

Context Augmented Spectrum Sensing in Cognitive Radio Networks

by

Nada Gohider

A thesis
presented to the University of Waterloo
in fulfillment of the
thesis requirement for the degree of
Master of Applied Science
in
Electrical and Computer Engineering

Waterloo, Ontario, Canada, 2015

© Nada Gohider 2015

Author's Declaration

I hereby declare that I am the sole author of this thesis. This is a true copy of the thesis, including any required final revisions, as accepted by my examiners.

I understand that my thesis may be made electronically available to the public.

Abstract

Spectrum management has become a crucial issue in wireless networks. However, optimal utilization of the spectrum among the different users is not a trivial task. Over the last two decades, wireless communication has witnessed a significant increase in applications. However, fixed strategies for allocating the spectrum bands cannot handle multiple requirements simultaneously, which is a core requirement of the emerging wireless applications. More importantly, licensed users or primary users (PUs) in wireless networks are intermittently connected, leading to spectrum underutilization. All of these limitations make it imperative that efficient strategies be developed to manage the spectrum among multiple users or networks. Cognition as a component of intelligence has been employed in communication technologies such as CR Networks for reasoning and learning goals. From this perspective, a Cognitive Radio Network is an adaptive data network that applies cognition as an optimization tool aiming to optimize spectrum sharing among multiple secondary users (SUs) in addition to the PUs in an autonomous and dynamic way. Spectrum Sensing is an important element of Cognitive Radio technology since its outcome is the basis for all the subsequent stages of the cognition cycle. However, with stand-alone Cognitive Radio devices, local spectrum sensing techniques such as Energy Detection technique might draw a false conclusion about the presence of a primary transmitter due to several reasons (e.g. fading, shadowing, hidden node problem, noise uncertainty, etc). Cooperative sensing minimizes the uncertainty due to those factors by exploiting the spatial variation of SUs, then concludes one global decision about the PU's presence/absence. In this research

work, I propose an intelligent cooperative spectrum sensing system whereby the contextual information of each secondary user is augmented in the fusion process wherein a set of information acquired by several contributing SUs are fused to optimize a global decision. Incorporating the contextual information of the SUs improves the spectrum sensing decision's reliability in the sense that false rejections and false acceptances are minimized, and therefore utilization is optimized. Artificial Neural Networks, as a Machine Learning and Artificial Intelligence tool, has been employed as a fusion algorithm utilizing the context of every SU to optimize final decisions. Experimental work is reported and discussed to demonstrate the effectiveness of the proposed technique.

Acknowledgements

My sincere gratitude and thanks are due to Allah, who always gives me the power to continue in the right direction, and finally achieve my goals.

Second, I would like to express my thanks to my supervisor Prof. Otman Basir for his support, encouragement, and insightful feedback.

Last but not least, my sincere thanks to the Ministry of Education in Libya for their generous financial support.

Dedication

To my husband, Khaled Brig, who is the most helpful and supporting person I found throughout my graduate studies; and to my parents who always were there for me whenever I needed them.

Table of Contents

Author's Declaration	ii
Abstract	iii
Acknowledgements	v
Dedication	vi
List of Figures	xi
List of Abbreviations	xiv
1 Introduction	1
1.1 Introduction	1
1.2 Research Motivation	5

1.3	Research Contribution	7
1.4	Thesis Organization	7
2	Background and Literature Review	9
2.1	Introduction	9
2.2	Spectrum Sensing	10
2.3	Design Issues in Spectrum Sensing	11
2.4	Channel Impairments	13
2.5	Spectrum Sensing Techniques	15
2.5.1	Passive Spectrum Awareness	15
2.5.2	Active Spectrum Awareness	16
2.6	Artificial Intelligence (AI) and Machine Learning (ML) Approaches for De- signing Cognitive Radio Components	23
2.6.1	Artificial Neural Networks: a powerful candidate for the learning and reasoning components of CR technology	24
2.7	Software Defined Radio: state of the art	28
2.7.1	Cognitive Radio over the Framework of Software Defined Radio	30
3	Context-aware Cognitive Radio	33
3.1	Introduction	33

3.2	The Proposed System Design	35
3.2.1	Model Assumptions	36
3.3	Spectrum Sensing Unit	37
3.3.1	Energy Detection as a Local Spectrum Sensing Technique	37
3.4	Context Modeling Unit	40
3.4.1	Energy Detector Threshold	43
3.4.2	Sensing Time	45
3.4.3	Path Loss	47
3.5	Artificial Neural Network Based Fusion Unit (Decision, Learning, Knowledge Base)	48
4	System Implementation and Results	54
4.1	System Implementation	54
4.2	Energy Detection Implementation	55
4.3	Assessment of the Secondary System's Contexts	56
4.3.1	Different Threshold Values	56
4.3.2	Different SNR Values	58
4.3.3	Different Sensing Periods	60
4.3.4	Different Channel Impairments	60

4.4	Artificial Neural Network Based Fusion Center	62
5	Conclusion and Future Work	69
5.1	Conclusion	69
5.2	Future Work	71
	References	76

List of Figures

1.1	Spectrum Underutilization	3
1.2	Cognition Cycle	4
2.1	Interference Range of CR	13
2.2	Channel Impairments	15
2.3	Centralized(a)and Distributed(b) Relay-assisted Cooperative Spectrum Sensing techniques	23
2.4	Artificial Neural Network	25
2.5	BNN/ANN Analogy	26
2.6	Software Defined Radio	30
2.7	CR over the framework of SDR	32
3.1	Context-augmented Cognitive System	36
3.2	Energy Detector Block diagram	39

3.3	Blind Vs. Aware-ED	42
3.4	ANN-based Cooperative Spectrum Sensing	44
3.5	Tradeoff between spectrum sensing time and user throughput	46
3.6	Cost 231 Hata PL	49
3.7	Multilayered Perceptron ANN	50
4.1	ROC Plot for ED's threshold Vs. P_f with mean SNR=-10dB, $N_{s1}=256$, $N_{s2}=500$, $N_{s3}=1000$	57
4.2	ROC Plot for Multiple SUs with different SNR values	58
4.3	ROC Plot for Multiple SUs with different sensing periods and average SNR= -10dB	61
4.4	Sensing performance with different path loss values (different distances) . .	62
4.5	Best training performance with MSE= 4.5085e05 at epoch 200 for one SU .	64
4.6	Best training performance with MSE= 2.8334e05 at epoch 200 for two co- operating SUs	65
4.7	Best training performance with MSE= 1.9641e05 at epoch 200 for three cooperating SUs	66
4.8	Sensing performance for two cooperative SS techniques (Majority and AND) over AWGN channels with mean $SNR = -10dB$	68

5.1	Universal Software Radio Peripheral (USRP B200) device	73
5.2	Energy Detection Simulation with USRP B200 receiver	74

List of Abbreviations

ADCs	Analog-to-Digital Converters
AI	Artificial Intelligence
ANN(s)	Artificial Neural Network(s)
AWGN	Additive White Gaussian Noise
BED	Blind Energy Detection
BPF	Band Pass Filter
BPL	Back Propagation Learning algorithm
BS	Base Station
CCU	Central Cognitive Unit
CDR	Constant Detection Rate Algorithm
CFAR	Constant False Alarm Rate algorithm
CFD	Cyclostationary Feature Detection
CMU	Context Modeling Unit
CR	Cognitive Radio
CRAHNS	Cognitive Radio Ad hoc Networks
CRN	Cognitive Radio Network
d	Distance

DOSA	Dynamic and Opportunistic Spectrum Access
DSPs	digital signal processors
EURO-COST		European Cooperative for Scientific and Technical research
ED	Energy Detection
f	Frequency
FCC	The Federal Communications Commission
FLS	Fuzzy Logic System
FNN	Fuzzy Neural Network
FPGAs	Field Programmable Gate Arrays
GA	Genetic Algorithms
GPPs	General Purpose Processors
HVM	Hidden Markov model
LOS	Line Of Site
MF	Matched Filter
ML	Machine Learning
MLP	Multi-layered Perceptron Neural Network
MSE	Mean Squared Error
N	Number of Samples

OSI	Open Systems Interconnection model
PL	Path Loss
PU(s)	Primary User(s)
QPSK	Quadrature Phase Shift Keying modulation
RL	Reinforcement Learning
ROC	Receiver Operating Characteristic
Rx	Receiver
SDR	Software Defined Radio
SNR	Signal to Noise Ratio
SPTF	The Spectrum Policy Task Force
SS	Spectrum Sensing
SSU	Spectrum Sensing Unit
SU(s)	Secondary User(s)
Tx	Transmitter
USRP	Universal Software Radio Peripheral

Chapter 1

Introduction

1.1 Introduction

Spectrum management has become a crucial issue in wireless networks. However, achieving perfect utilization of the spectrum among different users is not a trivial task. Over the last two decades, wireless communication has witnessed a significant increase in applications. Many such applications demand more and more bandwidth to be allocated. In the past, fixed frequency allocation techniques have generally satisfied users, and allowed a largely interference-free environment. However, with the persistent evolution of wireless applications, fixed-spectrum-bands allocation strategies cannot handle multiple requirements simultaneously. More importantly, licensed users or primary users in wireless networks are only intermittently connected leading to spectrum underutilization. The Spectrum Policy

Task Force (SPTF) of the Federal Communications Commission (FCC) has estimated that spectrum utilization is space and time dependent, meaning that some frequency bands are highly employed but in only particular periods of time. On the other hand, other bands are highly underutilized [19]. This situation, then, results in holes in the radio spectrum, representing available bands that are not used or, at least, not used efficiently, as depicted in Fig. 1.1 [19]. In other words, the traditional allocation schemes allot spectrum bands to licensed users under the command-and-control model, which prevents other unlicensed users from utilizing those bands even when they are available. All of these limitations make it imperative that efficient strategies are developed to manage the spectrum among multiple users or networks. These strategies should be dynamic, such that secondary users, also called unlicensed users, are permitted to share spectrum bands with the legacy users of that spectrum without causing any interference. This dynamic allocation is one of the most prominent suggested solutions that have emerged over the last two decades to tackle the crisis of spectrum scarcity. **Cognitive Radio (CR)** was proposed by Joseph Mitola in 1999 [43]. It represents a new communication model that employs Machine Learning and Artificial Intelligence capabilities to facilitate spectrum sharing in an efficient manner. The main attraction of this technology is its ability to sense the surrounding environment, then use the sensing results to build a knowledge base that will be the key engine to take future decisions during the cognition cycle, as depicted in Fig. 1.2 [57]. Generally, these techniques are called opportunistic spectrum sharing techniques, in which a secondary user tries to exploit the underutilized spectrum bands of primary users under a set of rules

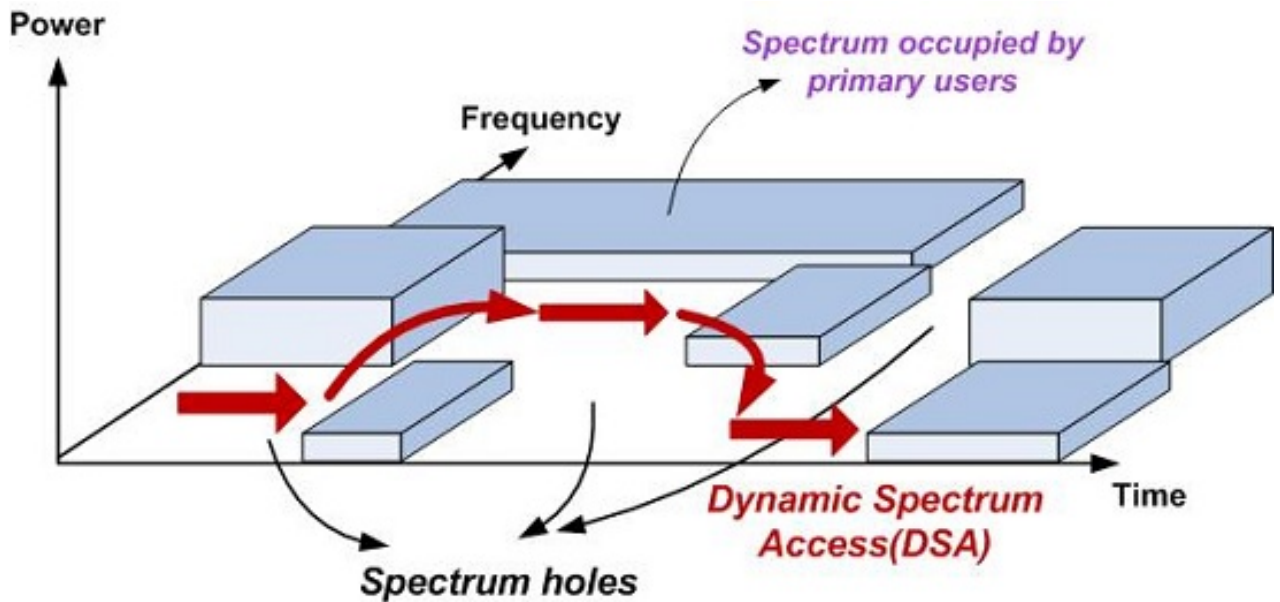

Figure 1.1: Spectrum Underutilization

preventing any interference with those primary users. For example, recently there has been growing interest in exploiting the bandwidth within TV broadcast stations for other services such as IEEE 802.11af standard, known as super Wi-Fi [55, 56].

Spectrum sensing (SS) represents a chief component of cognitive radio technology since it guides all the subsequent components of CR based on sensing results. In the SS stage, a CR user seeks to identify the temporarily unused spectrum channels (spectrum holes) and utilize them opportunistically. Since the secondary user cannot transmit and sense the radio environment simultaneously, several challenges arise in the SS process, as for every stage of the Cognition process (Cognition Cycle), SS has some requirements

that must be satisfied. Simplicity, reliability, accuracy, security, and fastness are the most important challenges of the spectrum sensing process. However, achieving all of these goals with the same sensing technique is not really an easy task. Thus, there is always some tradeoff need to be considered. For example, a lengthy sensing process will probably achieve better sensing results in terms of the final decision reliability and accuracy; however, this will be at the expense of spectrum utilization. This chapter presents in brief the main

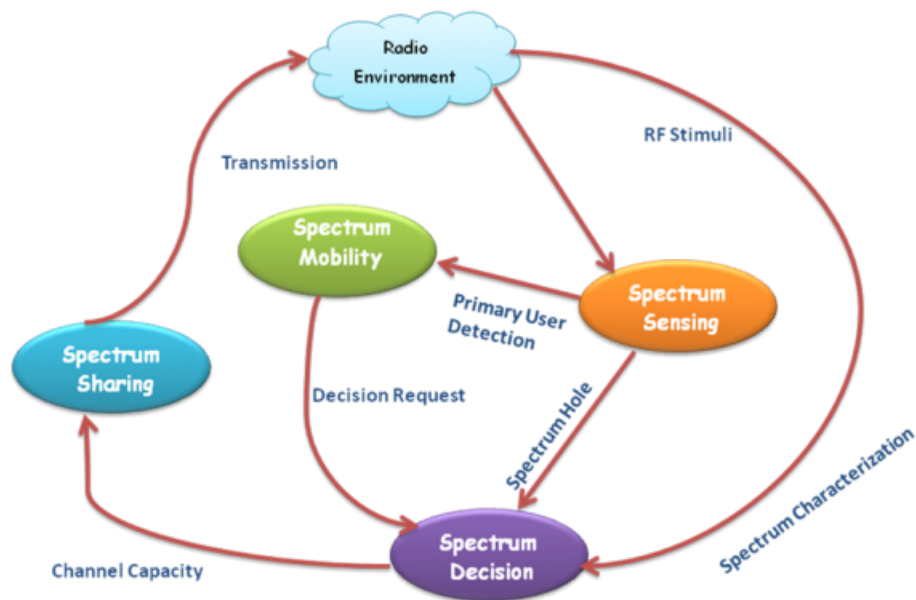

Figure 1.2: Cognition Cycle

goals of this research and how the problem of spectrum underutilization can be addressed with Cognitive Radio capabilities.

1.2 Research Motivation

Cognitive Radio technology has been proposed to efficiently optimize spectrum usage without negatively affecting the primary users' activities. Increasing spectrum utilization is the key objective of cognitive radio invention; however, this approach comes with an increased probability of interference either with the primary users (PUs) or even among the secondary users (SUs) themselves. Thus, these two conflicting components; namely spectrum utilization and interference, should be considered, giving a multi-objective optimization problem to be tackled. In this context, the concept of cognitive radio occurred to Mitola in 1999, as a trial to optimize spectrum utilization by applying artificial intelligence and machine learning capabilities without causing harmful interference with primary users. This cognitive radio technology, indeed, tries to mimic human ways of acting in an adaptive manner according to environment status. Spectrum sensing represents a main step in defining the current status of spectrum usage, after which a final decision can be made about spectrum access. Spectrum sensing techniques might be classified into different categories and from different points of view. Each spectrum sensing technique has its own merits and limitations as well. However, with stand-alone Cognitive Radio devices, those sensing techniques might draw a false conclusion about the primary user's existence due to several possible issues such as fading, hidden node problem, and noise uncertainty. Ideally, cooperation between several cognitive devices employing the same or different spectrum sensing technique will optimize the sensing results in terms of their reliability and ac-

curacy. Cooperative spectrum sensing techniques have attracted an intensive research for long years as they introduce good solutions to certain limitations encountered with most of the local spectrum sensing techniques, by exploiting the spatial variations of multiple secondary users located in different locations with respect to the primary user and ultimately identifying one global decision.

Although cooperative spectrum sensing usually improves the reliability of local spectrum sensing techniques, the observations achieved by the secondary users may deteriorate the overall system reliability. In other words, the sensing information received from different secondary users might be drawn from different contexts or environments, not all of them sound, leading to different grades of reliability. Ignoring that contextual information of different secondary users can undermine the value of the global decision made by the cooperative sensing system. By incorporating the contextual information of the SUs, the spectrum sensing decision could be improved in the sense that the false rejection and false acceptance will be minimized, and therefore interference and utilization will be optimized. Thus, to achieve this, an intelligent cooperative sensing scheme is proposed in this study, which employs several contextual parameters to assess the credibility of local observations by every cooperating unlicensed user.

1.3 Research Contribution

This dissertation contributes to the spectrum sensing field by proposing to augment the contextual information of multiple secondary users, which are spatially distributed, on the sensing reliability. In this research, several secondary users employ the same local spectrum sensing technique, namely, Energy Detection. Assuming that the SUs are located in different environments with respect to the PU's location creates a variation of the contexts where and when every secondary user makes its own local decision. Therefore, this study starts first with evaluating some contextual data on the sensing accuracy. In particular, it compares the signal to noise ratio (SNR), the threshold of the energy detector, the sensing period, and the path loss between the primary user and every secondary user. Each of those parameters is examined individually in order to extract the most valuable information that may affect the accuracy of the final decision. So, two cognitive units are jointly employed: the spectrum sensing unit and context modeling unit. Furthermore, this research proposes a novel cooperative spectrum sensing system whereby a cognitive central unit employs a trained Artificial Neural Network to fuse the received data from the secondary users and ultimately reach one final decision of the PU's presence.

1.4 Thesis Organization

This dissertation is composed of five chapters: Chapter 1 is a general introduction to the cognitive networks and spectrum sensing as the main interest of this research work.

Chapter 2 provides a comprehensive review of relevant research reported in the literature. An overview of spectrum sensing techniques is presented and an insight on the challenges pertinent to their design is highlighted. Furthermore, this chapter sheds some light on another novel technology, namely, Software Defined Radio (SDR), and illustrates the connection between SDR and CR technologies.

Chapter 3 presents the proposed cognitive system consisting of several cognitive units, that aims to accomplish certain important tasks of CR technology (i.e., to observe, understand, decide, and learn). Later on, each stage is explained in more details in Sections 3.3, 3.4, and 3.5.

Chapter 4 describes the simulation experiments conducted to assess the reliability of the system proposed in Chapter 3. Several Monte Carlo simulations were carried to evaluate the sensing performance according to the variation of the contextual data of several cooperating secondary users.

Finally, concluding remarks are presented in Chapter 5.

Chapter 2

Background and Literature Review

2.1 Introduction

Cognition as a component of intelligence has been employed in communication technologies such as Cognitive Radio Networks to achieve reasoning and learning goals. From this perspective, CRN is an adaptive data network that employs cognition as an optimization tool, aiming to optimize spectrum sharing among multiple secondary users in addition to the primary users in an autonomous and dynamic way [37]. Similar to other intelligent communication technologies, a cognitive radio network is supported by particular smart elements, which have the capability to observe their environment, understand the network's status, and consequently create a knowledge base that can be used later to modify network decisions through the cognition cycle (observe, plan, decide, and act as depicted in Fig.

1.2) [57]. However, a cognitive radio network differs from other smart communication techniques in that it considers users' requirements, particularly spectrum usage. It carries the responsibility to sense the network condition and act based on the sensor outcome. One of the most pivotal factors of CR technology success is that it can self-modify to the current situation's requirements. Thus, it dynamically adapts users' access to the spectrum according to environment status and network parameters, while maintaining the primary (i.e. licensed) users' need for spectrum access. This feature is commonly known as dynamic and opportunistic spectrum access (DOSA) [33]. Indeed, cognitive radio capability goes beyond adaptation behavior. The key element of CR is that it is aware of the radio environment, and uses its intelligence capabilities to make correct decisions, avoiding any unsound ones that might have been taken earlier. Another interesting benefit of cognitive radio is its reconfigurability. Transmission power, carrier frequency, and modulation strategy at the physical layer are examples of the parameters that might be controlled according to CR conclusions [9].

2.2 Spectrum Sensing

Spectrum Sensing (SS) is the chief component of the cognition cycle in CR Networks since it guides all the subsequent components based on its results [57]. In the SS stage, a CR user seeks to identify the temporarily unused spectrum channels (spectrum holes) and utilize them in an opportunistic manner without interfering with the primary user (PU):

”a spectrum hole is a band of frequencies assigned to a primary user, but at a particular time and at a specific geographic location, the band is not being utilized by that user” [70]. In this context, the spectrum holes can be classified into two main types: temporal and spatial. For the temporal holes, the PU does not, temporarily, use its band of interest for a particular period of time. In contrast, for spatial holes, the SU utilizes the primary transmitter’s band in a geographical location that is far from the primary receiver, so there is no harmful interference with the primary receiver.

Like every other Cognitive Radio component, the SS process is accompanied by certain critical challenges as explained in the next section.

2.3 Design Issues in Spectrum Sensing

Although the sensing process is performed periodically by the secondary user (SU), the SU cannot transmit and sense the radio environment simultaneously, it will be unaware of the spectrum status until the next sensing period starts again. During that transmission period of the secondary user, the primary user may decide to use its band again and therefore will be interfered with the SU’s activities. This highlights the tradeoff of setting the appropriate sensing time for the secondary user. In other words, a long sensing time will probably reduce the possibility of the PU’s interference; however, this also will be at the expense of the throughput of the secondary system [66]. As well, some applications or scenarios are sensitive to the sensing delay and restricted to the maximum sensing period.

In addition to the sensing time, noise uncertainty represents a critical issue for spectrum sensing techniques. Interested readers may refer to [39] for a detailed analysis of noise uncertainty and its impact on spectrum sensing. In most of the spectrum sensing techniques, a decision statistic is compared to a predefined threshold to detect the primary user's presence. To calculate the threshold value, the noise power will probably need to be detected, which is usually not possible, a phenomenon known as noise uncertainty. For instance, although the simplicity of the Energy detector has encouraged many researchers to use it as a local sensing technique, it is susceptible to low SNR values, and in many times cannot distinguish between noise and weak signals of the primary user [13].

More importantly, dynamic variations of the channel between the primary and secondary users may represent a source of confusion when the secondary users try to determine spectrum status. Fading, shadowing, and path loss of the PU's signal are the most influential factors of the channel variations [30]. The licensed user's signal might be decayed, scattered, or reflected due to the presence of some obstacles, trees, or buildings. This, then, may mislead the secondary user's conclusion about the PU's existence.

Another significant issue is the interference range of the primary user, which can be defined as the minimum distance between the PU's and the SU's transmitting antennas, from which both can be sent simultaneously without harmful interference to the primary receiver [6].

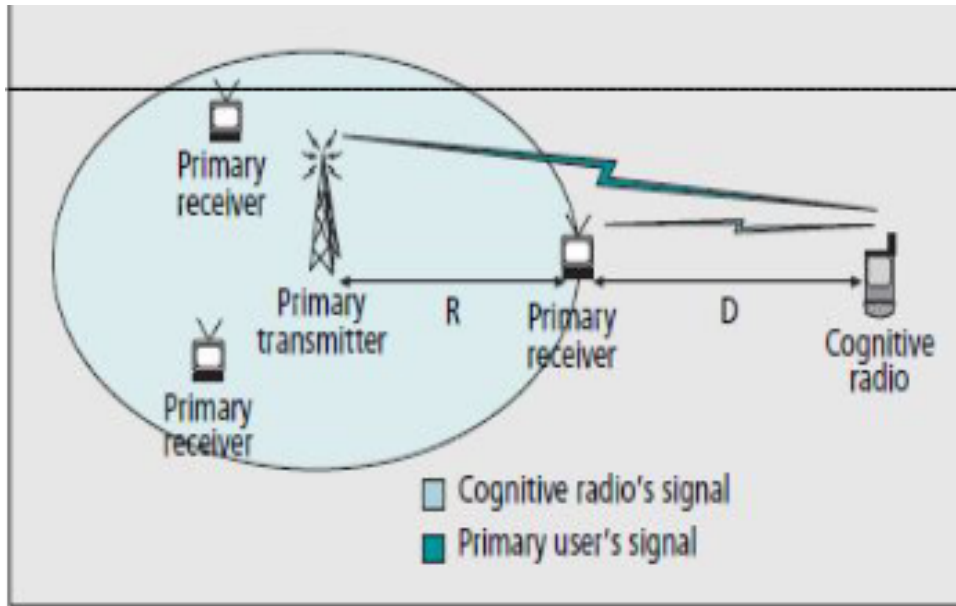

Figure 2.1: Interference Range of CR

2.4 Channel Impairments

As wireless signals propagate through the wireless channel, they are likely to suffer from several sources of signal attenuation and variation known generally as channel impairments phenomena. In this context, path loss, multipath fading, shadowing and interference are the most influential impairment issues that can impact the spectrum sensing process. In the literature, those channel impairments are graded based on the scale of their impact on the propagated signal. For instance, path loss, defined in decibels, is the attenuation of the signal power as a function of the carrier frequency and the distance separating the transmitter and the receiver. It is classified as a large-scale property of the channel. Thus, for a given value of path loss, the average received power can be calculated relative to the

power transmitted from a particular transmitter. Another important factor is multipath fading, known as small-scale channel impairment due to the rapid fluctuation of the signal over relatively short distances. Both environmental and man-made obstacles can cause multipath fading, resulting in scattering, reflection, and diffraction of the propagated signal. Different to the path loss, multipath fading is relatively insensitive to the carrier frequency [31]. Different models have been developed in the literature to represent the channel impairments in a more accurate way. The simplest model for the attenuation caused by path loss is known as the Free-Space Path Loss model as shown in Equation 2.1; however, it is limited to the line of site cases (LOS) where there is no obstruction in the path between the two end systems (Tx and Rx) [20, 67].

$$PL = 3.24 + 20 \log(f * d), \quad (2.1)$$

where PL represents the Free Space Path Loss, f is the carrier frequency of interest, d is the distance (in kilometers) between the transmitter and receiver.

Although the Free-Space Path Loss model has been widely utilized in many previous studies due to its simplicity, it is practically inefficient since LOS paths do not often occur in real scenarios [7, 12, 15, 16, 29, 62]. In other words, an entire path between the transmitter and the receiver with no obstructions is unlikely as shown in Fig. 2.2 [34].

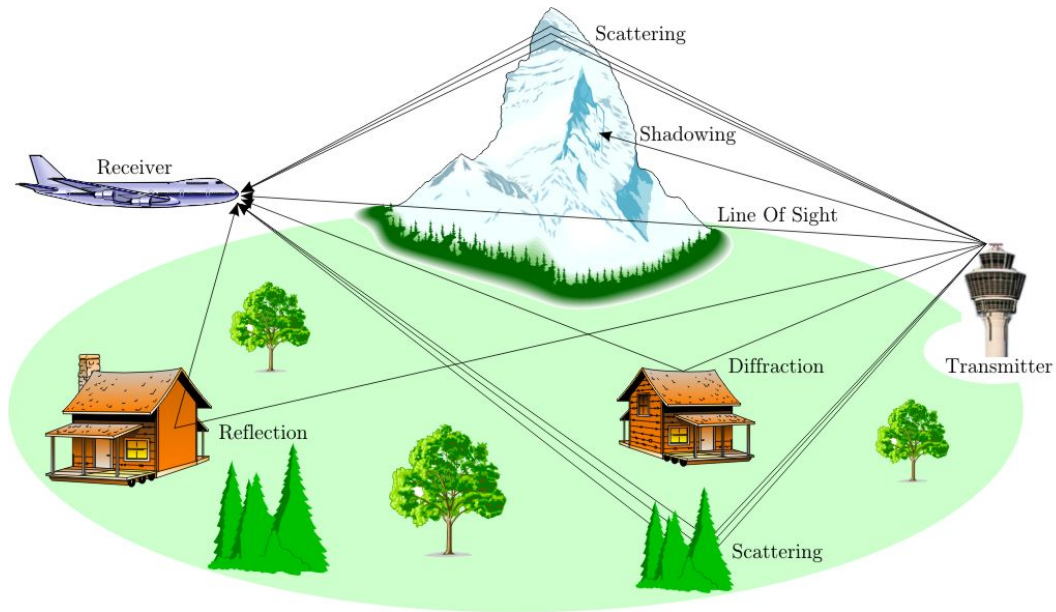

Figure 2.2: Channel Impairments

2.5 Spectrum Sensing Techniques

Spectrum sensing techniques can be classified from different points of view and different perspectives. Since awareness is the main objective of the sensing process, in this thesis, the various SS techniques are categorized according to the way in which awareness is acquired.

2.5.1 Passive Spectrum Awareness

In this class, the secondary system is not physically engaged in the sensing process. Instead, the spectrum's current status is received from outside one's own secondary communication system [6]. This can be accomplished via different approaches; one most commonly em-

ployed passive sensing scheme uses a central database to exchange spectrum status between the primary and secondary users. Moreover, a beacon approach, in which a beacon signal is synchronized and exchanged between the primary and secondary users, has also shed the light on passive sensing techniques. Even though these passive approaches have shown excellent results in some previous studies [6], their infrastructure cost and the limited flexibility caused many sensing-system designers to focus instead on active sensing techniques which are simple and less computational complex [22].

2.5.2 Active Spectrum Awareness

Unlike the passive techniques, active ones require unlicensed users to actively and periodically sense the primary user's band of interest, and then reconfigure their parameters according to the achieved observations [22]. In these techniques, the primary system has no role in the sensing process, and is even unaware of it. Active SS techniques can be further classified according to the level of cooperation among secondary users trying to detect the same primary user.

Non-cooperative Spectrum Sensing

In non-cooperative SS techniques, the SU employs particular features of the primary user's signal to conclude a decision statistic and later compares it to a predefined threshold or reference. The sensed signal can be generally described as a binary-hypothesis problem as

follows:

$$X(n) = \begin{cases} hS(n) + w(n) & H_1, \text{ PU's band is occupied} \\ w(n) & H_0, \text{ PU's band is idle} \end{cases} \quad (2.2)$$

where $X(n)$ is the signal received by a secondary user, $S(n)$ is the primary user signal, h is the channel gain, $w(n)$ is the Additive White Gaussian Noise (AWGN), and N is the number of samples ($n=1,2,3,\dots,N$)

Non-cooperative spectrum sensing, also known as local spectrum sensing in this context, varies in its operation from one technique to another, and can be classified from different points of view. For instance, the SS techniques that require a prior knowledge about the primary user's signal to compare particular signal features to the received signal at the SU are called coherent signal detection techniques. On the other hand, the non-coherent detection techniques compare the received to a threshold which is defined based on some features that are independent on the primary signal knowledge. Alternatively, SS techniques can also be classified from the bandwidth perspective into Wideband and Narrowband detection techniques. Following are the most popular SS techniques that belong to the different classes mentioned above.

- **Energy Detection**

Energy Detection (ED) is one of the most common local sensing techniques in the SS field due to its simplicity and relatively low complexity. As well, it does

not require prior knowledge about the primary user signal. Instead, the secondary user uses the received power as a decision statistic and compares it to a pre-defined threshold, so ED can be considered as a non-coherent sensing technique. In addition to the mentioned features, the sensing time required to achieve a high level of sensing accuracy could be relatively small compared to that in other sensing techniques [35].

$$Y = \frac{1}{N} \sum_{n=1}^N |x(n)|^2 \quad (2.3)$$

where $x(n)$ is the signal received by a secondary user, and Y is the decision statistic which represents the received power in ED.

Although the simplicity of this technique has attracted many researchers, its advantages are accompanied with some limitations as well. For example, a secondary user under ED technique misses the ability to differentiate between the primary user signal and the signal of another secondary user, possibly causing interference with one of them. Furthermore, setting the threshold value as a reference depends on the noise floor, which is unknown, adding further uncertainty.

- **Matched Filter Detection**

Different to ED as a sensing technique, **Matched Filter (MF)** technique requires prior knowledge of the PU's signal to calculate the correlation between the received signal and a known copy of the PU's signal. The carrier frequency, the modulation scheme, and the transmission data rate are examples of the important parameters of the PU's signal that are required to calculate that correlation. This, then, represents

one of the most significant limitations of MF spectrum sensing technique, since this information about the PU's signal is not always available. On the other hand, if that information can be acquired, MF is expected to perform perfectly in terms of sensing reliability. As well, Matched Filter detector needs relatively longer sensing time to accomplish a certain level of error probability (either a false alarm or misdetection probability) compared to some other spectrum sensing techniques.

As explained in [50], the matched filter of a real signal $s(t)$, defined over a period $[0, T]$, that maximizes the signal to noise ratio at the output of the filter sampler is given by:

$$Y[t] = \begin{cases} s[T - t], & \text{if } 0 \leq t \leq T \\ 0, & \text{elsewhere} \end{cases} \quad (2.4)$$

- **Cyclostationary Feature Detection (CFD)** A **Cyclostationary signal** is a periodic signal that has some statistical properties such as its mean and auto-correlation acting as a finger print of the PU's signal. For a given periodic signal $s(t)$,

$$M_s(t + \tau) = M_s(t) \quad (2.5)$$

$$R_s(t + \tau, u + \tau) = R_s(t, u) \quad (2.6)$$

where M is the mean of the signal, R is the auto-correlation of the signal, and τ is the period time [42].

In the context of spectrum sensing, this feature of signal periodicity has been utilized to detect the PU's existence. One of the strong merits of CFD is that, using the periodicity property, it can distinguish the primary user signal from noise and interference, thus, this detector is robust to noise uncertainty, unlike some other SS techniques such as ED. Moreover, CFD has the ability to distinguish the PU's signal from other unlicensed users' signals. However, all of these utilities should be supported by the prior knowledge of the primary user signal which adds a complexity burden to the sensing process. Furthermore, CFD requires a relatively long sensing time to achieve a particular level of sensing reliability [18,42].

Cooperative Spectrum Sensing

As stated in the previous sections, spectrum sensing is accompanied by several challenges or difficulties which can negatively impact the sensing reliability. As well, each of the local SS techniques, such as ED and MF, has its own strong points and limitations, and there is no one optimal scheme for all applications and scenarios. In order to mitigate the problems of the sensing techniques, cooperation between several SUs that are spatially distributed is proposed in many studies in the area of spectrum sensing. Environmental and man-made factors such as fading, shadowing or noise are not likely to be experienced simultaneously in different geographical locations. Therefore, cooperative spectrum sensing aims to utilize that variation of the secondary users' locations and come up ultimately with one global decision for all secondary users [13]. According to the way in which the secondary users

share their sensing information, Cooperative SS techniques can be categorized into three main classes: centralized, distributed, and relay-assisted [23].

- **Centralized Cooperative Spectrum Sensing**

In this class, all secondary users sense a band of interest using the same or different sensing techniques, and ultimately send their local decisions-either hard or soft-through a control channel to a central unit. After that, all the received data is fused to conclude one final or global decision stating the PU's current status [23,24]. Interestingly, centralized cooperative spectrum sensing can even be organized in both centralized and distributed fashions. Thus, if the fusion process is done at a central base station (BS), the cooperative system is recognized as a centralized model; on the other hand, in CR Ad hoc networks (CRAHNs) where there is no base station, one of the cooperating nodes co-ordinates the synchronization and fusion processes [17,26]. Different fusion models have been suggested in the literature, and they depend on different factors to make their final decision, as explained in Section 2.6.

- **Distributed Cooperative Spectrum Sensing**

Instead of relying on a central fusion center, the cognitive nodes share their sensing information with each other and eventually converge to one global decision after several turns. Thus, distributed cooperative spectrum sensing systems might cost less than other models since they need no infrastructure to be established. Several algorithms have been employed in cooperative spectrum sensing to coordinate the

sensed data at different cognitive nodes. In [14] a discrete time gossip protocol is employed in which a secondary user senses a band of interest during a certain time slot and later sends its observations to a set of their neighboring SUs that are selected randomly. Similar to the previous technique, [36] proposes a dissemination strategy for the sensing information among the secondary users, where during a particular time slot, only a group of the total cooperating secondary users exchange their local decisions. Afterward, a secondary user within this group sends all the received data to a randomly selected neighbor which will be the designated user in the next time slot, and so on, until all the secondary users receive the sensing information.

- **Relay-assisted Cooperative Sensing**

In these cooperative systems, an unlicensed user senses a frequency band of interest periodically through the sensing channel, and later delivers its observations through the reporting channel. Both the sensing and reporting channels, like any physical channels, may experience some environmental problems such as fading or noise. Thus, secondary user may experience a good sensing channel and a poor reporting channel on the other side; contrarily, another secondary user may encounter sensing and reporting channels with the opposite conditions. This channel status variation among different secondary users can be exploited by having one secondary user's channels serve as relay to another secondary user and vice versa so they improve the performance of the sensing process. Furthermore, the relay-assisted cooperative sensing can be further implemented in both centralized and distributed manners as

described in Fig. 2.3 [23, 69].

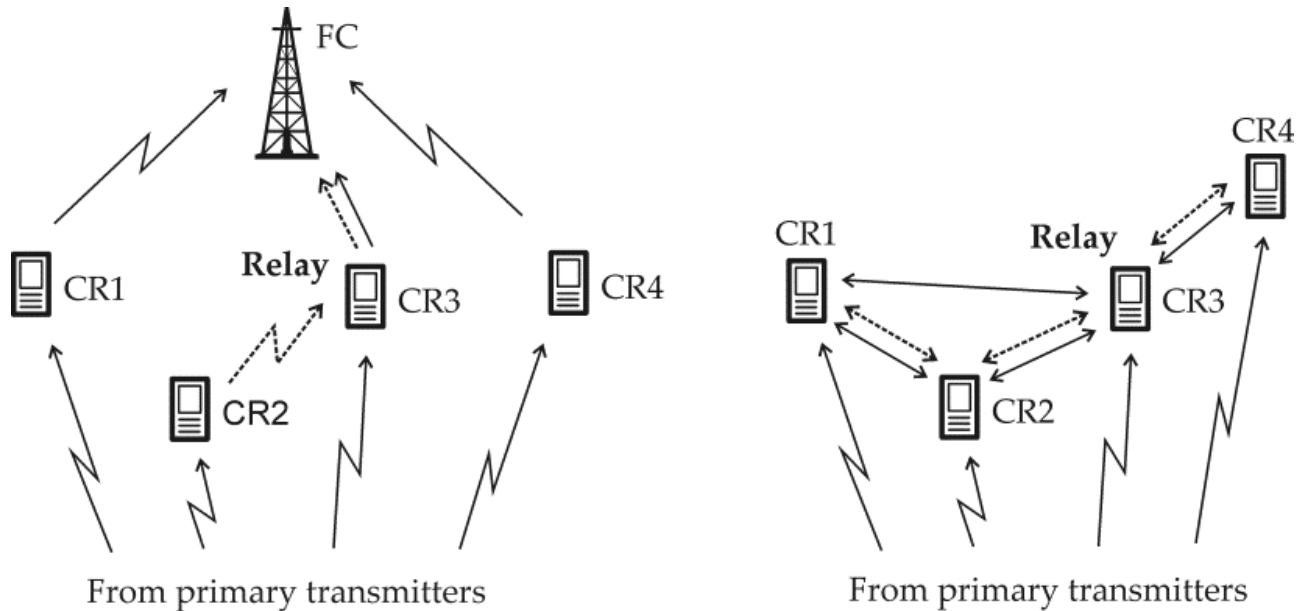

Figure 2.3: Centralized(a)and Distributed(b) Relay-assisted Cooperative Spectrum Sensing techniques

2.6 Artificial Intelligence (AI) and Machine Learning (ML) Approaches for Designing Cognitive Radio Components

Intelligence, as a main ingredient of Cognitive Radio technology, can be employed in every stage of the cognition cycle [4, 10, 63]. For instance, [10] employs ML tools to develop a

knowledge base from observations of spectrum availability. Learning elements are then used to manipulate the acquired knowledge based on the updates of those observations. Eventually, a decision is made about spectrum access. From the learning and reasoning perspectives, making the best decision (spectrum access) with less cost using the available inputs (channel status, QoS, etc) is indeed an optimization problem. AI and ML algorithms, such as Hidden Markov model (HVM) [46], Artificial Neural Networks (ANNs) [32], Reinforcement Learning (RL) [54], or Genetic Algorithms (GA) [27], have been proven as effective solutions for the cognitive radio tasks.

2.6.1 Artificial Neural Networks: a powerful candidate for the learning and reasoning components of CR technology

Learning is one of the fundamental characteristics of cognitive systems generally, and of cognitive radio technology in particular. In this context, Artificial Neural Networks, as classifiers, often employ supervised learning where the information is processed with the aim to achieve a predefined target output. This approach, indeed, can be considered as an optimization problem whose objective function is to minimize the total error resulting from the difference between the target and the actual outputs. Artificial Neural Networks were proposed a long time ago as a trial to mimic the biological structure of the connected neurons of the human brain. The key factor behind the success of ANN models as a machine learning tool is their powerful ability to predict in non-linear systems. In other words, this

”magic” structure of NNs, in which several dense interconnected neurons process the input data in a parallel manner, has attracted many researchers to utilize it in many nonlinear sophisticated problems. This structure indeed has been inspired from the complicated structure of the brain’s neurons which together form the nervous system of human beings. In addition, the beauty of the neural network model is its way of approximating the nonlinear functions of the learning process. Thus, with neural network capabilities, an intelligent system can be developed that has the ability to tackle sophisticated problems without the need to know much about the input signal.

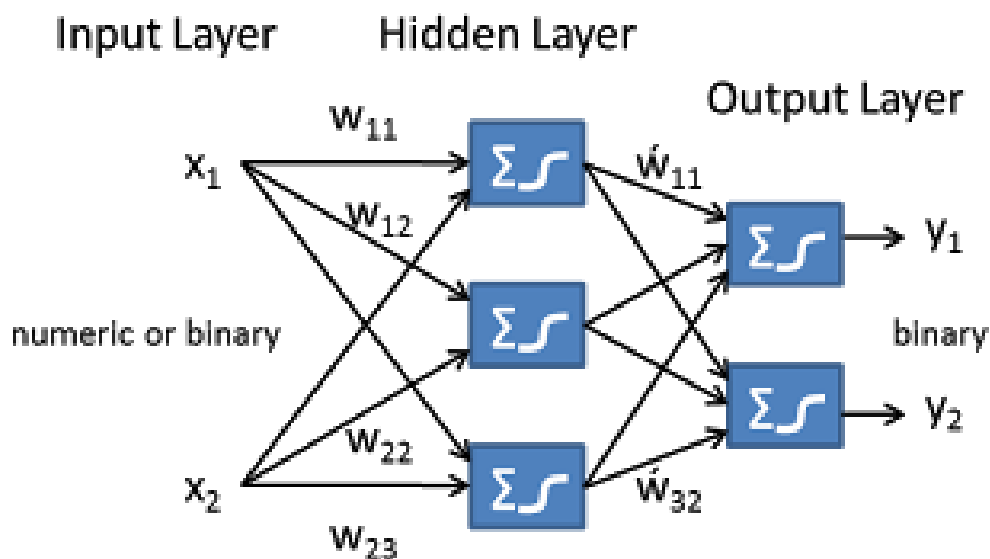

Figure 2.4: Artificial Neural Network

As shown in Fig. 2.4, a neural network consists of a set of nodes called neurons that are distributed in several layers and connected through weights. In addition to the input

and the output layers, a neural network can have different numbers of intermediate layers known as the hidden layers. The input features (data) are fed to the neural network and forwarded through the different hidden layers until they reach the output layer. At each neuron, the weighted inputs from other nodes in the previous layer are summed and then filtered through a transfer function. This process is repeated at every node until the forwarded data reaches the output layer. This process is exactly analogous to the information flow between the biological neurons, where the distributed cell bodies (soma) have a function to collect and combine the received information and then transfer it to other neurons through channels called axons, as depicted in Fig. 2.5 [41].

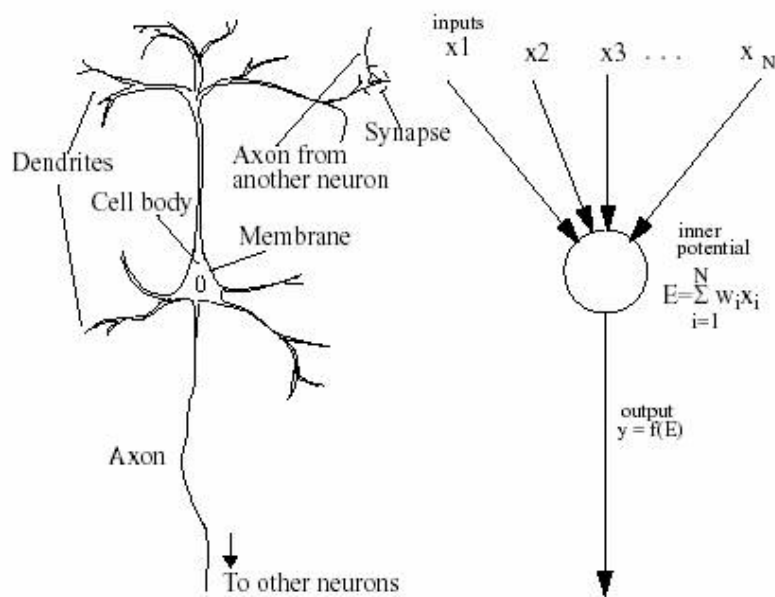

Figure 2.5: BNN/ANN Analogy

The output of each connected node (neuron) is as follows:

$$y(t) = f\left(\sum_{i=1}^n w_i x_i\right) \quad (2.7)$$

where x_i is the output of every connected neuron, w_i s the connecting weights of those neurons, f is the transfer function, more commonly known as the activation function [41].

Moreover, different classes of the neural networks can be defined according to different characteristics. For instance, there are two main types of neural networks based on the direction of information flow through the different connected layers: feedforward networks (static networks) and feedback networks (recurrent networks). For the former class, the information is transferred from one layer to the next layer only in the forward direction. The Multi-layered Perceptron Neural Network (MLP) is one of the most widely employed feedforward NNs. On the other hand, with the feedback networks such as Hopfield Networks, the memories of the connected neurons are refreshed with the data coming back from other nodes in the subsequent layers [41].

Although many classification problems in the literature exploit ANNs with supervised learning to achieve a particular predefined output, ANNs with unsupervised learning algorithms such as Hebbian learning and competitive learning have also been utilized in many areas of research [64]. For the latter class of learning algorithms, determining the output and adjusting the connecting weights are both based on the reaction and the behavior of the network itself, without the involvement of a target output as is the case with supervised learning [41]. For instance, the weights in the competitive learning are adjusted for the

neuron that has the largest output; in contrast, the weights in the Hebbian learning are modified if the node connected with those weights is fired by the input [64].

2.7 Software Defined Radio: state of the art

Currently, cognitive radio has been deployed in various applications such as military, emergency, commercial and industrial ones. Spectrum sensing as a chief component of the cognition cycle in Cognitive Radio Networks has attracted a huge proportion of research. The main motivation of this technology is its ability to sense the surrounding environment, and use the sensing results to build a knowledge base on which future decisions will be made. These stages go through a cycle called the cognition cycle [57]. Analogous to CR, the idea of **Software Defined Radio (SDR)** was also established by Joseph Mitola [53] as a revolutionary technology which seeks to move most of the functionality and control from the hardware to the software. Both technologies, namely, CR and SDR, are currently active areas of research, and have grabbed intensive attention from researchers as promising technologies to manage the available spectrum effectively. However, this analogy between CR and SDR could be a source of confusion for some readers who are not familiar with these technologies. SDR is a multiband radio characterized by its flexibility; that is, it controls the chief radio parameters using programs running on particular processors. This flexibility characteristic of SDR has been a long standing demand by the operators of radio networks. For example, in the military sector, time is critical and long delays cannot

be tolerated, so SDR research has been highly motivated to avoid dealing with hardware components whenever possible [53]. Adding to this, the persistent increase in wireless applications in the commercial field has created the demand for a more convenient solution for controlling radio parameters more efficiently [59]. Before SDR intervention, physical modification was the only available solution in case of any upgrade that a system might need. Then, SDR moved most of the functionality of radio components such as waveform synthesis from the hardware to the software side. Nevertheless, this does not mean that SDR is completely free of hardware: it provides a combination of software and hardware protocols but keeps the majority of control in the software elements. Field programmable gate arrays (FPGAs), digital signal processors (DSPs), general purpose processors (GPPs), and analog-to-digital converter (ADCs) represent some of the elementary components of SDR systems that aim to process the transmitted/received signals in the digital domain rather than the analog one, as shown in Fig 2.6.

These signal processing elements such as detection, filtering, or modulation/demodulation can be simply carried out in an embedded system or programmable device such as a personal computer instead of hardware, which demonstrates the flexibility feature of SDR [59]. Adding to the flexibility feature of SDR, the required power can be reduced by implementing most of radio tasks via software programs [59].

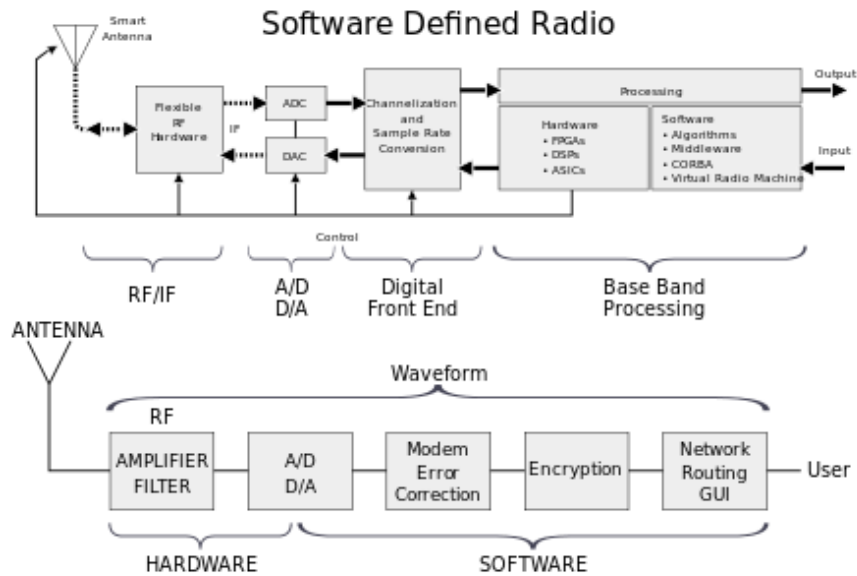

Figure 2.6: Software Defined Radio

2.7.1 Cognitive Radio over the Framework of Software Defined Radio

The basic idea of SDR has been explained earlier in Section 2.7. Having a centralized control in software can facilitate employing cognition tools to manage the spectrum effectively through its property of reconfigurability and run-time reconfiguration. SDR introduces the possibility to program different communication components and different radio access technologies on the same device platform [59]. Nevertheless, installing unlimited amounts of software on the same device is not really possible, so a combination of hardware and software elements is the key to the required management [59]. Cognitive Radio over the

framework of Software Defined Radio presents a wireless communication paradigm which combines the features of CR intelligence and SDR flexibility to observe, understand, and use the received feedback to learn the environment state. Consequently, the past and current feedback reports constitute together a knowledge base which presents the key engine of the decision making phase [40]. This cooperation of CR and SDR capabilities enables diversity of wireless standards, modulation techniques, and services with better quality for users, and, at the same time, with less cost for the operators [40]. In this regard, CR might include all the Open Systems Interconnection model's (OSI) layers in the cognition process, while SDR takes care of the physical layer functions and the link issues. They, together, provide an independent open-structure topology which can be gently reconfigured according to the current state of communication [68].



Figure 2.7: CR over the framework of SDR

Chapter 3

Context-aware Cognitive Radio

3.1 Introduction

Adding to the fact that spectrum sensing techniques vary in their strategies, features, limitations, and performance, every technique might incur a particular degree of overhead to the sensing process. As explained in Section 2.5.2, there is no one optimal sensing scheme that is suitable for all problems, so sensing models can complement each other by working in a collaborative paradigm. By utilizing the spatial variation of secondary users' locations, the overhead of each secondary user's sensing can be mitigated. In this context, different cooperative spectrum sensing approaches have been developed and analyzed in previous studies [44, 52, 61]. Although cooperative sensing systems have shown promising results, most of these techniques indeed treat the sensing information received from different

secondary users almost equally in terms of sensing reliability, assuming that all cognitive users have the same or similar contexts, which is not the case of real cognitive systems. This, then, might lead to misleading results in the sensing process because the secondary users are more likely to have different environments and contexts for when and where they take their local decisions. Although some cooperative spectrum sensing systems utilize weighted schemes to evaluate the reliability of sensed information, these schemes generally are dimensionless; that is, their evaluation depends on only one factor such as SNR, which is not sufficient enough to evaluate the system credibility [65]. Another study [47] suggests a weighted sequential probability ratio test to evaluate the sensing reliability using confidence coefficients. Although this algorithm has shown good results in terms of overall sensing reliability, it is a highly complex and subjective technique.

Several parameters can be considered under the context model of every SU, such as the sensing period, SNR at the SU's location, the channel impairments, etc. In particular, this thesis investigates the hypothesis that incorporating some contextual information of each SU in the fusion process will improve spectrum sensing decisions, in the sense that false rejection and false acceptance will be minimized. Therefore, interference and utilization will be optimized. In other words, this research tries to examine the impact of Context-awareness on the reliability of the final decision of spectrum sensing (i.e., whether the PU is active or idle).

3.2 The Proposed System Design

This chapter presents the design of a comprehensive cognitive system consisting of several cognitive units, that aims to accomplish certain important tasks of CR technology (i.e., to observe, understand, decide, and learn), as shown in Fig. 3.1.

1. First of all, the two cognitive models; namely, the spectrum sensing unit (SSU) and the context modeling unit (CMU) work in parallel for every cooperating unlicensed user. The energy detection scheme is employed at the SSU whereby every cooperating secondary user periodically senses the primary user's channel of interest, and ultimately makes one local decision (1/0) reporting the primary user's current status. In the mean time, the environment of every secondary user, when and where the local decision is taken, is modeled at the context modeling unit, which exports raw of contextual parameters for each secondary user along with its local decision.
2. Later on, the acquired information (the local decisions at the SSU and the contextual data of each SU at the CMU) are sent simultaneously to the central cognitive unit(CCU).
3. The central cognitive unit is designed to receive all the observations stated in Step 2 and fuse them using a trained artificial neural network (ANN) to optimize the total error and ultimately optimize the global decision.
4. Every scenario at all previously-mentioned stages, is stored in a knowledge base for

later exploitation in future decision making.

Each stage is explained with more details in the Sections 3.3, 3.4, and 3.5 respectively.

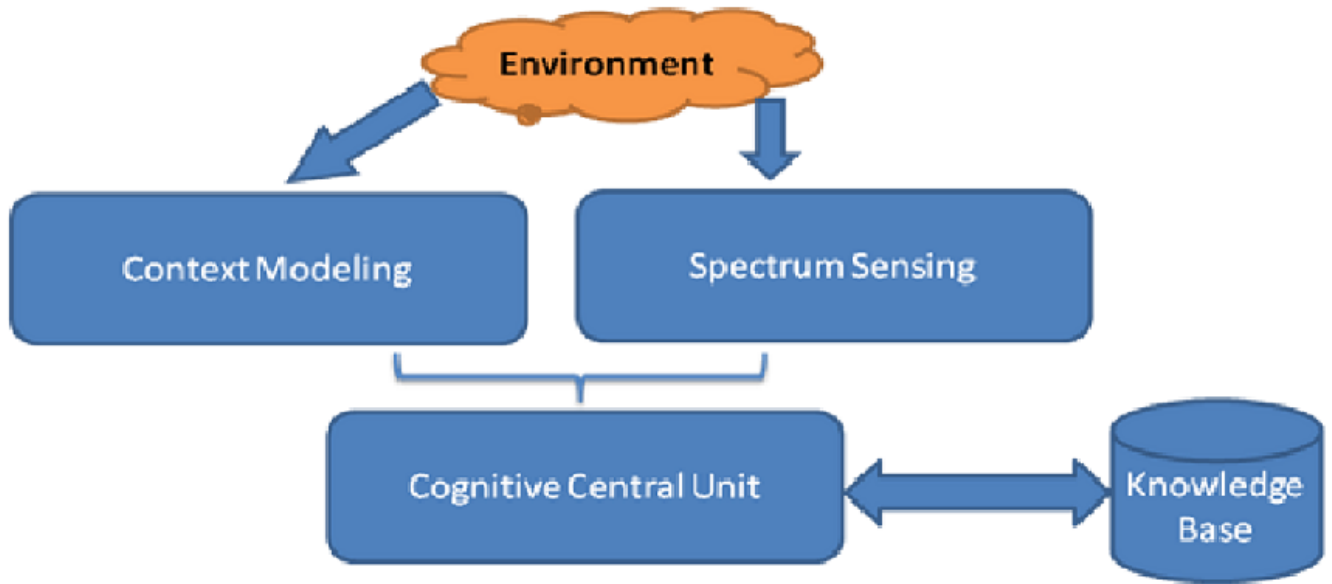

Figure 3.1: Context-augmented Cognitive System

3.2.1 Model Assumptions

The frequency spectrum has a random nature in the sense of spectrum usage, the environment status, or the transition instance from one state to another. Thus, a set of assumptions have been considered in this research, mainly for the purpose of simplification.

1. Practically, the noise power is unknown. It varies with time and location, and estimating its value is not really a trivial task. In this research, different values have been assigned to the noise power of different environments of the SUs.
2. There is only one primary user of interest, which is stationary, meaning that its location is fixed during the whole sensing process.
3. On the other hand, we have N remote or mobile secondary users, which are likely to change their location from time to time. From this perspective, it is assumed that each secondary user is equipped with a GPS device in order to continuously track its position.

3.3 Spectrum Sensing Unit

At this unit, several secondary users that are spatially distributed sense the licensed user's band(s) of interest periodically and locally using the same sensing technique, namely, Energy Detection.

3.3.1 Energy Detection as a Local Spectrum Sensing Technique

Energy detection technique is one of the most commonly used strategies owing to its simplicity and relatively low computational complexity. Nevertheless, this approach might perform very poorly in some environments (i.e., low SNR environments). It was first

discussed by Urkowitz in [60] as a binary hypothesis problem described in Equation 3.2. Later on, ED was further analyzed in [21] for unknown deterministic signals that operate over Rayleigh and Nakagami fading channels.

$$X(n) = \begin{cases} hS(n) + w(n) & H_1, \text{ PU's band is occupied} \\ w(n) & H_0, \text{ PU's band is idle} \end{cases} \quad (3.1)$$

where $X(n)$ is the signal received at a secondary user, $S(n)$ is the primary user signal, h is the channel gain, $w(n)$ is the Additive White Gaussian Noise (AWGN), and N is the number of samples.

The decision statistic of the energy detector, the power of the received signal, is calculated through the averaged sum of the squared power of N received samples and then compared to a predefined threshold, assuming that the signal power is much higher than the noise power, which is not always the case. The received energy as a key signal characteristic is calculated by every unlicensed user simultaneously as in the following:

$$Y = \frac{1}{N} \sum_{n=1}^N |x(n)|^2 \quad (3.2)$$

where Y is the decision statistic representing the received power in ED. The distribution of the decision statistic follows the status of the primary user. In other words, if the band of interest is occupied, the decision statistic Y has a central Chi-square distribution with N degrees of freedom. Otherwise, it has a non-central Chi-square distribution with N degrees

of freedom and the non central parameter $\rho = N\gamma$ where γ is the signal to noise ratio of the received signal. The signal to noise ratio is defined as:

$$SNR = \frac{\sigma_s^2}{\sigma_w^2} \quad (3.3)$$

The final decision of the Energy Detector is made based on the results of the comparison between the decision statistic and the predefined-threshold (λ) as follows:

$$ED's \text{ decision} = \begin{cases} 1 & \text{if } H_1 \text{ is declared } (Y \geq \lambda) \\ 0 & \text{if } H_0 \text{ is declared } (Y \leq \lambda) \end{cases} \quad (3.4)$$

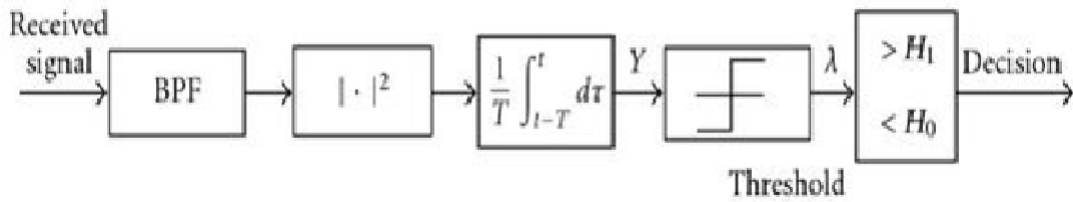

Figure 3.2: Energy Detector Block diagram

The performance of the ED's decision can be determined more precisely with the two conflicting values: misdetection and false alarm probabilities (P_{md} and P_{fa}): The detection probability (Equation 3.5) is the probability of correctly detecting that the primary user is active.

$$P_d = P(Y \geq \lambda/H_1) = Q\left(\frac{\lambda - \sigma_t^2}{\sqrt{2N\sigma_t^4}}\right) \quad (3.5)$$

where $\sigma_t^2 = \sigma_s^2 + \sigma_w^2$

$$P_{md} = 1 - P_d = 1 - Q\left(\frac{\lambda - \sigma_t^2}{\sqrt{2N\sigma_t^4}}\right) \quad (3.6)$$

On the other hand, the false alarm probability (Equation 3.7) is the probability of incorrectly detecting that the primary user is present, which results in spectrum underutilization.

$$P_{fa} = P(Y \geq \lambda/H_0) \quad (3.7)$$

$$P_{fa} = Q\left(\frac{\lambda - \sigma_w^2}{\sigma_w^2/\left(\frac{N}{2}\right)}\right) \quad (3.8)$$

where $Q(\cdot)$ is the generalized Marcum Q-function, λ is the ED's threshold, and both mentioned probabilities are assumed to follow Gaussian distribution.

3.4 Context Modeling Unit

Cooperative spectrum sensing was proposed a long time ago to mitigate the problem of sensing uncertainty due to several limitations of traditional spectrum sensing techniques [35]. However, most of the work in the area of cooperative spectrum sensing treats the information sent from different CR nodes almost equally in terms of its sensing reliability, which is not the case in real-life scenarios. In fact, cooperative spectrum sensing was originally proposed to tackle sensing uncertainty problems by having several random spatially distributed sensors (cognitive radio nodes), because the variation of secondary users' locations incurs different contexts in the sensing scope. For example, sensing of environments with different SNR levels can lead to different reliability grades for the sensing observations

and consequently different potential decisions for the same primary user. In other words, assuming that all cooperating CR users have the same or even similar environments means that cooperative sensing may not add a significant improvement over single CR user sensing. In addition to the different environment natures that CR users might have, they can be located far away from the primary user at different distances. This variation of the separating distances, then, makes it essential to deal with the sensed information at different CR nodes asymmetrically according to the path losses of the received signals at different unlicensed users, especially with a large number of SUs.

Cognitive Radio, by its definition, should be aware of its surrounding features (e.g., location) and able to exploit this information as a knowledge base to assist the sensing strategies. In this study, we have investigated the possibility of improving ED performance by incorporating specific contextual information to the decision process. This can be achieved by comparing the decision accuracy in the two cases: traditional ED "**Blind ED (BED)**" and "**Aware ED**". In this study, we use the terms "blind" and "traditional" alternatively, as the traditional energy detection scheme is unaware of the surrounding environments of the contributing unlicensed user.

Different from BED, Aware ED consists of the main elements of the traditional ED, however assisted with some contextual parameters to optimize its final decision, as depicted in the following block diagram.

Generally, contextual parameters can be any information that might affect the signal propagation, such as the nature of the primary transmitter's and receiver's locations or

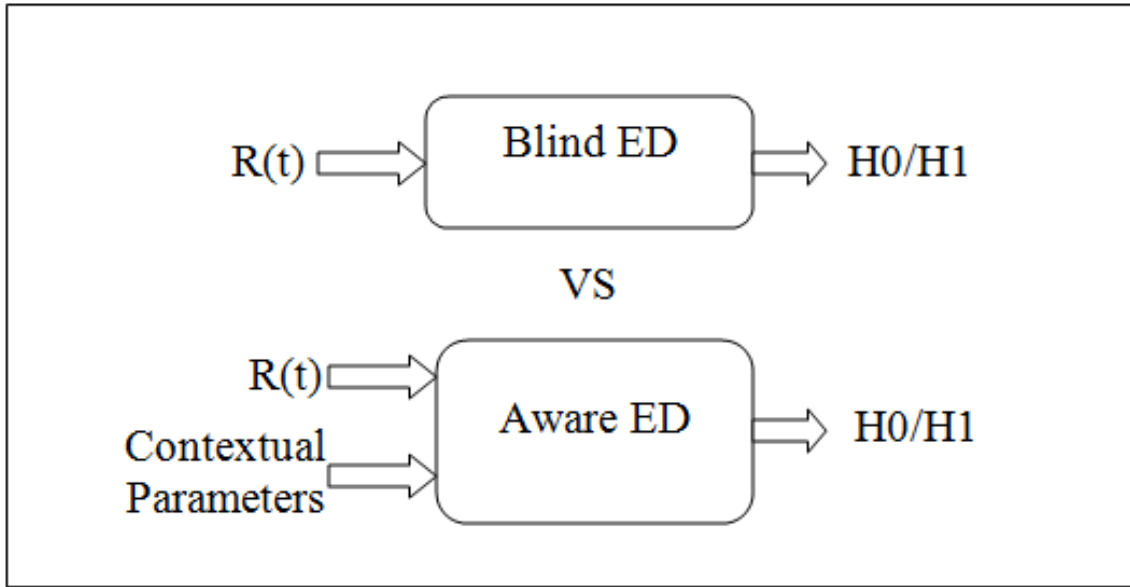

Figure 3.3: Blind Vs. Aware-ED

the nature of the surrounding environment (Indoor/Outdoor, controlled environment, etc). The performance of both mentioned models, Blind and Aware EDs, will be assessed using the false alarm and detection probabilities. In particular, this study employs four significant parameters to model the context of each user:

1. Since the cooperating secondary users are assumed to be located in different noisy environments with different noise floors, unlicensed users are more likely to set different threshold values for their local sensing systems.
2. The signal to noise ratio value, when and where the secondary user senses the band of interest, is also included as a main factor for modeling the context of each SU.

3. As explained in Section 2.3, the sensing period has a very influential impact on the sensing reliability. In this study, the sensing time or period is added to the contextual parameters to be fused with the other data for every secondary user.
4. One of the most crucial parameters affecting sensing accuracy is the path loss as one of the main channel impairments for every cooperating unlicensed user. Therefore, the severity grade of the path loss of each SU has been engaged in the context-modeling unit.

Once these features are extracted, they are sent in parallel with the local decision for every cooperating unlicensed user to the cognitive central unit where a trained Artificial Neural Network is utilized to fuse all those features and conclude one global decision as depicted in Fig. 3.4.

3.4.1 Energy Detector Threshold

The most challenging issue of the energy detection algorithm, which should be highlighted, is setting an optimal threshold level to be compared to the energy received by the secondary users. Setting the threshold to a very large value means that we consider all low-power signals as noise, and this ultimately leads to false detection. In contrast, too-small values of the threshold might mislead the decision-making center by treating noise as low signals, called false rejection. Thus, having a fixed threshold with which all cooperating secondary

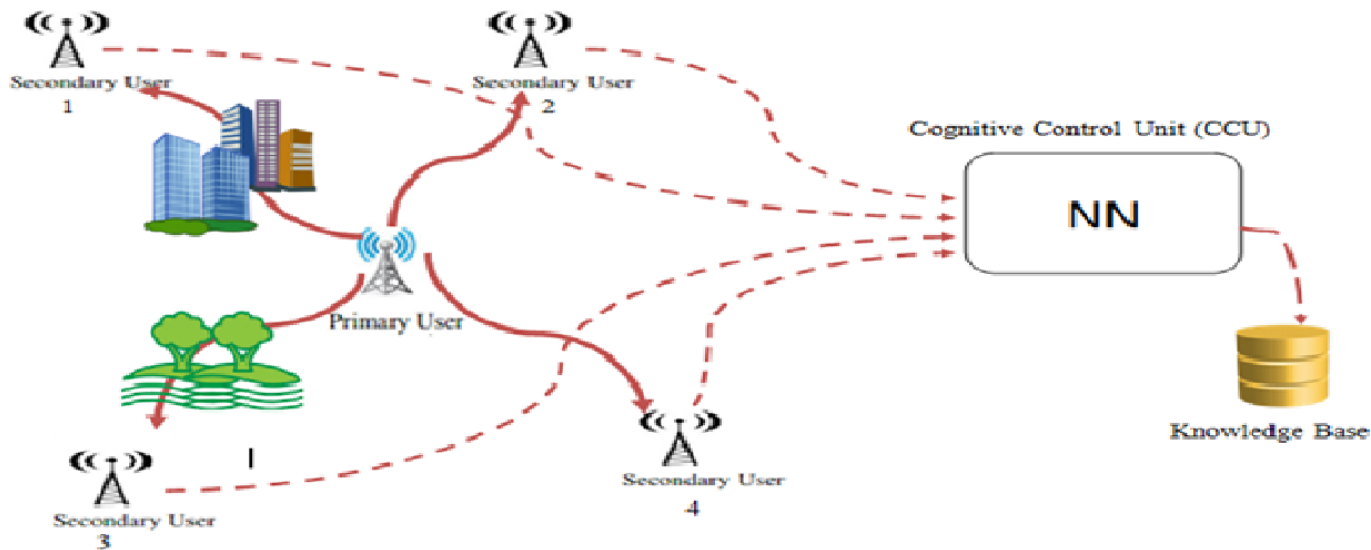

Figure 3.4: ANN-based Cooperative Spectrum Sensing

users can detect the PU's existence is not a reliable base for making final decisions. Instead, a dynamic threshold is required to optimize the global decision.

A number of strategies have been employed in previous studies to calculate the threshold value of ED. The most common two are the **Constant False Alarm Rate** algorithm (**CFAR**) [49] and the **Constant Detection Rate** algorithm (**CDR**) [49]. The former is based on setting a constant false alarm probability P_{fa} to calculate the threshold as depicted in Equation 3.9, then using that threshold value to calculate the corresponding detection probability P_d .

$$\lambda_{fa} = \sigma_w^2 \left(1 + \frac{Q^{-1}(P_{fa})}{\sqrt{2N}} \right) \quad (3.9)$$

In contrast, for the CDR, a target detection probability is chosen to calculate the threshold

value as shown in Equation 3.10.

$$\lambda_d = (\sigma_s^2 + \sigma_w^2) \left(1 + \frac{Q^{-1}(P_d)}{\sqrt{2N}}\right) \quad (3.10)$$

In this research, the first method (CFAR) is used to calculate the threshold since, unlike the CDR scheme, it needs no knowledge of the primary user's signal power.

Because each secondary user is assumed to be located in a different environment from other unlicensed users, this brings in the possibility of different noise levels among the secondary users. Therefore, in this study, each secondary user applies an adaptive threshold level based on the SNR value at that SU's location.

3.4.2 Sensing Time

Sensing period, which indicates how often a cognitive user needs to sense the PUs band of interest, is a design parameter that should be defined carefully based on certain factors. Since the CR technology maintains the priority for PUs' requirements, PUs have the property to claim their frequency bands anytime they need. This can even happen during a SU's activities. Therefore, to avoid any interference for both systems (i.e., the primary and secondary ones), the sensing process should be done within a certain short period. However, a tradeoff between that period's length and the sensing reliability must be highlighted.

As shown in the Equations 3.5 and 3.7, both the probabilities of detection (or misdetection) and false alarm are highly dependent on the sensing time where the number of

samples $N = T_s * f_s$, T_s is the sensing period and f_s is the sampling frequency. Thus, for a given total time frame (T_{total}) where $T_{total} = T_s + T_t$, the longer the sensing time T_s , the shorter the possible transmission time T_t as depicted in Fig. 3.5 [45]. Furthermore, it is well known that the function $Q(x)$ is a monotonically decreasing function of x , so, as we can see in Equation 3.7, the larger the number of samples N , the longer the sensing time and the lower the false alarm probability, which indicates a higher chance of spectrum utilization by the secondary system.

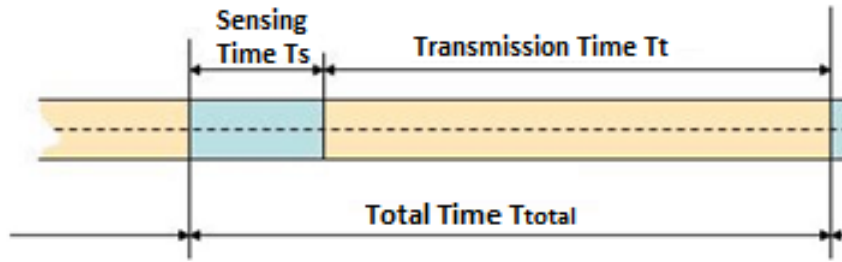

Figure 3.5: Tradeoff between spectrum sensing time and user throughput

Thus, increasing the sensing time can improve the spectrum sensing credibility; however, this should be allowed only within a maximum limit for the sensing period in order to protect the primary user from any possible interference. For instance, the sensing period should be no longer than 2 seconds ($T_s \leq 2sec$) for the standard IEEE 802.22 WRAN [11,51]. In this study, the sensing period is varied among different secondary users to form an important dimension of the context modeling process.

3.4.3 Path Loss

The rapid increase of wireless services and the nature of wireless signal propagation necessitate the demand for prediction models that have the ability to catch the complexity and instability of the propagation environment of a wireless signal. In this context, path loss is a major factor of the communication system's link budget, and needs to be analyzed as a fundamental step in the design of wireless communication systems. There are several path loss models in the literature, developed to assist radio-systems designers with a comprehensive knowledge of the propagation environment. These models vary from one model to another in several aspects: the suitability of particular environments, the algorithm used to calculate the path loss, the accuracy level, the main parameters required to determine the channel status, etc. Certain common path loss models have been employed in a large body of research; for example, the Okumura-Hata model [30], COST231-Hata model [1], ITU Terrain Model [5], Egli model [5], Sakagami model [48], and COST231-Walfisch-Ikegami model [2]. Nevertheless, some of these models have been accompanied with some limitations as well. For instance, the Okumara Hata models response is relatively slow with respect to signal transitions. On the other hand, the ITU Terrain model is not suitable for terrains with high irregularities.

Although the Cost 231 Hata model requires that the base station antenna should be higher than all the neighboring rooftops, this model performs very well in urban areas and big cities in terms of prediction accuracy. The Cost 231 Hata model has been developed

by the European Cooperative for Scientific and Technical research (EURO-COST) as an extension to the Hata model to cover a more elaborated range of frequencies of 1500 MHz to 2000 MHz [1, 28].

$$PL_{urban}(dB) = 46.3 + 33.9 \log f_c - 13.82 \log h_b - ah_m + (44.9 - 6.55 \log h_b) \log d + C_m \quad (3.11)$$

where f_c is the carrier frequency, h_b is the height of the base station, d is the distance in Km, and ah_m is defined as:

$$ah_m = (1.1 \log f_c - 0.7)h_m - (1.56 \log f_c - 0.8) \quad (dB)$$

$$C_m = \begin{cases} 0 & \text{for medium sized cities and suburban areas} \\ 3dB & \text{for metropolitan areas} \end{cases} \quad (3.12)$$

The Cost 231 Hata model is restricted to the range of 30m to 200m for the base station antenna height, and 1m to 10m for the mobile antenna height. As well, the distance between the two antennas should be in the range of 1km to 20km.

3.5 Artificial Neural Network Based Fusion Unit (Decision, Learning, Knowledge Base)

Owing to the main definition of cognitive radio technology, learning is an essential characteristic of cognitive radio technology. In this regard, with learning ability, cognitive radio technology can make a knowledge base and utilize it to update its behavior and actions

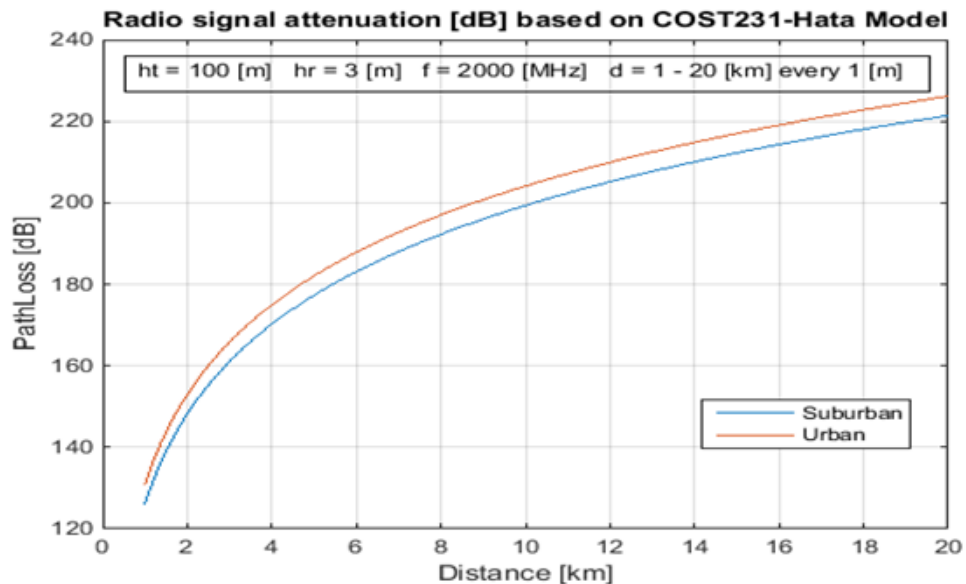

Figure 3.6: Cost 231 Hata PL

according to the ambient radio environment. In order to accomplish that, this research employs an Artificial Neural Network model as a machine learning tool that exploits past sensing experiences to optimize the total detection error, as shown in Equation 3.13, where J is the cumulative error as a function of the weights connecting the nodes at different layers, t is the target output, z is the NN's output, and c is the number of the nodes at the output layer.

$$J(w) = \frac{1}{2} \sum_{k=1}^c (t_k - z_k)^2 \quad (3.13)$$

The main attraction of using Neural Network based cooperative spectrum sensing lies in the fact that a cognitive radio system can learn and train itself from historical data of the previous scenarios and ultimately make optimal decisions without the need for

comprehensive knowledge about the current processed signal.

In addition to the learning capability of ANN models, this study employs ANN as a weighting scheme for the fusion process, whereby the contextual data of each secondary user is used to assist its local decision. In other words, the combination of the contextual information of each secondary user can either strengthen or weaken the SU's local decision.

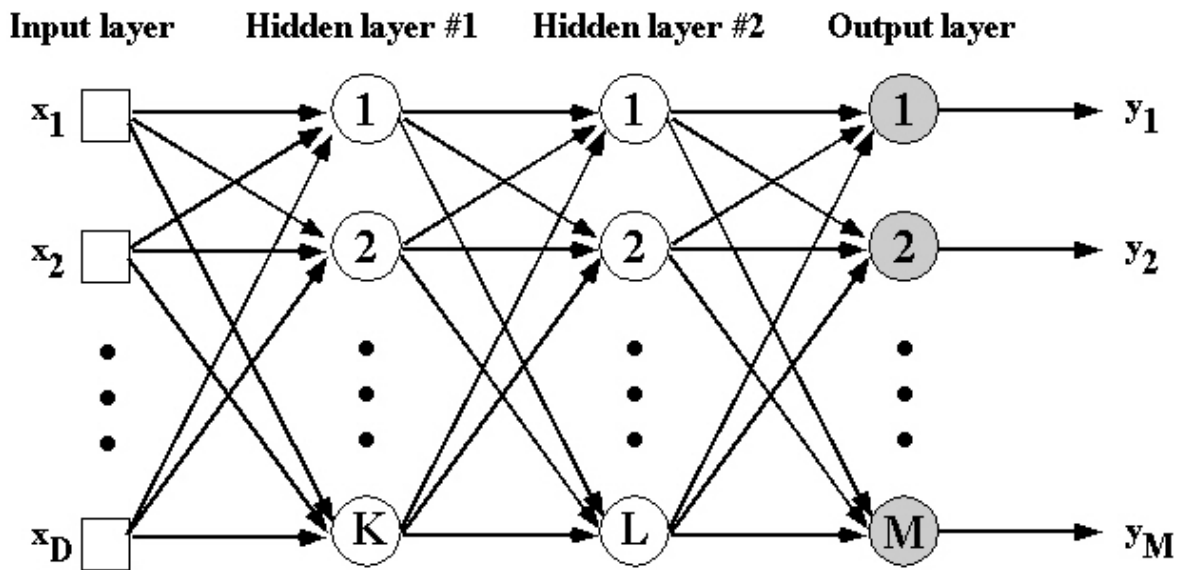

Figure 3.7: Multilayered Perceptron ANN

Different typologies and learning algorithms for the neural network model are presented in the literature, and each has its own pros and cons. For example, although the simplicity of the single-layer-perceptron neural network model has attracted many researchers, its learning capability has been demonstrated to be very limited. As well, it cannot deal with non-separable linear patterns [41]. On the other hand, another feed-forward ANN

known as Madaline has shown better learning capabilities. However, it cannot tackle sophisticated classification problems such as multi-class pattern recognition problems. In this study, a Feedforward Multilayer Perceptron Neural Network (MLP NN) with back propagation learning algorithm (BPL) is elected to be implemented as a fusion model due to its superior learning capabilities [41]. In addition, it has the ability to classify very complicated nonlinear patterns. In this thesis, MLP is employed as a fusion technique at the cognitive central unit, which receives the local observations acquired by different cooperating secondary users along with other information modeling the context of each SU when and where it has acquired its sensed data.

Fig. 3.7 shows the typical representation of an MLP neural network with an input layer, n hidden layers ($n \geq 1$), and an output layer [8]. In general, the number of hidden layers of MLP is highly dependent on the problem itself, and there is no general rule for that. However, according to previous research, the larger the number of hidden layers, the more sophisticated problems might be solved, but at the expense of increasing the computational complexity.

In ANN systems, a set of input-output data of the actual process is solved through measurements. Later, these patterns are used as examples to draw a conclusion for future scenarios. After each journey from the input layer to the output layer of the neural network, the error is fed back in the reverse direction to update the weights connecting the nodes, in what is known as the Back Propagation training algorithm. The optimization of the network behavior is actually directed with the gradient descent of the cumulative error or

with respect to the weight vector in an iterative manner as shown in Equation 3.14. As well, the sigmoid function is used as the activation function for all the network nodes.

$$\Delta W(t+1) = -\eta \frac{\partial E(t)}{\partial w} + \gamma \Delta W(t) \quad (3.14)$$

η is the learning rate, γ is the momentum factor.

In fact, the Gradient Descent algorithm, as a training scheme, requires many little steps to converge with different values of the learning rate η . Furthermore, very small values of the learning rate will probably bring slow convergence; on the other hand, large steps for the learning rate will accelerate the convergence, but at the expense of unwanted oscillation or unstable behavior of the network. Therefore, the momentum concept was proposed in the literature to tackle this tradeoff. In the current study, the update of the weights is impacted by, besides the learning rate, different values for the momentum factor multiplied by the previous weight change [41]. The momentum factor can have a value in the range of [0,1].

Thus, a row of four contextual parameters for every cooperating secondary user in addition to its local decision is fed in as input features to the neural network for the training purpose as follows:

$$\begin{aligned} Data - set(i) = [d_{i1}, SNR_{i1}, Thre_{i1}, Ts_{i1}, PL_{i1}, d_{i2}, SNR_{i2}, Thre_{i2}, \\ Ts_{i2}, PL_{i2}, d_{i3}, SNR_{i3}, Thre_{i3}, Ts_{i3}, PL_{i3}] \end{aligned} \quad (3.15)$$

where d_{i1} is the distance separating the PU and SU1, SNR_{i1} is the SNR at the SU1

location, $Thre_{i1}$ is the local threshold value used by SU1, PL_{i1} is the path loss for the received signal at the SU1, and similarly for the other two users.

Specifically, in this research it is assumed that three secondary users cooperate with each other to sense the PU's band of 2.4GHz, and then their observations along with the estimated contextual information are sent to the fusion center. In particular, 800 different scenarios of the secondary users' data are simulated and employed as different data sets to train the neural network.

Chapter 4

System Implementation and Results

4.1 System Implementation

As explained in Chapter 3, the system is implemented through different stages at different units. Prior to employing the proposed system of different units, this study starts with a comprehensive analysis investigating the impact of the main contextual features stated in Section 3.4 (e.g. SNR, threshold value, etc) of different secondary users that are spatially distributed. These features are extracted in parallel to the sensing process using Energy Detection algorithm. All experiments have been done for one primary user with a central frequency f_c of 2.4GHz. Several Monte Carlo simulations using MATLAB software were carried to evaluate the sensing performance according to the variation of the cooperating secondary users' contextual data. Receiver Operating Characteristic (ROC)

curve is used as a performance displayer to report the sensing performance with the main metrics: Detection and False Alarm probabilities. In other words, this curve reflects the sensing sensitivity to a particular parameter by varying that parameter through different values and accordingly evaluates the resulting performance. The primary user signal is first generated with a random stream and then modulated with quadrature phase shift keying (QPSK) modulation scheme, and a zero mean and variance σ_x . As well, the noise is represented with zero mean and variance σ_w . Thus, the signal samples are treated as a random process since the signal has an unknown form. In other words, the signal samples follow an independent and identically distributed (i.i.d.) random process.

4.2 Energy Detection Implementation

Following the generation of the primary user's signal, the signal is passed through a chain of processes in order to calculate the power received by a secondary user, as explained in Section 3.3.1. The generated signal is first filtered through a band pass filter (BPF) maintaining only the band of interest of the signal and simultaneously eliminating any noise. Next, a squaring device is employed to determine the signal power with the aid of a finite-time integrating device. Finally, the computed signal power is compared to a predefined threshold, and consequently a local decision (i.e., whether the primary user's band is idle or busy) is announced. In the following sections, the performance of ED is evaluated with the variation of the CRs' contextual information.

4.3 Assessment of the Secondary System's Contexts

Before examining the efficiency of the proposed cooperative sensing system shown in Fig. 3.1, the performance of the energy-detection algorithm is presented using ROC curves with the variation of several contextual factors of the non-cooperating secondary users. In other words, these results of sensing information by non-cooperating secondary users represent the performance of Blind-ED since they do not involve the impact of SUs' environments, as explained in Section 3.4.

4.3.1 Different Threshold Values

As explained earlier, the concept of constant false alarm is utilized to calculate the ED's threshold and later compare that value to the decision statistic (the received power in ED case) to identify the PU's current status (Busy/Idle).

In this research, the Constant False Alarm Rate algorithm (CFAR) is used to calculate the threshold value. To do so, the false alarm probability (P_{fa}) is swept through a set of values in the range $[0,1]$, and simultaneously the corresponding threshold is computed wherein M Monte Carlo simulations are carried for each threshold value. The number of Monte Carlo simulations is held at $M = 5000$, and the average signal to noise ratio (SNR) = $-10dB$.

As well, the noise variance, as a significant parameter to calculate the threshold, is also varied. For each value of the noise variance, the false alarm probability is updated through

different values to see the impact of this variation on ED's threshold. Fig. 4.1 shows the threshold values corresponding to different values of false alarm probability.

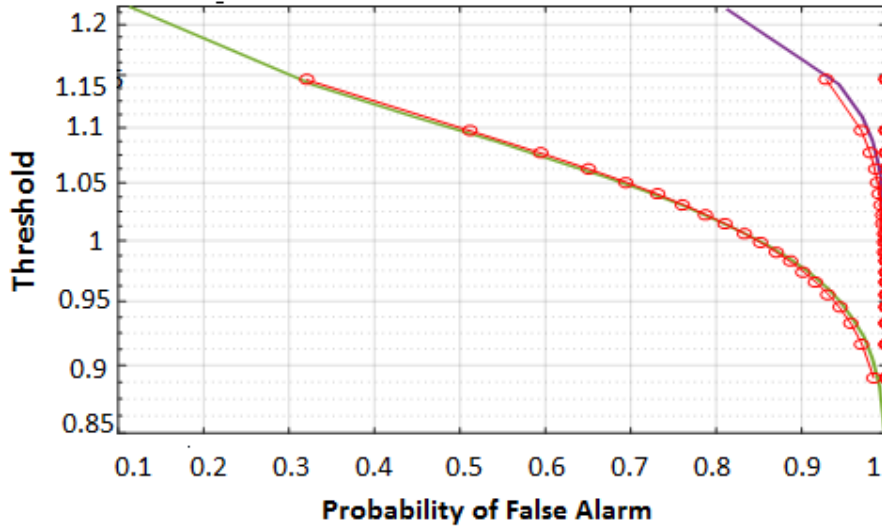

Figure 4.1: ROC Plot for ED's threshold Vs. P_f with mean SNR=-10dB, $N_{s1}=256$, $N_{s2}=500$, $N_{s3}=1000$

As shown in Fig. 4.1, three users with different number of samples have been used to calculate the threshold as a function of the false alarm probability ($N_1=256$, $N_2=500$, $N_3=1000$). For each user, we can see that as the value of false alarm probability increases, the threshold value decreases consequently. This can be explained as follows: the probability of false alarm is the probability of incorrectly detecting that the sensed band of interest is busy (i.e., the primary user is active). Thus, by increasing the probability of false alarm, the chance of missing more free frequency bands is actually increased as some noise power

portions may be identified as the primary user's signal. Therefore, this situation implies that the threshold value is lowered to include a larger portion of low signals and noise as well.

4.3.2 Different SNR Values

In addition to different threshold values, the signal to noise ratio (SNR) is also varied through a discrete range of values assuming that the cooperating secondary users are located in different noisy environments. M Monte Carlo simulations were executed for each SNR value with $M = 5000$, number of samples $N = 1000$. For each SNR value, the noise variance was changed.

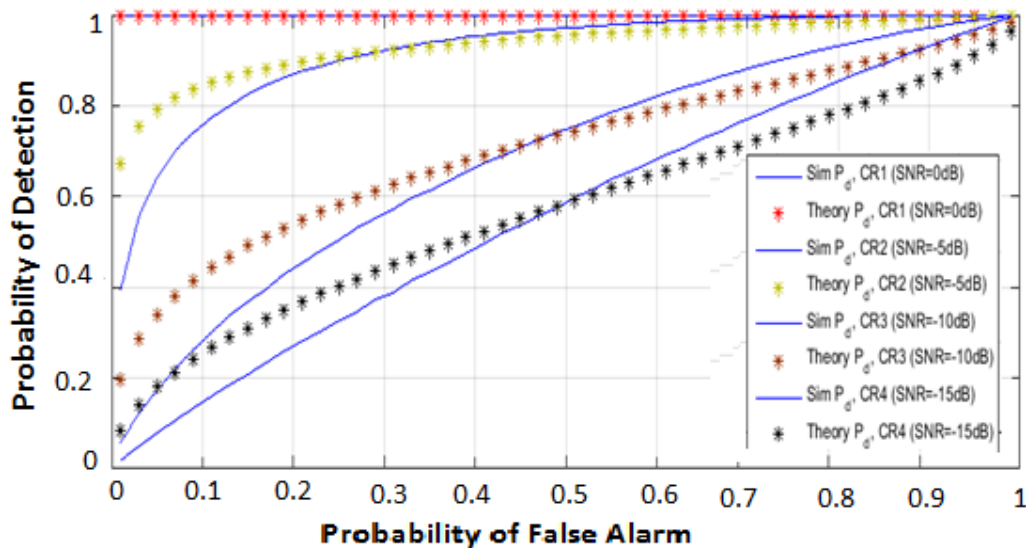

Figure 4.2: ROC Plot for Multiple SUs with different SNR values

Fig.4.2 compares the theoretical and simulation results representing the system's sensitivity to the variation of signal to noise ratio values. The theoretical results were achieved using Equation 4.1, while the simulation results were calculated by counting the number of successful detections among the total trials of a secondary user.

$$P_d = Q\left(\left(\frac{\lambda}{N\sigma_w^2}\right) - 1 - SNR\right)\sqrt{\frac{N}{1 + 2SNR}} \quad (4.1)$$

Four secondary users have been compared with $SNR = 0dB, -5dB, -10dB, \text{ and } -15dB$ respectively. As depicted in Fig. 4.2, the secondary users with higher SNR values are more likely to achieve more-reliable decisions (i.e., with higher SNR values, the secondary users are much able to differentiate between the primary user's signal and noise).

However, for traditional cooperative spectrum sensing algorithms (with no context-awareness) such as AND, OR, and Majority fusion rules, if all or at least most of the cognitive nodes are located in low-SNR environments, the cooperation between these nodes has no advantage, or it may even deteriorate the overall sensing accuracy. This mainly occurs because those cooperative spectrum sensing techniques involve the sensing information acquired by different unlicensed users blindly, without specifically considering the surrounding contexts (e.g., SNR values) of these secondary users. In this study, the SNR value of every secondary user is considered within the contextual data in the fusion process. In fact, the value of the signal to noise ratio for each cognitive node, implicitly, works as a weighting factor for the SU's local detection information.

4.3.3 Different Sensing Periods

As explained in Section 3.4.2, the sensing period is varied from one contributing SU to another (with a maximum value of 2sec), adding another important factor to the context modeling unit. Since the number of samples is the main variable used to calculate a SU's sensing period, it was updated through a range of several discrete values (e.g., $N_s = 32, 64, 128, 256$, etc). As we can see in Fig. 4.3, increasing the sensing period (i.e., increasing the number of samples) increases the probability of detection accordingly, indicating more-reliable sensing results. However, a longer sensing period actually directly impacts the duration of the transmission, resulting in low rates of the secondary system's throughput since the SU uses the same channel for both tasks (i.e., sensing and transmission). In this research, this variation in the sensing duration is augmented in the fusion process thereby forming various contexts for the contributing SUs.

4.3.4 Different Channel Impairments

Since it is assumed that the secondary users are spatially distributed, this implies that they are located in different environments and far away at different distances from the primary user's base station. This, then, incurs different grades of channel impairment. In this study, urban and suburban areas are considered; nevertheless, rural areas can also be included by adding conversions to the implemented system.

Different scenarios have been implemented in this study in terms of the secondary users'

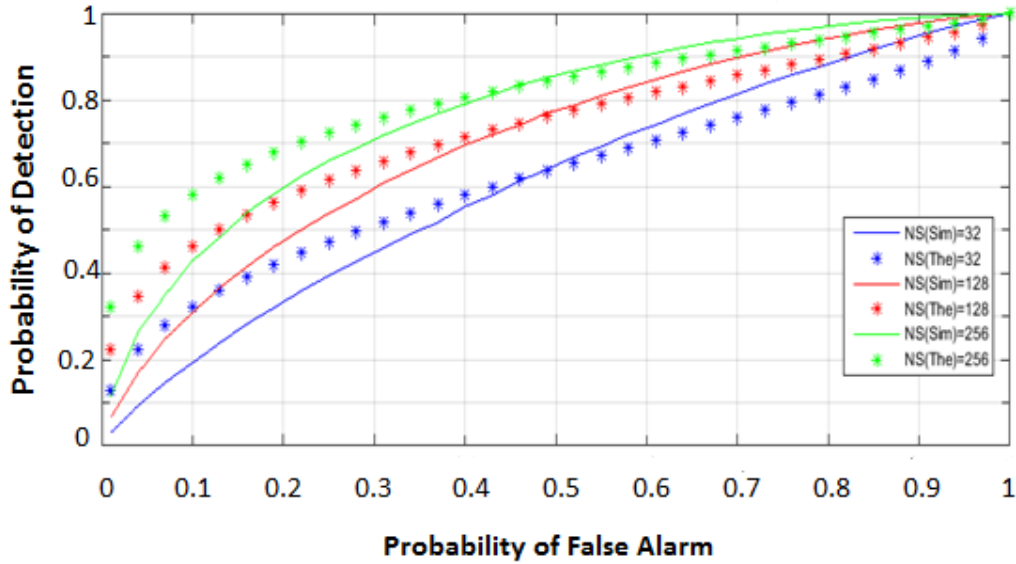

Figure 4.3: ROC Plot for Multiple SUs with different sensing periods and average SNR=-10dB

location distribution with respect to the location of the primary user's base station. For example, with three cooperating secondary users, one scenario is as follows: CR1 is the closest user to the primary user (e.g., at 750 m), meaning that it is less likely to experience harmful path loss for the received signal. On the other hand, CR2 is farther away from the primary user transmitter. This user, then, will probably receive a very weak signal or even comes to the conclusion that primary user's band of interest is free. Fig. 4.4 shows the ROC comparison of the path loss for the received signal at different secondary users' locations far away and at different distances from the primary user's base station.

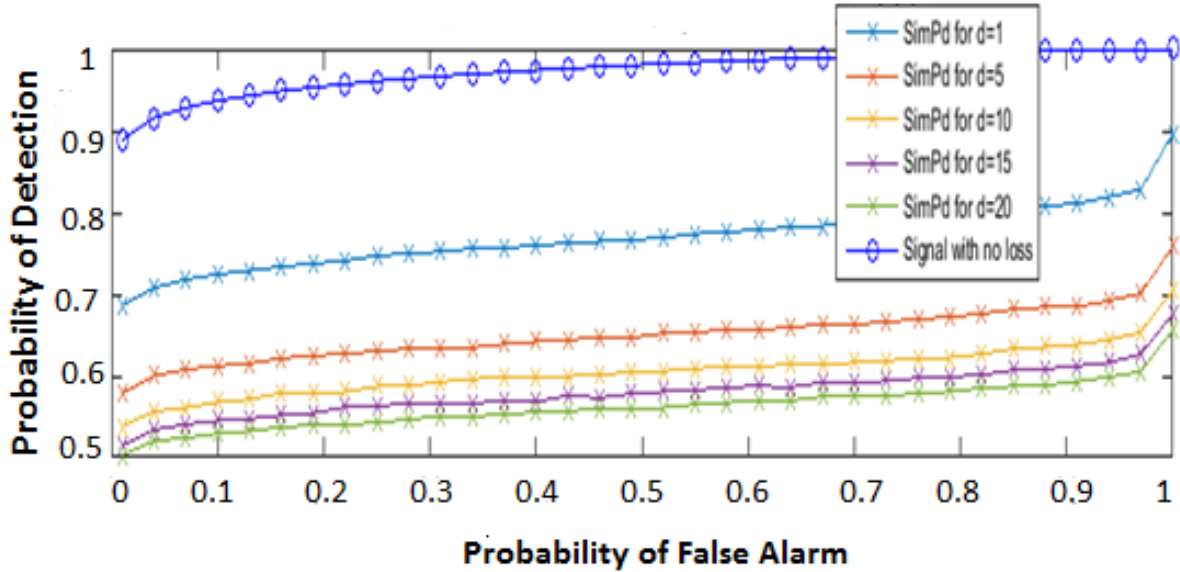

Figure 4.4: Sensing performance with different path loss values (different distances)

4.4 Artificial Neural Network Based Fusion Center

After evaluating the sensing performance according to the variation of several contextual features of the secondary system, these features were employed along with the contributing SUs' local decisions as main parameters in the fusion process. The simulation of ANN fusion approach is implemented through two main stages: ANN-training and ANN-testing.

ANN training

It is well known that the supervised learning characteristic of ANN is based on training the network first with a set of teachers (target outputs) and exemplars (ANN's features) to be able to solve future problems, classify data, and recognize patterns. In this research,

800 various scenarios, representing different contexts of the cooperating SUs, were utilized to train the neural network. These different scenarios were formed first using a Matlab code that generated different patterns of the SUs' environments using the stated contextual data: the PU's status (representing the target output in ANN's training), every SU's local decision (1/0), the SNR value of each SU, the sensing period of each SU, the employed ED's threshold value, and the path loss affecting the signal received by each contributing SU. The contextual parameters of every secondary user worked together as weighting factor that could either strength or weaken the users' local decisions. On the other hand, the NN' weights were updated automatically using the gradient descent algorithm explained in Chapter 3 (i.e., optimizing the resulting error, which is the difference between the target and actual outputs).

Furthermore, some technical factors were tested in a trail approach to test the corresponding training performance. For example, the number of the hidden layers and the hidden nodes of each layer were varied (e.g., number of hidden layers= 1,2,3,4; number of hidden nodes= 10, 20, 50, 80). In addition, the number of training epochs was swept in the range [100-600] to check the best training error achievable. Moreover, in order to optimize the training performance, the learning rate and the momentum factor, explained in Section 3.5, were also used with different values. The number of hidden layers of the ANN was not very significant in terms of the training performance. one hidden layer can achieve very good results with less cost (i.e., time). On the other hand, the training results demonstrated that increasing the hidden layers' sizes or the number of hidden nodes of

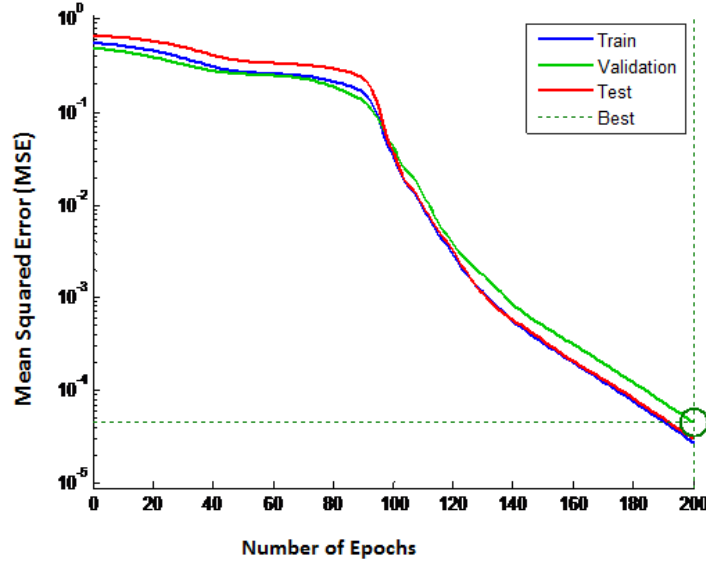

Figure 4.5: Best training performance with $MSE= 4.5085e05$ at epoch 200 for one SU

each layer improves the overall training performance.

Figures 4.5, 4.6, and 4.7 illustrate the optimization of the training-error using Mean Squared Error (MSE) algorithm with the best number of epochs of 200. In particular, Fig. 4.5 shows the resulting performance with only a single SU for the three data sets: training, validation and testing as a function of the number of iterations or epochs. Similarly, Fig. 4.6 and Fig. 4.7 illustrate the training performance with two and three secondary users respectively. In these figure, we can see the impact of the weights update to calculate the gradient. The error optimization of all data sets continues to improve until it converges to a minimum with the number of epochs of 200. Then, the error starts again to increase during the NN's training, indicating that the NW starts to miss the generalization property,

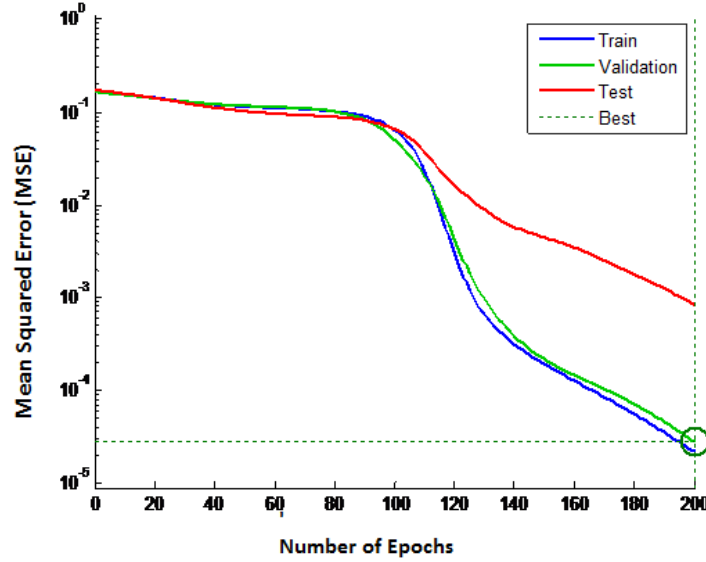

Figure 4.6: Best training performance with $MSE= 2.8334e05$ at epoch 200 for two cooperating SUs

known as the NW overfitting. However, the values of the optimized error in the three cases demonstrate that increasing the number of the cooperating secondary users (i.e., increasing the number of features of the ANN's data set) caused to improve the overall training performance with MSE values: $4.5085e05$ (1 SU), $2.8334e05$ (2 SUs), and $1.9641e05$ (3 SUs).

ANN testing

After training the neural network with a large data set, several smaller data sets were employed to test the efficiency of the proposed fusion system. An example of these testing sets is presented in Table 4.1.

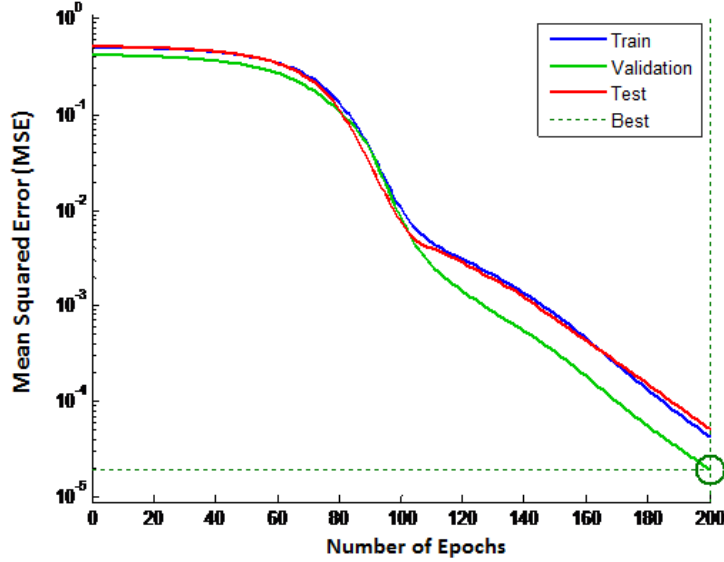

Figure 4.7: Best training performance with MSE= 1.9641e05 at epoch 200 for three cooperating SUs

As previously illustrated in Chapter 3, the SUs’ contexts in the first column of Table 4.1 simply represent different patterns of the SUs’ environments during the sensing process. On the other hand, column 2 and 3 of the table represent the ANN’s global decision for the spectrum status and the actual or real PU’s status (1/0). Thus, this data sample represents some possible combinations of three SUs’ contexts. For example, Context1 represents the environmental features of the three cooperating users: SNR1= -10dB, N1= 256, PL1= 0.3, d1=2Km, SNR2=-5dB, N2=1000, PL2=0.7, d2=1Km, SNR3= 0dB, N3=500, PL3=0.09, d3=300m. As well, the local decision of each secondary user is involved in the context. Other different combinations of the SUs’ features were applied in the rest of the contexts.

SUs Data	ANN' global decision	Target Decision (PU's Status)
Context 1	0.00127090	0
Context 2	0.99962000	1
Context 3	0.99947000	1
Context 4	0.99752000	1
Context 5	0.99974000	1
Context 6	0.99831000	1
Context 7	0.99927000	1
Context 8	0.00058169	0
Context 9	0.01101600	0
Context 10	0.99962000	1

Table 4.1: Different Testing Scenarios of ANN-based Fusion Center

As we can see in the table, the difference between the two outputs (i.e., target and actual outputs) is very small, and it can be rounded using a simple rounding algorithm. This promising results of ANN prediction proves that the proposed system can achieve very reliable sensing results, and its performance outperforms other fusion techniques such as AND and Majority rules with the same number of the cooperating secondary users.

Fig. 4.8 shows the detection probability for two different cooperative sensing techniques: Majority and AND fusion rules. The simulation results of these two techniques show that the Majority rule outperforms AND-fusion system with the same number of the cooperating SUs (e.g., No of SUs= 5). Nevertheless, both system show slow improvement for the sensing reliability relative to the cost of the increase in false alarm probability values. On the other hand, ANN-based fusion algorithm has achieved high grades of sensing reliability with less

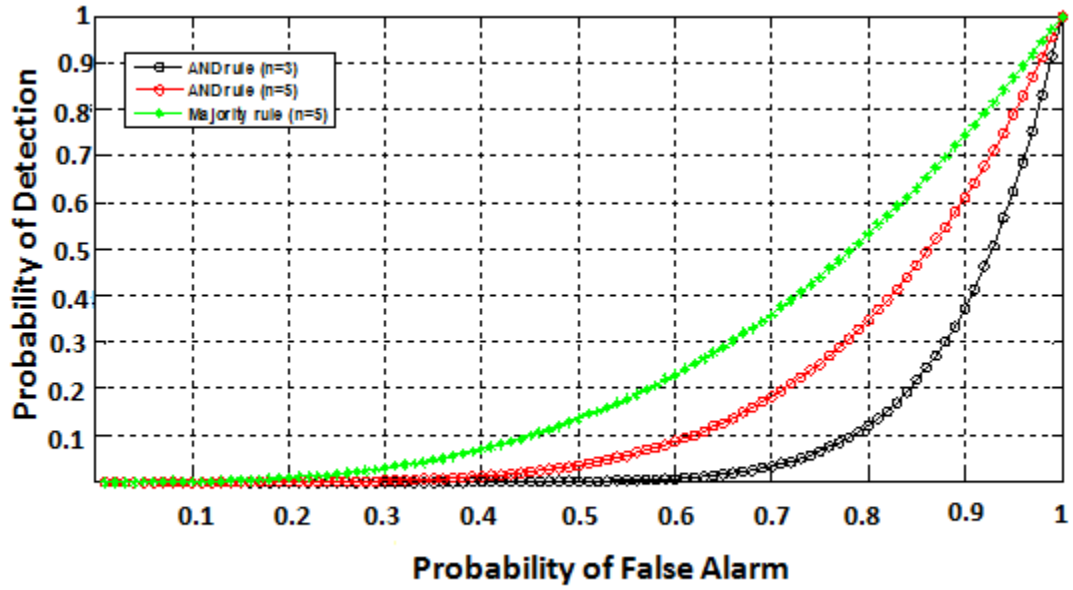

Figure 4.8: Sensing performance for two cooperative SS techniques (Majority and AND) over AWGN channels with mean $SNR = -10dB$

cost (i.e., less number of SUs needed to cooperate).

Chapter 5

Conclusion and Future Work

5.1 Conclusion

The fixed radio spectrum allocation's policies that characterize today's wireless networks cannot meet current requirements in wireless communications. Thus, Cognitive Radio technology was proposed to tackle the problem of spectrum management. The cognition and learning capabilities of CR technology facilitate coexistence between the primary and secondary users in a dynamic fashion, maintaining the priority of the PUs' needs. In order to achieve these goals, a cognitive user has to sense the available spectrum periodically and smartly, and accordingly make the right decision (i.e., to use or not to use the band of interest). Therefore, spectrum sensing is a major element of the cognition cycle of CR networks.

The work described in this thesis has concerned with the development of an intelligent spectrum-sensing system that defines spectrum status efficiently. First, a comprehensive review has been done of related design issues in the scope of Cognitive Radio Networks. In this context, various crucial issues, related to CR technology in general and the spectrum sensing stage in particular, were discussed. Different spectrum sensing techniques were compared in terms of their sensing reliability, simplicity, computational cost, etc. The importance of the cooperation among several secondary systems was highlighted. The spatial variation of different contributing cognitive users was the inspirational key of this research, which exploits that variation through an intelligent cooperative spectrum sensing system.

A novel cooperative spectrum sensing system has been implemented, in this research as explained in Chapter 3. This proposed system consists of several intelligent units performing different fundamental tasks. ED algorithm was employed as a local spectrum-sensing technique at the SSU where every SU has to sense the PU's band of interest periodically and locally at its physical position. Simultaneously, at the CMU, a number of interesting contextual features were defined for every SU, modeling the surrounding environment of each contributing cognitive user. The results of both units were sent to the CCU at the same time in a row format for each user. At this point, a trained ANN was utilized to fuse all data for the contributing secondary users received from both units: SSU and CMU. Furthermore, all the applied scenarios were stored in a knowledge base to achieve the learning and reasoning goals for future decisions.

The system's performance has been evaluated through a large number of simulations in Matlab. Detection and false alarm probabilities were the basic metrics used to evaluate the overall performance of the designed system. Incorporating the contextual information of the secondary users in the fusion process has shown promising results over the traditional fusion techniques. In this context, we could improve the detection probability of the cooperative system with less cost of the corresponding increase of the false alarm probability. As well, our proposed system has achieved very good detection results with less number of cooperating CR users comparing with other cooperative techniques.

5.2 Future Work

Although the results presented in this thesis have demonstrated the effectiveness of the proposed cooperative sensing system, it could be further developed in a number of ways:

- **Extending the SSU to incorporate more than one local sensing technique**

As explained in Section 2.5, every local sensing technique has its own features and limitations as well. Thus, using more than one local sensing technique for the different cognitive users might improve decision reliability, since different features of the received signal will be utilized. Matched Filter detection, Cyclostationary Feature detection, and Energy detection algorithms would form an interesting combination as a prior step to the decision making process.

- **Extending the CMU's dimensions**

In this thesis, modeling the environment of each secondary user at the CMU is based on a number of that SU's contextual data (i.e., SNR, sensing period, the ED's threshold value, path loss). These features could be extended in the future work of this research to include other significant factors such as other channel impairments (e.g., multipath fading level), the sensing time instance of the day in addition to the sensing period, etc.

- **Extending the CCU to a Fuzzy-based Artificial Neural Network fusion algorithm**

The concept of **Fuzzy Neural Network (FNN)** was originally coined by Jang [38], combining the learning capabilities of ANN and the human-like reasoning features of the fuzzy-logic system (FLS) [38]. Unsurprisingly, both ANN and FLS have their strengths and limitations as well. For example, FLS depends on fuzzy sets and linguistic rules to model the problem of interest, and they can encompass very accurate details of the system's requirements. On the other hand, the connectionist structure and the learning capabilities reveal the key secret behind the success of ANN technique [25]. Therefore, FNN can provide more powerful prediction capabilities as a fusion technique for future work of this thesis.

- **Exploring the use of Software Defined Radio as a practical framework for cognitive radio applications**

As explained in Section 2.7, SDR can be utilized as the foundation of CR technology, facilitating the employment of cognition capabilities to achieve CR goals. In other words, with its reconfigurability and flexibility features, SDR can be described as an enabler of CR tasks.



Figure 5.1: Universal Software Radio Peripheral (USRP B200) device

During the experimental work of this research, it was first decided to apply the sensing process to real-world signals input from an RF frontend, rather than ideal signals generated in Matlab. However, due to resource limitations, mainly time constraints, this step was left for future work. Nevertheless, a few primary experiments have been executed to detect a primary user's signal over **Universal Software Radio Peripheral (USRP B200)** device. USRP B200, shown in Fig. 5.1 [3] is a fully

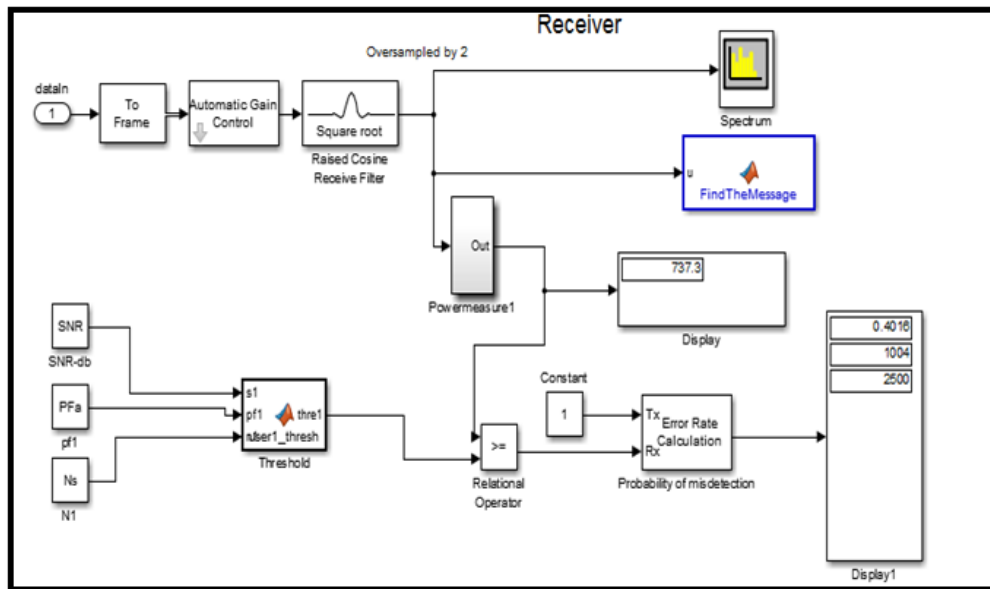

Figure 5.2: Energy Detection Simulation with USRP B200 receiver

integrated SDR device with continuous RF coverage from 70MHz to 6GHz. Moreover, it is characterized by full duplex operation, with up to 56MHz of real time bandwidth. As well, it has fast and convenient bus-powered connectivity using SuperSpeed USB 3.0 and open reconfigurable FPGA [3].

Fig. 5.2 shows a Simulink block diagram representing a basic communication system with one primary user who has a QPSK-modulated signal and one secondary user who senses the PU's signal using ED technique. The top of the figure shows the USRP B200 device acting as a primary receiver of a real signal with a central frequency of 2.4GHz and modulated with a QPSK modulation scheme. On the other hand, the bottom of the figure shows a simple secondary system of a single SU sensing the PU's band using ED

algorithm. Prior to comparing the received signal with the PU's status, the threshold value is calculated using the CFAR algorithm explained in Section 3.4.1. The future work of this research might be implemented completely over SDR devices with real signals in order to draw a complete picture of an intelligent sensing system.

References

- [1] *European Cooperation in the Field of Scientific and Technical Research EURO-COST231, Urban Transmission LOSS Models for Mobile Radio in the 900 and 1800 MHz Bands*, sep 1991.
- [2] *COST 231, Digital mobile radio towards future generation systems, Final Report, COST Telecom Secretariat, European Commission, Brussels*, 1999.
- [3] About ettus research ettus research, a national instruments (ni) company, 2015.
- [4] J.D. Poston A. Ginsberg and W.D. Horne. Toward a cognitive radio architecture: Integrating knowledge representation with software defined radio technologies. *IEEE Military Communications Conference (MILCOM)*, pages 1–7, oct 2006.
- [5] E.G. Pelaez A.P. Neto, E.O. Rozal. Bidimensional statistics analysis of the bertoni - walfisch propagation model for mobile radio design in urban areas. In *Microwave and Optoelectronics Conference, 2003. IMOC 2003. Proceedings of the 2003 SBMO/IEEE MTT-S International*, volume 2, pages 801 – 806, 2003.

- [6] Catherine Rosenberg Aravind Iyer and Aditya Karnik. What is the right model for wireless channel interference? *IEEE TRANSACTIONS ON WIRELESS COMMUNICATIONS*, 2009.
- [7] C. Bergl jung and P. Karlsson. characteristics for indoor broadband radio access networks in the 5 ghz band. *in Proc. IEEE Int. Symp. Pers., Indoor Mobile Radio Commun*, page 612616, 1998.
- [8] C.M. Bishop. *Neural Networks for Pattern Recognition*. Clarendon Press, 1996.
- [9] Milind M. Buddhikot. Understanding dynamic spectrum access: Models,taxonomy and challenges. *New Frontiers in Dynamic Spectrum Access Networks*, pages 649 – 663, 2007.
- [10] E. Stuntebeck C. Clancy, J. Hecker and T. O’Shea. Applications of machine learning to cognitive radio networks. *IEEE Wireless Communications*, 14(4):47 – 52, aug 2007.
- [11] Canada Zhongding Lei Singapore Wendong Hu Stephen J. Shellhammer Carl R. Stevenson, Gerald Chouinard and Winston Caldwell. Ieee 802.22: The first cognitive radio wireless regional area network standard. *IEEE STANDARDS IN COMMUNICATIONS AND NETWORKING*, 2009.
- [12] I. Cuinas and M. G. Sanchez. Measuring, modeling, and characterizing of indoor radio channel at 5.8 ghz. *IEEE Trans. Veh. Technol*, 50:526535, mar 2001.

- [13] Shridhar Mubaraq Mishra Danijela Cabric and Robert W. Brodersen. Implementation issues in spectrum sensing for cognitive radios. *Proc. Of Asilomar Conf. on Signals, Systems, and Computers*, 1:772776, 2004.
- [14] Alin Dobra David Kempe and Johannes Gehrke. Gossip-based computation of aggregate information. *in Proceeding of IEEE Symposium on Foundations of Computer Science (FOC)*, pages 482–491, oct 2003.
- [15] D. Devasirvatham. A comparison of time delay spread and signal level measurements within two dissimilar office buildings. *IEEE Trans. Antennas Propagat*, AP-35:319324, mar 1987.
- [16] P. E. Driessen. Prediction of multipath delay profiles in mountainous terrain. *IEEE J. Sel. Areas Commun.*, 18:336–346, mar 2000.
- [17] R. Peterson E. Visotsky, S. Kuffner. On collaborative detection of tv transmissions in support of dynamic spectrum sharing. In *New Frontiers in Dynamic Spectrum Access Networks, 2005. DySPAN 2005. 2005 First IEEE International Symposium on*, pages 338 – 345, 2005.
- [18] K. Madisetti Ed. Vijay and Douglas B. Williams. *Digital Signal Processing*. CRC Press LLC, 1999.
- [19] Dusit Niyato Ekram Hossain and Zhu Han. *Dynamic Spectrum Access and Management in Cognitive Radio Networks*. Cambridge University Press, New York, 2009.

- [20] Vinko Erceg. Channel models for fixed wireless systems. IEEE 802.16d-03/34, may 2001.
- [21] Mohamed-Slim Alouini Fadel F. Digham and Marvin K. Simon. On the energy detection of unknown signals over fading channels. In *IEEE Transactions on Communications*, volume 55 of 1, page 2124, 2007.
- [22] Frank H. P. Fitzek and Marcos D. Katz. *Cognitive Wireless Networks: Concepts, Methodologies and Visions Inspiring the Age of Enlightenment of Wireless Communications*. Springer Science & Business Media, 2007.
- [23] G. Ganesan and Ye Li. Cooperative spectrum sensing in cognitive radio, part i: Two user networks. *IEEE Transactions on Wireless Communications*, 6(6):2204-2213, 2007.
- [24] G. Ganesan and Ye Li. Cooperative spectrum sensing in cognitive radio, part ii: Multiuser networks. *IEEE Transactions on Wireless Communications*, 6(6):2214-2222, 2007.
- [25] M.B. Ghalia and A.T. Alouani. Artificial neural networks and fuzzy logic for system modeling and control: a comparative study. *System Theory, 1995., Proceedings of the Twenty-Seventh Southeastern Symposium on*, pages 258 – 262, mar 1995.
- [26] Abbas Ghasemi and E. S. Sousa. Collaborative spectrum sensing for opportunistic access in fading environments. In *New Frontiers in Dynamic Spectrum Access Networks, 2005. DySPAN 2005. 2005 First IEEE International Symposium on*, 2005.

- [27] David E. Goldberg. *Genetic Algorithms in Search, Optimization and Machine Learning*. Addison-Wesley, first edition, 1989.
- [28] Andrea Goldsmith. *Wireless Communicatio*. USA, Cambridge University Press, aug 2005.
- [29] L. R. Macel H. L. Bertoni, W. Honcharenko and H.H. Xia. Uhf propagation prediction for wireless personal communications. *Proc. IEEE*, 82:13331359, sep 1994.
- [30] Masaharu Hata. Empirical formula for propagation loss in land mobile radio services. *IEEE TRANSACTIONS ON VEHICULAR TECHNOLOGY*, VT-29(3), aug 1980.
- [31] Masharu Hata. Empirical formula for propagation loss in land mobile radio services. *IEEE TRANSACTIONS ON VEHICULAR TECHNOLOGY*, VT-29(3), aug 1980.
- [32] Simon Haykin. *Neural Networks: A Comprehensive Foundation*. Prentice Hall PTR Upper Saddle River, NJ, USA, second edition, 1998.
- [33] Simon Haykin. Cognitive radio: Brain-empowered wireless communications. *IEEE JOURNAL ON SELECTED AREAS IN COMMUNICATIONS*, 23(2), feb 2005.
- [34] Hussein Hijazi. Estimation de canal radio-mobile volution rapide dans les systmes modulation ofdm. <http://www.cs.nccu.edu.tw/~lien/NIISlide/WirelessTech/propage.htm>, nov 2008.
- [35] Brandon F. Lo Ian F. Akyildiz and Ravikumar Balakrishnan. Cooperative spectrum sensing in cognitive radio networks: A survey. *Physical Communication*, 4:4062, 2011.

- [36] David N. C. Tse J. Nicholas Laneman and Gregory W. Wornell. Cooperative diversity in wireless networks: Efficient protocols and outage behavior. *IEEE TRANSACTIONS ON INFORMATION THEORY*, 50(12):3062–3080, dec 2004.
- [37] Danda B. Rawat Jaime Lloret Mauri, Kayhan Zrar Ghafoor and Javier Manuel Aguiar Perez. *Cognitive Networks: Applications and Deployments*. CRC Press, 2014.
- [38] Roger Jang. *Neuro-Fuzzy Modeling: Architectures, Analyses and Applications*. PhD thesis, University of California, Berkeley, jul 1992.
- [39] Guoqing Ji and Hongbo Zhu. A survey of the solving strategies for the snr walls problem in local spectrum sensing. *Journal of Convergence Information Technology*, 6(8):51–57, aug 2011.
- [40] Friedrich K. Jondral. Software-defined radiobasics and evolution to cognitive radio. *EURASIP Journal on Wireless Communications and Networking*, page 275283, 2005.
- [41] Fakhreddine O. Karray and Clarence W De Silva. *Soft Computing and Intelligent Systems Design: Theory, Tools and Applications*. Pearson, first edition, jun 2004.
- [42] K.K. Bae Jung-Sun Um C.M. Spooner Kyouwoong Kim, I.A. Akbar and J.H Reed. Cyclostationary approaches to signal detection and classification in cognitive radio. In *New Frontiers in Dynamic Spectrum Access Networks, 2007. DySPAN 2007. 2nd IEEE International Symposium on*, pages 212 – 215, apr 2007.

- [43] Joseph Mitola and Gerald Q. Maguire. Cognitive radio: making software radios more personal. *Personal Communications, IEEE*, 6(4):13–18, aug 1999.
- [44] E Peh and Ying-Chang Liang. Optimization for cooperative sensing in cognitive radio networks. In *Wireless Communications and Networking Conference, 2007.WCNC 2007. IEEE*, pages 27 – 32, mar 2007.
- [45] Anil Rabde and Amit Chauhan. Intelligent spectrum sensing cognitive radio network using median filtering. *International Journal of Advance Research*, 3(3), mar 2015.
- [46] Lawrence. R. Rabiner. A tutorial on hidden markov models and selected applications in speech recognition. *Proceedings of the IEEE*, 77(2):257 – 286, feb 1989.
- [47] Jung-Min Park Ruiliang Chen and Kaigui Bian. Robust distributed spectrum sensing in cognitive radio networks. In *. IEEE INFOCOM 2008. The 27th Conference on Computer Communications*, apr 2008.
- [48] Shuji Sakagami and Kiyoshi Kuboi. Mobile propagation loss prediction for arbitrary urban environments. *Electronics and Communications in Japan (Part I: Communications) Electronics and Communications in Japan*, 74(10):87–99, oct 1991.
- [49] Saqib Saleem and Khurram Shahzad. Performance evaluation of energy detection based spectrum sensing technique for wireless channel. *INTERNATIONAL JOURNAL OF MULTIDISCIPLINARY SCIENCES AND ENGINEERING*, 3(5), may 2012.

- [50] Vatsal Sharan and Preet Wankhede. Spectrum sensing for cognitive radio. Technical report, Indian Institute of Technology Kanpur, 2013.
- [51] Stephen. J. Shellhammer. Spectrum sensing in ieee 802.22. *First IAPR Workshop on Cognitive Information Processing*, 2008.
- [52] A. Sahai S.M. Mishra and R.W. Brodersen . Cooperative sensing among cognitive radios. In *Communications, 2006. ICC '06. IEEE International Conference on*, volume 4. IEEE2006, jun 2006.
- [53] Duminda Thilakawardana Terence Dodgson Stoytcho Gultchev, Klaus Moessner and Rahim Tafazolli. Evaluation of software defined radio technology. Technical report, Centre for Communication Systems Research, University of Surrey, feb 2006.
- [54] Richard S. Sutton and Andrew G. Barto. *Reinforcement Learning: An Introduction*. The MIT Press Cambridge, 1998.
- [55] Dina Simunic Tanuja Satish Dhope and Ramjee Prasad. Hybrid detection method for cognitive radio. *Software, Telecommunications and Computer Networks (SoftCOM)*, 2011.
- [56] Dina Simunic Tanuja Satish Dhope and Ramjee Prasad. Tvws opportunities and regulation:- empowering rural india. *14th International Symposium on WPMC*, 2011.
- [57] Shubham Tarun and Pankaj. Introduction to cognitive radio (cr). *Personal Communications, IEEE*, 6(4):13–18, nov 2012.

- [58] Shubham Tarun and Pankaj. Introduction to cognitive radio (cr). zoyok.com/blog/introduction-cognitive-radio-cr, nov 2012.
- [59] T. Ulversoy. Software defined radio: Challenges and opportunities. *IEEE Communications Surveys & Tutorials*, 12(4):531 – 550, may 2010.
- [60] Harry Urkowitz. Energy detection of unknown deterministic signals. *PROCEEDINGS OF THE IEEE*, 55(4):523– 531, apr 1967.
- [61] Ranjan K. Mallik Wei Zhang and Khaled Ben Letaief. Cooperative spectrum sensing optimization in cognitive radio networks. *IEEE Communications Society*, 2008.
- [62] J. Weitzen and T. J. Lowe. Measurement of angular and distance correlation properties of log-normal shadowing at 1900 mhz and its application to design of pcs systems. *IEEE Trans. Veh. Technol*, 51:265273, mar 2002.
- [63] Gang Xu and Yourong Lu. Channel and modulation selection based on support vector machines for cognitive radio. *in proceeding of IEEE nternational Conference on Wireless Communications, Networking and Mobile Computing (WiCOM)*, sep 2006.
- [64] B. YEGNANARAYANA. *ARTIFICIAL NEURAL NETWORKS*. PHI Learning Pvt. Ltd, 2009.
- [65] Xianzhong Xie Yi Zheng and Lili Yang. Cooperative spectrum sensing based on snr comparison in fusion center for cognitive radio. In *Advanced Computer Control, ICACC , International Conference on*, pages 212 – 216, 2009.

- [66] Edward C.Y. Peh Ying-Chang Liang, Yonghong Zeng and Anh Tuan Hoang. Sensing-throughput tradeoff for cognitive radio networks. *Wireless Communications, IEEE Transactions on*, 7(4):1326 – 1337, apr 2008.
- [67] T. Kawano Yoshihisa Okumura, E. Ohmori and K. Fukuda. Field strength and its variability in uhf and vhf land-mobile radio service. *Rev. Electr. Commun. Lab.*, 16(9), 1968.
- [68] M.A. Azam Z. Ejaz, N.U. Hasan and H.S. Kim. Improved local spectrum sensing for cognitive radio networks. *Eurasip Journal of Advanced Signal Processing*, pages 1–12, 2012.
- [69] Wei Zhang and Khaled Ben Letaief. Cooperative spectrum sensing with transmit and relay diversity in cognitive radio networks. *IEEE transactions on wireless communications*, 7(12):4761–4766, dec 2008.
- [70] Yan Zhang and Mohsen Guizani. *Game Theory for Wireless Communications and Networking*. CRC press, 2011.
- [71] Gokhan Memik Zhuan Ye and John Grossnietsch. Energy detection using estimated noise variance for spectrum sensing in cognitive radio networks. In *Wireless Communications and Networking Conference, WCNC 2008. IEEE*, pages 711 – 716, apr 2008.