

Technical and Economic Assessment of Ground Source Heat Pump Systems (GSHPs) in Ontario

by

Armughan Al-Haq

A thesis
presented to the University of Waterloo
in fulfillment of the
thesis requirement for the degree of
Master of Applied Science
in
Civil Engineering

Waterloo, Ontario, Canada, 2017

©Armughan Al-Haq 2017

AUTHOR'S DECLARATION

I hereby declare that I am the sole author of this thesis. This is a true copy of the thesis, including any required final revisions as accepted by my examiners.

I understand that my thesis may be made electronically available to the public.

ABSTRACT

Ground Source Heat Pump Systems (GSHPs) are one of the most promising clean and low-carbon source of geothermal renewable energy technologies for heating, ventilation and cooling of homes. Geothermal heat pump (GHP) technologies, referred to as GeoExchange, comprise ground-source and/or water-source heat pumps that use the constant temperature of the earth as the exchange medium instead of the outside air temperature.

This study is a technical and economic assessment of use of GSHPs to support the policy options for increasing the share of geothermal energy sources within the residential sector of Ontario. The study identifies the technical and economic barriers to the wide-spread adoption of ground source heat pumps in Ontario and is an assessment of the impacts of large-scale deployment of GSHPs on greenhouse gas (GHG) emissions.

In this study, I have established the basis for evaluating the cost and environmental benefits of GSHPs in Ontario. The results provide a sound economic and technical foundation for supporting investment decisions in favour of implementing GSHPs as a viable alternative to traditional heating, ventilation, air-conditioning systems (HVACs), specifically, natural gas use for space heating and hot water usage in buildings.

The study reveals that geothermal ground source heat pumps have a great potential to reduce GHG emissions for Ontario's residential sector by a magnitude of 21.7 megatonnes (Mt) that will in turn reduce the overall emissions of Ontario by 13%.

GSHPs are a cost-effective solution for implementation on a wide-scale. The economic analysis clearly indicates the horizontal ground source heat pump system (H.GSHPs) is a strong winner in multiple sensitivity analysis when considering different lifespans, discount factors, and base case scenario against comparative scenarios. The rankings of the twenty-seven (27) cities selected for this study identify that the GSHPs are more attractive compared to traditional HVACs from an investment point of view in cities of the southern and distinct region as compared to the northern regions because of low present value (PV) of costs. The PV compares the cash outflows based on the initial investment, operating costs, maintenance costs, and disposal costs in a project lifespan of 60 years that span life cycles of 20 – 30 years for GSHPs and 12 years for traditional HVAC applications.

This study has conducted a comprehensive technical and economic assessment for twenty-seven (27) cities in Ontario to address the geographic variation of benefits. While there is a variation across regions of Ontario – and this is based on weather, soil condition and level of energy use – the overall conclusion is a compelling case for GSHPs as a viable alternative to the use of natural gas.

ACKNOWLEDGEMENT

I would like to acknowledge the Department of Civil and Environmental Engineering for the support of this research project. I would like to express my gratitude to my advisors, Prof. Jatin Nathwani and Prof. Dipanjan Basu for their guidance and mentorship throughout my master's thesis. I would like to sincerely thank Prof. Maurice Dusseault, Prof. Ranjini Jha, and Prof. Paul Parker who contributed to this research project as technical readers.

I am also grateful to the entire team of GeoSmart Energy Inc. for their feedback and direction in improving the technical and economic model of the thesis work.

Table of Contents

List of Tables	ix
List of Figures	xv
List of Abbreviations	xviii
Chapter 1 – Environmental Perspectives and Energy Systems	1
1.1 Introduction	1
1.1.1 Role of Geothermal Energy Systems	1
1.2 Context: Climate Change Challenge and Ontario Action Plan	2
1.2.1 Background – Climate Science and Canada’s Energy Use	2
1.2.2 Greenhouse Gas Emissions and the Energy Sector	3
1.2.3 The Ontario Action Plan.....	11
1.2.3.1 Energy Systems in the Residential Sector of Ontario	14
1.2.3.2 Residential Households in Ontario	23
1.3 Research Problem.....	23
1.4 Research Questions	24
1.5 Thesis Organization.....	24
Chapter 2 – Fundamentals and Literature Review	25
2.1 Overview of Ground Source Heat Pump Systems (GSHPs).....	25
2.1.1 Working Principle	26
2.1.2 Components	27
2.1.3 Performance – Efficiency Measures.....	27
2.1.4 Principles of Thermodynamics	28
2.1.4.1 Heating Cycles	30
2.1.4.2 Cooling Cycles.....	31
2.1.4.3 Domestic Hot Water	31
2.1.5 Distribution System	31
2.1.6 Types of Loops	34
2.1.7 Technical Configuration/Specifications and Economic Evaluation.....	36

2.1.7.1	Ground and Weather Characteristics	36
2.1.7.2	Calculations of Heating and Cooling Loads	47
2.1.7.3	Economic Evaluation	48
2.1.8	Meta-Analysis of System Performance and Economics of GSHPs	50
2.1.8.1	General Technical and Economic Analysis	50
2.1.8.2	Studies on Hybrid Systems	53
2.1.8.3	Effect of Soil Type on Performance of GSHPs	53
2.2	Overview of Conventional Heating, Ventilation, and Air Conditioning (HVAC) Systems	54
2.2.1	Natural Gas Furnace	54
2.2.2	Air Conditioner (A/C)	56
2.2.2.1	Room Air Conditioners	56
2.2.2.1.1	Energy Efficiency Consideration	58
2.2.2.1.2	Sizing Consideration	59
2.2.2.1.3	Life Expectancy and Warranties	59
2.2.2.2	Central Air Conditioners	59
2.2.2.2.1	Energy Efficiency Consideration	61
2.2.2.2.2	Sizing Consideration	62
2.2.2.2.3	Life Expectancy and Warranties	62
2.2.3	Natural Gas Water Heater	63
2.2.3.1	Conventional Gas Fired Water Heater	63
2.2.3.2	Power Vented Gas Fired Water Heater	64
2.2.3.3	Measuring Energy Performance	64
2.2.3.4	Typical Household Hot Water Use in Canada	65
2.3	Snapshot Analysis of HVAC Systems	65
Chapter 3 – Methodology and Results		67
3.1	Synopsis	67
3.1.1	Technical Assessment	67
3.1.1.1	Natural Resources Canada (NRCan)	67
3.1.1.2	National Energy Board (NEB)	68

3.1.1.3 Market Share.....	68
3.1.1.4 Selection of Cities.....	68
3.1.1.5 HVAC Designing (<i>HVAC-Calc Residential 4.0</i>)	71
3.1.1.6 Geothermal Engineering (<i>GeoSmart Design Studio</i>)	80
3.1.2 Economic Assessment.....	118
3.1.2.1 Results and Analysis.....	122
3.1.2.1.1 Economic Variation	122
3.1.2.1.2 Rankings of the Cities – Average Construction Type	125
3.1.2.1.3 Rankings of the Cities – Improved Construction Type	125
3.1.3 Environmental Assessment	175
3.1.3.1 Carbon Footprint of Traditional HVAC Applications in Ontario Cities – Average Construction Type	175
3.1.3.2 Carbon Footprint of Traditional HVAC Applications in Ontario Cities – Improved construction Type	175
3.1.3.3 Percentage (%) Difference.....	175
3.1.3.4 Environmental Role of GSHPs in Ontario.....	179
Chapter 4 – Summary and Recommendations	180
4.1 Summary	180
4.1.1 Technical Barriers.....	180
4.1.2 Economic Barriers	181
4.1.3 Environmental Impact.....	182
4.1.4 Strategic Planning	182
4.2 Conclusion.....	183
4.3 Contribution	183
4.4 Implications for Future Work and Recommendations	183
References	185

Appendices

Appendix A1 – Type of Residential Households and % Share in Ontario	198
Appendix A2 – Total Energy Use by End-Use in the Residential Households of Ontario	200
Appendix A3 – Total Energy Use by Energy Source in the Residential Households of Ontario	203
Appendix A4 – Total Energy Use by System Type in the Residential Households of Ontario	206
Appendix A5 – Total Energy System Stock in the Residential Households of Ontario	208
Appendix B1 – Annual Hourly Analysis of Heating and Cooling Loads and HVAC Units Capacity to Cover these Loads – Average Construction Type	222
Appendix B2 – Annual Hourly Analysis of Heating and Cooling Loads and HVAC Units Capacity to Cover these Loads – Improved Construction Type	303
Appendix C – Electricity and Natural Gas Rates Forecasting	384
Appendix D1 – Annual Operating Costs of HVAC Systems in Ontario Cities – Average Construction Type.....	385
Appendix D2 – Annual Operating Costs of HVAC Systems in Ontario Cities – Improved Construction Type.....	466
Appendix E1 – Economic Variation of HVAC Technologies for Different Scenarios Based on Present Value at Various Discount Factors – Average Construction Type	547
Appendix E2 – Economic Variation of HVAC Technologies for Different Scenarios Based on Present Value at Various Discount Factors – Improved Construction Type	619
Appendix F1 – Rankings of Cities for Different Scenarios Based on Present Value at Various Discount Factors – Average Construction Type.....	691
Appendix F2 – Rankings of Cities for Different Scenarios Based on Present Value at Various Discount Factors – Improved Construction Type.....	763

List of Tables

Table 1 – Soil and Rock Classification	37
Table 2 – Ground Loop Arrangements Variations – Ground Source Heat Pump Systems	43
Table 3 – Heating and Cooling Loads Values – Rule of Thumb	47
Table 4a – HVAC Design Parameters	72
Table 4b – Designing of the First Floor	74
Table 4c – Designing of the Second Floor	76
Table 4d – Designing of the Basement	78
Table 4e – Loads (Losses)	79
Table 4f – Loads (Losses) Per Square Feet	80
Table 4g – Cooling Sensible Loads	82
Table 4h – Delta T (dt)	83
Table 4i – Building Properties	85
Table 4j – Capacity (in tons) – Average Construction Scenario	89
Table 4k – Capacity (in tons) – Improved Construction Scenario	90
Table 4l – Capacity (in tons) – Difference (% Change)	91
Table 4m – Borehole Configuration – Vertical Ground Source Heat Pump (V.GSHP)	91
Table 4n – Trenching Configuration – Horizontal Ground Source Heat Pump (H.GSHP)	92
Table 5a – Space Heating Usage – Average Construction Scenario	97
Table 5b – Space Heating Usage – Improved Construction Scenario	98
Table 5c – Space Heating Usage – Difference (% Change)	99
Table 5d – Space Cooling Usage – Average Construction Scenario	100
Table 5e – Space Cooling Usage – Improved Construction Scenario	101
Table 5f – Space Cooling Usage – Difference (% Change)	102
Table 5g – Hot Water Usage – Average Construction Scenario	103
Table 5h – Hot Water Usage – Improved Construction Scenario	104
Table 5i – Hot Water Usage – Difference (% Change)	105
Table 6a – Average Efficiency Output of Space Heating Units – Average Construction Scenario	106
Table 6b – Average Efficiency Output of Space Heating Units – Improved Construction Scenario	107

Table 6c – Average Efficiency Output of Space Heating Units – Difference (% Change)	108
Table 6d – Average Efficiency Output of Space Cooling Units – Average Construction Scenario	109
Table 6e – Average Efficiency Output of Space Cooling Units – Improved Construction Scenario	110
Table 6f – Average Efficiency Output of Space Cooling Units – Difference (% Change)	111
Table 6g – Average Efficiency Output of Hot Water Units – Average Construction Scenario	112
Table 6h – Average Efficiency Output of Hot Water Units – Improved Construction Scenario	113
Table 6i – Average Efficiency Output of Hot Water Units – Difference (% Change)	114
Table 7a – Total Operating Costs on Annual Basis (Space Heating + Space Cooling + Hot Water)	116
Table 7b – Difference (% Change) in Total Operating Costs (Space Heating + Space Cooling + Hot Water)	117
Table 8 – Economic Variation of HVAC Technologies for Different Scenarios at Various Discount Rates	124
Table 9a – Rankings of the Cities Based on present values for V.GSHP, H.GSHP (two life cycles) and Traditional HVAC Applications (five life cycles) at a discount rate of 5% for average construction scenario	127
Table 9b – % change in present values for comparative scenarios in regards to the main scenario for V.GSHP, H.GSHP (two life cycles) and Traditional HVAC Applications (five life cycles) at a discount rate of 5% for average construction scenario	128
Table 9c – Rankings of the Cities Based on present values for V.GSHP, H.GSHP (two life cycles) and Traditional HVAC Applications (five life cycles) at a discount rate of 7% for average construction scenario	129
Table 9d – % change in present values for comparative scenarios in regards to the main scenario for V.GSHP, H.GSHP (two life cycles) and Traditional HVAC Applications (five life cycles) at a discount rate of 7% for average construction scenario	130
Table 9e – Rankings of the Cities Based on present values for V.GSHP, H.GSHP (two life cycles) and Traditional HVAC Applications (five life cycles) at a discount rate of 7.5% for average construction scenario	131
Table 9f – % change in present values for comparative scenarios in regards to the main scenario for V.GSHP, H.GSHP (two life cycles) and Traditional HVAC Applications (five life cycles) at a discount rate of 7.5% for average construction scenario	132

Table 9g – Rankings of the Cities Based on present values for V.GSHP, H.GSHP (two life cycles) and Traditional HVAC Applications (five life cycles) at a discount rate of 8.5% for average construction scenario	133
Table 9h – % change in present values for comparative scenarios in regards to the main scenario for V.GSHP, H.GSHP (two life cycles) and Traditional HVAC Applications (five life cycles) at a discount rate of 8.5% for average construction scenario	134
Table 9i – Rankings of the Cities Based on present values for V.GSHP, H.GSHP (two life cycles) and Traditional HVAC Applications (five life cycles) at a discount rate of 10% for average construction scenario	135
Table 9j – % change in present values for comparative scenarios in regards to the main scenario for V.GSHP, H.GSHP (two life cycles) and Traditional HVAC Applications (five life cycles) at a discount rate of 10% for average construction scenario	136
Table 9k – Rankings of the Cities Based on present values for V.GSHP, H.GSHP (two life cycles) and Traditional HVAC Applications (five life cycles) at a discount rate of 12% for average construction scenario	137
Table 9l – % change in present values for comparative scenarios in regards to the main scenario for V.GSHP, H.GSHP (two life cycles) and Traditional HVAC Applications (five life cycles) at a discount rate of 12% for average construction scenario	138
Table 10a – Rankings of the Cities Based on present values for V.GSHP, H.GSHP (three life cycles) and Traditional HVAC Applications (five life cycles) at a discount rate of 5% for average construction scenario	139
Table 10b – % change in present values for comparative scenarios in regards to the main scenario for V.GSHP, H.GSHP (three life cycles) and Traditional HVAC Applications (five life cycles) at a discount rate of 5% for average construction scenario	140
Table 10c – Rankings of the Cities Based on present values for V.GSHP, H.GSHP (three life cycles) and Traditional HVAC Applications (five life cycles) at a discount rate of 7% for average construction scenario	141
Table 10d – % change in present values for comparative scenarios in regards to the main scenario for V.GSHP, H.GSHP (three life cycles) and Traditional HVAC Applications (five life cycles) at a discount rate of 7% for average construction scenario	142
Table 10e – Rankings of the Cities Based on present values for V.GSHP, H.GSHP (three life cycles) and Traditional HVAC Applications (five life cycles) at a discount rate of 7.5% for average construction scenario	143
Table 10f – % change in present values for comparative scenarios in regards to the main scenario for V.GSHP, H.GSHP (three life cycles) and Traditional HVAC Applications (five life cycles) at a discount rate of 7.5% for average construction scenario	144

Table 10g – Rankings of the Cities Based on present values for V.GSHP, H.GSHP (three life cycles) and Traditional HVAC Applications (five life cycles) at a discount rate of 8.5% for average construction scenario	145
Table 10h – % change in present values for comparative scenarios in regards to the main scenario for V.GSHP, H.GSHP (three life cycles) and Traditional HVAC Applications (five life cycles) at a discount rate of 8.5% for average construction scenario	146
Table 10i – Rankings of the Cities Based on present values for V.GSHP, H.GSHP (three life cycles) and Traditional HVAC Applications (five life cycles) at a discount rate of 10% for average construction scenario	147
Table 10j – % change in present values for comparative scenarios in regards to the main scenario for V.GSHP, H.GSHP (three life cycles) and Traditional HVAC Applications (five life cycles) at a discount rate of 10% for average construction scenario	148
Table 10k – Rankings of the Cities Based on present values for V.GSHP, H.GSHP (three life cycles) and Traditional HVAC Applications (five life cycles) at a discount rate of 12% for average construction scenario	149
Table 10l – % change in present values for comparative scenarios in regards to the main scenario for V.GSHP, H.GSHP (three life cycles) and Traditional HVAC Applications (five life cycles) at a discount rate of 12% for average construction scenario	150
Table 11a – Rankings of the Cities Based on present values for V.GSHP, H.GSHP (two life cycles) and Traditional HVAC Applications (five life cycles) at a discount rate of 5% for improved construction scenario	151
Table 11b – % change in present values for comparative scenarios in regards to the main scenario for V.GSHP, H.GSHP (two life cycles) and Traditional HVAC Applications (five life cycles) at a discount rate of 5% for improved construction scenario	152
Table 11c – Rankings of the Cities Based on present values for V.GSHP, H.GSHP (two life cycles) and Traditional HVAC Applications (five life cycles) at a discount rate of 7% for improved construction scenario	153
Table 11d – % change in present values for comparative scenarios in regards to the main scenario for V.GSHP, H.GSHP (two life cycles) and Traditional HVAC Applications (five life cycles) at a discount rate of 7% for improved construction scenario	154
Table 11e – Rankings of the Cities Based on present values for V.GSHP, H.GSHP (two life cycles) and Traditional HVAC Applications (five life cycles) at a discount rate of 7.5% for improved construction scenario	155
Table 11f – % change in present values for comparative scenarios in regards to the main scenario for V.GSHP, H.GSHP (two life cycles) and Traditional HVAC Applications (five life cycles) at a discount rate of 7.5% for improved construction scenario	156

Table 11g – Rankings of the Cities Based on present values for V.GSHP, H.GSHP (two life cycles) and Traditional HVAC Applications (five life cycles) at a discount rate of 8.5% for improved construction scenario	157
Table 11h – % change in present values for comparative scenarios in regards to the main scenario for V.GSHP, H.GSHP (two life cycles) and Traditional HVAC Applications (five life cycles) at a discount rate of 8.5% for improved construction scenario	158
Table 11i – Rankings of the Cities Based on present values for V.GSHP, H.GSHP (two life cycles) and Traditional HVAC Applications (five life cycles) at a discount rate of 10% for improved construction scenario	159
Table 11j – % change in present values for comparative scenarios in regards to the main scenario for V.GSHP, H.GSHP (two life cycles) and Traditional HVAC Applications (five life cycles) at a discount rate of 10% for improved construction scenario	160
Table 11k – Rankings of the Cities Based on present values for V.GSHP, H.GSHP (two life cycles) and Traditional HVAC Applications (five life cycles) at a discount rate of 12% for improved construction scenario	161
Table 11l – % change in present values for comparative scenarios in regards to the main scenario for V.GSHP, H.GSHP (two life cycles) and Traditional HVAC Applications (five life cycles) at a discount rate of 12% for improved construction scenario	162
Table 12a – Rankings of the Cities Based on present values for V.GSHP, H.GSHP (three life cycles) and Traditional HVAC Applications (five life cycles) at a discount rate of 5% for improved construction scenario	163
Table 12b – % change in present values for comparative scenarios in regards to the main scenario for V.GSHP, H.GSHP (three life cycles) and Traditional HVAC Applications (five life cycles) at a discount rate of 5% for improved construction scenario	164
Table 12c – Rankings of the Cities Based on present values for V.GSHP, H.GSHP (three life cycles) and Traditional HVAC Applications (five life cycles) at a discount rate of 7% for improved construction scenario	165
Table 12d – % change in present values for comparative scenarios in regards to the main scenario for V.GSHP, H.GSHP (three life cycles) and Traditional HVAC Applications (five life cycles) at a discount rate of 7% for improved construction scenario	166
Table 12e – Rankings of the Cities Based on present values for V.GSHP, H.GSHP (three life cycles) and Traditional HVAC Applications (five life cycles) at a discount rate of 7.5% for improved construction scenario	167
Table 12f – % change in present values for comparative scenarios in regards to the main scenario for V.GSHP, H.GSHP (three life cycles) and Traditional HVAC Applications (five life cycles) at a discount rate of 7.5% for improved construction scenario	168

Table 12g – Rankings of the Cities Based on present values for V.GSHP, H.GSHP (three life cycles) and Traditional HVAC Applications (five life cycles) at a discount rate of 8.5% for improved construction scenario	169
Table 12h – % change in present values for comparative scenarios in regards to the main scenario for V.GSHP, H.GSHP (three life cycles) and Traditional HVAC Applications (five life cycles) at a discount rate of 8.5% for improved construction scenario	170
Table 12i – Rankings of the Cities Based on present values for V.GSHP, H.GSHP (three life cycles) and Traditional HVAC Applications (five life cycles) at a discount rate of 10% for improved construction scenario	171
Table 12j – % change in present values for comparative scenarios in regards to the main scenario for V.GSHP, H.GSHP (three life cycles) and Traditional HVAC Applications (five life cycles) at a discount rate of 10% for improved construction scenario	172
Table 12k – Rankings of the Cities Based on present values for V.GSHP, H.GSHP (three life cycles) and Traditional HVAC Applications (five life cycles) at a discount rate of 12% for improved construction scenario	173
Table 12l – % change in present values for comparative scenarios in regards to the main scenario for V.GSHP, H.GSHP (three life cycles) and Traditional HVAC Applications (five life cycles) at a discount rate of 12% for improved construction scenario	174
Table 13 – Natural gas usage (in cubic meters) from traditional HVAC applications (natural gas furnace and natural gas water heater) and CO ₂ emissions (in tons) produced from the Natural Gas Usage for a 2,000 square feet detached house above grade (average construction type) in the twenty-seven (27) cities (ascending order) of Ontario	176
Table 14 – Natural gas usage (in cubic meters) from traditional HVAC applications (natural gas furnace and natural gas water heater) and CO ₂ emissions (in tons) produced from the Natural Gas Usage for a 2,000 square feet detached house above grade (improved construction type) in the twenty-seven (27) cities (ascending order) of Ontario	177
Table 15 – % Change (switching from average to improved construction type) in CO ₂ emissions (in tons) produced from the Natural Gas Usage for a 2,000 square feet detached house above grade in the twenty-seven (27) cities of Ontario	178

List of Figures

Figure 1 – Annual mean temperature anomalies for Canada (°C).....	2
Figure 2 – Greenhouse Gas Emissions (Megatonnes of CO ₂ eq. in Canada from 1990 – 2014.....	3
Figure 3 – Greenhouse Gas Emissions by Economic Sector, Canada, 1990 to 2014.....	5
Figure 4 – Projections of Greenhouse Gas (GHG) Emissions for Canada, 2015 – 2030, and Assigned Target of GHG by 2030	5
Figure 5 – Total Energy Use (Petajoules) in the Residential Sector of Ontario	6
Figure 6 – Total Floor Space (million square meters) in the Residential Sector of Ontario	7
Figure 7 – Energy Intensity (Gigajoules/Household and Gigajoules/Square Meter) in the Residential Sector of Ontario.....	7
Figure 8 – Energy use by energy source (petajoules) and % share in the residential sector of Canada in 1990	8
Figure 9 – Energy use by energy source (petajoules) and % share in the residential sector of Canada in 2014	8
Figure 10 – Greenhouse gas (GHG) emissions (megatonnes of Carbon Dioxide equivalent (CO ₂ e) and % share in the residential sector of Canada in 1990	9
Figure 11 – Greenhouse gas (GHG) emissions (megatonnes of Carbon Dioxide equivalent (CO ₂ e) and % share in the residential sector of Canada in 2014	9
Figure 12 – Canadian population breakdown by provinces and territories, and % share in 2016	11
Figure 13 – Energy use by energy source (petajoules) and % share in the residential buildings of Ontario in 1990	12
Figure 14 – Energy use by energy source (petajoules) and % share in the residential buildings of Ontario in 2014	13
Figure 15 – Greenhouse gas (GHG) emissions (megatonnes of Carbon Dioxide equivalent (CO ₂ e) from Natural Gas in the residential buildings of Ontario (Year 1990 – 2014).....	13
Figure 16 – Energy use by end-use (petajoules) and % share in the residential buildings of Ontario in 1990	15
Figure 17 – Energy use by end-use (petajoules) and % share in the residential buildings of Ontario in 2014	15
Figure 18 – Greenhouse gas (GHG) emissions (megatonnes of Carbon Dioxide equivalent (CO ₂ e)) and % share in the residential buildings of Ontario from energy use by end-use in 1990	16
Figure 19 – Greenhouse gas (GHG) emissions (megatonnes of Carbon Dioxide equivalent (CO ₂ e) and % share in the residential buildings of Ontario from energy use by end-use in 2014	16

Figure 20 – Space Heating Energy use by system type (petajoules) and % share in the residential buildings of Ontario in 1990	17
Figure 21 – Space Heating Energy use by system type (petajoules) and % share in the residential buildings of Ontario in 2014	17
Figure 22 – Greenhouse gas (GHG) emissions (megatonnes of Carbon Dioxide equivalent (CO ₂ e) and % share in the residential buildings of Ontario from space heating energy use by system type in 1990	18
Figure 23 – Greenhouse gas (GHG) emissions (megatonnes of Carbon Dioxide equivalent (CO ₂ e) and % share in the residential buildings of Ontario from space heating energy use by system type in 2014	18
Figure 24 – Space Cooling Energy use by system type (petajoules) and % share in the residential buildings of Ontario in 1990	19
Figure 25 – Space Cooling Energy use by system type (petajoules) and % share in the residential buildings of Ontario in 2014	20
Figure 26 – Energy Use (petajoules) by Cooling System Type (Room and Central), 1990 – 2075	20
Figure 27 – Water Heating Energy use by energy source (petajoules) and % share in the residential buildings of Ontario in 1990	21
Figure 28 – Water Heating Energy use by energy source (petajoules) and % share in the residential buildings of Ontario in 2014	21
Figure 29 – Greenhouse gas (GHG) emissions (megatonnes of Carbon Dioxide equivalent (CO ₂ e)) and % share in the residential buildings of Ontario from water heating energy use by energy source in 1990	22
Figure 30 – Greenhouse gas (GHG) emissions (megatonnes of Carbon Dioxide equivalent (CO ₂ e)) and % share in the residential buildings of Ontario from water heating energy use by energy source in 2014	22
Figure 31 – Heat Pump Scheme	26
Figure 32 – Basic Premise of a Heat Pump: Reproduced from Figure 27	29
Figure 33 – Vapour Compression Cycle	30
Figure 34 – Ventilation Ducts made up of Galvanized Sheets	32
Figure 35 – Ceiling Air Ventilation	32
Figure 36 – Layout of a Radiant HVAC System	33
Figure 37 – Open system using groundwater from a well as a heat source	34
Figure 38 – Layout of a vertical ground loop piping – Limited space	35
Figure 39 – Horizontal ground loop for a residential facility	35
Figure 40 – Pond/Lake closed loop system	35

Figure 41 – Deep Earth Temperature of the Selected Cities in Ontario	40
Figure 42 – Annual Swing Temperature of the Selected Cities in Ontario	40
Figure 43 – 1% Cooling Design Temperature of the Selected Cities in Ontario	41
Figure 44 – 97% Heating Design Temperature of the Selected Cities in Ontario	41
Figure 45 – Ground Lag Time of the Selected Cities in Ontario	42
Figure 46 – Degree – Days of the Selected Cities in Ontario	42
Figure 47 – Natural Gas Furnace with Duct Work	54
Figure 48 – Components of a room air conditioner	57
Figure 49 – Basic Cooling Cycle	58
Figure 50 – Efficiency of a room air conditioner	59
Figure 51 – Installed Central Air Conditioner	60
Figure 52 – Operations of a Central Air Conditioner	61
Figure 53 – Efficiency of a Central Air Conditioner	62
Figure 54 – Conventional Gas Fired Water Heater	63
Figure 55 – Power Vented Gas Fired Water Heater	64
Figure 56 – Main Uses for Household Hot Water in Canada	65
Figure 57 – Technical Assessment – Data Acquisition and Data Generation Schematic	67
Figure 58 – Selected Cities in Northern Ontario	69
Figure 59 – Selected Cities in Southern Ontario, and Central/Eastern Ontario (Distinct Region)	69
Figure 60 – Selected Cities in Northern, Southern, and Distinct Region	70
Figure 61 – Configuration for Two Boreholes	92
Figure 62 – Configuration for Two Trenches	93
Figure 63 – Ontario Electricity Rates (in \$ per kilowatt-hour); projections based on National Energy Board (NEB) Data (High Price Case - Residential - 2010 C\$ per KWh)	95
Figure 64 – Ontario Natural Gas Rates (in \$ per cubic meter); projections based on National Energy Board (NEB) Data (High Price Case - Residential - 2010 C\$ per KWh)	95
Figure 65 – A comprehensive snapshot of the economic assessment	122

List of Abbreviations

%	Percentage
$\sum \dot{W}_{input}$	Total Work Input Rate to the System
$\varepsilon_{GHSP, unit}$	Exergy Efficiency of the Ground Source Heat Pump Unit
°C	Degree Celsius
°F	Degree Fahrenheit
\$	Dollar
A/C	Air Conditioner
ACH	Air Changes per Hour
AFUE	Annual Fuel Utilization Efficiency
AHRI	Air Conditioning, Heating and Refrigeration Institute
ASHP	Air Source Heat Pump
ASHRAE	American Society of Heating, Refrigerating and Air-Conditioning Engineers
B.C	Base Case
Btu	British Thermal Unit
Btu-h	British Thermal Unit per Hour
Btu/hr-ft.-°F	British Thermal Unit per Hour-Feet-Degree Fahrenheit
CAGR	Compound Annual Growth Rate
CFM	Cubic Feet per Minute
CGC	Canadian Geexchange Coalition
cm	Centimetre
CMHC	Canadian Mortgage and Housing Corporation
CO ₂	Carbon Dioxide
CO ₂ e	Carbon Dioxide Equivalent
COP	Coefficient of Performance
COP_{Carnot}	Maximum Heating Coefficient of Performance Obtained from the Carnot Cycle for an Ideal Heat Pump System
$COP_{GHSP, sys}$	Energy Efficiency of a Ground Source Heat Pump
CSA	Canadian Standards and Association
C.T	Carbon Taxes
D – D	Degree Days
dt	Delta T
ECM	Electronically Commutated Permanent Magnet
EER	Energy Efficiency Ratio
EF	Energy Factor
EFT	Entering Fluid Temperature

ESP	External Static Pressure
FHR	First Hour Rating
FIT	Feed-In Tariff
ft.	Feet
ft ² /day	Square Feet per Day
GE	General Electric
GHG	Greenhouse Gases
GHP	Geothermal Heat Pump
GLHX	Ground Loop Heat Exchanger
gpp	Grains per Pound
GSHP	Ground Source Heat Pump
GSHPs	Ground Source Heat Pump System
H	Height
HCFC	Hydro-Chlorofluorocarbon
HDPE	High Density Polyethylene
HFC	Hydro-Fluorocarbon
H.GSHP	Horizontal Ground Source Heat Pump
HGSHP	Hybrid Ground Source Heat Pump
HVAC	Heating, Ventilation, and Air Conditioning
HPWHs	Heat Pump Water Heating Systems
IN	Indiana
IPCC	Intergovernmental panel on climate change
KW	Kilowatt
KWh	Kilowatt-Hour
L	Litre
L	Length
LCC	Life Cycle Costing
m ² /s	Square meter per second
m ³	Cubic Meter
MEPS	Minimum Energy Performance Standards
mm	Millimetre
Mt	Megatonnes
NEB	National Energy Board
NFPA	National Fire Protection Association
No.	Number
NRCan	Natural Resources Canada
NREL	National Renewable Energy Laboratory
ODP	Ozone Depletion Potential
Pa	Pascal

PE	Polyethylene
PJ	Petajoules
PV	Present Value
PSC	Permanent Split Capacitor
Q	Condenser
\dot{Q}_{sh}	Space Heating Load Rate
Q_{source}	Low Temperature Heat Source
Q_{sink}	High Temperature Heat Sink
REB	Rebates
RESNET	Residential Energy Services Network
RH	Relative Humidity
SEER	Seasonal Energy Efficiency Rating
Sq.ft	Square Feet
T_c	Cooler Body
TC	Thermal Conductivity
T_h	Hotter Body
T_H	High Temperature Reservoirs
T_L	Low Temperature Reservoirs
$T_c \rightarrow T_h$	Net Heat Transfer
UNFCCC	United Nations Framework Convention on Climate Change
U.S DOE	United States Department of Energy
V.GSHP	Vertical Ground Source Heat Pump
W	Mechanical Work/Compressor
$\dot{W}_{compressor}$	Work Input Rate to the Compressor of the Ground Source Heat Pump Unit
WFEA	Water Furnace Energy Analysis
W/m-K	Watts per meter-Kelvin

Chapter 1 – Environmental Perspectives and Energy Systems

1.1 Introduction

The importance of climate change is now well recognized as an environmental challenge and Canada has committed to a comprehensive climate change plan through the United Nations Framework Convention on Climate Change (UNFCCC) agreement (Environment and Climate Change Canada, 2017a). This plan is underpinned by a strong scientific foundation and includes action on, and investments in mitigation and adaptation, and with a specific focus on clean and renewable energy technologies to reduce GHG emissions in the residential sector (Government of Canada, 2014). The pan-Canadian framework on clean growth and climate change is the plan – developed with the provinces and territories and in consultation with Indigenous peoples – to meet the emissions reduction target and grow the economy. The plan includes a pan-Canadian approach to pricing carbon pollution, and measures to achieve reductions across all sectors of the economy (Government of Canada, 2017).

The Government of Canada is focused on a pragmatic approach to addressing climate change that will reduce emissions while continuing to create jobs and encourage the growth of the economy. The Government is implementing a sector-by-sector approach to regulate greenhouse gas (GHG) emissions through design of policies to combat climate change (Environment Canada, 2014). These policies, in support of technological innovation can be categorized as market-based instruments and non-market instruments. Two broad categories of market-based instruments are environmentally-related taxes and systems of tradable pollution emission permits. Similarly, non-market instruments can be classified as command-and-control regulation, active technology-support policies and voluntary approaches (Nikzad & Sedigh, 2017).

1.1.1 Role of Geothermal Energy Systems

One of the most promising clean and a low-carbon source of renewable energy technologies for Canadian households is ground source heat pump systems (GSHPs). Geothermal heat pumps (GHPs) use the constant temperature of the earth as the exchange medium instead of the outside air temperature with significant potential for reducing the heating and cooling costs. Energy-cost savings compared to conventional heating and ventilation applications are in the order of 65 percent. On average, a GSHPs will yield savings that are about 40 percent more than would be provided by an air-source heat pump. This is due to the fact that underground temperatures are higher in winter than air temperatures. As a result, a GSHP can provide more heat over the course of the winter than an air-source heat pump (NRCan, 2017b). Actual energy savings will vary depending on the local climate, the efficiency of the existing heating system, the costs of fuel and

electricity, the size of the heat pump installed, and its coefficient of performance (COP) at Canadian Standards and Association (CSA) rating conditions (NRCan, 2017b).

The goal in this thesis is to evaluate the potential for wide-spread application of geothermal heating systems as one mitigation strategy for a lower carbon energy future.

1.2 Context: Climate Change Challenge and Ontario Action Plan

1.2.1 Background – Climate Science and Canada’s Energy Use

Globally, the impacts of climate change are becoming evident. This includes coastal erosion; thawing permafrost; increases in heat waves, droughts and flooding; and risks to critical infrastructure and food security are already being felt in Canada. The science is clear that human activities (use of fossil fuels) are driving unprecedented changes in the Canada’s climate, which pose significant risks to human health, security, and economic growth (Government of Canada, 2017). The intergovernmental panel on climate change (IPCC) continues to identify rising air and ocean temperatures, shifting precipitation patterns, shrinking glaciers, declining snow cover and sea ice extent, rising sea level and changes in extreme events (IPCC, 2013).

Over the last six decades, Canada has become warmer, with average surface air temperatures over the landmass increasing by 1.5°C between 1950 and 2010 as shown in Figure 1 (Vincent et al., 2012). This rate of warming is about double the global average reported over the same time period (Hartmann et al., 2013). Warming has been occurring even faster in many areas of northern Canada, and has been observed through all seasons, with the greatest warming trends in winter and spring. The annual number of extreme warm days has also risen, while the number of cold nights has declined (Warren & Lemmen, 2014). Recent analysis shows that 2011 and 2012 were 1.5°C and 1.9°C warmer than the reference period (1961-1990 average). The year 2010 still stands as the warmest year on record in Canada, at 3.0°C above normal (Environment Canada, 2012). Canada’s climate varies considerably from from one region to another, and is characterized by significant variability – seasonally, from year to year, and over periods of multiple

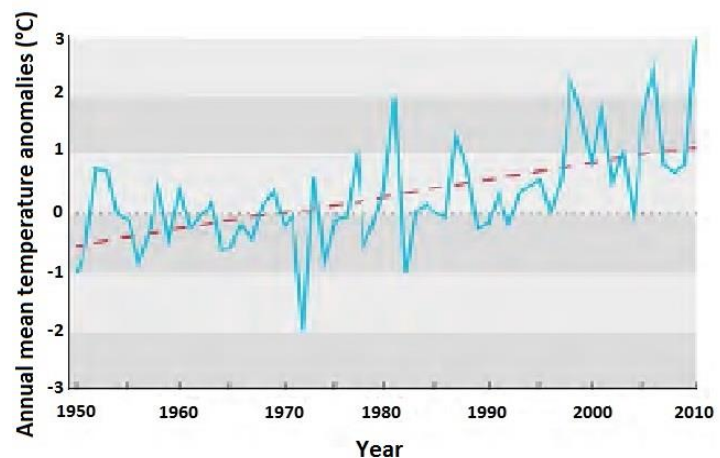

Figure 1: Annual mean temperature anomalies for Canada (°C)

1950-2010. Anomalies are calculated as departures from the 1961-1990 average (represented by zero on the Y-axis). A warming trend of 1.5°C over the period 1950- 2010 is indicated by the red line

Source: Vincent et al., 2012; and Environment Canada, 2011

years (Warren & Lemmen, 2014). Accelerated climate change has implications for northern communities facing increasing risks related to reduced duration and thickness of sea and lake ice, thawing permafrost, sea level rise and storm surges, erosion and landslides, more unpredictable weather, freezing rain and wildfires, shorter winter conditions, and hotter summers (Ford, 2009; Boulton et al., 2011). Northern residents report that environmental changes are impacting their livelihoods, their relationship with the land, their culture, and their well-being (Ford et al., 2010b; Lemelin et al., 2010; Morse and Zakrison, 2010; Downing and Cuerrier, 2011; Andrachuk and Smit, 2012; McClymont and Myers, 2012).

Climate change has emerged as one of the most crucial environmental challenges of the 21st century. Taking strong action to address climate change has become an urgent priority for governments. The cost of inaction has been estimated in the order of \$21-\$43 billion per year by 2050, according to 2011 estimates from the National Round Table on the Environment and the Economy (Government of Canada, 2017). Businesses and markets are increasingly considering climate risks. In recent years, severe weather events have cost Canadians billions of dollars, including in insured losses. Indigenous Peoples, northern and coastal regions and communities in Canada are particularly vulnerable and disproportionately affected (Government of Canada, 2017).

1.2.2 Greenhouse Gas Emissions and the Energy Sector

The primary source of carbon dioxide is from the combustion of fossil fuels for the purposes of energy production. This accounted for 89% of total CO₂ emissions in 2011. Carbon dioxide may also be released during the extraction of fossil fuels, and the conversion of fossil fuels to other products (Environment Canada, 2013). Canada's total greenhouse gas (GHG) emissions in 2014 were 732 megatonnes (Mt) of carbon dioxide equivalent (CO₂ eq), or 20% (120 Mt CO₂ eq) above the 1990 emissions of 613 Mt CO₂ eq (Figure 2). Canada's emissions growth between 1990 and 2014 was driven primarily by increased emissions from mining and upstream oil and gas production as well as transport (Environment and Climate Change Canada, 2016a).

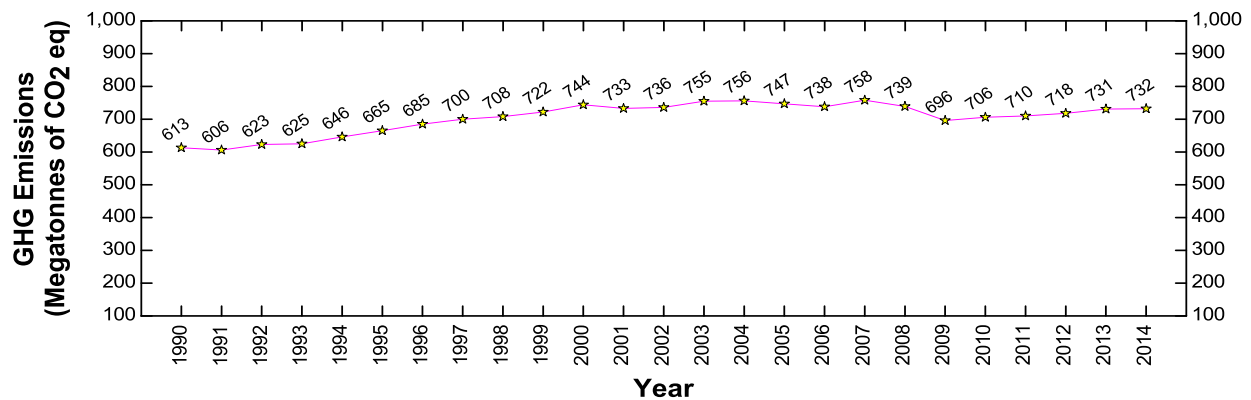

Source: Environment and Climate Change Canada, 2016a

Figure 2: Greenhouse Gas Emissions (Megatonnes of CO₂ eq. in Canada from 1990 – 2014)

In 2014, the oil and gas sector was the largest GHG emitter in Canada, accounting for 192 Mt CO₂ eq (26.25% of total emissions), followed closely by the transportation sector emitting 171 Mt CO₂ (23.39%), electricity emitting 78 Mt CO₂ (10.68%), buildings emitting 87 Mt CO₂ (11.90%), emissions-intensive and trade-exposed industries emitting 77 Mt CO₂ (10.44%), agriculture emitting 73 Mt CO₂ (9.95%), and waste & others emitting 54 Mt CO₂ (7.39%) as shown in Figure 3 (Environment and Climate Change Canada, 2016b).

Environment Canada has projected the GHG emissions for Canada to 2030 based on a range of scenarios. Figure 4 presents three lines on a graph spanning the years 2005-2030. The vertical axis is in Megatonnes of CO₂e and spans the values 500 to 850 in fifty megatonne increments. The three lines start out as one in the period between 2005 and 2014 and represent historical emissions, but in 2015 they start to diverge. From 2015 the top line, representing the highest emissions scenario, reaches 747 Mt in 2020, peaks in 2029 and then declines slightly to reach 790 Mt in 2030. The middle line, representing the reference scenario, reaches 731 Mt in 2020, is slowly increasing to reach the peak in 2025, and then declines to 742 in 2030. The lowest line represents the lowest emissions scenario and reaches 720 Mt in 2020, stays relatively stable till 2029, and then declines to 697 Mt in 2030. Looking ahead, the most significant challenge for Canada is to transform its energy sector and fundamentally shift energy use away from carbon based fuels to low-carbon sources of energy. A 30% reduction in the emission target from current levels to 523 Mt in 2030 (see orange dot below) in Figure 4 is a daunting challenge.

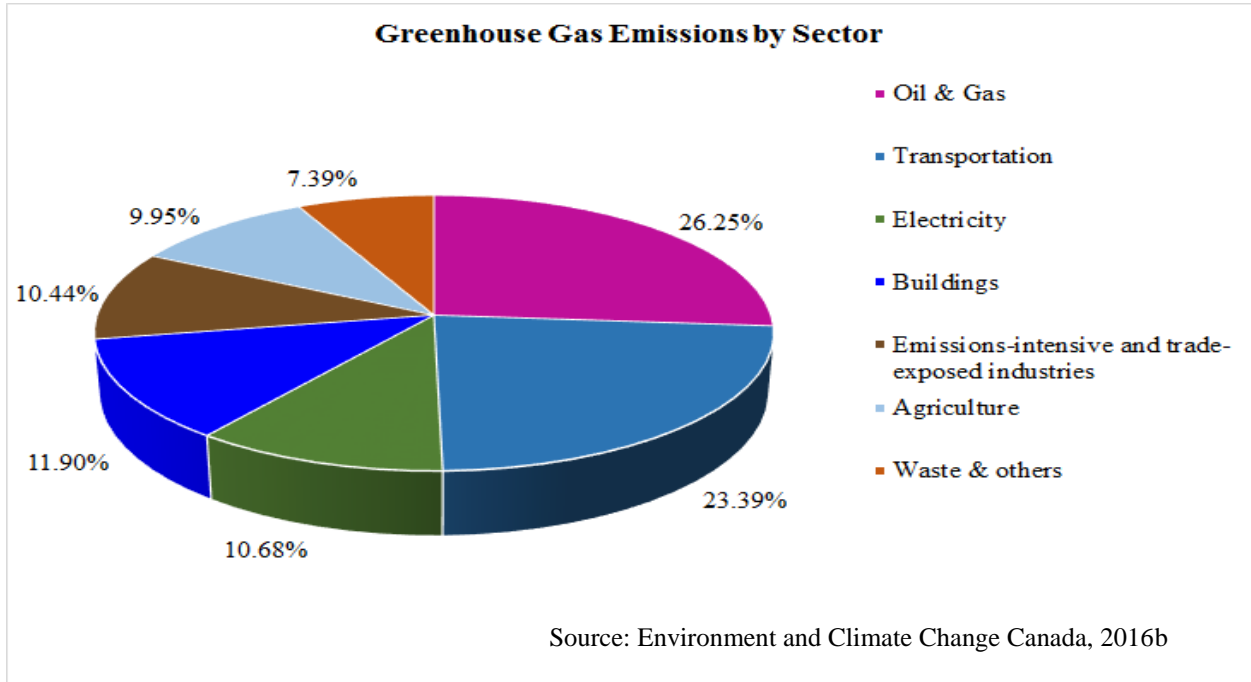

Figure 3: Greenhouse gas emissions by economic sector, Canada, 1990 to 2014

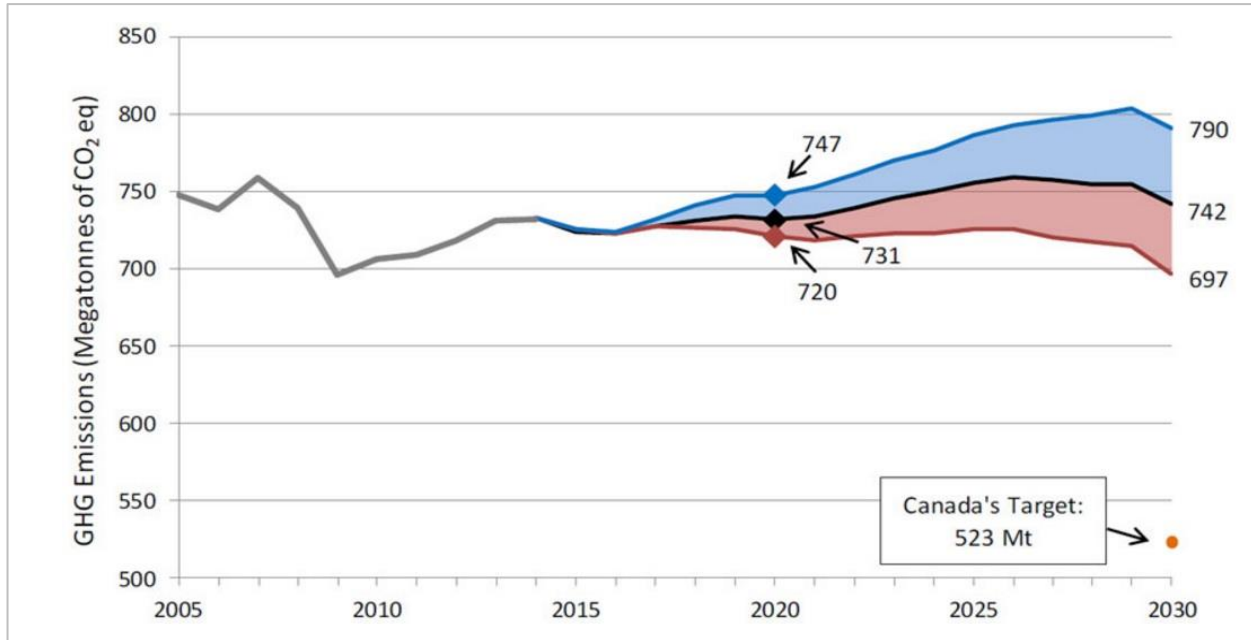

Figure 4: Projections of Greenhouse Gas (GHG) Emissions for Canada, 2015 – 2030, and Assigned Target of GHG by 2030

Innovative renewable and clean energy system technologies for the heating, ventilation, and air conditioning (HVAC) in the residential households of Canada are required to meet the vision of market-feasible net-zero energy solutions by 2030 and to reduce the greenhouse gas emissions in the residential sector of Canada (NRCan, 2016a). Canadian households use energy for space heating, cooling, and hot water usage. Energy sources include electricity, natural gas, oil, propane and wood. The amount of energy consumed depends on many factors such as climate, fuel prices, household size, and dwelling size can all contribute to household energy use (Statistics Canada, 2012). Dwellings built in the early 20th century used on average more energy than built after 1946. Modern construction practices and building codes have incorporated energy-efficient designs and features, such as improved insulation and construction tightness. The per square metre energy consumption varies according to the age of the dwelling. However, the size of dwellings also varies according to age – dwellings built after 1996 were larger on average than all other dwellings, while those built during the immediate post-WW II era were the smallest (Statistics Canada, 2012).

The energy intensity (in gigajoules per square meter) went down by 33% from 1990 to 2014 in the residential sector of Ontario due to efficiency improvements. Energy Intensity is defined as:

$$\text{Energy Intensity} = \frac{\text{Total Energy Use}}{\text{Total Floor Space}} \quad (1)$$

The total energy use (in petajoules), floor space (million square meter), and energy intensity (gigajoules per square meter and gigajoules per household) in the residential sector of Ontario from 1990 to 2014 can be seen in figures 5, 6, and 7 respectively. It can be said that the effective gains from efficiency improvement has negated by growth.

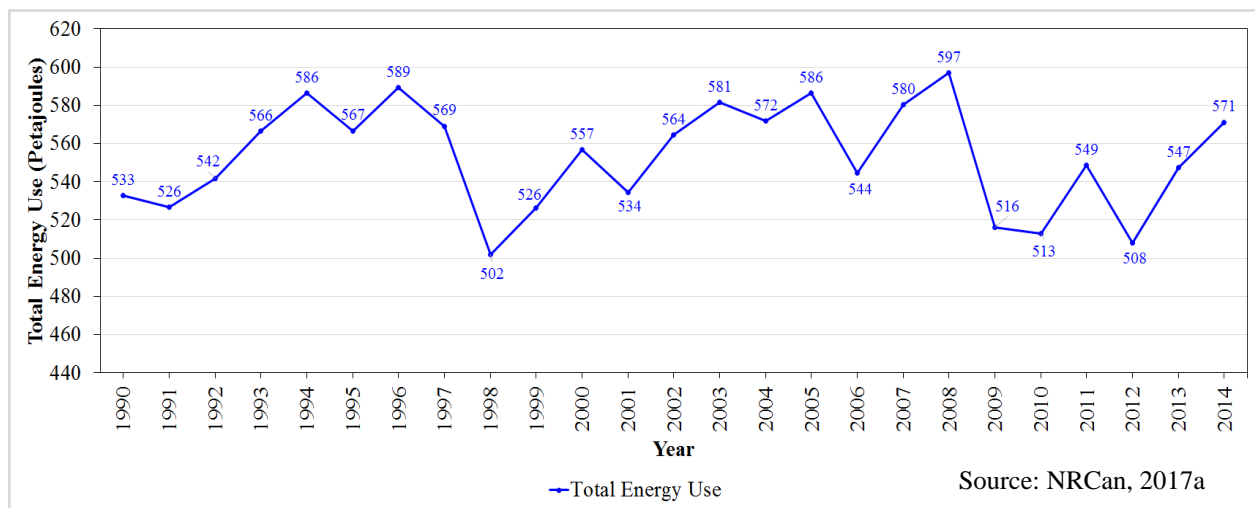

Figure 5: Total Energy Use (Petajoules) in the Residential Sector of Ontario

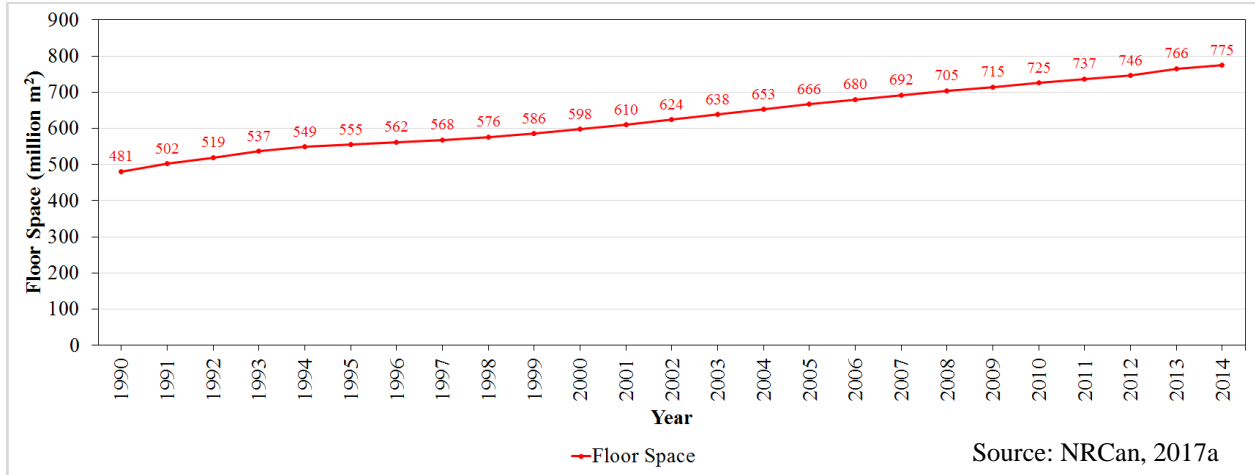

Figure 6: Total Floor Space (million square meters) in the Residential Sector of Ontario

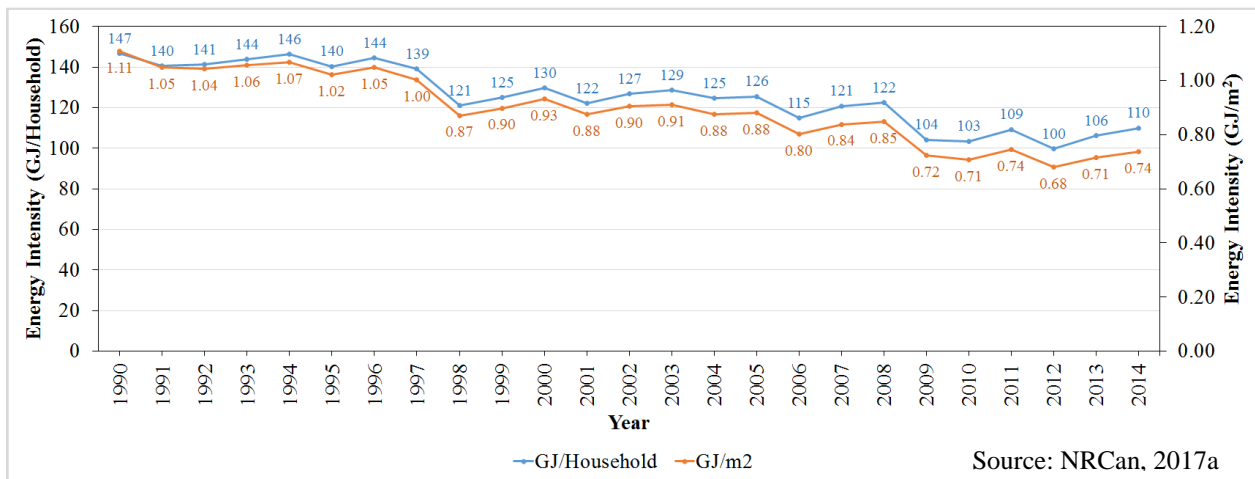

Figure 7: Energy Intensity (Gigajoules/Household and Gigajoules/square meter) in the Residential Sector of Ontario

Natural gas furnaces, air conditioners, and natural gas water heaters are the main types of energy systems for the conventional HVAC applications used in the Canadian residential households for space heating, space cooling, and hot water usage. The total energy use by energy source in the residential sector of Canada and the greenhouse gas emissions related to them in 1990 and 2014 can be seen in Figures 8, 9, 10, and 11 respectively.

In 1990, the total energy use in the residential sector of Canada was 1,424.5 petajoules (PJ) whereas in 2014 it went to 1,560.5 PJ, an increase of 9.55%. The use of natural gas to heat homes increased by 39% (528.4 PJ to 735.3 PJ) from 1990 to 2014 (see Figure 8 and 9). The % share of natural gas increased from 37.09% in 1990 to 47.12% in 2014 (see Figure 8 and 9) (NRCan, 2017a).

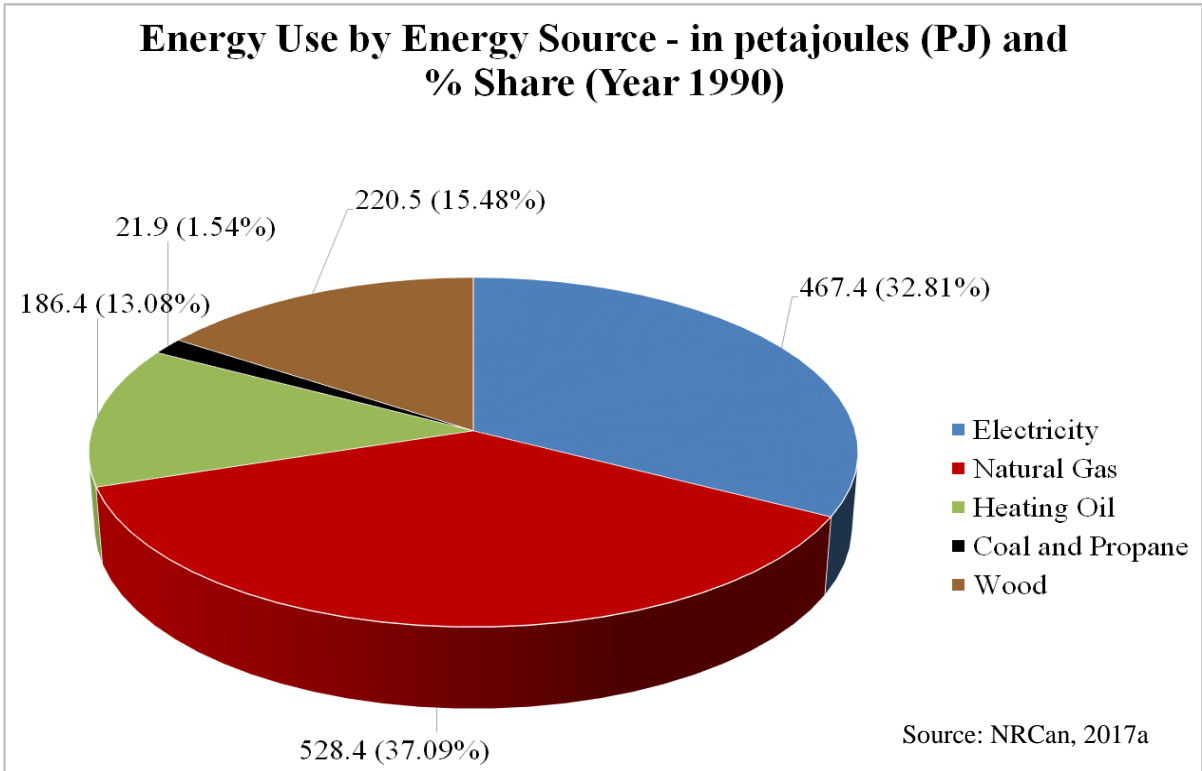

Figure 8: Energy use by energy source (petajoules) and % share in the residential sector of Canada in 1990

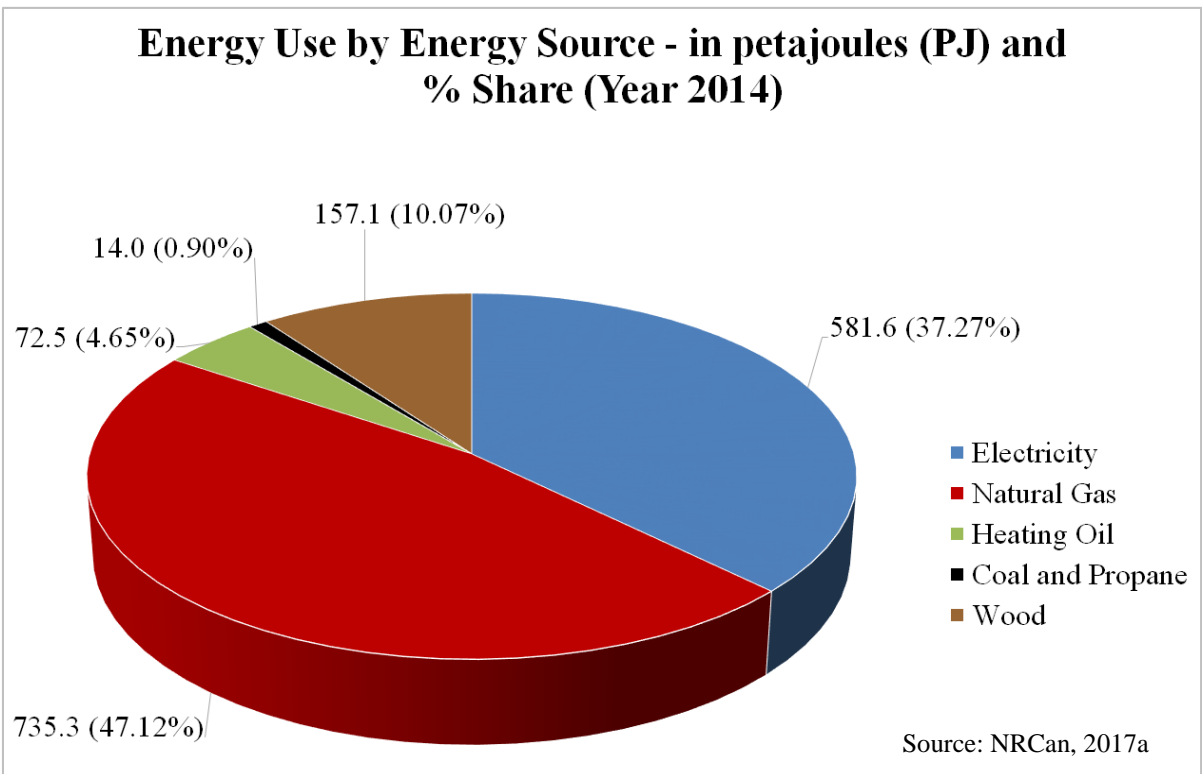

Figure 9: Energy use by energy source (petajoules) and % share in the residential sector of Canada in 2014

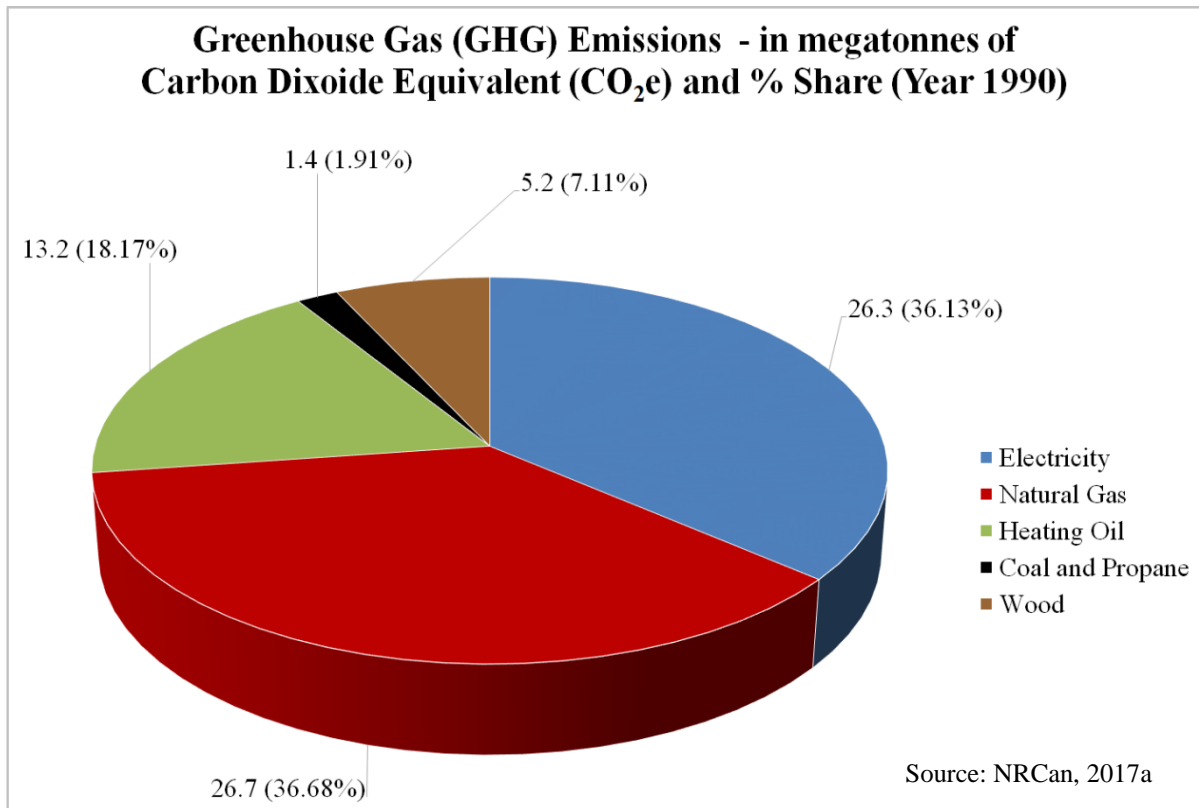

Figure 10: Greenhouse gas (GHG) emissions (megatonnes of Carbon Dioxide equivalent (CO₂e)) and % share in the residential sector of Canada in 1990

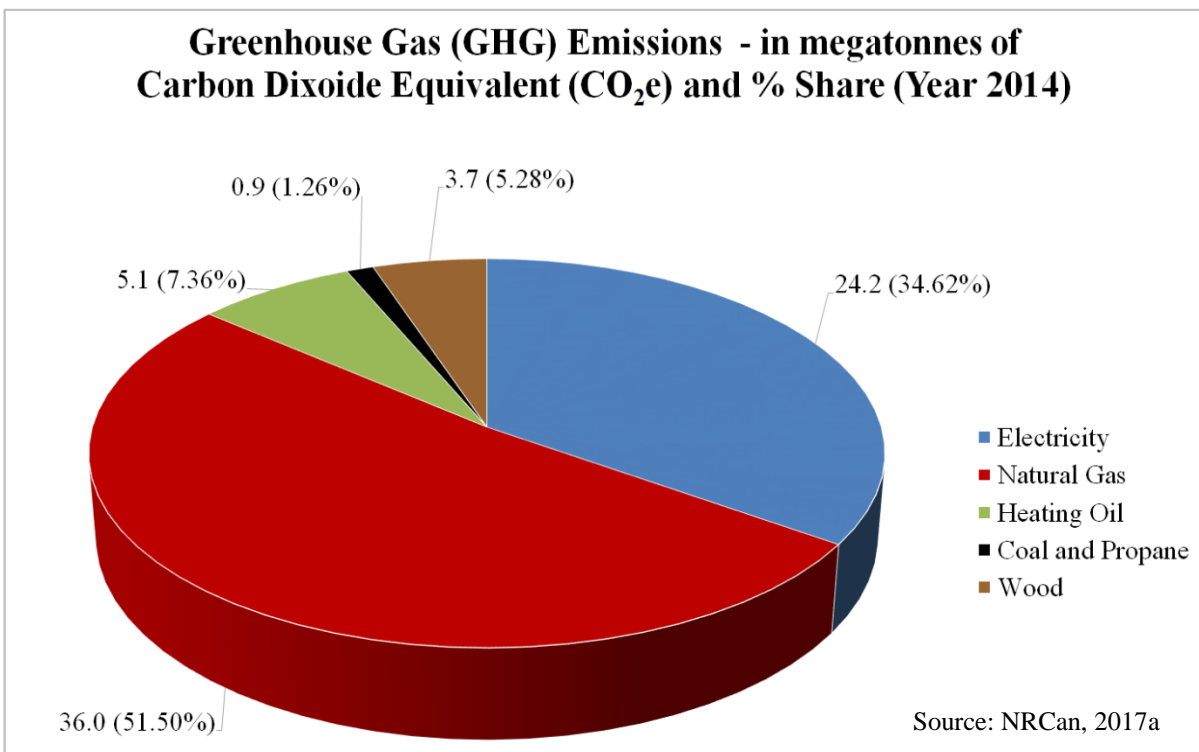

Figure 11: Greenhouse gas (GHG) emissions (megatonnes of Carbon Dioxide equivalent (CO₂e)) and % share in the residential sector of Canada in 2014

The total population of Canada is 36.29 million (Statistics Canada, 2016). See Figure 12 below for more details. Emissions vary significantly by province, owing to factors such as population, energy sources and economic base. Everything else being equal, economies based on resource extraction will tend to have higher emission levels than service-based economies. Similarly, provinces that rely on fossil fuels for their electricity generation will have higher emissions than provinces relying more on renewable sources. Ontario's GHG emissions were higher than those from the other provinces in 1990 because of its large manufacturing industry. Ontario's emissions decreased between 1990 (181.8 megatonnes of CO₂ eq.) and 2014 (170.2 megatonnes of CO₂ eq.) primarily because of the closure of coal-fired electricity generation plants (Environment and Climate Change Canada, 2016c). The total energy use by energy source in the residential sector of Ontario and the greenhouse gas emissions related to them in 1990 and 2014 is shown in Figures 13 and 14 respectively. The carbon emissions (in megatonnes) from natural gas in the residential sector of Ontario can be analyzed from year 1990 to 2014 in Figure 15.

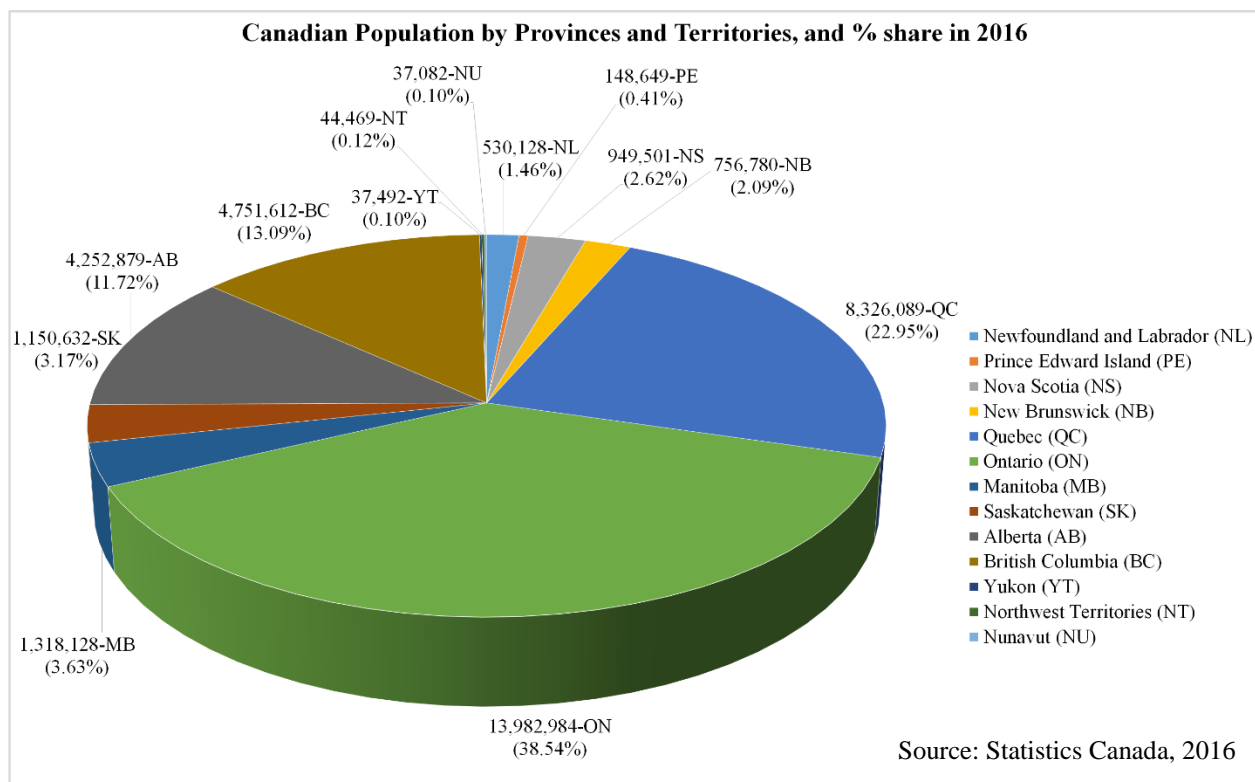

Figure 12: Canadian population breakdown by provinces and territories, and % share in 2016

The impacts of emissions from energy use are largely determined by the level of economic actions and population density.

1.2.3 The Ontario Action Plan

On April 15, 2014, Ontario became the first jurisdiction in North America to fully eliminate coal as a source of electricity generation. This action is the single largest GHG reduction initiative in North America. On November 23, 2015, Ontario passed the Ending Coal for Cleaner Air Act, permanently banning coal-fired electricity generation in the province (Ontario, 2016; and Government of Canada, 2017).

Ontario's Climate Change Strategy sets the framework for the province to meet its long-term 2050 GHG emissions reduction target. The Strategy highlights five key objectives for transformation (Ontario, 2016):

1. A prosperous low-carbon economy with world-leading innovation, science and technology,
2. Government collaboration and leadership,
3. A resource-efficient, high-productivity society,

4. Reducing GHG emissions across sectors, and
5. Adapting and thriving in a changing climate.

Policies and programs identified in the Ontario Climate Change Action Plan include (Government of Canada, 2016):

1. Transforming how ultra-low and carbon-free energy technologies are deployed in our homes and workplaces, and how we move people and goods,
2. Halting rising building-related emissions, with a focus on helping homeowners and small businesses move to low- and zero carbon energy,
3. Making available funding for industries and manufacturers proposing to transform their operations and move off carbon-based fuels and peak electricity, and
4. Aligning Ontario’s R&D and innovation funding to place a greater emphasis on climate change science and technologies, with a view to making the discoveries that could lead to breakthroughs in zero-carbon technology.

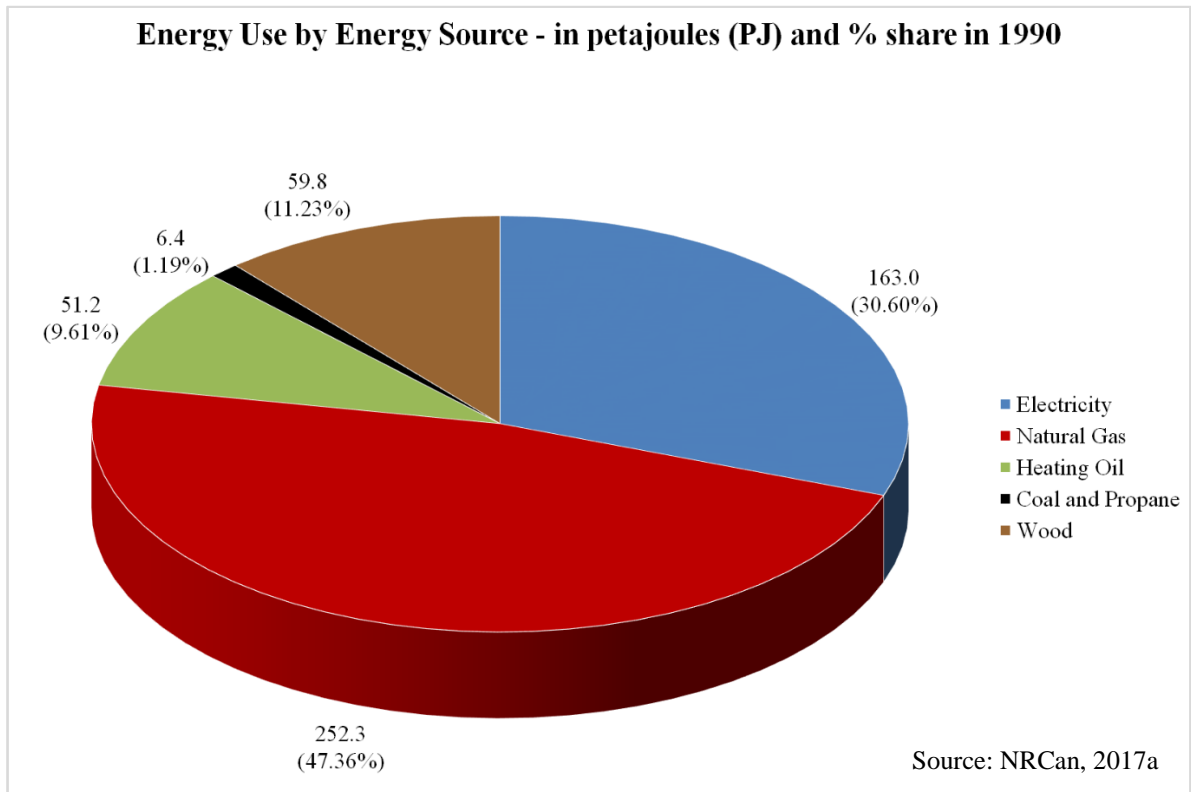

Figure 13: Energy use by energy source (petajoules) and % share in the residential buildings of Ontario in 1990

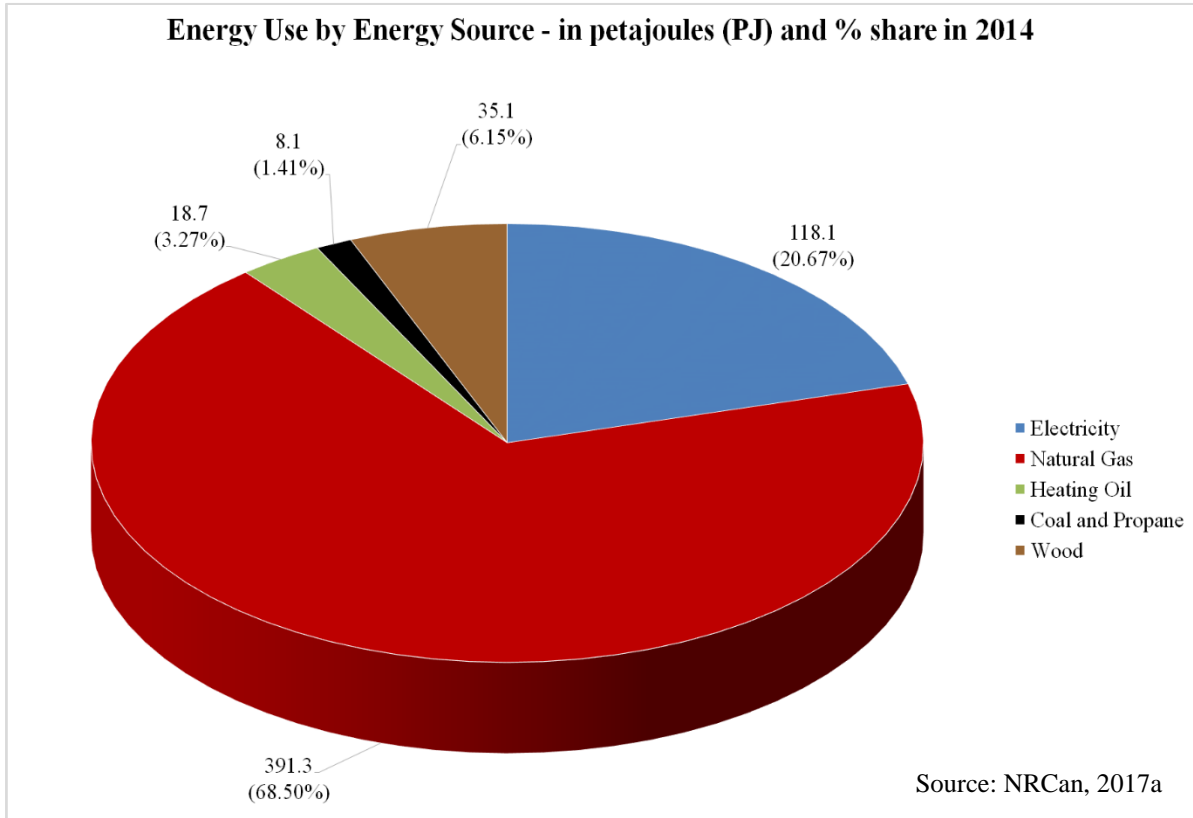

Figure 14: Energy use by energy source (petajoules) and % share in the residential buildings of Ontario in 2014

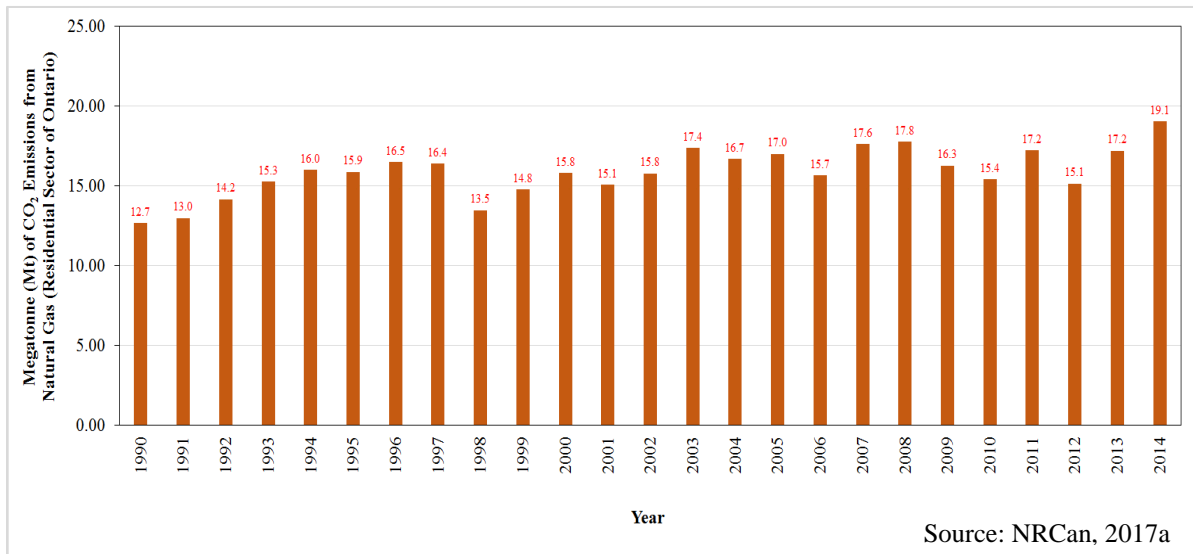

Figure 15: Greenhouse gas (GHG) emissions (megatonnes of Carbon Dioxide equivalent (CO₂e)) from Natural Gas in the residential buildings of Ontario (Year 1990 – 2014)

On May 18, 2016, Ontario passed its landmark Climate Change Mitigation and Low-carbon Economy Act, which creates a long term framework for climate action. The Act creates a robust

framework for cap and trade program, ensures transparency and accountability on how any proceeds collected under the program are used and enshrines emission reduction targets in legislation. Ontario's approach, including its cap and trade program and associated emissions reduction targets, will exceed the standards of the federal carbon pricing benchmark. Ontario's targets are: 15% below 1990 levels by 2020, 37% below 1990 levels by 2030, and 80% below 1990 levels by 2050. In Ontario, emissions will need to decline, 67.3 Mt to 114.5 Mt for 2030, and 145.4 Mt to 36.4 Mt for 2050 goals. The Ontario emissions in 1990 were 181.8 megatonnes of CO₂e Ontario has set a cap on total emissions from the covered sectors in 2017 based on the forecast emissions for large final emitters, electricity generation and transportation and heating fuels. Allowances will then be created in an amount equal to the cap and either sold or provided free of-charge to Ontario emitters (Government of Canada, 2017).

Ontario is actively developing programs for fuel switching and energy efficiency, such as retrofits for existing residential buildings (including targeted initiatives for low-income households), and clean technologies for industries and small and medium enterprises (Government of Canada, 2017).

1.2.3.1 Energy Systems in the Residential Sector of Ontario

The heating, ventilation, and air conditioning (HVAC) energy systems is arguably the most complex system installed in a house and is a substantial component of the total house energy use (Burdick, 2012). The conventional use of HVAC applications such as natural gas furnace, natural gas water heater, and air conditioner for space heating, hot water use, and space cooling in the residential households of Ontario has contributed in the growth of greenhouse gas (GHG) emissions. The total energy use by end-use and GHG emissions associated with it in the residential households of Ontario in 1990 and 2014 can be seen in Figures 16, 17, 18, and 19.

Energy systems used in the residential households of Ontario for space heating includes: (i) single systems such as heating oil (normal efficiency), heating oil (medium efficiency), heating oil (high efficiency), natural gas (normal efficiency), natural gas (medium efficiency), natural gas (high efficiency), electric, heat pump, coal and propane, and wood; and (ii) dual systems such as wood/electric, wood/heating oil, natural gas/electric, and heating oil/electric. A detailed analysis of the energy use for space heating and related GHG emissions in the residential households of Ontario in 1990 and 2014 can be seen in Figures 20, 21, 22, and 23.

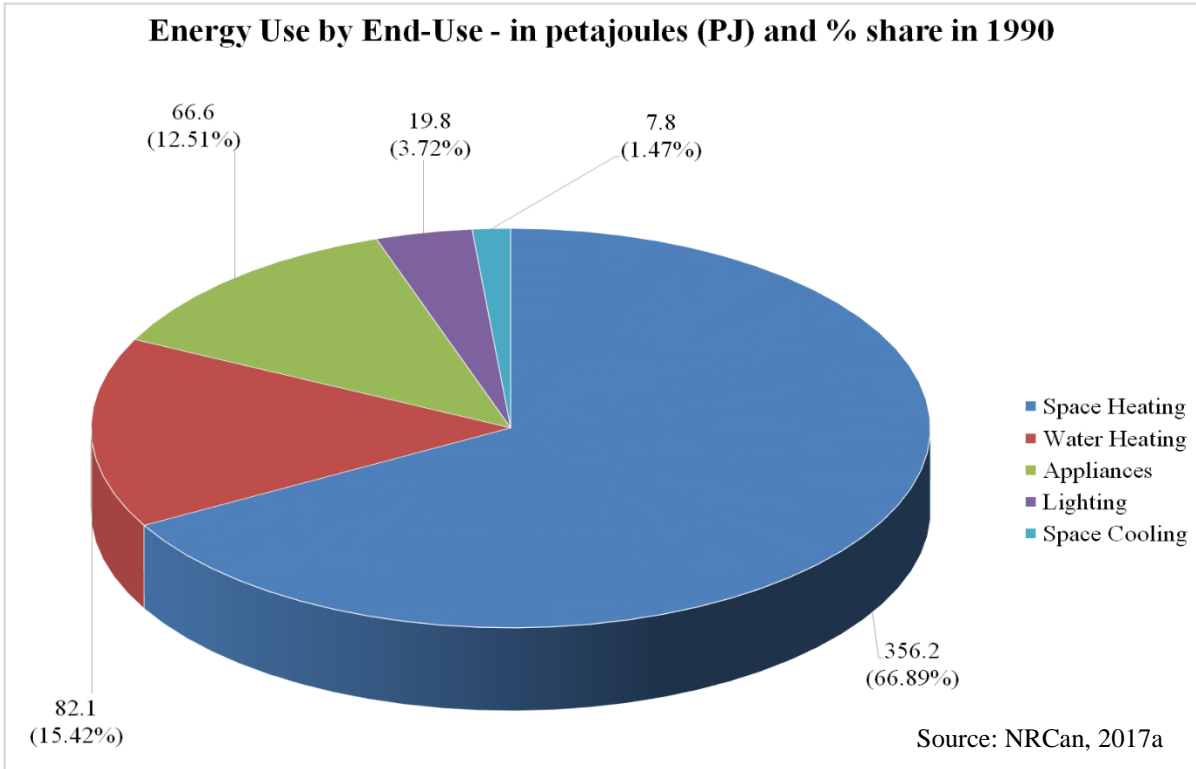

Figure 16: Energy use by end-use (petajoules) and % share in the residential buildings of Ontario in 1990

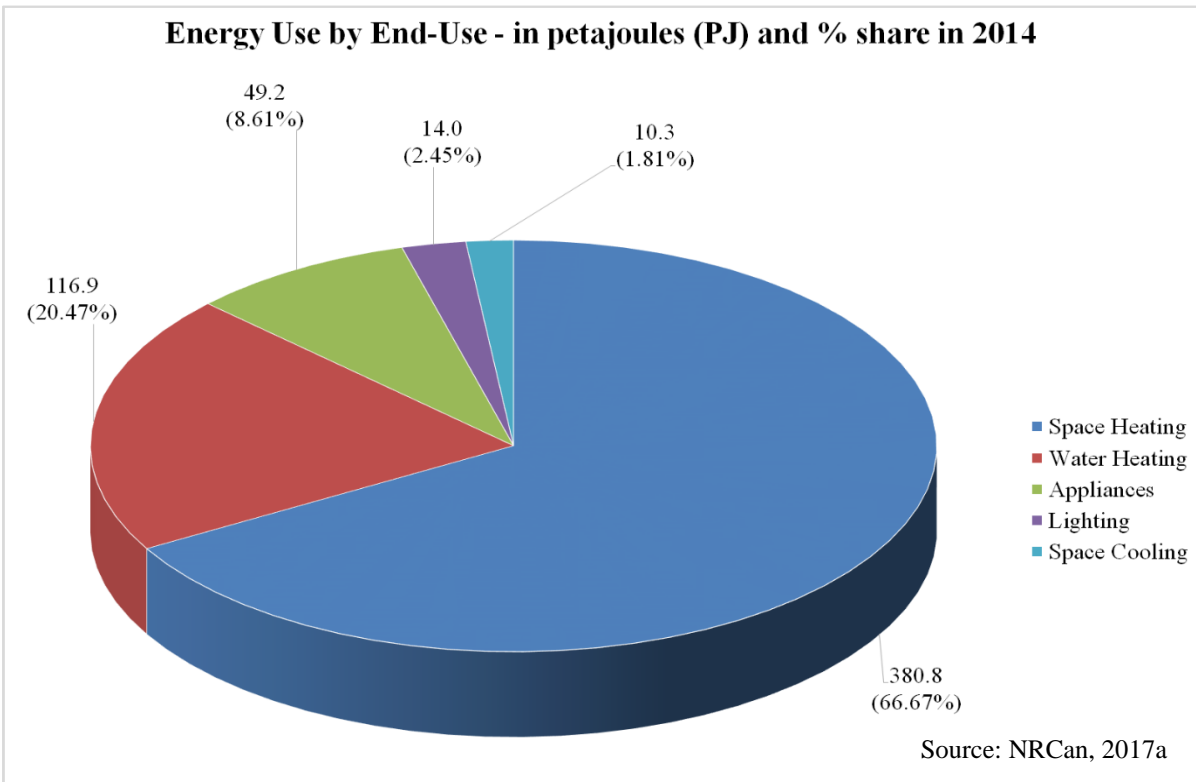

Figure 17: Energy use by end-use (petajoules) and % share in the residential buildings of Ontario in 2014

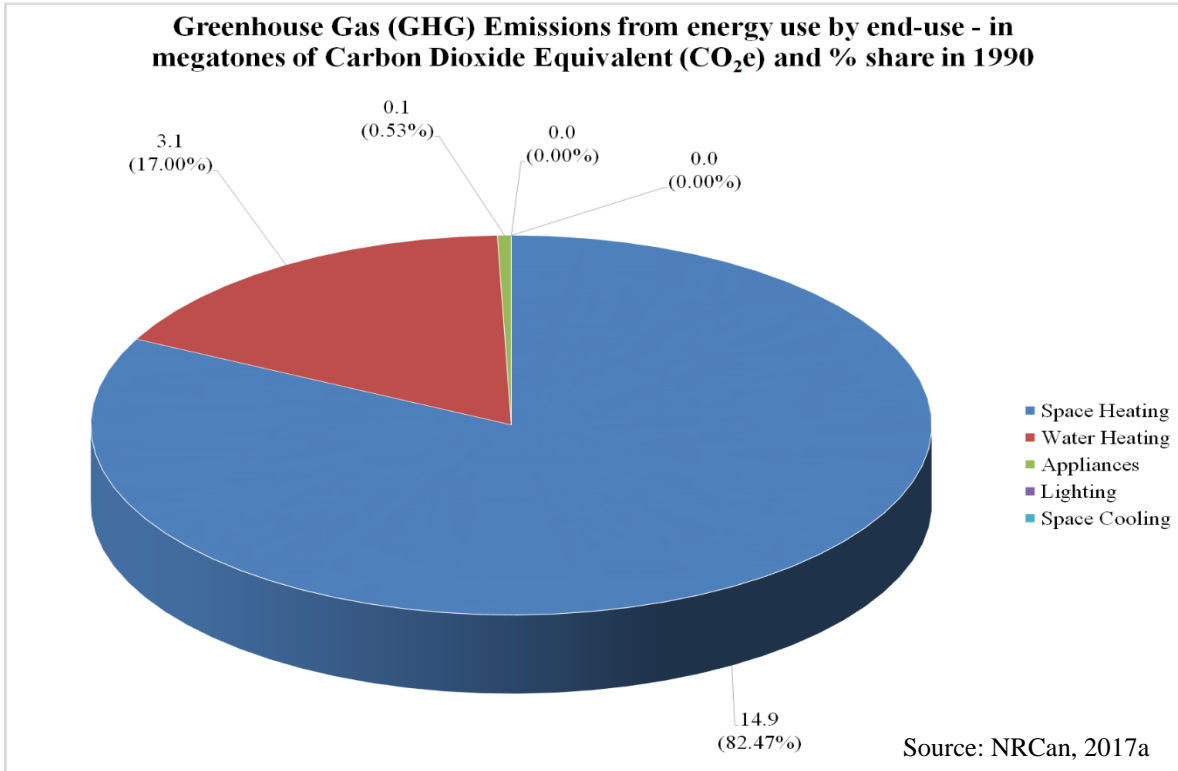

Figure 18: Greenhouse gas (GHG) emissions (megatonnes of Carbon Dioxide equivalent (CO₂e)) and % share in the residential buildings of Ontario from energy use by end-use in 1990

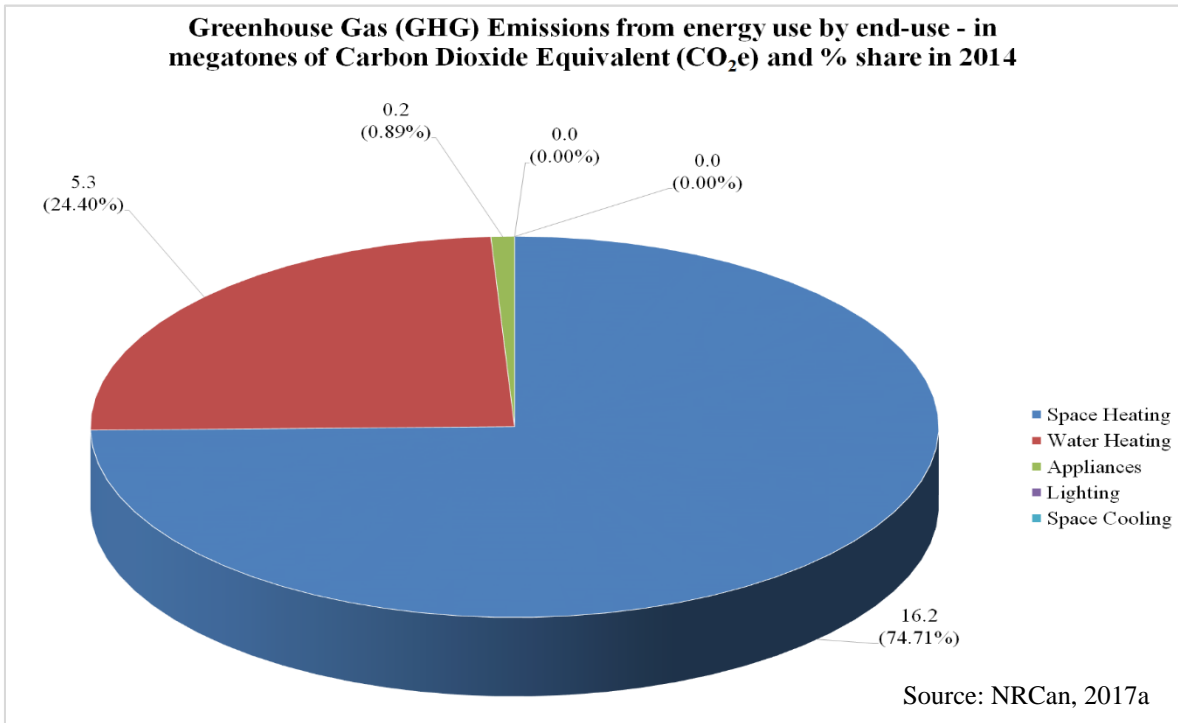

Figure 19: Greenhouse gas (GHG) emissions (megatonnes of Carbon Dioxide equivalent (CO₂e)) and % share in the residential buildings of Ontario from energy use by end-use in 2014

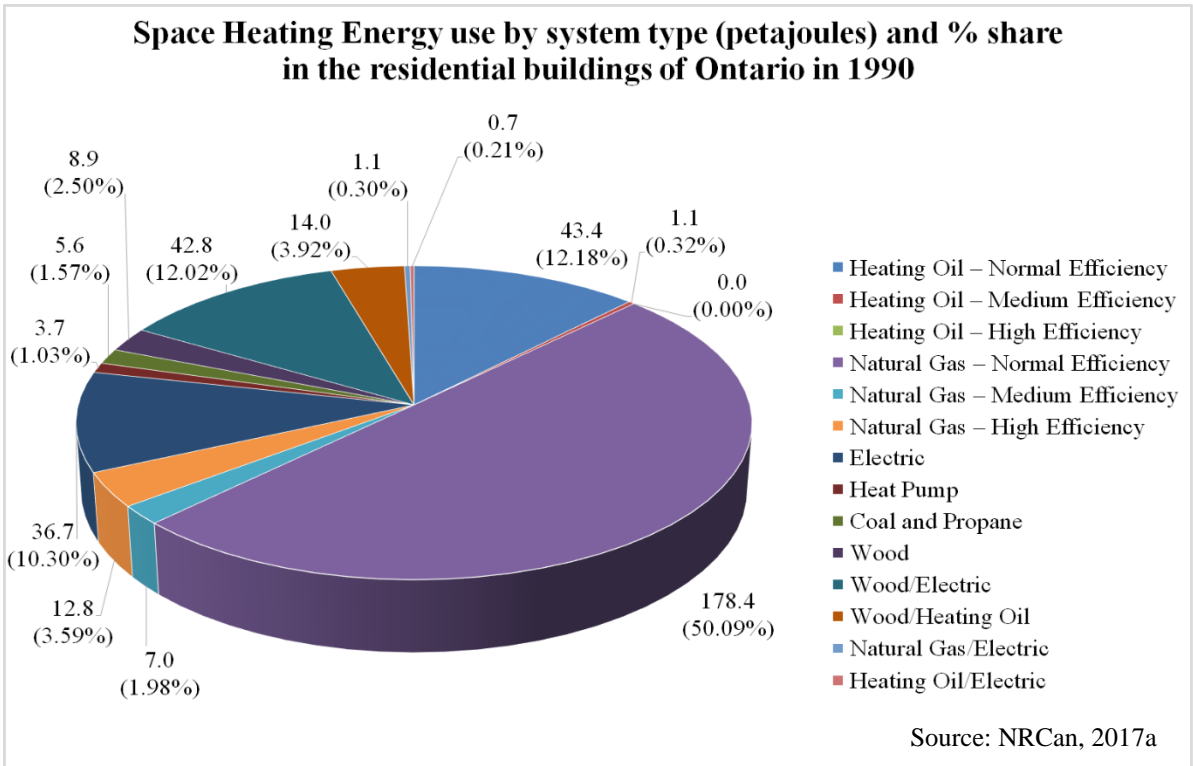

Figure 20: Space Heating Energy use by system type (petajoules) and % share in the residential buildings of Ontario in 1990

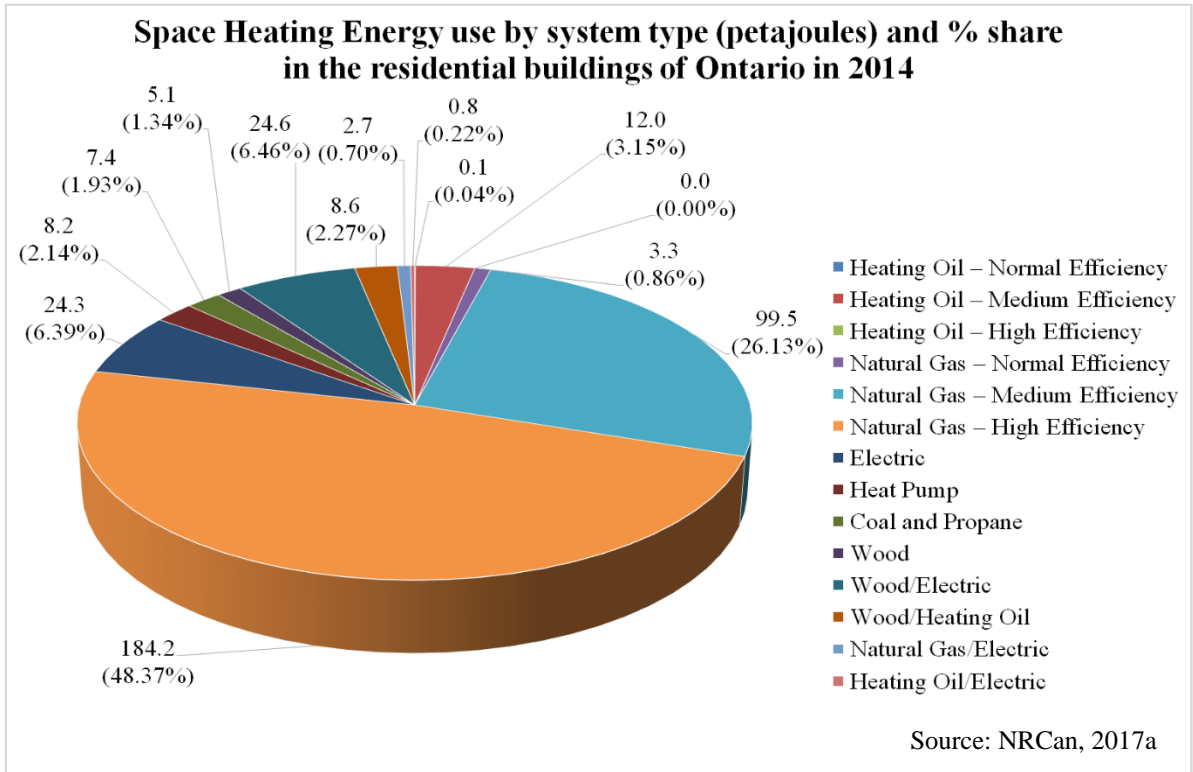

Figure 21: Space Heating Energy use by system type (petajoules) and % share in the residential buildings of Ontario in 2014

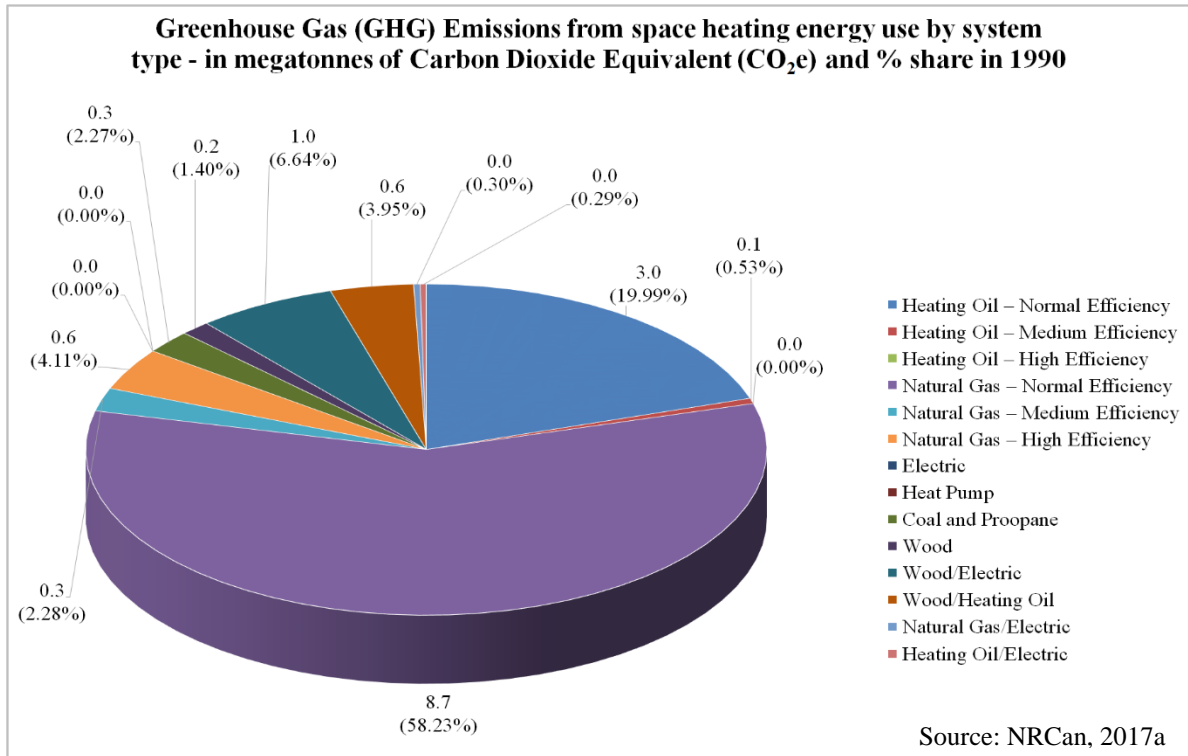

Figure 22: Greenhouse gas (GHG) emissions (megatonnes of Carbon Dioxide equivalent (CO₂e)) and % share in the residential buildings of Ontario from space heating energy use by system type in 1990

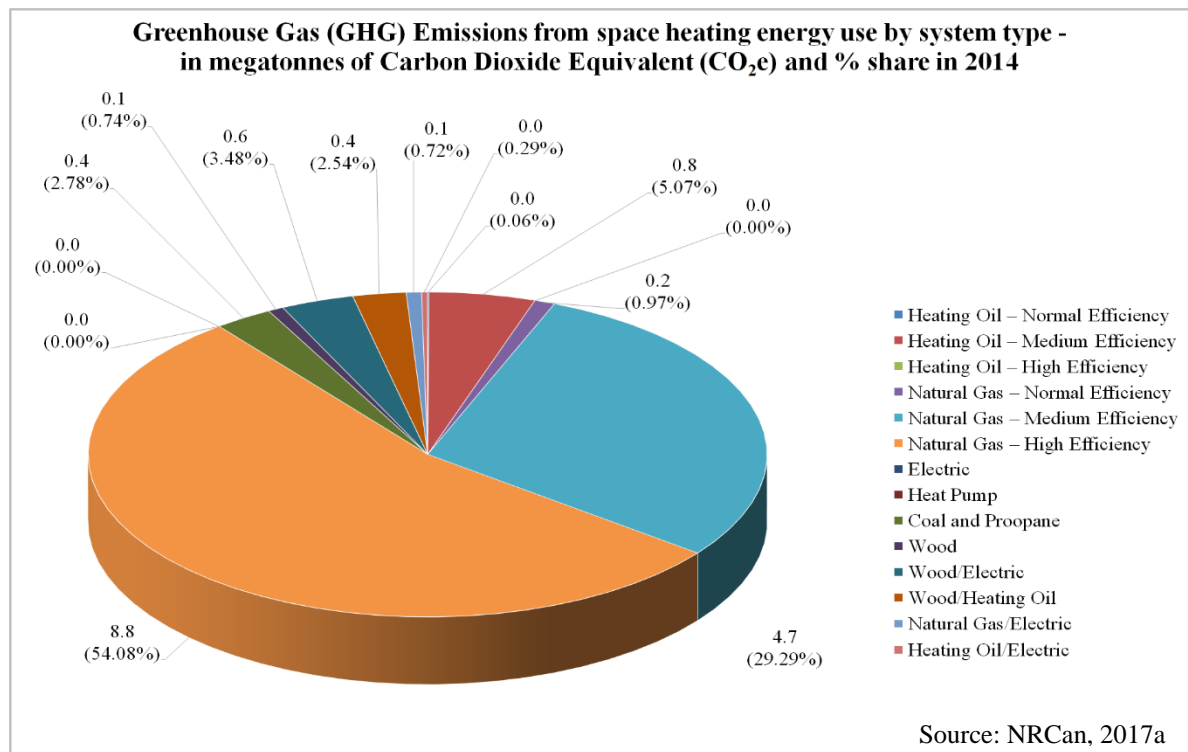

Figure 23: Greenhouse gas (GHG) emissions (megatonnes of Carbon Dioxide equivalent (CO₂e)) and % share in the residential buildings of Ontario from space heating energy use by system type in 2014

The energy systems for space cooling consists of central air conditioners and room air conditioners whereas water heating energy systems are based on electricity, natural gas, heating oil, coal and propane, and wood. The space cooling energy use by system type for the residential buildings of Ontario in 1990 and 2014 can be seen in Figure 24 and 25. It can be seen in Figure 26 that the space cooling use for central cooling system went up by 57% from 1990 to 2014. The linear forecasting method shows that it will continue to go up in the future. Additionally, the water heating energy use by energy source and related GHG emissions for the residential households of Ontario in 1990 and 2014 can be assessed in Figures 27, 28, 29, and 30.

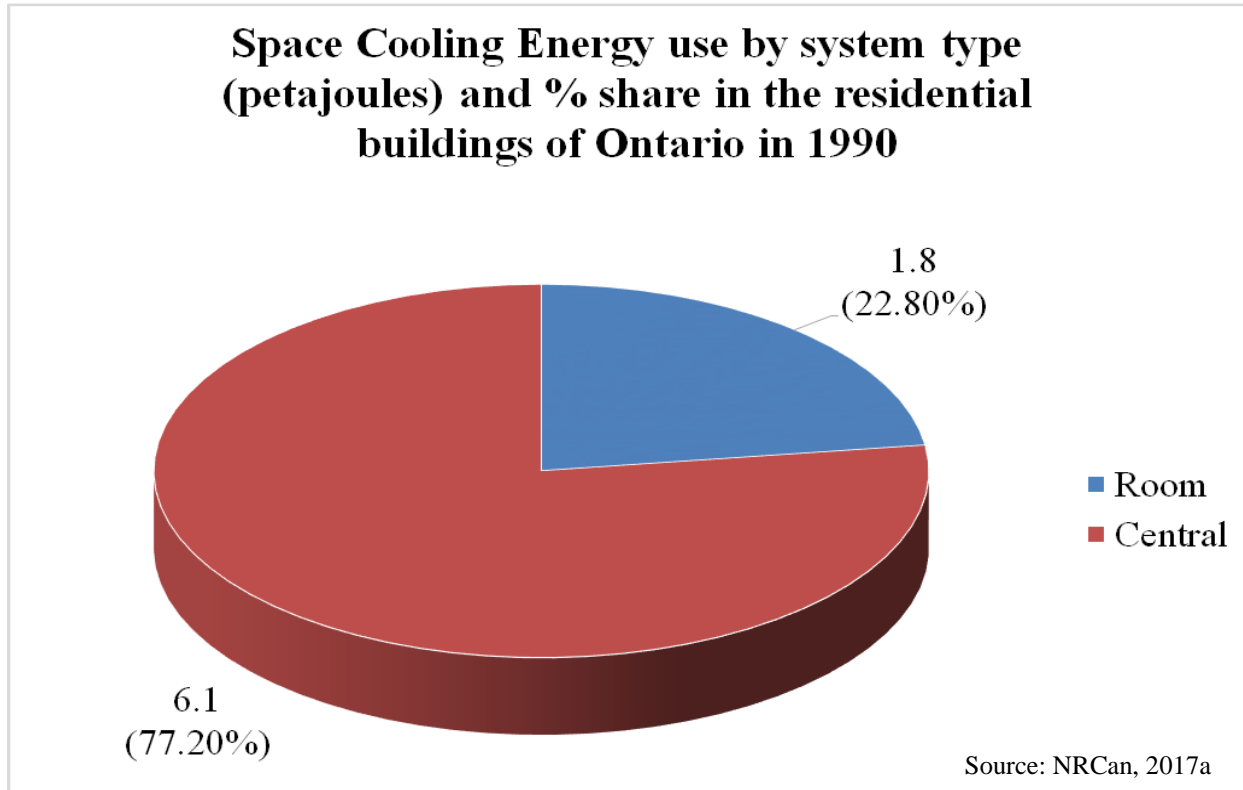
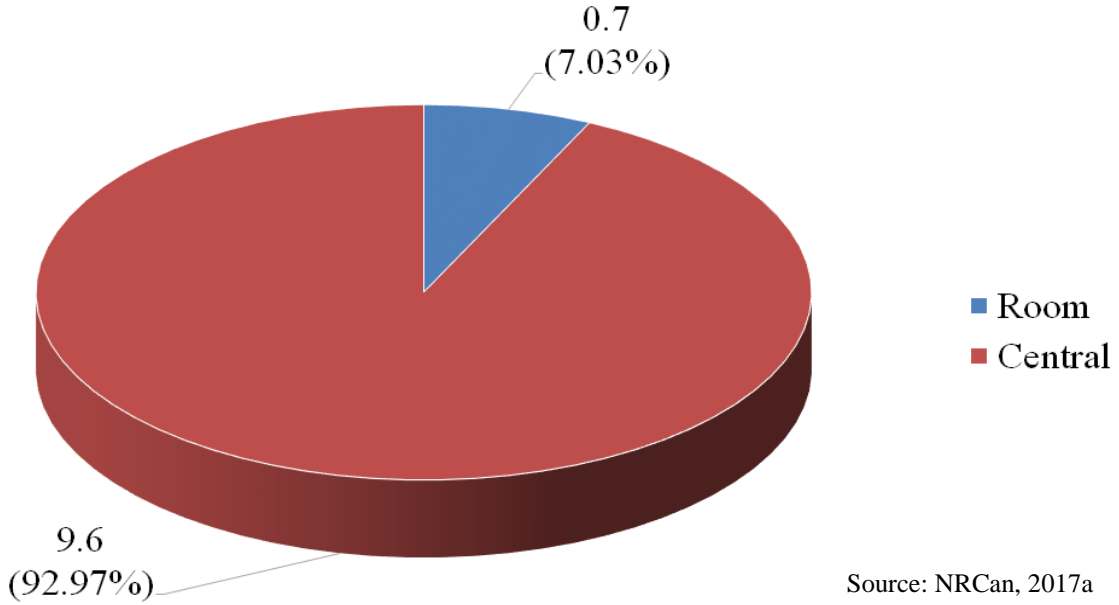

Figure 24: Space Cooling Energy use by system type (petajoules) and % share in the residential buildings of Ontario in 1990

Space Cooling Energy use by system type (petajoules) and % share in the residential buildings of Ontario in 2014



Source: NRCan, 2017a

Figure 25: Space Cooling Energy use by system type (petajoules) and % share in the residential buildings of Ontario in 2014

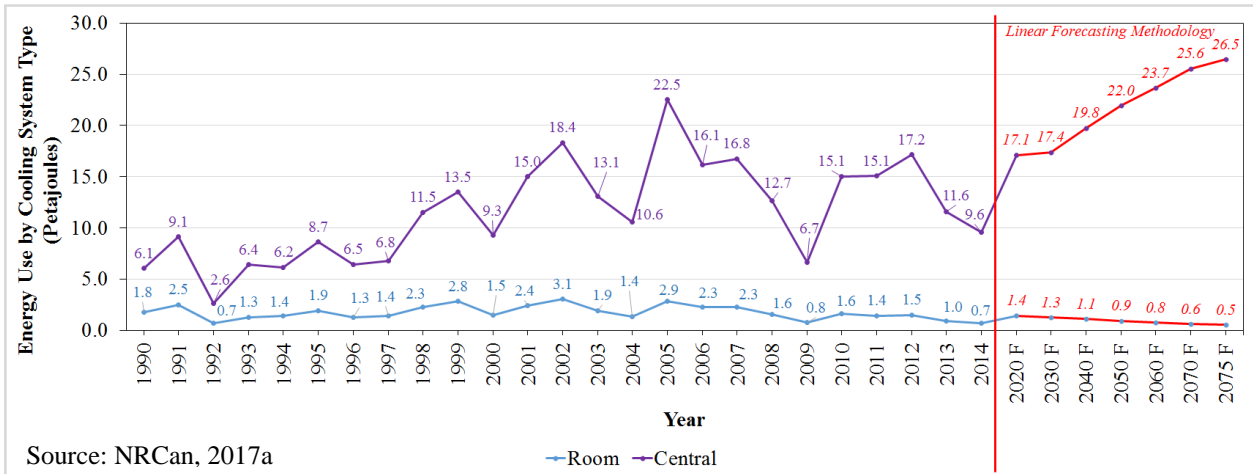

Source: NRCan, 2017a

Figure 26: Energy Use (petajoules) by Cooling System Type (Room and Central), 1990 – 2075

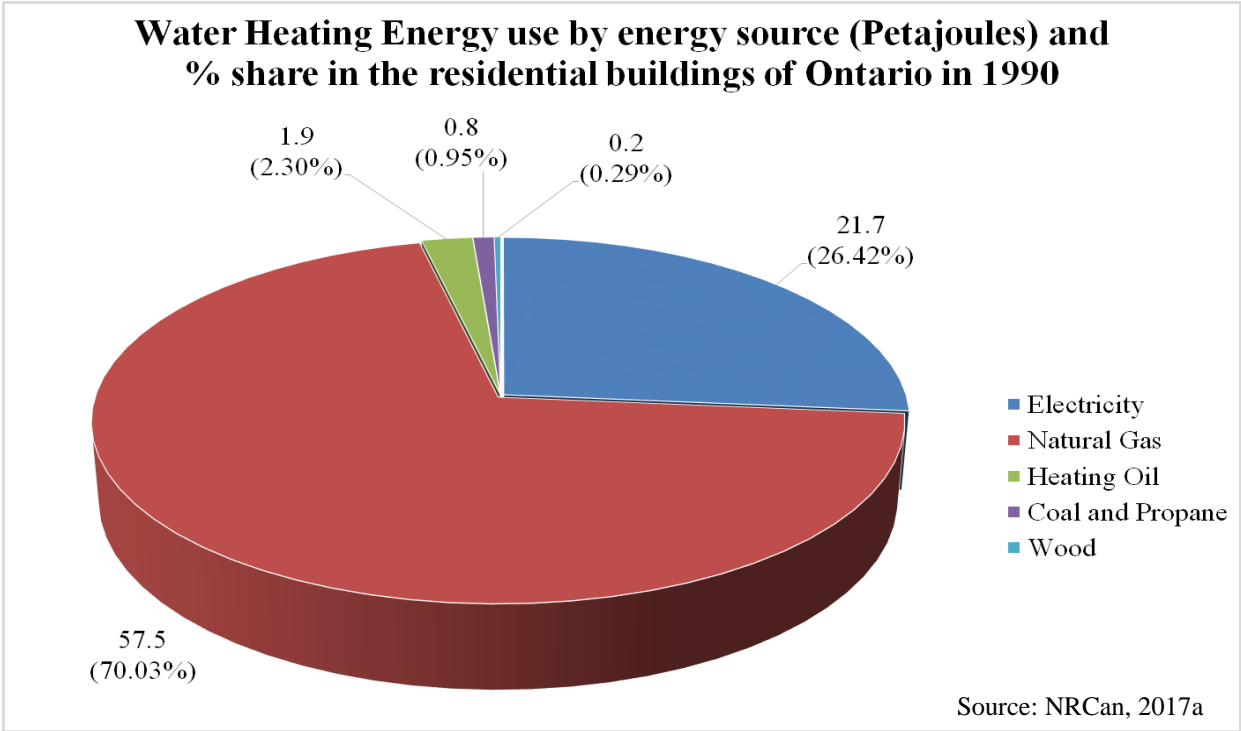

Figure 27: Water Heating Energy use by energy source (petajoules) and % share in the residential buildings of Ontario in 1990

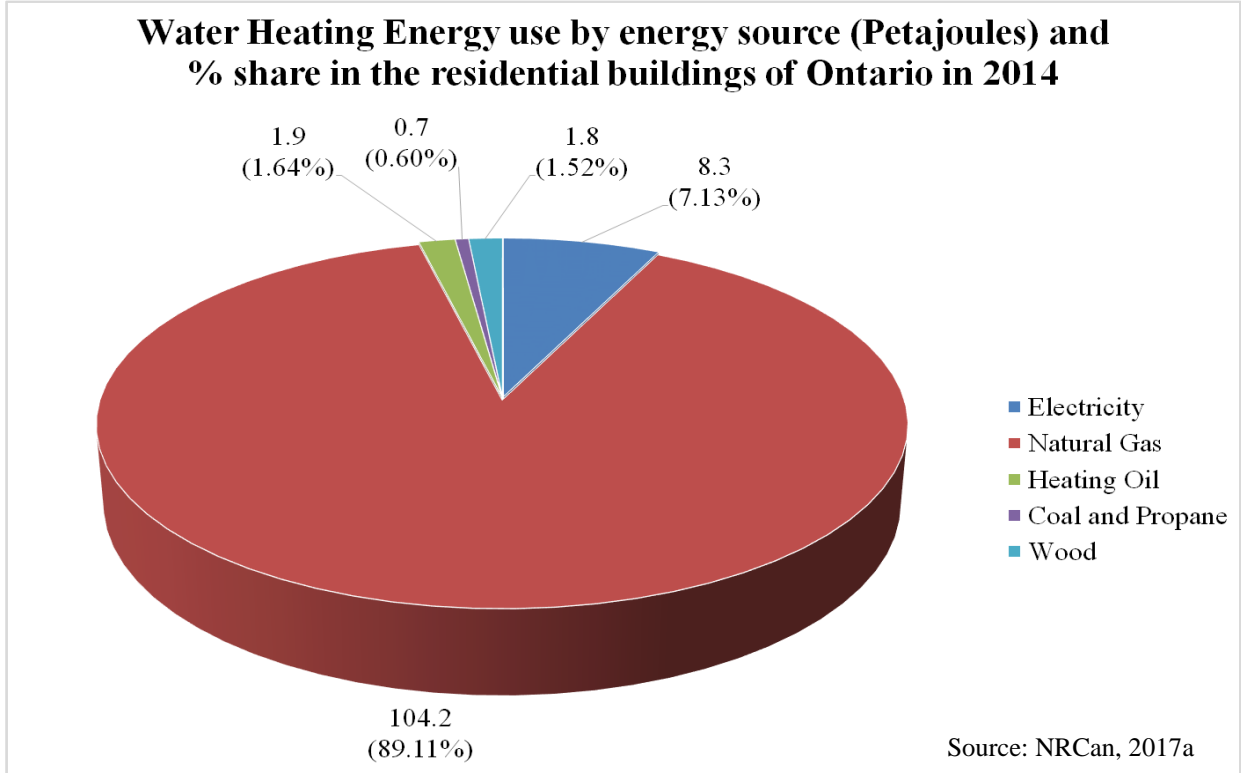

Figure 28: Water Heating Energy use by energy source (petajoules) and % share in the residential buildings of Ontario in 2014

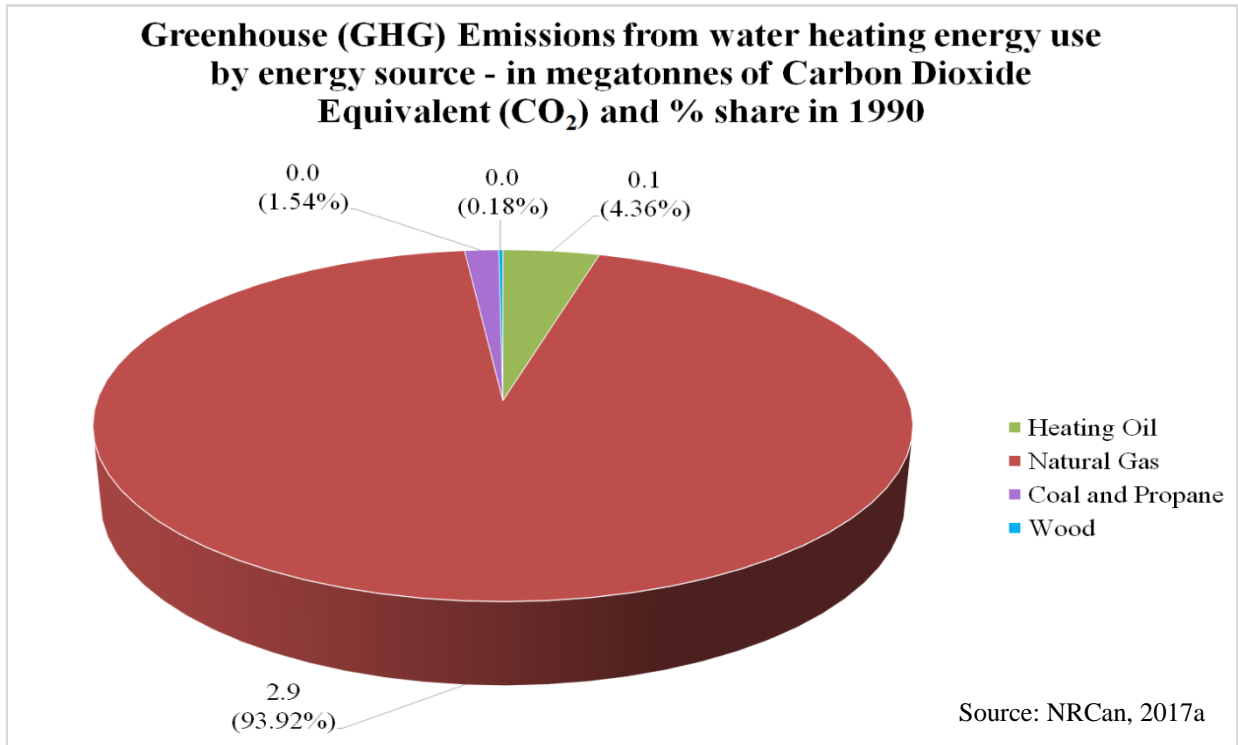

Figure 29: Greenhouse gas (GHG) emissions (megatonnes of Carbon Dioxide equivalent (CO₂e)) and % share in the residential buildings of Ontario from water heating energy use by energy source in 1990

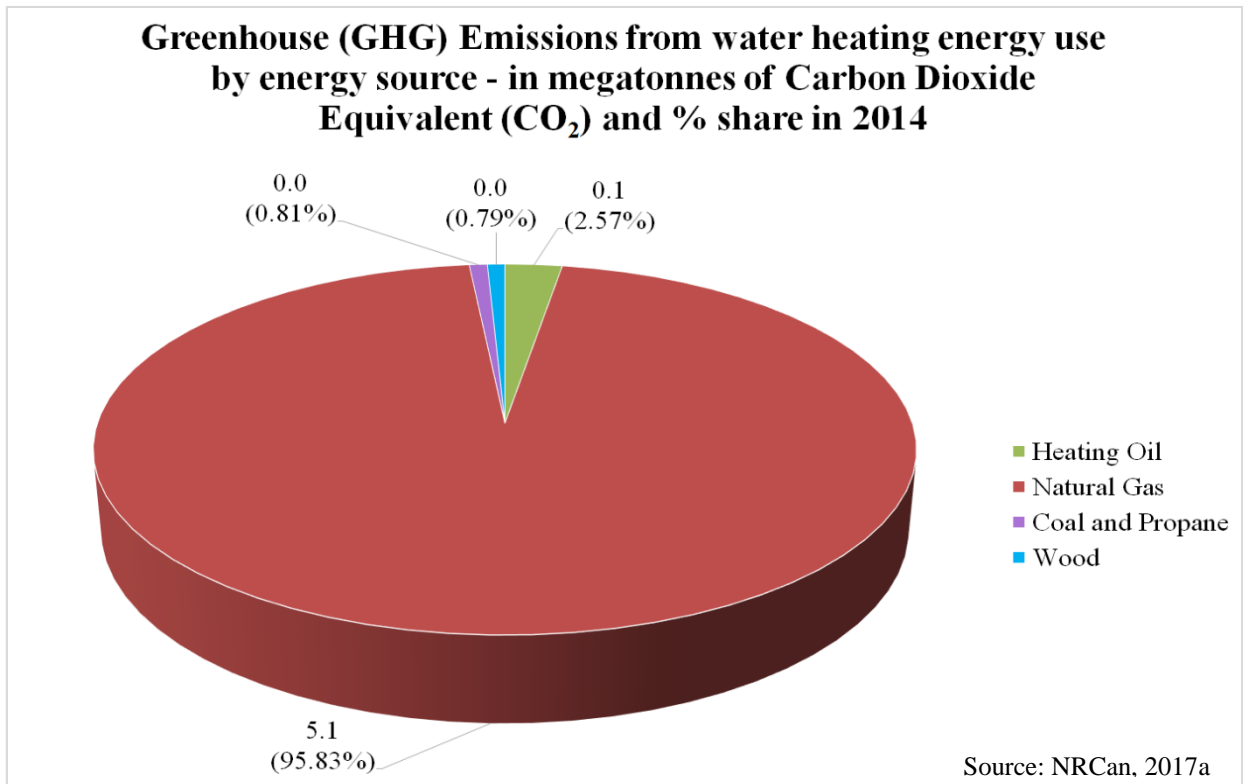

Figure 30: Greenhouse gas (GHG) emissions (megatonnes of Carbon Dioxide equivalent (CO₂e)) and % share in the residential buildings of Ontario from water heating energy use by energy source in 2014

1.2.3.2 Residential Households in Ontario

A detailed evaluation of the data for the type of residential households and % share in Ontario; total energy use by end-use; total energy use by energy source; total energy use by system type; and total energy system stock in the residential sector of Ontario from 1990 to 2014 are provided in Appendix A1, A2, A3, A4, and A5 respectively.

1.3 Research Problem

The primary focus of this study is to identify the scope, scale and the potential for reducing greenhouse gas emissions related to energy use in buildings. According to Natural Resources Canada, the total energy use of natural gas to provide space heating and hot water use in the residential households of Ontario was 252.3 petajoules (PJ) in 1990 with a market share of 47.4% as compared to 391.3 petajoules (PJ) in 2014 with a market share of 68.5% (NRCan, 2017a). The greenhouse gas (GHG) emissions from natural gas in the residential sector of Ontario were 12.7 megatonnes of CO₂ equivalent in 1990 as compared to 19.1 megatonnes of CO₂ equivalent in 2014 (NRCan, 2017a). This is an increase of 50% in carbon emissions from natural gas in the residential sector of Ontario. The total GHG emissions in the residential sector of Ontario from the energy use of natural gas, heating oil, coal & propane, and wood has jumped from 18.1 megatonnes of CO₂ equivalent in 1990 to 21.7 megatonnes of CO₂ equivalent in 2014 (NRCan, 2017a).

Geothermal energy systems are a promising solution for meeting the energy needs for heating, ventilation and air conditioning (HVAC) systems. Ground Source Heat Pump Systems (GSHPs) are highly efficient, clean, renewable energy technology for space heating, space cooling, and hot water use that can replace fossil fuel (natural gas, heating oil, propane, *etc.*) based HVAC systems to significantly reduce GHG emissions in the residential market of Ontario. Several studies have shown the technical feasibility and financial viability of GSHPs in Ontario (Ball et al., 2011; Miller & Maynes, 2008; and Hanova et al., 2007) but the total space heating energy use by heat pumps (including ground source and air source) was only 2.1% in the residential sector of Ontario in 2014 (NRCan, 2017a). The data for cooling and hot water usage is not available from NRCan.

In spite of the prominence of the benefits of ground source heat pump system (GSHPs), the end users of the Ontario residential market haven't fully exploited this technology. One of the reasons being the high capital costs associated with GSHPs. It is about \$5,000 per ton¹ for a horizontal GSHP (H.GSHP) and \$8,000 per ton for a vertical GSHP (V.GSHP) (CGC, 2010; Marco, 2016). This means a 4 ton H.GSHP unit will cost \$20,000 and a 4 ton V.GSHP unit will cost \$32,000. In comparison, the average total installation cost for the traditional HVAC system for a 2,000 square feet detached house is approximately \$10,000 in Toronto. The breakdown is

¹ 1 Ton = 12,000 British Thermal Unit/Hour (BTU/Hour) or 3.5 Kilowatt (KW)

\$1,250 per ton for a natural gas furnace, \$1,250 per ton for an air conditioner, and \$500 per ton for a natural gas water heater (Acchione, 2016).

According to the literature, the proven lifespan of a GSHP unit is 20 to 30 years and the loops beneath the earth's surface is up to 50 years (U.S DOE, 2011; Garber et al., 2013; and Badescu, 2006). The industry experts is of the view that the GSHP unit has the potential to go past 30 years lifespan and the loops could be operative for about 150 years (Marco, 2016). On the contrary, the lifespan of a conventional HVAC system (natural gas furnace, air conditioner, and natural gas water heater) is not more than 12 years under best case scenario (Acchione, 2016).

This study highlights the critical technical parameters of geothermal energy systems and provides an economic assessment of the viability for implementing GSHPs on a wide scale in Ontario. Unique factors such as soil/rock mechanics, loop design, trenching and borehole configurations are assessed for 27 cities in Ontario.

1.4 Research Questions

This study is a technical and economic assessment of geothermal technology to support the policy options for increased use of geothermal energy sources within the residential sector of Ontario. The study also quantifies the GHG reduction potential and benefits as an aid to meet provincial and national targets. The following research questions are addressed:

1. What are the technical and economic barriers in the wide-spread adoption of ground source heat pump systems (GSHPs) in Ontario?
2. What would be the impact of large-scale deployment of Ground Source Heat Pump systems (GSHPs) on the Greenhouse Gas (GHG) Emissions in the residential sector of Ontario?
3. What strategy is required to make Ground Source Heat Pump (GSHP) technology competitive in the HVAC market with respect to the residential sector of Ontario?

1.5 Thesis Organization

The thesis is organized into four chapters. Chapter one presents the general background and sets out the research context, the problem and significance, the research questions, and the contribution of the research to the Ontario residential market. Chapter two entails a review of the fundamentals of HVAC technologies and industry best practices in the residential sector of Ontario. Chapter three is a technical, economic, and environmental assessment and relevance of the geotechnical engineering processes required in the installation of ground source heat pump systems (GSHPs). It provides the methodology, the research modeling framework, the analysis and the results. Chapter four concludes the research with summary and recommendations.

Chapter 2 – Fundamentals, and Literature Review

2.1 Overview of Ground Source Heat Pump Systems (GSHPs)

The ground source heat pump systems (GSHPs) are electrically powered heating, ventilation, and air conditioning (HVAC) technologies that take the advantage of the Earth's relatively constant temperature, below certain depths, to provide building space conditioning. GSHPs are clean (there are no on-site greenhouse gas (GHG) emissions, because the system doesn't combust fuel), energy-efficient technologies that can effectively replace conventional HVAC systems and improve building comfort (Hillesheim & Mosey, 2014).

The primary benefit of installing a GSHP system is a reduction in energy use for same level of service (heating or cooling) at a lower cost. In terms of heating, GSHP systems have a coefficient of performance of 3.0 or higher. This means that for every unit of energy consumed, three units are generated (i.e., GSHP systems are 300% or more efficient). In comparison, the efficiencies of most boiler-based heating systems are 80% or less. For space cooling, GSHP systems have an energy-efficiency ratio in excess of 14.5 (27 is the market best), which is approximately twice the energy-efficiency ratio of conventional air-conditioning. Energy savings of 70% can be achieved; 50% is the norm (Hillesheim & Mosey, 2014). According to NREL, additional GSHP system benefits include (Hillesheim & Mosey, 2014):

- **Increased conditioned space comfort:** Heat pumps run almost constantly, ramping heating and cooling up and down as needed (i.e., there are no on-off fluctuations); provide superior humidity regulation; and are quiet.
- **Safe operation:** Heat pumps are electric and do not combust fuel, which also results in significantly reduced greenhouse gas emissions.
- **Free to low-cost domestic hot water:** This can be achieved by adding a de-superheater or an additional heat pump or by installing a three-phase heat pump.
- **Low operations and maintenance costs:** Annual costs are typically 50% to 70% less than conventional systems.
- **Long warranty periods:** Typically, warranties are 25 years for the interior components and 50 years for the loop-field piping.

GSHP systems work optimally in climate regimes where heating and cooling are relatively balanced. Their versatility means with minor system adaptation, modification, or hybridization, GSHP systems can be deployed effectively in heating-dominated or cooling dominated climates. Additionally, GSHP systems can be used to supply hot water for domestic purposes and/or commercial or industrial applications *i.e.* snow melting, brewing, *etc.* (Hillesheim & Mosey, 2014).

2.1.1 Working Principle

The technology of GSHPs follow the same principles of a heat pump system. They rely on the ground temperatures being higher than outside air in winter and lower in summer. During the winter, GSHPs extract heat from the ground at a certain depth and pump it into the conditioned space whereas in summer, the process is reversed. The heat is extracted out of the conditioned space and sent to the ground as a sink for the heat through a ground heat exchanger. (Zhai et., al, 2011; Omer, 2008; and Florides & Kalogirou, 2007).

The heat pumps are machines that transfer heat from a low temperature heat source Q_{source} to a high temperature heat sink Q_{sink} employing mechanical work W . A simple conceptual scheme of heat pump is provided in Figure 31. The balance helps the ground to maintain its geothermal properties in the long run.

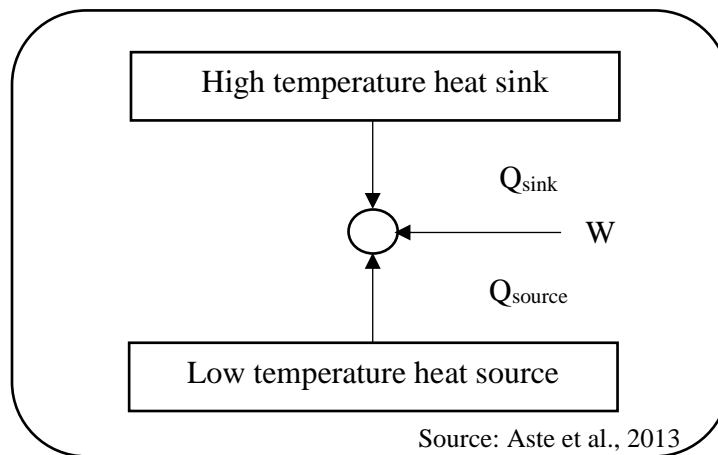

Figure 31: Heat Pump Scheme

The basic formulas to characterize heat pumps' energy behaviour are as follows:

$$Q_{\text{source}} + W = Q_{\text{sink}} \quad (2)$$

$$Q_{\text{source}} = Q_{\text{sink}} - W \quad (3)$$

The heat pump cycle is fully capable of providing year round climate control for the building *i.e.* heating in winter and cooling & dehumidifying in summer. A heat pump can be used to supply heat to a living space of a building even on cold winter days. In fact, air at -18°C contains about 85% of the heat it contained at 21°C (NRCan, 2017c). There is a myth that heat cannot be abstracted from the ground, water, or air at or below 0°C because the water freezes at this temperature. In fact, it is only -273°C (absolute zero on the Kelvin temperature scale) that a substance is devoid of all temperature and energy. In other words, even at 0°C , there are still 273 units of useful energy left in the environment (Feuvre, 2007). The energy stored in the environment and in the Earth is low grade as opposed to electricity which is high grade. For this reason, it needs

the heat pump process serve a useful purpose to convert low grade heat to useful service, namely, domestic space heating and cooling and direct hot water.

2.1.2 Components

The components of ground source heat pump system (GSHPs) are as follows (NRCan, 2017d):

Refrigerant: It is the liquid/gaseous substance that circulates through the heat pump, alternately absorbing, transporting and releasing heat.

Reversing Valve: It controls the direction of flow of the refrigerant in the heat pump and changes the heat pump from heating to cooling mode or vice versa.

Coil: It is a loop, or loops, of tubing where heat transfer takes place. The tubing may have fins to increase the surface area available for heat exchange.

Evaporator: It is a coil in which the refrigerant absorbs heat from its surroundings and boils to become a low-temperature vapour. As the refrigerant passes from the reversing valve to the compressor, the accumulator collects any excess liquid that didn't vaporize into a gas. Not all heat pumps, however, have an accumulator.

Compressor: It squeezes the molecules of the refrigerant gas together, increasing the temperature of the refrigerant.

Condenser: It is a coil in which the refrigerant gives off heat to its surroundings and becomes a liquid.

Expansion Valve: It lowers the pressure created by the compressor. This causes the temperature to drop, and the refrigerant becomes a low-temperature vapour/liquid mixture.

2.1.3 Performance – Efficiency Measures

The performance of GSHP is identified by the coefficient of performance (COP) and the energy efficiency ratio (EER) in both heating and cooling modes (Aste et al., 2013). The coefficient of performance (COP) is an expression of the efficiency of a heat pump. The COP can be calculated by comparing the heat output from the condenser (Q) to the power supplied to the compressor (W) (Grundfos, 2017). For example, if the COP is 2 (2 = 200%) then it means that 2 KW of heat is generated for every 1 KW of energy utilized (Feuvre, 2007).

The COP and EER is defined as follows (Egg & Howard, 2011):

Cooling – COP: Ratio of heat removed to energy input to the compressor.

Heating – COP: Ratio of heat delivered to energy input to the compressor.

EER: It is the ratio of the cooling capacity (in British thermal units [Btu] per hour) to the power input (in watts). The higher the EER rating, the more efficient the air conditioner (U.S DOE, 2017b). EER is a term generally used to define cooling efficiencies of unitary air conditioning and heat pump systems (Egg & Howard, 2011).

The formula of COP and EER can be derived From Figure 28. They are as follows:

$$\text{COP} = \frac{Q_{\text{sink}}}{W} \quad (4)$$

$$\text{EER} = \frac{Q_{\text{Source}}}{W} \quad (5)$$

Today, the heat pump units typically operate with a COP of 4.0 and a minimum required EER value of 14.1 (Fredin, 2009).

SEER (Seasonal Energy Efficiency Rating): It is the same is ‘EER’, but on a national seasonal average. It is usually used for residential air-conditioning systems, typically for less than 6 tons capacity (Fredin, 2009).

COP is an instantaneous value, which will depend on the temperatures of the heat source and sink at the time of measurement. During the assessment of the efficiency of a system, it is necessary to take a long term average COP over the entire season (heating or cooling) known as the ‘seasonal performance factor’ (SPF) of the heat pump (Banks, 2012).

One of the most significant elements to maximize the efficiency of residential building operations is to properly assess the dynamics of energy flows, control strategies, and occupant behaviour in buildings (Abdelalim, O’Brien, & Shi, 2017).

2.1.4 Principles of Thermodynamics

According to the second law of thermodynamics, heat always flows from hot to cold objects and not the revers. Therefore, it is not possible to operate a cyclic device in which heat transfers from a cooler body (T_c) to a hotter body (T_h). However, addition of an energy input can produce a net heat transfer from $T_c \rightarrow T_h$ as shown in Figure 32.

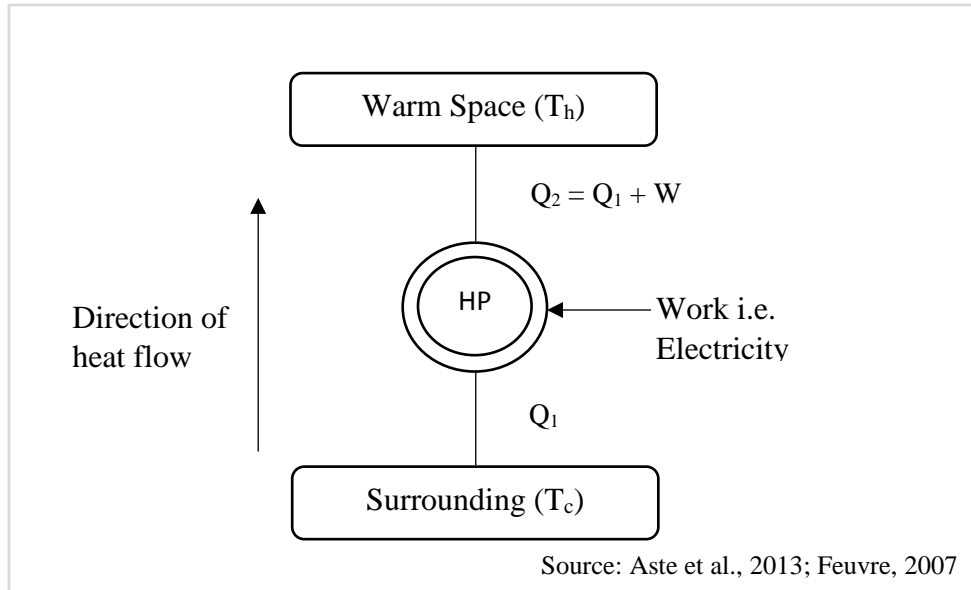

Figure 32: Basic Premise of a Heat Pump: Reproduced from Figure 31

A heat pump system is actually a ‘heat multiplier’ which heats the desired space (room) to a higher temperature than the ambient environment using a heat source (air, water, ground). A heat multiplier is a device which moves heat from the surroundings to a warm space to keep that space at a higher temperature than its surroundings (Feuvre, 2007). The heat energy or enthalpy (H) of a body can be increased by adding energy as is accomplished by the heat pump with the help of compression. This is in accordance with the first law of thermodynamics which states that it is always possible to convert any given quantity of mechanical energy into its equivalent heat energy (Feuvre, 2007).

There are many types of thermodynamic cycles which can be used to perform the operations of a heat pump but the most common one is known as the ‘vapour compression cycle’. This technology has been well established in the refrigeration system. It comprises four components: (i) compressor, (ii) condenser, (iii) expansion valve, and (iv) evaporator. Generally speaking, the refrigerant enters the compressor as a saturated vapour and is cooled to the saturated liquid state in the condenser. It is then throttled to the evaporator pressure and vaporizes as it absorbs from the desired space (Saylor, 2017). A detailed representation of the vapour compression cycle is shown in Figure 33.

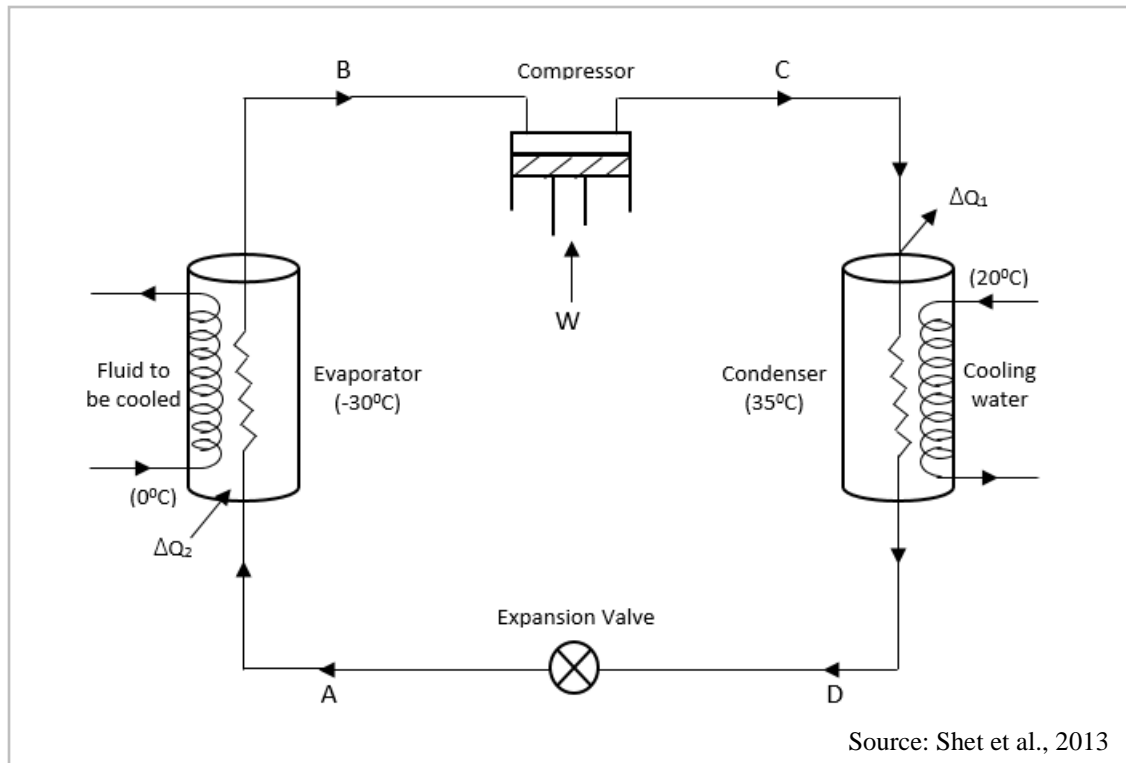

Figure 33: Vapour Compression Cycle

The compressor in the middle compresses the low temperature, low pressure vapor at state B to a high temperature and pressure vapor at state C as it comes into contact with the compressor. The condenser condenses this vapor into high pressure vapor at state D and then passed through the expansion valve. Now, the vapor is throttled down to a low pressure liquid and send to the evaporator, where it absorbs heat from the surroundings from the circulating fluid and vaporizes back again into low pressure vapor at state B. The cycle then repeats (Shet et al., 2013).

2.1.4.1 Heating Cycles

In the heating cycle of the GSHPs, the anti-freeze mixture circulating in the underground pipes absorbs heat from the soil and transfers it to the refrigerant (acts as a heat transfer fluid) in the evaporator (*i.e.* the heat exchanger). The refrigerant begins to boil and turns into a gas. The refrigerant doesn't physically mix with the anti-freeze mixture. They are separated by the plates of the heat exchangers which permits the heat transfer. These gases then fed into the compressor where the pressure of the refrigerant gas increases which makes the gas temperature rise.

After this, the gas moves into the condenser (*i.e.* the second heat exchanger) where it releases heat to the air which blows across the coil and through the duct system (*i.e.* forced air system) to heat the home. After the release of the heat, the refrigerant gas turns back into the liquid and passes through the expansion valve where its temperature and pressure drops further before it returns to

the first heat exchanger and to the ground, to begin the cycle again (NRCan, 2004a; Kensa Heat Pumps, 2017). In the radiant system, a water circulation pump moves water through pipes to different rooms. These rooms have radiators where the hot water flows through them to give away radiant heat (Feuvre, 2007; Smith, 2008).

2.1.4.2 Cooling Cycles

The cooling cycle is technically the reverse of the heating cycle where the refrigerant absorbs heat from the indoor living space and transfers it directly into the anti-freeze mixture. The heat is then pumped into the ground water pipes. Here, the reversing valve changes the direction of the refrigerant flow. The defrost cycle is not needed for GSHPs as the underground temperatures are quite stable. In addition, the heat pump unit itself is located inside the facility so the issue with the frost typically doesn't exist (NRCan, 2004a).

2.1.4.3 Domestic Hot Water

A desuperheater is used in GSHPs which absorbs heat from the refrigerant on its exit from the compressor. The facility's water heater pumps the water through a coil before the condenser coil to make sure that the heat which dissipates at the condenser can be utilized to heat water. In the summer cooling mode and heating mode during the mild weather, excess heat is easily accessible as the heat pump is above the balance point and not operating to its full capacity. The compressor is located inside the building facility which makes the process of water heating easier. Also, the GSHPs have usually extra hours of surplus heating capacity than required for domestic space heating (NRCan, 2004a).

2.1.5 Distribution System

There are two main heating, ventilation, and air conditioning (HVAC) distribution systems commonly used in the residential households: (i) forced air, and (ii) radiant.

i) Forced Air

It is a network of ducts that distributes air around the house for space heating, air conditioning, fresh air distribution, dehumidification, and air filtration. Ducts used in forced-air space-conditioning systems are a vital element in home energy efficiency. The purpose of a space-conditioning duct system is to convey heated or cooled air from the central furnace, heat pump, or air conditioner to the rooms where it is needed (NREL, 2017). A sample of the duct system and forced air supply can be viewed in Figure 34 and 35 respectively.



Source: Shutterstock, 2017a

Figure 34: Ventilation Ducts made up of Galvanized Sheets

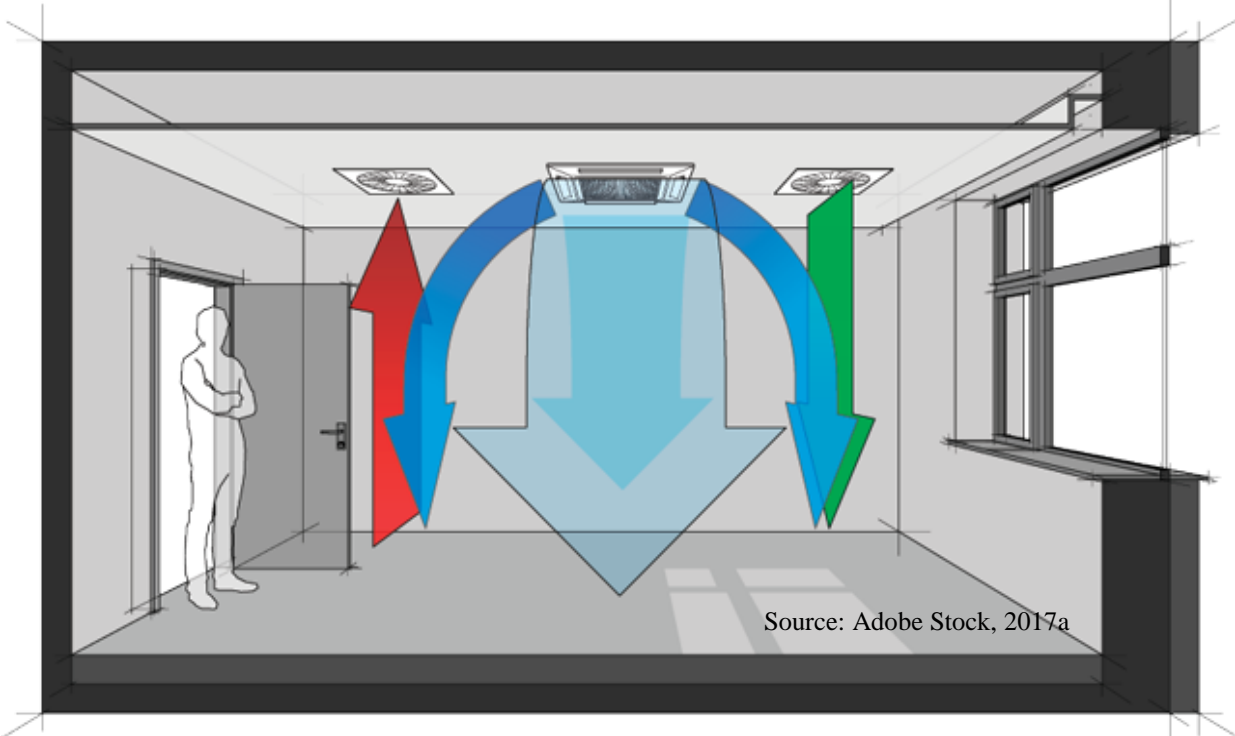

Source: Adobe Stock, 2017a

Figure 35: Ceiling Air Ventilation

ii) Radiant

Radiant heating and radiant cooling systems are different from the typical forced air HVAC systems because they heat or cool surfaces rather than air. The warm or cool surfaces then radiate heat to occupants (Autodesk, 2015). A radiant system based HVAC layout can be seen in Figure 36 below:

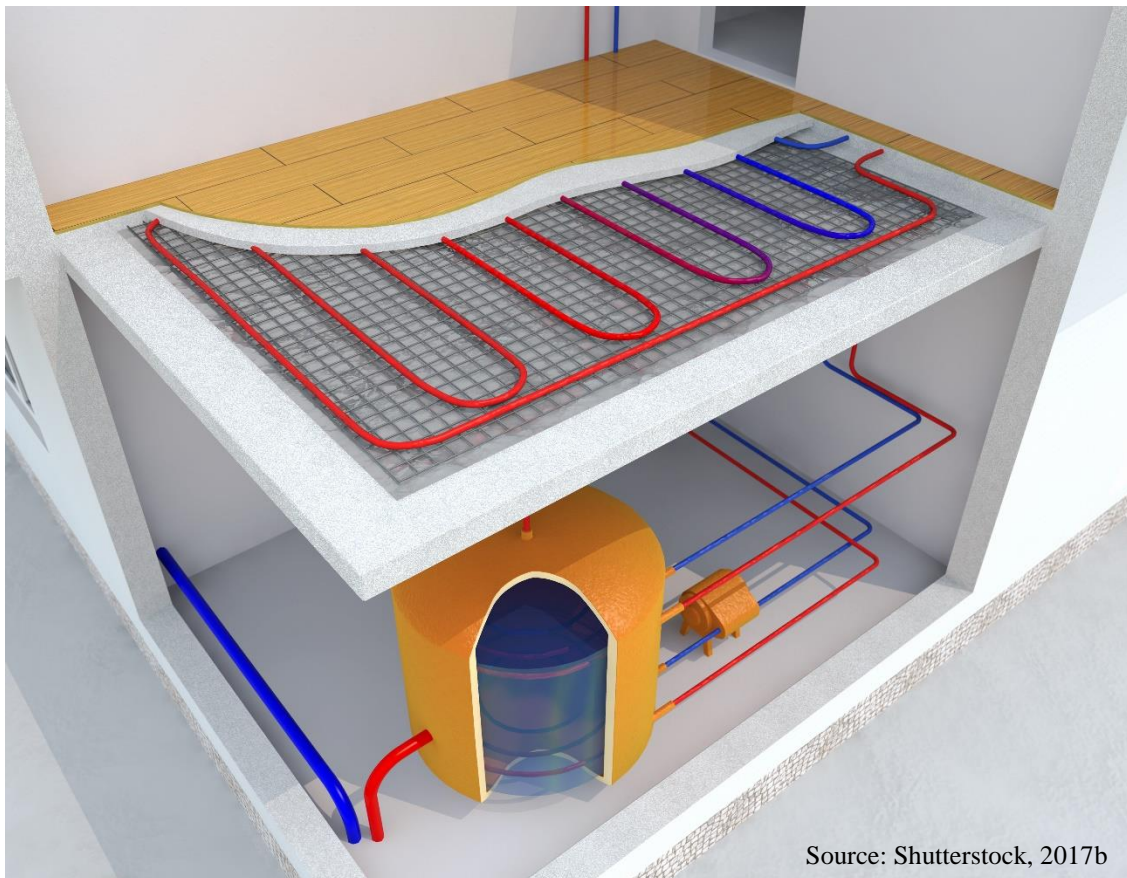

Source: Shutterstock, 2017b

Figure 36: Layout of a Radiant HVAC System

Radiant heating systems supply heat directly to the floor or to panels in the wall or ceiling of a house. The systems depend largely on radiant heat transfer -- the delivery of heat directly from the hot surface to the people and objects in the room via infrared radiation. Radiant heating is the effect you feel when you can feel the warmth of a hot stovetop element from across the room. When radiant heating is located in the floor, it is often called radiant floor heating or simply floor heating (U.S DOE, 2017c)

Radiant cooling cools a floor or ceiling by absorbing the heat radiated from the rest of the room. When the floor is cooled, it is often referred to as radiant floor cooling; cooling the ceiling is usually done in homes with radiant panels. Although potentially suitable for arid climates, radiant cooling is problematic for homes in more humid climates (U.S DOE, 2017d).

2.1.6 Types of Loops

In addition to the heat pump and the distribution system (forced air, or radiant), another very important component to collect and dissipate heat underground is the ground loop. The loop is ideally built from polyethylene pipe which is buried under the ground filled with anti-freeze mixture (U.S DOE, 2017a). The loop system is either open or closed.

i) Open Loop System

In this system, the underground water is drawn from a well, river, or lake through the heat pump and then returned back to complete the loop (U.S DOE, 2017a) as shown in figure 37. It is considered an open loop system as the water is open to the environment (CGC, 2009). It is examined from the figure that a constant groundwater supply from the well is utilized as the heat transfer fluid. Here, the water is pumped from the well and heat is transferred via refrigerant to the heat exchanger. The water is pumped back into the same well through an injection tube (NRCan, 2005).

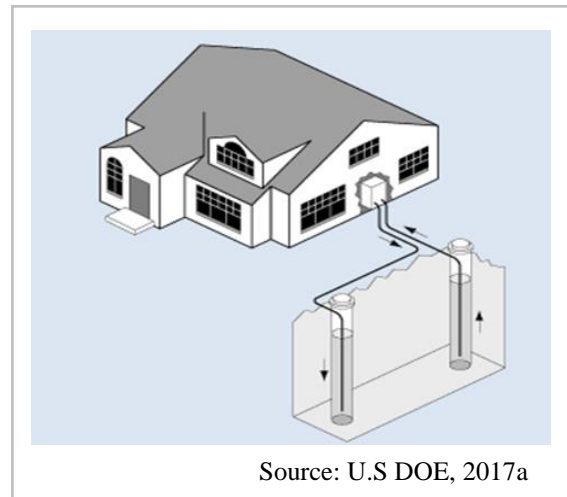

Figure 37: Open system using groundwater from a well as a heat source

ii) Closed Loop

There are three types of closed loop systems: vertical, horizontal, and lake (or pond) which utilize a continuous loop of special buried plastic pipes joined to the indoor heat pump through which an anti-freeze mixture is circulated (NRCan, 2004a).

a) Vertical Closed Loop

It is an ideal choice for the suburban residential homes where space is limited. The high density polyethylene (HDPE) pipes are inserted into the boreholes which are drilled in the soil. These bored holes are 150 mm (6 in.) in diameter, to a depth of 18 to 60 m (60 to 200 ft.). They vary from region to region depending on the geological conditions, building loads, and the size of the

system required. Approximately 270 to 350 ft. of piping is needed for every ton (3.5 kW or 12,000 Btu/h) of heat pump capacity (NRCan, 2004a) as shown in figure 38.

The rigs are used to drill boreholes. After the insertion of the pipes, the boreholes are backfilled and grouted. The horizontal underground supply and return header pipes are coupled with the pipes in the vertical boreholes. The anti-freeze mixture is in the header pipes which moves to and from the heat pump (NRCan, 2005; and NRCan, 2004a).

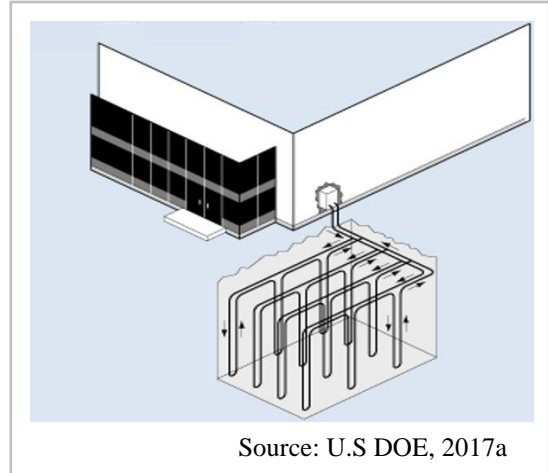

Figure 38: Layout of a vertical ground loop piping – Limited space

b) Horizontal Closed Loop

The horizontal arrangement is more suitable for regions where space is not restricted i.e. rural areas. The HDPE pipes are placed in trenches as shown in figure 39 normally between the ranges of 3 to 6 ft. in depth. It is also subjected to the number of pipes in a trench (U.S DOE, 2017a).

Best practices indicate about 400 to 600 ft. of pipe are required per ton of heat pump capacity (NRCan, 2004a). The configuration of the horizontal loop piping varies depending upon the space area. If the space is limited then ‘slinky’ or ‘spiral’ type arrangement could be used to fit more piping into the trench. The horizontal loop installation is less expensive as compared to the vertical drilling and better suited to residential applications *i.e.* detached and semi-detached houses (NRCan, 2005).

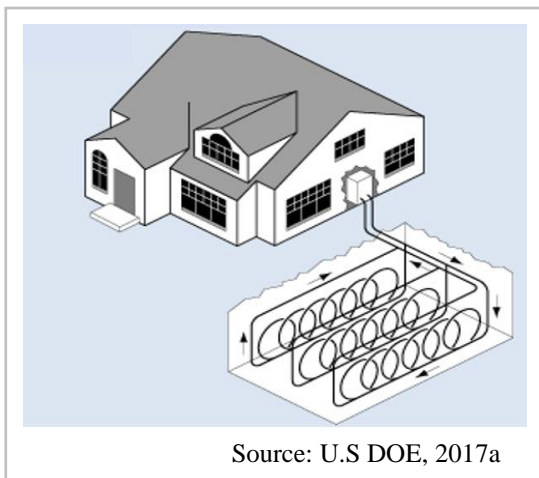

Figure 39: Horizontal ground loop for a residential facility

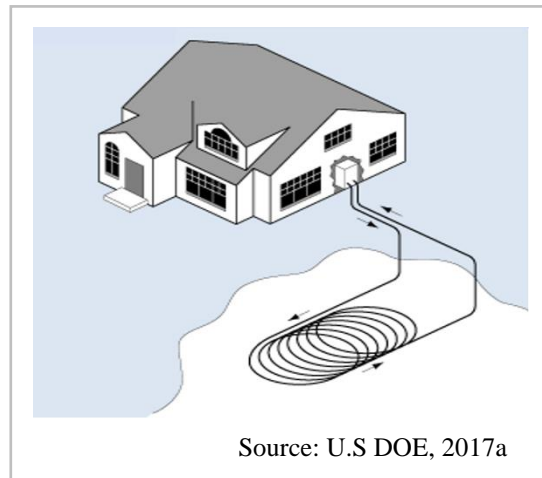

Figure 40: Pond/Lake closed loop system

c) Pond/Lake Closed Loop

This is the lowest cost option available but not feasible all the time. It can be evaluated from figure 40 that a supply of HDPE pipe line is passed underground from the facility to the water source. The pipes are coiled into circles about 8 ft. under the surface to avoid freezing. The heat source should meet the criteria of quality, minimum volume and depth for optimal GSHP performance (U.S DOE, 2017a).

2.1.7 Technical Configuration/Specifications and Economic Evaluation

The ground source heat pump system (GSHPs) must be optimized for effectiveness. There are several factors that needs to be properly considered in order to install a technically feasible GSHP unit in a residential household. An optimized system will not only lead to a longer lifespan but also results in high energy savings in the entire life cycle costing (LCC) for the end user.

2.1.7.1 Ground and Weather Characteristics

Key factors which strongly influence the design, installation and subsequent operating costs of GSHPs are as follows:

Soil and Rock Type

In GSHP technology, the extraction and deposition of thermal energy from the ground is achieved by using underground HDPE pipes which contains anti-freeze mixture. The heat is transferred from the soil and rock to the anti-freeze solution through heat conduction and moisture migration. Therefore, the operation of heat transfer is strongly dependent on the soil and rock type, temperature, and moisture gradients (Hepbasli et al., 2003; Bakirci, 2010; Leong, 1998). The thermal conductivity and diffusivity plays a significant role in the operating costs of GSHPs (U.S DOE, 2001). The vertical and horizontal loops generally require different soil type specifications as a result of different depths. Table 1 shows the soil and rock classification for the design of GSHPs.

i) Thermal Conductivity

It a measure of the quantity of heat transmitted per unit area, per unit temperature gradient and in unit time, under steady state conditions (Feuvre, 2007). In other words, it is a process in which the material has the ability to transmit heat from high to low temperature regions of a substance. It is measured in either W/m-K or Btu/hr-ft.-°F (Ysasi et al., 2014). The thermal conductivity of heat transfer fluids plays a significant role in establishing energy efficient heat transfer equipment (Choi & Eastman, 1995). There are certain factors which can influence the thermal conductivity

such as the density of material, moisture of material, and ambient temperature. The thermal conductivity will generally increase for these factors at higher levels.

Table 1: Soil and Rock Classification					
#	Soil Type	Soil Description	Conductivity	Diffusivity	Moisture Content
			Btu/hr-ft.- °F	ft ² /day	
1)	Dense Rock	Rare dense rock associated with only a few areas - vertical	2.00	1.20	-
2)	Average Rock (same as WFEA ² avg. rock)	Common medium rock densities associated with most areas - vertical	1.40	0.96	-
3)	Saturated Sand/Gravel (same as WFEA saturated soil)	Less common sand/gravel associated with overburden in vertical loops	1.44	0.86	20%
4)	Saturated Silt/Clay	Common heavy soils associated with overburden in vertical loops	0.96	0.61	30%
5)	Damp Sand/Gravel	Less common sandy soils associated with horizontal loops	0.90	0.64	10%
6)	Damp Silt/Clay (same as WFEA heavy damp)	Common heavy soils associated with most horizontal loops	0.75	0.60	15%
7)	Dry Sand/Gravel	Rare dry sandy soils associated with only a few horizontal loops	0.35	0.42	5%
8)	Dry Silt/Clay	Rare dry clay soils associated with only a few horizontal loops	0.50	0.48	5%
9)	Horizontal Bore - Saturated to Damp Silt/Clay	Typical soil variation at the 10-20 ft. (3-7 m) depth - horizontal boring	0.86	0.61	15 – 30%

Source: EPRI, 1989; GeoSmart Design Studio, 2016

² WFEA = Water Furnace Energy Analysis (Sullivan, 1997)

ii) Thermal Diffusivity

The ratio of thermal conductivity to volumetric specific heat capacity is known as thermal diffusivity. It is measured in either m^2/s or ft^2/day (Banks, 2012). It is a measure of ground thermal conduction in relation to thermal capacity. The higher the value of the thermal diffusivity, the more rapidly the material will adjust temperature to the surrounding environment as heat conduction happens faster relative to thermal mass (Feuvre, 2007).

iii) Soil Temperature Variations

Geothermal energy is derived from heat in the Earth's interior. The Earth's heat is generated dominantly by radioactive decay of three key elements *i.e.* Uranium, Thorium, and Potassium, in addition to primordial heat related to the original formation of the planet (Grasby et al., 2012). This internal heat flows naturally to the surface by conduction and creates a gradient where temperature of the solid earth rises with increasing depth (Majorowicz & Grasby, 2010). The thermal characteristic of the ground is that a few meters of surface soil insulate the Earth and groundwater below which decreases the amplitude of the disparity in soil temperature as compared to the temperature in the air above the ground (NRCan, 2005). The following factors have a strong impact on the performance and costs of GSHP technology.

1. **Deep Earth Temperature:** It is the average annual ground temperature for a specific city at a depth of 2 cm, roughly corresponds to the constant deep earth temperature (below 25') and the well water source temperature for the selected cities of Ontario (GeoSmart Design Studio, 2016). This can be seen in Figure 41.
2. **Annual Swing Temperature:** It is the degree swing in ground temperature above and below the deep earth temperature at 2 cm. For example in Fort Wayne, IN the average ground temperature (deep Earth temperature) is 53°F with a surface swing of 24.3°F . At 2 cm depth, the ground will average 53°F but get as high as 76.3°F in the summer and as low as 29.7°F in the winter. At depths below 25' the ground will remain a constant 53°F (GeoSmart Design Studio, 2016). The annual swing temperatures for the selected cities of Ontario is shown in Figure 42.
3. **1% Cooling Design Temperature:** It is the outdoor air temperature at the upper 1% of the annual hours of cooling. The cooling equipment should be sized to maintain the structure at set-point at this outdoor air temperature with the heat gain associated with it. At this outdoor temperature the cooling equipment will generally run continuously to maintain the set-point. In other words, the cooling equipment is sized to handle 99% of the heat gain of the structure (GeoSmart Design Studio, 2016). The data for the cities of Ontario can be seen below in Figure 43.

4. **97% Heating Design Temperature:** It is the outdoor air temperature at 97% of the annual hours of heating. The heating equipment should be sized to maintain the structure at set-point at this outdoor air temperature with the heat loss associated with it. At this outdoor temperature the heating equipment will generally run continuously to maintain the set-point. Past this temperature, auxiliary heat should be used to maintain or catch up to maintain the set-point temperature (GeoSmart Design Studio, 2016). The stats for the selected cities of Ontario can be viewed in Figure 44 below.
5. **Ground Lag Time:** The ground temperature changes will typically lag 25-40 days behind the air temperature. For example in Fort Wayne, IN the ground temperature will peak in the summer approximately 35 days (Sept 20) after the outdoor air temperatures peak (Aug 15) (GeoSmart Design Studio, 2016).

Likewise in the winter the ground will peak approximately 35 days (Feb. 20) after the minimum air temperatures (Jan. 15) (GeoSmart Design Studio, 2016). The ground lag time for the selected cities of Ontario can be seen in Figure 45.

6. **Degree Days (D – D):** It is a measurement of heat units over time. It is the amount of heat which accumulates above a specific baseline temperature during a 24 hour period. Every time, the average temperature goes above the specific baseline temperature during the 24 hour time frame, one degree day happens. Therefore, it can be concluded that several degree days can accumulate in 24 hours (Herms, 2004). The formula to calculate the degree days is as follows:

$$D-D = [(Daily\ maximum\ temperature) + (Daily\ minimum\ temperature)/2] - Baseline\ Temperature$$

For example, if the daily high temperature in a city is 75°F and daily low is 47°F then it would accumulate 11 degree – days by considering 50°F as the baseline temperature (Murray, 2008). The data for the selected cities of Ontario can be analyzed in Figure 46 (GeoSmart Design Studio, 2016).

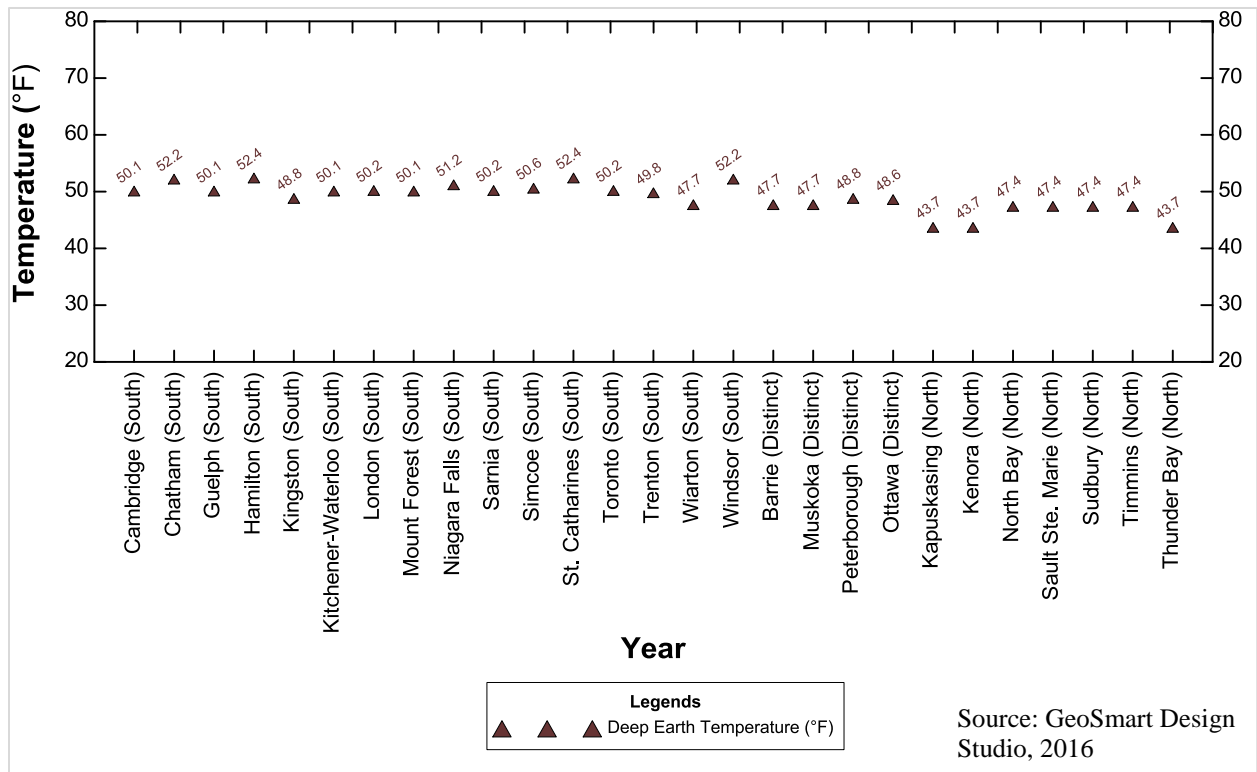

Figure 41: Deep Earth Temperature of the Selected Cities in Ontario

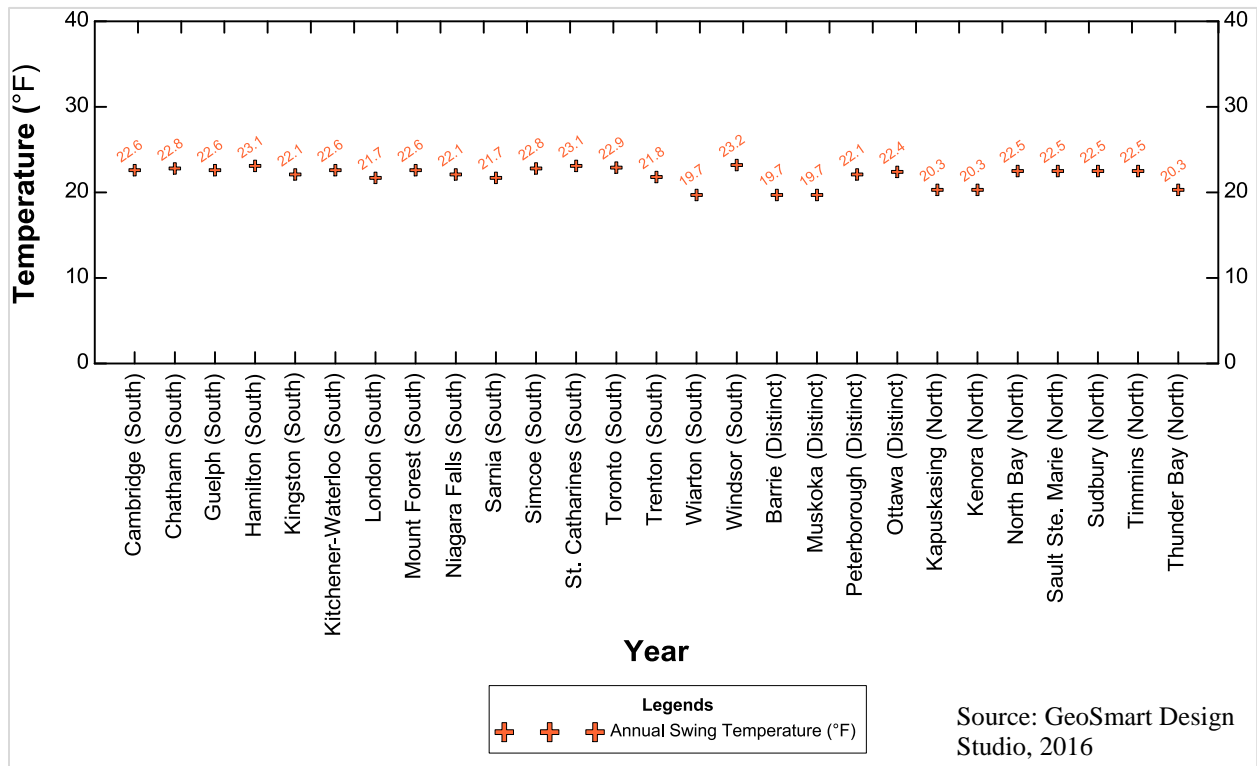

Figure 42: Annual Swing Temperature of the Selected Cities in Ontario

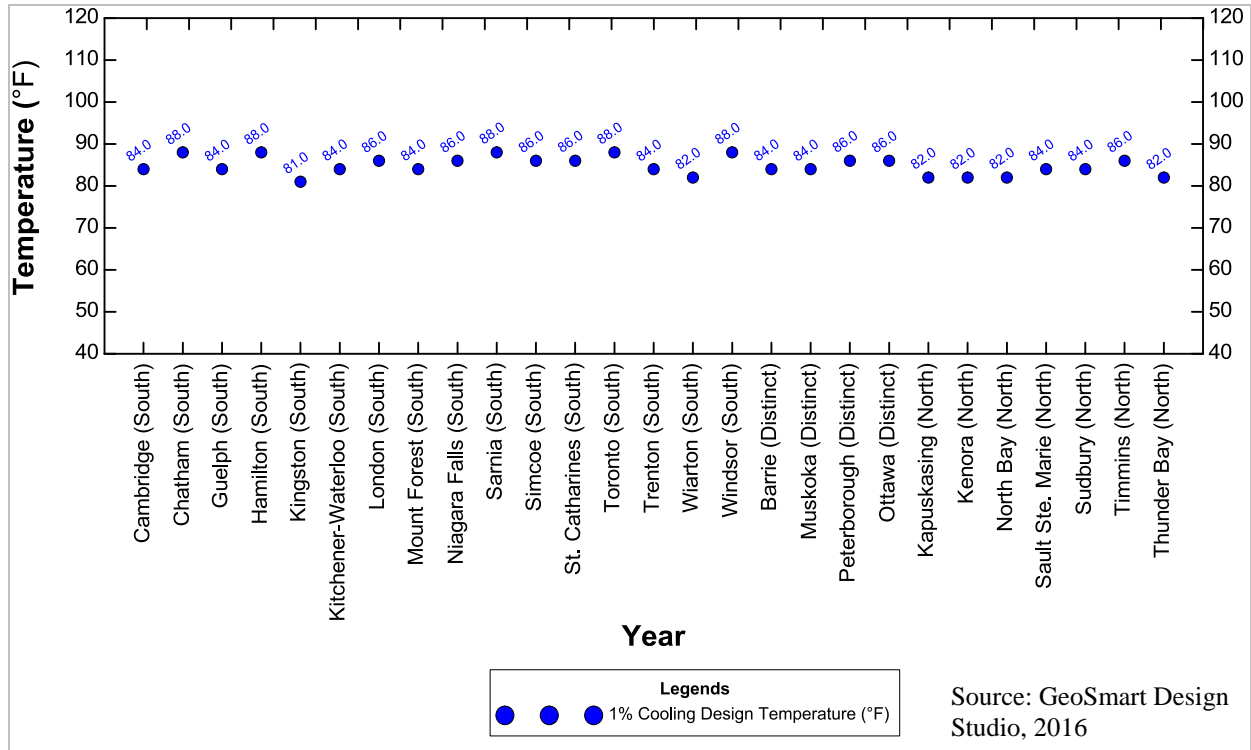

Figure 43: 1% Cooling Design Temperature of the Selected Cities in Ontario

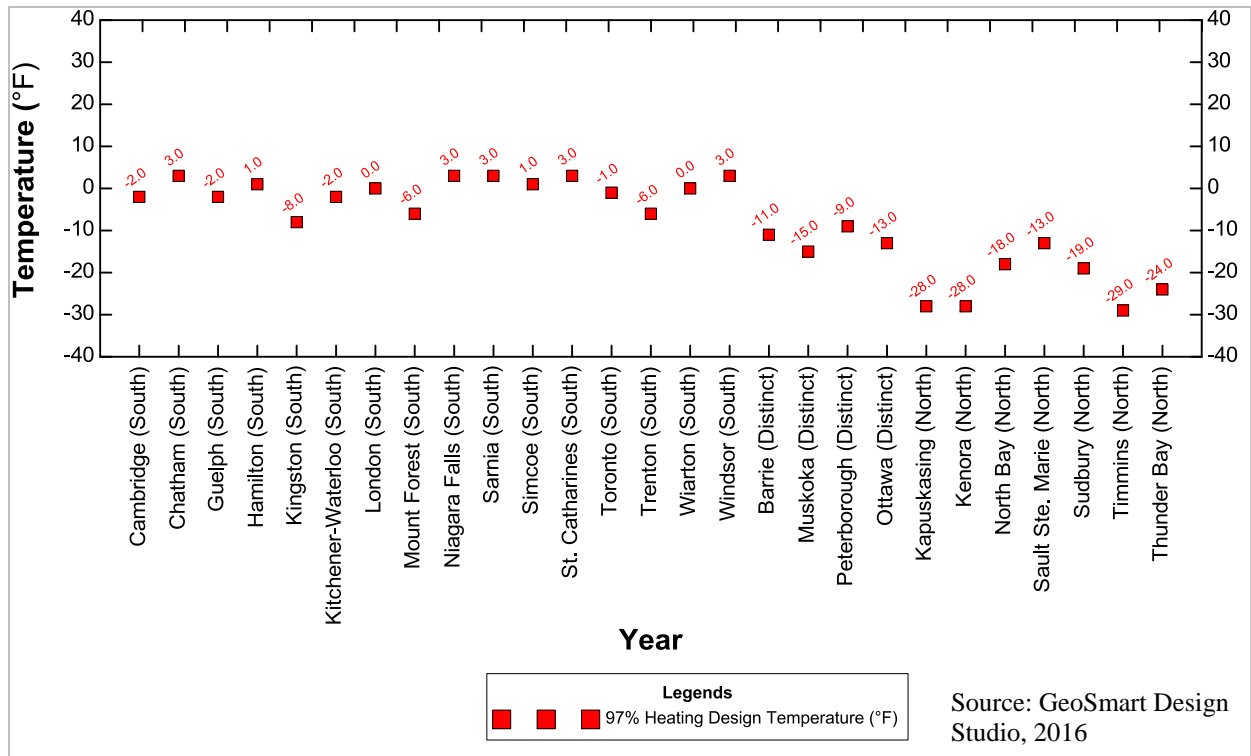

Figure 44: 97% Heating Design Temperature of the Selected Cities in Ontario

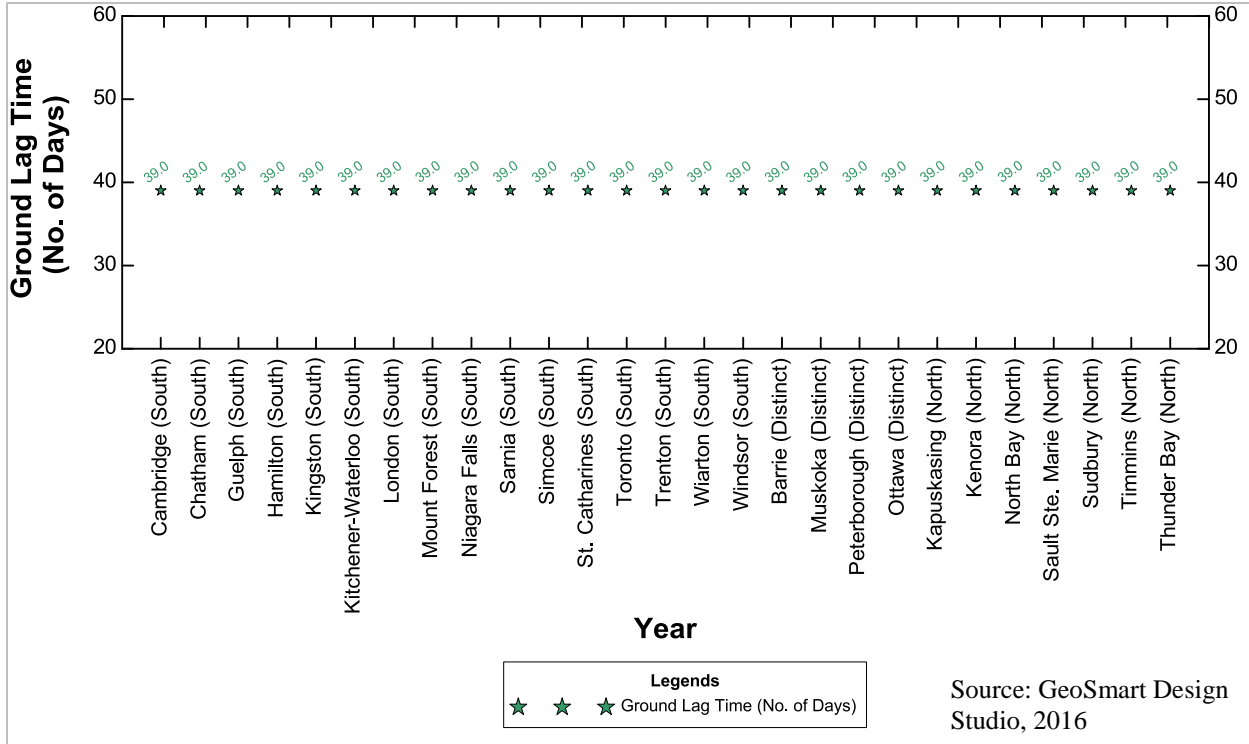

Figure 45: Ground Lag Time of the Selected Cities in Ontario

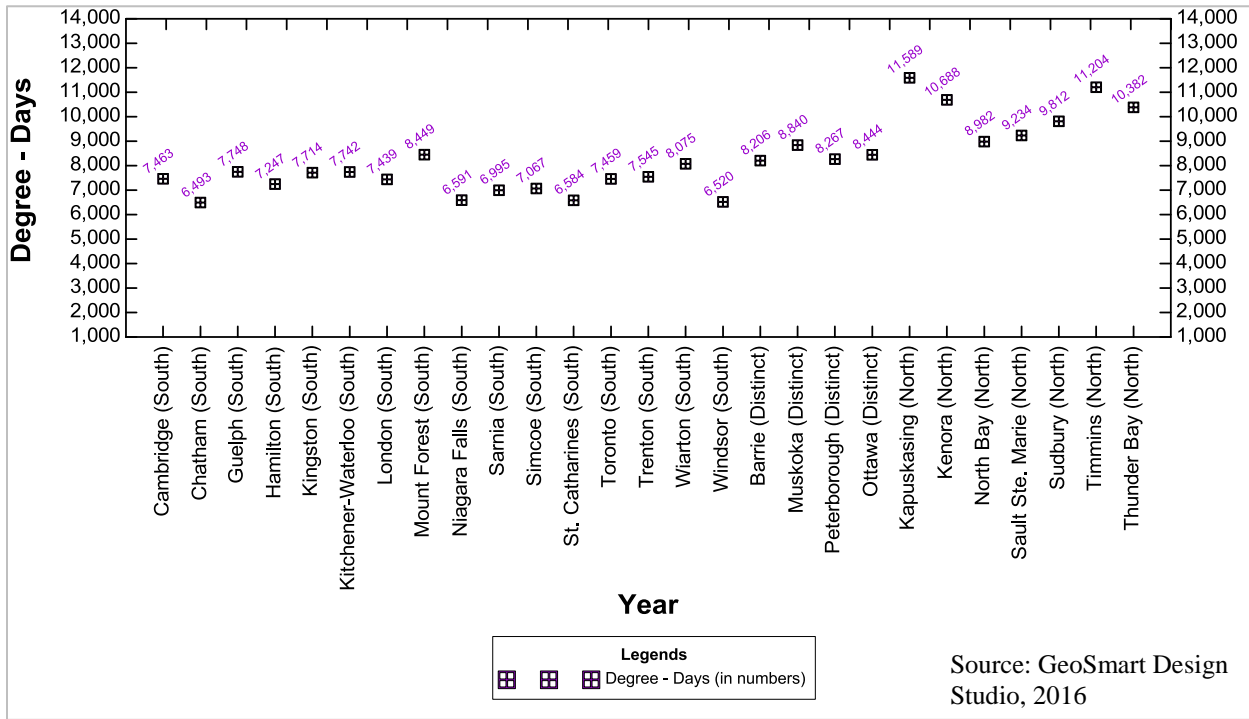
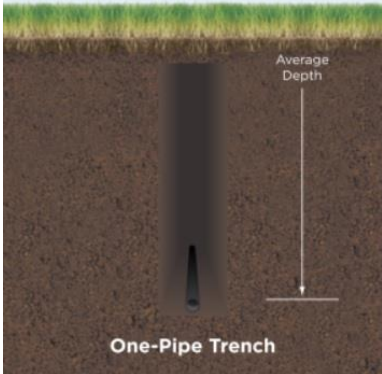
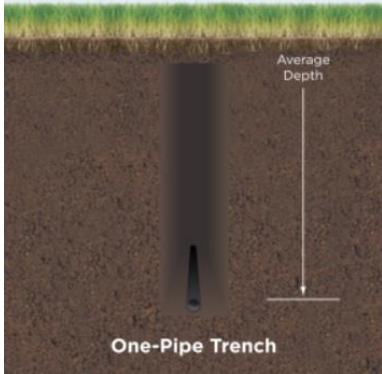
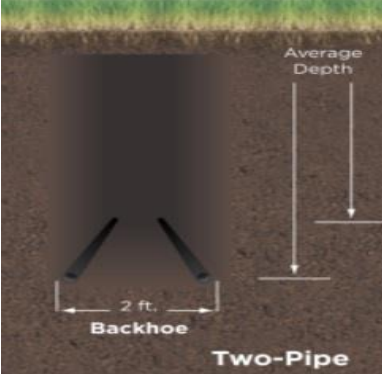
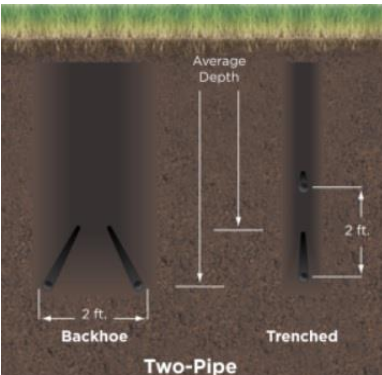
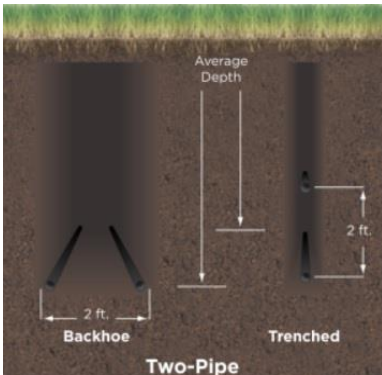
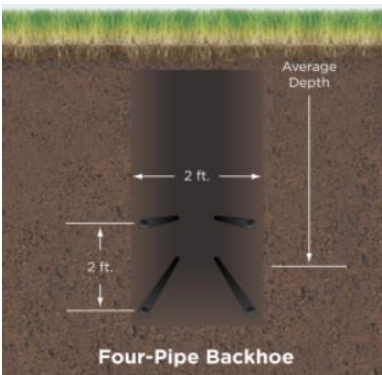
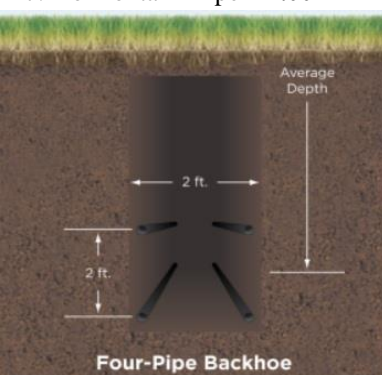
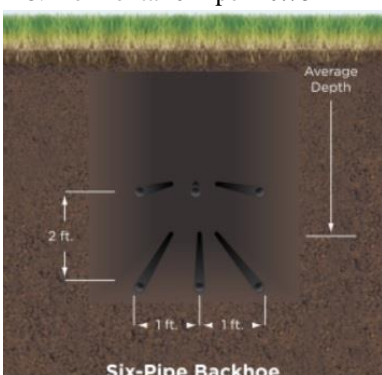
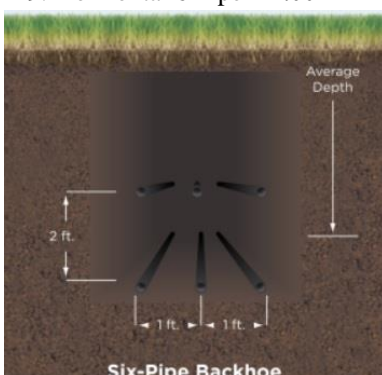

Figure 46: Degree - Days of the Selected Cities in Ontario

iv) Ground Loop Arrangements

There are different kinds of ground loop arrangements possible for the residential households. A snapshot of these arrangements can be seen in Table 2.

Table 2: Ground Loop Arrangements Variations – Ground Source Heat Pump Systems		
<p>1. Horizontal 1 Pipe – 1.00” PE</p>  <p>Average Depth</p> <p>One-Pipe Trench</p>	<p>2. Horizontal 1 Pipe – 1.25” PE</p>  <p>Average Depth</p> <p>One-Pipe Trench</p>	<p>3. Horizontal 2 Pipe – 0.75” PE</p>  <p>Average Depth</p> <p>2 ft. Backhoe</p> <p>Two-Pipe</p>
<p>4. Horizontal 2 Pipe – 1.00” PE</p>  <p>Average Depth</p> <p>2 ft. Backhoe</p> <p>2 ft. Trenched</p> <p>Two-Pipe</p>	<p>5. Horizontal 2 Pipe – 1.25” PE</p>  <p>Average Depth</p> <p>2 ft. Backhoe</p> <p>2 ft. Trenched</p> <p>Two-Pipe</p>	<p>6. Horizontal 4 Pipe – 0.75” PE</p>  <p>Average Depth</p> <p>2 ft.</p> <p>2 ft.</p> <p>Four-Pipe Backhoe</p>
<p>7. Horizontal 4 Pipe – 1.00” PE</p>  <p>Average Depth</p> <p>2 ft.</p> <p>2 ft.</p> <p>Four-Pipe Backhoe</p>	<p>8. Horizontal 6 Pipe – 0.75” PE</p>  <p>Average Depth</p> <p>2 ft.</p> <p>2 ft.</p> <p>1 ft. 1 ft.</p> <p>Six-Pipe Backhoe</p>	<p>9. Horizontal 6 Pipe – 1.00” PE</p>  <p>Average Depth</p> <p>2 ft.</p> <p>2 ft.</p> <p>1 ft. 1 ft.</p> <p>Six-Pipe Backhoe</p>

Source: GeoSmart Design Studio, 2016

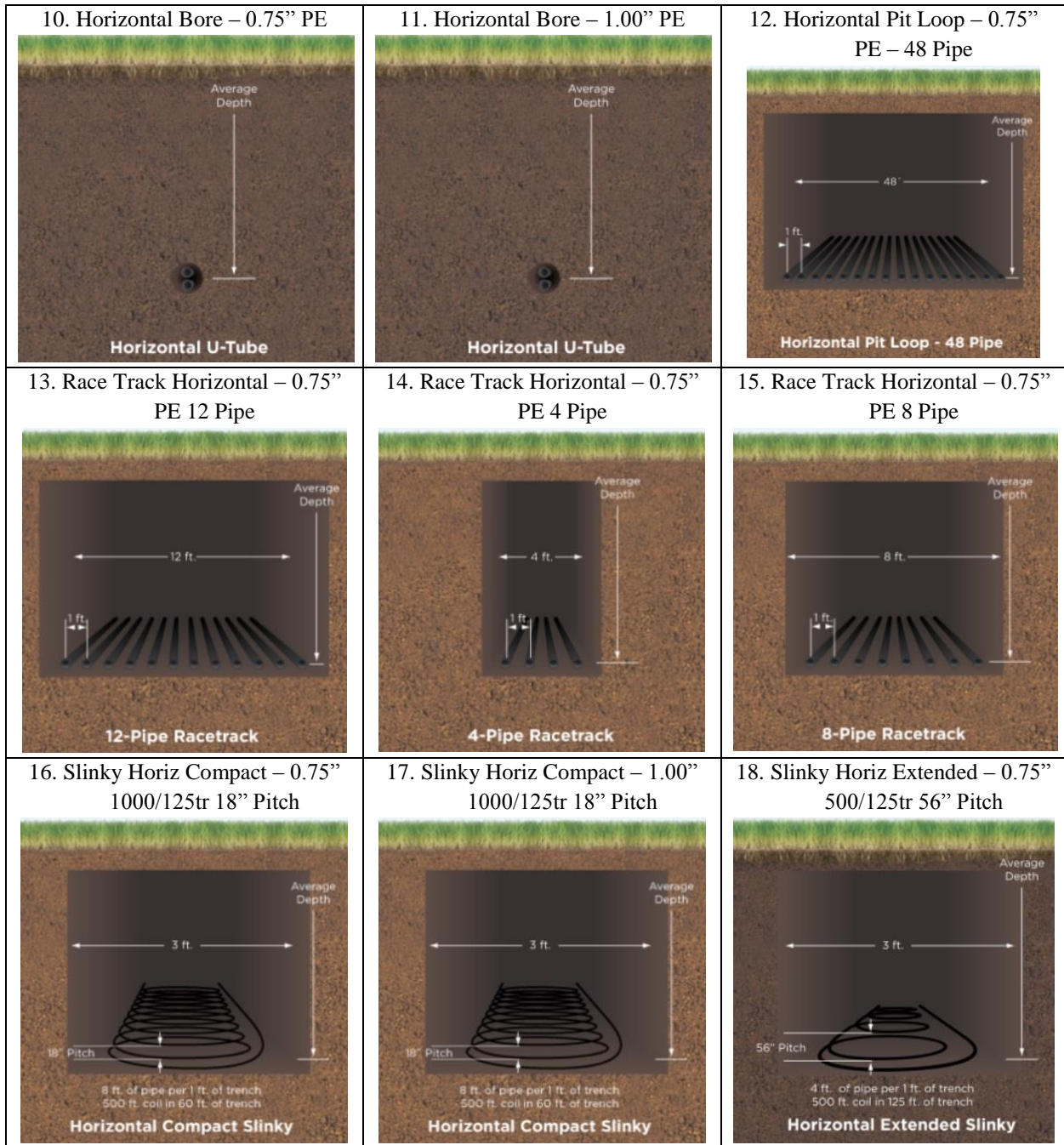

Source: GeoSmart Design Studio, 2016

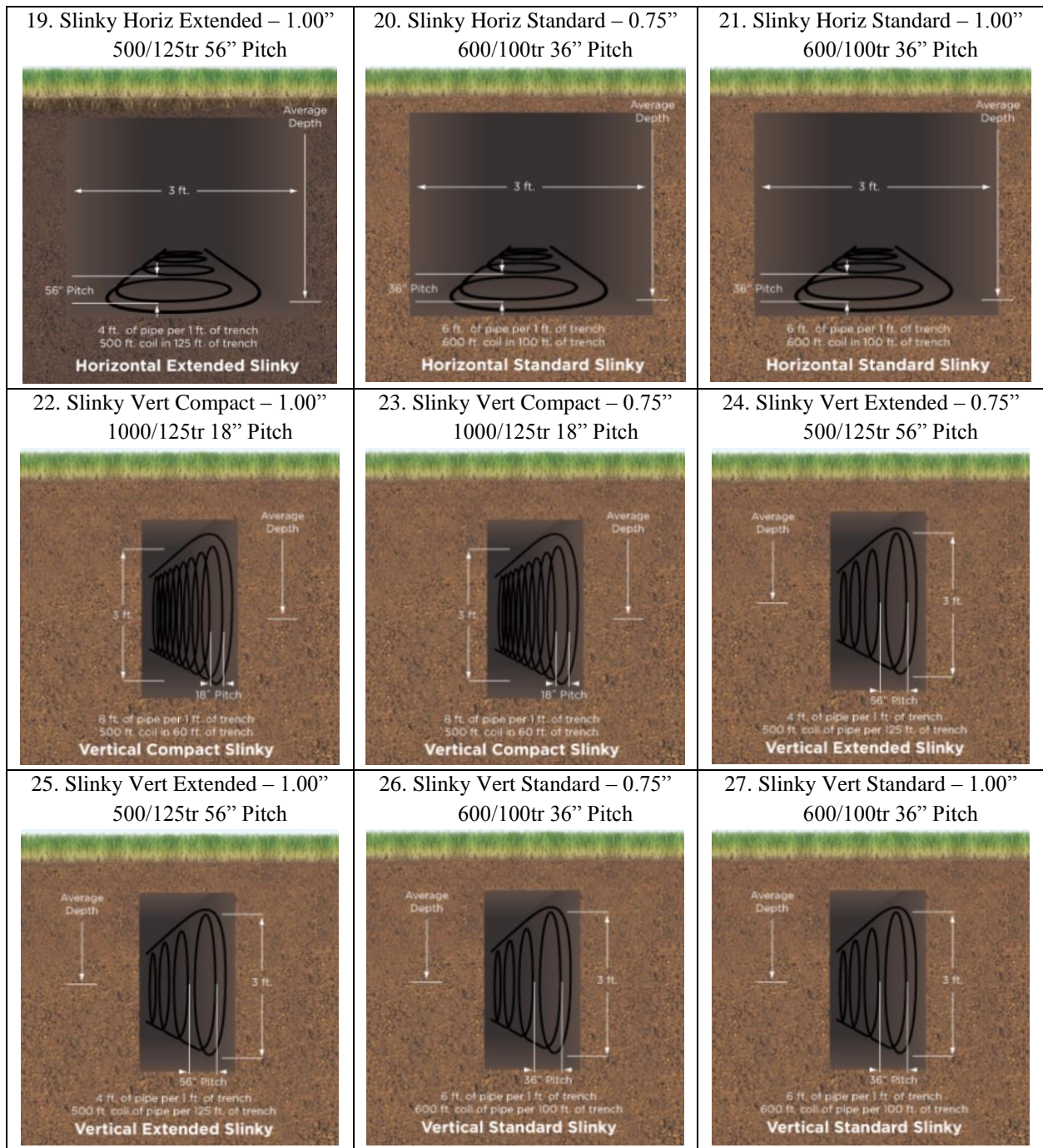

Source: GeoSmart Design Studio, 2016

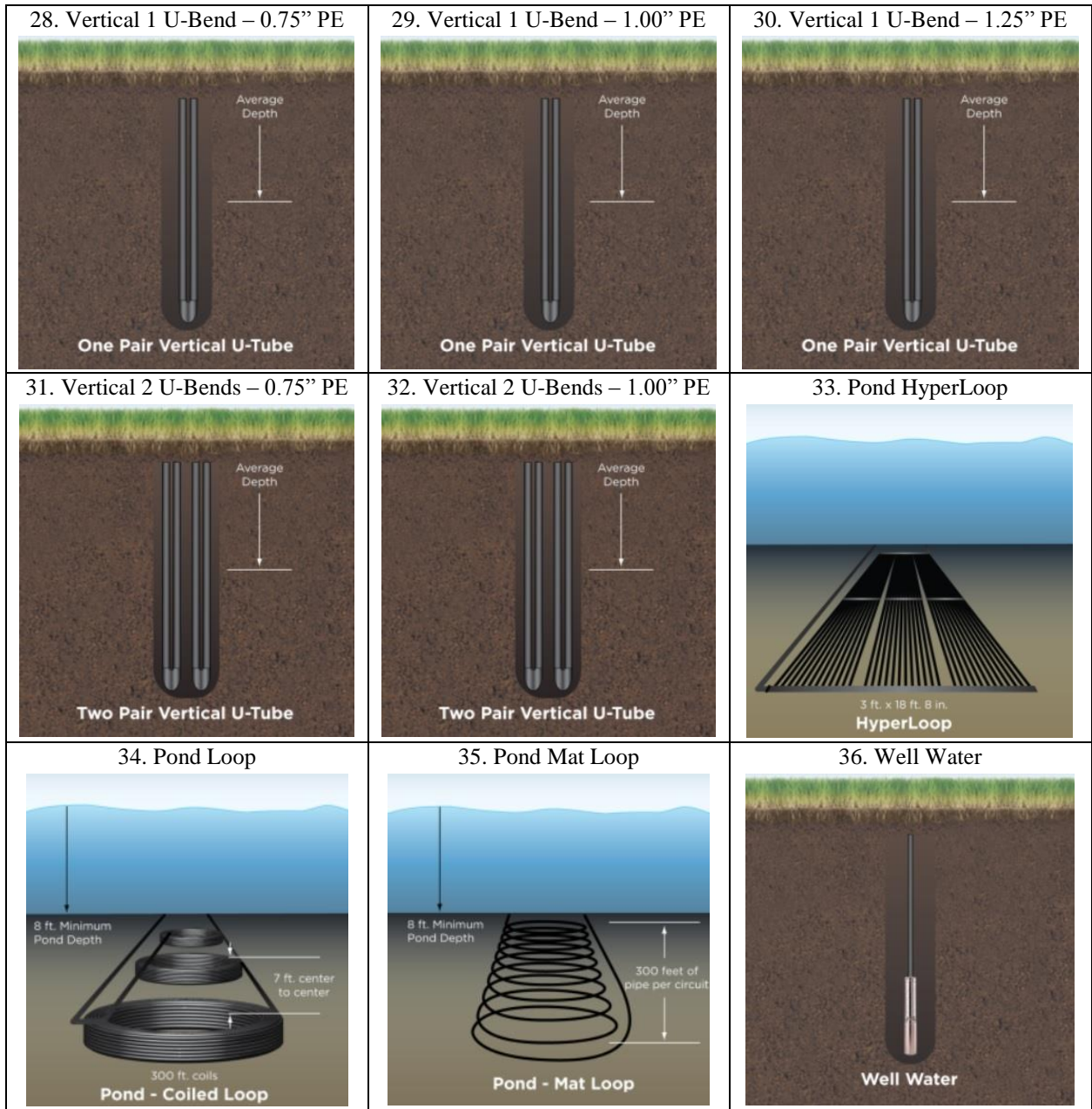

Source: GeoSmart Design Studio, 2016

2.1.7.2 Calculations of Heating and Cooling Loads

The heating and cooling loads are the measure of the energy required to be added/removed from the space of the residential household by the HVAC system in order to produce the comfort or desired space temperature (Burdick, 2011). The values of the heating and cooling loads in Btu-h helps in selecting the equipment size and duct designing to provide conditioned air to the all the floors of the residence. In addition, these values have a direct impact on the costs & efficiency of the HVAC equipment and comfort level & air quality of the living space (Burdick, 2011). Table 2 provides the range of values for the heating and cooling loads of the detached, semi-detached, and apartment dwellings with respect to the international standards of HVAC systems. These values are the rule of thumbs on which contractors rely to estimate the size of the HVAC equipment (Bell, 2007). They vary from region to region and can be influenced by a number of factors such as the type of insulation, window and door sizes/direction, wall & ceiling area (length, height, and width), number of occupants, and weather conditions (Bell, 2007).

Table 3: Heating and Cooling Loads Values – Rule of Thumb		
	Heating Loads	Cooling Loads
	Btu-h	Btu-h
Detached House	25 – 40	17 – 24
Semi – Detached House	25 – 40	17 – 24
Apartments	25 – 40	27 – 34

Source: Bell, 2007

These values act as a best practice for the international HVAC standards. The geothermal industry experts strongly believe that the cooling loads have gone up in the past 25 years because of climate change and lifestyle activities of the Ontarians (Marco, 2016).

There are smart components such as a thermostat that could be used to control the temperature of a conditioned space in a facility. This would result in energy savings.

Thermostat

It is a device which automatically regulates the temperature of the living space in a building facility. A thermostat results in better overall HVAC performance and provides healthier comfort level for the occupants (Lamin, 2011). It is common today to have programmable thermostats in new homes and in many existing homes as well. The sensor technology generally consists of thermistors with a heat or cool anticipation function. These thermostats generally have three or four wires connected to their terminals for sending and receiving heating, cooling, and fan signals to and from indoor air handling unit. In older homes, bimetallic switching thermostats are still used (NREL, 2012).

In a field test setting, a thermistor is commonly mounted close to the thermostat to monitor the thermostat sensing temperature. Coupled with the indoor air handler power and/or outdoor condensing unit power reading, and/or the furnace gas flow or supply and return air temperature readings, thermostat setpoints can be easily concluded. In simple heating and cooling air handling units with cycling on/off supply fans, the indoor fan status alone with a thermistor mounted next to the air handler can indicate the thermostat setpoints (NREL, 2012).

Understanding the thermostat setpoint is critically important in field tests since the setpoint is the main driver for house heating and air conditioning system. Many energy saving measures are set around thermostat night setback, unoccupied setback, or pre-cooling to take advantage of house thermal mass, so controlling and monitoring the thermostat setpoint is a central activity for any field test looking at HVAC systems (NREL, 2012).

i) Heating Set-point Temperature

It is the set temperature on the thermostat for heating. If the temperature falls below this point then the thermostat will activate the heating system and shuts it off when the warm air goes up past this set-point (CMHC, 2014). It is recommended that the heating set-point shouldn't be less than 70°F and the ideal value for Ontario is 72°F (GeoSmart Design Studio, 2016; Marco, 2016).

ii) Cooling Set-point Temperature

It is the set temperature on the thermostat for cooling. The cooling system will start to operate as soon as the temperature goes above this set-point and turns off when the room temperature falls below the desired temperature set out in the thermostat (CMHC, 2014). A cooling set-point temperature of no more than 75°F is suggested. Most contractors advise a value of 74°F for the province of Ontario (GeoSmart Design Studio, 2016; Marco, 2016).

2.1.7.3 Economic Evaluation

i) Installation Cost

According to a report by Canadian Geoechange Coalition (CGC), the average price of a vertical GSHP system sold in 2010 was \$8,132 per ton in Ontario compared to \$6100 per ton for a GSHP system with a horizontal arrangement. The total average price in 2010 for a 4-ton system in Canada was \$31,544 (\$7,886 per ton) for a GSHP system with a vertical arrangement and \$24,464 (\$6,116 per ton) for a system with a horizontal arrangement (CGC, 2009).

ii) Operating Costs

The operating costs of a GSHP system are usually considerably lower than those of other heating systems, because of the savings in fuel (NRCan, 2004a). However, the relative savings will depend on the users mix of electricity, oil or natural gas, and on the relative costs of different energy sources dependent on geography. A heat pump reduces gas or oil consumption but increases electricity use. If you live in an area where electricity is expensive, your operating costs may be higher. The payback on an investment for the GSHP system may vary between 5 – 15 years.

iii) Thermodynamics of GSHP system and its implications on the Operating Cost

The energy efficiency (considering the first law of thermodynamics) of a system is the ratio of useful output energy from the system to the energy input to the system, and is called the coefficient of performance (COP) (Hepbasli, 2005). GSHP systems are generally analyzed on the basis of vapour compression cycle of thermodynamics (Figure 1), and their thermodynamic efficiency can be evaluated based on the COP. The energy efficiency of a GSHP system can be defined as (Hepbasli, 2005):

$$\text{COP}_{\text{GHSP, sys}} = \frac{\dot{Q}_{sh}}{\sum \dot{W}_{\text{input}}} \quad (6)$$

where \dot{Q}_{sh} is the space heating load rate, and $\sum \dot{W}_{\text{input}}$ is the total work input rate to the system. Focusing on the GSHP unit itself, the efficiency can be defined as (Hepbasli, 2005):

$$\text{COP}_{\text{GHSP, unit}} = \frac{\dot{Q}_{sh}}{\dot{W}_{\text{compressor}}} \quad (7)$$

where $\dot{W}_{\text{compressor}}$ is the work input rate to the compressor of the GSHP unit.

Efficiency from the standpoint of the second law of thermodynamics can be expressed in terms of exergy (i.e., energy available to perform useful work) (Hepbasli, 2005). The exergy efficiency of the GSHP unit can be defined as (Hepbasli, 2005):

$$\varepsilon_{\text{GHSP, unit}} = \frac{\text{COP}_{\text{Carnot}}}{\text{COP}_{\text{GHSP,unit}}} \quad (8)$$

where COP_{Carnot} is the maximum heating coefficient of performance obtained from the Carnot cycle for an ideal heat pump system operating between the low and high temperature reservoirs at T_L and T_H , respectively, and is defined as

$$COP_{Carnot} = \frac{T_H}{T_H - T_L} \quad (9)$$

It is evident from the foregoing equations and Figure 1 that the performance of GSHP systems depends on the temperature of the conditioned space T_H (typically, 68-72°F), the ground temperature T_L (45-50°F), the space heating load (\dot{Q}_{sh}), and the work input to the system ($\sum \dot{W}_{input}$ or $\dot{W}_{compressor}$). The space heating load (which is related to the heat loss to the atmosphere from the conditioned space) depends on the difference in temperatures between that of the conditioned space (buildings or facilities) and the outside air, and on the size and insulation of the conditioned space. Thus, the size and type of buildings, the number and size of openings (doors and windows), the number of occupants, etc., affect the space heating load. The more the demand (i.e., \dot{Q}_{sh}), the more the input work (i.e., $\sum \dot{W}_{input}$ or $\dot{W}_{compressor}$) required to maintain a steady level of performance of the GSHP systems. The work input to GSHP systems (typically, in the form of electrical energy) is directly related to the cost of operation. Therefore, the operation cost of GSHP systems depends on the geographic location of the unit (which influences the air and ground temperatures), and the size and types of buildings.

2.1.8 Meta-Analysis of System Performance and Economics of GSHPs

The literature strongly suggests that GSHPs have proven to be an efficient and economically viable alternative to conventional systems for heating and cooling services (Aste et al., 2013; Kalinci & Hepbasli, 2009; and Chua et al., 2010).

2.1.8.1 General Technical and Economic Analysis

Natural Resources Canada (NRCan) has conducted a techno-economic analysis of heat pump and cogeneration systems for a typical midrise apartment in the Canadian climate in the city of Calgary and Montreal. Out of the the five systems selected for comparison include: (i) a conventional mid-rise apartment heating and cooling system, (ii) boiler/cooling tower water source heat pumps, (iii) ground source heat pumps, (iv) a cogeneration unit sized to meet the heating load of the building, and (v) a cogeneration plus electric driven heat pump system, the ground source heat pump system demonstrated the greatest secondary energy savings (Kegel, Tamasauskas, Sunye, & Giguere, 2014). Another study demonstrates that hybrid ground source heat pump system combined with solar thermal collectors is a feasible choice for space conditioning for heating dominated houses in the city of Milton (Ontario) in Canada (Rad et al., 2013).

A study on ten buildings in Southern Ontario with respect to the economic and environmental effects of GSHPs evaluated the CO₂ emissions of optimally-sized (based on economic factors) hybrid GHSPs and those of non-hybridized GSHPs. Both the optimally-sized hybrid GHSPs, and the non-hybridized GSHPs significantly reduce CO₂ emissions compared to the use of conventional natural gas/electrical systems (Nguyen et al., 2016). The study has also suggested that the entering fluid temperature (EFT) to heat pump plays a crucial role in determining the efficiency of the heat pump and total costs of the system. In addition, the ground layers and single or double U-tube configuration affects the borehole heat transfer performance (Nguyen et al., 2016).

A study by Benli was done on a facility in the greenhouse district of Firat University and suggested that GSHPs has a better performance than conventional air – source heating systems in low environment conditions *i.e.* temperature of the environment is lower than the temperature of the ground (Benli, 2011). Another study was done to assess the performance of vertical GSHPs for cold climatic condition of the province of Erzurum in Turkey. The results showed that the average heat pump COP and overall systems COPS values are approximately 3.0 and 2.6 in the coldest months of heating season (Bakirci, 2010). Hepbasli and Kalinci conducted a research on heat pump water heating systems (HPWHs) by using energy and exergy analysis methods. It's been revealed at the end of the study that the primary advantage of HPWHs is the increased operational efficiency over conventional electric water heating systems (Kalinci, & Hepbasli, 2009).

A techno-economic analytical comparison of the performance of air-source and horizontal-ground-source air-conditioners in South Africa. It was concluded that ground source systems are more viable than air-source systems with respect to the financial parameters such as payback period, net present value, and internal rate of return of ground source systems at various depths (Petit, & Meyer, 1997).

In 2012, a study came out which investigated alternative energy saving design concepts for a typical new detached house design in Finland. It was a two storey house which has a lounge, kitchen, dining room, four bedrooms, entrance hall, utility room, two walk-in closets, two WCs and a sauna plus shower room. The interior space (net floor area) of the house was about 1,512 square feet. The financial viability of different design concepts *i.e.* energy consumption modification were analyzed for the house by running different simulations. It was found out that the installation of heat pump in the house with high energy consumption results in a payback period of 7 years whereas for ultra – low energy design, the payback period was over 13 years (Saari et al., 2012).

An experimental study of a closed loop vertical GSHPs was performed where a GSHP was installed in a 700 square foot room in the solar energy institute at Ege University in Izmir, Turkey. It has a livable floor area of 32,292 square feet. The heating and cooling loads of the room were 12,966 Btu/h and 14,331 Btu/h at design conditions respectively. Izmir has 568 cooling degree days at base temperature of 22°C and 1,226 heating degree days at base temperature of 18°C. The results of the study showed that certain parameters can strongly influence the performance and installation cost of GSHP systems. These parameters are: GSHP size; depth of ground heat exchanger below grade; GSHP capacity; heat transfer fluid; heat transfer fluid flow rate; ground heat exchanger pipe size; spacing of ground heat exchanger; and soil type. These factors have to be taken into account in accomplishing a successful design and efficient operation of the GSHP system (Hepbasli et al., 2003).

A study by Cho and Choi also supported the influence of these parameters. The study found out that the decrease of the size of ground loop heat exchanger (GLHX) is extremely significant in reducing the total installation cost of a GSHP system (Cho & Choi, 2013). In another study, the performance of a GSHP unit is measured by modifying the secondary fluid flow rate and compressor speed. The impact of the flow rate and the thermal conductivity on the performance of the system and the size of ground loop heat exchanger (GLHX) was also analyzed. The results indicated that the GLHX length increases with the increase of the flow rate whereas it decreases with high thermal conductivity. The drop in thermal conductivity value resulted in an increase rate of the loop length as the flow rate rises. A higher secondary fluid flow rate can enhance the performance of the GSHP unit but it makes the length of the loop longer. It is concluded that the design parameters such as system COP and the flow rate can play an essential role in minimizing the installation cost and lead to energy savings in the GSHP system (Chung & Choi, 2012).

The Oak Ridge National Laboratory in Tennessee, United States has conducted a study to show that 68%–76% of the energy required to produce domestic hot water may be extracted from the ground through a vertical-bore ground source heat pump that serves as a renewable energy resource (Ally, Munk, Baxter, & Gehl, 2015).

Kütahya Dumlupınar University in Turkey has used the concept of life cycle costing (LCC) coupled with net present value analysis (NPV) to show that 13,776 residences from a town center in the Simav region with a population of nearly 25,000 could be heated through a proper geothermal heat pump aided district heating infrastructure. This pre-feasibility study showed that the usage of this proposed system would be an attractive investment for this region (Arat, & Arslan, 2017).

2.1.8.2 Studies on Hybrid Systems

Some studies have also been conducted on the integrated approaches of GSHPs. According to study conducted by Jiao Tong University in Shanghai, it was suggested that for a heating dominated building, the combination of a GSHPs with a solar thermal unit shows strong potential for energy conservation and high efficiency utilization of the GSHPs. On the other hand, for a cooling dominated building, it is more feasible to integrate a GSHPs with a cooling tower. It was also recommended that the high inertia heating/cooling distribution systems *i.e.* radiant floors, ceilings or walls are more appropriate for GSHPs (Zhai et al., 2011). Similarly, a study was done on the hybrid GSHPs for air – conditioning in hot weather areas like Hong Kong. A case study was developed and HGSHP was compared with GSHP for a hypothetical private residential building located in Hong Kong. The results showed that the HGSHP system can effectively solve the heat accumulation problem and decrease the initial and operating cost of the air – conditioning system in the building (Man et al., 2010). A study by Flemish Institute for Technological Research (VITO) in Belgium shows that with a hybrid GSHP system a significant borefield size reduction can be achieved without compromising system performance; *i.e.* for the reference case a reduction of 47% was achieved in the cost-optimal configuration (Allaerts, Coomans, & Salenbien, 2015).

2.1.8.3 Effect of Soil Type on Performance of GSHPs

Very few studies have actually looked at the impact of the soil type on the performance of GSHPs. Leong and his research team has suggested that the performance of GSHPs is strongly dependent on the moisture content and soil type (Leong et al., 1998). Another study looked at the passive design strategy for a horizontal GSHP pipe operation optimization with a non – homogenous soil profile which suggested that a properly sized and engineered non-homogeneous soil profile demonstrated the potential to increase the energy extraction/dissipation rates from/to the ground to a significant level (Bazkiael et al., 2013).

2.2 Overview of Conventional Heating, Ventilation, and Air Conditioning (HVAC) Systems

The primary conventional heating, ventilation, and Air Conditioning (HVAC) systems in the residential households of Ontario consist of natural gas furnace (space heating), air conditioner (space cooling), and natural gas water heater (hot water usage).

2.2.1 Natural Gas Furnace

A natural gas furnace converts gas to heat (Trane, 2016). A gas forced-air heating system goes into action when the thermostat tells it that the room temperature has dropped below a preset comfort level. The thermostat sends a low-voltage electrical signal to a relay in the furnace, which signals a valve to open and deliver natural gas to the burners and for the blower to turn on. The furnace's pilot light or electronic ignition lights the burner inside the combustion chamber. This creates heat in the furnace's heat exchanger, a metal chamber around which the moving air flows. Once warmed, the air is pushed into the hot-air plenum and then out to the rooms through duct work. The combustion gases created by burning fuel are vented through a flue in the roof or, with high-efficiency furnaces, through a wall (Vandervort, 2016). A gas furnace fan is the indoor air moving component of the furnace that is designed to supply heating through a system of ducts with air as the heat transfer medium. The assembly typically consists of a fan motor and its controls, an impeller, and housing (NRCan, 2016b). A natural gas furnace can be viewed in Figure 47.



Source: Adobe Stock, 2017b

Figure 47: Natural Gas Furnace with Duct Work

Gas furnaces were first regulated in Canada in 1995. The current regulation only sets minimum energy performance standards (MEPS) for the fuel efficiency of gas furnaces. On July 3, 2014, the United States Department of Energy (U.S. DOE) issued a final rule which set conservation standards for the electrical consumption of residential furnace fans (NRCan, 2016b).

Natural Resources Canada (NRCan) is considering introducing MEPS which would limit the electrical consumption of gas furnace fans. If implemented, this proposal would ensure the Regulations for gas furnace fans are aligned with those of the U.S. DOE (NRCan, 2016b).

The majority of the gas furnaces installed in existing homes are open combustion, non-condensing fan-assist types. These furnaces have an Annual Fuel Utilization Efficiency (AFUE) between 60-80%, with a significant derating when operated at altitude. They also are normally

equipped with standing pilot lights. In older homes, make-up air openings may not have been installed next to furnaces per code requirements, thus combustion make-up air is pulled from the living space. It is important to keep this in mind during an energy retrofit in order to avoid back-spill, which can be a dangerous side effect of over-tightening the space without proper combustion and make-up air openings (NREL, 2014).

According to a report by U.S DOE, the proper installation of a gas furnace requires attention to many details and interconnecting systems: heating capacity (sizing), consideration for duct distribution systems, gas piping, vent systems, provision for combustion air, flue gas condensate disposal, electrical connection requirements, provision for forced-air cooling (as required), air filtering equipment, and humidification requirements (Brand & Rose, 2012). Recently, there are two types of equipment to choose from: (i) mid-efficiency furnaces have an Annual Fuel Utilization Efficiency (AFUE) of 80%-83%, and (ii) high efficiency furnaces have an AFUE of 90%-98%. Gas furnaces are typically sized to provide a 50°F rise in air temperature from return to supply, or 120°F supply air temperature under all outdoor conditions.

High efficiency gas furnaces have limited interaction with the thermal envelope but significant interaction with central space cooling (air conditioning) equipment, humidifiers, air cleaners, and the air distribution system (ductwork). Selecting the right furnace capacity for the application, properly designing the distribution systems, and selecting the correct fan speed settings on the furnace blower will provide seamless interaction between the furnace and the other systems (Brand & Rose, 2012).

Furnace interaction with the thermal envelope typically takes the form of increasing infiltration (if the direct vent option is not supported), heat losses through the enclosure and interactions with the distribution system that can lead to duct leakage outside the conditioned space. High efficiency furnaces use about 10 cubic ft. of air for every cubic ft. of gas burned, or about 13 cfm of air for the typical 80,000 Btu/hr furnace. The increase in heating load associated with the increase in infiltration, if outdoor air for combustion is not used, is on the order of 1% in cold climates, or about 800 Btu/hr in this example. In addition, furnaces that use indoor air for combustion may be competing with draft-hood equipped appliances, dryers, range hoods, fireplaces, and ventilation systems for air, resulting in nuisance heat outages. For this reason, direct vent systems are strongly recommended for furnaces installed within the conditioned space (Brand & Rose, 2012).

In the case of distribution system interactions, the furnace circulating air blower speed (for PSC motors) is selected according to the manufacturer's installation instructions to match the equipment heating and cooling capacity. Separate wiring connections on the control board are used for heating and cooling fan speeds. For heating fan speed selection, consult the manufacturer's installation instruction—fan speeds are selected according to the capacity of the furnace. For

cooling, manufacturers will recommend a cooling fan speed according to the capacity of the cooling system. Furnace fans are designed to work against an external static pressure (ESP) at rated flow in the distribution system. This pressure is typically 0.5 to 1.0 inches of water column (125 to 250 Pa), though some practitioners design for significantly lower numbers (Chitwood & Harriman, 2010; Brand, & Rose, 2012).

2.2.2 Air Conditioner (A/C)

In summer, high relative humidity, elevated air temperatures and bright sunshine can sometimes combine to produce an uncomfortable indoor environment. An air-conditioning system can provide comfort for occupants by lowering the air temperature and the humidity level in the home. The most common types of air conditioners in the residential households of Ontario are: (i) Room air conditioners, and (ii) Central air conditioners (NRCan, 2004b).

Both room air conditioners and central air conditioners are covered under Canada's Energy Efficiency Regulations, which came into effect February 3, 1995. These regulations, which cover several types of energy-using products, help Canadians save money and protect the environment by reducing electricity demand. Improving energy efficiency reduces greenhouse gas (GHG) emissions that contribute to climate change. Under the Regulations, energy-using products, such as room air conditioners and central air conditioners, must meet minimum efficiency standards of performance if they are to be imported into Canada or shipped across provincial and territorial boundaries (NRCan, 2004b).

2.2.2.1 Room Air Conditioners

A room air conditioner is essentially a smaller version of a central air conditioner and is intended to cool only a small area, usually one room. Powered by electricity, it removes heat from the living space to maintain comfort conditions during hot, humid weather and conveys it to the outdoors. Unlike a central air conditioner, no ductwork is required, and all components are built into a single package that is mounted in a window opening or through the wall (Figure 48). Smaller capacity room air conditioners are portable, as they are easily moved from one room or residence to another. Two major categories of room air conditioners are available: units with louvred sides that are intended for installation in window openings, which are the most common type, and units without louvred sides intended for through-the-wall installation (NRCan, 2004b).

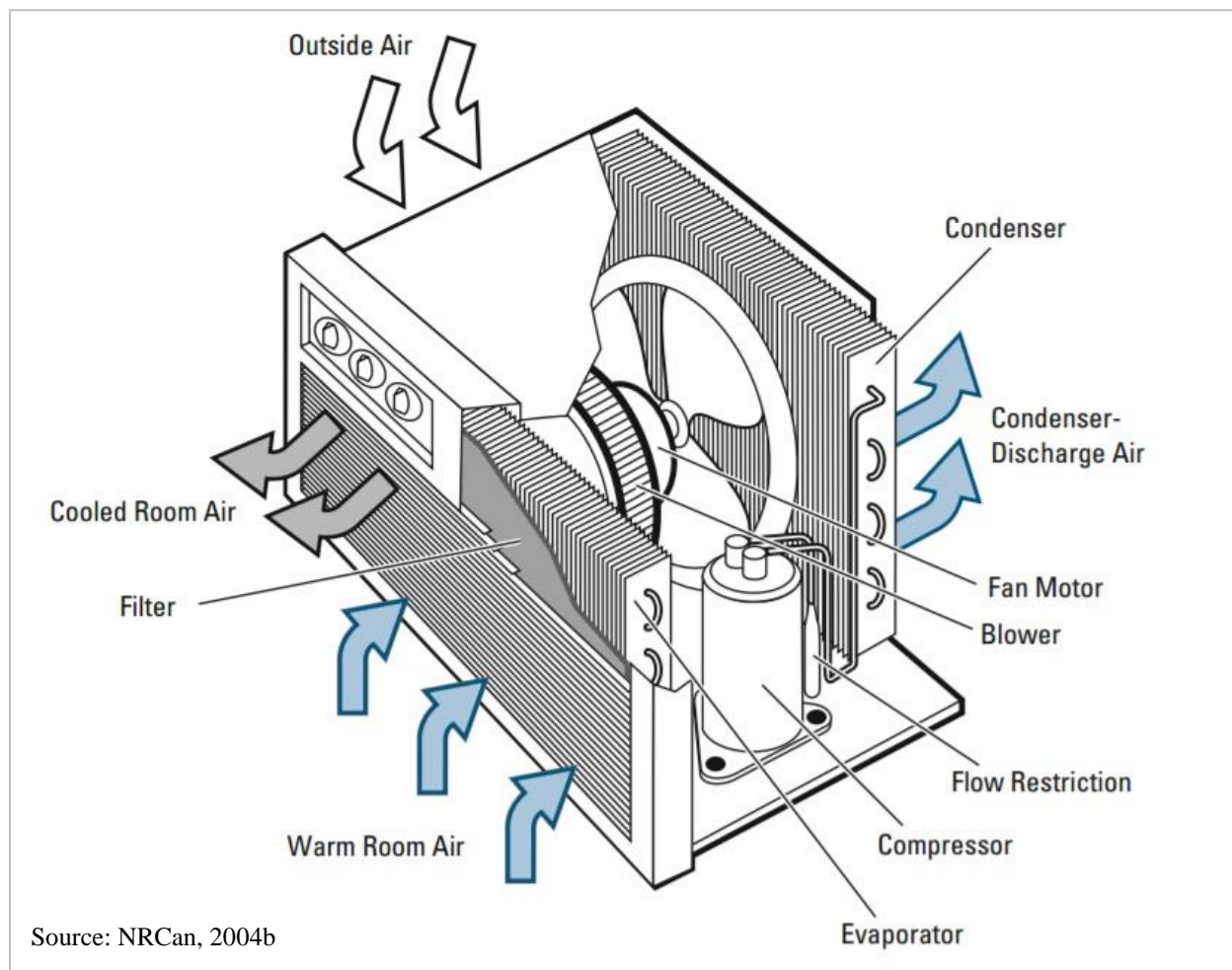

Figure 48: Components of a room air conditioner

Room air conditioners function in much the same way as refrigerators do – heat is extracted from the space that is being cooled and is conveyed outside of that space. A fan circulates room air through the evaporator, which contains low-pressure refrigerant (see Figure 49). Evaporation of the refrigerant cools the tubes and fins, extracting heat from the air and causing moisture in the air to condense on the evaporator’s outer surface. The cooler, drier air is returned to the room, and the gaseous refrigerant leaving the evaporator is drawn into the compressor where mechanical compression raises its temperature and pressure. The hot, high-pressure refrigerant passes through the condenser, where it loses heat to outdoor air (which is blown over it with a second fan) and condenses. This high-pressure liquid refrigerant passes through a restriction and into the low-pressure side of the circuit, and the entire process is repeated (NRCan, 2004b).

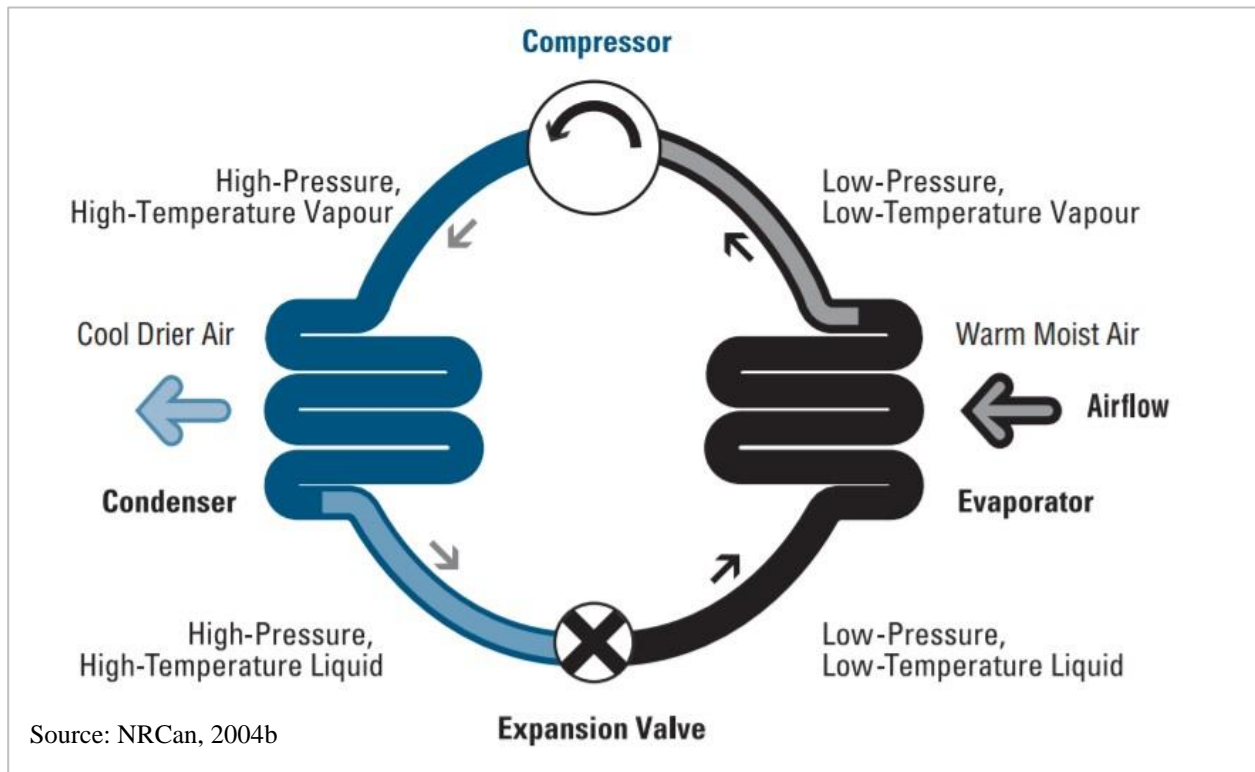

Figure 49: Basic Cooling Cycle

2.2.2.1.1 Energy Efficiency Consideration

The efficiency of room air conditioners in converting electricity into cooling effect varies widely, depending on the manufacturer's design choices. Models for window mounting are available with EER ratings between 12.0 and 8.0, and units intended for through-the-wall applications have EERs between 9.5 and 8.0 (NRCan, 2004b).

High-efficiency units generally incorporate efficient rotary compressors, large evaporators and condensers with louvred fins and internally rifled tubes, as well as efficient fans and a slinger ring to deposit water collected from the evaporator onto the hot condenser (NRCan, 2004b). Minimum efficiency units tend to use small conventional heat exchangers and standard compressors and fans (Figure 50).

While higher efficiency units are more expensive to manufacture, retail prices do not necessarily reflect this premium. Select a unit with as high an EER as is practical, to minimize operating costs (NRCan, 2004b).

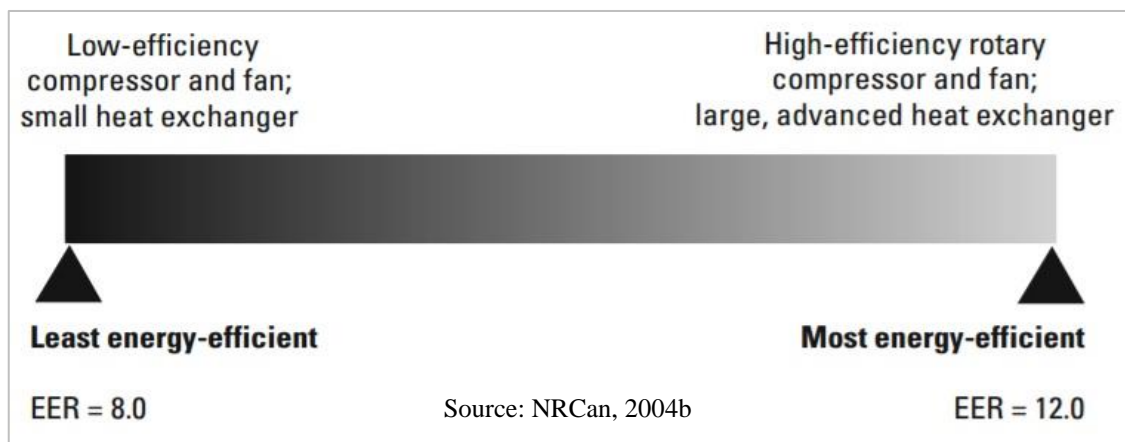

Figure 50: Efficiency of a room air conditioner

2.2.2.1.2 Sizing Considerations

The amount of cooling that the air conditioner must provide to maintain comfort conditions is called the cooling load. It is affected by the size of the room, the size and orientation of windows, attic and wall insulation levels, and the amount of heat being generated in the room, *etc.* As a rough rule of thumb, 200 Btu/h of room air conditioner capacity will be required to cool and dehumidify each square metre of living space. Ideally, the unit should be sized by a qualified air conditioning contractor, using detailed calculations that take into account the size of rooms, insulation levels, size and orientation of windows and doors, shading, number of occupants, appliances, lighting, climate, *etc.* (NRCAn, 2004b).

2.2.2.1.3 Life Expectancy and Warranties

In general, room air conditioners are expected to have a service life of approximately 10 years. Lower annual run-time results in a greater than average life expectancy. Warranties vary from one manufacturer to another. Frequently, some form of five-year warranty is offered with complete parts and labour coverage in the first year. Subsequent coverage is usually limited to, for example, the cost of sealed refrigeration-system parts being covered (NRCAn, 2004b).

2.2.2.2 Central Air Conditioners

Central air conditioners are designed to cool the entire house. The large compressor and outdoor coil are located outdoors and are connected by refrigerant lines to an indoor coil mounted in the furnace (Figure 51). The same duct system is used for both heating and cooling air distribution (NRCAn, 2004b).

A central air conditioner uses energy to take heat away. The most common type uses a compressor cycle (like a refrigerator), illustrated in Figure 52, to transfer heat from the house to

the outdoors. Using a special fluid called a refrigerant, heat is absorbed and released when the refrigerant changes back and forth between a liquid and gas state. As it changes from liquid to gas, it absorbs heat; in changing back to a liquid from a gas, it releases heat. The compressor cycle passes liquid refrigerant through an expansion device, changing the liquid to a low-pressure liquid/gas mixture. In the indoor coil or evaporator, the remaining liquid absorbs heat from household air and becomes a low-temperature gas (NRCan, 2004b).

The low-temperature gas is compressed by a compressor that reduces its volume and increases its temperature, causing it to become a high-pressure, high-temperature vapour. This vapour is sent to the outdoor coil or condenser where its heat is transferred to the outdoor air, causing the refrigerant to condense into a liquid. The liquid returns to the expansion device and the cycle is repeated. Household air is cooled and dehumidified as it passes over the indoor coil. The moisture removed from the air, when it contacts the indoor coil, is collected in a pan at the bottom of the coil and sent to a house drain (NRCan, 2004b).

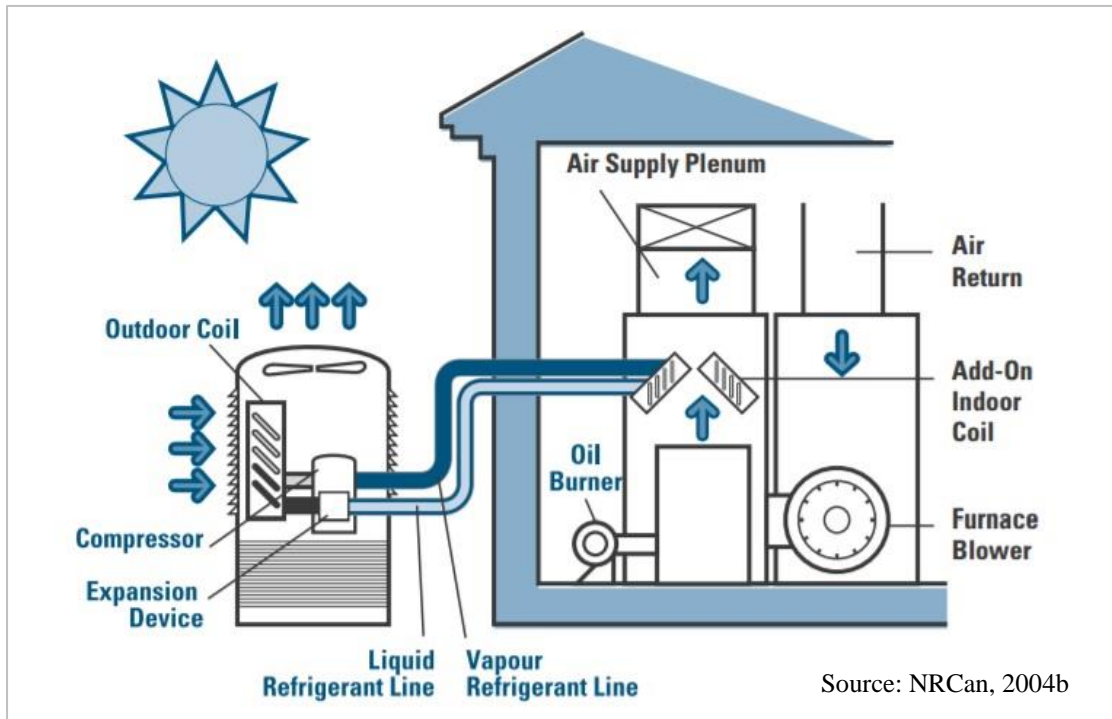

Figure 51: Installed Central Air Conditioner

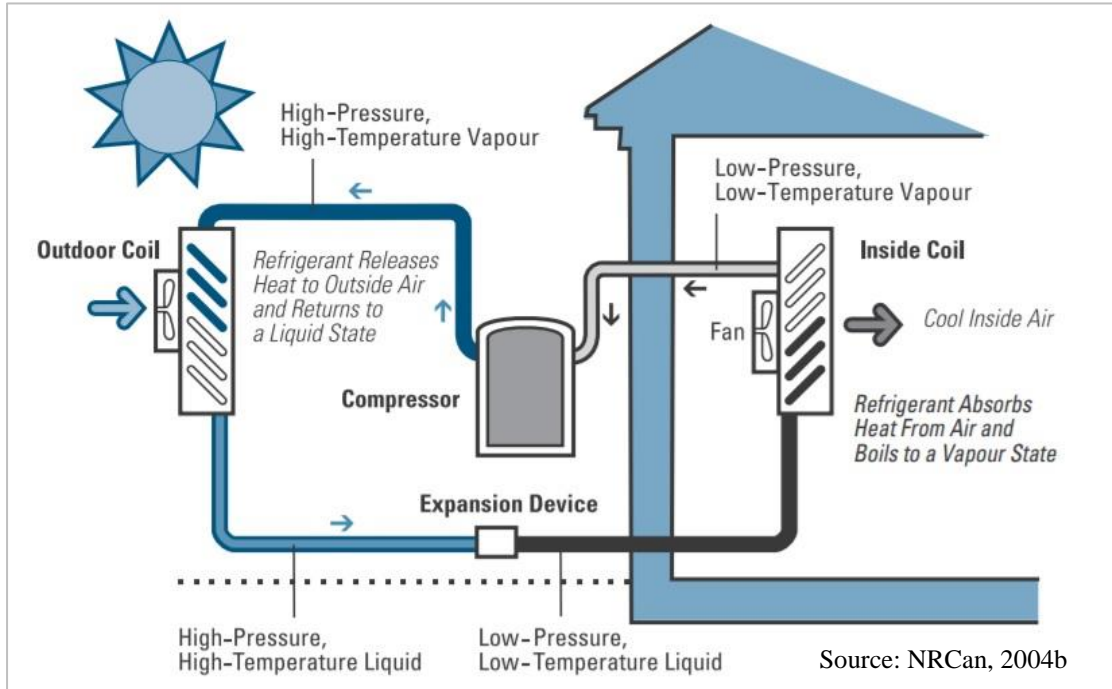

Figure 52: Operations of a Central Air Conditioner

2.2.2.2.1 Energy Efficiency Consideration

Select a central air conditioner with as high a SEER as is practical within your budget. The annual cooling efficiency of a central air conditioner is affected by the manufacturer’s choice of features and components. The SEER of central air conditioners ranges from a minimum of 10.0 to a maximum of about 17.0. More efficient compressors, larger and more effective heat exchanger surfaces, improved refrigerant flow and other features are largely responsible for recent improvements in the efficiency of central air conditioners. Advanced reciprocating, scroll and variable-speed or two-speed compressors, when combined with the current best heat exchangers and controls, permit SEERs as high as 17.0 (Figure 53). Central air conditioners with the highest SEERs always use variable-speed or two-speed high efficiency compressors (NRCAN, 2004b).

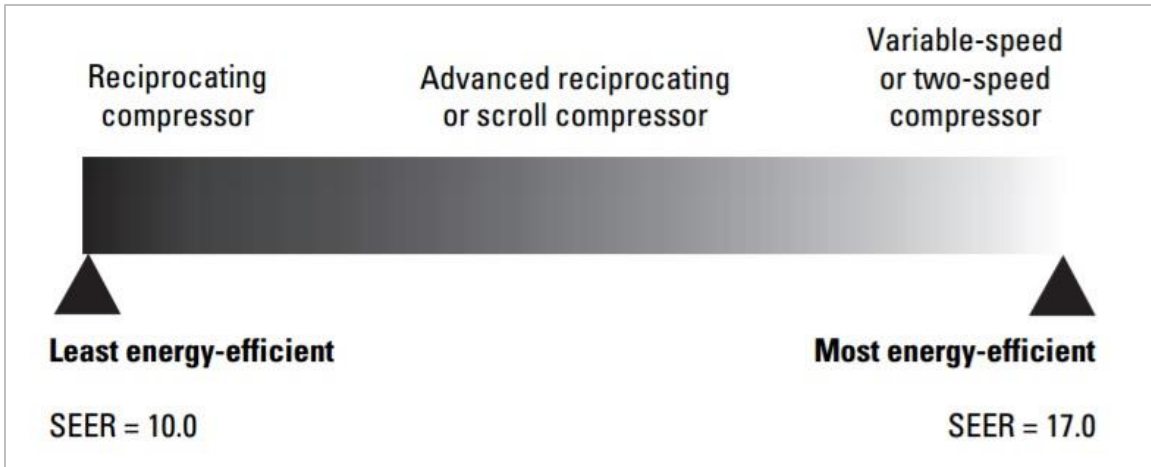

Figure 53: Efficiency of a Central Air Conditioner

2.2.2.2.2 Sizing Consideration

Cooling loads should be determined by a qualified air conditioning contractor, using a recognized sizing method such as that specified in CSA-F280-M90: Determining the Required Capacity of Residential Space Heating and Cooling Appliances. Do not rely on simple rules of thumb for sizing, but insist on a thorough analysis from the sales representative. Select a central air conditioner size or capacity to just meet the design cooling-load calculated. Oversizing the unit will result in short operating cycles, which will not adequately remove humidity, resulting in an unpleasantly cold and damp home. Undersizing the unit will result in an inability to attain a comfortable temperature on the hottest days. Also, with a central air conditioning system, the equipment cost is much more proportional to size than it is with heating equipment. Unnecessary oversizing will increase the purchase price and increase on-and-off cycling, which will decrease the unit's overall efficiency (NRCan, 2004b).

2.2.2.2.3 Life Expectancy and Warranties

The life expectancy of a central air conditioner is 15 years or longer. When the air conditioner starts giving more problems than seem cost-effective to fix – particularly when major components, such as a compressor, require replacement – it may be time to replace the central air conditioner. New units offer greater efficiency and lower operating costs; it may be more cost-effective in the long run to replace rather than repair. The warranty on your equipment will vary according to the manufacturer. Air conditioner warranties range from one year for complete parts and labour to five years for the compressor. Some manufacturers are now offering 10-year warranties on their compressors (NRCan, 2004b).

2.2.3 Natural Gas Water Heater

Hot water use is the second largest portion of energy utility costs, after home heating. • Water heating represents 15 to 25 percent of your household energy bill and may become a larger portion if you upgrade the energy efficiency of your home and its space heating and cooling systems without upgrading your water heating system (NRCan, 2012). A water heater uses energy to raise the temperature of cold water coming in from the municipal water system or from your well. Most commonly, hot water is stored in a tank, but in the case of a tankless or on-demand water heater, the water is heated only as it is needed (NRCan, 2012).

2.2.3.1 Conventional Gas Fired Water Heater

The standard natural gas-fired water heater (Figure 54) is called a conventional or naturally aspirating water heater. Its tank is cylindrical, steel, lined with glass (that protects the steel tank from corrosion, insulated externally with foam, and covered with a thin, outer metal skin (outer jacket). The tank has a: cold water supply inlet, hot water outlet connection, draft hood, flue vent and pipe, and gas burner in a combustion chamber (attached externally to the bottom of the storage tank) (NRCan, 2012).

The gas burner uses a continuous pilot light to heat a small thermal element (a thermopile) that generates a small amount of electricity to power the control and safety circuits and ignite the main burner when required. Conditioned house air that is used for combustion enters through openings at the bottom of the combustion chamber. The flue passes vertically through the centre of the tank to the chimney of the house for venting to the outside. Additional conditioned house air is added to and dilutes combustion gases through a draft hood at the top of the water heater. A combined thermostat and gas valve unit controls the burner. The gas burner is activated when the water temperature in the storage tank drops below the thermostat set point. The temperature drop occurs after enough hot water is withdrawn from the tank and replaced by cold inlet water. Then hot combustion gases rise up the flue, transferring heat through the steel flue to the water. These gases exit the water heater at the top. The flue gases rise up through the chimney because they are less dense (because they are warmer) than the surrounding air (stack effect). This type of water heater does not require electricity (NRCan, 2012).



Figure 54: Conventional Gas Fired Water Heater

Conventional gas-fired water heaters are tested and rated to the CSA P.3 standard, which determines their EF. In use, these water heaters are rather inefficient because they use naturally

aspirated burners, continuous pilot lights and have constant energy losses up the chimney. They also can spill combustion gases if the house depressurizes (NRCAN, 2012).

2.2.3.2 Power Vented Gas Fired Water Heater

Power-vented gas-fired water heaters (Figure 55) are similar in construction to conventional gas-fired water heaters. The main difference is that a fan pushes the exhaust gases through a vent out the side wall of the house. Because no chimney is required, this type of water heater is compatible with high-efficiency furnaces that are sidewall-vented. All power-vented water heaters have electronic ignition instead of a continuous pilot light, which also improves efficiency. However, the efficiency improvement over conventional water heaters is fairly small. An advantage of power venting is that it eliminates the possibility of back drafting and spilling combustion gases. A power-vented gas water heater may be a good option where no chimney exists or where the cost of chimney lining would be high. These water heaters require electricity, so they cannot produce hot water during a power outage. Power vented gas-fired water heaters are also tested and rated to the CSA P.3 standard (NRCAN, 2012).



Figure 55: Power Vented Gas Fired Water Heater

2.2.3.3 Measuring Energy Performance

The energy factor (EF) is used to rate the efficiency of gas-fired (natural gas) or oil-fired water heaters. It is the amount of energy supplied as hot water divided by the total amount of energy used by the water heater over a 24-hour (hr) period. The EF is determined assuming a standard hot water use profile with fixed inlet and outlet water temperatures. The calculations account for standby losses and the operating efficiency of the water heater when it is heating water (recovery efficiency). A higher EF indicates higher efficiency. The EF is used for both storage tank and tankless water heaters. The energy performance of electric water heaters is rated in standby loss measured in watts. This indirect measure of efficiency indicates the loss of heat from the tank. Better insulation around the tank reduces heat loss. A lower standby loss indicates higher efficiency (NRCAN, 2012).

The efficiency of gas-fired, propane and oil-fired water heaters is measured by the EF. The efficiency of electric water heaters in Canada is measured by standby loss. After you select the size, choose models with a high EF or low standby loss rating because these are the most efficient. Remember that using an oversized water heater will increase energy costs because of increased standby losses. Higher efficiency is a result of improved heat exchange and better heat retention

due to increased insulation levels. Higher efficiency water heaters usually have a higher purchase cost but lower operating costs, are higher quality and have better warranties (NRCan, 2012).

The first hour rating (FHR) measures how much hot water the heater can supply during 1 hr, starting with a fully heated storage tank. This should match or exceed the maximum estimated hot water use in your house in 1 hr. The higher the FHR (also referred to as first hour delivery), the more hot water the water heater can deliver during the peak use time. The “capacity” of a gas-fired water heater should be judged by its FHR, not its tank size. Due to larger burners, some gas water heaters with smaller tanks actually have a higher FHR than models with larger tanks. (NRCan, 2012).

2.2.3.4 Typical Household Hot Water Use in Canada

In Canada, the average person uses 75 L of hot water per day and the average Canadian household uses 225 L. The four main uses for hot water in the home are showers, faucets (food preparation, hand washing), clothes washers and dishwashers. Figure 56 shows typical hot water use breakdown, which illustrates that showers and baths account for almost half the hot water use in your home (NRCan, 2012).

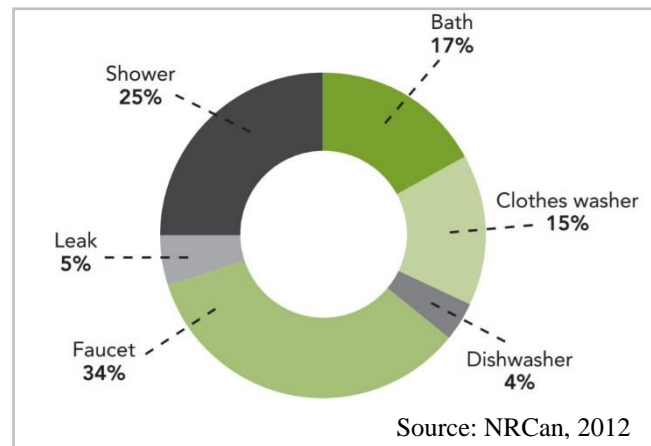

Figure 56: Main Uses for Household Hot Water in Canada

2.3 Snapshot Analysis of HVAC Systems

This chapter has described the GSHPs and traditional fossil fuel based energy HVAC applications in detail to set-up the stage for a robust and tangible technical, economic, and environmental assessment of these HVAC technologies. This will help consumers to determine the most attractive investment among these technologies for space heating, cooling, and hot water usage for their residential households in Ontario.

Variables such as costs, efficiency, system sizing, heating and cooling loads, weather conditions, soil characteristics, technical barriers, lifespan, system components, laws of thermodynamics, etc. has been introduced in this chapter. This will help the readers in easy

transition to the next chapter of methodology that comprises of technical, economic, and environmental assessments.

Chapter 3 – Methodology and Results

3.1 Synopsis

In this thesis, a geotechnical analysis of ground source heat pump systems (GSHPs) in comparison with the traditional HVAC applications was performed on a 2,000 square feet detached house for 27 cities in Ontario. This allows a rigorous and consistent comparison of the economic feasibility of GSHPs, HVAC systems efficiency comparisons, and an environmental assessment of reduction of greenhouse gas (GHG) emissions arising from use of these technologies in Ontario on a large-scale.

3.1.1 Technical Assessment

The data has been acquired and generated through different sources and mediums that was used to do a technical assessment for the vertical and horizontal ground source heat pumps and traditional HVAC applications (see Figure 57).

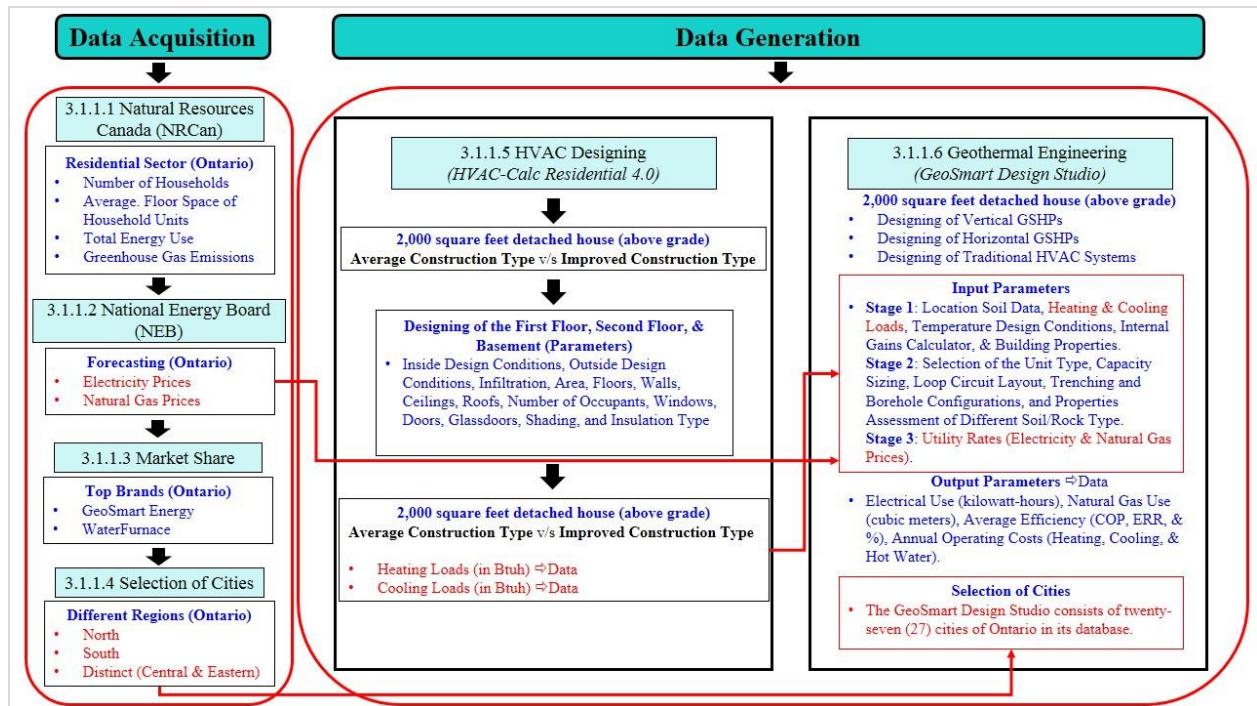

Figure 57: Technical Assessment – Data Acquisition and Data Generation Schematic

3.1.1.1 Natural Resources Canada (NRCan)

The data on the residential sector of Ontario has been acquired from the database of Natural Resources Canada (NRCan). This has given information on the different types and number of households, average floor space of these household units, total energy use by end-use, total energy use by energy source, total energy use by system type, and energy system stock in Ontario. A

‘2,000 square feet detached house above the grade’ dwelling type was selected as single detached houses have higher presence than other dwelling types in Ontario. In 2014, the shares of single detached, single attached, apartments, and mobile homes were 56.1%, 13.9%, 29.7%, and 0.3%, respectively (NRCan, 2017a). The average floor space of a single detached house in Ontario in year 2014 was 1,911 square feet (NRCan, 2017a).

3.1.1.2 National Energy Board (NEB)

The existing and forecasted rates of electricity and natural gas were taken from the National Energy Board (NEB) database. A detailed analysis is shown in Figures 63 and 64 in section 3.1.1.6 under stage 3 input parameters.

3.1.1.3 Market Share

The market share of different ground source heat pump brands were analyzed in Ontario. In the past five years, GeoSmart Energy has installed more than 30,000 GSHP units in Ontario and now occupies a leading share of the market (Marco, 2016). GeoSmart Energy GSHP brand was chosen for this study.

3.1.1.4 Selection of Cities

Twenty-Seven (27) cities were included in the study for the technical and economic analysis of GSHP systems against traditional HVAC applications in a 2,000 square feet detached house. Seven cities (Kapusking, Kenora, North Bay, Sault. Ste. Marie, Sudbury, Timmins, and Thunder Bay) were selected from Northern Ontario (Figure 58) and sixteen cities (Cambridge, Chatham, Guelph, Hamilton, Kingston, Kitchener-Waterloo, London, Mount Forest, Niagara Falls, Sarnia, Simcoe, St. Catharines, Toronto, Trenton, Warton, and Windsor) from Southern Ontario. In addition, three cities (Barrie, Muskoka, and Peterborough) were added from Central Ontario and 1 city (Ottawa) from Eastern Ontario. The central and eastern cities have been placed as one cluster under the name of ‘Distinct’ region (Figure 59). The complete map can be seen in Figure 60.

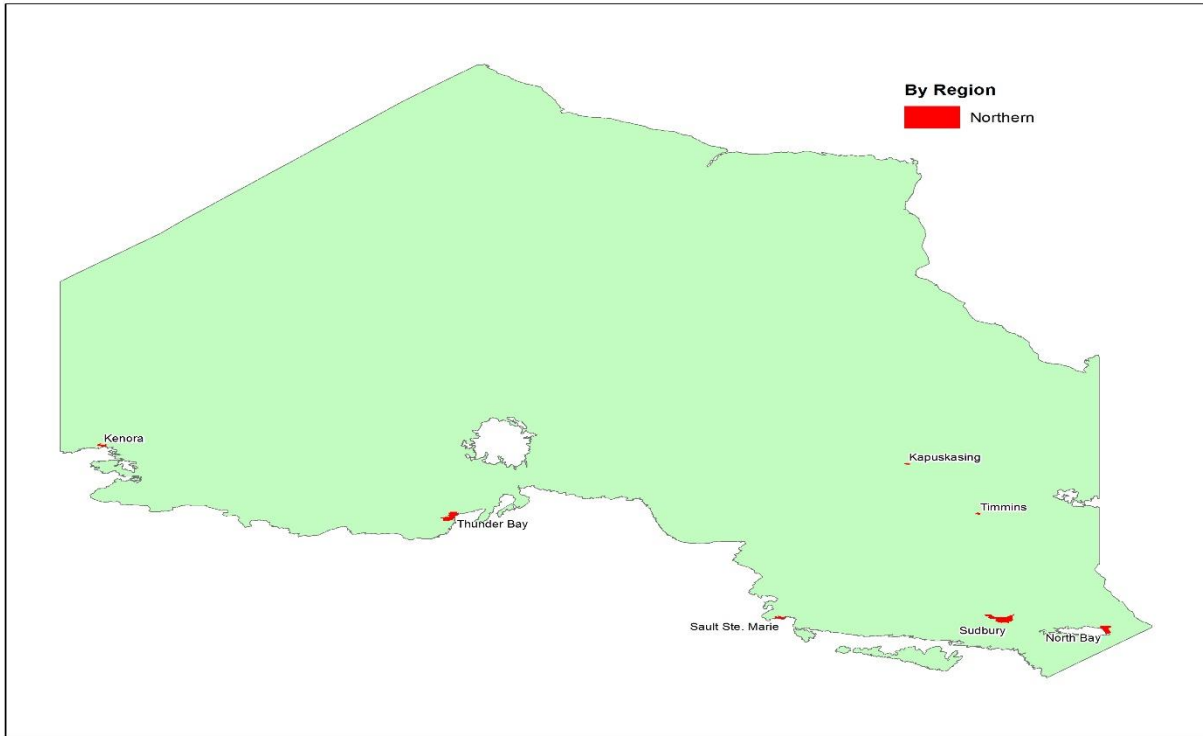

Figure 58: Selected Cities in Northern Ontario

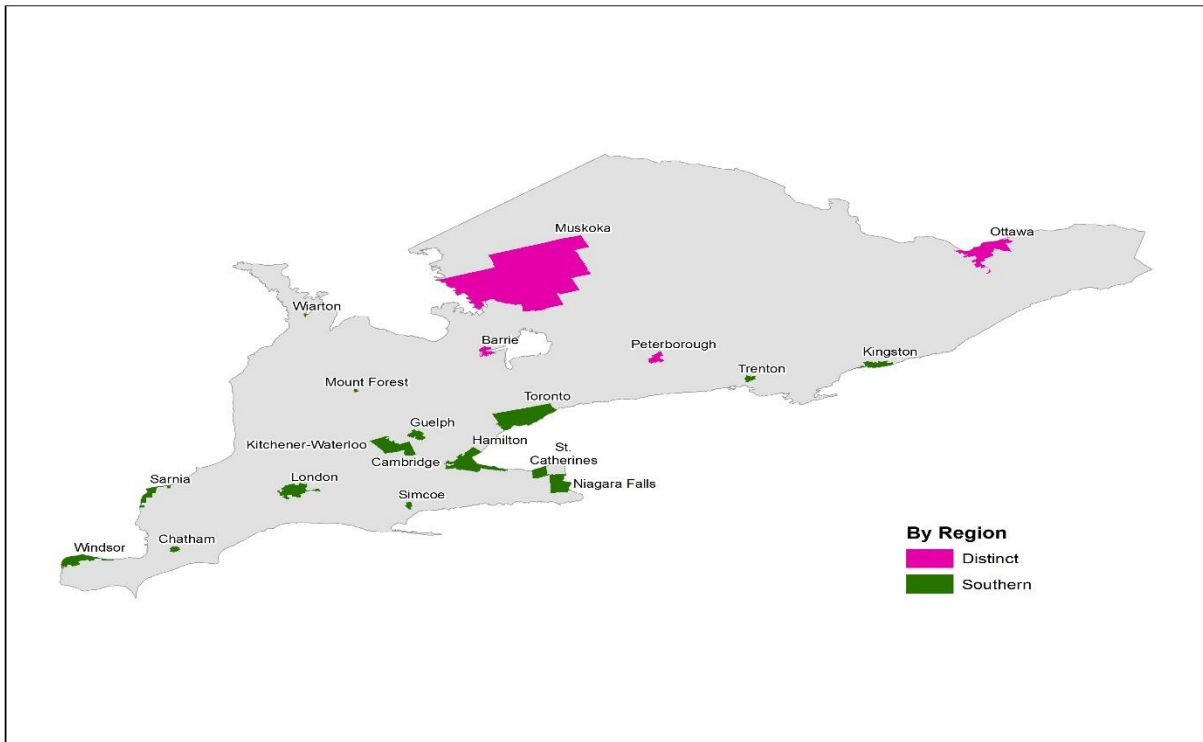

Figure 59: Selected Cities in Southern Ontario, and Central/Eastern Ontario (Distinct Region)

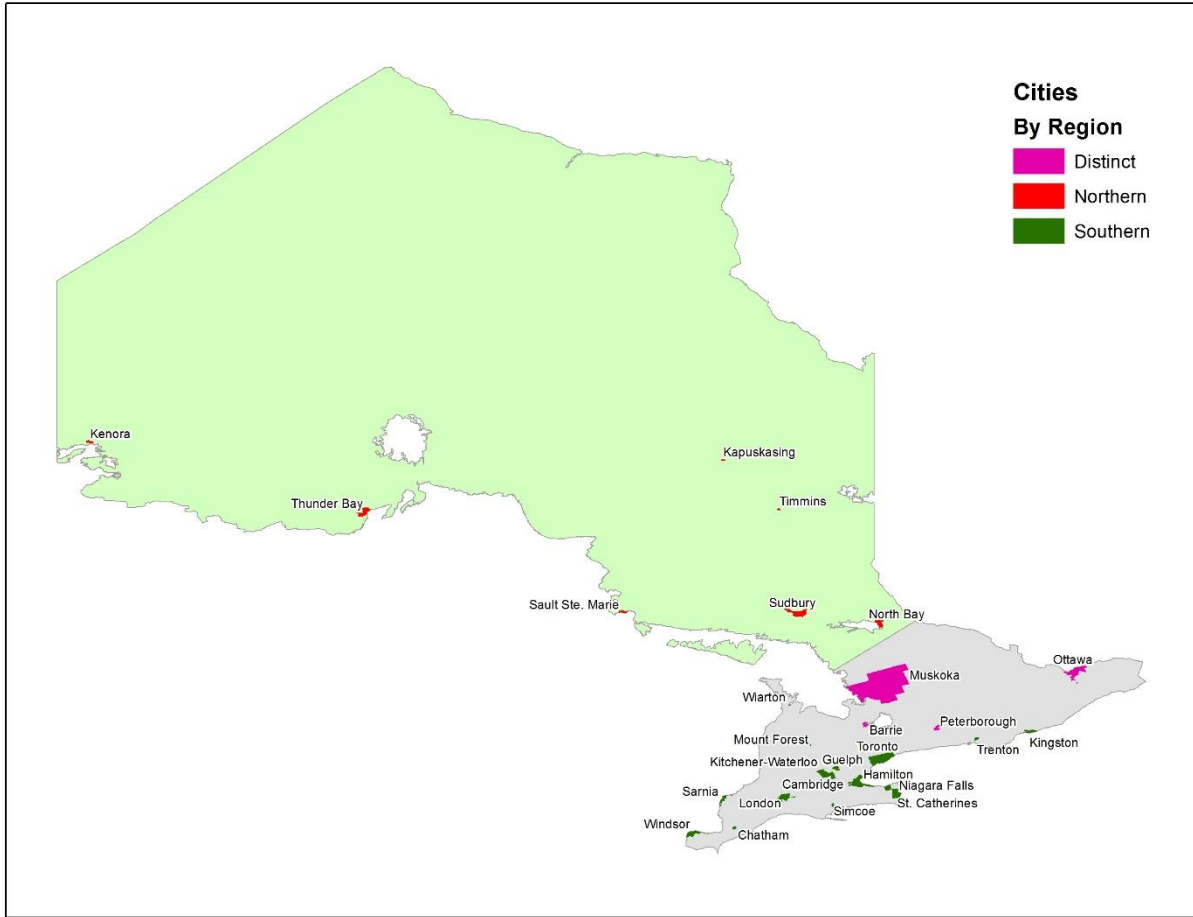

Figure 60: Selected Cities in Northern, Southern, and Distinct Region

3.1.1.5 HVAC Designing (*HVAC-Calc Residential 4.0*)

The heating and cooling loads (losses) of the 2,000 square feet detached house was calculated for the above mentioned 27 cities in Ontario by using HVAC-Calc Residential 4.0 software. The entire household structure was designed in this program. The HVAC designing has been divided into two categories: (i) Average Construction Tightness (normal construction, poor vapor barrier), and (ii) Improved construction Tightness (improved construction, sealed vapor barrier).

There are two sources of *heat loss* (Heating Loads) in a house. One source is heat transfer through the envelope of the building, the outside walls, the windows, the ceiling and the floor if it is not above a heated space. The other source of heat loss is infiltration. Infiltration is the amount of cold air that either sneaks into the house through cracks and door openings, or is purposely brought into the house for ventilation (Sleeth, 2016).

Here is a summary of the factors affecting heat loss (Sleeth, 2016):

1. **Temperature Difference:** Reducing the inside temperature and moving to a warmer climate are two ways to reduce heat loss.
2. **Area of the building envelope:** Smaller houses have lower heat losses than larger ones.
3. **Thermal Resistance:** Adding insulation to the walls and ceiling (increasing R-value) reduces heat loss.
4. **Tightness:** Better window frames, sealing cracks particularly around doors reduces infiltration as does better fireplaces.

Heat Gain (Cooling Loads/Losses) of course is very much like heat loss, except here we are talking about the amount of heat that the house gains in the summer time. In the summer, the temperature difference goes the other way, it is warmer outside and ideally, cooler inside. Heat is transferred from the hot outside and it also is brought in with outside air, infiltration (Sleeth, 2016).

The four factors discussed above all affect heat gain also, in exactly the same way they affect heat loss. However there is one additional and very important factor, solar gain through glass. In addition to heat transferring in through the house envelope and sneaking in through infiltration it is also radiated in by sunlight, both direct and indirect, through windows, glass doors and skylights (Sleeth, 2016).

There is also an additional unit of measurement that is used to describe the cooling capacity of air conditioners and that is the “Ton”. One Ton = 12,000 Btu per hour (Btu-h). It comes from the

number of Btu’s absorbed by a ton of ice melting in 24 hours. If you have a heat gain of 30,000 Btu-h (at the summer design temperature) then you would need to remove 30,000 Btu-h in order to keep the house at the indoor design temperature of say 75°F. You could remove the 30,000 Btus each hour by either setting up some fans to blow the inside air over a mountain of ice, being sure to completely melt 2 ½ tons each day, or you can install a 2 ½ ton air conditioner. Due to the difficulty of obtaining ice these days and the problems associated with drinking two and a half tons of ice water each day, most homeowners choose the A/C (Sleeth, 2016).

The HVAC design parameters can be seen in the tables below:

Table 4a: HVAC Design Parameters

Cities	Inside Design Conditions			Outside Design Conditions				Infiltration				
	Summer	Winter	Relative Humidity	Summer	Winter	Summer Grains of Moisture	Daily Range	Construction Tightness	Air Changes Per Hour (ACH) Value (Summer)	Air Changes Per Hour (ACH) Value (Winter)	Air Changes Per Hour (ACH) Value (Summer)	Air Changes Per Hour (ACH) Value (Winter)
										Average Construction	Improved Construction	
Cambridge (South)	74 °F	72 °F	55% RH	84 °F	-2 °F	98	Medium	i) Average, and ii) Improved	0.4	0.7	0.2	0.3
Chatham (South)	74 °F	72 °F	55% RH	88 °F	3 °F	101	Medium	i) Average, and ii) Improved	0.4	0.7	0.2	0.3
Guelph (South)	74 °F	72 °F	55% RH	84 °F	-2 °F	97	Medium	i) Average, and ii) Improved	0.4	0.7	0.2	0.3
Hamilton (South)	74 °F	72 °F	55% RH	88 °F	1 °F	96	Medium	i) Average, and ii) Improved	0.4	0.7	0.2	0.3
Kingston (South)	74 °F	72 °F	55% RH	81 °F	-8 °F	100	Medium	i) Average, and ii) Improved	0.4	0.7	0.2	0.3
Kitchener-Waterloo (South)	74 °F	72 °F	55% RH	84 °F	-2 °F	98	Medium	i) Average, and ii) Improved	0.4	0.7	0.2	0.3
London (South)	74 °F	72 °F	55% RH	86 °F	0 °F	104	Medium	i) Average, and ii) Improved	0.4	0.7	0.2	0.3
Mt. Forest (South)	74 °F	72 °F	55% RH	84 °F	-6 °F	103	Medium	i) Average, and ii) Improved	0.4	0.7	0.2	0.3
Niagara Falls (South)	74 °F	72 °F	55% RH	86 °F	3 °F	98	Medium	i) Average, and ii) Improved	0.4	0.7	0.2	0.3
Sarnia (South)	74 °F	72 °F	55% RH	88 °F	3 °F	97	Medium	i) Average, and ii) Improved	0.4	0.7	0.2	0.3
Simcoe (South)	74 °F	72 °F	55% RH	86 °F	1 °F	94	Medium	i) Average, and ii) Improved	0.4	0.7	0.2	0.3
St. Catharines (South)	74 °F	72 °F	55% RH	86 °F	3 °F	98	Medium	i) Average, and ii) Improved	0.4	0.7	0.2	0.3
Toronto (South)	74 °F	72 °F	55% RH	88 °F	-1 °F	95	Medium	i) Average, and ii) Improved	0.4	0.7	0.2	0.3
Trenton (South)	74 °F	72 °F	55% RH	84 °F	-6 °F	93	Medium	i) Average, and ii) Improved	0.4	0.7	0.2	0.3
Warton (South)	74 °F	72 °F	55% RH	82 °F	0 °F	102	Medium	i) Average, and ii) Improved	0.4	0.7	0.2	0.3
Windsor (South)	74 °F	72 °F	55% RH	88 °F	3 °F	99	Medium	i) Average, and ii) Improved	0.4	0.7	0.2	0.3
Barrie (Distinct)	74 °F	72 °F	55% RH	84 °F	-11 °F	94	Medium	i) Average, and ii) Improved	0.4	0.7	0.2	0.3
Muskoka (Distinct)	74 °F	72 °F	55% RH	84 °F	-15 °F	89	Medium	i) Average, and ii) Improved	0.4	0.7	0.2	0.3
Peterborough (Distinct)	74 °F	72 °F	55% RH	86 °F	-9 °F	93	Medium	i) Average, and ii) Improved	0.4	0.7	0.2	0.3
Ottawa (Distinct)	74 °F	72 °F	55% RH	86 °F	-13 °F	90	Medium	i) Average, and ii) Improved	0.4	0.7	0.2	0.3
Kapuskasing (North)	74 °F	72 °F	55% RH	82 °F	-28 °F	85	Medium	i) Average, and ii) Improved	0.4	0.7	0.2	0.3
Kenora (North)	74 °F	72 °F	55% RH	82 °F	-28 °F	86	Medium	i) Average, and ii) Improved	0.4	0.7	0.2	0.3
North Bay (North)	74 °F	72 °F	55% RH	82 °F	-18 °F	77	Medium	i) Average, and ii) Improved	0.4	0.7	0.2	0.3
St. Ste. Marie (North)	74 °F	72 °F	55% RH	84 °F	-13 °F	89	Medium	i) Average, and ii) Improved	0.4	0.7	0.2	0.3
Sudbury (North)	74 °F	72 °F	55% RH	84 °F	-19 °F	75	Medium	i) Average, and ii) Improved	0.4	0.7	0.2	0.3
Timmins (North)	74 °F	72 °F	55% RH	86 °F	-29 °F	78	Medium	i) Average, and ii) Improved	0.4	0.7	0.2	0.3
Thunder Bay (North)	74 °F	72 °F	55% RH	82 °F	-24 °F	80	Medium	i) Average, and ii) Improved	0.4	0.7	0.2	0.3

Table 4a shows the numbers for the inside design conditions, outside design conditions, and infiltration variables.

Inside Design Conditions: A cooling thermostat set-point of 74 °F for the summer and a heating thermostat set-point of 72 °F for the winter has been selected for this study as it was recommended by the geothermal system contractors for the most ideal results in terms of comfort levels for the

occupants living in the house (Marco, 2016). The relative humidity, expressed as a percent, measures the absolute humidity relative to the maximum amount of water vapour that the air can hold at that air temperature. For a given absolute humidity level, relative humidity will decrease as air warms and reduce as it cools. People typically find a relative humidity of between 30 to 60 percent most comfortable. Humidity levels above 55 percent can allow mould to grow, although levels of 70 percent are more ideal for mould growth (National Asthma Council Australia, 2016). Maintaining relative humidity (RH) levels below 65% per ASHRAE's (American Society of Heating, Refrigerating and Air-Conditioning Engineers) recommendation helps improve indoor air quality that can positively affect the health and productivity of occupants (Lennox, 2017). A relative humidity (RH) of 55% was selected based on the expert advise from different geothermal and traditional HVAC system contractors (Marco, 2016; and Sleeth, 2016).

Outside Design Conditions: The outside design temperature for summer (1% cooling design temperature) and outside design temperatures for winter (97% heating design temperature) for the 27 cities has been taken from Manual J database built into the GeoSmart Design Studio program (software used to design GSHP and HVAC units for the 2,000 square feet detached house above grade). Manual J is the name for a specific protocol (often called "Heat Load Calculation" or "Cooling Load Calculation") used to determine how much heating/cooling a home needs to stay cool and dry in the summer and warm in the winter. This load calculation process was developed by engineers in the heating and air conditioning industry and has been used for decades to accurately size heating and air-conditioning equipment (RESNET, 2011).

The summer grains of moisture is the measurement of the quantity of moisture in the outside air (Sleeth, 2016). Grains per pound (gpp) is the unit used to measure the weight of moisture in air. The number of grains per pound of dry air expresses the specific humidity of the air. Stated another way, specific humidity expresses the weight (in number of grains) of the moisture present in a pound of air (Bush, 2010). Specific humidity is the actual amount of moisture in the air. This amount is expressed in weight as the number of grains of moisture per pound of air (gpp). A grain is a unit of weight measurement with 7,000 grains equaling one pound (approximately 14 cubic feet of air weighs one pound). Psychrometric charts are used to calculate the specific humidity of air at various temperature and relative humidity conditions. Some electronic moisture meters also convert temperature and relative humidity to specific humidity (Bush, 2010).

Because of the tremendous effect temperature has on the properties of air, relative humidity is not always a good indicator of the amount of moisture present (Bush, 2010). Cooler air will hold less actual moisture than warmer air at the same relative humidity. If air temperature is 80 °F and the relative humidity is 80 percent, the specific humidity is 126 grains per pound (gpp). If the air temperature decreases to 60 °F while the relative humidity remains at 80 percent, the specific humidity is 62 gpp (Bush, 2010). It varies from region to region as it can be seen in Table 4a. The ones in black color have been acquired from the Manual J database built into the HVAC-Calc

Residential 4.0 software whereas the ones in blue color have been discussed and verified through personal communications with the CEO of GeoSmart Energy Inc. (Marco, 2016).

Infiltration: The heating and cooling loads (losses) have been calculated under two different scenarios *i.e.* (i) Average Construction Tightness, and (ii) Improved construction Tightness. The average construction tightness is normal construction with poor vapor barrier whereas the improved construction tightness is improved construction with sealed vapor barrier.

The air changes per hour (ACH) aka air change rate is the ratio of the volume of air flowing through a space in a certain period of time (*i.e.* the air flow rate) to the volume of the space (*i.e.* the room volume) (Dyro, 2004). The recommended ACH value based on a 2,000 square feet detached house above grade (3,000 square feet including basement) by HVAC-Calc Residential 4.0 program is 0.4 for summer and 0.7 for winter (average construction type) and 0.2 for summer and 0.3 for winter (improved construction type).

Table 4b: Designing of the First Floor															
Floor		North Wall				Window							Door		
Floor Area	Floor Location	Area	Wall Const.	Insulation	Wall Const.	Area	Type	Emittance of Glass	Outside Shading	Window Frame	Glass Coating	Inside Shading	Area	Material	Const.
1,000 sq.ft (20Lx50W)	Over Conditioned Space	160 sq.ft (20Lx8H)	Masonry, above grade	R-19 5 ½ in	8 or 12 in. Block	32 sq.ft	Double or Triple Pane	Clear Glass	0% no external shading	Vinyl Frame	None (clear glass)	No inside shading	18 sq.ft	Wood	Solid

South Wall				Window								Glassdoor						
Area	Wall Const.	Insulation	Wall Const.	Area	Type	Frame	Emittance of Glass	Glass Coating	Outside Shading	Inside Shading	Area	Style	Type	Frame	Emittance of Glass	Glass Coating	Outside Shading	Inside Shading
160 sq.ft (20Lx8H)	Masonry, above grade	R-19 5 ½ in	8 or 12 in. Block	16 sq.ft	Double or Triple Pane	Vinyl Frame	Clear Glass	None (clear glass)	0% no external shading	No inside shading	24 sq.ft (4Lx6H)	Sliding glass door	Double Pane	Wood or Vinyl	Clear Glass	None (clear glass)	0% no external shading	No inside shading

East Wall				Window							
Area	Wall Const.	Insulation	Wall Const.	Area	Type	Frame	Emittance of Glass	Glass Coating	Outside Shading	Inside Shading	
400 sq.ft (50Lx8H)	Masonry, above grade	R-19 5 ½ in	8 or 12 in. Block	40 sq.ft	Double or Triple Pane	Vinyl	Clear Glass	None (clear glass)	0% no external shading	No inside shading	

West Wall				Window							
Area	Wall Const.	Insulation	Wall Const.	Area	Type	Frame	Emittance of Glass	Glass Coating	Outside Shading	Inside Shading	
400 sq.ft (50Lx8H)	Masonry, above grade	R-19 5 ½ in	8 or 12 in. Block	40 sq.ft	Double or Triple Pane	Vinyl	Clear Glass	None (clear glass)	0% no external shading	No inside shading	

Table 4b shows the construction design of the first floor.

First Floor: The floor area is 1,000 square feet (20L x 50H) with the floor location based on over conditioned space.

North Wall: The area of the north wall is 160 square feet (20L x 8H) with wall construction type of masonry, above grade with 8 or 12 inch block. An insulation of R-19 5 ½ inch is used.

North Wall Windows: Two windows of 16 square feet (4L x 4H) adding to an area of 32 square feet is constructed on the north wall. The ‘*double pane*’ windows were selected for the cities of Cambridge (South), Chatham (South), Guelph (South), Hamilton (South), Kingston (South), Kitchener-Waterloo (South), London (South), Mt. Forrest (South), Niagara Falls (South), Peterborough (Distinct), Sarnia (South), Simcoe (South), St. Catharines (South), Toronto (South), Trenton (South), Wiarton (South), and Windsor (South) as the 97% Heating Design Temperature in these cities is higher than -10 °F (*i.e.* between -1 °F and -9 °F) (Figure 41). On the other hand, ‘*Triple Pane*’ windows were selected for Barrie (Distinct), Muskoka (Distinct), Ottawa (Distinct), Kapuskasing (North), Kenora (North), North Bay (North), Sault Ste. Marie (North), Sudbury (North), Timmins (North), and Thunder Bay (North) as the 97% Heating Design Temperature in these cities is -10 °F or less (*i.e.* between -10 °F and -29 °F) (Figure 41).

The option of clear glass, 0% no external shading, and vinyl frame is selected for emittance of glass, outside shading, and window frame, respectively. No glass coating and no inside shading was chosen in the simulation.

North Wall Door: A door with an area of 18 square feet made up of wood with solid construction type is selected.

South Wall: The same parameters of north wall has been applied with an area of 160 square feet, wall construction type of masonry, above grade with 8 or 12 inch block, and an insulation of R-19 5 ½ inch.

South Wall Windows: Two windows of 8 square feet (2L x 4H) with a total area of 16 square feet is constructed on the south wall. The same rule applies for double v/s triple pane as it was done for the north wall windows. The same option of clear glass, 0% no external shading, vinyl frame, no glass coating, and no inside shading was selected as it was chosen for the north wall windows.

South Wall Glasdoor: A sliding glassdoor with an area of 24 square feet (4L x 6H), double pane glass, and wood or vinyl frame type was selected. An option of clear glass with no coating, 0% no external shading, and no inside shading was applied.

East and West Wall: The east wall has a total area of 400 square feet (50L x 8H) with wall construction type of masonry, above grade and 8 or 12 inch block with an insulation of R-19 5 ½ inch.

East and West Wall Windows: Three windows (16 square feet (4L x 4H); 12 square feet (3L x 4H); and 12 square feet (3L x 4H)) with a total area of 40 square feet were constructed on the east wall. Vinyl frame, clear glass, no coating, 0% no external shading, and no inside shading with double or triple pane option for selected cities was applied.

Wall to Window Ratio: The north wall, south wall, east wall, and west wall windows are 20%, 10%, 10%, and 10% of their wall sizes, respectively for the first floor.

Insulation Type: The insulation designated for the north, south, east, and west wall for the first floor was R-19 5 ½ inches.

Table 4c: Designing of the Second Floor														
People		Floor		North Wall				Window						
Adult	Children	Floor Area	Floor Location	Area	Wall Const.	Insulation	Wall Const.	Area	Type	Emittance of Glass	Outside Shading	Window Frame	Glass Coating	Inside Shading
2	2	1,000 sq.ft (20Lx50W)	Over Conditioned Space	160 sq.ft (20Lx8H)	Masonry, above grade	R-19 5 ½ in	8 or 12 in. Block	16 sq.ft	Double or Triple Pane	Clear Glass	0% no external shading	Vinyl Frame	None (clear glass)	No inside shading

South Wall				Window						
Area	Wall Const.	Insulation	Wall Const.	Area	Type	Frame	Emittance of Glass	Glass Coating	Outside Shading	Inside Shading
160 sq.ft (20Lx8H)	Masonry, above grade	R-19 5 ½ in	8 or 12 in. Block	16 sq.ft	Double or Triple Pane	Vinyl Frame	Clear Glass	None (clear glass)	0% no external shading	No inside shading

East Wall				Window						
Area	Wall Const.	Insulation	Wall Const.	Area	Type	Frame	Emittance of Glass	Glass Coating	Outside Shading	Inside Shading
400 sq.ft (50Lx8H)	Masonry, above grade	R-19 5 ½ in	8 or 12 in. Block	40 sq.ft	Double or Triple Pane	Vinyl	Clear Glass	None (clear glass)	0% no external shading	No inside shading

West Wall				Window							Ceiling			
Area	Wall Const.	Insulation	Wall Const.	Area	Type	Frame	Emittance of Glass	Glass Coating	Outside Shading	Inside Shading	Area	Type	Roof Color	Insulation Above Ceiling
400 sq.ft (50Lx8H)	Masonry, above grade	R-19 5 ½ in	8 or 12 in. Block	40 sq.ft	Double or Triple Pane	Vinyl	Clear Glass	None (clear glass)	0% no external shading	No inside shading	1,000 sq.ft	Under Ventilated Attic	Dark	R-30 (8-9inch)

Table 4c shows the construction design of the second floor.

Second Floor: The floor area is 1,000 square feet (20L x 50H) with the floor location based on over conditioned space designed for four living occupants (2 adults and 2 children).

North Wall: The area of the north wall is 160 square feet (20L x 8H) with exactly the same parameters of the north wall for the first floor *i.e.* wall construction type of masonry, above grade, 8 or 12 inch block and an insulation type of R-19 5 ½ inch.

North Wall Windows: Same as the north wall windows of the first floor.

South Wall: Same design with respect to the south wall of the first floor.

South Wall Windows: Same metrics used for the south wall windows of the first floor. There is no glassdoor constructed here.

East and West Wall: Same schematic as applied to the east and west wall of the first floor.

East and West Wall Windows: Same representation as the east and west wall windows of the first floor.

Wall to Window Ratio: Same ratios were used with respect to the first floor.

Insulation Type: The value of R-19 5 ½ inches for the north, south, east, and west wall (same as first floor) was applied.

Ceiling: A ceiling with an area of 1,000 square feet (20L x 8H) with under ventilated attic type and a dark roof color was applied. The value of R-30 (8-9 inch) was selected for the insulation above ceiling.

Table 4d: Designing of the Basement													
Floor			North Wall Below Grade				Window						
Floor Area	Floor Location	Floor Type	Area	Wall Const.	Insulation	Wall Const.	Area	Type	Emittance of Glass	Outside Shading	Window Frame	Glass Coating	Inside Shading
1,000 sq.ft (20Lx50W)	Basement floor, 2' or more below grade	Concrete	160 sq.ft (20Lx8H)	Block or brick, extends to 5' below grade	R-19 5 ½ in	8 or 12 in. Block	3 sq.ft	Double or Triple Pane	Clear Glass	0% no external shading	Vinyl Frame	None (clear glass)	No inside shading

South Wall Below Grade				Window						
Area	Wall Const.	Insulation	Wall Const.	Area	Type	Frame	Emittance of Glass	Glass Coating	Outside Shading	Inside Shading
160 sq.ft (20Lx8H)	Block or brick, extends to 5' below grade	R-19 5 ½ in	8 or 12 in. Block	3 sq.ft	Double or Triple Pane	Vinyl Frame	Clear Glass	None (clear glass)	0% no external shading	No inside shading

East Wall Below Grade				Window						
Area	Wall Const.	Insulation	Wall Const.	Area	Type	Frame	Emittance of Glass	Glass Coating	Outside Shading	Inside Shading
400 sq.ft (50Lx8H)	Block or brick, extends to 5' below grade	R-19 5 ½ in	8 or 12 in. Block	3 sq.ft	Double or Triple Pane	Vinyl	Clear Glass	None (clear glass)	0% no external shading	No inside shading

West Wall Below Grade				Window						
Area	Wall Const.	Insulation	Wall Const.	Area	Type	Frame	Emittance of Glass	Glass Coating	Outside Shading	Inside Shading
400 sq.ft (50Lx8H)	Block or brick, extends to 5' below grade	R-19 5 ½ in	8 or 12 in. Block	3 sq.ft	Double or Triple Pane	Vinyl	Clear Glass	None (clear glass)	0% no external shading	No inside shading

Table 4d shows the construction design of the basement.

Basement Floor: A 1,000 square feet (20L x 50H) area with the floor location built on ‘basement floor, 2’ or more below grade’ option was applied. A concrete floor type was selected.

North Wall: Same parameters as the north wall of the first and second floor with the only replacement of ‘masonry, above grade’ to ‘block or brick, extends to 5’ below grade’ for the wall construction type.

North Wall Windows: One window of 3 square feet (1L x 3H) is constructed on the north wall with the same preferences of clear glass, 0% no external shading, vinyl frame, no glass coating, and no inside shading as done for the north wall windows of the first and second floor.

South Wall: Same as the north wall of the basement.

South Wall Windows: Same as the north wall windows of the basement.

East and West Wall: Same schematic as applied to the east and west wall of the first and second floor with the exception of replacing ‘masonry, above grade’ to ‘block or brick, extends to 5’ below grade’ for the wall construction type.

East and West Wall Windows: Same representation as the east and west wall windows of the first and second floor with the exception of replacing ‘masonry, above grade’ to ‘block or brick, extends to 5’ below grade’ for the wall construction type.

Heating and Cooling Loads/Losses

Table 4e shows the heating and cooling loads (losses) for the northern, southern, and distinct regions in an ascending order. In addition, it also depicts the % change if the construction is upgraded from average to best. It can be clearly seen that the heating loads (losses) goes down by 22% – 23% whereas the cooling loads (losses) goes down by 4% – 8% when switched from average construction to improved construction type. The reduction in heating loads by a higher margin than cooling loads is due to the high heating design delta T (dt) and low cooling design delta T (dt) temperatures (see table 4h). The heating loads (in btu-h) are on the lower side for the southern cities and higher for the northern cities. In contrast, the cooling loads (in btu-h) are on the lower side for the northern cities and higher for the southern cities. The distinct region varies in both heating and cooling loads scenarios.

Cities	Average Construction Tightness	Improved Construction Tightness	Difference in Heating Loads	Cities	Average Construction Tightness	Improved Construction Tightness	Difference in Cooling Loads
	Heating Loads (in btu-h)	Heating Loads (in btu-h)	(% Change)		Cooling Loads (in btu-h)	Cooling Loads (in btu-h)	(% Change)
Chatham (South)	37,292	29,196	-22%	North Bay (North)	19,302	18,542	-4%
Niagara Falls (South)	37,292	29,196	-22%	Thunder Bay (North)	19,520	18,651	-4%
Sarnia (South)	37,292	29,196	-22%	Sudbury (North)	19,781	18,978	-4%
St. Catharines (South)	37,292	29,196	-22%	Kapuskasing (North)	19,883	18,832	-5%
Windsor (South)	37,292	29,196	-22%	Kenora (North)	19,955	18,869	-5%
Hamilton (South)	38,377	30,046	-22%	Timmins (North)	20,619	19,588	-5%
Simcoe (South)	38,377	30,046	-22%	Muskoka (Distinct)	20,797	19,485	-6%
London (South)	38,911	30,463	-22%	Sault Ste. Marie (North)	20,797	19,485	-6%
Warton (South)	38,911	30,463	-22%	Barrie (Distinct)	21,159	19,667	-7%
Toronto (South)	39,452	30,887	-22%	Ottawa (Distinct)	21,489	20,024	-7%
Cambridge (South)	39,996	31,313	-22%	Kingston (South)	21,742	20,207	-7%
Guelph (South)	39,996	31,313	-22%	Warton (South)	22,252	20,585	-7%
Kitchener-Waterloo (South)	39,996	31,313	-22%	Trenton (South)	22,325	20,868	-7%
Barrie (Distinct)	41,635	31,896	-23%	Guelph (South)	22,615	21,013	-7%
Mt. Forest (South)	42,159	33,007	-22%	Cambridge (South)	22,687	21,050	-7%
Trenton (South)	42,159	33,007	-22%	Kitchener-Waterloo (South)	22,687	21,050	-7%
Ottawa (Distinct)	42,644	32,671	-23%	Peterborough (Distinct)	23,047	21,472	-7%
Sault Ste. Marie (North)	42,644	32,671	-23%	Mt. Forest (South)	23,050	21,231	-8%
Kingston (South)	43,237	33,850	-22%	Simcoe (South)	23,119	21,509	-7%
Muskoka (Distinct)	43,639	33,431	-23%	Niagara Falls (South)	23,409	21,654	-7%
Peterborough (Distinct)	43,783	34,279	-22%	St. Catharines (South)	23,409	21,654	-7%
North Bay (North)	45,145	34,585	-23%	London (South)	23,845	21,871	-8%
Sudbury (North)	45,648	34,971	-23%	Toronto (South)	23,922	22,157	-7%
Thunder Bay (North)	48,159	36,895	-23%	Hamilton (South)	23,994	22,193	-8%
Kapuskasing (North)	50,168	38,435	-23%	Sarnia (South)	24,067	22,229	-8%
Kenora (North)	50,168	38,435	-23%	Windsor (South)	24,212	22,302	-8%
Timmins (North)	50,671	38,820	-23%	Chatham (South)	24,357	22,375	-8%

The heating and cooling losses in btu-h per square feet for a 2,000 square feet detached house above grade for the cities in the northern, southern, and distinct regions based on the simulation in the ‘HVAC-Calc Residential 4.0’ software can be seen in table 4f below:

Table 4f: Loads (Losses) Per Square Feet

	Average Construction Tightness	Improved Construction Tightness	Difference in Heating Loads		Average Construction Tightness	Improved Construction Tightness	Difference in Cooling Loads
Cities	Heating Loads (in btu-h) per Square Feet	Heating Loads (in btu-h) per Square Feet	(% Change)	Cities	Cooling Loads (in btu-h) per Square Feet	Cooling Loads (in btu-h) per Square Feet	(% Change)
Chatham (South)	19	15	-22%	North Bay (North)	10	9	-4%
Niagara Falls (South)	19	15	-22%	Thunder Bay (North)	10	9	-4%
Sarnia (South)	19	15	-22%	Sudbury (North)	10	9	-4%
St. Catharines (South)	19	15	-22%	Kapuskasing (North)	10	9	-5%
Windsor (South)	19	15	-22%	Kenora (North)	10	9	-5%
Hamilton (South)	19	15	-22%	Timmins (North)	10	10	-5%
Simcoe (South)	19	15	-22%	Muskoka (Distinct)	10	10	-6%
London (South)	19	15	-22%	Sault Ste. Marie (North)	10	10	-6%
Warton (South)	19	15	-22%	Barrie (Distinct)	11	10	-7%
Toronto (South)	20	15	-22%	Ottawa (Distinct)	11	10	-7%
Cambridge (South)	20	16	-22%	Kingston (South)	11	10	-7%
Guelph (South)	20	16	-22%	Warton (South)	11	10	-7%
Kitchener-Waterloo (South)	20	16	-22%	Trenton (South)	11	10	-7%
Barrie (Distinct)	21	16	-23%	Guelph (South)	11	11	-7%
Mt. Forest (South)	21	17	-22%	Cambridge (South)	11	11	-7%
Trenton (South)	21	17	-22%	Kitchener-Waterloo (South)	11	11	-7%
Ottawa (Distinct)	21	16	-23%	Peterborough (Distinct)	12	11	-7%
Sault Ste. Marie (North)	21	16	-23%	Mt. Forest (South)	12	11	-8%
Kingston (South)	22	17	-22%	Simcoe (South)	12	11	-7%
Muskoka (Distinct)	22	17	-23%	Niagara Falls (South)	12	11	-7%
Peterborough (Distinct)	22	17	-22%	St. Catharines (South)	12	11	-7%
North Bay (North)	23	17	-23%	London (South)	12	11	-8%
Sudbury (North)	23	17	-23%	Toronto (South)	12	11	-7%
Thunder Bay (North)	24	18	-23%	Hamilton (South)	12	11	-8%
Kapuskasing (North)	25	19	-23%	Sarnia (South)	12	11	-8%
Kenora (North)	25	19	-23%	Windsor (South)	12	11	-8%
Timmins (North)	25	19	-23%	Chatham (South)	12	11	-8%

The most common practice in the HVAC industry is to use a rule of thumb *i.e.* 25 btu-h per square feet for the heating loads and 15 btu-h per square feet for the cooling loads in the southern region. However, the rule of thumb in the northern and distinct regions of Ontario for the heating and cooling loads is 30 btu-h per square feet and 15 btu-h per square feet, respectively. This can also be mentioned by saying that the cooling loads are considered to be 60% of the heating loads in the southern region and 50% in the northern and distinct regions (Marco, 2016).

3.1.1.6 Geothermal Engineering (*GeoSmart Design Studio*)

The ‘GeoSmart Design’ Studio software was used to design the horizontal ground source heat pump system (H.GSHP), vertical ground source heat pump system (V.GSHP), and traditional HVAC applications *i.e.* air conditioner, natural gas furnace, and natural gas water heater for the 2,000 square feet detached house above grade for the cities in the northern, southern, and distinct regions of Ontario. In this software, inputs are given in three stages:

Stage 1: This stage consists of variables such as: (i) location soil data, (ii) Heating and Cooling Loads (Losses) Parameters, (iii) Temperature Design Conditions, (iv) Internal Gains Calculator, and (v) Building Properties.

(i) Location Soil Data

It consists of parameters such as Deep Earth Temperature, Annual Swing Temperature, 1% Cooling Design Temperature, 97% Heating Design Temperature, Ground Lag Time, and Degree-Days. These parameters are described in detail under soil temperature variation in section 2.1.7.1 – ‘Ground and Weather Characteristics’. The values selected for these parameters can be seen in Figures 38 – 43. These are the built-in values in the ‘GeoSmart Design Studio’ software taken from the Manual J database.

(ii) Heating and Cooling Loads (Losses) Parameters

Heating and Cooling Loads (Losses)

The calculated heating and cooling loads (losses) used in the ‘GeoSmart Design Studio’ software were generated from the HVAC-Calc Residential 4.0 software (see Table 4e). There is an additional feature in the GeoSmart Design Studio that also calculates the ‘Cooling Sensible Loads’ from the Cooling Loads (losses). This can be seen in Table 4g. For proper cooling load sizing it is important to meet not only the total cooling load but also the sensible load. Many southern climates and most commercial applications will benefit from comparing the sensible capacity of the equipment with the sensible load of the building (GeoSmart Design Studio, 2016). It can be noted from Table 4g that the sensible cooling loads are 75% of the total cooling loads in the case of both average and improved construction type.

(iii) Temperature Design Conditions

Heating and Cooling Thermostat Set-Points

A heating thermostat set-point of 72°F (for winter) and a cooling thermostat set-point of 74°F (for summer) is selected for the indoor design conditions (see Table 4a). A detailed explanation can be seen in section 2.1.7.2 – ‘Calculations of Heating and Cooling Loads’ under thermostat.

Heating and Cooling Design Delta T (dt)

The heating design delta T (dt) is the difference between *heating thermostat set-point* temperature and *97% heating design* temperature whereas the cooling design delta T (dt) is the difference between *cooling thermostat set-point* temperature and *1% cooling design* temperature.

Table 4h shows the heating and cooling design delta T values for the cities in northern, southern, and distinct regions of Ontario in an ascending order. The heating design dt is on the lower side for the southern regions and higher side for the northern and distinct region. In contrast, the cooling design dt is a bit scattered with a few cities from the southern region occupying both the lower side as well as the higher side of the spectrum whereas the northern and distinct regions mostly covering the middle and the lower spots.

	Average Construction Tightness	Average Construction Tightness	Improved Construction Tightness	Improved Construction Tightness
Cities	Cooling Loads (in btu-h)	Cooling Sensible Loads (in btu-h)	Cooling Loads (in btu-h)	Cooling Sensible Loads (in btu-h)
North Bay (North)	19,302	14,477	18,542	13,907
Thunder Bay (North)	19,520	14,640	18,651	13,988
Sudbury (North)	19,781	14,836	18,978	14,234
Kapuskasing (North)	19,883	14,912	18,832	14,124
Kenora (North)	19,955	14,966	18,869	14,152
Timmins (North)	20,619	15,464	19,588	14,691
Muskoka (Distinct)	20,797	15,598	19,485	14,614
Sault Ste. Marie (North)	20,797	15,598	19,485	14,614
Barrie (Distinct)	21,159	15,869	19,667	14,750
Ottawa (Distinct)	21,489	16,117	20,024	15,018
Kingston (South)	21,742	16,307	20,207	15,155
Warton (South)	22,252	16,689	20,585	15,439
Trenton (South)	22,325	16,744	20,868	15,651
Guelph (South)	22,615	16,961	21,013	15,760
Cambridge (South)	22,687	17,015	21,050	15,788
Kitchener-Waterloo (South)	22,687	17,015	21,050	15,788
Peterborough (Distinct)	23,047	17,285	21,472	16,104
Mt. Forest (South)	23,050	17,288	21,231	15,923
Simcoe (South)	23,119	17,339	21,509	16,132
Niagara Falls (South)	23,409	17,557	21,654	16,241
St. Catharines (South)	23,409	17,557	21,654	16,241
London (South)	23,845	17,884	21,871	16,403
Toronto (South)	23,922	17,942	22,157	16,618
Hamilton (South)	23,994	17,996	22,193	16,645
Sarnia (South)	24,067	18,050	22,229	16,672
Windsor (South)	24,212	18,159	22,302	16,727
Chatham (South)	24,357	18,268	22,375	16,781

Cities	Heating Thermostat Set-Point Temperature (°F)	97% Heating Design Temperature (°F)	Heating Design Delta T (dt)	Cities	Cooling Thermostat Set-Point Temperature (°F)	1% Cooling Design Temperature (°F)	Cooling Design Delta T (dt)
Chatham (South)	72	3	69	Kingston (South)	74	81	7
Niagara Falls (South)	72	3	69	Warton (South)	74	82	8
Sarnia (South)	72	3	69	Kapuskasing (North)	74	82	8
St. Catharines (South)	72	3	69	Kenora (North)	74	82	8
Windsor (South)	72	3	69	North Bay (North)	74	82	8
Hamilton (South)	72	1	71	Thunder Bay (North)	74	82	8
Simcoe (South)	72	1	71	Cambridge (South)	74	84	10
London (South)	72	0	72	Guelph (South)	74	84	10
Warton (South)	72	0	72	Kitchener-Waterloo (South)	74	84	10
Toronto (South)	72	-1	73	Mt. Forest (South)	74	84	10
Cambridge (South)	72	-2	74	Trenton (South)	74	84	10
Guelph (South)	72	-2	74	Barrie (Distinct)	74	84	10
Kitchener-Waterloo (South)	72	-2	74	Muskoka (Distinct)	74	84	10
Mt. Forest (South)	72	-6	78	Sault Ste. Marie (North)	74	84	10
Trenton (South)	72	-6	78	Sudbury (North)	74	84	10
Kingston (South)	72	-8	80	London (South)	74	86	12
Peterborough (Distinct)	72	-9	81	Niagara Falls (South)	74	86	12
Barrie (Distinct)	72	-11	83	Simcoe (South)	74	86	12
Ottawa (Distinct)	72	-13	85	St. Catharines (South)	74	86	12
Sault Ste. Marie (North)	72	-13	85	Ottawa (Distinct)	74	86	12
Muskoka (Distinct)	72	-15	87	Peterborough (Distinct)	74	86	12
North Bay (North)	72	-18	90	Timmins (North)	74	86	12
Sudbury (North)	72	-19	91	Chatham (South)	74	88	14
Thunder Bay (North)	72	-24	96	Hamilton (South)	74	88	14
Kapuskasing (North)	72	-28	100	Sarnia (South)	74	88	14
Kenora (North)	72	-28	100	Toronto (South)	74	88	14
Timmins (North)	72	-29	101	Windsor (South)	74	88	14

Begin Cooling Temperature

Most modern buildings and homes have only two modes of space conditioning; heating and cooling. However many homes still prefer three modes of space conditioning; *heating*, *cooling*, and *venting (open windows)* to allow flexibility. In GeoSmart Design Studio software, the user can select the venting mode temperatures. In other words when the home needs only a little cooling but the outdoor temp is below the cooling set-point (<74 °F), the GeoSmart Energy equipment allows the home to vent the heat out. Then as outdoor increases to equal the 'Begin Cooling at' set-point the windows are closed and the GeoSmart Energy system begins cooling mode with the equipment (GeoSmart Design Studio, 2016). A temperature of 68 °F was selected for this simulation as recommended by the team of GeoSmart Energy Inc. (Marco, 2016).

Hot Water Set-Point and Hot Water Users

The water heater set-point is typically between 130-140 °F. A set-point of 150 °F can cause scalding and 120 °F may not provide water hot enough to disinfect dishes and utensils. However, some dishwashers can boost the temperature themselves making 110-120 °F a realistic set-point (Marco, 2016). In this simulation, a set-point of 130 °F was selected on the recommendation of the team of GeoSmart Energy Inc.

The GeoSmart Design Studio uses the standard ASHRAE (American Society of Heating, Refrigerating and Air-Conditioning Engineers) *i.e.* 20 gallons per day per person for the first two people and 15 gallons per day for each additional person. For example a family of four would use

70 gallons of hot water per day (20+20+15+15=70) (GeoSmart Design Studio, 2016). Four hot water users (*i.e.* 2 adults and 2 children) were considered for this research project.

(iv) Internal Gains Calculator

It consists of level selection (low, average, and high) for factors such as *lights/appliance load per square feet, occupancy per square feet, solar gain per square feet, and building load per square feet*. The average level was selected for all the four factors.

Since heating loads are calculated without accounting for solar gains, some estimation must be done to determine heat gain internally generated in the home that would tend to offset the heating load of the building. These "internal gains" include base lights and appliances, occupancy load, and solar gains (accounted for in cooling but not heating). The internal gains calculator attempts to estimate this.

Lights/appliance Load per ft²: If the home is small it will still have the same appliance load with a kitchen and lighting etc. For example, a small 1500 ft² home with a family of 6 would more than likely have a lot of activity in every room (lights, stereos, T.Vs, *etc.*) and still have a full kitchen. This represents a *high* load per ft². On the other hand, an elderly couple in a 3,200 ft² home would more than likely only have limited activities in each room and this would be *low* load per ft² (GeoSmart Design Studio, 2016).

Occupancy Load per ft²: The same principle of a small 1500 ft² home with a family of 6 with high activity leading to *high* occupancy per ft² and an elderly couple in a large 3,200 ft² home with limited activities in each room leading to *low* occupancy per ft² applies here (GeoSmart Design Studio, 2016).

Solar Gains per ft²: Solar gains are not taken into account in the heating design load calculation. Therefore, this is used to describe the relative amount of solar gain that would be present in the home. For example a burned up home with very few windows or a home in a dense wooded lot would exhibit *low* solar gains per ft². On the other hand, a passive solar home with large south facing windows would be *high* solar gains per ft² (GeoSmart Design Studio, 2016).

Building Load per ft²: An estimate of the construction quality must be made to estimate the heat loss of the building relative to the overall size of the structure. For example a 45,000 btu/hr loss for a 1,700 sq. ft farm house with little insulation and high infiltration would be *high* building load per square foot while a 45,000 btu/hr loss for a 4,200 sq. ft super insulated home with very tight construction would be low building load per square foot. The latter example will tend to be affected more by internal gains estimation because the tight construction will hold the heat in (GeoSmart Design Studio, 2016).

(v) Building Properties

It shows the result of the internal gains calculator by displaying the building balance point, the effective Co, and the internal gains for the structure (see Table 4i)

Table 4i: Building Properties									
	Average Construction Tightness	Improved Construction Tightness		Average Construction Tightness	Improved Construction Tightness		Average Construction Tightness		Improved Construction Tightness
Cities	Building Balance Point (°F)	Building Balance Point (°F)	Cities	Effective Co.	Effective Co.	Cities	Internal Gains (btu-h)	Cities	Internal Gains (btu-h)
Cambridge (South)	55.8	55.8	Chatham (South)	0.740	0.740	Sarnia (South)	5,579	Sarnia (South)	4,368
Guelph (South)	56.9	56.9	Niagara Falls (South)	0.740	0.740	Timmins (North)	5,752	Timmins (North)	4,406
Barrie (Distinct)	57.4	57.4	St. Catharines (South)	0.740	0.740	St. Catharines (South)	5,783	St. Catharines (South)	4,527
North Bay (North)	57.8	57.8	Windsor (South)	0.740	0.740	Sudbury (North)	5,972	Sudbury (North)	4,575
Chatham (South)	58.6	58.6	Hamilton (South)	0.747	0.747	Kitchener-Waterloo (South)	5,978	Sault Ste. Marie (North)	4,592
Windsor (South)	58.7	58.7	Sarnia (South)	0.747	0.747	Peterborough (Distinct)	5,983	Muskoka (Distinct)	4,605
Simcoe (South)	59.2	59.2	Simcoe (South)	0.747	0.747	Sault Ste. Marie (North)	5,993	Kapuskasing (North)	4,677
Ottawa (Distinct)	59.2	59.2	Cambridge (South)	0.757	0.757	Muskoka (Distinct)	6,011	Kitchener-Waterloo (South)	4,680
London (South)	59.3	59.3	London (South)	0.757	0.757	Kapuskasing (North)	6,105	Peterborough (Distinct)	4,684
Kenora (North)	59.4	59.4	Toronto (South)	0.757	0.757	Thunder Bay (North)	6,175	Thunder Bay (North)	4,731
Toronto (South)	59.5	59.5	Trenton (South)	0.757	0.757	Niagara Falls (South)	6,261	Kenora (North)	4,829
Trenton (South)	59.5	59.5	Guelph (South)	0.767	0.767	Kenora (North)	6,302	Niagara Falls (South)	4,902
Thunder Bay (North)	59.7	59.7	Kingston (South)	0.767	0.767	Kingston (South)	6,368	Ottawa (Distinct)	4,919
Hamilton (South)	59.8	59.8	Kitchener-Waterloo (South)	0.767	0.767	Warton (South)	6,391	Kingston (South)	4,986
Kapuskasing (North)	59.8	59.8	Warton (South)	0.767	0.767	Ottawa (Distinct)	6,421	Warton (South)	5,003
Mt. Forest (South)	59.9	59.9	Barrie (Distinct)	0.767	0.767	Mt. Forest (South)	6,529	Mt. Forest (South)	5,112
Muskoka (Distinct)	60.0	60.0	Peterborough (Distinct)	0.767	0.767	Hamilton (South)	6,617	Hamilton (South)	5,181
Sault Ste. Marie (North)	60.1	60.1	Mt. Forest (South)	0.777	0.777	Trenton (South)	6,746	Trenton (South)	5,282
Sudbury (North)	60.1	60.1	Ottawa (Distinct)	0.777	0.777	Toronto (South)	6,758	Toronto (South)	5,291
Kingston (South)	60.2	60.2	Muskoka (Distinct)	0.787	0.787	London (South)	6,881	London (South)	5,387
Warton (South)	60.2	60.2	North Bay (North)	0.787	0.787	Simcoe (South)	6,899	Simcoe (South)	5,401
Niagara Falls (South)	60.4	60.4	Sault Ste. Marie (North)	0.787	0.787	North Bay (North)	7,133	North Bay (North)	5,464
Timmins (North)	60.5	60.5	Sudbury (North)	0.800	0.800	Windsor (South)	7,211	Barrie (Distinct)	5,615
Kitchener-Waterloo (South)	60.9	60.9	Kenora (North)	0.803	0.803	Chatham (South)	7,260	Windsor (South)	5,646
Peterborough (Distinct)	60.9	60.9	Thunder Bay (North)	0.803	0.803	Barrie (Distinct)	7,329	Chatham (South)	5,684
St. Catharines (South)	61.3	61.3	Kapuskasing (North)	0.813	0.813	Guelph (South)	8,155	Guelph (South)	6,384
Sarnia (South)	61.7	61.7	Timmins (North)	0.813	0.813	Cambridge (South)	8,769	Cambridge (South)	6,866

There is no difference in the *building balance point* and the *effective co.* between the average construction and improved construction type. In building balance point, the cities vary from all the regions with southern region dominating both sides of the spectrum. As far as the effective co. is concerned, the cities in the southern region are on the lower side and cities in the distinct and northern region are on the higher side. On the contrary, the majority of the cities in southern region are on the higher end of the spectrum for *internal gains* in both average and improved construction type scenario.

Stage 2: This phase is based on the designing of the HVAC units (V.GSHP, H.GSHP, and Traditional Energy Applications). The steps consist of: (i) Selection of the Unit Type, (ii) Capacity Sizing, (iii) Loop Circuit Layout, (iv) Trenching and Borehole Configurations, and (v) Properties Assessment of Different Soil/Rock Type.

(i) Selection of the Unit Type

Vertical and Horizontal Ground Source Heat Pump (GSHP) Systems

Unit: In this research project, ‘VI Series Variable Capacity’ model with the water heater ‘Electric with Geo Assist’ from the GeoSmart Energy brand was selected for the vertical and horizontal ground source heat pump systems (GSHPs). It is one of the most advanced and highly efficient GSHP system ever manufactured that features a variable capacity compressor that can run at as little as 20% of normal operation for maximum comfort, and efficiency (Marco, 2016; GeoSmart Energy Inc., 2016). The intelligent system then scales its output based on current weather conditions and the comfort requirements to ensure the right amount of space heating and cooling conditioning (GeoSmart Energy Inc., 2016).

This variable capacity system features the Danfoss Performer® VRJ variable speed compressor, a scroll compressor that uses an external variable frequency drive (VFD) — also known as an inverter — to slow or speed up the AC motor that rotates the scroll. This method varies refrigerant flow by actually changing the RPM of the scroll (GeoSmart Energy Inc., 2016). It is AHRI Performance Certified® by the Air-Conditioning, Heating and Refrigeration Institute, is safety listed by ETL (Electrical Testing Labs) and exceeds performance standards for the ENERGY STAR® rating (GeoSmart Energy Inc., 2016).

Refrigerant: This variable capacity unit is based on R-410A refrigerant. As of 2010, R-22 refrigerant was discontinued for use in HVAC systems as it was a hydro-chlorofluorocarbon (HCFC) that contributed to ozone depletion (Thien, 2012). R-410A is a hydro-fluorocarbon (HFC) that doesn’t damage the ozone layer (Thien, 2012). It has zero ODP (Ozone Depletion Potential) value (The Linde Group, 2017).

Air Conditioner (AC)

Unit: A ‘13 SEER single stage-R410A PSC (permanent split capacitor)’ was selected for the comparison with the ‘VI Series Variable Capacity’ vertical and horizontal GSHP units. This unit is also based on R-410A refrigerant. A 13 SEER AC unit is the cheapest option available in the market for consumers in terms of installation cost. In some cases, it is the only option available for installation as some of the old construction residential dwellings are not compatible with any AC unit that is more than 13 SEER (Kimia, 2017). All the AC units under 13 SEER have been discontinued in Ontario (Kimia, 2017).

Refrigerant: R-410A can absorb and release more heat than R-22 *i.e.* air conditioning compressor can run cooler, reducing the risk of compressor burnout due to overheating. R-410A also functions at a higher pressure than R-22, so new compressors are built to withstand greater stresses, reducing

the chance for cracking. If you were to put R-410A refrigerant into a system designed for R-22, the pressure would be too much and the unit would break (Thien, 2012). All air conditioners use an oil to keep the compressor lubricated during operation. R-22 air conditioners use mineral oil and R-410A systems use synthetic oil. The synthetic oil is generally more soluble with R-410A than mineral oil is with R-22. This means the R-410A system operates more efficiently reducing wear and tear on the compressor (Thien, 2012).

Indoor Air Coil Selection: The equipment can have multiple combinations of condensers and air handlers/coils for AHRI ratings. Most often the largest combination is used for the highest AHRI rating as the series SEER rating. However often a much less efficient combination is actually installed in the home leading to some deceiving operating cost expectations of the homeowner (GeoSmart Design Studio, 2016). This selection allows in most cases a '**standard**' sizing (*i.e.* 3 ton indoor coil with 3 ton outdoor condensing unit) or a '**best**' selection (*i.e.* 4-5 ton indoor coil with a 3 ton condensing unit). Remember that the larger coils are often less adept at moisture removal due to the larger size and higher evaporating temperatures (GeoSmart Design Studio, 2016).

A '**standard**' indoor air coil was selected based on the recommendations of the team of GeoSmart Energy Inc. for this simulation.

Outdoor Coil Condition: Studies have shown that outdoor condensing unit condition can have a great impact on the overall performance of the system. General Electric HVAC (now American Standard), in developing their trademark 'spine fin' versus 'plate fin' condenser coils found that when comparing new condensing units to existing ones, a significant performance reduction can be seen. Frequently these condensing units are damaged, blocked by landscaping or at least extremely dirty with debris limiting the efficiency and capacity of the system. GE shows that when both the spinefin and platefin data is averaged, a 19% reduction in efficiency and 13% reduction in capacity can be observed for typical units installed in at least 18 months of continuous operation. The study also proved that even after cleaning, the coils still performed on average 6% less efficiently and showed 9% less capacity than the new coils. GDS references this study in applying these degradation factors to outdoor coils. When comparing an existing system it is recommended that this outdoor coil condition be taken into consideration (GeoSmart Design Studio, 2016; The American Standard Company, 2016).

A '**New**' outdoor coil condition means a brand new system recently installed. This selection would produce an ARI rated system without any performance reduction due to outside coil condition. On the other hand, an '**Average/Clean**' represents an average system age of 3-5 years (18 month continuous operation) that has been recently cleaned. A typical reduction in performance would be 6% lower efficiency and 9% lower capacity than 'New'. A '**Dirty**' means a poorly maintained coil that would inhibit good airflow or performance. Typical reduction in

performance of 19% in efficiency and 13% capacity can be seen in these systems (GeoSmart Design Studio, 2016).

An '**Average/Clean**' outdoor coil condition option was chosen based on the expert advice of the team of GeoSmart Energy Inc.

Fossil Furnace

Unit: A natural gas furnace unit with 90% Annual Fuel Utilization Efficiency (AFUE) and an ignition type of 'spark condensing' *i.e.* 'Gas-90%/SparkCond-PSC (permanent split capacitor)' was selected for the comparative analysis with vertical and horizontal GSHPs for space heating. This is one of the cheapest solutions (in terms of installation cost) available in the Ontario HVAC market (Marco, 2016).

A standard efficiency furnace has an AFUE of 80 percent or less, while condensing furnaces with an AFUE of 90 percent or above are considered high-efficiency models (Stephens, 2017). Spark Condensing is a further refinement in higher efficiency technology (GeoSmart Design Studio, 2016).

Water Heater

Unit: A natural gas based water heater *i.e.* 'Gas Power Vent' type was selected in this study for a comparison with vertical and horizontal GSHPs for domestic hot water usage.

(ii) Capacity Sizing

Right capacity sizing of a residential heating, ventilation, and air conditioning (HVAC) system involves primarily the selection of equipment and the accurate calculations of heating and cooling loads of a house. Selection of the equipment can have a substantial impact on the efficiency and operating costs of the system (Burdick, 2011).

In this research project, the vertical GSHP, horizontal GSHP, and traditional applications (air conditioner, natural gas furnace, and natural gas water heater) were sized as accurately as possible by making sure that the space heating and cooling loads (btu/hr) on an annual basis are completely covered. The model adopted here is based on the recommendations of the team of GeoSmart Energy Inc. The capacity sizing of the HVAC equipment must be designed in such a way that it has to cover all the hourly heating and cooling loads regardless of the capacity going a bit more (*i.e.* slightly oversized). In certain cases, it was seen in the simulation that selecting a 3 ton HVAC unit will not completely cover the hourly heating and cooling loads whereas selecting a unit above 3 ton would become slightly oversized. A detailed chart for the results of the entire simulation with respect to the hourly heating and cooling loads coverage for the cities (selected for this study) in

the northern, southern, and distinct regions under two scenarios: (i) Average Construction Type, and (ii) Improved construction Type, can be seen in Appendix B1 and B2 respectively.

The results obtained with respect to the capacity sizing (in tons) of the vertical and horizontal GSHP, and traditional HVAC applications for a 2,000 square feet detached house above grade for the cities in the northern, southern, and distinct regions of Ontario under average construction and improved construction scenarios (in an ascending order) can be analyzed in Table 4j and Table 4k, respectively.

Table 4j: Capacity (in Tons) - Average Construction Scenario								
	V.GSHP		H.GSHP		Conventional			
					Natural Gas Furnace	Natural Gas Water Heater		Air Conditioner
Cities	Capacity (in Tons)	Cities	Capacity (in Tons)	Cities	Capacity (in Tons)	Capacity (in Tons)	Cities	Capacity (in Tons)
Cambridge (South)	4.0	Cambridge (South)	4.0	Niagara Falls (South)	3.0	3.0	Cambridge (South)	2.5
Chatham (South)	4.0	Chatham (South)	4.0	Chatham (South)	3.5	3.0	Guelph (South)	2.5
Guelph (South)	4.0	Guelph (South)	4.0	London (South)	3.5	3.0	Peterborough (Distinct)	3.0
Hamilton (South)	4.0	Hamilton (South)	4.0	Sarnia (South)	3.5	3.0	Chatham (South)	3.5
London (South)	4.0	Kingston (South)	4.0	Simcoe (South)	3.5	3.0	Hamilton (South)	3.5
Mt. Forest (South)	4.0	Kitchener-Waterloo (South)	4.0	St. Catharines (South)	3.5	3.0	Kitchener-Waterloo (South)	3.5
Niagara Falls (South)	4.0	London (South)	4.0	Windsor (South)	3.5	3.0	London (South)	3.5
Sarnia (South)	4.0	Mt. Forest (South)	4.0	Sault Ste. Marie (North)	3.5	3.0	Mt. Forest (South)	3.5
Simcoe (South)	4.0	Niagara Falls (South)	4.0	Cambridge (South)	4.0	3.0	Toronto (South)	3.5
St. Catharines (South)	4.0	Sarnia (South)	4.0	Guelph (South)	4.0	3.0	Windsor (South)	3.5
Toronto (South)	4.0	Simcoe (South)	4.0	Hamilton (South)	4.0	3.0	Barrie (Distinct)	3.5
Trenton (South)	4.0	St. Catharines (South)	4.0	Kingston (South)	4.0	3.0	Muskoka (Distinct)	3.5
Windsor (South)	4.0	Toronto (South)	4.0	Kitchener-Waterloo (South)	4.0	3.0	Ottawa (Distinct)	3.5
Sault Ste. Marie (North)	4.0	Trenton (South)	4.0	Mt. Forest (South)	4.0	3.0	North Bay (North)	3.5
Kingston (South)	5.0	Warton (South)	4.0	Toronto (South)	4.0	3.0	Sault Ste. Marie (North)	3.5
Kitchener-Waterloo (South)	5.0	Windsor (South)	4.0	Trenton (South)	4.0	3.0	Timmins (North)	3.5
Warton (South)	5.0	Sault Ste. Marie (North)	4.0	Warton (South)	4.0	3.0	Thunder Bay (North)	3.5
Barrie (Distinct)	5.0	Barrie (Distinct)	5.0	Barrie (Distinct)	4.0	3.0	Niagara Falls (South)	4.0
Muskoka (Distinct)	5.0	Muskoka (Distinct)	5.0	Muskoka (Distinct)	4.0	3.0	Sarnia (South)	4.0
Ottawa (Distinct)	5.0	Ottawa (Distinct)	5.0	Ottawa (Distinct)	4.0	3.0	Simcoe (South)	4.0
Peterborough (Distinct)	5.0	Peterborough (Distinct)	5.0	Kapuskasing (North)	4.0	3.0	St. Catharines (South)	4.0
Kapuskasing (North)	5.0	Kapuskasing (North)	5.0	Kenora (North)	4.0	3.0	Warton (South)	4.0
Kenora (North)	5.0	Kenora (North)	5.0	North Bay (North)	4.0	3.0	Kenora (North)	4.0
North Bay (North)	5.0	North Bay (North)	5.0	Sudbury (North)	4.0	3.0	Sudbury (North)	4.0
Sudbury (North)	5.0	Sudbury (North)	5.0	Timmins (North)	4.0	3.0	Kingston (South)	4.5
Timmins (North)	5.0	Timmins (North)	5.0	Thunder Bay (North)	4.0	3.0	Trenton (South)	4.5
Thunder Bay (North)	5.0	Thunder Bay (North)	5.0	Peterborough (Distinct)	4.5	3.0	Kapuskasing (North)	4.5

Note: 1 Ton = 12,000 british thermal unit-hour (btu-h); 1 Ton = 3.52 Kilowatt (KW)

Table 4k: Capacity (in Tons) - Improved Construction Scenario								
	V.GSHP		H.GSHP			Conventional		
					Natural Gas Furnace	Natural Gas Water Heater		Air Conditioner
Cities	Capacity (in Tons)	Cities	Capacity (in Tons)	Cities	Capacity (in Tons)	Capacity (in Tons)	Cities	Capacity (in Tons)
Cambridge (South)	3.0	Cambridge (South)	3.0	Niagara Falls (South)	2.5	3.0	Cambridge (South)	2.5
Chatham (South)	3.0	Chatham (South)	3.0	St. Catharines (South)	2.5	3.0	Guelph (South)	2.5
Guelph (South)	3.0	Guelph (South)	3.0	Cambridge (South)	3.0	3.0	London (South)	3.0
Hamilton (South)	3.0	Hamilton (South)	3.0	Chatham (South)	3.0	3.0	Barrie (Distinct)	3.0
London (South)	3.0	London (South)	3.0	Guelph (South)	3.0	3.0	Muskoka (Distinct)	3.0
Niagara Falls (South)	3.0	Mt. Forest (South)	3.0	Hamilton (South)	3.0	3.0	Peterborough (Distinct)	3.0
Sarnia (South)	3.0	Niagara Falls (South)	3.0	Kingston (South)	3.0	3.0	Sault Ste. Marie (North)	3.0
Simcoe (South)	3.0	Sarnia (South)	3.0	Kitchener-Waterloo (South)	3.0	3.0	Chatham (South)	3.5
Windsor (South)	3.0	Simcoe (South)	3.0	London (South)	3.0	3.0	Hamilton (South)	3.5
Sault Ste. Marie (North)	3.0	St. Catharines (South)	3.0	Mt. Forest (South)	3.0	3.0	Kitchener-Waterloo (South)	3.5
Kingston (South)	4.0	Toronto (South)	3.0	Sarnia (South)	3.0	3.0	Mt. Forest (South)	3.5
Kitchener-Waterloo (South)	4.0	Windsor (South)	3.0	Simcoe (South)	3.0	3.0	Sarnia (South)	3.5
Mt. Forest (South)	4.0	Sault Ste. Marie (North)	3.0	Toronto (South)	3.0	3.0	Toronto (South)	3.5
St. Catharines (South)	4.0	Kingston (South)	4.0	Trenton (South)	3.0	3.0	Windsor (South)	3.5
Toronto (South)	4.0	Kitchener-Waterloo (South)	4.0	Warton (South)	3.0	3.0	Ottawa (Distinct)	3.5
Trenton (South)	4.0	Trenton (South)	4.0	Windsor (South)	3.0	3.0	Kenora (North)	3.5
Warton (South)	4.0	Warton (South)	4.0	Barrie (Distinct)	3.0	3.0	North Bay (North)	3.5
Barrie (Distinct)	4.0	Barrie (Distinct)	4.0	Muskoka (Distinct)	3.0	3.0	Timmins (North)	3.5
Muskoka (Distinct)	4.0	Muskoka (Distinct)	4.0	Ottawa (Distinct)	3.0	3.0	Thunder Bay (North)	3.5
Ottawa (Distinct)	4.0	Ottawa (Distinct)	4.0	Kapuskasing (North)	3.0	3.0	Niagara Falls (South)	4.0
Peterborough (Distinct)	4.0	Peterborough (Distinct)	4.0	Kenora (North)	3.0	3.0	Simcoe (South)	4.0
Kapuskasing (North)	4.0	Kapuskasing (North)	4.0	North Bay (North)	3.0	3.0	St. Catharines (South)	4.0
Kenora (North)	4.0	Kenora (North)	4.0	Sault Ste. Marie (North)	3.0	3.0	Warton (South)	4.0
North Bay (North)	4.0	North Bay (North)	4.0	Sudbury (North)	3.0	3.0	Sudbury (North)	4.0
Sudbury (North)	4.0	Sudbury (North)	4.0	Timmins (North)	3.0	3.0	Kingston (South)	4.5
Timmins (North)	4.0	Timmins (North)	4.0	Thunder Bay (North)	3.0	3.0	Trenton (South)	4.5
Thunder Bay (North)	4.0	Thunder Bay (North)	4.0	Peterborough (Distinct)	3.5	3.0	Kapuskasing (North)	4.5

Note: 1 Ton = 12,000 british thermal unit-hour (btu-h); 1 Ton = 3.52 Kilowatt (KW)

The results under average construction scenario for the capacity sizing (Table 4j) indicated a big size HVAC unit is required for majority of the cities in northern and distinct regions with respect to the vertical and horizontal GSHPs. A similar pattern can be seen with respect to the sizing of the natural gas furnace. The capacity of the natural gas water heater for domestic hot water usage was consistent for all the cities. However, a scattered chart can be seen for the air conditioner sizing unit with majority of the cities in the southern region requiring a small size AC unit whereas some needing a big size AC unit to cover the hourly heating and cooling loads. A similar pattern can be seen under the improved construction scenario (Table 4k).

Table 4l represents the % change in capacity sizing once a shift from the average construction type to improved construction type took place. It can be noticed the capacity sizing went down by 20% – 25% with respect to the vertical and horizontal GSHPs for majority of the cities in the northern, southern, and distinct regions of Ontario. A capacity size reduction between 14% – 29% can be seen for the natural gas furnace. There was no change at all for the natural gas water heater. A very few cities got the benefit of a reduced AC unit and the remaining cities stayed unchanged.

V.GSHP		H.GSHP		Conventional				
					Natural Gas Furnace	Natural Gas Water Heater	Air Conditioner	
Cities	% Change	Cities	% Change	Cities	% Change	% Change	% Change	
Cambridge (South)	-25%	Cambridge (South)	-25%	St. Catharines (South)	-29%	0%	London (South)	-14%
Chatham (South)	-25%	Chatham (South)	-25%	Cambridge (South)	-25%	0%	Barrie (Distinct)	-14%
Guelph (South)	-25%	Guelph (South)	-25%	Guelph (South)	-25%	0%	Muskoka (Distinct)	-14%
Hamilton (South)	-25%	Hamilton (South)	-25%	Hamilton (South)	-25%	0%	Sault Ste. Marie (North)	-14%
London (South)	-25%	London (South)	-25%	Kingston (South)	-25%	0%	Sarnia (South)	-13%
Niagara Falls (South)	-25%	Mt. Forest (South)	-25%	Kitchener-Waterloo (South)	-25%	0%	Kenora (North)	-13%
Sarnia (South)	-25%	Niagara Falls (South)	-25%	Mt. Forest (South)	-25%	0%	Cambridge (South)	0%
Simcoe (South)	-25%	Sarnia (South)	-25%	Toronto (South)	-25%	0%	Chatham (South)	0%
Windsor (South)	-25%	Simcoe (South)	-25%	Trenton (South)	-25%	0%	Guelph (South)	0%
Sault Ste. Marie (North)	-25%	St. Catharines (South)	-25%	Warton (South)	-25%	0%	Hamilton (South)	0%
Kingston (South)	-20%	Toronto (South)	-25%	Barrie (Distinct)	-25%	0%	Kingston (South)	0%
Kitchener-Waterloo (South)	-20%	Windsor (South)	-25%	Muskoka (Distinct)	-25%	0%	Kitchener-Waterloo (South)	0%
Warton (South)	-20%	Sault Ste. Marie (North)	-25%	Ottawa (Distinct)	-25%	0%	Mt. Forest (South)	0%
Barrie (Distinct)	-20%	Barrie (Distinct)	-20%	Kapuskasing (North)	-25%	0%	Niagara Falls (South)	0%
Muskoka (Distinct)	-20%	Muskoka (Distinct)	-20%	Kenora (North)	-25%	0%	Simcoe (South)	0%
Ottawa (Distinct)	-20%	Ottawa (Distinct)	-20%	North Bay (North)	-25%	0%	St. Catharines (South)	0%
Peterborough (Distinct)	-20%	Peterborough (Distinct)	-20%	Sudbury (North)	-25%	0%	Toronto (South)	0%
Kapuskasing (North)	-20%	Kapuskasing (North)	-20%	Timmins (North)	-25%	0%	Trenton (South)	0%
Kenora (North)	-20%	Kenora (North)	-20%	Thunder Bay (North)	-25%	0%	Warton (South)	0%
North Bay (North)	-20%	North Bay (North)	-20%	Peterborough (Distinct)	-22%	0%	Windsor (South)	0%
Sudbury (North)	-20%	Sudbury (North)	-20%	Niagara Falls (South)	-17%	0%	Ottawa (Distinct)	0%
Timmins (North)	-20%	Timmins (North)	-20%	Chatham (South)	-14%	0%	Peterborough (Distinct)	0%
Thunder Bay (North)	-20%	Thunder Bay (North)	-20%	London (South)	-14%	0%	Kapuskasing (North)	0%
Mt. Forest (South)	0%	Kingston (South)	0%	Sarnia (South)	-14%	0%	North Bay (North)	0%
St. Catharines (South)	0%	Kitchener-Waterloo (South)	0%	Simcoe (South)	-14%	0%	Sudbury (North)	0%
Toronto (South)	0%	Trenton (South)	0%	Windsor (South)	-14%	0%	Timmins (North)	0%
Trenton (South)	0%	Warton (South)	0%	Sault Ste. Marie (North)	-14%	0%	Thunder Bay (North)	0%

(iii) Loop Circuit Layout and Borehole & Trenching Configurations

Vertical Ground Source Heat Pump System

The ‘Vertical 1U-Bend – 1.25” PE’ loop type was selected for the vertical ground source heat pump loop circuit layout with 180 feet per ton borehole length with a maximum depth not exceeding 540 feet per borehole. Please see table 4m for borehole configurations with respect to different capacity sizing (in Tons).

Tons	Total Length of Boreholes (in feet)	Number of Boreholes	Length per Borehole (in feet)	Average Depth per Borehole (in feet)
1	180	1	180	90
2	360	1	360	180
3	540	1	540	270
4	720	2	360	180
5	900	2	450	225
6	1,080	2	540	270

Each borehole has to be 15 feet apart from each other for heat recovery purposes (Figure 61). A 4 Ton, 5 Ton, and a 6 Ton unit requires two boreholes.

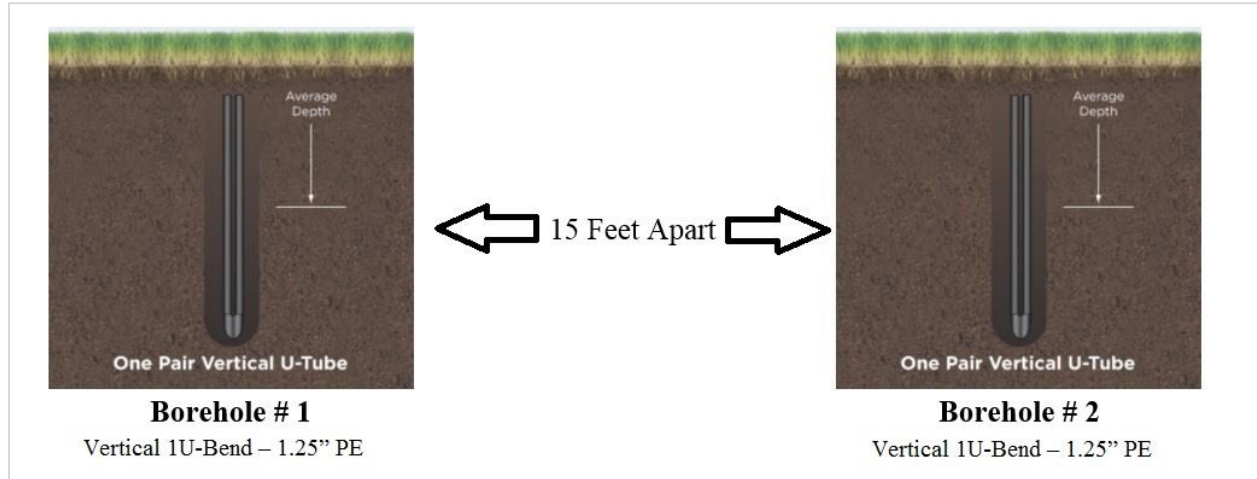

Figure 61: Configuration for Two Boreholes

The above mentioned arrangement for vertical ground source heat pump system was recommended by the President of GeoSmart Energy Inc. (Marco, 2016).

Horizontal Ground Source Heat Pump System

The ‘horizontal 2 Pipe – 0.75” PE’ loop type was selected for the horizontal ground source heat pump loop circuit layout with an average depth of 6 feet and 300 feet per ton of trenching beneath the ground. Please see table 4n for trenching configurations with respect to different capacity sizing (in Tons).

Table 4n: Trenching Configuration - Horizontal Ground Source Heat Pump (H.GSHP)				
Tons	Total Length of Trenches (in feet)	Number of Trenches	Length per Trench (in feet)	Average Depth per Trench (in feet)
1	300	1	300	6
2	600	2	300	6
3	900	3	300	6
4	1,200	4	300	6
5	1,500	5	300	6
6	1,800	6	300	6

Each trench has to be 15 feet apart from each other for heat recovery purposes (Figure 62). An extra ton H.GSHP unit requires an additional trench.

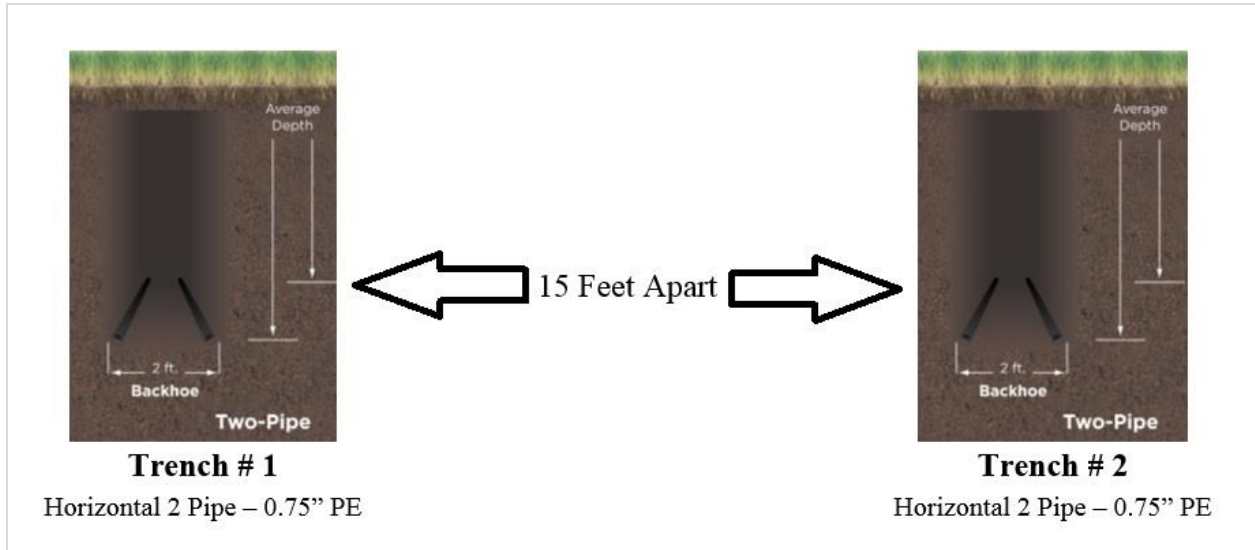

Figure 62: Configuration for Two Trenches

The above mentioned arrangement for horizontal ground source heat pump system was recommended by the President of GeoSmart Energy Inc. (Marco, 2016).

(iv) Anti-Freeze

A mixture of 75% water and 25% ethanol (Environol 2000) was selected as an anti-freeze for both V.GSHP and H.GSHP units to circulate in the loops to extract heat from the ground. This mixture provides loop fluid freeze protection down to 15°F which is 5°F below the mechanical protection that has been built into the unit. The unit will shut off before the fluid freezes.

Environol 2000 anti-freeze is environmentally safe. It has lowest NFPA (National Fire Protection Association) health warning. The heat transfer performance is 20% greater than propylene glycol. It biodegrades more readily than any other anti-freeze type. It comes as a specially designed corrosion inhibitor package (WaterFurnace, 2016).

(v) Properties Assessment of Different Soil/Rock Type

Vertical Ground Source Heat Pump

The ‘Average Rock’ soil type with a thermal conductivity of 1.40 Btu/hr-ft.-°F and thermal diffusivity of 0.96 ft²/day was selected for the vertical ground source heat pump (V.GSHP) as it is the most common medium rock densities associated with the vertical loops.

Horizontal Ground Source Heat Pump

The ‘Silt/Clay-Damp’ soil type with a thermal conductivity of 0.75 Btu/hr-ft.-°F, thermal diffusivity of 0.60 ft²/day, and moisture content of 15% was selected for the vertical ground source heat pump (V.GSHP) as it is the most common heavy soils associated with most horizontal loops.

Stage 3: This stage involves computation of the unit prices of: (i) electricity, and (ii) natural gas in Ontario. The residential household rates in Ontario for electricity and natural gas are taken from the National Energy Board (NEB) database. These rates are based on 2010 Canadian dollar (\$) value with respect to high price case scenario. A compound annual growth rate (CAGR) was used to forecast electricity and natural gas prices for the future years.

$$\text{CAGR} = \left(\frac{\text{Ending Value}}{\text{Beginning Value}} \right)^{\left(\frac{1}{\text{Number of Years}} \right)} - 1 \quad (10)$$

(i) Electricity Prices in Ontario

The electricity rates for the residential household of Ontario in the NEB database were given from the year of 2005 and projected till year 2040. The compound annual growth rate (CAGR) from 2016 to 2040 was calculated to forecast the electricity prices from 2041 to 2075 as a lifespan of 60 years for the HVAC units is considered for this study. It was found out that electricity prices increased at a CAGR of 0.58% from 2016 to 2040. The value of 0.58% was used to forecast electricity prices from 2041 to 2075 (see Figure 63). A detailed analysis can be seen in Appendix C.

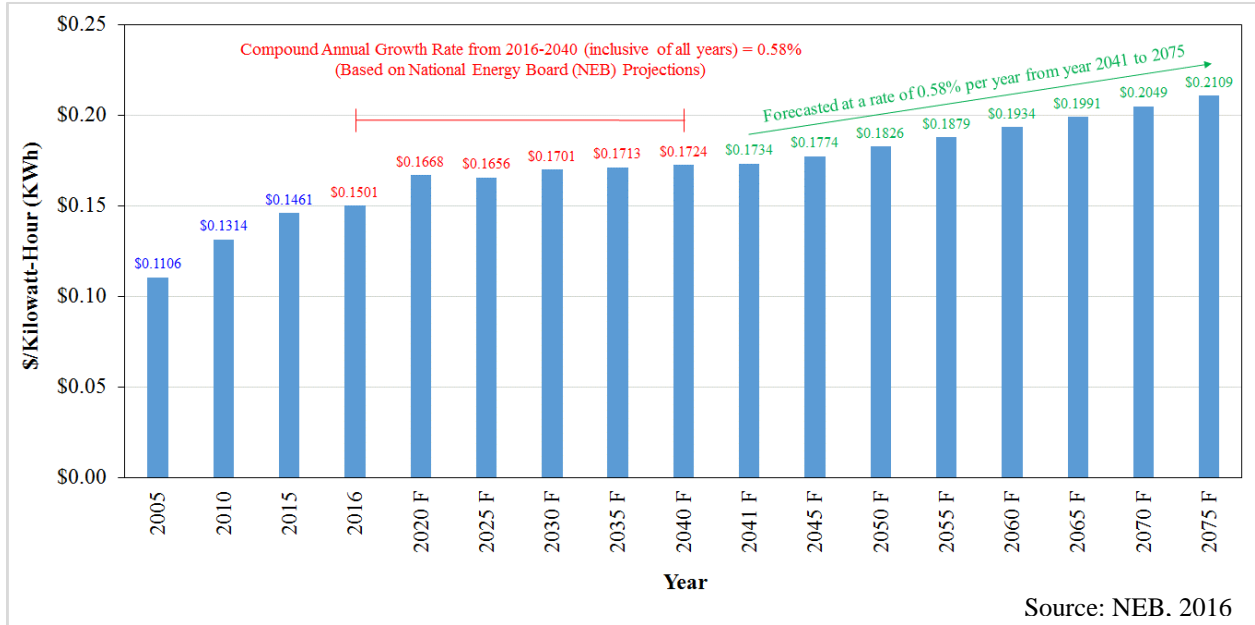

Figure 63: Ontario Electricity Rates (in \$ per kilowatt-hour); projections based on National Energy Board (NEB) Data (High Price Case - Residential - 2010 C\$ per KWh)

(ii) Natural Gas Prices in Ontario

Similarly, the natural gas rates for the residential household of Ontario in the NEB database were given from the year of 2005 and projected till year 2040. The same method was applied and a CAGR of 0.99% was used to forecast natural gas prices from 2041 to 2075 (see Figure 64).

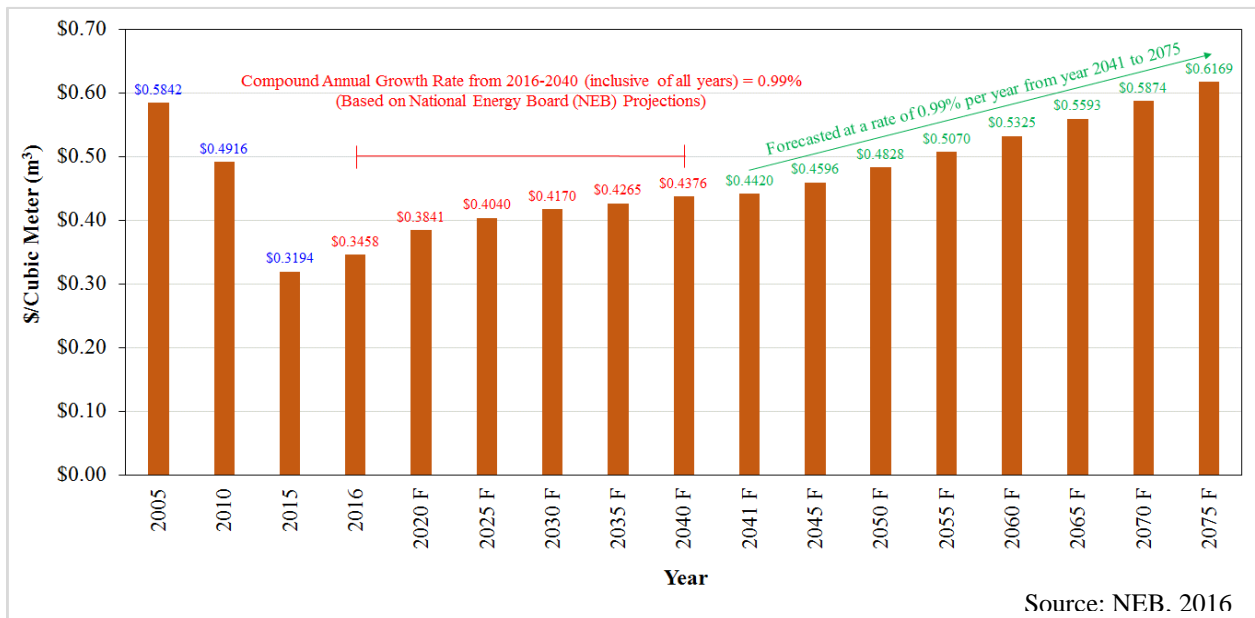

Figure 64: Ontario Natural Gas Rates (in \$ per cubic meter); projections based on National Energy Board (NEB) Data (High Price Case - Residential - 2010 C\$ per KWh)

The designing of the vertical grounds source heat pump (V.GSHP), horizontal ground source heat pump (H.GSHP), and traditional energy applications to cover the heating and cooling loads in a 2,000 square feet detached house above grade facility for 27 cities of Ontario in the 'GeoSmart Design Studio' software' has resulted in: (i) energy usage, (ii) average system efficiency output, and (iii) operating costs on an annual basis.

(i) Energy Usage

a) Space Heating Use

Table 5a: Space Heating Usage - Average Construction Scenario

V.GSHP		H.GSHP		Traditional (Natural Gas Furnace)			
	Space Heating (Electricity in KWh)		Space Heating (Electricity in KWh)		Space Heating (Component # 1) (Electricity in KWh)		Space Heating (Component # 2) (Natural Gas in m ³)
Chatham (South)	4,504	Chatham (South)	4,582	Cambridge (South)	1,348	Chatham (South)	2,235
St. Catharines (South)	4,511	St. Catharines (South)	4,588	Guelph (South)	1,410	St. Catharines (South)	2,237
Windsor (South)	4,523	Windsor (South)	4,605	Peterborough (Distinct)	1,425	Windsor (South)	2,244
Niagara Falls (South)	4,621	Niagara Falls (South)	4,700	Hamilton (South)	1,492	Niagara Falls (South)	2,264
Sarnia (South)	4,914	Sarnia (South)	4,981	Chatham (South)	1,523	Sarnia (South)	2,378
Simcoe (South)	5,016	Simcoe (South)	5,099	Windsor (South)	1,530	Simcoe (South)	2,442
Hamilton (South)	5,046	Hamilton (South)	5,129	Toronto (South)	1,558	Hamilton (South)	2,509
London (South)	5,366	London (South)	5,440	Barrie (Distinct)	1,593	London (South)	2,598
Cambridge (South)	5,378	Cambridge (South)	5,460	Kitchener-Waterloo (South)	1,625	Cambridge (South)	2,609
Toronto (South)	5,380	Toronto (South)	5,469	St. Catharines (South)	1,628	Toronto (South)	2,618
Trenton (South)	5,462	Trenton (South)	5,533	Ottawa (Distinct)	1,662	Trenton (South)	2,638
Guelph (South)	5,630	Kitchener-Waterloo (South)	5,712	Sarnia (South)	1,734	Barrie (Distinct)	2,679
Kitchener-Waterloo (South)	5,632	Guelph (South)	5,713	Muskoka (Distinct)	1,760	Guelph (South)	2,726
Barrie (Distinct)	5,665	Barrie (Distinct)	5,766	London (South)	1,776	Kingston (South)	2,726
Kingston (South)	5,720	Kingston (South)	5,792	Simcoe (South)	1,778	Kitchener-Waterloo (South)	2,726
Ottawa (Distinct)	5,868	Ottawa (Distinct)	5,998	Trenton (South)	1,779	Ottawa (Distinct)	2,786
Warton (South)	6,040	Warton (South)	6,086	North Bay (North)	1,782	Warton (South)	2,855
Peterborough (Distinct)	6,060	Peterborough (Distinct)	6,187	Mt. Forest (South)	1,794	Peterborough (Distinct)	2,887
Mt. Forest (South)	6,230	Mt. Forest (South)	6,312	Warton (South)	1,813	Muskoka (Distinct)	2,951
Muskoka (Distinct)	6,272	Muskoka (Distinct)	6,376	Kingston (South)	1,840	North Bay (North)	2,987
North Bay (North)	6,390	North Bay (North)	6,533	Niagara Falls (South)	1,928	Mt. Forest (South)	3,006
Sault Ste. Marie (North)	6,560	Sault Ste. Marie (North)	6,656	Thunder Bay (North)	2,099	Sault Ste. Marie (North)	3,071
Sudbury (North)	7,110	Sudbury (North)	7,259	Sault Ste. Marie (North)	2,102	Sudbury (North)	3,302
Thunder Bay (North)	7,907	Thunder Bay (North)	8,038	Sudbury (North)	2,107	Thunder Bay (North)	3,506
Kenora (North)	8,144	Kenora (North)	8,255	Timmins (North)	2,272	Kenora (North)	3,574
Timmins (North)	8,255	Timmins (North)	8,401	Kenora (North)	2,288	Timmins (North)	3,785
Kapuskasing (North)	8,933	Kapuskasing (North)	9,050	Kapuskasing (North)	2,659	Kapuskasing (North)	3,907

In average construction type, the rankings of the cities for space heating use in case of V.GSHP and H.GSHP came out to be similar with Chatham required the least amount of electricity usage to heat a 2,000 square feet detached house above grade and Kapuskasing at the top of list requiring the maximum amount of electricity usage to provide the desired heat.

The rankings of the cities for space heating use in case of traditional HVAC applications shows Cambridge as being the one using minimum amount of electricity and Chatham using the minimum amount of natural gas to heat a 2,000 square feet detached house above grade whereas Kapuskasing requires the maximum amount of electricity as well as natural gas to provide the required amount of heat.

The permanent split capacitor (PSC) single speed motors (consumes electricity in KWh) in natural gas furnaces are used to drive the fans in air handlers. Furnace electricity use is an especially significant expense in homes where the furnace fan is run continuously for air filtration and other reasons (Pigg, 2003). This can be analyzed in Table 5a (Component # 1) above.

Table 5b: Space Heating Usage - Improved Construction Scenario							
V.GSHP		H.GSHP		Traditional (Natural Gas Furnace)			
	Space Heating (Electricity in KWh)		Space Heating (Electricity in KWh)		Space Heating (Component # 1) (Electricity in KWh)		Space Heating (Component # 2) (Natural Gas in m ³)
Chatham (South)	3,430	Chatham (South)	3,495	Chatham (South)	1,392	St. Catharines (South)	1,746
Windsor (South)	3,445	St. Catharines (South)	3,503	Windsor (South)	1,397	Chatham (South)	1,756
Niagara Falls (South)	3,515	Windsor (South)	3,513	Cambridge (South)	1,408	Windsor (South)	1,763
St. Catharines (South)	3,518	Niagara Falls (South)	3,582	Peterborough (Distinct)	1,435	Niagara Falls (South)	1,776
Sarnia (South)	3,777	Sarnia (South)	3,831	Guelph (South)	1,472	Sarnia (South)	1,868
Simcoe (South)	3,846	Simcoe (South)	3,913	Sarnia (South)	1,486	Simcoe (South)	1,918
Hamilton (South)	3,856	Hamilton (South)	3,924	London (South)	1,515	Hamilton (South)	1,961
London (South)	4,122	London (South)	4,181	Barrie (Distinct)	1,520	Cambridge (South)	2,040
Cambridge (South)	4,135	Cambridge (South)	4,201	Hamilton (South)	1,558	London (South)	2,041
Toronto (South)	4,185	Toronto (South)	4,202	Simcoe (South)	1,624	Toronto (South)	2,047
Trenton (South)	4,242	Trenton (South)	4,323	Toronto (South)	1,626	Barrie (Distinct)	2,051
Barrie (Distinct)	4,294	Barrie (Distinct)	4,365	Muskoka (Distinct)	1,679	Trenton (South)	2,062
Guelph (South)	4,336	Guelph (South)	4,402	Kitchener-Waterloo (South)	1,697	Guelph (South)	2,131
Kitchener-Waterloo (South)	4,373	Kitchener-Waterloo (South)	4,464	Ottawa (Distinct)	1,698	Kingston (South)	2,131
Kingston (South)	4,433	Kingston (South)	4,521	Sault Ste. Marie (North)	1,755	Kitchener-Waterloo (South)	2,131
Ottawa (Distinct)	4,444	Ottawa (Distinct)	4,534	St. Catharines (South)	1,785	Ottawa (Distinct)	2,133
Warton (South)	4,678	Warton (South)	4,754	Niagara Falls (South)	1,812	Warton (South)	2,231
Peterborough (Distinct)	4,689	Peterborough (Distinct)	4,778	North Bay (North)	1,820	Muskoka (Distinct)	2,259
Muskoka (Distinct)	4,747	Muskoka (Distinct)	4,820	Trenton (South)	1,857	Peterborough (Distinct)	2,260
North Bay (North)	4,825	Mt. Forest (South)	4,877	Mt. Forest (South)	1,873	North Bay (North)	2,286
Mt. Forest (South)	4,832	North Bay (North)	4,924	Warton (South)	1,893	Mt. Forest (South)	2,350
Sault Ste. Marie (North)	4,959	Sault Ste. Marie (North)	5,038	Kingston (South)	1,921	Sault Ste. Marie (North)	2,363
Sudbury (North)	5,359	Sudbury (North)	5,462	Thunder Bay (North)	2,144	Sudbury (North)	2,528
Thunder Bay (North)	5,926	Thunder Bay (North)	6,018	Sudbury (North)	2,152	Thunder Bay (North)	2,684
Kenora (North)	6,084	Kenora (North)	6,163	Kenora (North)	2,191	Kenora (North)	2,735
Timmins (North)	6,199	Timmins (North)	6,302	Timmins (North)	2,321	Timmins (North)	2,896
Kapuskasing (North)	6,671	Kapuskasing (North)	6,754	Kapuskasing (North)	2,715	Kapuskasing (North)	2,989

In improved construction type, the rankings of the cities for space heating use in case of V.GSHP and H.GSHP came out to be similar with Chatham consuming the least amount of electricity usage whereas Kapuskasing demanding the maximum amount of electricity usage to heat a 2,000 square feet detached house above grade. The cities in the middle are shuffled up and the rankings vary because of the impact of improved construction type on the heating and cooling loads. The rankings of the cities shuffled up a lot in case of traditional HVAC applications because of the switching from average to improved construction type.

It can be noticed that in both cases (average construction type v/s improved construction type), the cities in the northern regions seems to be using a lot more electricity and natural gas as compared to the cities in southern and distinct regions (see Table 5a and Table 5b) to heat a 2,000 square feet detached house above grade.

Table 5c: Space Heating Usage - Difference (% Change)							
V.GSHP		H.GSHP		Traditional (Natural Gas Furnace)			
	% Change		% Change		% Change		% Change
Kapuskasing (North)	-25%	Kapuskasing (North)	-25%	Sault Ste. Marie (North)	-17%	Kapuskasing (North)	-23%
Kenora (North)	-25%	Kenora (North)	-25%	London (South)	-15%	Timmins (North)	-23%
Thunder Bay (North)	-25%	Thunder Bay (North)	-25%	Sarnia (South)	-14%	Kenora (North)	-23%
Timmins (North)	-25%	Timmins (North)	-25%	Windsor (South)	-9%	North Bay (North)	-23%
Sudbury (North)	-25%	Sudbury (North)	-25%	Simcoe (South)	-9%	Muskoka (Distinct)	-23%
North Bay (North)	-24%	North Bay (North)	-25%	Chatham (South)	-9%	Thunder Bay (North)	-23%
Sault Ste. Marie (North)	-24%	Ottawa (Distinct)	-24%	Niagara Falls (South)	-6%	Barrie (Distinct)	-23%
Muskoka (Distinct)	-24%	Muskoka (Distinct)	-24%	Muskoka (Distinct)	-5%	Sudbury (North)	-23%
Ottawa (Distinct)	-24%	Sault Ste. Marie (North)	-24%	Barrie (Distinct)	-5%	Ottawa (Distinct)	-23%
Barrie (Distinct)	-24%	Barrie (Distinct)	-24%	Kenora (North)	-4%	Sault Ste. Marie (North)	-23%
Niagara Falls (South)	-24%	Niagara Falls (South)	-24%	Peterborough (Distinct)	1%	St. Catharines (South)	-22%
Chatham (South)	-24%	Chatham (South)	-24%	Kapuskasing (North)	2%	Warton (South)	-22%
Windsor (South)	-24%	Windsor (South)	-24%	North Bay (North)	2%	Hamilton (South)	-22%
Hamilton (South)	-24%	St. Catharines (South)	-24%	Sudbury (North)	2%	Trenton (South)	-22%
Simcoe (South)	-23%	Hamilton (South)	-23%	Thunder Bay (North)	2%	Guelph (South)	-22%
London (South)	-23%	Simcoe (South)	-23%	Timmins (North)	2%	Kingston (South)	-22%
Sarnia (South)	-23%	Toronto (South)	-23%	Ottawa (Distinct)	2%	Kitchener-Waterloo (South)	-22%
Cambridge (South)	-23%	London (South)	-23%	Toronto (South)	4%	Mt. Forest (South)	-22%
Guelph (South)	-23%	Sarnia (South)	-23%	Trenton (South)	4%	Toronto (South)	-22%
Peterborough (Distinct)	-23%	Cambridge (South)	-23%	Guelph (South)	4%	Cambridge (South)	-22%
Warton (South)	-23%	Guelph (South)	-23%	Kingston (South)	4%	Peterborough (Distinct)	-22%
Kingston (South)	-23%	Peterborough (Distinct)	-23%	Mt. Forest (South)	4%	Niagara Falls (South)	-22%
Mt. Forest (South)	-22%	Mt. Forest (South)	-23%	Warton (South)	4%	Simcoe (South)	-21%
Kitchener-Waterloo (South)	-22%	Kingston (South)	-22%	Hamilton (South)	4%	Sarnia (South)	-21%
Trenton (South)	-22%	Warton (South)	-22%	Kitchener-Waterloo (South)	4%	London (South)	-21%
Toronto (South)	-22%	Trenton (South)	-22%	Cambridge (South)	4%	Windsor (South)	-21%
St. Catharines (South)	-22%	Kitchener-Waterloo (South)	-22%	St. Catharines (South)	10%	Chatham (South)	-21%

The percentage decrease in electricity for space heating in case of V.GSHP and H.GSHP (if switched from average construction type to improved construction type) ranges from -22% to -25% whereas for traditional HVAC applications the electricity usage ranges from +1% to -17%. The reduction in natural gas usage is a significant decrease in the range of -21% to -23%. This can be examined in Table 5c.

b) Space Cooling Use

V.GSHP		H.GSHP		Traditional (Air Conditioner)	
	Space Cooling (Electricity in KWh)		Space Cooling (Electricity in KWh)		Space Cooling (Electricity in KWh)
Thunder Bay (North)	135	Thunder Bay (North)	139	Thunder Bay (North)	616
Sault Ste. Marie (North)	158	Sault Ste. Marie (North)	162	Timmins (North)	746
Timmins (North)	166	Timmins (North)	172	North Bay (North)	750
North Bay (North)	172	North Bay (North)	179	Sault Ste. Marie (North)	763
Kapuskasing (North)	179	Kapuskasing (North)	184	Kapuskasing (North)	859
Sudbury (North)	186	Sudbury (North)	193	Guelph (South)	871
Kenora (North)	206	Kenora (North)	211	Sudbury (North)	872
Guelph (South)	224	Warton (South)	218	Cambridge (South)	899
Mt. Forest (South)	226	Guelph (South)	230	Kenora (North)	971
Barrie (Distinct)	234	Mt. Forest (South)	232	Barrie (Distinct)	996
Cambridge (South)	235	Cambridge (South)	241	Mt. Forest (South)	1,016
Warton (South)	236	Barrie (Distinct)	241	Warton (South)	1,037
Muskoka (Distinct)	239	Muskoka (Distinct)	246	Muskoka (Distinct)	1,052
Kingston (South)	303	Kingston (South)	288	Ottawa (Distinct)	1,327
Trenton (South)	304	Trenton (South)	311	Kingston (South)	1,413
Ottawa (Distinct)	307	Ottawa (Distinct)	319	Toronto (South)	1,470
Toronto (South)	327	Toronto (South)	335	London (South)	1,474
London (South)	330	London (South)	338	Trenton (South)	1,511
Simcoe (South)	361	Simcoe (South)	370	Peterborough (Distinct)	1,623
Sarnia (South)	400	Sarnia (South)	409	Simcoe (South)	1,677
Niagara Falls (South)	403	Niagara Falls (South)	411	Kitchener-Waterloo (South)	1,834
Peterborough (Distinct)	404	Peterborough (Distinct)	419	Niagara Falls (South)	1,868
Windsor (South)	444	Kitchener-Waterloo (South)	421	Windsor (South)	1,911
Chatham (South)	447	Windsor (South)	455	Chatham (South)	1,919
Kitchener-Waterloo (South)	458	Chatham (South)	458	Sarnia (South)	1,930
Hamilton (South)	475	Hamilton (South)	488	Hamilton (South)	2,073
St. Catharines (South)	485	St. Catharines (South)	497	St. Catharines (South)	2,218

In average construction type, Thunder Bay seemed to be using the least amount of electricity (in KWh) to cool a 2,000 square feet detached house above grade in consideration for the technologies of V.GSHP and H.GSHP whereas St. Catharines comes out to be the heavy use of electricity (in KWh) to provide space cooling for the facility. These results seemed to be consistent for the traditional HVAC application (i.e. the air conditioner). The numbers of electricity usage (in KWh) for the top, bottom, and middle ranked cities can be seen in Table 5d.

Table 5e: Space Cooling Usage - Improved Construction Scenario					
V.GSHP		H.GSHP		Traditional (Air Conditioner)	
	Space Cooling (Electricity in KWh)		Space Cooling (Electricity in KWh)		Space Cooling (Electricity in KWh)
Thunder Bay (North)	108	Thunder Bay (North)	110	Thunder Bay (North)	568
Timmins (North)	132	Timmins (North)	136	Sault Ste. Marie (North)	654
Sault Ste. Marie (North)	134	Sault Ste. Marie (North)	138	North Bay (North)	681
North Bay (North)	136	North Bay (North)	140	Timmins (North)	684
Kapuskasing (North)	142	Kapuskasing (North)	143	Guelph (South)	774
Sudbury (North)	148	Sudbury (North)	153	Cambridge (South)	796
Kenora (North)	163	Kenora (North)	166	Kapuskasing (North)	799
Barrie (Distinct)	181	Barrie (Distinct)	185	Sudbury (North)	804
Warton (South)	184	Warton (South)	187	Barrie (Distinct)	846
Guelph (South)	188	Muskoka (Distinct)	192	Kenora (North)	848
Muskoka (Distinct)	188	Guelph (South)	193	Muskoka (Distinct)	903
Mt. Forest (South)	191	Mt. Forest (South)	201	Mt. Forest (South)	920
Cambridge (South)	197	Cambridge (South)	202	Warton (South)	948
Kingston (South)	238	Kingston (South)	245	Ottawa (Distinct)	1,201
Ottawa (Distinct)	240	Ottawa (Distinct)	247	London (South)	1,258
Trenton (South)	258	Trenton (South)	265	Kingston (South)	1,294
Toronto (South)	279	London (South)	292	Toronto (South)	1,333
London (South)	287	Toronto (South)	293	Trenton (South)	1,383
Simcoe (South)	318	Simcoe (South)	325	Peterborough (Distinct)	1,479
Peterborough (Distinct)	319	Peterborough (Distinct)	327	Simcoe (South)	1,529
Kitchener-Waterloo (South)	358	Kitchener-Waterloo (South)	366	Kitchener-Waterloo (South)	1,681
Sarnia (South)	362	Sarnia (South)	366	Sarnia (South)	1,682
Niagara Falls (South)	366	Niagara Falls (South)	370	Niagara Falls (South)	1,710
Windsor (South)	391	Windsor (South)	400	Windsor (South)	1,725
Chatham (South)	393	Chatham (South)	401	Chatham (South)	1,730
Hamilton (South)	420	Hamilton (South)	430	Hamilton (South)	1,881
St. Catharines (South)	421	St. Catharines (South)	457	St. Catharines (South)	2,039

In improved construction type scenario, the results are consistent for the top and bottom ranked cities for space cooling usage for all the three technologies i.e. V.GSHP, H.GSHP, and traditional HVAC application (i.e. the air conditioner).

The cities in the northern region found out to be the ones needed least amount of electricity (in KWh) to provide space cooling and cities in the southern and distinct regions required the maximum amount of electricity (in KWh) to provide space cooling to satisfy the cooling demand in a 2,000 square feet detached house above grade facility. This can be assessed in Table 5e.

Table 5f: Space Cooling Usage - Difference (% Change)					
V.GSHP		H.GSHP		Traditional (Air Conditioner)	
	% Change		% Change		% Change
Barrie (Distinct)	-23%	Barrie (Distinct)	-23%	Barrie (Distinct)	-15%
Warton (South)	-22%	Ottawa (Distinct)	-23%	London (South)	-15%
Kitchener-Waterloo (South)	-22%	Kapuskasing (North)	-22%	Sault Ste. Marie (North)	-14%
Ottawa (Distinct)	-22%	Peterborough (Distinct)	-22%	Muskoka (Distinct)	-14%
Kingston (South)	-21%	Muskoka (Distinct)	-22%	Sarnia (South)	-13%
Muskoka (Distinct)	-21%	North Bay (North)	-22%	Kenora (North)	-13%
Peterborough (Distinct)	-21%	Kenora (North)	-21%	Cambridge (South)	-11%
North Bay (North)	-21%	Timmins (North)	-21%	Guelph (South)	-11%
Kenora (North)	-21%	Thunder Bay (North)	-21%	Chatham (South)	-10%
Kapuskasing (North)	-21%	Sudbury (North)	-21%	Windsor (South)	-10%
Timmins (North)	-20%	Cambridge (South)	-16%	Ottawa (Distinct)	-9%
Sudbury (North)	-20%	Guelph (South)	-16%	Mt. Forest (South)	-9%
Thunder Bay (North)	-20%	Kingston (South)	-15%	Toronto (South)	-9%
Cambridge (South)	-16%	Sault Ste. Marie (North)	-15%	Hamilton (South)	-9%
Guelph (South)	-16%	Trenton (South)	-15%	North Bay (North)	-9%
Mt. Forest (South)	-15%	Warton (South)	-14%	Peterborough (Distinct)	-9%
Sault Ste. Marie (North)	-15%	London (South)	-14%	Simcoe (South)	-9%
Trenton (South)	-15%	Mt. Forest (South)	-13%	Warton (South)	-9%
Toronto (South)	-15%	Kitchener-Waterloo (South)	-13%	Trenton (South)	-8%
St. Catharines (South)	-13%	Toronto (South)	-13%	Niagara Falls (South)	-8%
London (South)	-13%	Chatham (South)	-12%	Kingston (South)	-8%
Chatham (South)	-12%	Simcoe (South)	-12%	Kitchener-Waterloo (South)	-8%
Windsor (South)	-12%	Windsor (South)	-12%	Timmins (North)	-8%
Simcoe (South)	-12%	Hamilton (South)	-12%	St. Catharines (South)	-8%
Hamilton (South)	-12%	Sarnia (South)	-11%	Sudbury (North)	-8%
Sarnia (South)	-10%	Niagara Falls (South)	-10%	Thunder Bay (North)	-8%
Niagara Falls (South)	-9%	St. Catharines (South)	-8%	Kapuskasing (North)	-7%

The percentage decrease in electricity (in KWh) if switched from average construction type to improved construction type is in the range of -8% to -23% for V.GSHP and H.GSHP. On the other hand, the percentage decrease for traditional HVAC application (i.e. the air conditioner) is between -7% to -15%. This can be seen in Table 5f.

c) Hot Water Use

Table 5g: Hot Water Usage - Average Construction Scenario					
V.GSHP		H.GSHP		Traditional (Natural Gas Water Heater)	
	Hot Water (Electricity in KWh)		Hot Water (Electricity in KWh)		Hot Water (Natural Gas in m ³)
Timmins (North)	3,651	Timmins (North)	3,649	Sarnia (South)	950
Kapuskasing (North)	3,918	Sarnia (South)	3,908	St. Catharines (South)	955
Sarnia (South)	3,928	Kapuskasing (North)	3,916	Chatham (South)	1,003
Sudbury (North)	3,935	Sudbury (North)	3,932	Windsor (South)	1,003
Kitchener-Waterloo (South)	3,982	St. Catharines (South)	3,988	Simcoe (South)	1,007
Mt. Forest (South)	4,010	Mt. Forest (South)	3,992	Mt. Forest (South)	1,015
St. Catharines (South)	4,014	Peterborough (Distinct)	4,070	Niagara Falls (South)	1,015
Warton (South)	4,063	Thunder Bay (North)	4,117	London (South)	1,028
Peterborough (Distinct)	4,084	Muskoka (Distinct)	4,126	Toronto (South)	1,028
Thunder Bay (North)	4,118	Ottawa (Distinct)	4,141	Cambridge (South)	1,029
Muskoka (Distinct)	4,132	Kenora (North)	4,170	Guelph (South)	1,029
Ottawa (Distinct)	4,152	North Bay (North)	4,170	Hamilton (South)	1,030
North Bay (North)	4,172	Kitchener-Waterloo (South)	4,199	Trenton (South)	1,033
Kenora (North)	4,173	Sault Ste. Marie (North)	4,226	Kitchener-Waterloo (South)	1,036
Kingston (South)	4,228	Simcoe (South)	4,260	Ottawa (Distinct)	1,047
Sault Ste. Marie (North)	4,241	Toronto (South)	4,275	Timmins (North)	1,051
Simcoe (South)	4,284	London (South)	4,281	Warton (South)	1,052
Barrie (Distinct)	4,293	Guelph (South)	4,285	Kingston (South)	1,054
Toronto (South)	4,298	Hamilton (South)	4,285	Peterborough (Distinct)	1,055
Guelph (South)	4,300	Barrie (Distinct)	4,288	Barrie (Distinct)	1,058
London (South)	4,302	Warton (South)	4,307	Sault Ste. Marie (North)	1,059
Hamilton (South)	4,314	Windsor (South)	4,317	Sudbury (North)	1,059
Windsor (South)	4,344	Chatham (South)	4,323	North Bay (North)	1,061
Chatham (South)	4,349	Niagara Falls (South)	4,360	Muskoka (Distinct)	1,067
Trenton (South)	4,380	Trenton (South)	4,360	Kapuskasing (North)	1,103
Cambridge (South)	4,382	Cambridge (South)	4,363	Kenora (North)	1,105
Niagara Falls (South)	4,385	Kingston (South)	4,460	Thunder Bay (North)	1,106

In average construction type, Timmins for V.GSHP and H.GSHP and Sarnia for traditional HVAC application (i.e. the natural gas water heater) seems to be consuming least amount of energy (electricity for V.GSHP and H.GSHP and natural gas for natural gas water heater) to provide hot water to a 2,000 square feet detached house above grade facility. On the contrary, Niagara Falls for V.GSHP, Kingston for H.GSHP, and Thunder Bay for traditional HVAC application (i.e. the natural gas water heater) have occupied the top spots for consuming the maximum amount of energy (electricity for V.GSHP and H.GSHP and natural gas for natural gas water heater) for providing hot water usage to meet the required demand. This can be evaluated in Table 5g.

V.GSHP		H.GSHP		Traditional (Natural Gas Water Heater)	
	Hot Water (Electricity in KWh)		Hot Water (Electricity in KWh)		Hot Water (Natural Gas in m ³)
Sarnia (South)	4,118	Sarnia (South)	4,119	Sarnia (South)	950
Timmins (North)	4,319	St. Catharines (South)	4,171	St. Catharines (South)	955
St. Catharines (South)	4,417	Mt. Forest (South)	4,226	Chatham (South)	1,003
Mt. Forest (South)	4,433	Timmins (North)	4,304	Windsor (South)	1,003
Simcoe (South)	4,475	Simcoe (South)	4,475	Simcoe (South)	1,007
Hamilton (South)	4,496	Hamilton (South)	4,492	Mt. Forest (South)	1,015
Guelph (South)	4,508	Toronto (South)	4,510	Niagara Falls (South)	1,015
London (South)	4,513	Guelph (South)	4,511	London (South)	1,028
Windsor (South)	4,523	London (South)	4,515	Toronto (South)	1,028
Chatham (South)	4,529	Windsor (South)	4,521	Cambridge (South)	1,029
Sault Ste. Marie (North)	4,533	Chatham (South)	4,527	Guelph (South)	1,029
Kapuskasing (North)	4,572	Sault Ste. Marie (North)	4,538	Hamilton (South)	1,030
Niagara Falls (South)	4,583	Kapuskasing (North)	4,559	Trenton (South)	1,033
Cambridge (South)	4,588	Niagara Falls (South)	4,586	Kitchener-Waterloo (South)	1,036
Sudbury (North)	4,616	Cambridge (South)	4,591	Ottawa (Distinct)	1,047
Kitchener-Waterloo (South)	4,657	Sudbury (North)	4,599	Timmins (North)	1,051
Toronto (South)	4,737	Kitchener-Waterloo (South)	4,634	Warton (South)	1,052
Peterborough (Distinct)	4,746	Peterborough (Distinct)	4,724	Kingston (South)	1,054
Warton (South)	4,772	Warton (South)	4,758	Peterborough (Distinct)	1,055
Kenora (North)	4,779	Kenora (North)	4,765	Barrie (Distinct)	1,058
Trenton (South)	4,790	Trenton (South)	4,769	Sault Ste. Marie (North)	1,059
Thunder Bay (North)	4,828	Ottawa (Distinct)	4,810	Sudbury (North)	1,059
Ottawa (Distinct)	4,832	Thunder Bay (North)	4,815	North Bay (North)	1,061
North Bay (North)	4,846	North Bay (North)	4,831	Muskoka (Distinct)	1,067
Muskoka (Distinct)	4,875	Muskoka (Distinct)	4,860	Kapuskasing (North)	1,103
Kingston (South)	4,887	Kingston (South)	4,868	Kenora (North)	1,105
Barrie (Distinct)	5,014	Barrie (Distinct)	5,001	Thunder Bay (North)	1,106

In improved construction type, Sarnia for V.GSHP, H.GSHP, and traditional HVAC application (i.e. the natural gas water heater) holds the rank for consuming the least amount of energy (electricity for V.GSHP and H.GSHP and natural gas for natural gas water heater) to meet the hot water demand of a 2,000 square feet detached house above grade. On the other side, Barrie for V.GSHP and H.GSHP and Thunder Bay for traditional HVAC application (i.e. the natural gas water heater) seems to be at the high end of the spectrum consuming the maximum amount of energy (electricity for V.GSHP and H.GSHP and natural gas for natural gas water heater) to provide hot water assistance for a 2,000 square feet detached house above grade. This assessment can be seen in Table 5h.

Table 5i: Hot Water Usage - Difference (% Change)					
V.GSHP		H.GSHP		Traditional (Natural Gas Water Heater)	
	% Change		% Change		% Change
Windsor (South)	4%	St. Catharines (South)	5%	Cambridge (South)	0%
Chatham (South)	4%	Chatham (South)	5%	Chatham (South)	0%
Hamilton (South)	4%	Windsor (South)	5%	Guelph (South)	0%
Simcoe (South)	4%	Hamilton (South)	5%	Hamilton (South)	0%
Niagara Falls (South)	5%	Simcoe (South)	5%	Kingston (South)	0%
Cambridge (South)	5%	Niagara Falls (South)	5%	Kitchener-Waterloo (South)	0%
Sarnia (South)	5%	Cambridge (South)	5%	London (South)	0%
Guelph (South)	5%	Guelph (South)	5%	Mt. Forest (South)	0%
London (South)	5%	Sarnia (South)	5%	Niagara Falls (South)	0%
Sault Ste. Marie (North)	7%	London (South)	5%	Sarnia (South)	0%
Trenton (South)	9%	Toronto (South)	5%	Simcoe (South)	0%
St. Catharines (South)	10%	Mt. Forest (South)	6%	St. Catharines (South)	0%
Toronto (South)	10%	Sault Ste. Marie (North)	7%	Toronto (South)	0%
Mt. Forest (South)	11%	Kingston (South)	9%	Trenton (South)	0%
Kenora (North)	15%	Trenton (South)	9%	Warton (South)	0%
Kingston (South)	16%	Kitchener-Waterloo (South)	10%	Windsor (South)	0%
North Bay (North)	16%	Warton (South)	10%	Barrie (Distinct)	0%
Peterborough (Distinct)	16%	Kenora (North)	14%	Muskoka (Distinct)	0%
Ottawa (Distinct)	16%	North Bay (North)	16%	Ottawa (Distinct)	0%
Kapuskasing (North)	17%	Peterborough (Distinct)	16%	Peterborough (Distinct)	0%
Barrie (Distinct)	17%	Ottawa (Distinct)	16%	Kapuskasing (North)	0%
Kitchener-Waterloo (South)	17%	Kapuskasing (North)	16%	Kenora (North)	0%
Thunder Bay (North)	17%	Barrie (Distinct)	17%	North Bay (North)	0%
Sudbury (North)	17%	Thunder Bay (North)	17%	Sault Ste. Marie (North)	0%
Warton (South)	17%	Sudbury (North)	17%	Sudbury (North)	0%
Muskoka (Distinct)	18%	Muskoka (Distinct)	18%	Timmins (North)	0%
Timmins (North)	18%	Timmins (North)	18%	Thunder Bay (North)	0%

It is interesting to see a jump in energy consumption (% increase) when switched from average construction type to improved construction type for hot water usage with respect to V.GSHP and H.GSHP systems and no increase or decrease for the traditional HVAC application (i.e. the natural gas furnace). This can be seen in Table 5i.

(ii) Average System Efficiency Output

a) Space Heating Use

Table 6a: Average Efficiency Output of Space Heating Units - Average Construction Scenario								
V.GSHP			H.GSHP			Traditional (Natural Gas Furnace)		
	Heating (COP)	Capacity (in Tons)		Heating (COP)	Capacity (in Tons)		Heating (%)	Capacity (in Tons)
Kapuskasing (North)	3.97	5.0	Kapuskasing (North)	3.92	5.0	Barrie (Distinct)	86.77	4.0
Kenora (North)	3.98	5.0	Kenora (North)	3.93	5.0	Peterborough (Distinct)	86.79	4.5
Thunder Bay (North)	4.01	5.0	Thunder Bay (North)	3.94	5.0	Hamilton (South)	86.80	4.0
Timmins (North)	4.16	5.0	Timmins (North)	4.09	5.0	Toronto (South)	86.81	4.0
Sudbury (North)	4.20	5.0	Sudbury (North)	4.11	5.0	Trenton (South)	86.89	4.0
North Bay (North)	4.21	5.0	North Bay (North)	4.12	5.0	Cambridge (South)	86.90	4.0
Sault Ste. Marie (North)	4.23	4.0	Barrie (Distinct)	4.17	5.0	Warton (South)	86.91	4.0
Muskoka (Distinct)	4.24	5.0	Muskoka (Distinct)	4.17	5.0	Kingston (South)	86.98	4.0
Warton (South)	4.25	5.0	Sault Ste. Marie (North)	4.17	4.0	Chatham (South)	86.99	3.5
Barrie (Distinct)	4.25	5.0	Ottawa (Distinct)	4.18	5.0	Kitchener-Waterloo (South)	87.00	4.0
Ottawa (Distinct)	4.28	5.0	Peterborough (Distinct)	4.19	5.0	Windsor (South)	87.00	3.5
Peterborough (Distinct)	4.28	5.0	Warton (South)	4.22	4.0	Guelph (South)	87.01	4.0
Kingston (South)	4.29	5.0	Kingston (South)	4.24	4.0	Muskoka (Distinct)	87.01	4.0
Trenton (South)	4.34	4.0	Mt. Forest (South)	4.29	4.0	Ottawa (Distinct)	87.02	4.0
Mt. Forest (South)	4.35	4.0	Trenton (South)	4.29	4.0	North Bay (North)	87.05	4.0
Cambridge (South)	4.36	4.0	Cambridge (South)	4.30	4.0	Mt. Forest (South)	87.09	4.0
Guelph (South)	4.36	4.0	Guelph (South)	4.30	4.0	St. Catharines (South)	87.14	3.5
Kitchener-Waterloo (South)	4.36	5.0	Kitchener-Waterloo (South)	4.30	4.0	Simcoe (South)	87.16	3.5
London (South)	4.37	4.0	Toronto (South)	4.30	4.0	London (South)	87.24	3.5
Sarnia (South)	4.37	4.0	London (South)	4.31	4.0	Sudbury (North)	87.31	4.0
Toronto (South)	4.37	4.0	Sarnia (South)	4.31	4.0	Sarnia (South)	87.32	3.5
Simcoe (South)	4.39	4.0	Simcoe (South)	4.32	4.0	Thunder Bay (North)	87.34	4.0
Niagara Falls (South)	4.43	4.0	Niagara Falls (South)	4.36	4.0	Niagara Falls (South)	87.40	3.0
Chatham (South)	4.47	4.0	Chatham (South)	4.39	4.0	Sault Ste. Marie (North)	87.43	3.5
Hamilton (South)	4.47	4.0	Hamilton (South)	4.39	4.0	Kenora (North)	87.65	4.0
St. Catharines (South)	4.47	4.0	Windsor (South)	4.39	4.0	Timmins (North)	87.70	4.0
Windsor (South)	4.47	4.0	St. Catharines (South)	4.40	4.0	Kapuskasing (North)	87.77	4.0

In average construction type, Kapuskasing for V.GSHP and H.GSHP ranks at the bottom (lowest efficiency) with a COP of 3.97 and 3.92 respectively on a 5 ton (60,000 btu/hr or 17.58 KW) unit capacity for space heating use. Windsor and St. Catharines are at the top for V.GSHP and H.GSHP with a COP of 4.47 and 4.40 on a 4 ton (48,000 btu/hr or 14.1 KW) unit capacity for space heating. In case of the traditional HVAC application (i.e. the natural gas furnace), Barrie is the lowest with 86.77% efficiency and Kapuskasing is the highest with 87.77% efficiency. This can be determined in Table 6a.

The COP of 1 is equal to 100% efficiency. This clearly shows that V.GSHP and H.GSHP is a clear winner as compared to the traditional HVAC application (i.e. the natural gas furnace) by a huge margin.

Table 6b: Average Efficiency Output of Space Heating Units - Improved Construction Scenario								
V.GSHP			H.GSHP			Traditional (Natural Gas Furnace)		
	Heating (COP)	Capacity (in Tons)		Heating (COP)	Capacity (in Tons)		Heating (%)	Capacity (in Tons)
Kapuskasing (North)	4.08	4.0	Kapuskasing (North)	4.03	4.0	Chatham (South)	86.72	3.0
Kenora (North)	4.08	4.0	Kenora (North)	4.03	4.0	Windsor (South)	86.73	3.0
Thunder Bay (North)	4.10	4.0	Thunder Bay (North)	4.03	4.0	Peterborough (Distinct)	86.81	3.5
Timmins (North)	4.24	4.0	Sudbury (North)	4.18	4.0	Barrie (Distinct)	86.84	3.0
North Bay (North)	4.27	4.0	Timmins (North)	4.18	4.0	Simcoe (South)	86.88	3.0
Sudbury (North)	4.27	4.0	North Bay (North)	4.19	4.0	Hamilton (South)	86.93	3.0
Barrie (Distinct)	4.29	4.0	Barrie (Distinct)	4.22	4.0	Toronto (South)	86.94	3.0
Muskoka (Distinct)	4.29	4.0	Muskoka (Distinct)	4.22	4.0	London (South)	86.96	3.0
Sault Ste. Marie (North)	4.29	3.0	Sault Ste. Marie (North)	4.22	3.0	Trenton (South)	87.02	3.0
Warton (South)	4.30	4.0	Warton (South)	4.23	4.0	Cambridge (South)	87.03	3.0
Kingston (South)	4.33	4.0	Ottawa (Distinct)	4.24	4.0	Sarnia (South)	87.05	3.0
Ottawa (Distinct)	4.33	4.0	Kingston (South)	4.25	4.0	Warton (South)	87.05	3.0
Peterborough (Distinct)	4.33	4.0	Peterborough (Distinct)	4.25	4.0	Sault Ste. Marie (North)	87.06	3.0
Trenton (South)	4.38	4.0	Trenton (South)	4.29	4.0	Muskoka (Distinct)	87.08	3.0
Kitchener-Waterloo (South)	4.39	4.0	Kitchener-Waterloo (South)	4.30	4.0	Ottawa (Distinct)	87.09	3.0
Mt. Forest (South)	4.39	4.0	Mt. Forest (South)	4.35	3.0	Kingston (South)	87.12	3.0
Toronto (South)	4.40	4.0	Guelph (South)	4.36	3.0	North Bay (North)	87.12	3.0
Guelph (South)	4.43	3.0	Cambridge (South)	4.37	3.0	Kitchener-Waterloo (South)	87.13	3.0
Cambridge (South)	4.44	3.0	Toronto (South)	4.38	3.0	Guelph (South)	87.14	3.0
London (South)	4.45	3.0	London (South)	4.39	3.0	Niagara Falls (South)	87.20	2.5
Sarnia (South)	4.45	3.0	Sarnia (South)	4.39	3.0	Mt. Forest (South)	87.22	3.0
Simcoe (South)	4.48	3.0	Simcoe (South)	4.41	3.0	Sudbury (North)	87.38	3.0
St. Catharines (South)	4.49	4.0	Niagara Falls (South)	4.47	3.0	St. Catharines (South)	87.42	2.5
Niagara Falls (South)	4.56	3.0	Hamilton (South)	4.50	3.0	Thunder Bay (North)	87.42	3.0
Hamilton (South)	4.57	3.0	Windsor (South)	4.50	3.0	Kenora (North)	87.75	3.0
Chatham (South)	4.59	3.0	Chatham (South)	4.51	3.0	Timmins (North)	87.80	3.0
Windsor (South)	4.59	3.0	St. Catharines (South)	4.51	3.0	Kapuskasing (North)	87.89	3.0

In improved construction type, the bottom ranked and the top ranked cities in terms of COP are the same as compared to the average construction type. Kapuskasing is at the bottom with an average efficiency of COP of 4.08 and 4.03 for V.GSHP and H.GSHP respectively. Windsor and St. Catharines tops the ranks with a COP of 4.59 and 4.51 for V.GSHP and H.GSHP respectively. In contrast, Chatham is at the bottom with 86.72% efficiency and Kapuskasing is at the top with 87.89% efficiency. This can be analyzed in Table 6b.

Table 6c: Average Efficiency Output of Space Heating Units - Difference (% Change)					
V.GSHP		H.GSHP		Traditional (Natural Gas Furnace)	
	% Change		% Change		% Change
St. Catharines (South)	0.45%	Kitchener-Waterloo (South)	0.00%	Sault Ste. Marie (North)	-0.42%
Toronto (South)	0.69%	Trenton (South)	0.00%	Simcoe (South)	-0.32%
Kitchener-Waterloo (South)	0.69%	Kingston (South)	0.24%	London (South)	-0.32%
Mt. Forest (South)	0.92%	Warton (South)	0.24%	Chatham (South)	-0.31%
Trenton (South)	0.92%	Barrie (Distinct)	1.20%	Windsor (South)	-0.31%
Kingston (South)	0.93%	Muskoka (Distinct)	1.20%	Sarnia (South)	-0.31%
Barrie (Distinct)	0.94%	Sault Ste. Marie (North)	1.20%	Niagara Falls (South)	-0.23%
Ottawa (Distinct)	1.17%	Guelph (South)	1.40%	Peterborough (Distinct)	0.02%
Peterborough (Distinct)	1.17%	Mt. Forest (South)	1.40%	Sudbury (North)	0.08%
Warton (South)	1.18%	Peterborough (Distinct)	1.43%	North Bay (North)	0.08%
Muskoka (Distinct)	1.18%	Ottawa (Distinct)	1.44%	Ottawa (Distinct)	0.08%
Sault Ste. Marie (North)	1.42%	Cambridge (South)	1.63%	Muskoka (Distinct)	0.08%
North Bay (North)	1.43%	North Bay (North)	1.70%	Barrie (Distinct)	0.08%
Guelph (South)	1.61%	Sudbury (North)	1.70%	Thunder Bay (North)	0.09%
Sudbury (North)	1.67%	London (South)	1.86%	Timmins (North)	0.11%
London (South)	1.83%	Sarnia (South)	1.86%	Kenora (North)	0.11%
Sarnia (South)	1.83%	Toronto (South)	1.86%	Kapuskasing (North)	0.14%
Cambridge (South)	1.83%	Simcoe (South)	2.08%	Mt. Forest (South)	0.15%
Timmins (North)	1.92%	Timmins (North)	2.20%	Guelph (South)	0.15%
Simcoe (South)	2.05%	Thunder Bay (North)	2.28%	Kitchener-Waterloo (South)	0.15%
Hamilton (South)	2.24%	St. Catharines (South)	2.50%	Cambridge (South)	0.15%
Thunder Bay (North)	2.24%	Hamilton (South)	2.51%	Trenton (South)	0.15%
Kenora (North)	2.51%	Windsor (South)	2.51%	Toronto (South)	0.15%
Chatham (South)	2.68%	Niagara Falls (South)	2.52%	Hamilton (South)	0.15%
Windsor (South)	2.68%	Kenora (North)	2.54%	Kingston (South)	0.16%
Kapuskasing (North)	2.77%	Chatham (South)	2.73%	Warton (South)	0.16%
Niagara Falls (South)	2.93%	Kapuskasing (North)	2.81%	St. Catharines (South)	0.32%

The percentage difference (if switched from average to improved construction type) is a jump in COP for both V.GSHP and H.GSHP in the range of 0% to 2.93%. However, in case of traditional HVAC application (i.e. the natural gas furnace) the range is from -0.42% to 0.32%. This can be appraised in Table 6c.

b) Space Cooling Use

Table 6d: Average Efficiency Output of Space Cooling Units - Average Construction Scenario								
V.GSHP			H.GSHP			Traditional (Air Conditioner)		
	Cooling (EER in %)	Capacity (in Tons)		Cooling (EER in %)	Capacity (in Tons)		Cooling (EER in %)	Capacity (in Tons)
Kitchener-Waterloo (South)	33.05	5.0	Peterborough (Distinct)	33.02	5.0	Kingston (South)	7.3	4.5
Peterborough (Distinct)	34.20	5.0	Ottawa (Distinct)	33.27	5.0	Trenton (South)	7.4	4.5
Kingston (South)	34.21	5.0	Sudbury (North)	33.89	5.0	Sudbury (North)	7.5	4.0
Warton (South)	34.45	5.0	Timmins (North)	33.92	5.0	Sarnia (South)	7.6	4.0
Ottawa (Distinct)	34.57	5.0	North Bay (North)	33.96	5.0	Kapuskasing (North)	7.6	4.5
Muskoka (Distinct)	35.00	5.0	Muskoka (Distinct)	33.99	5.0	Niagara Falls (South)	7.8	4.0
Barrie (Distinct)	35.02	5.0	Barrie (Distinct)	34.00	5.0	Simcoe (South)	7.8	4.0
Sudbury (North)	35.24	5.0	Hamilton (South)	34.61	4.0	St. Catharines (South)	7.8	4.0
Timmins (North)	35.27	5.0	Windsor (South)	34.67	4.0	Warton (South)	7.8	4.0
North Bay (North)	35.34	5.0	Chatham (South)	34.71	4.0	Kenora (North)	7.8	4.0
Hamilton (South)	35.56	4.0	St. Catharines (South)	34.79	4.0	Timmins (North)	7.8	3.5
Chatham (South)	35.58	4.0	Cambridge (South)	35.31	4.0	Sault Ste. Marie (North)	7.9	3.5
Windsor (South)	35.59	4.0	Guelph (South)	35.41	4.0	Muskoka (Distinct)	8.0	3.5
St. Catharines (South)	35.60	4.0	Niagara Falls (South)	35.45	4.0	Ottawa (Distinct)	8.0	3.5
Niagara Falls (South)	36.19	4.0	Kapuskasing (North)	35.46	5.0	Hamilton (South)	8.1	3.5
Cambridge (South)	36.21	4.0	Simcoe (South)	35.51	4.0	Mt. Forest (South)	8.1	3.5
Kapuskasing (North)	36.30	5.0	Mt. Forest (South)	35.74	4.0	North Bay (North)	8.1	3.5
Guelph (South)	36.34	4.0	Toronto (South)	35.77	4.0	Thunder Bay (North)	8.1	3.5
Simcoe (South)	36.42	4.0	Kenora (North)	35.82	5.0	London (South)	8.2	3.5
London (South)	36.65	4.0	London (South)	35.85	4.0	Toronto (South)	8.2	3.5
Mt. Forest (South)	36.65	4.0	Trenton (South)	35.87	4.0	Barrie (Distinct)	8.2	3.5
Toronto (South)	36.69	4.0	Thunder Bay (North)	35.91	5.0	Chatham (South)	8.3	3.5
Trenton (South)	36.71	4.0	Kitchener-Waterloo (South)	36.00	4.0	Kitchener-Waterloo (South)	8.3	3.5
Sarnia (South)	36.84	4.0	Kingston (South)	36.07	4.0	Windsor (South)	8.3	3.5
Kenora (North)	36.84	5.0	Sarnia (South)	36.09	4.0	Peterborough (Distinct)	8.5	3.0
Thunder Bay (North)	36.97	5.0	Sault Ste. Marie (North)	37.24	4.0	Guelph (South)	9.3	2.5
Sault Ste. Marie (North)	38.30	4.0	Warton (South)	37.31	4.0	Cambridge (South)	9.5	2.5

In average construction type, Kitchener-Waterloo and Peterborough ranks at the bottom for V.GSHP and H.GSHP with an EER of 33.05% and 33.02% respectively for space cooling use. Sault Ste. Marie with an EER of 38.30% and 37.31% for V.GSHP and H.GSHP ranks at the top on the efficiency scale. In case of traditional HVAC application (i.e. the air conditioner), Kingston with an EER of 7.4% is at the bottom and Cambridge with an EER of 9.5% is at the top. Clearly, V.GSHP and H.GSHP are the winners in this case. This can be seen in Table 6d.

V.GSHP			H.GSHP			Traditional (Air Conditioner)		
	Cooling (EER in %)	Capacity (in Tons)		Cooling (EER in %)	Capacity (in Tons)		Cooling (EER in %)	Capacity (in Tons)
Chatham (South)	34.40	3.0	St. Catharines (South)	32.94	3.0	Kingston (South)	6.9	4.5
Windsor (South)	34.43	3.0	Hamilton (South)	33.66	3.0	Trenton (South)	6.9	4.5
Niagara Falls (South)	34.44	3.0	Windsor (South)	33.66	3.0	Sudbury (North)	7.1	4.0
Hamilton (South)	34.48	3.0	Chatham (South)	33.70	3.0	Kapuskasing (North)	7.2	4.5
Sarnia (South)	35.40	3.0	Niagara Falls (South)	34.04	3.0	Niagara Falls (South)	7.4	4.0
Simcoe (South)	35.48	3.0	Simcoe (South)	34.78	3.0	Simcoe (South)	7.4	4.0
St. Catharines (South)	35.75	4.0	Sarnia (South)	34.96	3.0	St. Catharines (South)	7.4	4.0
London (South)	35.92	3.0	Toronto (South)	35.04	3.0	Warton (South)	7.4	4.0
Cambridge (South)	36.38	3.0	Mt. Forest (South)	35.24	3.0	Timmins (North)	7.4	3.5
Guelph (South)	36.48	3.0	London (South)	35.30	3.0	Ottawa (Distinct)	7.5	3.5
Toronto (South)	36.82	4.0	Cambridge (South)	35.49	3.0	Sarnia (South)	7.6	3.5
Mt. Forest (South)	36.95	4.0	Guelph (South)	35.56	3.0	North Bay (North)	7.6	3.5
Kitchener-Waterloo (South)	36.98	4.0	Trenton (South)	36.06	4.0	Hamilton (South)	7.7	3.5
Trenton (South)	37.02	4.0	Kitchener-Waterloo (South)	36.12	4.0	Mt. Forest (South)	7.7	3.5
Kingston (South)	37.29	4.0	Kingston (South)	36.35	4.0	Toronto (South)	7.7	3.5
Peterborough (Distinct)	37.67	4.0	Ottawa (Distinct)	36.60	4.0	Thunder Bay (North)	7.7	3.5
Ottawa (Distinct)	37.69	4.0	Peterborough (Distinct)	36.69	4.0	Chatham (South)	7.8	3.5
Warton (South)	38.15	4.0	North Bay (North)	37.22	4.0	Windsor (South)	7.8	3.5
Barrie (Distinct)	38.18	4.0	Timmins (North)	37.27	4.0	Kenora (North)	7.8	3.5
Muskoka (Distinct)	38.32	4.0	Barrie (Distinct)	37.35	4.0	Kitchener-Waterloo (South)	7.9	3.5
North Bay (North)	38.34	4.0	Sudbury (North)	37.40	4.0	Sault Ste. Marie (North)	7.9	3.0
Timmins (North)	38.36	4.0	Muskoka (Distinct)	37.54	4.0	Muskoka (Distinct)	8.0	3.0
Sudbury (North)	38.47	4.0	Sault Ste. Marie (North)	37.54	3.0	Peterborough (Distinct)	8.1	3.0
Sault Ste. Marie (North)	38.49	3.0	Warton (South)	37.55	4.0	London (South)	8.2	3.0
Kapuskasing (North)	40.65	4.0	Kenora (North)	39.94	4.0	Barrie (Distinct)	8.2	3.0
Kenora (North)	40.65	4.0	Thunder Bay (North)	40.00	4.0	Guelph (South)	8.9	2.5
Thunder Bay (North)	40.75	4.0	Kapuskasing (North)	40.18	4.0	Cambridge (South)	9.0	2.5

In improved construction type, Chatham and St. Catharines are at the bottom for V.GSHP and H.GSHP with an EER of 34.40% and 32.94% respectively. Thunder Bay and Kapuskasing are the highest end of the average efficiency spectrum for V.GSHP and H.GSHP with an EER of 40.75% and 40.18% respectively. Kingston comes out at the bottom with an EER of 6.9% and Cambridge at the top with an EER of 9.0% average efficiency for the traditional HVAC application (i.e. the air conditioner). This can be analyzed in Table 6e.

Table 6f: Average Efficiency Output of Space Cooling Units - Difference (% Change)					
V.GSHP		H.GSHP		Traditional (Air Conditioner)	
	% Change		% Change		% Change
Niagara Falls (South)	-4.84%	St. Catharines (South)	-5.32%	Trenton (South)	-6.76%
Sarnia (South)	-3.91%	Niagara Falls (South)	-3.98%	Ottawa (Distinct)	-6.25%
Chatham (South)	-3.32%	Sarnia (South)	-3.13%	North Bay (North)	-6.17%
Windsor (South)	-3.26%	Windsor (South)	-2.91%	Toronto (South)	-6.10%
Hamilton (South)	-3.04%	Chatham (South)	-2.91%	Chatham (South)	-6.02%
Simcoe (South)	-2.58%	Hamilton (South)	-2.74%	Windsor (South)	-6.02%
London (South)	-1.99%	Simcoe (South)	-2.06%	Kingston (South)	-5.48%
Toronto (South)	0.35%	Toronto (South)	-2.04%	Sudbury (North)	-5.33%
Guelph (South)	0.39%	London (South)	-1.53%	Cambridge (South)	-5.26%
St. Catharines (South)	0.42%	Mt. Forest (South)	-1.40%	Kapuskasing (North)	-5.26%
Cambridge (South)	0.47%	Kitchener-Waterloo (South)	0.33%	Niagara Falls (South)	-5.13%
Sault Ste. Marie (North)	0.50%	Guelph (South)	0.42%	Simcoe (South)	-5.13%
Mt. Forest (South)	0.82%	Cambridge (South)	0.51%	St. Catharines (South)	-5.13%
Trenton (South)	0.84%	Trenton (South)	0.53%	Warton (South)	-5.13%
North Bay (North)	8.49%	Warton (South)	0.64%	Timmins (North)	-5.13%
Timmins (North)	8.76%	Kingston (South)	0.78%	Hamilton (South)	-4.94%
Kingston (South)	9.00%	Sault Ste. Marie (North)	0.81%	Mt. Forest (South)	-4.94%
Barrie (Distinct)	9.02%	North Bay (North)	9.60%	Thunder Bay (North)	-4.94%
Ottawa (Distinct)	9.03%	Barrie (Distinct)	9.85%	Kitchener-Waterloo (South)	-4.82%
Sudbury (North)	9.17%	Timmins (North)	9.88%	Peterborough (Distinct)	-4.71%
Muskoka (Distinct)	9.49%	Ottawa (Distinct)	10.01%	Guelph (South)	-4.30%
Peterborough (Distinct)	10.15%	Sudbury (North)	10.36%	London (South)	0.00%
Thunder Bay (North)	10.22%	Muskoka (Distinct)	10.44%	Sarnia (South)	0.00%
Kenora (North)	10.34%	Peterborough (Distinct)	11.11%	Barrie (Distinct)	0.00%
Warton (South)	10.74%	Thunder Bay (North)	11.39%	Muskoka (Distinct)	0.00%
Kitchener-Waterloo (South)	11.89%	Kenora (North)	11.50%	Kenora (North)	0.00%
Kapuskasing (North)	11.98%	Kapuskasing (North)	13.31%	Sault Ste. Marie (North)	0.00%

The percentage difference (if switched from average to improved construction type) is a mixed bag in COP for both V.GSHP and H.GSHP in the range of -5.32% to 13.31%. However, in case of traditional HVAC application (i.e. the air conditioner) the range is from -6.76% to 0%. This can be evaluated in Table 6f.

c) Hot Water Use

Table 6g: Average Efficiency Output of Hot Water Units - Average Construction Scenario								
V.GSHP			H.GSHP			Traditional (Natural Gas Water Heater)		
	Hot Water (COP)	Capacity (in Tons)		Hot Water (COP)	Capacity (in Tons)		Hot Water (%)	Capacity (in Tons)
Kapuskasing (North)	4.09	5.0	Kapuskasing (North)	4.02	5.0	Hamilton (South)	56.77	3.0
Thunder Bay (North)	4.10	5.0	Thunder Bay (North)	4.02	5.0	Peterborough (Distinct)	57.99	3.0
Kenora (North)	4.11	5.0	Kenora (North)	4.04	5.0	Kingston (South)	58.05	3.0
Timmins (North)	4.28	5.0	Timmins (North)	4.20	5.0	Muskoka (Distinct)	58.10	3.0
Sudbury (North)	4.32	5.0	Sudbury (North)	4.23	5.0	Kitchener-Waterloo (South)	58.12	3.0
North Bay (North)	4.33	5.0	North Bay (North)	4.24	5.0	Chatham (South)	58.41	3.0
Sault Ste. Marie (North)	4.34	4.0	Sault Ste. Marie (North)	4.28	4.0	Windsor (South)	58.41	3.0
Muskoka (Distinct)	4.40	5.0	Muskoka (Distinct)	4.33	5.0	Niagara Falls (South)	58.46	3.0
Warton (South)	4.41	5.0	Barrie (Distinct)	4.34	5.0	Toronto (South)	58.49	3.0
Barrie (Distinct)	4.41	5.0	Warton (South)	4.38	4.0	London (South)	58.50	3.0
Ottawa (Distinct)	4.49	5.0	Ottawa (Distinct)	4.41	5.0	Trenton (South)	58.50	3.0
Kingston (South)	4.51	5.0	Kingston (South)	4.47	4.0	Cambridge (South)	58.52	3.0
Mt. Forest (South)	4.53	4.0	Mt. Forest (South)	4.47	4.0	Guelph (South)	58.52	3.0
Guelph (South)	4.54	4.0	Peterborough (Distinct)	4.48	5.0	Ottawa (Distinct)	58.55	3.0
Cambridge (South)	4.56	4.0	Guelph (South)	4.49	4.0	Barrie (Distinct)	58.60	3.0
Peterborough (Distinct)	4.56	5.0	Cambridge (South)	4.51	4.0	North Bay (North)	58.64	3.0
Trenton (South)	4.60	4.0	Trenton (South)	4.55	4.0	Sault Ste. Marie (North)	58.76	3.0
Toronto (South)	4.65	4.0	Toronto (South)	4.59	4.0	Sudbury (North)	58.77	3.0
London (South)	4.66	4.0	London (South)	4.61	4.0	Thunder Bay (North)	58.77	3.0
Kitchener-Waterloo (South)	4.69	5.0	Kitchener-Waterloo (South)	4.66	4.0	Kenora (North)	58.85	3.0
Simcoe (South)	4.72	4.0	Simcoe (South)	4.67	4.0	Warton (South)	58.91	3.0
Sarnia (South)	4.75	4.0	Sarnia (South)	4.71	4.0	Kapuskasing (North)	58.92	3.0
Niagara Falls (South)	4.83	4.0	Niagara Falls (South)	4.77	4.0	Timmins (North)	59.20	3.0
Hamilton (South)	4.93	4.0	Hamilton (South)	4.88	4.0	Mt. Forest (South)	59.29	3.0
Chatham (South)	4.94	4.0	Windsor (South)	4.88	4.0	Simcoe (South)	59.38	3.0
Windsor (South)	4.94	4.0	Chatham (South)	4.89	4.0	St. Catharines (South)	61.19	3.0
St. Catharines (South)	5.01	4.0	St. Catharines (South)	4.95	4.0	Sarnia (South)	63.27	3.0

In average construction type, Kapuskasing with a COP OF 4.09 for V.GSHP and a COP of 4.02 for H.GSHP is at the bottom of average efficiency for hot water use. St. Catharines with a COP of 5.01 for V.GSHP and a COP of 4.95 for H.GSHP came out to be at the top of average efficiency spectrum. In case of traditional HVAC application (i.e. the natural gas water heater), Hamilton with an efficiency of 56.77% is at the bottom and Sarnia with an efficiency of 63.27% is at the top. Table 6g clearly shows that V.GSHP and H.GSHP are the clear winners in this case.

Table 6h: Average Efficiency Output of Hot Water Units - Improved Construction Scenario								
V.GSHP			H.GSHP			Traditional (Natural Gas Water Heater)		
	Hot Water (COP)	Capacity (in Tons)		Hot Water (COP)	Capacity (in Tons)		Hot Water (%)	Capacity (in Tons)
Kapuskasing (North)	4.16	4.0	Thunder Bay (North)	4.10	4.0	Hamilton (South)	56.77	3.0
Thunder Bay (North)	4.16	4.0	Kapuskasing (North)	4.11	4.0	Peterborough (Distinct)	57.99	3.0
Kenora (North)	4.18	4.0	Kenora (North)	4.13	4.0	Kingston (South)	58.05	3.0
Timmins (North)	4.34	4.0	Timmins (North)	4.27	4.0	Muskoka (Distinct)	58.10	3.0
Sudbury (North)	4.37	4.0	North Bay (North)	4.30	4.0	Kitchener-Waterloo (South)	58.12	3.0
North Bay (North)	4.38	4.0	Sudbury (North)	4.30	4.0	Chatham (South)	58.41	3.0
Sault Ste. Marie (North)	4.42	3.0	Sault Ste. Marie (North)	4.35	3.0	Windsor (South)	58.41	3.0
Muskoka (Distinct)	4.44	4.0	Muskoka (Distinct)	4.38	4.0	Niagara Falls (South)	58.46	3.0
Warton (South)	4.45	4.0	Warton (South)	4.39	4.0	Toronto (South)	58.49	3.0
Barrie (Distinct)	4.45	4.0	Barrie (Distinct)	4.39	4.0	London (South)	58.50	3.0
Ottawa (Distinct)	4.53	4.0	Ottawa (Distinct)	4.46	4.0	Trenton (South)	58.50	3.0
Kingston (South)	4.55	4.0	Kingston (South)	4.48	4.0	Cambridge (South)	58.52	3.0
Mt. Forest (South)	4.56	4.0	Peterborough (Distinct)	4.54	4.0	Guelph (South)	58.52	3.0
Peterborough (Distinct)	4.61	4.0	Mt. Forest (South)	4.55	3.0	Ottawa (Distinct)	58.55	3.0
Trenton (South)	4.62	4.0	Trenton (South)	4.56	4.0	Barrie (Distinct)	58.60	3.0
Guelph (South)	4.64	3.0	Guelph (South)	4.58	3.0	North Bay (North)	58.64	3.0
Cambridge (South)	4.67	3.0	Cambridge (South)	4.60	3.0	Sault Ste. Marie (North)	58.76	3.0
Toronto (South)	4.68	4.0	Kitchener-Waterloo (South)	4.68	4.0	Sudbury (North)	58.77	3.0
Kitchener-Waterloo (South)	4.75	4.0	Toronto (South)	4.71	3.0	Thunder Bay (North)	58.77	3.0
London (South)	4.78	3.0	London (South)	4.72	3.0	Kenora (North)	58.85	3.0
Simcoe (South)	4.87	3.0	Simcoe (South)	4.80	3.0	Warton (South)	58.91	3.0
Sarnia (South)	4.90	3.0	Sarnia (South)	4.84	3.0	Kapuskasing (North)	58.92	3.0
Niagara Falls (South)	5.03	3.0	Niagara Falls (South)	4.95	3.0	Timmins (North)	59.20	3.0
St. Catharines (South)	5.04	4.0	Hamilton (South)	5.03	3.0	Mt. Forest (South)	59.29	3.0
Hamilton (South)	5.10	3.0	Windsor (South)	5.05	3.0	Simcoe (South)	59.38	3.0
Windsor (South)	5.12	3.0	Chatham (South)	5.06	3.0	St. Catharines (South)	61.19	3.0
Chatham (South)	5.13	3.0	St. Catharines (South)	5.14	3.0	Sarnia (South)	63.27	3.0

In improved construction type, Kapuskasing with a COP of 4.16 and Thunder Bay with a COP of 4.10 are at the bottom for V.GSHP and H.GSHP respectively whereas Chatham and St. Catharines with a COP of 5.13 AND 5.14 for V.GSHP and H.GSHP respectively ranked the highest on the average efficiency scale. In case of traditional HVAC applications (i.e. the natural gas water heater), Hamilton is at the bottom with 56.77% and Sarnia at the top with 63.27% average efficiencies for hot water use. This can be confirmed from Table 6h.

Table 6i: Average Efficiency Output of Hot Water Units - Difference (% Change)					
V.GSHP		H.GSHP		Traditional (Natural Gas Water Heater)	
	% Change		% Change		% Change
Trenton (South)	0.43%	Trenton (South)	0.22%	Cambridge (South)	0.00%
St. Catharines (South)	0.60%	Kingston (South)	0.22%	Chatham (South)	0.00%
Toronto (South)	0.65%	Warton (South)	0.23%	Guelph (South)	0.00%
Mt. Forest (South)	0.66%	Kitchener-Waterloo (South)	0.43%	Hamilton (South)	0.00%
Kingston (South)	0.89%	Ottawa (Distinct)	1.13%	Kingston (South)	0.00%
Ottawa (Distinct)	0.89%	Barrie (Distinct)	1.15%	Kitchener-Waterloo (South)	0.00%
Warton (South)	0.91%	Muskoka (Distinct)	1.15%	London (South)	0.00%
Barrie (Distinct)	0.91%	Peterborough (Distinct)	1.34%	Mt. Forest (South)	0.00%
Muskoka (Distinct)	0.91%	North Bay (North)	1.42%	Niagara Falls (South)	0.00%
Peterborough (Distinct)	1.10%	Sault Ste. Marie (North)	1.64%	Sarnia (South)	0.00%
North Bay (North)	1.15%	Sudbury (North)	1.65%	Simcoe (South)	0.00%
Sudbury (North)	1.16%	Timmins (North)	1.67%	St. Catharines (South)	0.00%
Kitchener-Waterloo (South)	1.28%	Mt. Forest (South)	1.79%	Toronto (South)	0.00%
Timmins (North)	1.40%	Thunder Bay (North)	1.99%	Trenton (South)	0.00%
Thunder Bay (North)	1.46%	Cambridge (South)	2.00%	Warton (South)	0.00%
Kenora (North)	1.70%	Guelph (South)	2.00%	Windsor (South)	0.00%
Kapuskasing (North)	1.71%	Kenora (North)	2.23%	Barrie (Distinct)	0.00%
Sault Ste. Marie (North)	1.84%	Kapuskasing (North)	2.24%	Muskoka (Distinct)	0.00%
Guelph (South)	2.20%	London (South)	2.39%	Ottawa (Distinct)	0.00%
Cambridge (South)	2.41%	Toronto (South)	2.61%	Peterborough (Distinct)	0.00%
London (South)	2.58%	Sarnia (South)	2.76%	Kapuskasing (North)	0.00%
Sarnia (South)	3.16%	Simcoe (South)	2.78%	Kenora (North)	0.00%
Simcoe (South)	3.18%	Hamilton (South)	3.07%	North Bay (North)	0.00%
Hamilton (South)	3.45%	Chatham (South)	3.48%	Sault Ste. Marie (North)	0.00%
Windsor (South)	3.64%	Windsor (South)	3.48%	Sudbury (North)	0.00%
Chatham (South)	3.85%	Niagara Falls (South)	3.77%	Timmins (North)	0.00%
Niagara Falls (South)	4.14%	St. Catharines (South)	3.84%	Thunder Bay (North)	0.00%

The percentage difference (if switched from average to improved construction type) is an increase in COP for both V.GSHP and H.GSHP in the range of 0.22% to 4.14%. However, in case of traditional HVAC application (i.e. the natural gas water heater) there is no change at all. This can be verified from Table 6i.

(iii) Operating Costs

Table 7a shows the rankings of the cities based on the operating costs on an annual basis. The operating costs consist of space heating, space cooling, and hot water use in a 2,000 square feet detached house above grade. In average construction type, St. Catharines is the cheapest for V.GSHP and H.GSHP with a dollar value of \$1,352 and \$1,362 respectively. Cambridge with an operating cost of \$1,595 proved to be the least expensive for the traditional HVAC applications (i.e. natural gas furnace, air conditioner and natural gas water heater). In the case of improved construction type, Sarnia with an operating cost of \$1,239 and St. Catharines with an operating cost of \$1,220 proved to be the least expensive for V.GSHP and H.GSHP respectively. Cambridge with \$1,392 is at the lowest end of the scale for traditional HVAC application.

Kapuskasing is the most expensive city for both average construction type and improved construction type for all the three technologies (i.e. V.GSHP, H.GSHP, and Traditional HVAC applications). This can be evaluated in Table 7a.

Table 7b shows the different in % change in operating costs when switched from average construction type to improved construction type. The V.GSHP and H.GSHP resulted in a decrease of range between -7% to -13%. In case of traditional HVAC applications, a decrease in operating costs in the range of -10% to -17% was seen for various cities.

Table 7a: Total Operating Costs on Annual Basis (Space Heating + Space Cooling + Hot Water)											
Average Construction Scenario					Improved Construction Scenario						
	V.GSHP		H.GSHP	Traditional		V.GSHP		H.GSHP		Traditional	
St. Catharines (South)	\$1,352	St. Catharines (South)	\$1,362	Cambridge (South)	\$1,595	Sarnia (South)	\$1,239	St. Catharines (South)	\$1,220	Cambridge (South)	\$1,392
Sarnia (South)	\$1,387	Sarnia (South)	\$1,395	Chatham (South)	\$1,636	Chatham (South)	\$1,253	Sarnia (South)	\$1,248	Chatham (South)	\$1,423
Chatham (South)	\$1,396	Chatham (South)	\$1,405	Windsor (South)	\$1,639	St. Catharines (South)	\$1,254	Chatham (South)	\$1,264	Windsor (South)	\$1,425
Windsor (South)	\$1,397	Windsor (South)	\$1,407	Guelph (South)	\$1,641	Windsor (South)	\$1,255	Windsor (South)	\$1,266	Guelph (South)	\$1,430
Niagara Falls (South)	\$1,412	Niagara Falls (South)	\$1,421	Barrie (Distinct)	\$1,681	Niagara Falls (South)	\$1,270	Niagara Falls (South)	\$1,281	Barrie (Distinct)	\$1,430
Simcoe (South)	\$1,450	Simcoe (South)	\$1,460	St. Catharines (South)	\$1,681	Simcoe (South)	\$1,297	Simcoe (South)	\$1,308	Sarnia (South)	\$1,450
Hamilton (South)	\$1,476	Hamilton (South)	\$1,486	Sarnia (South)	\$1,701	Hamilton (South)	\$1,317	Hamilton (South)	\$1,328	London (South)	\$1,478
Cambridge (South)	\$1,500	London (South)	\$1,510	Niagara Falls (South)	\$1,704	Cambridge (South)	\$1,339	London (South)	\$1,349	Simcoe (South)	\$1,485
London (South)	\$1,501	Cambridge (South)	\$1,510	Simcoe (South)	\$1,711	London (South)	\$1,339	Cambridge (South)	\$1,350	Niagara Falls (South)	\$1,494
Toronto (South)	\$1,502	Toronto (South)	\$1,513	Toronto (South)	\$1,715	Guelph (South)	\$1,356	Toronto (South)	\$1,351	Toronto (South)	\$1,508
Kitchener-Waterloo (South)	\$1,512	Trenton (South)	\$1,531	London (South)	\$1,742	Toronto (South)	\$1,381	Guelph (South)	\$1,367	St. Catharines (South)	\$1,508
Trenton (South)	\$1,523	Guelph (South)	\$1,535	Hamilton (South)	\$1,759	Trenton (South)	\$1,394	Mt. Forest (South)	\$1,396	North Bay (North)	\$1,533
Guelph (South)	\$1,524	Barrie (Distinct)	\$1,545	Trenton (South)	\$1,763	Kitchener-Waterloo (South)	\$1,409	Trenton (South)	\$1,404	Ottawa (Distinct)	\$1,535
Barrie (Distinct)	\$1,530	Kitchener-Waterloo (South)	\$1,551	Ottawa (Distinct)	\$1,774	Mt. Forest (South)	\$1,419	Kitchener-Waterloo (South)	\$1,420	Muskoka (Distinct)	\$1,538
Kingston (South)	\$1,538	Ottawa (Distinct)	\$1,570	Warton (South)	\$1,779	Barrie (Distinct)	\$1,424	Barrie (Distinct)	\$1,433	Sault Ste. Marie (North)	\$1,545
Ottawa (Distinct)	\$1,550	Mt. Forest (South)	\$1,581	North Bay (North)	\$1,780	Ottawa (Distinct)	\$1,428	Ottawa (Distinct)	\$1,439	Hamilton (South)	\$1,551
Warton (South)	\$1,552	Kingston (South)	\$1,582	Kingston (South)	\$1,795	Kingston (South)	\$1,434	Kingston (South)	\$1,446	Trenton (South)	\$1,557
Mt. Forest (South)	\$1,571	Warton (South)	\$1,593	Muskoka (Distinct)	\$1,812	Sault Ste. Marie (North)	\$1,445	Warton (South)	\$1,456	Warton (South)	\$1,562
Peterborough (Distinct)	\$1,583	Peterborough (Distinct)	\$1,602	Mt. Forest (South)	\$1,812	Warton (South)	\$1,446	Sault Ste. Marie (North)	\$1,458	Mt. Forest (South)	\$1,583
Muskoka (Distinct)	\$1,597	Muskoka (Distinct)	\$1,613	Kitchener-Waterloo (South)	\$1,820	Peterborough (Distinct)	\$1,464	Peterborough (Distinct)	\$1,475	Peterborough (Distinct)	\$1,584
North Bay (North)	\$1,611	North Bay (North)	\$1,633	Peterborough (Distinct)	\$1,821	North Bay (North)	\$1,472	Muskoka (Distinct)	\$1,482	Kingston (South)	\$1,584
Sault Ste. Marie (North)	\$1,645	Sault Ste. Marie (North)	\$1,658	Sault Ste. Marie (North)	\$1,858	Muskoka (Distinct)	\$1,472	North Bay (North)	\$1,485	Kitchener-Waterloo (South)	\$1,602
Sudbury (North)	\$1,686	Sudbury (North)	\$1,709	Sudbury (North)	\$1,955	Sudbury (North)	\$1,519	Sudbury (North)	\$1,533	Sudbury (North)	\$1,684
Timmins (North)	\$1,812	Timmins (North)	\$1,834	Thunder Bay (North)	\$2,002	Timmins (North)	\$1,598	Timmins (North)	\$1,612	Thunder Bay (North)	\$1,718
Thunder Bay (North)	\$1,825	Thunder Bay (North)	\$1,845	Kenora (North)	\$2,107	Thunder Bay (North)	\$1,630	Thunder Bay (North)	\$1,642	Kenora (North)	\$1,784
Kenora (North)	\$1,879	Kenora (North)	\$1,896	Timmins (North)	\$2,125	Kenora (North)	\$1,655	Kenora (North)	\$1,665	Timmins (North)	\$1,816
Kapuskasing (North)	\$1,956	Kapuskasing (North)	\$1,974	Kapuskasing (North)	\$2,261	Kapuskasing (North)	\$1,709	Kapuskasing (North)	\$1,719	Kapuskasing (North)	\$1,943

A detailed assessment of operating costs for main scenario (base case scenario) in regards to comparative scenarios (carbon taxes, feed-in tariff, rebates, FIT + Rebates, and (FIT + Rebates) + Carbon Taxes can be seen in Appendix D1 for average construction type and Appendix D2 for improved construction type.

Table 7b: Difference (% Change) in Total Operating Costs (Space Heating + Space Cooling + Hot Water)					
V.GSHP		H.GSHP		Traditional	
	% Change		% Change		% Change
Kapuskasing (North)	-13%	Kapuskasing (North)	-13%	Sault Ste. Marie (North)	-17%
Sault Ste. Marie (North)	-12%	Kenora (North)	-12%	Kenora (North)	-15%
Kenora (North)	-12%	Timmins (North)	-12%	London (South)	-15%
Timmins (North)	-12%	Sault Ste. Marie (North)	-12%	Muskoka (Distinct)	-15%
Guelph (South)	-11%	Mt. Forest (South)	-12%	Barrie (Distinct)	-15%
Hamilton (South)	-11%	Thunder Bay (North)	-11%	Sarnia (South)	-15%
London (South)	-11%	Guelph (South)	-11%	Timmins (North)	-15%
Cambridge (South)	-11%	Hamilton (South)	-11%	Thunder Bay (North)	-14%
Thunder Bay (North)	-11%	Toronto (South)	-11%	Kapuskasing (North)	-14%
Sarnia (South)	-11%	London (South)	-11%	North Bay (North)	-14%
Simcoe (South)	-11%	Cambridge (South)	-11%	Sudbury (North)	-14%
Windsor (South)	-10%	Sarnia (South)	-11%	Ottawa (Distinct)	-13%
Chatham (South)	-10%	Simcoe (South)	-10%	Simcoe (South)	-13%
Niagara Falls (South)	-10%	St. Catharines (South)	-10%	Windsor (South)	-13%
Sudbury (North)	-10%	Sudbury (North)	-10%	Chatham (South)	-13%
Mt. Forest (South)	-10%	Windsor (South)	-10%	Peterborough (Distinct)	-13%
North Bay (North)	-9%	Chatham (South)	-10%	Guelph (South)	-13%
Trenton (South)	-8%	Niagara Falls (South)	-10%	Cambridge (South)	-13%
Toronto (South)	-8%	North Bay (North)	-9%	Mt. Forest (South)	-13%
Ottawa (Distinct)	-8%	Kingston (South)	-9%	Niagara Falls (South)	-12%
Muskoka (Distinct)	-8%	Warton (South)	-9%	Warton (South)	-12%
Peterborough (Distinct)	-8%	Kitchener-Waterloo (South)	-8%	Toronto (South)	-12%
St. Catharines (South)	-7%	Trenton (South)	-8%	Kitchener-Waterloo (South)	-12%
Barrie (Distinct)	-7%	Ottawa (Distinct)	-8%	Hamilton (South)	-12%
Warton (South)	-7%	Muskoka (Distinct)	-8%	Kingston (South)	-12%
Kitchener-Waterloo (South)	-7%	Peterborough (Distinct)	-8%	Trenton (South)	-12%
Kingston (South)	-7%	Barrie (Distinct)	-7%	St. Catharines (South)	-10%

3.1.2 Economic Assessment

The economic assessment provides a ranking of the most expensive and least expensive cities in Ontario with respect to the potential for use of vertical ground source heat pump system (V.GSHPs), horizontal ground source heat pump system (H.GSHPs) and they are compared against traditional HVAC applications.

Construction Type

A 2,000 square feet detached house above grade was divided into *average construction* type (normal construction, poor vapor barrier) and *improved construction* type (improved construction, sealed vapor barrier). The improved construction type has led to lower heating and cooling loads that has reduced the HVAC system capacity (lower installation costs), and electrical (KWh) and natural gas (m³) usage (lower operating costs). This has also minimized the maintenance and disposal costs for the HVAC systems.

Present Value

The concept of present value lies at the heart of finance in general and actuarial science in particular. The importance of the concept is universally recognized. Present values of various cash flows are extensively utilized in the pricing of financial instruments, funding of financial commitments, financial reporting, and other areas (Mindlin, 2013).

The calculation of a present value utilizes a discount rate – a deterministic return assumption that represents investment returns. If the investment return and the commitment are certain, then the discount rate is equal to the investment return and the present value is equal to the sum of all payments discounted by the compounded discount rates. The asset value that is equal to this present value and invested in the portfolio that generates the investment return will fund the commitment with certainty (Mindlin, 2013).

The parameter of present value (PV) was selected for the economic assessment to quantify the hierarchy of the twenty-seven (27) cities (in an ascending order) from northern, southern, and distinct (central & eastern) regions of Ontario. The PV is the value of money on a specific date for a future payment, discounted at a rate to reflect the time value of money (Economy | Mortgage 101, 2010). It is the current worth of future cash flows of a project at a given discount rate (Byers, 2009).

$$PV = \frac{C}{(1+i)^n} \quad (11)$$

where ‘C’ is a future cash flow, ‘i’ is the discount rate, and ‘n’ is the number of years.

A project's financial benefit is measured by its present value (PV), which is determined by discounting all arising cash flows (at a given rate of return) to the start time of the project. As such, the PV can be regarded as the 'cash equivalent' of undertaking the project (Wiesemann & Rustem, 2010). It is a financial quantitative measure that is commonly used to make investment decisions to select the most economical project from different options.

The discount rates of 5%, 7%, 7.5%, 8.5%, 10%, and 12% were selected to do the sensitivity analysis. Low discount rates are used for less risky projects and high discount rates are used to adjust to reflect high risk project (Byers, 2009). To put it into context, the Canadian prime mortgage rates have been fluctuating between 2.25% (Year 2009-2010) and 22.75% (Year 1981) inclusive since the year of 1935 (Ratehub, 2017).

Life Cycle Analysis

The lifespan of vertical and horizontal ground source heat pump systems ranges between 20 years (conservative) and 30 years (liberal) and the lifespan of traditional HVAC applications is considered to be 12 years. Therefore, a two life cycle (investment is made twice) and a three life cycle (investment is made three times) analysis was done for V.GSHP and H.GSHP in comparison with a five life cycle (investment is made five times) analysis for traditional HVAC applications in a 60 year project lifespan for a 2,000 square feet detached house above grade in twenty-seven (27) cities of Ontario.

Life Cycle Costing

The life cycle costing consists of: (i) investment costs, (ii) operating costs, (iii) maintenance costs, and (iv) disposal costs.

i) Investment Costs

According to the interactions with the geothermal industry experts, a V.GSHP system costs \$8,000 per ton and H.GSHP systems costs \$5,000 per ton in installation cost. On the contrary, a natural gas furnace is \$1,250 per ton, natural gas water heater is \$500 per ton, and air conditioner (A/C) is \$1,250 per ton. These are average numbers (rule of thumb) that have been used for this research project. The installation cost varies specifically based on brands. (Marco, 2016).

ii) Operating Costs

The operating costs are directly linked to the electrical and natural gas usage of the HVAC applications. These numbers have been generated from 'GeoSmart Design Studio' software. The

forecasted electricity and natural gas rates have led to an increase in operating costs in the future years as the analysis on HVAC systems was done in this study based on a 60 year project lifespan.

iii) Maintenance Costs

The value of \$25 per ton for V.GSHP and H.GSHP and \$35 per ton for traditional energy applications was considered in this study based on the advise of HVAC industry experts (Marco, 2016; and Acchione, 2016).

iv) Disposal Costs

A disposal cost of \$20 per ton for V.GSHP and H.GSHP and \$30 per ton for traditional energy applications was used in consultation of the HVAC industry experts (Marco, 2016; and Acchione, 2016).

Main Case Scenario v/s Comparative Scenarios

The present value (PV) results obtained are considered to be the main scenario (base case scenario). These results were than compared with the comparative scenario: (i) carbon taxes, (ii) feed-in tariff (FIT), (iii) Rebates, (iv) FIT + Rebates, and (v) (FIT + Rebates) + Carbon Taxes to do additional detailed scenario analysis.

i) Carbon Taxes

A carbon tax of \$10/ton was selected in year one and projected to increase by \$10/ton per year in the subsequent years till the end of the project lifespan (i.e. year 60). This is applied to the operating costs of natural gas furnace and natural gas water heater for traditional HVAC systems only as the fuel source for space heating and hot water usage is natural gas that emits carbon emissions leading to a high environmental carbon footprint in the residential sector of Ontario. The natural gas usage (in cubic meters) was converted into carbon tons (1 cubic meter of natural gas emits 0.00181 tons of carbon emissions) and the \$10/ton penalty was applied on it. This has resulted in high operating costs for the traditional HVAC systems.

Approximately, CH₄ at normal conditions has a mass density of 0.656 kg per meter cubed (atomic mass divided by Avogadro's number). If 100% combusted, the products are (Dusseault, 2017):



So, for each carbon atom in methane, one carbon atom in carbon dioxide is created. The atomic weight of carbon is 12, of methane is 16, and of carbon dioxide is 44. The calculation has resulted in about 1.804 kg of CO₂ generated from the one cubic meter of methane (CH₄) (Dusseault, 2017).

So, this is about 0.00181 tonnes per cubic meter of methane at standard temperature and pressure (STP) (Dusseault, 2017).

ii) Feed-in Tariff (FIT)

A feed-in tariff (FIT) of \$0.05/KWh is applied to the operating costs (electricity rates *i.e.* \$/KWh) of vertical and horizontal ground source heat pump systems (consistently from year 1 to year 60). These systems are based on electricity (fuel type) use only. This has decreased the operating costs of vertical and horizontal ground source heat pump systems from year 1 to year 60.

iii) Rebates

A government rebate of \$5,000 is considered for the vertical and horizontal ground source heat pump systems on the investment (installation cost) of the systems. This has minimized the investment cost to give a relief to the consumers of the clean and environmental friendly technology.

iv) FIT + Rebates

In this case, both the options of FIT (\$0.05/KWh) and Rebates (\$5,000 on the installation cost) were applied to the vertical and horizontal ground source heat pump systems.

v) (FIT + Rebates) + Carbon Taxes

In this scenario, the options of FIT (\$0.05/KWh) and Rebates (\$5,000 on the installation cost) were for the vertical and horizontal ground source heat pump systems and a carbon tax (\$10/ton and an increase in the subsequent years) for the traditional applications (natural gas furnace and natural gas water heater) were considered.

A comprehensive snapshot of the economic assessment can be seen in Figure 65 below:

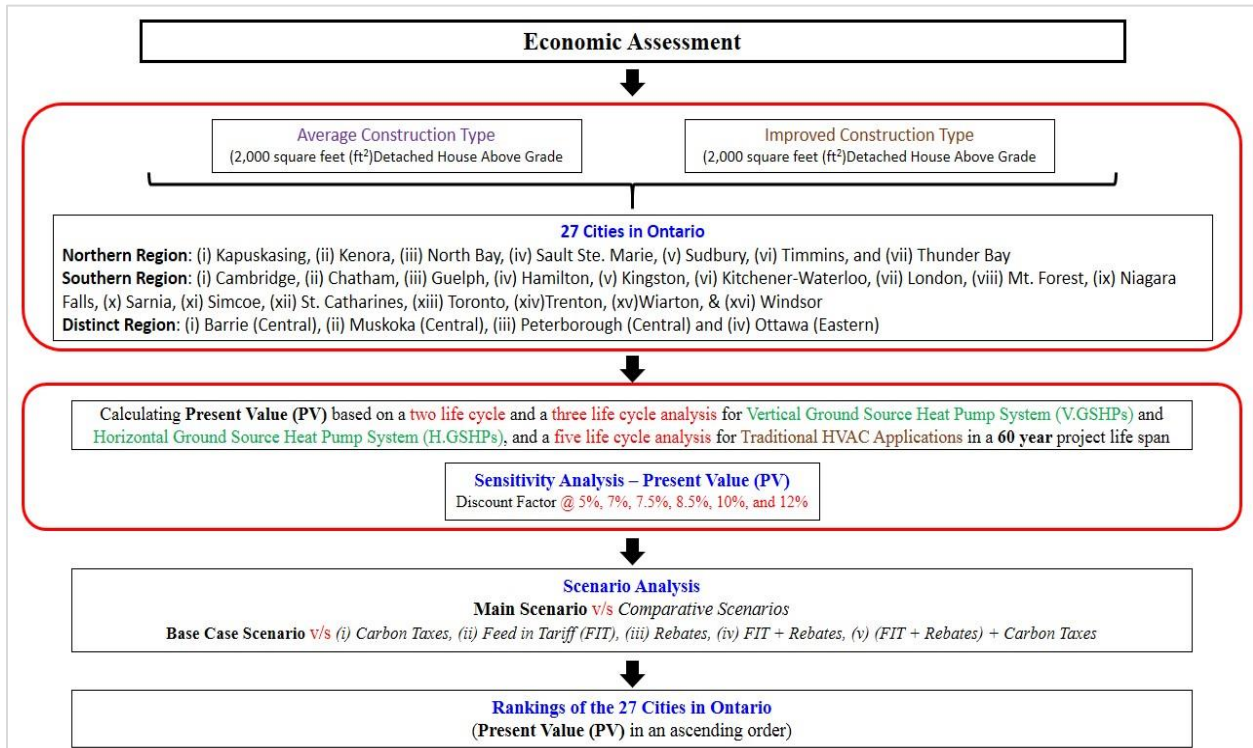

Figure 65: A comprehensive snapshot of the economic assessment

3.1.2.1 Results and Analysis

Ground Source Heat Pump Systems (GSHPs) are an economically viable solution as an HVAC equipment in the residential households of Ontario but with a variation. The economic model has developed an understanding of the cost structure of GSHPs and traditional energy applications for space heating, cooling, and hot water usage in a 2,000 square feet detached house above grade facility in twenty seven (27) different cities of Ontario.

3.1.2.1.1 Economic Variation

It can be seen from Table 8 that horizontal ground source heat pump systems (H.GSHPs) is an ideal option as an HVAC system for the consumers in the residential households of Ontario. The H.GSHPs has occupied the top spot under the assessment of different scenarios and various discount factors. The financial measure of present value (PV) for the H.GSHP has clearly indicated its economic viability over its competitors. However, H.GSHPs has to share the top spot with the traditional HVAC applications under certain scenarios as some cities have favoured the later than the former. The overlap in graphical analysis can be analyzed in Appendix E1 and E2.

The low interest rates have favoured the vertical ground source heat pump systems (V.GSHPs) over the traditional HVAC applications in certain circumstances (see Table 8). The comparative scenarios (Carbon Taxes (#1), FIT (#2), Rebates (#3), FIT + Rebates (#4), and FIT + Rebates + Carbon Taxes (#5)) have also supported the H.GSHPs as a financially viable preference for the residential sector of Ontario. The results are quite consistent across the entire spectrum of multiple scenarios (see Table 8).

Table 8: Economic Variation of HVAC Technologies for Different Scenarios at Various Discount Rates

Table 8: Economic Variation of HVAC Technologies for Different Scenarios at Various Discount Rates																								
	Average Construction												Improved construction											
Scenarios	2 Life Cycles of V.GSHP & H.GSHP and 5 Life Cycles of Traditional Energy Applications						3 Life Cycles of V.GSHP & H.GSHP and 5 Life Cycles of Traditional Energy Applications						2 Life Cycles of V.GSHP & H.GSHP and 5 Life Cycles of Traditional Energy Applications						3 Life Cycles of V.GSHP & H.GSHP and 5 Life Cycles of Traditional Energy Applications					
	5%	7%	7.5%	8.5%	10%	12%	5%	7%	7.5%	8.5%	10%	12%	5%	7%	7.5%	8.5%	10%	12%	5%	7%	7.5%	8.5%	10%	12%
B.C	H V&T	H T V	H&T V	H&T V	H&T V	H&T V	H&T V	H&T V	H&T V	H&T V	H&T V	H&T V	H V&T	H V&T	H&T V&T	H&T V	H&T V	H&T V	H&T V	H&T V	H&T V	H&T V	H&T V	H&T V
Comparative Scenarios																								
C.T (#1)	H V T	H V&T	H V&T	H V&T	H T V	H&T V	H V&T	H V&T	H V&T	H T V	H&T V	H&T V	H V T	H V&T	H V&T	H V&T	H V&T	H&T V	H V&T	H V&T	H V&T	H V&T	H&T V	H&T V
FIT (#2)	H V&T	H V&T	H V&T	H V&T	H T V	H&T V	H V&T	H T V	H&T V	H&T V	H&T V	H&T V	H V&T	H V&T	H V&T	H V&T	H V&T	H&T V	H V&T	H V&T	H V&T	H V&T	H&T V	H&T V
REB (#3)	H V&T	H V&T	H V&T	H V&T	H T V	H&T V	H T V	H T V	H T V	H&T V	H&T V	H&T V	H V&T	H V&T	H V&T	H V&T	H V&T	H&T V	H V&T	H V&T	H V&T	H V&T	H&T V	H&T V
FIT+REB (#4)	H V T	H V&T	H V&T	H V&T	H T V	H&T V	H V&T	H V&T	H V&T	H V&T	H T V	H T V	H V T	H V&T	H V&T	H V&T	H V&T	H&T V	H V&T	H V&T	H V&T	H V&T	H&T V	H&T V
FIT+REB+C.T (#5)	H V T	H V T	H V T	H V T	H V&T	H V&T	H V T	H V&T	H V&T	H V&T	H V&T	H V&T	H V T	H V T	H V T	H V T	H V&T	H V&T	H V T	H V T	H V T	H V T	H V&T	H V&T

B.C = Base Case; **C.T** = Carbon Taxes; **FIT** = Feed-in Tariff; **REB** = Rebates;

H = Horizontal Ground Source Heat Pump; **V** = Vertical Grounds Source Heat Pump; **T** = Traditional Energy Application

Note: A detailed graphical analysis can be seen in Appendix E1 and E2.

3.1.2.1.2 Rankings of the Cities – Average Construction Type

Two Life Cycles (V.GSHP & H.GSHP) and Five Life Cycles (Traditional HVAC Applications)

The economic assessment (based on present value (PV)) shows that the vertical ground source heat pump system (V.GSHPs) and horizontal ground source heat pump systems (H.GSHPs) is least expensive in St. Catharines whereas the traditional HVAC system is least expensive in Cambridge.

The most expensive city for V.GSHP, H.GSHP, and traditional HVAC applications comes to be Kapuskasing. This pattern is consistent in terms of main scenario (base case scenario) v/s comparative scenarios (carbon taxes, FIT, Rebates, FIT + Rebates, and (FIT + Rebates) + Carbon Taxes. The increase in discount rate (5% to 12%) hasn't impacted the rankings of the least expensive and most expensive cities but it has changed the rankings of some of the cities in the middle of the ranking order as higher discount rates tends to have a lesser impact (less weight) on the later years of the cash flow. The present values and % change increase/decrease with respect to comparative scenarios can be seen in Tables 9a to 9l. A detailed breakdown of the rankings in an ascending order can be viewed in Appendix F1.

Three Life Cycles (V.GSHP & H.GSHP) and Five Life Cycles (Traditional HVAC Applications)

A similar patterns resulted for the average construction type for three life cycles of V.GSHP & H.GSHP and five life cycles of traditional HVAC applications with St. Catharines being the least expensive for V.GSHP and H.GSHP and Cambridge being the least expensive for traditional HVAC applications. Kapuskasing tops the list of most expensive city for all the three HVAC technologies. This pattern is consistent for all the sensitivity (discount factors) and scenario (main v/s comparative) analysis. The rankings of some of the cities in the middle of the ranking order has changed as higher discount rates tends to have a lesser impact (less weight) on the later years of the cash flow. The present values and % change increase/decrease with respect to comparative scenarios can be seen in Tables 10a to 10l. A detailed breakdown of the rankings in an ascending order can be viewed in Appendix F1.

3.1.2.1.3 Rankings of the Cities – Improved Construction Type

Two Life Cycles (V.GSHP & H.GSHP) and Five Life Cycles (Traditional HVAC Applications)

In the case of improved construction, Sarnia takes the lead for the least expensive city for V.GSHP and St. Catharines for H.GSHP. Cambridge proved to be the least expensive city for traditional HVAC applications. The switching from average construction type to improved construction type has helped Sarnia to replace St. Catharines (as St. Catharines was the lead in

average construction type for both V.GSHP and H.GSHP) as the least expensive city for V.GSHP. Kapuskasing has once again being credited as the most expensive city for all the three technologies. This pattern is consistent for all the sensitivity (discount factors) and scenario (main v/s comparative) analysis. The rankings of some of the cities in the middle of the ranking order has changed as higher discount rates tends to have a lesser impact (less weight) on the later years of the cash flow. The present values and % change increase/decrease with respect to comparative scenarios can be seen in Tables 11a to 11l. A detailed breakdown of the rankings in an ascending order can be viewed in Appendix F2.

Three Life Cycles (V.GSHP & H.GSHP) and Five Life Cycles (Traditional HVAC Applications)

A similar rankings resulted in this case as compared to the improved construction type for two life cycles of V.GSHP & H.GSHP and five life cycles of traditional HVAC applications with Sarnia being the least expensive for V.GSHP, St. Catharines for H.GSHP, and Cambridge for traditional HVAC applications. This pattern is consistent for all the sensitivity (discount factors) and scenario (main v/s comparative) analysis. The rankings of some of the cities in the middle of the ranking order has changed as higher discount rates tends to have a lesser impact (less weight) on the later years of the cash flow. The present values and % change (increase/decrease) with respect to comparative scenarios can be seen in Tables 12a to 12l. A detailed breakdown of the rankings in an ascending order can be viewed in Appendix F2.

			Total Present Value																		
			Main Scenario				v/s	Comparative Scenarios													
			Base Case Scenario			v/s	Carbon Taxes - (€1)			FIT - (€2)			Rebates - (€3)			(FIT+Rebates) - (€4)			(FIT+Rebates) + Carbon Taxes - (€5)		
City	Project Life Span	Discount Rate	V.GSHP	H.GSHP	Traditional	v/s	V.GSHP	H.GSHP	Traditional	V.GSHP	H.GSHP	Traditional	V.GSHP	H.GSHP	Traditional	V.GSHP	H.GSHP	Traditional	V.GSHP	H.GSHP	Traditional
Cambridge (South)	60 Years (2 Life Cycles)	5%	\$80,494	\$63,687	\$73,410	v/s	\$80,494	\$63,687	\$95,355	\$71,034	\$54,162	\$73,410	\$73,399	\$56,592	\$73,410	\$63,939	\$47,067	\$73,410	\$63,939	\$47,067	\$95,355
Chatham (South)	60 Years (2 Life Cycles)	5%	\$78,254	\$61,427	\$76,326	v/s	\$78,254	\$61,427	\$95,858	\$69,452	\$52,566	\$76,326	\$71,158	\$54,332	\$76,326	\$62,356	\$45,470	\$76,326	\$62,356	\$45,470	\$95,858
Guelph (South)	60 Years (2 Life Cycles)	5%	\$81,007	\$64,216	\$74,460	v/s	\$81,007	\$64,216	\$97,111	\$71,396	\$54,536	\$74,460	\$73,911	\$57,120	\$74,460	\$64,301	\$47,440	\$74,460	\$64,301	\$47,440	\$97,111
Hamilton (South)	60 Years (2 Life Cycles)	5%	\$79,978	\$63,165	\$81,417	v/s	\$79,978	\$63,165	\$102,765	\$70,670	\$53,793	\$81,417	\$72,883	\$56,069	\$81,417	\$63,574	\$46,698	\$81,417	\$63,574	\$46,698	\$102,765
Kingston (South)	60 Years (2 Life Cycles)	5%	\$93,388	\$65,222	\$86,900	v/s	\$93,388	\$65,222	\$109,702	\$83,685	\$55,246	\$86,900	\$86,292	\$58,126	\$86,900	\$76,590	\$48,150	\$86,900	\$76,590	\$48,150	\$109,702
Kitchener-Waterloo (South)	60 Years (2 Life Cycles)	5%	\$92,811	\$64,551	\$82,867	v/s	\$92,811	\$64,551	\$105,560	\$83,278	\$54,772	\$82,867	\$85,715	\$57,456	\$82,867	\$76,182	\$47,677	\$82,867	\$76,182	\$47,677	\$105,560
London (South)	60 Years (2 Life Cycles)	5%	\$80,504	\$63,671	\$78,824	v/s	\$80,504	\$63,671	\$100,697	\$71,041	\$54,151	\$78,824	\$73,408	\$56,576	\$78,824	\$63,946	\$47,055	\$78,824	\$63,946	\$47,055	\$100,697
Mt. Forest (South)	60 Years (2 Life Cycles)	5%	\$82,013	\$65,209	\$82,855	v/s	\$82,013	\$65,209	\$107,110	\$72,107	\$55,237	\$82,855	\$74,917	\$58,113	\$82,855	\$65,011	\$48,141	\$82,855	\$65,011	\$48,141	\$107,110
Niagara Falls (South)	60 Years (2 Life Cycles)	5%	\$78,605	\$61,776	\$77,796	v/s	\$78,605	\$61,776	\$97,576	\$69,700	\$52,812	\$77,796	\$71,509	\$54,680	\$77,796	\$62,604	\$45,716	\$77,796	\$62,604	\$45,716	\$97,576
Sarnia (South)	60 Years (2 Life Cycles)	5%	\$78,067	\$61,218	\$80,041	v/s	\$78,067	\$61,218	\$100,116	\$69,319	\$52,418	\$80,041	\$70,971	\$54,122	\$80,041	\$62,224	\$45,322	\$80,041	\$62,224	\$45,322	\$100,116
Simcoe (South)	60 Years (2 Life Cycles)	5%	\$79,417	\$62,607	\$80,339	v/s	\$79,417	\$62,607	\$101,145	\$70,274	\$53,399	\$80,339	\$72,322	\$55,512	\$80,339	\$63,178	\$46,304	\$80,339	\$63,178	\$46,304	\$101,145
St. Catharines (South)	60 Years (2 Life Cycles)	5%	\$77,319	\$60,493	\$79,535	v/s	\$77,319	\$60,493	\$98,790	\$68,791	\$51,905	\$79,535	\$70,223	\$53,397	\$79,535	\$61,696	\$44,810	\$79,535	\$61,696	\$44,810	\$98,790
Toronto (South)	60 Years (2 Life Cycles)	5%	\$80,526	\$63,736	\$80,545	v/s	\$80,526	\$63,736	\$102,539	\$71,057	\$54,196	\$80,545	\$73,431	\$56,640	\$80,545	\$63,961	\$47,101	\$80,545	\$63,961	\$47,101	\$102,539
Trenton (South)	60 Years (2 Life Cycles)	5%	\$80,981	\$64,139	\$86,144	v/s	\$80,981	\$64,139	\$108,288	\$71,378	\$54,481	\$86,144	\$73,885	\$57,043	\$86,144	\$64,283	\$47,385	\$86,144	\$64,283	\$47,385	\$108,288
Warton (South)	60 Years (2 Life Cycles)	5%	\$93,671	\$65,451	\$84,345	v/s	\$93,671	\$65,451	\$107,913	\$83,886	\$55,408	\$84,345	\$86,576	\$58,355	\$84,345	\$76,790	\$48,312	\$84,345	\$76,790	\$48,312	\$107,913
Windsor (South)	60 Years (2 Life Cycles)	5%	\$78,289	\$61,473	\$76,395	v/s	\$78,289	\$61,473	\$95,982	\$69,477	\$52,598	\$76,395	\$71,194	\$54,377	\$76,395	\$62,381	\$45,502	\$76,395	\$62,381	\$45,502	\$95,982
Barrie (Distinct)	60 Years (2 Life Cycles)	5%	\$93,197	\$72,243	\$79,861	v/s	\$93,197	\$72,243	\$102,404	\$83,551	\$62,499	\$79,861	\$86,102	\$65,147	\$79,861	\$76,456	\$55,403	\$79,861	\$76,456	\$55,403	\$102,404
Muskoka (Distinct)	60 Years (2 Life Cycles)	5%	\$94,651	\$73,703	\$82,837	v/s	\$94,651	\$73,703	\$107,075	\$84,578	\$63,531	\$82,837	\$87,556	\$66,608	\$82,837	\$77,483	\$56,435	\$82,837	\$77,483	\$56,435	\$107,075
Ottawa (Distinct)	60 Years (2 Life Cycles)	5%	\$93,633	\$72,768	\$81,922	v/s	\$93,633	\$72,768	\$105,043	\$83,858	\$62,870	\$81,922	\$86,537	\$65,673	\$81,922	\$76,763	\$55,775	\$81,922	\$76,763	\$55,775	\$105,043
Peterborough (Distinct)	60 Years (2 Life Cycles)	5%	\$94,345	\$73,471	\$82,988	v/s	\$94,345	\$73,471	\$106,767	\$84,362	\$63,367	\$82,988	\$87,250	\$66,376	\$82,988	\$77,266	\$56,271	\$82,988	\$77,266	\$56,271	\$106,767
Kapuskasing (North)	60 Years (2 Life Cycles)	5%	\$102,346	\$81,447	\$97,635	v/s	\$102,346	\$81,447	\$127,857	\$90,014	\$69,001	\$97,635	\$95,251	\$74,351	\$97,635	\$82,918	\$61,905	\$97,635	\$82,918	\$61,905	\$127,857
Kenora (North)	60 Years (2 Life Cycles)	5%	\$100,712	\$79,790	\$91,865	v/s	\$100,712	\$79,790	\$120,089	\$88,859	\$67,830	\$91,865	\$93,616	\$72,694	\$91,865	\$81,764	\$60,735	\$91,865	\$81,764	\$60,735	\$120,089
North Bay (North)	60 Years (2 Life Cycles)	5%	\$94,945	\$74,135	\$82,176	v/s	\$94,945	\$74,135	\$106,594	\$84,785	\$63,836	\$82,176	\$87,849	\$67,040	\$82,176	\$77,690	\$56,740	\$82,176	\$77,690	\$56,740	\$106,594
Sault Ste. Marie (North)	60 Years (2 Life Cycles)	5%	\$83,602	\$66,847	\$81,631	v/s	\$83,602	\$66,847	\$106,544	\$73,230	\$56,394	\$81,631	\$76,506	\$59,751	\$81,631	\$66,134	\$49,298	\$81,631	\$66,134	\$49,298	\$106,544
Sudbury (North)	60 Years (2 Life Cycles)	5%	\$96,547	\$75,753	\$88,408	v/s	\$96,547	\$75,753	\$114,714	\$85,917	\$64,979	\$88,408	\$89,451	\$68,658	\$88,408	\$78,822	\$57,883	\$88,408	\$78,822	\$57,883	\$114,714
Timmins (North)	60 Years (2 Life Cycles)	5%	\$99,258	\$78,455	\$90,072	v/s	\$99,258	\$78,455	\$119,244	\$87,832	\$66,887	\$90,072	\$92,163	\$71,359	\$90,072	\$80,737	\$59,792	\$90,072	\$80,737	\$59,792	\$119,244
Thunder Bay (North)	60 Years (2 Life Cycles)	5%	\$99,542	\$78,687	\$87,296	v/s	\$99,542	\$78,687	\$115,117	\$88,033	\$67,051	\$87,296	\$92,446	\$71,592	\$87,296	\$80,937	\$59,956	\$87,296	\$80,937	\$59,956	\$115,117

Table 9a: Rankings of the Cities Based on present values for V.GSHP, H.GSHP (two life cycles) and Traditional HVAC Applications (five life cycles) at a discount rate of 5% for average construction scenario

Total Present Value																					
			Main Scenario			v/s	Comparative Scenarios														
			Base Case Scenario			v/s	Carbon Taxes - (€1)			FIT - (€2)			Rebates - (€3)			(FIT+Rebates) - (€4)			(FIT+Rebates) + Carbon Taxes - (€5)		
City	Project Life Span	Discount Rate	V.GSHP	H.GSHP	Traditional	v/s	V.GSHP	H.GSHP	Traditional	V.GSHP	H.GSHP	Traditional	V.GSHP	H.GSHP	Traditional	V.GSHP	H.GSHP	Traditional	V.GSHP	H.GSHP	Traditional
Cambridge (South)	60 Years (2 Life Cycles)	5%	\$80,494	\$63,687	\$73,410	v/s	0%	0%	30%	-12%	-15%	0%	-9%	-11%	0%	-21%	-26%	0%	-21%	-26%	30%
Chatham (South)	60 Years (2 Life Cycles)	5%	\$78,254	\$61,427	\$76,326	v/s	0%	0%	26%	-11%	-14%	0%	-9%	-12%	0%	-20%	-26%	0%	-20%	-26%	26%
Guelph (South)	60 Years (2 Life Cycles)	5%	\$81,007	\$64,216	\$74,460	v/s	0%	0%	30%	-12%	-15%	0%	-9%	-11%	0%	-21%	-26%	0%	-21%	-26%	30%
Hamilton (South)	60 Years (2 Life Cycles)	5%	\$79,978	\$63,165	\$81,417	v/s	0%	0%	26%	-12%	-15%	0%	-9%	-11%	0%	-21%	-26%	0%	-21%	-26%	26%
Kingston (South)	60 Years (2 Life Cycles)	5%	\$93,388	\$65,222	\$86,900	v/s	0%	0%	26%	-10%	-15%	0%	-8%	-11%	0%	-18%	-26%	0%	-18%	-26%	26%
Kitchener-Waterloo (South)	60 Years (2 Life Cycles)	5%	\$92,811	\$64,551	\$82,867	v/s	0%	0%	27%	-10%	-15%	0%	-8%	-11%	0%	-18%	-26%	0%	-18%	-26%	27%
London (South)	60 Years (2 Life Cycles)	5%	\$80,504	\$63,671	\$78,824	v/s	0%	0%	28%	-12%	-15%	0%	-9%	-11%	0%	-21%	-26%	0%	-21%	-26%	28%
Mt. Forest (South)	60 Years (2 Life Cycles)	5%	\$82,013	\$65,209	\$82,855	v/s	0%	0%	29%	-12%	-15%	0%	-9%	-11%	0%	-21%	-26%	0%	-21%	-26%	29%
Niagara Falls (South)	60 Years (2 Life Cycles)	5%	\$78,605	\$61,776	\$77,796	v/s	0%	0%	25%	-11%	-15%	0%	-9%	-11%	0%	-20%	-26%	0%	-20%	-26%	25%
Sarnia (South)	60 Years (2 Life Cycles)	5%	\$78,067	\$61,218	\$80,041	v/s	0%	0%	25%	-11%	-14%	0%	-9%	-12%	0%	-20%	-26%	0%	-20%	-26%	25%
Simcoe (South)	60 Years (2 Life Cycles)	5%	\$79,417	\$62,607	\$80,339	v/s	0%	0%	26%	-12%	-15%	0%	-9%	-11%	0%	-20%	-26%	0%	-20%	-26%	26%
St. Catharines (South)	60 Years (2 Life Cycles)	5%	\$77,319	\$60,493	\$79,535	v/s	0%	0%	24%	-11%	-14%	0%	-9%	-12%	0%	-20%	-26%	0%	-20%	-26%	24%
Toronto (South)	60 Years (2 Life Cycles)	5%	\$80,526	\$63,736	\$80,545	v/s	0%	0%	27%	-12%	-15%	0%	-9%	-11%	0%	-21%	-26%	0%	-21%	-26%	27%
Trenton (South)	60 Years (2 Life Cycles)	5%	\$80,981	\$64,139	\$86,144	v/s	0%	0%	26%	-12%	-15%	0%	-9%	-11%	0%	-21%	-26%	0%	-21%	-26%	26%
Warton (South)	60 Years (2 Life Cycles)	5%	\$93,671	\$65,451	\$84,345	v/s	0%	0%	28%	-10%	-15%	0%	-8%	-11%	0%	-18%	-26%	0%	-18%	-26%	28%
Windsor (South)	60 Years (2 Life Cycles)	5%	\$78,289	\$61,473	\$76,395	v/s	0%	0%	26%	-11%	-14%	0%	-9%	-12%	0%	-20%	-26%	0%	-20%	-26%	26%
Barrie (Distinct)	60 Years (2 Life Cycles)	5%	\$93,197	\$72,243	\$79,861	v/s	0%	0%	28%	-10%	-13%	0%	-8%	-10%	0%	-18%	-23%	0%	-18%	-23%	28%
Muskoka (Distinct)	60 Years (2 Life Cycles)	5%	\$94,651	\$73,703	\$82,837	v/s	0%	0%	29%	-11%	-14%	0%	-7%	-10%	0%	-18%	-23%	0%	-18%	-23%	29%
Ottawa (Distinct)	60 Years (2 Life Cycles)	5%	\$93,633	\$72,768	\$81,922	v/s	0%	0%	28%	-10%	-14%	0%	-8%	-10%	0%	-18%	-23%	0%	-18%	-23%	28%
Peterborough (Distinct)	60 Years (2 Life Cycles)	5%	\$94,345	\$73,471	\$82,988	v/s	0%	0%	29%	-11%	-14%	0%	-8%	-10%	0%	-18%	-23%	0%	-18%	-23%	29%
Kapuskasing (North)	60 Years (2 Life Cycles)	5%	\$102,346	\$81,447	\$97,635	v/s	0%	0%	31%	-12%	-15%	0%	-7%	-9%	0%	-19%	-24%	0%	-19%	-24%	31%
Kenora (North)	60 Years (2 Life Cycles)	5%	\$100,712	\$79,790	\$91,865	v/s	0%	0%	31%	-12%	-15%	0%	-7%	-9%	0%	-19%	-24%	0%	-19%	-24%	31%
North Bay (North)	60 Years (2 Life Cycles)	5%	\$94,945	\$74,135	\$82,176	v/s	0%	0%	30%	-11%	-14%	0%	-7%	-10%	0%	-18%	-23%	0%	-18%	-23%	30%
Sault Ste. Marie (North)	60 Years (2 Life Cycles)	5%	\$83,602	\$66,847	\$81,631	v/s	0%	0%	31%	-12%	-16%	0%	-8%	-11%	0%	-21%	-26%	0%	-21%	-26%	31%
Sudbury (North)	60 Years (2 Life Cycles)	5%	\$96,547	\$75,753	\$88,408	v/s	0%	0%	30%	-11%	-14%	0%	-7%	-9%	0%	-18%	-24%	0%	-18%	-24%	30%
Timmins (North)	60 Years (2 Life Cycles)	5%	\$99,258	\$78,455	\$90,072	v/s	0%	0%	32%	-12%	-15%	0%	-7%	-9%	0%	-19%	-24%	0%	-19%	-24%	32%
Thunder Bay (North)	60 Years (2 Life Cycles)	5%	\$99,542	\$78,687	\$87,296	v/s	0%	0%	32%	-12%	-15%	0%	-7%	-9%	0%	-19%	-24%	0%	-19%	-24%	32%

Table 9b: % change in present values for comparative scenarios in regards to the main scenario for V.GSHP, H.GSHP (two life cycles) and Traditional HVAC Applications (five life cycles) at a discount rate of 5% for average construction scenario

			Total Present Value																		
			Main Scenario				v/s	Comparative Scenarios													
			Base Case Scenario			v/s	Carbon Taxes - (#1)			FIT - (#2)			Rebates - (#3)			(FIT+Rebates) - (#4)			(FIT+Rebates) + Carbon Taxes - (#5)		
City	Project Life Span	Discount Rate	V.GSHP	H.GSHP	Traditional	v/s	V.GSHP	H.GSHP	Traditional	V.GSHP	H.GSHP	Traditional	V.GSHP	H.GSHP	Traditional	V.GSHP	H.GSHP	Traditional	V.GSHP	H.GSHP	Traditional
Cambridge (South)	60 Years (2 Life Cycles)	7%	\$65,115	\$50,422	\$53,985	v/s	\$65,115	\$50,422	\$67,142	\$58,099	\$43,357	\$53,985	\$58,925	\$44,232	\$53,985	\$51,909	\$37,167	\$53,985	\$51,909	\$37,167	\$67,142
Chatham (South)	60 Years (2 Life Cycles)	7%	\$63,480	\$48,772	\$56,197	v/s	\$63,480	\$48,772	\$67,907	\$56,951	\$42,200	\$56,197	\$57,290	\$42,583	\$56,197	\$50,762	\$36,010	\$56,197	\$50,762	\$36,010	\$67,907
Guelph (South)	60 Years (2 Life Cycles)	7%	\$65,489	\$50,807	\$54,741	v/s	\$65,489	\$50,807	\$68,321	\$58,361	\$43,628	\$54,741	\$59,299	\$44,618	\$54,741	\$52,171	\$37,438	\$54,741	\$52,171	\$37,438	\$68,321
Hamilton (South)	60 Years (2 Life Cycles)	7%	\$64,738	\$50,041	\$59,938	v/s	\$64,738	\$50,041	\$72,737	\$57,835	\$43,090	\$59,938	\$58,549	\$43,851	\$59,938	\$51,645	\$36,900	\$59,938	\$51,645	\$36,900	\$72,737
Kingston (South)	60 Years (2 Life Cycles)	7%	\$76,117	\$51,541	\$64,021	v/s	\$76,117	\$51,541	\$77,691	\$68,921	\$44,143	\$64,021	\$69,927	\$45,352	\$64,021	\$62,732	\$37,953	\$64,021	\$62,732	\$37,953	\$77,691
Kitchener-Waterloo (South)	60 Years (2 Life Cycles)	7%	\$75,696	\$51,052	\$60,977	v/s	\$75,696	\$51,052	\$74,583	\$68,626	\$43,800	\$60,977	\$69,506	\$44,862	\$60,977	\$62,436	\$37,610	\$60,977	\$62,436	\$37,610	\$74,583
London (South)	60 Years (2 Life Cycles)	7%	\$65,122	\$50,410	\$57,988	v/s	\$65,122	\$50,410	\$71,101	\$58,104	\$43,349	\$57,988	\$58,932	\$44,220	\$57,988	\$51,914	\$37,159	\$57,988	\$51,914	\$37,159	\$71,101
Mt. Forest (South)	60 Years (2 Life Cycles)	7%	\$66,223	\$51,532	\$60,947	v/s	\$66,223	\$51,532	\$75,489	\$58,876	\$44,136	\$60,947	\$60,033	\$45,342	\$60,947	\$52,686	\$37,946	\$60,947	\$52,686	\$37,946	\$75,489
Niagara Falls (South)	60 Years (2 Life Cycles)	7%	\$63,736	\$49,027	\$57,267	v/s	\$63,736	\$49,027	\$69,125	\$57,131	\$42,378	\$57,267	\$57,546	\$42,837	\$57,267	\$50,942	\$36,189	\$57,267	\$50,942	\$36,189	\$69,125
Sarnia (South)	60 Years (2 Life Cycles)	7%	\$63,343	\$48,620	\$58,951	v/s	\$63,343	\$48,620	\$70,987	\$56,856	\$42,093	\$58,951	\$57,153	\$42,430	\$58,951	\$50,666	\$35,903	\$58,951	\$50,666	\$35,903	\$70,987
Simcoe (South)	60 Years (2 Life Cycles)	7%	\$64,329	\$49,634	\$59,159	v/s	\$64,329	\$49,634	\$71,632	\$57,547	\$42,804	\$59,159	\$58,139	\$43,444	\$59,159	\$51,358	\$36,614	\$59,159	\$51,358	\$36,614	\$71,632
St. Catharines (South)	60 Years (2 Life Cycles)	7%	\$62,797	\$48,090	\$58,593	v/s	\$62,797	\$48,090	\$70,137	\$56,473	\$41,721	\$58,593	\$56,608	\$41,900	\$58,593	\$50,283	\$35,532	\$58,593	\$50,283	\$35,532	\$70,137
Toronto (South)	60 Years (2 Life Cycles)	7%	\$65,138	\$50,457	\$59,293	v/s	\$65,138	\$50,457	\$72,479	\$58,115	\$43,382	\$59,293	\$58,949	\$44,267	\$59,293	\$51,925	\$37,192	\$59,293	\$51,925	\$37,192	\$72,479
Trenton (South)	60 Years (2 Life Cycles)	7%	\$65,470	\$50,751	\$63,478	v/s	\$65,470	\$50,751	\$76,754	\$58,348	\$43,588	\$63,478	\$59,280	\$44,561	\$63,478	\$52,158	\$37,398	\$63,478	\$52,158	\$37,398	\$76,754
Warton (South)	60 Years (2 Life Cycles)	7%	\$76,324	\$51,709	\$62,095	v/s	\$76,324	\$51,709	\$76,225	\$69,067	\$44,260	\$62,095	\$70,134	\$45,519	\$62,095	\$62,877	\$38,070	\$62,095	\$62,877	\$38,070	\$76,225
Windsor (South)	60 Years (2 Life Cycles)	7%	\$63,506	\$48,805	\$56,246	v/s	\$63,506	\$48,805	\$67,989	\$56,970	\$42,223	\$56,246	\$57,316	\$42,616	\$56,246	\$50,780	\$36,033	\$56,246	\$50,780	\$36,033	\$67,989
Barrie (Distinct)	60 Years (2 Life Cycles)	7%	\$75,978	\$57,651	\$58,786	v/s	\$75,978	\$57,651	\$72,301	\$68,824	\$50,425	\$58,786	\$69,789	\$51,462	\$58,786	\$62,634	\$44,235	\$58,786	\$62,634	\$44,235	\$72,301
Muskoka (Distinct)	60 Years (2 Life Cycles)	7%	\$77,039	\$58,717	\$60,935	v/s	\$77,039	\$58,717	\$75,466	\$69,568	\$51,172	\$60,935	\$70,850	\$52,527	\$60,935	\$63,379	\$44,983	\$60,935	\$63,379	\$44,983	\$75,466
Ottawa (Distinct)	60 Years (2 Life Cycles)	7%	\$76,296	\$58,035	\$60,282	v/s	\$76,296	\$58,035	\$74,144	\$69,047	\$50,694	\$60,282	\$70,106	\$51,845	\$60,282	\$62,857	\$44,504	\$60,282	\$62,857	\$44,504	\$74,144
Peterborough (Distinct)	60 Years (2 Life Cycles)	7%	\$76,816	\$58,548	\$61,051	v/s	\$76,816	\$58,548	\$75,307	\$69,412	\$51,054	\$61,051	\$70,626	\$52,358	\$61,051	\$63,222	\$44,864	\$61,051	\$63,222	\$44,864	\$75,307
Kapuskasing (North)	60 Years (2 Life Cycles)	7%	\$82,655	\$64,368	\$71,753	v/s	\$82,655	\$64,368	\$89,872	\$73,509	\$55,137	\$71,753	\$76,465	\$58,178	\$71,753	\$67,319	\$48,948	\$71,753	\$67,319	\$48,948	\$89,872
Kenora (North)	60 Years (2 Life Cycles)	7%	\$81,462	\$63,159	\$67,519	v/s	\$81,462	\$63,159	\$84,441	\$72,672	\$54,289	\$67,519	\$75,272	\$56,969	\$67,519	\$66,482	\$48,099	\$67,519	\$66,482	\$48,099	\$84,441
North Bay (North)	60 Years (2 Life Cycles)	7%	\$77,253	\$59,032	\$60,449	v/s	\$77,253	\$59,032	\$75,089	\$69,719	\$51,394	\$60,449	\$71,064	\$52,843	\$60,449	\$63,529	\$45,204	\$60,449	\$63,529	\$45,204	\$75,089
Sault Ste. Marie (North)	60 Years (2 Life Cycles)	7%	\$67,383	\$52,727	\$59,995	v/s	\$67,383	\$52,727	\$74,931	\$59,690	\$44,975	\$59,995	\$61,193	\$46,537	\$59,995	\$53,500	\$38,785	\$59,995	\$53,500	\$38,785	\$74,931
Sudbury (North)	60 Years (2 Life Cycles)	7%	\$78,423	\$60,213	\$65,022	v/s	\$78,423	\$60,213	\$80,794	\$70,539	\$52,222	\$65,022	\$72,233	\$54,024	\$65,022	\$64,349	\$46,032	\$65,022	\$64,349	\$46,032	\$80,794
Timmins (North)	60 Years (2 Life Cycles)	7%	\$80,401	\$62,185	\$66,147	v/s	\$80,401	\$62,185	\$83,637	\$71,927	\$53,605	\$66,147	\$74,211	\$55,995	\$66,147	\$65,737	\$47,416	\$66,147	\$65,737	\$47,416	\$83,637
Thunder Bay (North)	60 Years (2 Life Cycles)	7%	\$80,608	\$62,354	\$64,140	v/s	\$80,608	\$62,354	\$80,819	\$72,072	\$53,724	\$64,140	\$74,418	\$56,164	\$64,140	\$65,883	\$47,535	\$64,140	\$65,883	\$47,535	\$80,819

Table 9c: Rankings of the Cities Based on present values for V.GSHP, H.GSHP (two life cycles) and Traditional HVAC Applications (five life cycles) at a discount rate of 7% for average construction scenario

			Total Present Value																		
			Main Scenario				v/s	Comparative Scenarios													
			Base Case Scenario			v/s	Carbon Taxes - (#1)			FIT - (#2)			Rebates - (#3)			(FIT+Rebates) - (#4)			(FIT+Rebates) + Carbon Taxes - (#5)		
City	Project Life Span	Discount Rate	V.GSHP	H.GSHP	Traditional	v/s	V.GSHP	H.GSHP	Traditional	V.GSHP	H.GSHP	Traditional	V.GSHP	H.GSHP	Traditional	V.GSHP	H.GSHP	Traditional	V.GSHP	H.GSHP	Traditional
Cambridge (South)	60 Years (2 Life Cycles)	7%	\$65,115	\$50,422	\$53,985	v/s	0%	0%	24%	-11%	-14%	0%	-10%	-12%	0%	-20%	-26%	0%	-20%	-26%	24%
Chatham (South)	60 Years (2 Life Cycles)	7%	\$63,480	\$48,772	\$56,197	v/s	0%	0%	21%	-10%	-13%	0%	-10%	-13%	0%	-20%	-26%	0%	-20%	-26%	21%
Guelph (South)	60 Years (2 Life Cycles)	7%	\$65,489	\$50,807	\$54,741	v/s	0%	0%	25%	-11%	-14%	0%	-9%	-12%	0%	-20%	-26%	0%	-20%	-26%	25%
Hamilton (South)	60 Years (2 Life Cycles)	7%	\$64,738	\$50,041	\$59,938	v/s	0%	0%	21%	-11%	-14%	0%	-10%	-12%	0%	-20%	-26%	0%	-20%	-26%	21%
Kingston (South)	60 Years (2 Life Cycles)	7%	\$76,117	\$51,541	\$64,021	v/s	0%	0%	21%	-9%	-14%	0%	-8%	-12%	0%	-18%	-26%	0%	-18%	-26%	21%
Kitchener-Waterloo (South)	60 Years (2 Life Cycles)	7%	\$75,696	\$51,052	\$60,977	v/s	0%	0%	22%	-9%	-14%	0%	-8%	-12%	0%	-18%	-26%	0%	-18%	-26%	22%
London (South)	60 Years (2 Life Cycles)	7%	\$65,122	\$50,410	\$57,988	v/s	0%	0%	23%	-11%	-14%	0%	-10%	-12%	0%	-20%	-26%	0%	-20%	-26%	23%
Mt. Forest (South)	60 Years (2 Life Cycles)	7%	\$66,223	\$51,532	\$60,947	v/s	0%	0%	24%	-11%	-14%	0%	-9%	-12%	0%	-20%	-26%	0%	-20%	-26%	24%
Niagara Falls (South)	60 Years (2 Life Cycles)	7%	\$63,736	\$49,027	\$57,267	v/s	0%	0%	21%	-10%	-14%	0%	-10%	-13%	0%	-20%	-26%	0%	-20%	-26%	21%
Sarnia (South)	60 Years (2 Life Cycles)	7%	\$63,343	\$48,620	\$58,951	v/s	0%	0%	20%	-10%	-13%	0%	-10%	-13%	0%	-20%	-26%	0%	-20%	-26%	20%
Simcoe (South)	60 Years (2 Life Cycles)	7%	\$64,329	\$49,634	\$59,159	v/s	0%	0%	21%	-11%	-14%	0%	-10%	-12%	0%	-20%	-26%	0%	-20%	-26%	21%
St. Catharines (South)	60 Years (2 Life Cycles)	7%	\$62,797	\$48,090	\$58,593	v/s	0%	0%	20%	-10%	-13%	0%	-10%	-13%	0%	-20%	-26%	0%	-20%	-26%	20%
Toronto (South)	60 Years (2 Life Cycles)	7%	\$65,138	\$50,457	\$59,293	v/s	0%	0%	22%	-11%	-14%	0%	-10%	-12%	0%	-20%	-26%	0%	-20%	-26%	22%
Trenton (South)	60 Years (2 Life Cycles)	7%	\$65,470	\$50,751	\$63,478	v/s	0%	0%	21%	-11%	-14%	0%	-9%	-12%	0%	-20%	-26%	0%	-20%	-26%	21%
Warton (South)	60 Years (2 Life Cycles)	7%	\$76,324	\$51,709	\$62,095	v/s	0%	0%	23%	-10%	-14%	0%	-8%	-12%	0%	-18%	-26%	0%	-18%	-26%	23%
Windsor (South)	60 Years (2 Life Cycles)	7%	\$63,506	\$48,805	\$56,246	v/s	0%	0%	21%	-10%	-13%	0%	-10%	-13%	0%	-20%	-26%	0%	-20%	-26%	21%
Barrie (Distinct)	60 Years (2 Life Cycles)	7%	\$75,978	\$57,651	\$58,786	v/s	0%	0%	23%	-9%	-13%	0%	-8%	-11%	0%	-18%	-23%	0%	-18%	-23%	23%
Muskoka (Distinct)	60 Years (2 Life Cycles)	7%	\$77,039	\$58,717	\$60,935	v/s	0%	0%	24%	-10%	-13%	0%	-8%	-11%	0%	-18%	-23%	0%	-18%	-23%	24%
Ottawa (Distinct)	60 Years (2 Life Cycles)	7%	\$76,296	\$58,035	\$60,282	v/s	0%	0%	23%	-10%	-13%	0%	-8%	-11%	0%	-18%	-23%	0%	-18%	-23%	23%
Peterborough (Distinct)	60 Years (2 Life Cycles)	7%	\$76,816	\$58,548	\$61,051	v/s	0%	0%	23%	-10%	-13%	0%	-8%	-11%	0%	-18%	-23%	0%	-18%	-23%	23%
Kapuskasing (North)	60 Years (2 Life Cycles)	7%	\$82,655	\$64,368	\$71,753	v/s	0%	0%	25%	-11%	-14%	0%	-7%	-10%	0%	-19%	-24%	0%	-19%	-24%	25%
Kenora (North)	60 Years (2 Life Cycles)	7%	\$81,462	\$63,159	\$67,519	v/s	0%	0%	25%	-11%	-14%	0%	-8%	-10%	0%	-18%	-24%	0%	-18%	-24%	25%
North Bay (North)	60 Years (2 Life Cycles)	7%	\$77,253	\$59,032	\$60,449	v/s	0%	0%	24%	-10%	-13%	0%	-8%	-10%	0%	-18%	-23%	0%	-18%	-23%	24%
Sault Ste. Marie (North)	60 Years (2 Life Cycles)	7%	\$67,383	\$52,727	\$59,995	v/s	0%	0%	25%	-11%	-15%	0%	-9%	-12%	0%	-21%	-26%	0%	-21%	-26%	25%
Sudbury (North)	60 Years (2 Life Cycles)	7%	\$78,423	\$60,213	\$65,022	v/s	0%	0%	24%	-10%	-13%	0%	-8%	-10%	0%	-18%	-24%	0%	-18%	-24%	24%
Timmins (North)	60 Years (2 Life Cycles)	7%	\$80,401	\$62,185	\$66,147	v/s	0%	0%	26%	-11%	-14%	0%	-8%	-10%	0%	-18%	-24%	0%	-18%	-24%	26%
Thunder Bay (North)	60 Years (2 Life Cycles)	7%	\$80,608	\$62,354	\$64,140	v/s	0%	0%	26%	-11%	-14%	0%	-8%	-10%	0%	-18%	-24%	0%	-18%	-24%	26%

Table 9d: % change in present values for comparative scenarios in regards to the main scenario for V.GSHP, H.GSHP (two life cycles) and Traditional HVAC Applications (five life cycles) at a discount rate of 7% for average construction scenario

			Total Present Value																		
			Main Scenario				v/s	Comparative Scenarios													
			Base Case Scenario			v/s	Carbon Taxes - (€1)			FIT - (€2)			Rebates - (€3)			(FIT+Rebates) - (€4)			(FIT+Rebates) + Carbon Taxes - (€5)		
City	Project Life Span	Discount Rate	V.GSHP	H.GSHP	Traditional	v/s	V.GSHP	H.GSHP	Traditional	V.GSHP	H.GSHP	Traditional	V.GSHP	H.GSHP	Traditional	V.GSHP	H.GSHP	Traditional	V.GSHP	H.GSHP	Traditional
Cambridge (South)	60 Years (2 Life Cycles)	7.5%	\$62,425	\$48,094	\$50,600	v/s	\$62,425	\$48,094	\$62,333	\$55,849	\$41,472	\$50,600	\$56,391	\$42,060	\$50,600	\$49,814	\$35,438	\$50,600	\$49,814	\$35,438	\$62,333
Chatham (South)	60 Years (2 Life Cycles)	7.5%	\$60,898	\$46,553	\$52,688	v/s	\$60,898	\$46,553	\$63,131	\$54,779	\$40,393	\$52,688	\$54,863	\$40,519	\$52,688	\$48,744	\$34,358	\$52,688	\$48,744	\$34,358	\$63,131
Guelph (South)	60 Years (2 Life Cycles)	7.5%	\$62,775	\$48,455	\$51,305	v/s	\$62,775	\$48,455	\$63,415	\$56,094	\$41,725	\$51,305	\$56,740	\$42,420	\$51,305	\$50,059	\$35,690	\$51,305	\$50,059	\$35,690	\$63,415
Hamilton (South)	60 Years (2 Life Cycles)	7.5%	\$62,074	\$47,738	\$56,194	v/s	\$62,074	\$47,738	\$67,607	\$55,602	\$41,223	\$56,194	\$56,039	\$41,704	\$56,194	\$49,568	\$35,188	\$56,194	\$49,568	\$35,188	\$67,607
Kingston (South)	60 Years (2 Life Cycles)	7.5%	\$73,102	\$49,140	\$60,035	v/s	\$73,102	\$49,140	\$72,226	\$66,357	\$42,205	\$60,035	\$67,068	\$43,106	\$60,035	\$60,323	\$36,171	\$60,035	\$60,323	\$36,171	\$72,226
Kitchener-Waterloo (South)	60 Years (2 Life Cycles)	7.5%	\$72,709	\$48,683	\$57,161	v/s	\$72,709	\$48,683	\$69,294	\$66,082	\$41,885	\$57,161	\$66,674	\$42,649	\$57,161	\$60,047	\$35,851	\$57,161	\$60,047	\$35,851	\$69,294
London (South)	60 Years (2 Life Cycles)	7.5%	\$62,432	\$48,083	\$54,355	v/s	\$62,432	\$48,083	\$66,049	\$55,853	\$41,465	\$54,355	\$56,397	\$42,049	\$54,355	\$49,819	\$35,430	\$54,355	\$49,819	\$35,430	\$66,049
Mt. Forest (South)	60 Years (2 Life Cycles)	7.5%	\$63,460	\$49,131	\$57,129	v/s	\$63,460	\$49,131	\$70,097	\$56,574	\$42,199	\$57,129	\$57,426	\$43,097	\$57,129	\$50,540	\$36,165	\$57,129	\$50,540	\$36,165	\$70,097
Niagara Falls (South)	60 Years (2 Life Cycles)	7.5%	\$61,137	\$46,791	\$53,687	v/s	\$61,137	\$46,791	\$64,262	\$54,946	\$40,559	\$53,687	\$55,103	\$40,756	\$53,687	\$48,912	\$34,525	\$53,687	\$48,912	\$34,525	\$64,262
Sarnia (South)	60 Years (2 Life Cycles)	7.5%	\$60,770	\$46,411	\$55,275	v/s	\$60,770	\$46,411	\$66,009	\$54,689	\$40,293	\$55,275	\$54,736	\$40,376	\$55,275	\$48,655	\$34,258	\$55,275	\$48,655	\$34,258	\$66,009
Simcoe (South)	60 Years (2 Life Cycles)	7.5%	\$61,691	\$47,358	\$55,468	v/s	\$61,691	\$47,358	\$66,591	\$55,334	\$40,956	\$55,468	\$55,657	\$41,323	\$55,468	\$49,300	\$34,922	\$55,468	\$49,300	\$34,922	\$66,591
St. Catharines (South)	60 Years (2 Life Cycles)	7.5%	\$60,260	\$45,916	\$54,943	v/s	\$60,260	\$45,916	\$65,238	\$54,332	\$39,946	\$54,943	\$54,226	\$39,882	\$54,943	\$48,298	\$33,912	\$54,943	\$48,298	\$33,912	\$65,238
Toronto (South)	60 Years (2 Life Cycles)	7.5%	\$62,447	\$48,127	\$55,590	v/s	\$62,447	\$48,127	\$67,348	\$55,864	\$41,495	\$55,590	\$56,413	\$42,093	\$55,590	\$49,830	\$35,461	\$55,590	\$49,830	\$35,461	\$67,348
Trenton (South)	60 Years (2 Life Cycles)	7.5%	\$62,757	\$48,402	\$59,530	v/s	\$62,757	\$48,402	\$71,369	\$56,081	\$41,688	\$59,530	\$56,723	\$42,367	\$59,530	\$50,047	\$35,653	\$59,530	\$50,047	\$35,653	\$71,369
Warton (South)	60 Years (2 Life Cycles)	7.5%	\$73,296	\$49,296	\$58,218	v/s	\$73,296	\$49,296	\$70,819	\$66,493	\$42,315	\$58,218	\$67,261	\$43,262	\$58,218	\$60,458	\$36,280	\$58,218	\$60,458	\$36,280	\$70,819
Windsor (South)	60 Years (2 Life Cycles)	7.5%	\$60,922	\$46,584	\$52,734	v/s	\$60,922	\$46,584	\$63,206	\$54,796	\$40,414	\$52,734	\$54,887	\$40,550	\$52,734	\$48,761	\$34,380	\$52,734	\$48,761	\$34,380	\$63,206
Barrie (Distinct)	60 Years (2 Life Cycles)	7.5%	\$72,973	\$55,096	\$55,115	v/s	\$72,973	\$55,096	\$67,167	\$66,267	\$48,322	\$55,115	\$66,938	\$49,061	\$55,115	\$60,232	\$42,287	\$55,115	\$60,232	\$42,287	\$67,167
Muskoka (Distinct)	60 Years (2 Life Cycles)	7.5%	\$73,964	\$56,091	\$57,118	v/s	\$73,964	\$56,091	\$70,076	\$66,961	\$49,019	\$57,118	\$67,929	\$50,057	\$57,118	\$60,927	\$42,985	\$57,118	\$60,927	\$42,985	\$70,076
Ottawa (Distinct)	60 Years (2 Life Cycles)	7.5%	\$73,269	\$55,454	\$56,511	v/s	\$73,269	\$55,454	\$68,872	\$66,474	\$48,573	\$56,511	\$67,235	\$49,419	\$56,511	\$60,440	\$42,538	\$56,511	\$60,440	\$42,538	\$68,872
Peterborough (Distinct)	60 Years (2 Life Cycles)	7.5%	\$73,755	\$55,933	\$57,227	v/s	\$73,755	\$55,933	\$69,940	\$66,815	\$48,908	\$57,227	\$67,721	\$49,898	\$57,227	\$60,780	\$42,874	\$57,227	\$60,780	\$42,874	\$69,940
Kapuskasing (North)	60 Years (2 Life Cycles)	7.5%	\$79,210	\$61,370	\$67,240	v/s	\$79,210	\$61,370	\$83,397	\$70,637	\$52,718	\$67,240	\$73,176	\$55,336	\$67,240	\$64,602	\$46,684	\$67,240	\$64,602	\$46,684	\$83,397
Kenora (North)	60 Years (2 Life Cycles)	7.5%	\$78,096	\$60,241	\$63,273	v/s	\$78,096	\$60,241	\$78,364	\$69,856	\$51,927	\$63,273	\$72,061	\$54,206	\$63,273	\$63,822	\$45,892	\$63,273	\$63,822	\$45,892	\$78,364
North Bay (North)	60 Years (2 Life Cycles)	7.5%	\$74,164	\$56,386	\$56,664	v/s	\$74,164	\$56,386	\$69,719	\$67,101	\$49,226	\$56,664	\$68,129	\$50,351	\$56,664	\$61,067	\$43,191	\$56,664	\$61,067	\$43,191	\$69,719
Sault Ste. Marie (North)	60 Years (2 Life Cycles)	7.5%	\$64,544	\$50,248	\$56,222	v/s	\$64,544	\$50,248	\$69,542	\$57,333	\$42,981	\$56,222	\$58,509	\$44,214	\$56,222	\$51,299	\$36,947	\$56,222	\$51,299	\$36,947	\$69,542
Sudbury (North)	60 Years (2 Life Cycles)	7.5%	\$75,256	\$57,489	\$60,946	v/s	\$75,256	\$57,489	\$75,011	\$67,866	\$49,999	\$60,946	\$69,222	\$51,454	\$60,946	\$61,832	\$43,964	\$60,946	\$61,832	\$43,964	\$75,011
Timmins (North)	60 Years (2 Life Cycles)	7.5%	\$77,105	\$59,331	\$61,974	v/s	\$77,105	\$59,331	\$77,571	\$69,162	\$51,289	\$61,974	\$71,070	\$53,296	\$61,974	\$63,127	\$45,255	\$61,974	\$63,127	\$45,255	\$77,571
Thunder Bay (North)	60 Years (2 Life Cycles)	7.5%	\$77,298	\$59,489	\$60,102	v/s	\$77,298	\$59,489	\$74,976	\$69,297	\$51,400	\$60,102	\$71,263	\$53,455	\$60,102	\$63,263	\$45,365	\$60,102	\$63,263	\$45,365	\$74,976

Table 9e: Rankings of the Cities Based on present values for V.GSHP, H.GSHP (two life cycles) and Traditional HVAC Applications (five life cycles) at a discount rate of 7.5% for average construction scenario

Total Present Value																					
		Main Scenario			v/s	Comparative Scenarios															
		Base Case Scenario			v/s	Carbon Taxes - (#1)			FIT - (#2)			Rebates - (#3)			(FIT+Rebates) - (#4)			(FIT+Rebates) + Carbon Taxes - (#5)			
City	Project Life Span	Discount Rate	V.GSHP	H.GSHP	Traditional	v/s	V.GSHP	H.GSHP	Traditional	V.GSHP	H.GSHP	Traditional	V.GSHP	H.GSHP	Traditional	V.GSHP	H.GSHP	Traditional	V.GSHP	H.GSHP	Traditional
Cambridge (South)	60 Years (2 Life Cycles)	7.5%	\$62,425	\$48,094	\$50,600	v/s	0%	0%	23%	-11%	-14%	0%	-10%	-13%	0%	-20%	-26%	0%	-20%	-26%	23%
Chatham (South)	60 Years (2 Life Cycles)	7.5%	\$60,898	\$46,553	\$52,688	v/s	0%	0%	20%	-10%	-13%	0%	-10%	-13%	0%	-20%	-26%	0%	-20%	-26%	20%
Guelph (South)	60 Years (2 Life Cycles)	7.5%	\$62,775	\$48,455	\$51,305	v/s	0%	0%	24%	-11%	-14%	0%	-10%	-12%	0%	-20%	-26%	0%	-20%	-26%	24%
Hamilton (South)	60 Years (2 Life Cycles)	7.5%	\$62,074	\$47,738	\$56,194	v/s	0%	0%	20%	-10%	-14%	0%	-10%	-13%	0%	-20%	-26%	0%	-20%	-26%	20%
Kingston (South)	60 Years (2 Life Cycles)	7.5%	\$73,102	\$49,140	\$60,035	v/s	0%	0%	20%	-9%	-14%	0%	-8%	-12%	0%	-17%	-26%	0%	-17%	-26%	20%
Kitchener-Waterloo (South)	60 Years (2 Life Cycles)	7.5%	\$72,709	\$48,683	\$57,161	v/s	0%	0%	21%	-9%	-14%	0%	-8%	-12%	0%	-17%	-26%	0%	-17%	-26%	21%
London (South)	60 Years (2 Life Cycles)	7.5%	\$62,432	\$48,083	\$54,355	v/s	0%	0%	22%	-11%	-14%	0%	-10%	-13%	0%	-20%	-26%	0%	-20%	-26%	22%
Mt. Forest (South)	60 Years (2 Life Cycles)	7.5%	\$63,460	\$49,131	\$57,129	v/s	0%	0%	23%	-11%	-14%	0%	-10%	-12%	0%	-20%	-26%	0%	-20%	-26%	23%
Niagara Falls (South)	60 Years (2 Life Cycles)	7.5%	\$61,137	\$46,791	\$53,687	v/s	0%	0%	20%	-10%	-13%	0%	-10%	-13%	0%	-20%	-26%	0%	-20%	-26%	20%
Sarnia (South)	60 Years (2 Life Cycles)	7.5%	\$60,770	\$46,411	\$55,275	v/s	0%	0%	19%	-10%	-13%	0%	-10%	-13%	0%	-20%	-26%	0%	-20%	-26%	19%
Simcoe (South)	60 Years (2 Life Cycles)	7.5%	\$61,691	\$47,358	\$55,468	v/s	0%	0%	20%	-10%	-14%	0%	-10%	-13%	0%	-20%	-26%	0%	-20%	-26%	20%
St. Catharines (South)	60 Years (2 Life Cycles)	7.5%	\$60,260	\$45,916	\$54,943	v/s	0%	0%	19%	-10%	-13%	0%	-10%	-13%	0%	-20%	-26%	0%	-20%	-26%	19%
Toronto (South)	60 Years (2 Life Cycles)	7.5%	\$62,447	\$48,127	\$55,590	v/s	0%	0%	21%	-11%	-14%	0%	-10%	-13%	0%	-20%	-26%	0%	-20%	-26%	21%
Trenton (South)	60 Years (2 Life Cycles)	7.5%	\$62,757	\$48,402	\$59,530	v/s	0%	0%	20%	-11%	-14%	0%	-10%	-12%	0%	-20%	-26%	0%	-20%	-26%	20%
Warton (South)	60 Years (2 Life Cycles)	7.5%	\$73,296	\$49,296	\$58,218	v/s	0%	0%	22%	-9%	-14%	0%	-8%	-12%	0%	-18%	-26%	0%	-18%	-26%	22%
Windsor (South)	60 Years (2 Life Cycles)	7.5%	\$60,922	\$46,584	\$52,734	v/s	0%	0%	20%	-10%	-13%	0%	-10%	-13%	0%	-20%	-26%	0%	-20%	-26%	20%
Barrie (Distinct)	60 Years (2 Life Cycles)	7.5%	\$72,973	\$55,096	\$55,115	v/s	0%	0%	22%	-9%	-12%	0%	-8%	-11%	0%	-17%	-23%	0%	-17%	-23%	22%
Muskoka (Distinct)	60 Years (2 Life Cycles)	7.5%	\$73,964	\$56,091	\$57,118	v/s	0%	0%	23%	-9%	-13%	0%	-8%	-11%	0%	-18%	-23%	0%	-18%	-23%	23%
Ottawa (Distinct)	60 Years (2 Life Cycles)	7.5%	\$73,269	\$55,454	\$56,511	v/s	0%	0%	22%	-9%	-12%	0%	-8%	-11%	0%	-18%	-23%	0%	-18%	-23%	22%
Peterborough (Distinct)	60 Years (2 Life Cycles)	7.5%	\$73,755	\$55,933	\$57,227	v/s	0%	0%	22%	-9%	-13%	0%	-8%	-11%	0%	-18%	-23%	0%	-18%	-23%	22%
Kapuskasing (North)	60 Years (2 Life Cycles)	7.5%	\$79,210	\$61,370	\$67,240	v/s	0%	0%	24%	-11%	-14%	0%	-8%	-10%	0%	-18%	-24%	0%	-18%	-24%	24%
Kenora (North)	60 Years (2 Life Cycles)	7.5%	\$78,096	\$60,241	\$63,273	v/s	0%	0%	24%	-11%	-14%	0%	-8%	-10%	0%	-18%	-24%	0%	-18%	-24%	24%
North Bay (North)	60 Years (2 Life Cycles)	7.5%	\$74,164	\$56,386	\$56,664	v/s	0%	0%	23%	-10%	-13%	0%	-8%	-11%	0%	-18%	-23%	0%	-18%	-23%	23%
Sault Ste. Marie (North)	60 Years (2 Life Cycles)	7.5%	\$64,544	\$50,248	\$56,222	v/s	0%	0%	24%	-11%	-14%	0%	-9%	-12%	0%	-21%	-26%	0%	-21%	-26%	24%
Sudbury (North)	60 Years (2 Life Cycles)	7.5%	\$75,256	\$57,489	\$60,946	v/s	0%	0%	23%	-10%	-13%	0%	-8%	-10%	0%	-18%	-24%	0%	-18%	-24%	23%
Timmins (North)	60 Years (2 Life Cycles)	7.5%	\$77,105	\$59,331	\$61,974	v/s	0%	0%	25%	-10%	-14%	0%	-8%	-10%	0%	-18%	-24%	0%	-18%	-24%	25%
Thunder Bay (North)	60 Years (2 Life Cycles)	7.5%	\$77,298	\$59,489	\$60,102	v/s	0%	0%	25%	-10%	-14%	0%	-8%	-10%	0%	-18%	-24%	0%	-18%	-24%	25%

Table 9f: % change in present values for comparative scenarios in regards to the main scenario for V.GSHP, H.GSHP (two life cycles) and Traditional HVAC Applications (five life cycles) at a discount rate of 7.5% for average construction scenario

			Total Present Value																		
			Main Scenario				v/s	Comparative Scenarios													
			Base Case Scenario			v/s	Carbon Taxes - (€1)			FIT - (€2)			Rebates - (€3)			(FIT+Rebates) - (€4)			(FIT+Rebates) + Carbon Taxes - (€5)		
City	Project Life Span	Discount Rate	V.GSHP	H.GSHP	Traditional	v/s	V.GSHP	H.GSHP	Traditional	V.GSHP	H.GSHP	Traditional	V.GSHP	H.GSHP	Traditional	V.GSHP	H.GSHP	Traditional	V.GSHP	H.GSHP	Traditional
Cambridge (South)	60 Years (2 Life Cycles)	8.5%	\$57,985	\$44,238	\$44,996	v/s	\$57,985	\$44,238	\$54,463	\$52,150	\$38,363	\$44,996	\$52,202	\$38,455	\$44,996	\$46,366	\$32,579	\$44,996	\$46,366	\$32,579	\$54,463
Chatham (South)	60 Years (2 Life Cycles)	8.5%	\$56,638	\$42,879	\$46,879	v/s	\$56,638	\$42,879	\$55,304	\$51,208	\$37,413	\$46,879	\$50,854	\$37,096	\$46,879	\$45,425	\$31,629	\$46,879	\$45,425	\$31,629	\$55,304
Guelph (South)	60 Years (2 Life Cycles)	8.5%	\$58,293	\$44,556	\$45,615	v/s	\$58,293	\$44,556	\$55,386	\$52,365	\$38,585	\$45,615	\$52,510	\$38,773	\$45,615	\$46,582	\$32,801	\$45,615	\$46,582	\$32,801	\$55,386
Hamilton (South)	60 Years (2 Life Cycles)	8.5%	\$57,675	\$43,924	\$49,994	v/s	\$57,675	\$43,924	\$59,203	\$51,933	\$38,143	\$49,994	\$51,891	\$38,141	\$49,994	\$46,149	\$32,360	\$49,994	\$46,149	\$32,360	\$59,203
Kingston (South)	60 Years (2 Life Cycles)	8.5%	\$68,133	\$45,161	\$53,438	v/s	\$68,133	\$45,161	\$63,274	\$62,149	\$39,008	\$53,438	\$62,350	\$39,378	\$53,438	\$56,365	\$33,224	\$53,438	\$56,365	\$33,224	\$63,274
Kitchener-Waterloo (South)	60 Years (2 Life Cycles)	8.5%	\$67,786	\$44,758	\$50,842	v/s	\$67,786	\$44,758	\$60,631	\$61,906	\$38,726	\$50,842	\$62,003	\$38,974	\$50,842	\$56,122	\$32,942	\$50,842	\$56,122	\$32,942	\$60,631
London (South)	60 Years (2 Life Cycles)	8.5%	\$57,991	\$44,229	\$48,339	v/s	\$57,991	\$44,229	\$57,775	\$52,154	\$38,356	\$48,339	\$52,207	\$38,445	\$48,339	\$46,370	\$32,572	\$48,339	\$46,370	\$32,572	\$57,775
Mt. Forest (South)	60 Years (2 Life Cycles)	8.5%	\$58,898	\$45,153	\$50,807	v/s	\$58,898	\$45,153	\$61,270	\$52,788	\$39,002	\$50,807	\$53,115	\$39,370	\$50,807	\$47,004	\$33,219	\$50,807	\$47,004	\$33,219	\$61,270
Niagara Falls (South)	60 Years (2 Life Cycles)	8.5%	\$56,849	\$43,089	\$47,758	v/s	\$56,849	\$43,089	\$56,291	\$51,356	\$37,559	\$47,758	\$51,065	\$37,305	\$47,758	\$45,572	\$31,776	\$47,758	\$45,572	\$31,776	\$56,291
Sarnia (South)	60 Years (2 Life Cycles)	8.5%	\$56,525	\$42,753	\$49,189	v/s	\$56,525	\$42,753	\$57,849	\$51,130	\$37,325	\$49,189	\$50,742	\$36,970	\$49,189	\$45,346	\$31,541	\$49,189	\$45,346	\$31,541	\$57,849
Simcoe (South)	60 Years (2 Life Cycles)	8.5%	\$57,338	\$43,589	\$49,356	v/s	\$57,338	\$43,589	\$58,330	\$51,697	\$37,909	\$49,356	\$51,554	\$37,805	\$49,356	\$45,914	\$32,125	\$49,356	\$45,914	\$32,125	\$58,330
St. Catharines (South)	60 Years (2 Life Cycles)	8.5%	\$56,076	\$42,317	\$48,900	v/s	\$56,076	\$42,317	\$57,206	\$50,815	\$37,020	\$48,900	\$50,292	\$36,534	\$48,900	\$45,032	\$31,236	\$48,900	\$45,032	\$31,236	\$57,206
Toronto (South)	60 Years (2 Life Cycles)	8.5%	\$58,005	\$44,267	\$49,458	v/s	\$58,005	\$44,267	\$58,946	\$52,163	\$38,383	\$49,458	\$52,221	\$38,484	\$49,458	\$46,380	\$32,599	\$49,458	\$46,380	\$32,599	\$58,946
Trenton (South)	60 Years (2 Life Cycles)	8.5%	\$58,278	\$44,510	\$52,995	v/s	\$58,278	\$44,510	\$62,547	\$52,354	\$38,552	\$52,995	\$52,494	\$38,726	\$52,995	\$46,571	\$32,769	\$52,995	\$46,571	\$32,769	\$62,547
Warton (South)	60 Years (2 Life Cycles)	8.5%	\$68,304	\$45,299	\$51,801	v/s	\$68,304	\$45,299	\$61,968	\$62,268	\$39,104	\$51,801	\$62,520	\$39,515	\$51,801	\$56,484	\$33,320	\$51,801	\$56,484	\$33,320	\$61,968
Windsor (South)	60 Years (2 Life Cycles)	8.5%	\$56,659	\$42,906	\$46,919	v/s	\$56,659	\$42,906	\$55,368	\$51,223	\$37,432	\$46,919	\$50,875	\$37,123	\$46,919	\$45,439	\$31,648	\$46,919	\$45,439	\$31,648	\$55,368
Barrie (Distinct)	60 Years (2 Life Cycles)	8.5%	\$68,019	\$50,868	\$49,037	v/s	\$68,019	\$50,868	\$58,761	\$62,069	\$44,857	\$49,037	\$62,235	\$45,084	\$49,037	\$56,285	\$39,074	\$49,037	\$56,285	\$39,074	\$58,761
Muskoka (Distinct)	60 Years (2 Life Cycles)	8.5%	\$68,893	\$51,746	\$50,797	v/s	\$68,893	\$51,746	\$61,252	\$62,680	\$45,471	\$50,797	\$63,110	\$45,963	\$50,797	\$56,896	\$39,688	\$50,797	\$56,896	\$39,688	\$61,252
Ottawa (Distinct)	60 Years (2 Life Cycles)	8.5%	\$68,281	\$51,184	\$50,266	v/s	\$68,281	\$51,184	\$60,240	\$62,252	\$45,078	\$50,266	\$62,497	\$45,400	\$50,266	\$56,468	\$39,295	\$50,266	\$56,468	\$39,295	\$60,240
Peterborough (Distinct)	60 Years (2 Life Cycles)	8.5%	\$68,709	\$51,607	\$50,895	v/s	\$68,709	\$51,607	\$61,153	\$62,551	\$45,374	\$50,895	\$62,926	\$45,823	\$50,895	\$56,767	\$39,590	\$50,895	\$56,767	\$39,590	\$61,153
Kapuskasing (North)	60 Years (2 Life Cycles)	8.5%	\$73,521	\$56,403	\$59,762	v/s	\$73,521	\$56,403	\$72,799	\$65,914	\$48,726	\$59,762	\$67,737	\$50,619	\$59,762	\$60,130	\$42,942	\$59,762	\$60,130	\$42,942	\$72,799
Kenora (North)	60 Years (2 Life Cycles)	8.5%	\$72,538	\$55,406	\$56,241	v/s	\$72,538	\$55,406	\$68,417	\$65,227	\$48,029	\$56,241	\$66,755	\$49,623	\$56,241	\$59,443	\$42,246	\$56,241	\$59,443	\$42,246	\$68,417
North Bay (North)	60 Years (2 Life Cycles)	8.5%	\$69,070	\$52,006	\$50,396	v/s	\$69,070	\$52,006	\$60,929	\$62,803	\$45,653	\$50,396	\$63,286	\$46,222	\$50,396	\$57,019	\$39,869	\$50,396	\$57,019	\$39,869	\$60,929
Sault Ste. Marie (North)	60 Years (2 Life Cycles)	8.5%	\$59,854	\$46,138	\$49,974	v/s	\$59,854	\$46,138	\$60,721	\$53,456	\$39,690	\$49,974	\$54,070	\$40,355	\$49,974	\$47,672	\$33,907	\$49,974	\$47,672	\$33,907	\$60,721
Sudbury (North)	60 Years (2 Life Cycles)	8.5%	\$70,033	\$52,979	\$54,196	v/s	\$70,033	\$52,979	\$65,544	\$63,476	\$46,333	\$54,196	\$64,250	\$47,196	\$54,196	\$57,693	\$40,549	\$54,196	\$57,693	\$40,549	\$65,544
Timmins (North)	60 Years (2 Life Cycles)	8.5%	\$71,664	\$54,604	\$55,060	v/s	\$71,664	\$54,604	\$67,644	\$64,616	\$47,468	\$55,060	\$65,880	\$48,820	\$55,060	\$58,832	\$41,685	\$55,060	\$58,832	\$41,685	\$67,644
Thunder Bay (North)	60 Years (2 Life Cycles)	8.5%	\$71,834	\$54,743	\$53,415	v/s	\$71,834	\$54,743	\$65,416	\$64,735	\$47,566	\$53,415	\$66,051	\$48,960	\$53,415	\$58,951	\$41,782	\$53,415	\$58,951	\$41,782	\$65,416

Table 9g: Rankings of the Cities Based on present values for V.GSHP, H.GSHP (two life cycles) and Traditional HVAC Applications (five life cycles) at a discount rate of 8.5% for average construction scenario

			Total Present Value																		
			Main Scenario				v/s	Comparative Scenarios													
			Base Case Scenario			v/s	Carbon Taxes - (#1)			FIT - (#2)			Rebates - (#3)			(FIT+Rebates) - (#4)			(FIT+Rebates) + Carbon Taxes - (#5)		
City	Project Life Span	Discount Rate	V.GSHP	H.GSHP	Traditional	v/s	V.GSHP	H.GSHP	Traditional	V.GSHP	H.GSHP	Traditional	V.GSHP	H.GSHP	Traditional	V.GSHP	H.GSHP	Traditional	V.GSHP	H.GSHP	Traditional
Cambridge (South)	60 Years (2 Life Cycles)	8.5%	\$57,985	\$44,238	\$44,996	v/s	0%	0%	21%	-10%	-13%	0%	-10%	-13%	0%	-20%	-26%	0%	-20%	-26%	21%
Chatham (South)	60 Years (2 Life Cycles)	8.5%	\$56,638	\$42,879	\$46,879	v/s	0%	0%	18%	-10%	-13%	0%	-10%	-13%	0%	-20%	-26%	0%	-20%	-26%	18%
Guelph (South)	60 Years (2 Life Cycles)	8.5%	\$58,293	\$44,556	\$45,615	v/s	0%	0%	21%	-10%	-13%	0%	-10%	-13%	0%	-20%	-26%	0%	-20%	-26%	21%
Hamilton (South)	60 Years (2 Life Cycles)	8.5%	\$57,675	\$43,924	\$49,994	v/s	0%	0%	18%	-10%	-13%	0%	-10%	-13%	0%	-20%	-26%	0%	-20%	-26%	18%
Kingston (South)	60 Years (2 Life Cycles)	8.5%	\$68,133	\$45,161	\$53,438	v/s	0%	0%	18%	-9%	-14%	0%	-8%	-13%	0%	-17%	-26%	0%	-17%	-26%	18%
Kitchener-Waterloo (South)	60 Years (2 Life Cycles)	8.5%	\$67,786	\$44,758	\$50,842	v/s	0%	0%	19%	-9%	-13%	0%	-9%	-13%	0%	-17%	-26%	0%	-17%	-26%	19%
London (South)	60 Years (2 Life Cycles)	8.5%	\$57,991	\$44,229	\$48,339	v/s	0%	0%	20%	-10%	-13%	0%	-10%	-13%	0%	-20%	-26%	0%	-20%	-26%	20%
Mt. Forest (South)	60 Years (2 Life Cycles)	8.5%	\$58,898	\$45,153	\$50,807	v/s	0%	0%	21%	-10%	-14%	0%	-10%	-13%	0%	-20%	-26%	0%	-20%	-26%	21%
Niagara Falls (South)	60 Years (2 Life Cycles)	8.5%	\$56,849	\$43,089	\$47,758	v/s	0%	0%	18%	-10%	-13%	0%	-10%	-13%	0%	-20%	-26%	0%	-20%	-26%	18%
Sarnia (South)	60 Years (2 Life Cycles)	8.5%	\$56,525	\$42,753	\$49,189	v/s	0%	0%	18%	-10%	-13%	0%	-10%	-14%	0%	-20%	-26%	0%	-20%	-26%	18%
Simcoe (South)	60 Years (2 Life Cycles)	8.5%	\$57,338	\$43,589	\$49,356	v/s	0%	0%	18%	-10%	-13%	0%	-10%	-13%	0%	-20%	-26%	0%	-20%	-26%	18%
St. Catharines (South)	60 Years (2 Life Cycles)	8.5%	\$56,076	\$42,317	\$48,900	v/s	0%	0%	17%	-9%	-13%	0%	-10%	-14%	0%	-20%	-26%	0%	-20%	-26%	17%
Toronto (South)	60 Years (2 Life Cycles)	8.5%	\$58,005	\$44,267	\$49,458	v/s	0%	0%	19%	-10%	-13%	0%	-10%	-13%	0%	-20%	-26%	0%	-20%	-26%	19%
Trenton (South)	60 Years (2 Life Cycles)	8.5%	\$58,278	\$44,510	\$52,995	v/s	0%	0%	18%	-10%	-13%	0%	-10%	-13%	0%	-20%	-26%	0%	-20%	-26%	18%
Warton (South)	60 Years (2 Life Cycles)	8.5%	\$68,304	\$45,299	\$51,801	v/s	0%	0%	20%	-9%	-14%	0%	-8%	-13%	0%	-17%	-26%	0%	-17%	-26%	20%
Windsor (South)	60 Years (2 Life Cycles)	8.5%	\$56,659	\$42,906	\$46,919	v/s	0%	0%	18%	-10%	-13%	0%	-10%	-13%	0%	-20%	-26%	0%	-20%	-26%	18%
Barrie (Distinct)	60 Years (2 Life Cycles)	8.5%	\$68,019	\$50,868	\$49,037	v/s	0%	0%	20%	-9%	-12%	0%	-9%	-11%	0%	-17%	-23%	0%	-17%	-23%	20%
Muskoka (Distinct)	60 Years (2 Life Cycles)	8.5%	\$68,893	\$51,746	\$50,797	v/s	0%	0%	21%	-9%	-12%	0%	-8%	-11%	0%	-17%	-23%	0%	-17%	-23%	21%
Ottawa (Distinct)	60 Years (2 Life Cycles)	8.5%	\$68,281	\$51,184	\$50,266	v/s	0%	0%	20%	-9%	-12%	0%	-8%	-11%	0%	-17%	-23%	0%	-17%	-23%	20%
Peterborough (Distinct)	60 Years (2 Life Cycles)	8.5%	\$68,709	\$51,607	\$50,895	v/s	0%	0%	20%	-9%	-12%	0%	-8%	-11%	0%	-17%	-23%	0%	-17%	-23%	20%
Kapuskasing (North)	60 Years (2 Life Cycles)	8.5%	\$73,521	\$56,403	\$59,762	v/s	0%	0%	22%	-10%	-14%	0%	-8%	-10%	0%	-18%	-24%	0%	-18%	-24%	22%
Kenora (North)	60 Years (2 Life Cycles)	8.5%	\$72,538	\$55,406	\$56,241	v/s	0%	0%	22%	-10%	-13%	0%	-8%	-10%	0%	-18%	-24%	0%	-18%	-24%	22%
North Bay (North)	60 Years (2 Life Cycles)	8.5%	\$69,070	\$52,006	\$50,396	v/s	0%	0%	21%	-9%	-12%	0%	-8%	-11%	0%	-17%	-23%	0%	-17%	-23%	21%
Sault Ste. Marie (North)	60 Years (2 Life Cycles)	8.5%	\$59,854	\$46,138	\$49,974	v/s	0%	0%	22%	-11%	-14%	0%	-10%	-13%	0%	-20%	-27%	0%	-20%	-27%	22%
Sudbury (North)	60 Years (2 Life Cycles)	8.5%	\$70,033	\$52,979	\$54,196	v/s	0%	0%	21%	-9%	-13%	0%	-8%	-11%	0%	-18%	-23%	0%	-18%	-23%	21%
Timmins (North)	60 Years (2 Life Cycles)	8.5%	\$71,664	\$54,604	\$55,060	v/s	0%	0%	23%	-10%	-13%	0%	-8%	-11%	0%	-18%	-24%	0%	-18%	-24%	23%
Thunder Bay (North)	60 Years (2 Life Cycles)	8.5%	\$71,834	\$54,743	\$53,415	v/s	0%	0%	22%	-10%	-13%	0%	-8%	-11%	0%	-18%	-24%	0%	-18%	-24%	22%

Table 9h: % change in present values for comparative scenarios in regards to the main scenario for V.GSHP, H.GSHP (two life cycles) and Traditional HVAC Applications (five life cycles) at a discount rate of 8.5% for average construction scenario

		Total Present Value																			
		Main Scenario					v/s	Comparative Scenarios													
		Base Case Scenario			v/s	Carbon Taxes - (€1)			FIT - (€2)			Rebates - (€3)			(FIT+Rebates) - (€4)			(FIT+Rebates) + Carbon Taxes - (€5)			
City	Project Life Span	Discount Rate	V.GSHP	H.GSHP	Traditional	v/s	V.GSHP	H.GSHP	Traditional	V.GSHP	H.GSHP	Traditional	V.GSHP	H.GSHP	Traditional	V.GSHP	H.GSHP	Traditional	V.GSHP	H.GSHP	Traditional
Cambridge (South)	60 Years (2 Life Cycles)	10%	\$53,065	\$39,933	\$38,721	v/s	\$53,065	\$39,933	\$45,811	\$48,084	\$34,917	\$38,721	\$47,546	\$34,414	\$38,721	\$42,565	\$29,398	\$38,721	\$42,565	\$29,398	\$45,811
Chatham (South)	60 Years (2 Life Cycles)	10%	\$51,923	\$38,781	\$40,372	v/s	\$51,923	\$38,781	\$46,683	\$47,289	\$34,115	\$40,372	\$46,404	\$33,262	\$40,372	\$41,770	\$28,596	\$40,372	\$41,770	\$28,596	\$46,683
Guelph (South)	60 Years (2 Life Cycles)	10%	\$53,326	\$40,202	\$39,242	v/s	\$53,326	\$40,202	\$46,560	\$48,266	\$35,105	\$39,242	\$47,807	\$34,683	\$39,242	\$42,747	\$29,586	\$39,242	\$42,747	\$29,586	\$46,560
Hamilton (South)	60 Years (2 Life Cycles)	10%	\$52,802	\$39,666	\$43,050	v/s	\$52,802	\$39,666	\$49,947	\$47,901	\$34,732	\$43,050	\$47,283	\$34,147	\$43,050	\$42,382	\$29,213	\$43,050	\$42,382	\$29,213	\$49,947
Kingston (South)	60 Years (2 Life Cycles)	10%	\$62,647	\$40,715	\$46,054	v/s	\$62,647	\$40,715	\$53,420	\$57,538	\$35,462	\$46,054	\$57,128	\$35,195	\$46,054	\$52,019	\$29,943	\$46,054	\$52,019	\$29,943	\$53,420
Kitchener-Waterloo (South)	60 Years (2 Life Cycles)	10%	\$62,353	\$40,373	\$43,763	v/s	\$62,353	\$40,373	\$51,094	\$57,334	\$35,224	\$43,763	\$56,834	\$34,854	\$43,763	\$51,815	\$29,705	\$43,763	\$51,815	\$29,705	\$51,094
London (South)	60 Years (2 Life Cycles)	10%	\$53,070	\$39,924	\$41,600	v/s	\$53,070	\$39,924	\$48,666	\$48,087	\$34,911	\$41,600	\$47,551	\$34,405	\$41,600	\$42,568	\$29,392	\$41,600	\$42,568	\$29,392	\$48,666
Mt. Forest (South)	60 Years (2 Life Cycles)	10%	\$53,839	\$40,708	\$43,727	v/s	\$53,839	\$40,708	\$51,563	\$48,623	\$35,457	\$43,727	\$48,320	\$35,189	\$43,727	\$43,104	\$29,938	\$43,727	\$43,104	\$29,938	\$51,563
Niagara Falls (South)	60 Years (2 Life Cycles)	10%	\$52,102	\$38,959	\$41,117	v/s	\$52,102	\$38,959	\$47,507	\$47,413	\$34,239	\$41,117	\$46,583	\$33,439	\$41,117	\$41,894	\$28,720	\$41,117	\$41,894	\$28,720	\$47,507
Sarnia (South)	60 Years (2 Life Cycles)	10%	\$51,828	\$38,674	\$42,374	v/s	\$51,828	\$38,674	\$48,859	\$47,222	\$34,041	\$42,374	\$46,309	\$33,155	\$42,374	\$41,703	\$28,522	\$42,374	\$41,703	\$28,522	\$48,859
Simcoe (South)	60 Years (2 Life Cycles)	10%	\$52,516	\$39,382	\$42,512	v/s	\$52,516	\$39,382	\$49,233	\$47,702	\$34,534	\$42,512	\$46,997	\$33,863	\$42,512	\$42,183	\$29,015	\$42,512	\$42,183	\$29,015	\$49,233
St. Catharines (South)	60 Years (2 Life Cycles)	10%	\$51,447	\$38,305	\$42,132	v/s	\$51,447	\$38,305	\$48,352	\$46,957	\$33,783	\$42,132	\$45,928	\$32,786	\$42,132	\$41,438	\$28,264	\$42,132	\$41,438	\$28,264	\$48,352
Toronto (South)	60 Years (2 Life Cycles)	10%	\$53,081	\$39,957	\$42,594	v/s	\$53,081	\$39,957	\$49,699	\$48,095	\$34,934	\$42,594	\$47,562	\$34,438	\$42,594	\$42,576	\$29,415	\$42,594	\$42,576	\$29,415	\$49,699
Trenton (South)	60 Years (2 Life Cycles)	10%	\$53,313	\$40,163	\$45,681	v/s	\$53,313	\$40,163	\$52,835	\$48,257	\$35,077	\$45,681	\$47,794	\$34,644	\$45,681	\$42,738	\$29,558	\$45,681	\$42,738	\$29,558	\$52,835
Warton (South)	60 Years (2 Life Cycles)	10%	\$62,792	\$40,831	\$44,618	v/s	\$62,792	\$40,831	\$52,232	\$57,639	\$35,543	\$44,618	\$57,273	\$35,312	\$44,618	\$52,120	\$30,024	\$44,618	\$52,120	\$30,024	\$52,232
Windsor (South)	60 Years (2 Life Cycles)	10%	\$51,941	\$38,804	\$40,406	v/s	\$51,941	\$38,804	\$46,734	\$47,301	\$34,131	\$40,406	\$46,422	\$33,285	\$40,406	\$41,782	\$28,612	\$40,406	\$41,782	\$28,612	\$46,734
Barrie (Distinct)	60 Years (2 Life Cycles)	10%	\$62,550	\$46,162	\$42,234	v/s	\$62,550	\$46,162	\$49,517	\$57,471	\$41,032	\$42,234	\$57,031	\$40,643	\$42,234	\$51,952	\$35,513	\$42,234	\$51,952	\$35,513	\$49,517
Muskoka (Distinct)	60 Years (2 Life Cycles)	10%	\$63,291	\$46,906	\$43,718	v/s	\$63,291	\$46,906	\$51,548	\$57,987	\$41,550	\$43,718	\$57,772	\$41,387	\$43,718	\$52,468	\$36,031	\$43,718	\$52,468	\$36,031	\$51,548
Ottawa (Distinct)	60 Years (2 Life Cycles)	10%	\$62,772	\$46,430	\$43,273	v/s	\$62,772	\$46,430	\$50,743	\$57,625	\$41,218	\$43,273	\$57,253	\$40,911	\$43,273	\$52,106	\$35,699	\$43,273	\$52,106	\$35,699	\$50,743
Peterborough (Distinct)	60 Years (2 Life Cycles)	10%	\$63,135	\$46,788	\$43,804	v/s	\$63,135	\$46,788	\$51,486	\$57,878	\$41,468	\$43,804	\$57,616	\$41,269	\$43,804	\$52,359	\$35,949	\$43,804	\$52,359	\$35,949	\$51,486
Kapuskasing (North)	60 Years (2 Life Cycles)	10%	\$67,212	\$50,852	\$51,381	v/s	\$67,212	\$50,852	\$61,144	\$60,718	\$44,299	\$51,381	\$61,693	\$45,333	\$51,381	\$55,199	\$38,780	\$51,381	\$55,199	\$38,780	\$61,144
Kenora (North)	60 Years (2 Life Cycles)	10%	\$66,379	\$50,008	\$48,360	v/s	\$66,379	\$50,008	\$57,478	\$60,138	\$43,710	\$48,360	\$60,860	\$44,489	\$48,360	\$54,619	\$38,191	\$48,360	\$54,619	\$38,191	\$57,478
North Bay (North)	60 Years (2 Life Cycles)	10%	\$63,441	\$47,127	\$43,378	v/s	\$63,441	\$47,127	\$51,266	\$58,091	\$41,703	\$43,378	\$57,921	\$41,608	\$43,378	\$52,572	\$36,184	\$43,378	\$52,572	\$36,184	\$51,266
Sault Ste. Marie (North)	60 Years (2 Life Cycles)	10%	\$54,648	\$41,542	\$42,972	v/s	\$54,648	\$41,542	\$51,020	\$49,187	\$36,039	\$42,972	\$49,129	\$36,023	\$42,972	\$43,668	\$30,520	\$42,972	\$43,668	\$30,520	\$51,020
Sudbury (North)	60 Years (2 Life Cycles)	10%	\$64,257	\$47,951	\$46,635	v/s	\$64,257	\$47,951	\$55,134	\$58,660	\$42,278	\$46,635	\$58,738	\$42,432	\$46,635	\$53,141	\$36,759	\$46,635	\$53,141	\$36,759	\$55,134
Timmins (North)	60 Years (2 Life Cycles)	10%	\$65,638	\$49,328	\$47,310	v/s	\$65,638	\$49,328	\$56,734	\$59,622	\$43,237	\$47,310	\$60,119	\$43,809	\$47,310	\$54,103	\$37,718	\$47,310	\$54,103	\$37,718	\$56,734
Thunder Bay (North)	60 Years (2 Life Cycles)	10%	\$65,783	\$49,446	\$45,921	v/s	\$65,783	\$49,446	\$54,909	\$59,723	\$43,319	\$45,921	\$60,264	\$43,927	\$45,921	\$54,204	\$37,800	\$45,921	\$54,204	\$37,800	\$54,909

Table 9i: Rankings of the Cities Based on present values for V.GSHP, H.GSHP (two life cycles) and Traditional HVAC Applications (five life cycles) at a discount rate of 10% for average construction scenario

		Total Present Value																				
		Main Scenario					v/s	Comparative Scenarios														
		Base Case Scenario			v/s	Carbon Taxes - (#1)			FIT - (#2)			Rebates - (#3)			(FIT+Rebates) - (#4)			(FIT+Rebates) + Carbon Taxes - (#5)				
City	Project Life Span	Discount Rate	V.GSHP	H.GSHP	Traditional	v/s	V.GSHP	H.GSHP	Traditional	V.GSHP	H.GSHP	Traditional	V.GSHP	H.GSHP	Traditional	V.GSHP	H.GSHP	Traditional	V.GSHP	H.GSHP	Traditional	
Cambridge (South)	60 Years (2 Life Cycles)	10%	\$53,065	\$39,933	\$38,721	v/s	0%	0%	18%	-9%	-13%	0%	-10%	-14%	0%	-20%	-26%	0%	-20%	-26%	18%	
Chatham (South)	60 Years (2 Life Cycles)	10%	\$51,923	\$38,781	\$40,372	v/s	0%	0%	16%	-9%	-12%	0%	-11%	-14%	0%	-20%	-26%	0%	-20%	-26%	16%	
Guelph (South)	60 Years (2 Life Cycles)	10%	\$53,326	\$40,202	\$39,242	v/s	0%	0%	19%	-9%	-13%	0%	-10%	-14%	0%	-20%	-26%	0%	-20%	-26%	19%	
Hamilton (South)	60 Years (2 Life Cycles)	10%	\$52,802	\$39,666	\$43,050	v/s	0%	0%	16%	-9%	-12%	0%	-10%	-14%	0%	-20%	-26%	0%	-20%	-26%	16%	
Kingston (South)	60 Years (2 Life Cycles)	10%	\$62,647	\$40,715	\$46,054	v/s	0%	0%	16%	-8%	-13%	0%	-9%	-14%	0%	-17%	-26%	0%	-17%	-26%	16%	
Kitchener-Waterloo (South)	60 Years (2 Life Cycles)	10%	\$62,353	\$40,373	\$43,763	v/s	0%	0%	17%	-8%	-13%	0%	-9%	-14%	0%	-17%	-26%	0%	-17%	-26%	17%	
London (South)	60 Years (2 Life Cycles)	10%	\$53,070	\$39,924	\$41,600	v/s	0%	0%	17%	-9%	-13%	0%	-10%	-14%	0%	-20%	-26%	0%	-20%	-26%	17%	
Mt. Forest (South)	60 Years (2 Life Cycles)	10%	\$53,839	\$40,708	\$43,727	v/s	0%	0%	18%	-10%	-13%	0%	-10%	-14%	0%	-20%	-26%	0%	-20%	-26%	18%	
Niagara Falls (South)	60 Years (2 Life Cycles)	10%	\$52,102	\$38,959	\$41,117	v/s	0%	0%	16%	-9%	-12%	0%	-11%	-14%	0%	-20%	-26%	0%	-20%	-26%	16%	
Sarnia (South)	60 Years (2 Life Cycles)	10%	\$51,828	\$38,674	\$42,374	v/s	0%	0%	15%	-9%	-12%	0%	-11%	-14%	0%	-20%	-26%	0%	-20%	-26%	15%	
Simcoe (South)	60 Years (2 Life Cycles)	10%	\$52,516	\$39,382	\$42,512	v/s	0%	0%	16%	-9%	-12%	0%	-11%	-14%	0%	-20%	-26%	0%	-20%	-26%	16%	
St. Catharines (South)	60 Years (2 Life Cycles)	10%	\$51,447	\$38,305	\$42,132	v/s	0%	0%	15%	-9%	-12%	0%	-11%	-14%	0%	-19%	-26%	0%	-19%	-26%	15%	
Toronto (South)	60 Years (2 Life Cycles)	10%	\$53,081	\$39,957	\$42,594	v/s	0%	0%	17%	-9%	-13%	0%	-10%	-14%	0%	-20%	-26%	0%	-20%	-26%	17%	
Trenton (South)	60 Years (2 Life Cycles)	10%	\$53,313	\$40,163	\$45,681	v/s	0%	0%	16%	-9%	-13%	0%	-10%	-14%	0%	-20%	-26%	0%	-20%	-26%	16%	
Warton (South)	60 Years (2 Life Cycles)	10%	\$62,792	\$40,831	\$44,618	v/s	0%	0%	17%	-8%	-13%	0%	-9%	-14%	0%	-17%	-26%	0%	-17%	-26%	17%	
Windsor (South)	60 Years (2 Life Cycles)	10%	\$51,941	\$38,804	\$40,406	v/s	0%	0%	16%	-9%	-12%	0%	-11%	-14%	0%	-20%	-26%	0%	-20%	-26%	16%	
Barrie (Distinct)	60 Years (2 Life Cycles)	10%	\$62,550	\$46,162	\$42,234	v/s	0%	0%	17%	-8%	-11%	0%	-9%	-12%	0%	-17%	-23%	0%	-17%	-23%	17%	
Muskoka (Distinct)	60 Years (2 Life Cycles)	10%	\$63,291	\$46,906	\$43,718	v/s	0%	0%	18%	-8%	-11%	0%	-9%	-12%	0%	-17%	-23%	0%	-17%	-23%	18%	
Ottawa (Distinct)	60 Years (2 Life Cycles)	10%	\$62,772	\$46,430	\$43,273	v/s	0%	0%	17%	-8%	-11%	0%	-9%	-12%	0%	-17%	-23%	0%	-17%	-23%	17%	
Peterborough (Distinct)	60 Years (2 Life Cycles)	10%	\$63,135	\$46,788	\$43,804	v/s	0%	0%	18%	-8%	-11%	0%	-9%	-12%	0%	-17%	-23%	0%	-17%	-23%	18%	
Kapuskasing (North)	60 Years (2 Life Cycles)	10%	\$67,212	\$50,852	\$51,381	v/s	0%	0%	19%	-10%	-13%	0%	-8%	-11%	0%	-18%	-24%	0%	-18%	-24%	19%	
Kenora (North)	60 Years (2 Life Cycles)	10%	\$66,379	\$50,008	\$48,360	v/s	0%	0%	19%	-9%	-13%	0%	-8%	-11%	0%	-18%	-24%	0%	-18%	-24%	19%	
North Bay (North)	60 Years (2 Life Cycles)	10%	\$63,441	\$47,127	\$43,378	v/s	0%	0%	18%	-8%	-12%	0%	-9%	-12%	0%	-17%	-23%	0%	-17%	-23%	18%	
Sault Ste. Marie (North)	60 Years (2 Life Cycles)	10%	\$54,648	\$41,542	\$42,972	v/s	0%	0%	19%	-10%	-13%	0%	-10%	-13%	0%	-20%	-27%	0%	-20%	-27%	19%	
Sudbury (North)	60 Years (2 Life Cycles)	10%	\$64,257	\$47,951	\$46,635	v/s	0%	0%	18%	-9%	-12%	0%	-9%	-12%	0%	-17%	-23%	0%	-17%	-23%	18%	
Timmins (North)	60 Years (2 Life Cycles)	10%	\$65,638	\$49,328	\$47,310	v/s	0%	0%	20%	-9%	-12%	0%	-8%	-11%	0%	-18%	-24%	0%	-18%	-24%	20%	
Thunder Bay (North)	60 Years (2 Life Cycles)	10%	\$65,783	\$49,446	\$45,921	v/s	0%	0%	20%	-9%	-12%	0%	-8%	-11%	0%	-18%	-24%	0%	-18%	-24%	20%	

Table 9j: % change in present values for comparative scenarios in regards to the main scenario for V.GSHP, H.GSHP (two life cycles) and Traditional HVAC Applications (five life cycles) at a discount rate of 10% for average construction scenario

			Total Present Value																		
			Main Scenario				v/s	Comparative Scenarios													
			Base Case Scenario			v/s	Carbon Taxes - (€1)			FIT - (€2)			Rebates - (€3)			(FIT+Rebates) - (€4)			(FIT+Rebates) + Carbon Taxes - (€5)		
City	Project Life Span	Discount Rate	V.GSHP	H.GSHP	Traditional	v/s	V.GSHP	H.GSHP	Traditional	V.GSHP	H.GSHP	Traditional	V.GSHP	H.GSHP	Traditional	V.GSHP	H.GSHP	Traditional	V.GSHP	H.GSHP	Traditional
Cambridge (South)	60 Years (2 Life Cycles)	12%	\$48,622	\$35,990	\$32,921	v/s	\$48,622	\$35,990	\$38,000	\$44,462	\$31,802	\$32,921	\$43,320	\$30,688	\$32,921	\$39,160	\$26,499	\$32,921	\$39,160	\$26,499	\$38,000
Chatham (South)	60 Years (2 Life Cycles)	12%	\$47,676	\$35,036	\$34,358	v/s	\$47,676	\$35,036	\$38,879	\$43,805	\$31,139	\$34,358	\$42,374	\$29,734	\$34,358	\$38,503	\$25,837	\$34,358	\$38,503	\$25,837	\$38,879
Guelph (South)	60 Years (2 Life Cycles)	12%	\$48,838	\$36,214	\$33,350	v/s	\$48,838	\$36,214	\$38,593	\$44,612	\$31,957	\$33,350	\$43,536	\$30,911	\$33,350	\$39,310	\$26,654	\$33,350	\$39,310	\$26,654	\$38,593
Hamilton (South)	60 Years (2 Life Cycles)	12%	\$48,404	\$35,770	\$36,631	v/s	\$48,404	\$35,770	\$41,572	\$44,311	\$31,649	\$36,631	\$43,102	\$30,468	\$36,631	\$39,009	\$26,346	\$36,631	\$39,009	\$26,346	\$41,572
Kingston (South)	60 Years (2 Life Cycles)	12%	\$57,724	\$36,638	\$39,235	v/s	\$57,724	\$36,638	\$44,512	\$53,458	\$32,252	\$39,235	\$52,422	\$31,336	\$39,235	\$48,156	\$26,949	\$39,235	\$48,156	\$26,949	\$44,512
Kitchener-Waterloo (South)	60 Years (2 Life Cycles)	12%	\$57,481	\$36,355	\$37,217	v/s	\$57,481	\$36,355	\$42,469	\$53,289	\$32,055	\$37,217	\$52,179	\$31,053	\$37,217	\$47,987	\$26,753	\$37,217	\$47,987	\$26,753	\$42,469
London (South)	60 Years (2 Life Cycles)	12%	\$48,626	\$35,984	\$35,367	v/s	\$48,626	\$35,984	\$40,429	\$44,465	\$31,797	\$35,367	\$43,324	\$30,681	\$35,367	\$39,163	\$26,495	\$35,367	\$39,163	\$26,495	\$40,429
Mt. Forest (South)	60 Years (2 Life Cycles)	12%	\$49,263	\$36,633	\$37,181	v/s	\$49,263	\$36,633	\$42,795	\$44,907	\$32,248	\$37,181	\$43,961	\$31,331	\$37,181	\$39,605	\$26,946	\$37,181	\$39,605	\$26,946	\$42,795
Niagara Falls (South)	60 Years (2 Life Cycles)	12%	\$47,824	\$35,183	\$34,974	v/s	\$47,824	\$35,183	\$39,552	\$43,908	\$31,241	\$34,974	\$42,522	\$29,881	\$34,974	\$38,606	\$25,939	\$34,974	\$38,606	\$25,939	\$39,552
Sarnia (South)	60 Years (2 Life Cycles)	12%	\$47,597	\$34,948	\$36,075	v/s	\$47,597	\$34,948	\$40,721	\$43,750	\$31,078	\$36,075	\$42,295	\$29,645	\$36,075	\$38,448	\$25,776	\$36,075	\$38,448	\$25,776	\$40,721
Simcoe (South)	60 Years (2 Life Cycles)	12%	\$48,167	\$35,534	\$36,186	v/s	\$48,167	\$35,534	\$41,002	\$44,146	\$31,485	\$36,186	\$42,865	\$30,232	\$36,186	\$38,844	\$26,183	\$36,186	\$38,844	\$26,183	\$41,002
St. Catharines (South)	60 Years (2 Life Cycles)	12%	\$47,281	\$34,641	\$35,877	v/s	\$47,281	\$34,641	\$40,334	\$43,531	\$30,865	\$35,877	\$41,979	\$29,339	\$35,877	\$38,229	\$25,563	\$35,877	\$38,229	\$25,563	\$40,334
Toronto (South)	60 Years (2 Life Cycles)	12%	\$48,636	\$36,011	\$36,250	v/s	\$48,636	\$36,011	\$41,340	\$44,472	\$31,816	\$36,250	\$43,333	\$30,709	\$36,250	\$39,169	\$26,514	\$36,250	\$39,169	\$26,514	\$41,340
Trenton (South)	60 Years (2 Life Cycles)	12%	\$48,828	\$36,181	\$38,928	v/s	\$48,828	\$36,181	\$44,053	\$44,605	\$31,934	\$38,928	\$43,525	\$30,879	\$38,928	\$39,303	\$26,632	\$38,928	\$39,303	\$26,632	\$44,053
Warton (South)	60 Years (2 Life Cycles)	12%	\$57,844	\$36,735	\$37,982	v/s	\$57,844	\$36,735	\$43,437	\$53,541	\$32,319	\$37,982	\$52,542	\$31,433	\$37,982	\$48,239	\$27,016	\$37,982	\$48,239	\$27,016	\$43,437
Windsor (South)	60 Years (2 Life Cycles)	12%	\$47,691	\$35,055	\$34,386	v/s	\$47,691	\$35,055	\$38,919	\$43,816	\$31,153	\$34,386	\$42,389	\$29,753	\$34,386	\$38,513	\$25,850	\$34,386	\$38,513	\$25,850	\$38,919
Barrie (Distinct)	60 Years (2 Life Cycles)	12%	\$57,644	\$41,878	\$35,950	v/s	\$57,644	\$41,878	\$41,168	\$53,402	\$37,593	\$35,950	\$52,342	\$36,575	\$35,950	\$48,100	\$32,290	\$35,950	\$48,100	\$32,290	\$41,168
Muskoka (Distinct)	60 Years (2 Life Cycles)	12%	\$58,258	\$42,494	\$37,174	v/s	\$58,258	\$42,494	\$42,784	\$53,828	\$38,021	\$37,174	\$52,956	\$37,192	\$37,174	\$48,526	\$32,719	\$37,174	\$48,526	\$32,719	\$42,784
Ottawa (Distinct)	60 Years (2 Life Cycles)	12%	\$57,828	\$42,099	\$36,809	v/s	\$57,828	\$42,099	\$42,161	\$53,530	\$37,747	\$36,809	\$52,526	\$36,797	\$36,809	\$48,228	\$32,444	\$36,809	\$48,228	\$32,444	\$42,161
Peterborough (Distinct)	60 Years (2 Life Cycles)	12%	\$58,129	\$42,396	\$37,246	v/s	\$58,129	\$42,396	\$42,750	\$53,739	\$37,953	\$37,246	\$52,827	\$37,094	\$37,246	\$48,436	\$32,650	\$37,246	\$48,436	\$32,650	\$42,750
Kapuskasing (North)	60 Years (2 Life Cycles)	12%	\$61,508	\$45,764	\$43,622	v/s	\$61,508	\$45,764	\$50,617	\$56,084	\$40,291	\$43,622	\$56,205	\$40,462	\$43,622	\$50,782	\$34,989	\$43,622	\$50,782	\$34,989	\$50,617
Kenora (North)	60 Years (2 Life Cycles)	12%	\$60,817	\$45,064	\$41,066	v/s	\$60,817	\$45,064	\$47,599	\$55,605	\$39,805	\$41,066	\$55,515	\$39,762	\$41,066	\$50,303	\$34,503	\$41,066	\$50,303	\$34,503	\$47,599
North Bay (North)	60 Years (2 Life Cycles)	12%	\$58,382	\$42,677	\$36,891	v/s	\$58,382	\$42,677	\$42,542	\$53,914	\$38,147	\$36,891	\$53,080	\$37,374	\$36,891	\$48,612	\$32,845	\$36,891	\$48,612	\$32,845	\$42,542
Sault Ste. Marie (North)	60 Years (2 Life Cycles)	12%	\$49,934	\$37,325	\$36,493	v/s	\$49,934	\$37,325	\$42,259	\$45,373	\$32,728	\$36,493	\$44,632	\$32,022	\$36,493	\$40,071	\$27,426	\$36,493	\$40,071	\$27,426	\$42,259
Sudbury (North)	60 Years (2 Life Cycles)	12%	\$59,059	\$43,360	\$39,644	v/s	\$59,059	\$43,360	\$45,732	\$54,384	\$38,622	\$39,644	\$53,756	\$38,058	\$39,644	\$49,082	\$33,320	\$39,644	\$49,082	\$33,320	\$45,732
Timmins (North)	60 Years (2 Life Cycles)	12%	\$60,203	\$44,501	\$40,132	v/s	\$60,203	\$44,501	\$46,884	\$55,179	\$39,414	\$40,132	\$54,901	\$39,198	\$40,132	\$49,877	\$34,112	\$40,132	\$49,877	\$34,112	\$46,884
Thunder Bay (North)	60 Years (2 Life Cycles)	12%	\$60,323	\$44,599	\$38,986	v/s	\$60,323	\$44,599	\$45,425	\$55,262	\$39,482	\$38,986	\$55,021	\$39,296	\$38,986	\$49,960	\$34,180	\$38,986	\$49,960	\$34,180	\$45,425

Table 9k: Rankings of the Cities Based on present values for V.GSHP, H.GSHP (two life cycles) and Traditional HVAC Applications (five life cycles) at a discount rate of 12% for average construction scenario

			Total Present Value																			
			Main Scenario				v/s	Comparative Scenarios														
			Base Case Scenario			v/s	Carbon Taxes - (#1)			FIT - (#2)			Rebates - (#3)			(FIT+Rebates) - (#4)			(FIT+Rebates) + Carbon Taxes - (#5)			
City	Project Life Span	Discount Rate	V.GSHP	H.GSHP	Traditional	v/s	V.GSHP	H.GSHP	Traditional	V.GSHP	H.GSHP	Traditional	V.GSHP	H.GSHP	Traditional	V.GSHP	H.GSHP	Traditional	V.GSHP	H.GSHP	Traditional	
Cambridge (South)	60 Years (2 Life Cycles)	12%	\$48,622	\$35,990	\$32,921	v/s	0%	0%	15%	-9%	-12%	0%	-11%	-15%	0%	-19%	-26%	0%	-19%	-26%	15%	
Chatham (South)	60 Years (2 Life Cycles)	12%	\$47,676	\$35,036	\$34,358	v/s	0%	0%	13%	-8%	-11%	0%	-11%	-15%	0%	-19%	-26%	0%	-19%	-26%	13%	
Guelph (South)	60 Years (2 Life Cycles)	12%	\$48,838	\$36,214	\$33,350	v/s	0%	0%	16%	-9%	-12%	0%	-11%	-15%	0%	-20%	-26%	0%	-20%	-26%	16%	
Hamilton (South)	60 Years (2 Life Cycles)	12%	\$48,404	\$35,770	\$36,631	v/s	0%	0%	13%	-8%	-12%	0%	-11%	-15%	0%	-19%	-26%	0%	-19%	-26%	13%	
Kingston (South)	60 Years (2 Life Cycles)	12%	\$57,724	\$36,638	\$39,235	v/s	0%	0%	13%	-7%	-12%	0%	-9%	-14%	0%	-17%	-26%	0%	-17%	-26%	13%	
Kitchener-Waterloo (South)	60 Years (2 Life Cycles)	12%	\$57,481	\$36,355	\$37,217	v/s	0%	0%	14%	-7%	-12%	0%	-9%	-15%	0%	-17%	-26%	0%	-17%	-26%	14%	
London (South)	60 Years (2 Life Cycles)	12%	\$48,626	\$35,984	\$35,367	v/s	0%	0%	14%	-9%	-12%	0%	-11%	-15%	0%	-19%	-26%	0%	-19%	-26%	14%	
Mt. Forest (South)	60 Years (2 Life Cycles)	12%	\$49,263	\$36,633	\$37,181	v/s	0%	0%	15%	-9%	-12%	0%	-11%	-14%	0%	-20%	-26%	0%	-20%	-26%	15%	
Niagara Falls (South)	60 Years (2 Life Cycles)	12%	\$47,824	\$35,183	\$34,974	v/s	0%	0%	13%	-8%	-11%	0%	-11%	-15%	0%	-19%	-26%	0%	-19%	-26%	13%	
Sarnia (South)	60 Years (2 Life Cycles)	12%	\$47,597	\$34,948	\$36,075	v/s	0%	0%	13%	-8%	-11%	0%	-11%	-15%	0%	-19%	-26%	0%	-19%	-26%	13%	
Simcoe (South)	60 Years (2 Life Cycles)	12%	\$48,167	\$35,534	\$36,186	v/s	0%	0%	13%	-8%	-11%	0%	-11%	-15%	0%	-19%	-26%	0%	-19%	-26%	13%	
St. Catharines (South)	60 Years (2 Life Cycles)	12%	\$47,281	\$34,641	\$35,877	v/s	0%	0%	12%	-8%	-11%	0%	-11%	-15%	0%	-19%	-26%	0%	-19%	-26%	12%	
Toronto (South)	60 Years (2 Life Cycles)	12%	\$48,636	\$36,011	\$36,250	v/s	0%	0%	14%	-9%	-12%	0%	-11%	-15%	0%	-19%	-26%	0%	-19%	-26%	14%	
Trenton (South)	60 Years (2 Life Cycles)	12%	\$48,828	\$36,181	\$38,928	v/s	0%	0%	13%	-9%	-12%	0%	-11%	-15%	0%	-20%	-26%	0%	-20%	-26%	13%	
Warton (South)	60 Years (2 Life Cycles)	12%	\$57,844	\$36,735	\$37,982	v/s	0%	0%	14%	-7%	-12%	0%	-9%	-14%	0%	-17%	-26%	0%	-17%	-26%	14%	
Windsor (South)	60 Years (2 Life Cycles)	12%	\$47,691	\$35,055	\$34,386	v/s	0%	0%	13%	-8%	-11%	0%	-11%	-15%	0%	-19%	-26%	0%	-19%	-26%	13%	
Barrie (Distinct)	60 Years (2 Life Cycles)	12%	\$57,644	\$41,878	\$35,950	v/s	0%	0%	15%	-7%	-10%	0%	-9%	-13%	0%	-17%	-23%	0%	-17%	-23%	15%	
Muskoka (Distinct)	60 Years (2 Life Cycles)	12%	\$58,258	\$42,494	\$37,174	v/s	0%	0%	15%	-8%	-11%	0%	-9%	-12%	0%	-17%	-23%	0%	-17%	-23%	15%	
Ottawa (Distinct)	60 Years (2 Life Cycles)	12%	\$57,828	\$42,099	\$36,809	v/s	0%	0%	15%	-7%	-10%	0%	-9%	-13%	0%	-17%	-23%	0%	-17%	-23%	15%	
Peterborough (Distinct)	60 Years (2 Life Cycles)	12%	\$58,129	\$42,396	\$37,246	v/s	0%	0%	15%	-8%	-10%	0%	-9%	-13%	0%	-17%	-23%	0%	-17%	-23%	15%	
Kapuskasing (North)	60 Years (2 Life Cycles)	12%	\$61,508	\$45,764	\$43,622	v/s	0%	0%	16%	-9%	-12%	0%	-9%	-12%	0%	-17%	-24%	0%	-17%	-24%	16%	
Kenora (North)	60 Years (2 Life Cycles)	12%	\$60,817	\$45,064	\$41,066	v/s	0%	0%	16%	-9%	-12%	0%	-9%	-12%	0%	-17%	-23%	0%	-17%	-23%	16%	
North Bay (North)	60 Years (2 Life Cycles)	12%	\$58,382	\$42,677	\$36,891	v/s	0%	0%	15%	-8%	-11%	0%	-9%	-12%	0%	-17%	-23%	0%	-17%	-23%	15%	
Sault Ste. Marie (North)	60 Years (2 Life Cycles)	12%	\$49,934	\$37,325	\$36,493	v/s	0%	0%	16%	-9%	-12%	0%	-11%	-14%	0%	-20%	-27%	0%	-20%	-27%	16%	
Sudbury (North)	60 Years (2 Life Cycles)	12%	\$59,059	\$43,360	\$39,644	v/s	0%	0%	15%	-8%	-11%	0%	-9%	-12%	0%	-17%	-23%	0%	-17%	-23%	15%	
Timmins (North)	60 Years (2 Life Cycles)	12%	\$60,203	\$44,501	\$40,132	v/s	0%	0%	17%	-8%	-11%	0%	-9%	-12%	0%	-17%	-23%	0%	-17%	-23%	17%	
Thunder Bay (North)	60 Years (2 Life Cycles)	12%	\$60,323	\$44,599	\$38,986	v/s	0%	0%	17%	-8%	-11%	0%	-9%	-12%	0%	-17%	-23%	0%	-17%	-23%	17%	

Table 9I: % change in present values for comparative scenarios in regards to the main scenario for V.GSHP, H.GSHP (two life cycles) and Traditional HVAC Applications (five life cycles) at a discount rate of 12% for average construction scenario

			Total Present Value																		
			Main Scenario				v/s	Comparative Scenarios													
			Base Case Scenario			v/s	Carbon Taxes - (#1)			FIT - (#2)			Rebates - (#3)			(FIT+Rebates) - (#4)			(FIT+Rebates) + Carbon Taxes - (#5)		
City	Project Life Span	Discount Rate	V.GSHP	H.GSHP	Traditional	v/s	V.GSHP	H.GSHP	Traditional	V.GSHP	H.GSHP	Traditional	V.GSHP	H.GSHP	Traditional	V.GSHP	H.GSHP	Traditional	V.GSHP	H.GSHP	Traditional
Cambridge (South)	60 Years (3 Life Cycles)	5%	\$95,077	\$72,815	\$73,410	v/s	\$95,077	\$72,815	\$95,355	\$85,617	\$63,290	\$73,410	\$85,708	\$63,447	\$73,410	\$76,248	\$53,921	\$73,410	\$76,248	\$53,921	\$95,355
Chatham (South)	60 Years (3 Life Cycles)	5%	\$92,836	\$70,555	\$76,326	v/s	\$92,836	\$70,555	\$95,858	\$84,034	\$61,693	\$76,326	\$83,468	\$61,187	\$76,326	\$74,666	\$52,325	\$76,326	\$74,666	\$52,325	\$95,858
Guelph (South)	60 Years (3 Life Cycles)	5%	\$95,589	\$73,344	\$74,460	v/s	\$95,589	\$73,344	\$97,111	\$85,979	\$63,663	\$74,460	\$86,221	\$63,975	\$74,460	\$76,611	\$54,295	\$74,460	\$76,611	\$54,295	\$97,111
Hamilton (South)	60 Years (3 Life Cycles)	5%	\$94,561	\$72,293	\$81,417	v/s	\$94,561	\$72,293	\$102,765	\$85,253	\$62,921	\$81,417	\$85,193	\$62,924	\$81,417	\$75,884	\$53,553	\$81,417	\$75,884	\$53,553	\$102,765
Kingston (South)	60 Years (3 Life Cycles)	5%	\$111,616	\$74,350	\$86,900	v/s	\$111,616	\$74,350	\$109,702	\$101,914	\$64,374	\$86,900	\$102,248	\$64,981	\$86,900	\$92,545	\$55,005	\$86,900	\$92,545	\$55,005	\$109,702
Kitchener-Waterloo (South)	60 Years (3 Life Cycles)	5%	\$111,039	\$73,679	\$82,867	v/s	\$111,039	\$73,679	\$105,560	\$101,506	\$63,900	\$82,867	\$101,671	\$64,311	\$82,867	\$92,138	\$54,532	\$82,867	\$92,138	\$54,532	\$105,560
London (South)	60 Years (3 Life Cycles)	5%	\$95,086	\$72,799	\$78,824	v/s	\$95,086	\$72,799	\$100,697	\$85,624	\$63,278	\$78,824	\$85,718	\$63,431	\$78,824	\$76,255	\$53,910	\$78,824	\$76,255	\$53,910	\$100,697
Mt. Forest (South)	60 Years (3 Life Cycles)	5%	\$96,595	\$74,337	\$82,855	v/s	\$96,595	\$74,337	\$107,110	\$86,689	\$64,365	\$82,855	\$87,227	\$64,968	\$82,855	\$77,321	\$54,996	\$82,855	\$77,321	\$54,996	\$107,110
Niagara Falls (South)	60 Years (3 Life Cycles)	5%	\$93,188	\$70,903	\$77,796	v/s	\$93,188	\$70,903	\$97,576	\$84,282	\$61,939	\$77,796	\$83,819	\$61,535	\$77,796	\$74,914	\$52,571	\$77,796	\$74,914	\$52,571	\$97,576
Sarnia (South)	60 Years (3 Life Cycles)	5%	\$92,649	\$70,346	\$80,041	v/s	\$92,649	\$70,346	\$100,116	\$83,902	\$61,545	\$80,041	\$83,281	\$60,977	\$80,041	\$74,534	\$52,177	\$80,041	\$74,534	\$52,177	\$100,116
Simcoe (South)	60 Years (3 Life Cycles)	5%	\$94,000	\$71,735	\$80,339	v/s	\$94,000	\$71,735	\$101,145	\$84,856	\$62,527	\$80,339	\$84,632	\$62,367	\$80,339	\$75,488	\$53,159	\$80,339	\$75,488	\$53,159	\$101,145
St. Catharines (South)	60 Years (3 Life Cycles)	5%	\$91,901	\$69,620	\$79,535	v/s	\$91,901	\$69,620	\$98,790	\$83,374	\$61,033	\$79,535	\$82,533	\$60,252	\$79,535	\$74,005	\$51,665	\$79,535	\$74,005	\$51,665	\$98,790
Toronto (South)	60 Years (3 Life Cycles)	5%	\$95,109	\$72,863	\$80,545	v/s	\$95,109	\$72,863	\$102,539	\$85,640	\$63,324	\$80,545	\$85,741	\$63,495	\$80,545	\$76,271	\$53,956	\$80,545	\$76,271	\$53,956	\$102,539
Trenton (South)	60 Years (3 Life Cycles)	5%	\$95,564	\$73,266	\$86,144	v/s	\$95,564	\$73,266	\$108,288	\$85,961	\$63,609	\$86,144	\$86,195	\$63,898	\$86,144	\$76,592	\$54,240	\$86,144	\$76,592	\$54,240	\$108,288
Warton (South)	60 Years (3 Life Cycles)	5%	\$111,900	\$74,578	\$84,345	v/s	\$111,900	\$74,578	\$107,913	\$102,114	\$64,536	\$84,345	\$102,531	\$65,210	\$84,345	\$92,746	\$55,167	\$84,345	\$92,746	\$55,167	\$107,913
Windsor (South)	60 Years (3 Life Cycles)	5%	\$92,872	\$70,600	\$76,395	v/s	\$92,872	\$70,600	\$95,982	\$84,059	\$61,725	\$76,395	\$83,503	\$61,232	\$76,395	\$74,691	\$52,357	\$76,395	\$74,691	\$52,357	\$95,982
Barrie (Distinct)	60 Years (3 Life Cycles)	5%	\$111,426	\$83,653	\$79,861	v/s	\$111,426	\$83,653	\$102,404	\$101,779	\$73,909	\$79,861	\$102,057	\$74,284	\$79,861	\$92,411	\$64,540	\$79,861	\$92,411	\$64,540	\$102,404
Muskoka (Distinct)	60 Years (3 Life Cycles)	5%	\$112,880	\$85,113	\$82,837	v/s	\$112,880	\$85,113	\$107,075	\$102,806	\$74,940	\$82,837	\$103,511	\$75,745	\$82,837	\$93,438	\$65,572	\$82,837	\$93,438	\$65,572	\$107,075
Ottawa (Distinct)	60 Years (3 Life Cycles)	5%	\$111,861	\$84,178	\$81,922	v/s	\$111,861	\$84,178	\$105,043	\$102,087	\$74,280	\$81,922	\$102,493	\$74,810	\$81,922	\$92,718	\$64,912	\$81,922	\$92,718	\$64,912	\$105,043
Peterborough (Distinct)	60 Years (3 Life Cycles)	5%	\$112,573	\$84,881	\$82,988	v/s	\$112,573	\$84,881	\$106,767	\$102,590	\$74,776	\$82,988	\$103,205	\$75,512	\$82,988	\$93,222	\$65,408	\$82,988	\$93,222	\$65,408	\$106,767
Kapuskasing (North)	60 Years (3 Life Cycles)	5%	\$120,575	\$92,856	\$97,635	v/s	\$120,575	\$92,856	\$127,857	\$108,242	\$80,410	\$97,635	\$111,206	\$83,488	\$97,635	\$98,874	\$71,042	\$97,635	\$98,874	\$71,042	\$127,857
Kenora (North)	60 Years (3 Life Cycles)	5%	\$118,940	\$91,199	\$91,865	v/s	\$118,940	\$91,199	\$120,089	\$107,088	\$79,240	\$91,865	\$109,572	\$81,831	\$91,865	\$97,719	\$69,871	\$91,865	\$97,719	\$69,871	\$120,089
North Bay (North)	60 Years (3 Life Cycles)	5%	\$113,173	\$85,545	\$82,176	v/s	\$113,173	\$85,545	\$106,594	\$103,014	\$75,246	\$82,176	\$103,805	\$76,177	\$82,176	\$93,645	\$65,877	\$82,176	\$93,645	\$65,877	\$106,594
Sault Ste. Marie (North)	60 Years (3 Life Cycles)	5%	\$98,184	\$75,974	\$81,631	v/s	\$98,184	\$75,974	\$106,544	\$87,812	\$65,522	\$81,631	\$88,816	\$66,606	\$81,631	\$78,444	\$56,153	\$81,631	\$78,444	\$56,153	\$106,544
Sudbury (North)	60 Years (3 Life Cycles)	5%	\$114,775	\$87,163	\$88,408	v/s	\$114,775	\$87,163	\$114,714	\$104,145	\$76,389	\$88,408	\$105,407	\$77,795	\$88,408	\$94,777	\$67,020	\$88,408	\$94,777	\$67,020	\$114,714
Timmins (North)	60 Years (3 Life Cycles)	5%	\$117,486	\$89,865	\$90,072	v/s	\$117,486	\$89,865	\$119,244	\$106,061	\$78,297	\$90,072	\$108,118	\$80,496	\$90,072	\$96,692	\$68,929	\$90,072	\$96,692	\$68,929	\$119,244
Thunder Bay (North)	60 Years (3 Life Cycles)	5%	\$117,770	\$90,097	\$87,296	v/s	\$117,770	\$90,097	\$115,117	\$106,261	\$78,461	\$87,296	\$108,402	\$80,728	\$87,296	\$96,893	\$69,093	\$87,296	\$96,893	\$69,093	\$115,117

Table 10a: Rankings of the Cities Based on present values for V.GSHP, H.GSHP (three life cycles) and Traditional HVAC Applications (five life cycles) at a discount rate of 5% for average construction scenario

		Total Present Value																				
		Main Scenario					v/s	Comparative Scenarios														
		Base Case Scenario			v/s	Carbon Taxes - (#1)			FIT - (#2)			Rebates - (#3)			(FIT+Rebates) - (#4)			(FIT+Rebates) + Carbon Taxes - (#5)				
City	Project Life Span	Discount Rate	V.GSHP	H.GSHP	Traditional	v/s	V.GSHP	H.GSHP	Traditional	V.GSHP	H.GSHP	Traditional	V.GSHP	H.GSHP	Traditional	V.GSHP	H.GSHP	Traditional	V.GSHP	H.GSHP	Traditional	
Cambridge (South)	60 Years (3 Life Cycles)	5%	\$95,077	\$72,815	\$73,410	v/s	0%	0%	30%	-10%	-13%	0%	-10%	-13%	0%	-20%	-26%	0%	-20%	-26%	30%	
Chatham (South)	60 Years (3 Life Cycles)	5%	\$92,836	\$70,555	\$76,326	v/s	0%	0%	26%	-9%	-13%	0%	-10%	-13%	0%	-20%	-26%	0%	-20%	-26%	26%	
Guelph (South)	60 Years (3 Life Cycles)	5%	\$95,589	\$73,344	\$74,460	v/s	0%	0%	30%	-10%	-13%	0%	-10%	-13%	0%	-20%	-26%	0%	-20%	-26%	30%	
Hamilton (South)	60 Years (3 Life Cycles)	5%	\$94,561	\$72,293	\$81,417	v/s	0%	0%	26%	-10%	-13%	0%	-10%	-13%	0%	-20%	-26%	0%	-20%	-26%	26%	
Kingston (South)	60 Years (3 Life Cycles)	5%	\$111,616	\$74,350	\$86,900	v/s	0%	0%	26%	-9%	-13%	0%	-8%	-13%	0%	-17%	-26%	0%	-17%	-26%	26%	
Kitchener-Waterloo (South)	60 Years (3 Life Cycles)	5%	\$111,039	\$73,679	\$82,867	v/s	0%	0%	27%	-9%	-13%	0%	-8%	-13%	0%	-17%	-26%	0%	-17%	-26%	27%	
London (South)	60 Years (3 Life Cycles)	5%	\$95,086	\$72,799	\$78,824	v/s	0%	0%	28%	-10%	-13%	0%	-10%	-13%	0%	-20%	-26%	0%	-20%	-26%	28%	
Mt. Forest (South)	60 Years (3 Life Cycles)	5%	\$96,595	\$74,337	\$82,855	v/s	0%	0%	29%	-10%	-13%	0%	-10%	-13%	0%	-20%	-26%	0%	-20%	-26%	29%	
Niagara Falls (South)	60 Years (3 Life Cycles)	5%	\$93,188	\$70,903	\$77,796	v/s	0%	0%	25%	-10%	-13%	0%	-10%	-13%	0%	-20%	-26%	0%	-20%	-26%	25%	
Sarnia (South)	60 Years (3 Life Cycles)	5%	\$92,649	\$70,346	\$80,041	v/s	0%	0%	25%	-9%	-13%	0%	-10%	-13%	0%	-20%	-26%	0%	-20%	-26%	25%	
Simcoe (South)	60 Years (3 Life Cycles)	5%	\$94,000	\$71,735	\$80,339	v/s	0%	0%	26%	-10%	-13%	0%	-10%	-13%	0%	-20%	-26%	0%	-20%	-26%	26%	
St. Catharines (South)	60 Years (3 Life Cycles)	5%	\$91,901	\$69,620	\$79,535	v/s	0%	0%	24%	-9%	-12%	0%	-10%	-13%	0%	-19%	-26%	0%	-19%	-26%	24%	
Toronto (South)	60 Years (3 Life Cycles)	5%	\$95,109	\$72,863	\$80,545	v/s	0%	0%	27%	-10%	-13%	0%	-10%	-13%	0%	-20%	-26%	0%	-20%	-26%	27%	
Trenton (South)	60 Years (3 Life Cycles)	5%	\$95,564	\$73,266	\$86,144	v/s	0%	0%	26%	-10%	-13%	0%	-10%	-13%	0%	-20%	-26%	0%	-20%	-26%	26%	
Warton (South)	60 Years (3 Life Cycles)	5%	\$111,900	\$74,578	\$84,345	v/s	0%	0%	28%	-9%	-13%	0%	-8%	-13%	0%	-17%	-26%	0%	-17%	-26%	28%	
Windsor (South)	60 Years (3 Life Cycles)	5%	\$92,872	\$70,600	\$76,395	v/s	0%	0%	26%	-9%	-13%	0%	-10%	-13%	0%	-20%	-26%	0%	-20%	-26%	26%	
Barrie (Distinct)	60 Years (3 Life Cycles)	5%	\$111,426	\$83,653	\$79,861	v/s	0%	0%	28%	-9%	-12%	0%	-8%	-11%	0%	-17%	-23%	0%	-17%	-23%	28%	
Muskoka (Distinct)	60 Years (3 Life Cycles)	5%	\$112,880	\$85,113	\$82,837	v/s	0%	0%	29%	-9%	-12%	0%	-8%	-11%	0%	-17%	-23%	0%	-17%	-23%	29%	
Ottawa (Distinct)	60 Years (3 Life Cycles)	5%	\$111,861	\$84,178	\$81,922	v/s	0%	0%	28%	-9%	-12%	0%	-8%	-11%	0%	-17%	-23%	0%	-17%	-23%	28%	
Peterborough (Distinct)	60 Years (3 Life Cycles)	5%	\$112,573	\$84,881	\$82,988	v/s	0%	0%	29%	-9%	-12%	0%	-8%	-11%	0%	-17%	-23%	0%	-17%	-23%	29%	
Kapuskasing (North)	60 Years (3 Life Cycles)	5%	\$120,575	\$92,856	\$97,635	v/s	0%	0%	31%	-10%	-13%	0%	-8%	-10%	0%	-18%	-23%	0%	-18%	-23%	31%	
Kenora (North)	60 Years (3 Life Cycles)	5%	\$118,940	\$91,199	\$91,865	v/s	0%	0%	31%	-10%	-13%	0%	-8%	-10%	0%	-18%	-23%	0%	-18%	-23%	31%	
North Bay (North)	60 Years (3 Life Cycles)	5%	\$113,173	\$85,545	\$82,176	v/s	0%	0%	30%	-9%	-12%	0%	-8%	-11%	0%	-17%	-23%	0%	-17%	-23%	30%	
Sault Ste. Marie (North)	60 Years (3 Life Cycles)	5%	\$98,184	\$75,974	\$81,631	v/s	0%	0%	31%	-11%	-14%	0%	-10%	-12%	0%	-20%	-26%	0%	-20%	-26%	31%	
Sudbury (North)	60 Years (3 Life Cycles)	5%	\$114,775	\$87,163	\$88,408	v/s	0%	0%	30%	-9%	-12%	0%	-8%	-11%	0%	-17%	-23%	0%	-17%	-23%	30%	
Timmins (North)	60 Years (3 Life Cycles)	5%	\$117,486	\$89,865	\$90,072	v/s	0%	0%	32%	-10%	-13%	0%	-8%	-10%	0%	-18%	-23%	0%	-18%	-23%	32%	
Thunder Bay (North)	60 Years (3 Life Cycles)	5%	\$117,770	\$90,097	\$87,296	v/s	0%	0%	32%	-10%	-13%	0%	-8%	-10%	0%	-18%	-23%	0%	-18%	-23%	32%	

Table 10b: % change in present values for comparative scenarios in regards to the main scenario for V.GSHP, H.GSHP (three life cycles) and Traditional HVAC Applications (five life cycles) at a discount rate of 5% for average construction scenario

		Total Present Value																				
		Main Scenario					v/s	Comparative Scenarios														
		Base Case Scenario					v/s	Carbon Taxes - (€1)			FIT - (€2)			Rebates - (€3)			(FIT+Rebates) - (€4)			(FIT+Rebates) + Carbon Taxes - (€5)		
City	Project Life Span	Discount Rate	V.GSHP	H.GSHP	Traditional	v/s	V.GSHP	H.GSHP	Traditional	V.GSHP	H.GSHP	Traditional	V.GSHP	H.GSHP	Traditional	V.GSHP	H.GSHP	Traditional	V.GSHP	H.GSHP	Traditional	
Cambridge (South)	60 Years (3 Life Cycles)	7%	\$74,530	\$56,315	\$53,985	v/s	\$74,530	\$56,315	\$67,142	\$67,514	\$49,251	\$53,985	\$66,873	\$48,658	\$53,985	\$59,857	\$41,593	\$53,985	\$59,857	\$41,593	\$67,142	
Chatham (South)	60 Years (3 Life Cycles)	7%	\$72,895	\$54,666	\$56,197	v/s	\$72,895	\$54,666	\$67,907	\$66,367	\$48,093	\$56,197	\$65,238	\$47,009	\$56,197	\$58,710	\$40,436	\$56,197	\$58,710	\$40,436	\$67,907	
Guelph (South)	60 Years (3 Life Cycles)	7%	\$74,904	\$56,701	\$54,741	v/s	\$74,904	\$56,701	\$68,321	\$67,777	\$49,521	\$54,741	\$67,247	\$49,044	\$54,741	\$60,119	\$41,864	\$54,741	\$60,119	\$41,864	\$68,321	
Hamilton (South)	60 Years (3 Life Cycles)	7%	\$74,154	\$55,934	\$59,938	v/s	\$74,154	\$55,934	\$72,737	\$67,250	\$48,983	\$59,938	\$66,496	\$48,277	\$59,938	\$59,593	\$41,326	\$59,938	\$59,593	\$41,326	\$72,737	
Kingston (South)	60 Years (3 Life Cycles)	7%	\$87,886	\$57,435	\$64,021	v/s	\$87,886	\$57,435	\$77,691	\$80,691	\$50,036	\$64,021	\$80,229	\$49,778	\$64,021	\$73,033	\$42,379	\$64,021	\$73,033	\$42,379	\$77,691	
Kitchener-Waterloo (South)	60 Years (3 Life Cycles)	7%	\$87,465	\$56,946	\$60,977	v/s	\$87,465	\$56,946	\$74,583	\$80,395	\$49,693	\$60,977	\$79,808	\$49,288	\$60,977	\$72,738	\$42,036	\$60,977	\$72,738	\$42,036	\$74,583	
London (South)	60 Years (3 Life Cycles)	7%	\$74,537	\$56,303	\$57,988	v/s	\$74,537	\$56,303	\$71,101	\$67,519	\$49,242	\$57,988	\$66,880	\$48,646	\$57,988	\$59,862	\$41,585	\$57,988	\$59,862	\$41,585	\$71,101	
Mt. Forest (South)	60 Years (3 Life Cycles)	7%	\$75,638	\$57,426	\$60,947	v/s	\$75,638	\$57,426	\$75,489	\$68,292	\$50,030	\$60,947	\$67,981	\$49,768	\$60,947	\$60,634	\$42,372	\$60,947	\$60,634	\$42,372	\$75,489	
Niagara Falls (South)	60 Years (3 Life Cycles)	7%	\$73,152	\$54,920	\$57,267	v/s	\$73,152	\$54,920	\$69,125	\$66,547	\$48,272	\$57,267	\$65,494	\$47,263	\$57,267	\$58,890	\$40,614	\$57,267	\$58,890	\$40,614	\$69,125	
Sarnia (South)	60 Years (3 Life Cycles)	7%	\$72,759	\$54,513	\$58,951	v/s	\$72,759	\$54,513	\$70,987	\$66,271	\$47,986	\$58,951	\$65,101	\$46,856	\$58,951	\$58,614	\$40,329	\$58,951	\$58,614	\$40,329	\$70,987	
Simcoe (South)	60 Years (3 Life Cycles)	7%	\$73,744	\$55,527	\$59,159	v/s	\$73,744	\$55,527	\$71,632	\$66,963	\$48,698	\$59,159	\$66,087	\$47,870	\$59,159	\$59,305	\$41,040	\$59,159	\$59,305	\$41,040	\$71,632	
St. Catharines (South)	60 Years (3 Life Cycles)	7%	\$72,213	\$53,984	\$58,593	v/s	\$72,213	\$53,984	\$70,137	\$65,888	\$47,615	\$58,593	\$64,556	\$46,326	\$58,593	\$58,231	\$39,957	\$58,593	\$58,231	\$39,957	\$70,137	
Toronto (South)	60 Years (3 Life Cycles)	7%	\$74,554	\$56,350	\$59,293	v/s	\$74,554	\$56,350	\$72,479	\$67,531	\$49,275	\$59,293	\$66,896	\$48,693	\$59,293	\$59,873	\$41,618	\$59,293	\$59,873	\$41,618	\$72,479	
Trenton (South)	60 Years (3 Life Cycles)	7%	\$74,885	\$56,644	\$63,478	v/s	\$74,885	\$56,644	\$76,754	\$67,763	\$49,482	\$63,478	\$67,228	\$48,987	\$63,478	\$60,106	\$41,824	\$63,478	\$60,106	\$41,824	\$76,754	
Warton (South)	60 Years (3 Life Cycles)	7%	\$88,093	\$57,602	\$62,095	v/s	\$88,093	\$57,602	\$76,225	\$80,836	\$50,153	\$62,095	\$80,436	\$49,945	\$62,095	\$73,179	\$42,496	\$62,095	\$73,179	\$42,496	\$76,225	
Windsor (South)	60 Years (3 Life Cycles)	7%	\$72,921	\$54,699	\$56,246	v/s	\$72,921	\$54,699	\$67,989	\$66,385	\$48,117	\$56,246	\$65,264	\$47,042	\$56,246	\$58,728	\$40,459	\$56,246	\$58,728	\$40,459	\$67,989	
Barrie (Distinct)	60 Years (3 Life Cycles)	7%	\$87,748	\$65,018	\$58,786	v/s	\$87,748	\$65,018	\$72,301	\$80,593	\$57,791	\$58,786	\$80,090	\$57,361	\$58,786	\$72,936	\$50,134	\$58,786	\$72,936	\$50,134	\$72,301	
Muskoka (Distinct)	60 Years (3 Life Cycles)	7%	\$88,809	\$66,084	\$60,935	v/s	\$88,809	\$66,084	\$75,466	\$81,338	\$58,539	\$60,935	\$81,151	\$58,427	\$60,935	\$73,680	\$50,882	\$60,935	\$73,680	\$50,882	\$75,466	
Ottawa (Distinct)	60 Years (3 Life Cycles)	7%	\$88,065	\$65,402	\$60,282	v/s	\$88,065	\$65,402	\$74,144	\$80,816	\$58,060	\$60,282	\$80,408	\$57,744	\$60,282	\$73,159	\$50,403	\$60,282	\$73,159	\$50,403	\$74,144	
Peterborough (Distinct)	60 Years (3 Life Cycles)	7%	\$88,585	\$65,914	\$61,051	v/s	\$88,585	\$65,914	\$75,307	\$81,181	\$58,420	\$61,051	\$80,928	\$58,257	\$61,051	\$73,524	\$50,763	\$61,051	\$73,524	\$50,763	\$75,307	
Kapuskasing (North)	60 Years (3 Life Cycles)	7%	\$94,424	\$71,735	\$71,753	v/s	\$94,424	\$71,735	\$89,872	\$85,278	\$62,504	\$71,753	\$86,767	\$64,078	\$71,753	\$77,621	\$54,847	\$71,753	\$77,621	\$54,847	\$89,872	
Kenora (North)	60 Years (3 Life Cycles)	7%	\$93,232	\$70,526	\$67,519	v/s	\$93,232	\$70,526	\$84,441	\$84,441	\$61,656	\$67,519	\$85,574	\$62,868	\$67,519	\$76,784	\$53,998	\$67,519	\$76,784	\$53,998	\$84,441	
North Bay (North)	60 Years (3 Life Cycles)	7%	\$89,023	\$66,399	\$60,449	v/s	\$89,023	\$66,399	\$75,089	\$81,488	\$58,760	\$60,449	\$81,365	\$58,742	\$60,449	\$73,831	\$51,103	\$60,449	\$73,831	\$51,103	\$75,089	
Sault Ste. Marie (North)	60 Years (3 Life Cycles)	7%	\$76,798	\$58,621	\$59,995	v/s	\$76,798	\$58,621	\$74,931	\$69,105	\$50,868	\$59,995	\$69,141	\$50,963	\$59,995	\$61,448	\$43,211	\$59,995	\$61,448	\$43,211	\$74,931	
Sudbury (North)	60 Years (3 Life Cycles)	7%	\$90,192	\$67,580	\$65,022	v/s	\$90,192	\$67,580	\$80,794	\$82,308	\$59,589	\$65,022	\$82,535	\$59,923	\$65,022	\$74,651	\$51,932	\$65,022	\$74,651	\$51,932	\$80,794	
Timmins (North)	60 Years (3 Life Cycles)	7%	\$92,170	\$69,552	\$66,147	v/s	\$92,170	\$69,552	\$83,637	\$83,696	\$60,972	\$66,147	\$84,513	\$61,894	\$66,147	\$76,039	\$53,315	\$66,147	\$76,039	\$53,315	\$83,637	
Thunder Bay (North)	60 Years (3 Life Cycles)	7%	\$92,378	\$69,721	\$64,140	v/s	\$92,378	\$69,721	\$80,819	\$83,842	\$61,091	\$64,140	\$84,720	\$62,064	\$64,140	\$76,184	\$53,434	\$64,140	\$76,184	\$53,434	\$80,819	

Table 10c: Rankings of the Cities Based on present values for V.GSHP, H.GSHP (three life cycles) and Traditional HVAC Applications (five life cycles) at a discount rate of 7% for average construction scenario

		Total Present Value																				
		Main Scenario					v/s	Comparative Scenarios														
		Base Case Scenario			v/s	Carbon Taxes - (#1)			FIT - (#2)			Rebates - (#3)			(FIT+Rebates) - (#4)			(FIT+Rebates) + Carbon Taxes - (#5)				
City	Project Life Span	Discount Rate	V.GSHP	H.GSHP	Traditional	v/s	V.GSHP	H.GSHP	Traditional	V.GSHP	H.GSHP	Traditional	V.GSHP	H.GSHP	Traditional	V.GSHP	H.GSHP	Traditional	V.GSHP	H.GSHP	Traditional	
Cambridge (South)	60 Years (3 Life Cycles)	7%	\$74,530	\$56,315	\$53,985	v/s	0%	0%	24%	-9%	-13%	0%	-10%	-14%	0%	-20%	-26%	0%	-20%	-26%	24%	
Chatham (South)	60 Years (3 Life Cycles)	7%	\$72,895	\$54,666	\$56,197	v/s	0%	0%	21%	-9%	-12%	0%	-11%	-14%	0%	-19%	-26%	0%	-19%	-26%	21%	
Guelph (South)	60 Years (3 Life Cycles)	7%	\$74,904	\$56,701	\$54,741	v/s	0%	0%	25%	-10%	-13%	0%	-10%	-14%	0%	-20%	-26%	0%	-20%	-26%	25%	
Hamilton (South)	60 Years (3 Life Cycles)	7%	\$74,154	\$55,934	\$59,938	v/s	0%	0%	21%	-9%	-12%	0%	-10%	-14%	0%	-20%	-26%	0%	-20%	-26%	21%	
Kingston (South)	60 Years (3 Life Cycles)	7%	\$87,886	\$57,435	\$64,021	v/s	0%	0%	21%	-8%	-13%	0%	-9%	-13%	0%	-17%	-26%	0%	-17%	-26%	21%	
Kitchener-Waterloo (South)	60 Years (3 Life Cycles)	7%	\$87,465	\$56,946	\$60,977	v/s	0%	0%	22%	-8%	-13%	0%	-9%	-13%	0%	-17%	-26%	0%	-17%	-26%	22%	
London (South)	60 Years (3 Life Cycles)	7%	\$74,537	\$56,303	\$57,988	v/s	0%	0%	23%	-9%	-13%	0%	-10%	-14%	0%	-20%	-26%	0%	-20%	-26%	23%	
Mt. Forest (South)	60 Years (3 Life Cycles)	7%	\$75,638	\$57,426	\$60,947	v/s	0%	0%	24%	-10%	-13%	0%	-10%	-13%	0%	-20%	-26%	0%	-20%	-26%	24%	
Niagara Falls (South)	60 Years (3 Life Cycles)	7%	\$73,152	\$54,920	\$57,267	v/s	0%	0%	21%	-9%	-12%	0%	-10%	-14%	0%	-19%	-26%	0%	-19%	-26%	21%	
Sarnia (South)	60 Years (3 Life Cycles)	7%	\$72,759	\$54,513	\$58,951	v/s	0%	0%	20%	-9%	-12%	0%	-11%	-14%	0%	-19%	-26%	0%	-19%	-26%	20%	
Simcoe (South)	60 Years (3 Life Cycles)	7%	\$73,744	\$55,527	\$59,159	v/s	0%	0%	21%	-9%	-12%	0%	-10%	-14%	0%	-20%	-26%	0%	-20%	-26%	21%	
St. Catharines (South)	60 Years (3 Life Cycles)	7%	\$72,213	\$53,984	\$58,593	v/s	0%	0%	20%	-9%	-12%	0%	-11%	-14%	0%	-19%	-26%	0%	-19%	-26%	20%	
Toronto (South)	60 Years (3 Life Cycles)	7%	\$74,554	\$56,350	\$59,293	v/s	0%	0%	22%	-9%	-13%	0%	-10%	-14%	0%	-20%	-26%	0%	-20%	-26%	22%	
Trenton (South)	60 Years (3 Life Cycles)	7%	\$74,885	\$56,644	\$63,478	v/s	0%	0%	21%	-10%	-13%	0%	-10%	-14%	0%	-20%	-26%	0%	-20%	-26%	21%	
Warton (South)	60 Years (3 Life Cycles)	7%	\$88,093	\$57,602	\$62,095	v/s	0%	0%	23%	-8%	-13%	0%	-9%	-13%	0%	-17%	-26%	0%	-17%	-26%	23%	
Windsor (South)	60 Years (3 Life Cycles)	7%	\$72,921	\$54,699	\$56,246	v/s	0%	0%	21%	-9%	-12%	0%	-11%	-14%	0%	-19%	-26%	0%	-19%	-26%	21%	
Barrie (Distinct)	60 Years (3 Life Cycles)	7%	\$87,748	\$65,018	\$58,786	v/s	0%	0%	23%	-8%	-11%	0%	-9%	-12%	0%	-17%	-23%	0%	-17%	-23%	23%	
Muskoka (Distinct)	60 Years (3 Life Cycles)	7%	\$88,809	\$66,084	\$60,935	v/s	0%	0%	24%	-8%	-11%	0%	-9%	-12%	0%	-17%	-23%	0%	-17%	-23%	24%	
Ottawa (Distinct)	60 Years (3 Life Cycles)	7%	\$88,065	\$65,402	\$60,282	v/s	0%	0%	23%	-8%	-11%	0%	-9%	-12%	0%	-17%	-23%	0%	-17%	-23%	23%	
Peterborough (Distinct)	60 Years (3 Life Cycles)	7%	\$88,585	\$65,914	\$61,051	v/s	0%	0%	23%	-8%	-11%	0%	-9%	-12%	0%	-17%	-23%	0%	-17%	-23%	23%	
Kapuskasing (North)	60 Years (3 Life Cycles)	7%	\$94,424	\$71,735	\$71,753	v/s	0%	0%	25%	-10%	-13%	0%	-8%	-11%	0%	-18%	-24%	0%	-18%	-24%	25%	
Kenora (North)	60 Years (3 Life Cycles)	7%	\$93,232	\$70,526	\$67,519	v/s	0%	0%	25%	-9%	-13%	0%	-8%	-11%	0%	-18%	-23%	0%	-18%	-23%	25%	
North Bay (North)	60 Years (3 Life Cycles)	7%	\$89,023	\$66,399	\$60,449	v/s	0%	0%	24%	-8%	-12%	0%	-9%	-12%	0%	-17%	-23%	0%	-17%	-23%	24%	
Sault Ste. Marie (North)	60 Years (3 Life Cycles)	7%	\$76,798	\$58,621	\$59,995	v/s	0%	0%	25%	-10%	-13%	0%	-10%	-13%	0%	-20%	-26%	0%	-20%	-26%	25%	
Sudbury (North)	60 Years (3 Life Cycles)	7%	\$90,192	\$67,580	\$65,022	v/s	0%	0%	24%	-9%	-12%	0%	-8%	-11%	0%	-17%	-23%	0%	-17%	-23%	24%	
Timmins (North)	60 Years (3 Life Cycles)	7%	\$92,170	\$69,552	\$66,147	v/s	0%	0%	26%	-9%	-12%	0%	-8%	-11%	0%	-18%	-23%	0%	-18%	-23%	26%	
Thunder Bay (North)	60 Years (3 Life Cycles)	7%	\$92,378	\$69,721	\$64,140	v/s	0%	0%	26%	-9%	-12%	0%	-8%	-11%	0%	-18%	-23%	0%	-18%	-23%	26%	

Table 10d: % change in present values for comparative scenarios in regards to the main scenario for V.GSHP, H.GSHP (three life cycles) and Traditional HVAC Applications (five life cycles) at a discount rate of 7% for average construction scenario

		Total Present Value																				
		Main Scenario					v/s	Comparative Scenarios														
		Base Case Scenario					v/s	Carbon Taxes - (#1)			FIT - (#2)			Rebates - (#3)			(FIT+Rebates) - (#4)			(FIT+Rebates) + Carbon Taxes - (#5)		
City	Project Life Span	Discount Rate	V.GSHP	H.GSHP	Traditional	v/s	V.GSHP	H.GSHP	Traditional	V.GSHP	H.GSHP	Traditional	V.GSHP	H.GSHP	Traditional	V.GSHP	H.GSHP	Traditional	V.GSHP	H.GSHP	Traditional	
Cambridge (South)	60 Years (3 Life Cycles)	7.5%	\$70,936	\$53,421	\$50,600	v/s	\$70,936	\$53,421	\$62,333	\$64,359	\$46,799	\$50,600	\$63,575	\$46,060	\$50,600	\$56,998	\$39,438	\$50,600	\$56,998	\$39,438	\$62,333	
Chatham (South)	60 Years (3 Life Cycles)	7.5%	\$69,408	\$51,880	\$52,688	v/s	\$69,408	\$51,880	\$63,131	\$63,289	\$45,720	\$52,688	\$62,047	\$44,519	\$52,688	\$55,928	\$38,359	\$52,688	\$55,928	\$38,359	\$63,131	
Guelph (South)	60 Years (3 Life Cycles)	7.5%	\$71,285	\$53,781	\$51,305	v/s	\$71,285	\$53,781	\$63,415	\$64,604	\$47,052	\$51,305	\$63,924	\$46,421	\$51,305	\$57,243	\$39,691	\$51,305	\$57,243	\$39,691	\$63,415	
Hamilton (South)	60 Years (3 Life Cycles)	7.5%	\$70,584	\$53,065	\$56,194	v/s	\$70,584	\$53,065	\$67,607	\$64,113	\$46,550	\$56,194	\$63,223	\$45,704	\$56,194	\$56,752	\$39,189	\$56,194	\$56,752	\$39,189	\$67,607	
Kingston (South)	60 Years (3 Life Cycles)	7.5%	\$83,740	\$54,467	\$60,035	v/s	\$83,740	\$54,467	\$72,226	\$76,995	\$47,532	\$60,035	\$76,379	\$47,106	\$60,035	\$69,634	\$40,171	\$60,035	\$69,634	\$40,171	\$72,226	
Kitchener-Waterloo (South)	60 Years (3 Life Cycles)	7.5%	\$83,347	\$54,010	\$57,161	v/s	\$83,347	\$54,010	\$69,294	\$76,720	\$47,212	\$57,161	\$75,986	\$46,649	\$57,161	\$69,359	\$39,851	\$57,161	\$69,359	\$39,851	\$69,294	
London (South)	60 Years (3 Life Cycles)	7.5%	\$70,942	\$53,410	\$54,355	v/s	\$70,942	\$53,410	\$66,049	\$64,364	\$46,791	\$54,355	\$63,581	\$46,049	\$54,355	\$57,003	\$39,431	\$54,355	\$57,003	\$39,431	\$66,049	
Mt. Forest (South)	60 Years (3 Life Cycles)	7.5%	\$71,971	\$54,458	\$57,129	v/s	\$71,971	\$54,458	\$70,097	\$65,084	\$47,526	\$57,129	\$64,610	\$47,097	\$57,129	\$57,723	\$40,165	\$57,129	\$57,723	\$40,165	\$70,097	
Niagara Falls (South)	60 Years (3 Life Cycles)	7.5%	\$69,648	\$52,118	\$53,687	v/s	\$69,648	\$52,118	\$64,262	\$63,457	\$45,886	\$53,687	\$62,287	\$44,757	\$53,687	\$56,096	\$38,525	\$53,687	\$56,096	\$38,525	\$64,262	
Sarnia (South)	60 Years (3 Life Cycles)	7.5%	\$69,281	\$51,737	\$55,275	v/s	\$69,281	\$51,737	\$66,009	\$63,200	\$45,620	\$55,275	\$61,920	\$44,377	\$55,275	\$55,839	\$38,259	\$55,275	\$55,839	\$38,259	\$66,009	
Simcoe (South)	60 Years (3 Life Cycles)	7.5%	\$70,201	\$52,685	\$55,468	v/s	\$70,201	\$52,685	\$66,591	\$63,845	\$46,283	\$55,468	\$62,841	\$45,324	\$55,468	\$56,484	\$38,922	\$55,468	\$56,484	\$38,922	\$66,591	
St. Catharines (South)	60 Years (3 Life Cycles)	7.5%	\$68,771	\$51,243	\$54,943	v/s	\$68,771	\$51,243	\$65,238	\$62,842	\$45,273	\$54,943	\$61,410	\$43,882	\$54,943	\$55,481	\$37,912	\$54,943	\$55,481	\$37,912	\$65,238	
Toronto (South)	60 Years (3 Life Cycles)	7.5%	\$70,957	\$53,454	\$55,590	v/s	\$70,957	\$53,454	\$67,348	\$64,374	\$46,822	\$55,590	\$63,597	\$46,093	\$55,590	\$57,014	\$39,461	\$55,590	\$57,014	\$39,461	\$67,348	
Trenton (South)	60 Years (3 Life Cycles)	7.5%	\$71,267	\$53,729	\$59,530	v/s	\$71,267	\$53,729	\$71,369	\$64,592	\$47,015	\$59,530	\$63,906	\$46,368	\$59,530	\$57,231	\$39,654	\$59,530	\$57,231	\$39,654	\$71,369	
Warton (South)	60 Years (3 Life Cycles)	7.5%	\$83,934	\$54,623	\$58,218	v/s	\$83,934	\$54,623	\$70,819	\$77,131	\$47,642	\$58,218	\$76,573	\$47,262	\$58,218	\$69,770	\$40,281	\$58,218	\$69,770	\$40,281	\$70,819	
Windsor (South)	60 Years (3 Life Cycles)	7.5%	\$69,432	\$51,911	\$52,734	v/s	\$69,432	\$51,911	\$63,206	\$63,306	\$45,741	\$52,734	\$62,071	\$44,550	\$52,734	\$55,945	\$38,380	\$52,734	\$55,945	\$38,380	\$63,206	
Barrie (Distinct)	60 Years (3 Life Cycles)	7.5%	\$83,610	\$61,754	\$55,115	v/s	\$83,610	\$61,754	\$67,167	\$76,904	\$54,980	\$55,115	\$76,250	\$54,393	\$55,115	\$69,544	\$47,619	\$55,115	\$69,544	\$47,619	\$67,167	
Muskoka (Distinct)	60 Years (3 Life Cycles)	7.5%	\$84,602	\$62,750	\$57,118	v/s	\$84,602	\$62,750	\$70,076	\$77,599	\$55,678	\$57,118	\$77,241	\$55,389	\$57,118	\$70,238	\$48,317	\$57,118	\$70,238	\$48,317	\$70,076	
Ottawa (Distinct)	60 Years (3 Life Cycles)	7.5%	\$83,907	\$62,112	\$56,511	v/s	\$83,907	\$62,112	\$68,872	\$77,112	\$55,231	\$56,511	\$76,546	\$54,751	\$56,511	\$69,751	\$47,870	\$56,511	\$69,751	\$47,870	\$68,872	
Peterborough (Distinct)	60 Years (3 Life Cycles)	7.5%	\$84,393	\$62,592	\$57,227	v/s	\$84,393	\$62,592	\$69,940	\$77,453	\$55,567	\$57,227	\$77,032	\$55,231	\$57,227	\$70,092	\$48,206	\$57,227	\$70,092	\$48,206	\$69,940	
Kapuskasing (North)	60 Years (3 Life Cycles)	7.5%	\$89,848	\$68,029	\$67,240	v/s	\$89,848	\$68,029	\$83,397	\$81,275	\$59,377	\$67,240	\$82,487	\$60,668	\$67,240	\$73,914	\$52,016	\$67,240	\$73,914	\$52,016	\$83,397	
Kenora (North)	60 Years (3 Life Cycles)	7.5%	\$88,734	\$66,899	\$63,273	v/s	\$88,734	\$66,899	\$78,364	\$80,494	\$58,585	\$63,273	\$81,373	\$59,538	\$63,273	\$73,133	\$51,224	\$63,273	\$73,133	\$51,224	\$78,364	
North Bay (North)	60 Years (3 Life Cycles)	7.5%	\$84,802	\$63,044	\$56,664	v/s	\$84,802	\$63,044	\$69,719	\$77,739	\$55,884	\$56,664	\$77,441	\$55,683	\$56,664	\$70,378	\$48,523	\$56,664	\$70,378	\$48,523	\$69,719	
Sault Ste. Marie (North)	60 Years (3 Life Cycles)	7.5%	\$73,054	\$55,575	\$56,222	v/s	\$73,054	\$55,575	\$69,542	\$65,844	\$48,308	\$56,222	\$65,693	\$48,214	\$56,222	\$58,483	\$40,947	\$56,222	\$58,483	\$40,947	\$69,542	
Sudbury (North)	60 Years (3 Life Cycles)	7.5%	\$85,894	\$64,148	\$60,946	v/s	\$85,894	\$64,148	\$75,011	\$78,504	\$56,657	\$60,946	\$78,533	\$56,787	\$60,946	\$71,143	\$49,296	\$60,946	\$71,143	\$49,296	\$75,011	
Timmins (North)	60 Years (3 Life Cycles)	7.5%	\$87,742	\$65,989	\$61,974	v/s	\$87,742	\$65,989	\$77,571	\$79,799	\$57,948	\$61,974	\$80,382	\$58,629	\$61,974	\$72,439	\$50,587	\$61,974	\$72,439	\$50,587	\$77,571	
Thunder Bay (North)	60 Years (3 Life Cycles)	7.5%	\$87,936	\$66,148	\$60,102	v/s	\$87,936	\$66,148	\$74,976	\$79,935	\$58,059	\$60,102	\$80,575	\$58,787	\$60,102	\$72,574	\$50,698	\$60,102	\$72,574	\$50,698	\$74,976	

Table 10e: Rankings of the Cities Based on present values for V.GSHP, H.GSHP (three life cycles) and Traditional HVAC Applications (five life cycles) at a discount rate of 7.5% for average construction scenario

		Total Present Value																				
		Main Scenario					v/s	Comparative Scenarios														
		Base Case Scenario			v/s	Carbon Taxes - (€1)			FIT - (€2)			Rebates - (€3)			(FIT+Rebates) - (€4)			(FIT+Rebates) + Carbon Taxes - (€5)				
City	Project Life Span	Discount Rate	V.GSHP	H.GSHP	Traditional	v/s	V.GSHP	H.GSHP	Traditional	V.GSHP	H.GSHP	Traditional	V.GSHP	H.GSHP	Traditional	V.GSHP	H.GSHP	Traditional	V.GSHP	H.GSHP	Traditional	
Cambridge (South)	60 Years (3 Life Cycles)	7.5%	\$70,936	\$53,421	\$50,600	v/s	0%	0%	23%	-9%	-12%	0%	-10%	-14%	0%	-20%	-26%	0%	-20%	-26%	23%	
Chatham (South)	60 Years (3 Life Cycles)	7.5%	\$69,408	\$51,880	\$52,688	v/s	0%	0%	20%	-9%	-12%	0%	-11%	-14%	0%	-19%	-26%	0%	-19%	-26%	20%	
Guelph (South)	60 Years (3 Life Cycles)	7.5%	\$71,285	\$53,781	\$51,305	v/s	0%	0%	24%	-9%	-13%	0%	-10%	-14%	0%	-20%	-26%	0%	-20%	-26%	24%	
Hamilton (South)	60 Years (3 Life Cycles)	7.5%	\$70,584	\$53,065	\$56,194	v/s	0%	0%	20%	-9%	-12%	0%	-10%	-14%	0%	-20%	-26%	0%	-20%	-26%	20%	
Kingston (South)	60 Years (3 Life Cycles)	7.5%	\$83,740	\$54,467	\$60,035	v/s	0%	0%	20%	-8%	-13%	0%	-9%	-14%	0%	-17%	-26%	0%	-17%	-26%	20%	
Kitchener-Waterloo (South)	60 Years (3 Life Cycles)	7.5%	\$83,347	\$54,010	\$57,161	v/s	0%	0%	21%	-8%	-13%	0%	-9%	-14%	0%	-17%	-26%	0%	-17%	-26%	21%	
London (South)	60 Years (3 Life Cycles)	7.5%	\$70,942	\$53,410	\$54,355	v/s	0%	0%	22%	-9%	-12%	0%	-10%	-14%	0%	-20%	-26%	0%	-20%	-26%	22%	
Mt. Forest (South)	60 Years (3 Life Cycles)	7.5%	\$71,971	\$54,458	\$57,129	v/s	0%	0%	23%	-10%	-13%	0%	-10%	-14%	0%	-20%	-26%	0%	-20%	-26%	23%	
Niagara Falls (South)	60 Years (3 Life Cycles)	7.5%	\$69,648	\$52,118	\$53,687	v/s	0%	0%	20%	-9%	-12%	0%	-11%	-14%	0%	-19%	-26%	0%	-19%	-26%	20%	
Sarnia (South)	60 Years (3 Life Cycles)	7.5%	\$69,281	\$51,737	\$55,275	v/s	0%	0%	19%	-9%	-12%	0%	-11%	-14%	0%	-19%	-26%	0%	-19%	-26%	19%	
Simcoe (South)	60 Years (3 Life Cycles)	7.5%	\$70,201	\$52,685	\$55,468	v/s	0%	0%	20%	-9%	-12%	0%	-10%	-14%	0%	-20%	-26%	0%	-20%	-26%	20%	
St. Catharines (South)	60 Years (3 Life Cycles)	7.5%	\$68,771	\$51,243	\$54,943	v/s	0%	0%	19%	-9%	-12%	0%	-11%	-14%	0%	-19%	-26%	0%	-19%	-26%	19%	
Toronto (South)	60 Years (3 Life Cycles)	7.5%	\$70,957	\$53,454	\$55,590	v/s	0%	0%	21%	-9%	-12%	0%	-10%	-14%	0%	-20%	-26%	0%	-20%	-26%	21%	
Trenton (South)	60 Years (3 Life Cycles)	7.5%	\$71,267	\$53,729	\$59,530	v/s	0%	0%	20%	-9%	-12%	0%	-10%	-14%	0%	-20%	-26%	0%	-20%	-26%	20%	
Warton (South)	60 Years (3 Life Cycles)	7.5%	\$83,934	\$54,623	\$58,218	v/s	0%	0%	22%	-8%	-13%	0%	-9%	-13%	0%	-17%	-26%	0%	-17%	-26%	22%	
Windsor (South)	60 Years (3 Life Cycles)	7.5%	\$69,432	\$51,911	\$52,734	v/s	0%	0%	20%	-9%	-12%	0%	-11%	-14%	0%	-19%	-26%	0%	-19%	-26%	20%	
Barrie (Distinct)	60 Years (3 Life Cycles)	7.5%	\$83,610	\$61,754	\$55,115	v/s	0%	0%	22%	-8%	-11%	0%	-9%	-12%	0%	-17%	-23%	0%	-17%	-23%	22%	
Muskoka (Distinct)	60 Years (3 Life Cycles)	7.5%	\$84,602	\$62,750	\$57,118	v/s	0%	0%	23%	-8%	-11%	0%	-9%	-12%	0%	-17%	-23%	0%	-17%	-23%	23%	
Ottawa (Distinct)	60 Years (3 Life Cycles)	7.5%	\$83,907	\$62,112	\$56,511	v/s	0%	0%	22%	-8%	-11%	0%	-9%	-12%	0%	-17%	-23%	0%	-17%	-23%	22%	
Peterborough (Distinct)	60 Years (3 Life Cycles)	7.5%	\$84,393	\$62,592	\$57,227	v/s	0%	0%	22%	-8%	-11%	0%	-9%	-12%	0%	-17%	-23%	0%	-17%	-23%	22%	
Kapuskasing (North)	60 Years (3 Life Cycles)	7.5%	\$89,848	\$68,029	\$67,240	v/s	0%	0%	24%	-10%	-13%	0%	-8%	-11%	0%	-18%	-24%	0%	-18%	-24%	24%	
Kenora (North)	60 Years (3 Life Cycles)	7.5%	\$88,734	\$66,899	\$63,273	v/s	0%	0%	24%	-9%	-12%	0%	-8%	-11%	0%	-18%	-23%	0%	-18%	-23%	24%	
North Bay (North)	60 Years (3 Life Cycles)	7.5%	\$84,802	\$63,044	\$56,664	v/s	0%	0%	23%	-8%	-11%	0%	-9%	-12%	0%	-17%	-23%	0%	-17%	-23%	23%	
Sault Ste. Marie (North)	60 Years (3 Life Cycles)	7.5%	\$73,054	\$55,575	\$56,222	v/s	0%	0%	24%	-10%	-13%	0%	-10%	-13%	0%	-20%	-26%	0%	-20%	-26%	24%	
Sudbury (North)	60 Years (3 Life Cycles)	7.5%	\$85,894	\$64,148	\$60,946	v/s	0%	0%	23%	-9%	-12%	0%	-9%	-11%	0%	-17%	-23%	0%	-17%	-23%	23%	
Timmins (North)	60 Years (3 Life Cycles)	7.5%	\$87,742	\$65,989	\$61,974	v/s	0%	0%	25%	-9%	-12%	0%	-8%	-11%	0%	-17%	-23%	0%	-17%	-23%	25%	
Thunder Bay (North)	60 Years (3 Life Cycles)	7.5%	\$87,936	\$66,148	\$60,102	v/s	0%	0%	25%	-9%	-12%	0%	-8%	-11%	0%	-17%	-23%	0%	-17%	-23%	25%	

Table 10f: % change in present values for comparative scenarios in regards to the main scenario for V.GSHP, H.GSHP (three life cycles) and Traditional HVAC Applications (five life cycles) at a discount rate of 7.5% for average construction scenario

			Total Present Value																		
			Main Scenario					v/s	Comparative Scenarios												
			Base Case Scenario			v/s	Carbon Taxes - (€1)			FIT - (€2)			Rebates - (€3)			(FIT+Rebates) - (€4)			(FIT+Rebates) + Carbon Taxes - (€5)		
City	Project Life Span	Discount Rate	V.GSHP	H.GSHP	Traditional	v/s	V.GSHP	H.GSHP	Traditional	V.GSHP	H.GSHP	Traditional	V.GSHP	H.GSHP	Traditional	V.GSHP	H.GSHP	Traditional	V.GSHP	H.GSHP	Traditional
Cambridge (South)	60 Years (3 Life Cycles)	8.5%	\$64,993	\$48,625	\$44,996	v/s	\$64,993	\$48,625	\$54,463	\$59,158	\$42,749	\$44,996	\$58,117	\$41,749	\$44,996	\$52,282	\$35,873	\$44,996	\$52,282	\$35,873	\$54,463
Chatham (South)	60 Years (3 Life Cycles)	8.5%	\$63,646	\$47,266	\$46,879	v/s	\$63,646	\$47,266	\$55,304	\$58,216	\$41,799	\$46,879	\$56,770	\$40,390	\$46,879	\$51,340	\$34,924	\$46,879	\$51,340	\$34,924	\$55,304
Guelph (South)	60 Years (3 Life Cycles)	8.5%	\$65,301	\$48,943	\$45,615	v/s	\$65,301	\$48,943	\$55,386	\$59,373	\$42,971	\$45,615	\$58,425	\$42,067	\$45,615	\$52,497	\$36,095	\$45,615	\$52,497	\$36,095	\$55,386
Hamilton (South)	60 Years (3 Life Cycles)	8.5%	\$64,683	\$48,311	\$49,994	v/s	\$64,683	\$48,311	\$59,203	\$58,941	\$42,530	\$49,994	\$57,807	\$41,435	\$49,994	\$52,065	\$35,654	\$49,994	\$52,065	\$35,654	\$59,203
Kingston (South)	60 Years (3 Life Cycles)	8.5%	\$76,893	\$49,548	\$53,438	v/s	\$76,893	\$49,548	\$63,274	\$70,909	\$43,394	\$53,438	\$70,018	\$42,672	\$53,438	\$64,033	\$36,518	\$53,438	\$64,033	\$36,518	\$63,274
Kitchener-Waterloo (South)	60 Years (3 Life Cycles)	8.5%	\$76,546	\$49,144	\$50,842	v/s	\$76,546	\$49,144	\$60,631	\$70,666	\$43,112	\$50,842	\$69,671	\$42,269	\$50,842	\$63,790	\$36,236	\$50,842	\$63,790	\$36,236	\$60,631
London (South)	60 Years (3 Life Cycles)	8.5%	\$64,999	\$48,615	\$48,339	v/s	\$64,999	\$48,615	\$57,775	\$59,162	\$42,742	\$48,339	\$58,123	\$41,739	\$48,339	\$52,286	\$35,867	\$48,339	\$52,286	\$35,867	\$57,775
Mt. Forest (South)	60 Years (3 Life Cycles)	8.5%	\$65,906	\$49,540	\$50,807	v/s	\$65,906	\$49,540	\$61,270	\$59,796	\$43,389	\$50,807	\$59,030	\$42,664	\$50,807	\$52,920	\$36,513	\$50,807	\$52,920	\$36,513	\$61,270
Niagara Falls (South)	60 Years (3 Life Cycles)	8.5%	\$63,857	\$47,475	\$47,758	v/s	\$63,857	\$47,475	\$56,291	\$58,364	\$41,946	\$47,758	\$56,981	\$40,599	\$47,758	\$51,488	\$35,070	\$47,758	\$51,488	\$35,070	\$56,291
Sarnia (South)	60 Years (3 Life Cycles)	8.5%	\$63,533	\$47,140	\$49,189	v/s	\$63,533	\$47,140	\$57,849	\$58,137	\$41,711	\$49,189	\$56,657	\$40,264	\$49,189	\$51,262	\$34,835	\$49,189	\$51,262	\$34,835	\$57,849
Simcoe (South)	60 Years (3 Life Cycles)	8.5%	\$64,346	\$47,975	\$49,356	v/s	\$64,346	\$47,975	\$58,330	\$58,705	\$42,295	\$49,356	\$57,470	\$41,100	\$49,356	\$51,829	\$35,419	\$49,356	\$51,829	\$35,419	\$58,330
St. Catharines (South)	60 Years (3 Life Cycles)	8.5%	\$63,083	\$46,704	\$48,900	v/s	\$63,083	\$46,704	\$57,206	\$57,823	\$41,406	\$48,900	\$56,208	\$39,828	\$48,900	\$50,947	\$34,531	\$48,900	\$50,947	\$34,531	\$57,206
Toronto (South)	60 Years (3 Life Cycles)	8.5%	\$65,012	\$48,654	\$49,458	v/s	\$65,012	\$48,654	\$58,946	\$59,171	\$42,769	\$49,458	\$58,137	\$41,778	\$49,458	\$52,295	\$35,894	\$49,458	\$52,295	\$35,894	\$58,946
Trenton (South)	60 Years (3 Life Cycles)	8.5%	\$65,286	\$48,896	\$52,995	v/s	\$65,286	\$48,896	\$62,547	\$59,362	\$42,939	\$52,995	\$58,410	\$42,020	\$52,995	\$52,486	\$36,063	\$52,995	\$52,486	\$36,063	\$62,547
Warton (South)	60 Years (3 Life Cycles)	8.5%	\$77,064	\$49,685	\$51,801	v/s	\$77,064	\$49,685	\$61,968	\$71,028	\$43,490	\$51,801	\$70,188	\$42,809	\$51,801	\$64,152	\$36,614	\$51,801	\$64,152	\$36,614	\$61,968
Windsor (South)	60 Years (3 Life Cycles)	8.5%	\$63,667	\$47,293	\$46,919	v/s	\$63,667	\$47,293	\$55,368	\$58,231	\$41,818	\$46,919	\$56,791	\$40,417	\$46,919	\$51,355	\$34,943	\$46,919	\$51,355	\$34,943	\$55,368
Barrie (Distinct)	60 Years (3 Life Cycles)	8.5%	\$76,779	\$56,351	\$49,037	v/s	\$76,779	\$56,351	\$58,761	\$70,829	\$50,341	\$49,037	\$69,903	\$49,475	\$49,037	\$63,953	\$43,465	\$49,037	\$63,953	\$43,465	\$58,761
Muskoka (Distinct)	60 Years (3 Life Cycles)	8.5%	\$77,653	\$57,229	\$50,797	v/s	\$77,653	\$57,229	\$61,252	\$71,440	\$50,954	\$50,797	\$70,778	\$50,354	\$50,797	\$64,564	\$44,079	\$50,797	\$64,564	\$44,079	\$61,252
Ottawa (Distinct)	60 Years (3 Life Cycles)	8.5%	\$77,041	\$56,667	\$50,266	v/s	\$77,041	\$56,667	\$60,240	\$71,011	\$50,561	\$50,266	\$70,165	\$49,791	\$50,266	\$64,136	\$43,686	\$50,266	\$64,136	\$43,686	\$60,240
Peterborough (Distinct)	60 Years (3 Life Cycles)	8.5%	\$77,469	\$57,090	\$50,895	v/s	\$77,469	\$57,090	\$61,153	\$71,311	\$50,857	\$50,895	\$70,593	\$50,214	\$50,895	\$64,435	\$43,981	\$50,895	\$64,435	\$43,981	\$61,153
Kapuskasing (North)	60 Years (3 Life Cycles)	8.5%	\$82,281	\$61,886	\$59,762	v/s	\$82,281	\$61,886	\$72,799	\$74,674	\$54,209	\$59,762	\$75,405	\$55,010	\$59,762	\$67,798	\$47,333	\$59,762	\$67,798	\$47,333	\$72,799
Kenora (North)	60 Years (3 Life Cycles)	8.5%	\$81,298	\$60,890	\$56,241	v/s	\$81,298	\$60,890	\$68,417	\$73,987	\$53,512	\$56,241	\$74,422	\$54,014	\$56,241	\$67,111	\$46,636	\$56,241	\$67,111	\$46,636	\$68,417
North Bay (North)	60 Years (3 Life Cycles)	8.5%	\$77,830	\$57,489	\$50,396	v/s	\$77,830	\$57,489	\$60,929	\$71,563	\$51,136	\$50,396	\$70,954	\$50,613	\$50,396	\$64,687	\$44,260	\$50,396	\$64,687	\$44,260	\$60,929
Sault Ste. Marie (North)	60 Years (3 Life Cycles)	8.5%	\$66,862	\$50,525	\$49,974	v/s	\$66,862	\$50,525	\$60,721	\$60,464	\$44,077	\$49,974	\$59,986	\$43,649	\$49,974	\$53,588	\$37,201	\$49,974	\$53,588	\$37,201	\$60,721
Sudbury (North)	60 Years (3 Life Cycles)	8.5%	\$78,793	\$58,462	\$54,196	v/s	\$78,793	\$58,462	\$65,544	\$72,236	\$51,816	\$54,196	\$71,917	\$51,587	\$54,196	\$65,360	\$44,940	\$54,196	\$65,360	\$44,940	\$65,544
Timmins (North)	60 Years (3 Life Cycles)	8.5%	\$80,424	\$60,087	\$55,060	v/s	\$80,424	\$60,087	\$67,644	\$73,376	\$52,951	\$55,060	\$73,548	\$53,211	\$55,060	\$66,500	\$46,076	\$55,060	\$66,500	\$46,076	\$67,644
Thunder Bay (North)	60 Years (3 Life Cycles)	8.5%	\$80,594	\$60,227	\$53,415	v/s	\$80,594	\$60,227	\$65,416	\$73,495	\$53,049	\$53,415	\$73,718	\$53,351	\$53,415	\$66,619	\$46,173	\$53,415	\$66,619	\$46,173	\$65,416

Table 10g: Rankings of the Cities Based on present values for V.GSHP, H.GSHP (three life cycles) and Traditional HVAC Applications (five life cycles) at a discount rate of 8.5% for average construction scenario

Total Present Value																					
Main Scenario						v/s	Comparative Scenarios														
Base Case Scenario						v/s	Carbon Taxes - (€1)			FIT - (€2)			Rebates - (€3)			(FIT+Rebates) - (€4)			(FIT+Rebates) + Carbon Taxes - (€5)		
City	Project Life Span	Discount Rate	V.GSHP	H.GSHP	Traditional	v/s	V.GSHP	H.GSHP	Traditional	V.GSHP	H.GSHP	Traditional	V.GSHP	H.GSHP	Traditional	V.GSHP	H.GSHP	Traditional	V.GSHP	H.GSHP	Traditional
Cambridge (South)	60 Years (3 Life Cycles)	8.5%	\$64,993	\$48,625	\$44,996	v/s	0%	0%	21%	-9%	-12%	0%	-11%	-14%	0%	-20%	-26%	0%	-20%	-26%	21%
Chatham (South)	60 Years (3 Life Cycles)	8.5%	\$63,646	\$47,266	\$46,879	v/s	0%	0%	18%	-9%	-12%	0%	-11%	-15%	0%	-19%	-26%	0%	-19%	-26%	18%
Guelph (South)	60 Years (3 Life Cycles)	8.5%	\$65,301	\$48,943	\$45,615	v/s	0%	0%	21%	-9%	-12%	0%	-11%	-14%	0%	-20%	-26%	0%	-20%	-26%	21%
Hamilton (South)	60 Years (3 Life Cycles)	8.5%	\$64,683	\$48,311	\$49,994	v/s	0%	0%	18%	-9%	-12%	0%	-11%	-14%	0%	-20%	-26%	0%	-20%	-26%	18%
Kingston (South)	60 Years (3 Life Cycles)	8.5%	\$76,893	\$49,548	\$53,438	v/s	0%	0%	18%	-8%	-12%	0%	-9%	-14%	0%	-17%	-26%	0%	-17%	-26%	18%
Kitchener-Waterloo (South)	60 Years (3 Life Cycles)	8.5%	\$76,546	\$49,144	\$50,842	v/s	0%	0%	19%	-8%	-12%	0%	-9%	-14%	0%	-17%	-26%	0%	-17%	-26%	19%
London (South)	60 Years (3 Life Cycles)	8.5%	\$64,999	\$48,615	\$48,339	v/s	0%	0%	20%	-9%	-12%	0%	-11%	-14%	0%	-20%	-26%	0%	-20%	-26%	20%
Mt. Forest (South)	60 Years (3 Life Cycles)	8.5%	\$65,906	\$49,540	\$50,807	v/s	0%	0%	21%	-9%	-12%	0%	-10%	-14%	0%	-20%	-26%	0%	-20%	-26%	21%
Niagara Falls (South)	60 Years (3 Life Cycles)	8.5%	\$63,857	\$47,475	\$47,758	v/s	0%	0%	18%	-9%	-12%	0%	-11%	-14%	0%	-19%	-26%	0%	-19%	-26%	18%
Sarnia (South)	60 Years (3 Life Cycles)	8.5%	\$63,533	\$47,140	\$49,189	v/s	0%	0%	18%	-8%	-12%	0%	-11%	-15%	0%	-19%	-26%	0%	-19%	-26%	18%
Simcoe (South)	60 Years (3 Life Cycles)	8.5%	\$64,346	\$47,975	\$49,356	v/s	0%	0%	18%	-9%	-12%	0%	-11%	-14%	0%	-19%	-26%	0%	-19%	-26%	18%
St. Catharines (South)	60 Years (3 Life Cycles)	8.5%	\$63,083	\$46,704	\$48,900	v/s	0%	0%	17%	-8%	-11%	0%	-11%	-15%	0%	-19%	-26%	0%	-19%	-26%	17%
Toronto (South)	60 Years (3 Life Cycles)	8.5%	\$65,012	\$48,654	\$49,458	v/s	0%	0%	19%	-9%	-12%	0%	-11%	-14%	0%	-20%	-26%	0%	-20%	-26%	19%
Trenton (South)	60 Years (3 Life Cycles)	8.5%	\$65,286	\$48,896	\$52,995	v/s	0%	0%	18%	-9%	-12%	0%	-11%	-14%	0%	-20%	-26%	0%	-20%	-26%	18%
Warton (South)	60 Years (3 Life Cycles)	8.5%	\$77,064	\$49,685	\$51,801	v/s	0%	0%	20%	-8%	-12%	0%	-9%	-14%	0%	-17%	-26%	0%	-17%	-26%	20%
Windsor (South)	60 Years (3 Life Cycles)	8.5%	\$63,667	\$47,293	\$46,919	v/s	0%	0%	18%	-9%	-12%	0%	-11%	-15%	0%	-19%	-26%	0%	-19%	-26%	18%
Barrie (Distinct)	60 Years (3 Life Cycles)	8.5%	\$76,779	\$56,351	\$49,037	v/s	0%	0%	20%	-8%	-11%	0%	-9%	-12%	0%	-17%	-23%	0%	-17%	-23%	20%
Muskoka (Distinct)	60 Years (3 Life Cycles)	8.5%	\$77,653	\$57,229	\$50,797	v/s	0%	0%	21%	-8%	-11%	0%	-9%	-12%	0%	-17%	-23%	0%	-17%	-23%	21%
Ottawa (Distinct)	60 Years (3 Life Cycles)	8.5%	\$77,041	\$56,667	\$50,266	v/s	0%	0%	20%	-8%	-11%	0%	-9%	-12%	0%	-17%	-23%	0%	-17%	-23%	20%
Peterborough (Distinct)	60 Years (3 Life Cycles)	8.5%	\$77,469	\$57,090	\$50,895	v/s	0%	0%	20%	-8%	-11%	0%	-9%	-12%	0%	-17%	-23%	0%	-17%	-23%	20%
Kapuskasing (North)	60 Years (3 Life Cycles)	8.5%	\$82,281	\$61,886	\$59,762	v/s	0%	0%	22%	-9%	-12%	0%	-8%	-11%	0%	-18%	-24%	0%	-18%	-24%	22%
Kenora (North)	60 Years (3 Life Cycles)	8.5%	\$81,298	\$60,890	\$56,241	v/s	0%	0%	22%	-9%	-12%	0%	-8%	-11%	0%	-17%	-23%	0%	-17%	-23%	22%
North Bay (North)	60 Years (3 Life Cycles)	8.5%	\$77,830	\$57,489	\$50,396	v/s	0%	0%	21%	-8%	-11%	0%	-9%	-12%	0%	-17%	-23%	0%	-17%	-23%	21%
Sault Ste. Marie (North)	60 Years (3 Life Cycles)	8.5%	\$66,862	\$50,525	\$49,974	v/s	0%	0%	22%	-10%	-13%	0%	-10%	-14%	0%	-20%	-26%	0%	-20%	-26%	22%
Sudbury (North)	60 Years (3 Life Cycles)	8.5%	\$78,793	\$58,462	\$54,196	v/s	0%	0%	21%	-8%	-11%	0%	-9%	-12%	0%	-17%	-23%	0%	-17%	-23%	21%
Timmins (North)	60 Years (3 Life Cycles)	8.5%	\$80,424	\$60,087	\$55,060	v/s	0%	0%	23%	-9%	-12%	0%	-9%	-11%	0%	-17%	-23%	0%	-17%	-23%	23%
Thunder Bay (North)	60 Years (3 Life Cycles)	8.5%	\$80,594	\$60,227	\$53,415	v/s	0%	0%	22%	-9%	-12%	0%	-9%	-11%	0%	-17%	-23%	0%	-17%	-23%	22%

Table 10h: % change in present values for comparative scenarios in regards to the main scenario for V.GSHP, H.GSHP (three life cycles) and Traditional HVAC Applications (five life cycles) at a discount rate of 8.5% for average construction scenario

Total Present Value																						
		Main Scenario					v/s	Comparative Scenarios														
		Base Case Scenario			v/s	Carbon Taxes - (#1)			FIT - (#2)			Rebates - (#3)			(FIT+Rebates) - (#4)			(FIT+Rebates) + Carbon Taxes - (#5)				
City	Project Life Span	Discount Rate	V.GSHP	H.GSHP	Traditional	v/s	V.GSHP	H.GSHP	Traditional	V.GSHP	H.GSHP	Traditional	V.GSHP	H.GSHP	Traditional	V.GSHP	H.GSHP	Traditional	V.GSHP	H.GSHP	Traditional	
Cambridge (South)	60 Years (3 Life Cycles)	10%	\$58,386	\$43,263	\$38,721	v/s	\$58,386	\$43,263	\$45,811	\$53,405	\$38,248	\$38,721	\$52,037	\$36,915	\$38,721	\$47,056	\$31,899	\$38,721	\$47,056	\$31,899	\$45,811	
Chatham (South)	60 Years (3 Life Cycles)	10%	\$57,244	\$42,112	\$40,372	v/s	\$57,244	\$42,112	\$46,683	\$52,609	\$37,445	\$40,372	\$50,896	\$35,763	\$40,372	\$46,261	\$31,097	\$40,372	\$46,261	\$31,097	\$46,683	
Guelph (South)	60 Years (3 Life Cycles)	10%	\$58,647	\$43,532	\$39,242	v/s	\$58,647	\$43,532	\$46,560	\$53,586	\$38,435	\$39,242	\$52,298	\$37,184	\$39,242	\$47,238	\$32,087	\$39,242	\$47,238	\$32,087	\$46,560	
Hamilton (South)	60 Years (3 Life Cycles)	10%	\$58,123	\$42,997	\$43,050	v/s	\$58,123	\$42,997	\$49,947	\$53,221	\$38,062	\$43,050	\$51,774	\$36,649	\$43,050	\$46,873	\$31,714	\$43,050	\$46,873	\$31,714	\$49,947	
Kingston (South)	60 Years (3 Life Cycles)	10%	\$69,298	\$44,045	\$46,054	v/s	\$69,298	\$44,045	\$53,420	\$64,189	\$38,792	\$46,054	\$62,950	\$37,697	\$46,054	\$57,841	\$32,444	\$46,054	\$57,841	\$32,444	\$53,420	
Kitchener-Waterloo (South)	60 Years (3 Life Cycles)	10%	\$69,004	\$43,703	\$43,763	v/s	\$69,004	\$43,703	\$51,094	\$63,984	\$38,554	\$43,763	\$62,656	\$37,355	\$43,763	\$57,636	\$32,206	\$43,763	\$57,636	\$32,206	\$51,094	
London (South)	60 Years (3 Life Cycles)	10%	\$58,391	\$43,255	\$41,600	v/s	\$58,391	\$43,255	\$48,666	\$53,408	\$38,242	\$41,600	\$52,042	\$36,906	\$41,600	\$47,060	\$31,893	\$41,600	\$47,060	\$31,893	\$48,666	
Mt. Forest (South)	60 Years (3 Life Cycles)	10%	\$59,159	\$44,038	\$43,727	v/s	\$59,159	\$44,038	\$51,563	\$53,943	\$38,788	\$43,727	\$52,811	\$37,690	\$43,727	\$47,595	\$32,439	\$43,727	\$47,595	\$32,439	\$51,563	
Niagara Falls (South)	60 Years (3 Life Cycles)	10%	\$57,423	\$42,289	\$41,117	v/s	\$57,423	\$42,289	\$47,507	\$52,734	\$37,569	\$41,117	\$51,075	\$35,941	\$41,117	\$46,386	\$31,221	\$41,117	\$46,386	\$31,221	\$47,507	
Sarnia (South)	60 Years (3 Life Cycles)	10%	\$57,149	\$42,005	\$42,374	v/s	\$57,149	\$42,005	\$48,859	\$52,543	\$37,371	\$42,374	\$50,800	\$35,656	\$42,374	\$46,195	\$31,023	\$42,374	\$46,195	\$31,023	\$48,859	
Simcoe (South)	60 Years (3 Life Cycles)	10%	\$57,837	\$42,713	\$42,512	v/s	\$57,837	\$42,713	\$49,233	\$53,022	\$37,864	\$42,512	\$51,489	\$36,364	\$42,512	\$46,674	\$31,516	\$42,512	\$46,674	\$31,516	\$49,233	
St. Catharines (South)	60 Years (3 Life Cycles)	10%	\$56,768	\$41,635	\$42,132	v/s	\$56,768	\$41,635	\$48,352	\$52,277	\$37,114	\$42,132	\$50,419	\$35,287	\$42,132	\$45,929	\$30,765	\$42,132	\$45,929	\$30,765	\$48,352	
Toronto (South)	60 Years (3 Life Cycles)	10%	\$58,402	\$43,288	\$42,594	v/s	\$58,402	\$43,288	\$49,699	\$53,416	\$38,265	\$42,594	\$52,054	\$36,939	\$42,594	\$47,068	\$31,916	\$42,594	\$47,068	\$31,916	\$49,699	
Trenton (South)	60 Years (3 Life Cycles)	10%	\$58,634	\$43,493	\$45,681	v/s	\$58,634	\$43,493	\$52,835	\$53,577	\$38,408	\$45,681	\$52,285	\$37,145	\$45,681	\$47,229	\$32,059	\$45,681	\$47,229	\$32,059	\$52,835	
Warton (South)	60 Years (3 Life Cycles)	10%	\$69,443	\$44,162	\$44,618	v/s	\$69,443	\$44,162	\$52,232	\$64,290	\$38,873	\$44,618	\$63,094	\$37,813	\$44,618	\$57,942	\$32,525	\$44,618	\$57,942	\$32,525	\$52,232	
Windsor (South)	60 Years (3 Life Cycles)	10%	\$57,262	\$42,135	\$40,406	v/s	\$57,262	\$42,135	\$46,734	\$52,622	\$37,461	\$40,406	\$50,914	\$35,786	\$40,406	\$46,274	\$31,113	\$40,406	\$46,274	\$31,113	\$46,734	
Barrie (Distinct)	60 Years (3 Life Cycles)	10%	\$69,201	\$50,325	\$42,234	v/s	\$69,201	\$50,325	\$49,517	\$64,122	\$45,195	\$42,234	\$62,853	\$43,977	\$42,234	\$57,773	\$38,846	\$42,234	\$57,773	\$38,846	\$49,517	
Muskoka (Distinct)	60 Years (3 Life Cycles)	10%	\$69,942	\$51,069	\$43,718	v/s	\$69,942	\$51,069	\$51,548	\$64,638	\$45,713	\$43,718	\$63,594	\$44,721	\$43,718	\$58,290	\$39,365	\$43,718	\$58,290	\$39,365	\$51,548	
Ottawa (Distinct)	60 Years (3 Life Cycles)	10%	\$69,423	\$50,593	\$43,273	v/s	\$69,423	\$50,593	\$50,743	\$64,276	\$45,381	\$43,273	\$63,074	\$44,245	\$43,273	\$57,928	\$39,033	\$43,273	\$57,928	\$39,033	\$50,743	
Peterborough (Distinct)	60 Years (3 Life Cycles)	10%	\$69,786	\$50,951	\$43,804	v/s	\$69,786	\$50,951	\$51,486	\$64,529	\$45,631	\$43,804	\$63,438	\$44,603	\$43,804	\$58,181	\$39,282	\$43,804	\$58,181	\$39,282	\$51,486	
Kapuskasing (North)	60 Years (3 Life Cycles)	10%	\$73,863	\$55,015	\$51,381	v/s	\$73,863	\$55,015	\$61,144	\$67,369	\$48,462	\$51,381	\$67,515	\$48,667	\$51,381	\$61,021	\$42,113	\$51,381	\$61,021	\$42,113	\$61,144	
Kenora (North)	60 Years (3 Life Cycles)	10%	\$73,030	\$54,171	\$48,360	v/s	\$73,030	\$54,171	\$57,478	\$66,789	\$47,873	\$48,360	\$66,682	\$47,822	\$48,360	\$60,441	\$41,525	\$48,360	\$60,441	\$41,525	\$57,478	
North Bay (North)	60 Years (3 Life Cycles)	10%	\$70,091	\$51,290	\$43,378	v/s	\$70,091	\$51,290	\$51,266	\$64,742	\$45,866	\$43,378	\$63,743	\$44,941	\$43,378	\$58,394	\$39,518	\$43,378	\$58,394	\$39,518	\$51,266	
Sault Ste. Marie (North)	60 Years (3 Life Cycles)	10%	\$59,969	\$44,873	\$42,972	v/s	\$59,969	\$44,873	\$51,020	\$54,508	\$39,369	\$42,972	\$53,621	\$38,524	\$42,972	\$48,159	\$33,021	\$42,972	\$48,159	\$33,021	\$51,020	
Sudbury (North)	60 Years (3 Life Cycles)	10%	\$70,908	\$52,114	\$46,635	v/s	\$70,908	\$52,114	\$55,134	\$65,311	\$46,441	\$46,635	\$64,559	\$45,766	\$46,635	\$58,962	\$40,093	\$46,635	\$58,962	\$40,093	\$55,134	
Timmins (North)	60 Years (3 Life Cycles)	10%	\$72,289	\$53,491	\$47,310	v/s	\$72,289	\$53,491	\$56,734	\$66,273	\$47,400	\$47,310	\$65,941	\$47,142	\$47,310	\$59,925	\$41,051	\$47,310	\$59,925	\$41,051	\$56,734	
Thunder Bay (North)	60 Years (3 Life Cycles)	10%	\$72,434	\$53,609	\$45,921	v/s	\$72,434	\$53,609	\$54,909	\$66,374	\$47,482	\$45,921	\$66,085	\$47,261	\$45,921	\$60,025	\$41,134	\$45,921	\$60,025	\$41,134	\$54,909	

Table 10i: Rankings of the Cities Based on present values for V.GSHP, H.GSHP (three life cycles) and Traditional HVAC Applications (five life cycles) at a discount rate of 10% for average construction scenario

		Total Present Value																				
		Main Scenario					v/s	Comparative Scenarios														
		Base Case Scenario			v/s	Carbon Taxes - (#1)			FIT - (#2)			Rebates - (#3)			(FIT+Rebates) - (#4)			(FIT+Rebates) + Carbon Taxes - (#5)				
City	Project Life Span	Discount Rate	V.GSHP	H.GSHP	Traditional	v/s	V.GSHP	H.GSHP	Traditional	V.GSHP	H.GSHP	Traditional	V.GSHP	H.GSHP	Traditional	V.GSHP	H.GSHP	Traditional	V.GSHP	H.GSHP	Traditional	
Cambridge (South)	60 Years (3 Life Cycles)	10%	\$58,386	\$43,263	\$38,721	v/s	0%	0%	18%	-9%	-12%	0%	-11%	-15%	0%	-19%	-26%	0%	-19%	-26%	18%	
Chatham (South)	60 Years (3 Life Cycles)	10%	\$57,244	\$42,112	\$40,372	v/s	0%	0%	16%	-8%	-11%	0%	-11%	-15%	0%	-19%	-26%	0%	-19%	-26%	16%	
Guelph (South)	60 Years (3 Life Cycles)	10%	\$58,647	\$43,532	\$39,242	v/s	0%	0%	19%	-9%	-12%	0%	-11%	-15%	0%	-19%	-26%	0%	-19%	-26%	19%	
Hamilton (South)	60 Years (3 Life Cycles)	10%	\$58,123	\$42,997	\$43,050	v/s	0%	0%	16%	-8%	-11%	0%	-11%	-15%	0%	-19%	-26%	0%	-19%	-26%	16%	
Kingston (South)	60 Years (3 Life Cycles)	10%	\$69,298	\$44,045	\$46,054	v/s	0%	0%	16%	-7%	-12%	0%	-9%	-14%	0%	-17%	-26%	0%	-17%	-26%	16%	
Kitchener-Waterloo (South)	60 Years (3 Life Cycles)	10%	\$69,004	\$43,703	\$43,763	v/s	0%	0%	17%	-7%	-12%	0%	-9%	-15%	0%	-16%	-26%	0%	-16%	-26%	17%	
London (South)	60 Years (3 Life Cycles)	10%	\$58,391	\$43,255	\$41,600	v/s	0%	0%	17%	-9%	-12%	0%	-11%	-15%	0%	-19%	-26%	0%	-19%	-26%	17%	
Mt. Forest (South)	60 Years (3 Life Cycles)	10%	\$59,159	\$44,038	\$43,727	v/s	0%	0%	18%	-9%	-12%	0%	-11%	-14%	0%	-20%	-26%	0%	-20%	-26%	18%	
Niagara Falls (South)	60 Years (3 Life Cycles)	10%	\$57,423	\$42,289	\$41,117	v/s	0%	0%	16%	-8%	-11%	0%	-11%	-15%	0%	-19%	-26%	0%	-19%	-26%	16%	
Sarnia (South)	60 Years (3 Life Cycles)	10%	\$57,149	\$42,005	\$42,374	v/s	0%	0%	15%	-8%	-11%	0%	-11%	-15%	0%	-19%	-26%	0%	-19%	-26%	15%	
Simcoe (South)	60 Years (3 Life Cycles)	10%	\$57,837	\$42,713	\$42,512	v/s	0%	0%	16%	-8%	-11%	0%	-11%	-15%	0%	-19%	-26%	0%	-19%	-26%	16%	
St. Catharines (South)	60 Years (3 Life Cycles)	10%	\$56,768	\$41,635	\$42,132	v/s	0%	0%	15%	-8%	-11%	0%	-11%	-15%	0%	-19%	-26%	0%	-19%	-26%	15%	
Toronto (South)	60 Years (3 Life Cycles)	10%	\$58,402	\$43,288	\$42,594	v/s	0%	0%	17%	-9%	-12%	0%	-11%	-15%	0%	-19%	-26%	0%	-19%	-26%	17%	
Trenton (South)	60 Years (3 Life Cycles)	10%	\$58,634	\$43,493	\$45,681	v/s	0%	0%	16%	-9%	-12%	0%	-11%	-15%	0%	-19%	-26%	0%	-19%	-26%	16%	
Warton (South)	60 Years (3 Life Cycles)	10%	\$69,443	\$44,162	\$44,618	v/s	0%	0%	17%	-7%	-12%	0%	-9%	-14%	0%	-17%	-26%	0%	-17%	-26%	17%	
Windsor (South)	60 Years (3 Life Cycles)	10%	\$57,262	\$42,135	\$40,406	v/s	0%	0%	16%	-8%	-11%	0%	-11%	-15%	0%	-19%	-26%	0%	-19%	-26%	16%	
Barrie (Distinct)	60 Years (3 Life Cycles)	10%	\$69,201	\$50,325	\$42,234	v/s	0%	0%	17%	-7%	-10%	0%	-9%	-13%	0%	-17%	-23%	0%	-17%	-23%	17%	
Muskoka (Distinct)	60 Years (3 Life Cycles)	10%	\$69,942	\$51,069	\$43,718	v/s	0%	0%	18%	-8%	-10%	0%	-9%	-12%	0%	-17%	-23%	0%	-17%	-23%	18%	
Ottawa (Distinct)	60 Years (3 Life Cycles)	10%	\$69,423	\$50,593	\$43,273	v/s	0%	0%	17%	-7%	-10%	0%	-9%	-13%	0%	-17%	-23%	0%	-17%	-23%	17%	
Peterborough (Distinct)	60 Years (3 Life Cycles)	10%	\$69,786	\$50,951	\$43,804	v/s	0%	0%	18%	-8%	-10%	0%	-9%	-12%	0%	-17%	-23%	0%	-17%	-23%	18%	
Kapuskasing (North)	60 Years (3 Life Cycles)	10%	\$73,863	\$55,015	\$51,381	v/s	0%	0%	19%	-9%	-12%	0%	-9%	-12%	0%	-17%	-23%	0%	-17%	-23%	19%	
Kenora (North)	60 Years (3 Life Cycles)	10%	\$73,030	\$54,171	\$48,360	v/s	0%	0%	19%	-9%	-12%	0%	-9%	-12%	0%	-17%	-23%	0%	-17%	-23%	19%	
North Bay (North)	60 Years (3 Life Cycles)	10%	\$70,091	\$51,290	\$43,378	v/s	0%	0%	18%	-8%	-11%	0%	-9%	-12%	0%	-17%	-23%	0%	-17%	-23%	18%	
Sault Ste. Marie (North)	60 Years (3 Life Cycles)	10%	\$59,969	\$44,873	\$42,972	v/s	0%	0%	19%	-9%	-12%	0%	-11%	-14%	0%	-20%	-26%	0%	-20%	-26%	19%	
Sudbury (North)	60 Years (3 Life Cycles)	10%	\$70,908	\$52,114	\$46,635	v/s	0%	0%	18%	-8%	-11%	0%	-9%	-12%	0%	-17%	-23%	0%	-17%	-23%	18%	
Timmins (North)	60 Years (3 Life Cycles)	10%	\$72,289	\$53,491	\$47,310	v/s	0%	0%	20%	-8%	-11%	0%	-9%	-12%	0%	-17%	-23%	0%	-17%	-23%	20%	
Thunder Bay (North)	60 Years (3 Life Cycles)	10%	\$72,434	\$53,609	\$45,921	v/s	0%	0%	20%	-8%	-11%	0%	-9%	-12%	0%	-17%	-23%	0%	-17%	-23%	20%	

Table 10j: % change in present values for comparative scenarios in regards to the main scenario for V.GSHP, H.GSHP (three life cycles) and Traditional HVAC Applications (five life cycles) at a discount rate of 10% for average construction scenario

			Total Present Value																		
			Main Scenario					v/s	Comparative Scenarios												
			Base Case Scenario			v/s	Carbon Taxes - (€1)			FIT - (€2)			Rebates - (€3)			(FIT+Rebates) - (€4)			(FIT+Rebates) + Carbon Taxes - (€5)		
City	Project Life Span	Discount Rate	V.GSHP	H.GSHP	Traditional	v/s	V.GSHP	H.GSHP	Traditional	V.GSHP	H.GSHP	Traditional	V.GSHP	H.GSHP	Traditional	V.GSHP	H.GSHP	Traditional	V.GSHP	H.GSHP	Traditional
Cambridge (South)	60 Years (3 Life Cycles)	12%	\$52,385	\$38,346	\$32,921	v/s	\$52,385	\$38,346	\$38,000	\$48,225	\$34,157	\$32,921	\$46,497	\$32,457	\$32,921	\$42,337	\$28,269	\$32,921	\$42,337	\$28,269	\$38,000
Chatham (South)	60 Years (3 Life Cycles)	12%	\$51,439	\$37,392	\$34,358	v/s	\$51,439	\$37,392	\$38,879	\$47,569	\$33,495	\$34,358	\$45,550	\$31,503	\$34,358	\$41,680	\$27,606	\$34,358	\$41,680	\$27,606	\$38,879
Guelph (South)	60 Years (3 Life Cycles)	12%	\$52,602	\$38,569	\$33,350	v/s	\$52,602	\$38,569	\$38,593	\$48,376	\$34,312	\$33,350	\$46,713	\$32,680	\$33,350	\$42,487	\$28,424	\$33,350	\$42,487	\$28,424	\$38,593
Hamilton (South)	60 Years (3 Life Cycles)	12%	\$52,168	\$38,126	\$36,631	v/s	\$52,168	\$38,126	\$41,572	\$48,074	\$34,004	\$36,631	\$46,279	\$32,237	\$36,631	\$42,185	\$28,115	\$36,631	\$42,185	\$28,115	\$41,572
Kingston (South)	60 Years (3 Life Cycles)	12%	\$62,429	\$38,994	\$39,235	v/s	\$62,429	\$38,994	\$44,512	\$58,162	\$34,607	\$39,235	\$56,540	\$33,105	\$39,235	\$52,273	\$28,718	\$39,235	\$52,273	\$28,718	\$44,512
Kitchener-Waterloo (South)	60 Years (3 Life Cycles)	12%	\$62,185	\$38,711	\$37,217	v/s	\$62,185	\$38,711	\$42,469	\$57,993	\$34,411	\$37,217	\$56,296	\$32,822	\$37,217	\$52,104	\$28,522	\$37,217	\$52,104	\$28,522	\$42,469
London (South)	60 Years (3 Life Cycles)	12%	\$52,390	\$38,339	\$35,367	v/s	\$52,390	\$38,339	\$40,429	\$48,228	\$34,153	\$35,367	\$46,501	\$32,450	\$35,367	\$42,339	\$28,264	\$35,367	\$42,339	\$28,264	\$40,429
Mt. Forest (South)	60 Years (3 Life Cycles)	12%	\$53,027	\$38,989	\$37,181	v/s	\$53,027	\$38,989	\$42,795	\$48,671	\$34,604	\$37,181	\$47,138	\$33,100	\$37,181	\$42,782	\$28,715	\$37,181	\$42,782	\$28,715	\$42,795
Niagara Falls (South)	60 Years (3 Life Cycles)	12%	\$51,588	\$37,539	\$34,974	v/s	\$51,588	\$37,539	\$39,552	\$47,672	\$33,597	\$34,974	\$45,699	\$31,650	\$34,974	\$41,783	\$27,708	\$34,974	\$41,783	\$27,708	\$39,552
Sarnia (South)	60 Years (3 Life Cycles)	12%	\$51,360	\$37,303	\$36,075	v/s	\$51,360	\$37,303	\$40,721	\$47,514	\$33,433	\$36,075	\$45,472	\$31,414	\$36,075	\$41,625	\$27,545	\$36,075	\$41,625	\$27,545	\$40,721
Simcoe (South)	60 Years (3 Life Cycles)	12%	\$51,931	\$37,890	\$36,186	v/s	\$51,931	\$37,890	\$41,002	\$47,910	\$33,841	\$36,186	\$46,042	\$32,001	\$36,186	\$42,021	\$27,952	\$36,186	\$42,021	\$27,952	\$41,002
St. Catharines (South)	60 Years (3 Life Cycles)	12%	\$51,045	\$36,997	\$35,877	v/s	\$51,045	\$36,997	\$40,334	\$47,295	\$33,221	\$35,877	\$45,156	\$31,108	\$35,877	\$41,406	\$27,332	\$35,877	\$41,406	\$27,332	\$40,334
Toronto (South)	60 Years (3 Life Cycles)	12%	\$52,399	\$38,367	\$36,250	v/s	\$52,399	\$38,367	\$41,340	\$48,235	\$34,172	\$36,250	\$46,510	\$32,478	\$36,250	\$42,346	\$28,283	\$36,250	\$42,346	\$28,283	\$41,340
Trenton (South)	60 Years (3 Life Cycles)	12%	\$52,591	\$38,537	\$38,928	v/s	\$52,591	\$38,537	\$44,053	\$48,368	\$34,290	\$38,928	\$46,702	\$32,648	\$38,928	\$42,479	\$28,401	\$38,928	\$42,479	\$28,401	\$44,053
Warton (South)	60 Years (3 Life Cycles)	12%	\$62,549	\$39,091	\$37,982	v/s	\$62,549	\$39,091	\$43,437	\$58,245	\$34,674	\$37,982	\$56,660	\$33,202	\$37,982	\$52,357	\$28,786	\$37,982	\$52,357	\$28,786	\$43,437
Windsor (South)	60 Years (3 Life Cycles)	12%	\$51,454	\$37,411	\$34,386	v/s	\$51,454	\$37,411	\$38,919	\$47,579	\$33,508	\$34,386	\$45,565	\$31,522	\$34,386	\$41,690	\$27,619	\$34,386	\$41,690	\$27,619	\$38,919
Barrie (Distinct)	60 Years (3 Life Cycles)	12%	\$62,348	\$44,822	\$35,950	v/s	\$62,348	\$44,822	\$41,168	\$58,107	\$40,537	\$35,950	\$56,460	\$38,933	\$35,950	\$52,218	\$34,648	\$35,950	\$52,218	\$34,648	\$41,168
Muskoka (Distinct)	60 Years (3 Life Cycles)	12%	\$62,962	\$45,439	\$37,174	v/s	\$62,962	\$45,439	\$42,784	\$58,533	\$40,965	\$37,174	\$57,074	\$39,550	\$37,174	\$52,644	\$35,077	\$37,174	\$52,644	\$35,077	\$42,784
Ottawa (Distinct)	60 Years (3 Life Cycles)	12%	\$62,532	\$45,044	\$36,809	v/s	\$62,532	\$45,044	\$42,161	\$58,234	\$40,691	\$36,809	\$56,643	\$39,155	\$36,809	\$52,345	\$34,802	\$36,809	\$52,345	\$34,802	\$42,161
Peterborough (Distinct)	60 Years (3 Life Cycles)	12%	\$62,833	\$45,341	\$37,246	v/s	\$62,833	\$45,341	\$42,750	\$58,443	\$40,897	\$37,246	\$56,944	\$39,452	\$37,246	\$52,554	\$35,008	\$37,246	\$52,554	\$35,008	\$42,750
Kapuskasing (North)	60 Years (3 Life Cycles)	12%	\$66,212	\$48,709	\$43,622	v/s	\$66,212	\$48,709	\$50,617	\$60,789	\$43,236	\$43,622	\$60,323	\$42,820	\$43,622	\$54,900	\$37,347	\$43,622	\$54,900	\$37,347	\$50,617
Kenora (North)	60 Years (3 Life Cycles)	12%	\$65,522	\$48,009	\$41,066	v/s	\$65,522	\$48,009	\$47,599	\$60,310	\$42,750	\$41,066	\$59,633	\$42,120	\$41,066	\$54,421	\$36,861	\$41,066	\$54,421	\$36,861	\$47,599
North Bay (North)	60 Years (3 Life Cycles)	12%	\$63,086	\$45,621	\$36,891	v/s	\$63,086	\$45,621	\$42,542	\$58,619	\$41,092	\$36,891	\$57,197	\$39,732	\$36,891	\$52,730	\$35,203	\$36,891	\$52,730	\$35,203	\$42,542
Sault Ste. Marie (North)	60 Years (3 Life Cycles)	12%	\$53,698	\$39,680	\$36,493	v/s	\$53,698	\$39,680	\$42,259	\$49,137	\$35,084	\$36,493	\$47,809	\$33,791	\$36,493	\$43,248	\$29,195	\$36,493	\$43,248	\$29,195	\$42,259
Sudbury (North)	60 Years (3 Life Cycles)	12%	\$63,763	\$46,305	\$39,644	v/s	\$63,763	\$46,305	\$45,732	\$59,088	\$41,566	\$39,644	\$57,874	\$40,416	\$39,644	\$53,200	\$35,678	\$39,644	\$53,200	\$35,678	\$45,732
Timmins (North)	60 Years (3 Life Cycles)	12%	\$64,908	\$47,445	\$40,132	v/s	\$64,908	\$47,445	\$46,884	\$59,883	\$42,358	\$40,132	\$59,019	\$41,556	\$40,132	\$53,994	\$36,470	\$40,132	\$53,994	\$36,470	\$46,884
Thunder Bay (North)	60 Years (3 Life Cycles)	12%	\$65,027	\$47,543	\$38,986	v/s	\$65,027	\$47,543	\$45,425	\$59,966	\$42,427	\$38,986	\$59,139	\$41,654	\$38,986	\$54,078	\$36,538	\$38,986	\$54,078	\$36,538	\$45,425

Table 10k: Rankings of the Cities Based on present values for V.GSHP, H.GSHP (three life cycles) and Traditional HVAC Applications (five life cycles) at a discount rate of 12% for average construction scenario

Total Present Value																						
		Main Scenario					v/s	Comparative Scenarios														
		Base Case Scenario			v/s	Carbon Taxes - (€1)			FIT - (€2)			Rebates - (€3)			(FIT+Rebates) - (€4)			(FIT+Rebates) + Carbon Taxes - (€5)				
City	Project Life Span	Discount Rate	V.GSHP	H.GSHP	Traditional	v/s	V.GSHP	H.GSHP	Traditional	V.GSHP	H.GSHP	Traditional	V.GSHP	H.GSHP	Traditional	V.GSHP	H.GSHP	Traditional	V.GSHP	H.GSHP	Traditional	
Cambridge (South)	60 Years (3 Life Cycles)	12%	\$52,385	\$38,346	\$32,921	v/s	0%	0%	15%	-8%	-11%	0%	-11%	-15%	0%	-19%	-26%	0%	-19%	-26%	15%	
Chatham (South)	60 Years (3 Life Cycles)	12%	\$51,439	\$37,392	\$34,358	v/s	0%	0%	13%	-8%	-10%	0%	-11%	-16%	0%	-19%	-26%	0%	-19%	-26%	13%	
Guelph (South)	60 Years (3 Life Cycles)	12%	\$52,602	\$38,569	\$33,350	v/s	0%	0%	16%	-8%	-11%	0%	-11%	-15%	0%	-19%	-26%	0%	-19%	-26%	16%	
Hamilton (South)	60 Years (3 Life Cycles)	12%	\$52,168	\$38,126	\$36,631	v/s	0%	0%	13%	-8%	-11%	0%	-11%	-15%	0%	-19%	-26%	0%	-19%	-26%	13%	
Kingston (South)	60 Years (3 Life Cycles)	12%	\$62,429	\$38,994	\$39,235	v/s	0%	0%	13%	-7%	-11%	0%	-9%	-15%	0%	-16%	-26%	0%	-16%	-26%	13%	
Kitchener-Waterloo (South)	60 Years (3 Life Cycles)	12%	\$62,185	\$38,711	\$37,217	v/s	0%	0%	14%	-7%	-11%	0%	-9%	-15%	0%	-16%	-26%	0%	-16%	-26%	14%	
London (South)	60 Years (3 Life Cycles)	12%	\$52,390	\$38,339	\$35,367	v/s	0%	0%	14%	-8%	-11%	0%	-11%	-15%	0%	-19%	-26%	0%	-19%	-26%	14%	
Mt. Forest (South)	60 Years (3 Life Cycles)	12%	\$53,027	\$38,989	\$37,181	v/s	0%	0%	15%	-8%	-11%	0%	-11%	-15%	0%	-19%	-26%	0%	-19%	-26%	15%	
Niagara Falls (South)	60 Years (3 Life Cycles)	12%	\$51,588	\$37,539	\$34,974	v/s	0%	0%	13%	-8%	-11%	0%	-11%	-16%	0%	-19%	-26%	0%	-19%	-26%	13%	
Sarnia (South)	60 Years (3 Life Cycles)	12%	\$51,360	\$37,303	\$36,075	v/s	0%	0%	13%	-7%	-10%	0%	-11%	-16%	0%	-19%	-26%	0%	-19%	-26%	13%	
Simcoe (South)	60 Years (3 Life Cycles)	12%	\$51,931	\$37,890	\$36,186	v/s	0%	0%	13%	-8%	-11%	0%	-11%	-16%	0%	-19%	-26%	0%	-19%	-26%	13%	
St. Catharines (South)	60 Years (3 Life Cycles)	12%	\$51,045	\$36,997	\$35,877	v/s	0%	0%	12%	-7%	-10%	0%	-12%	-16%	0%	-19%	-26%	0%	-19%	-26%	12%	
Toronto (South)	60 Years (3 Life Cycles)	12%	\$52,399	\$38,367	\$36,250	v/s	0%	0%	14%	-8%	-11%	0%	-11%	-15%	0%	-19%	-26%	0%	-19%	-26%	14%	
Trenton (South)	60 Years (3 Life Cycles)	12%	\$52,591	\$38,537	\$38,928	v/s	0%	0%	13%	-8%	-11%	0%	-11%	-15%	0%	-19%	-26%	0%	-19%	-26%	13%	
Warton (South)	60 Years (3 Life Cycles)	12%	\$62,549	\$39,091	\$37,982	v/s	0%	0%	14%	-7%	-11%	0%	-9%	-15%	0%	-16%	-26%	0%	-16%	-26%	14%	
Windsor (South)	60 Years (3 Life Cycles)	12%	\$51,454	\$37,411	\$34,386	v/s	0%	0%	13%	-8%	-10%	0%	-11%	-16%	0%	-19%	-26%	0%	-19%	-26%	13%	
Barrie (Distinct)	60 Years (3 Life Cycles)	12%	\$62,348	\$44,822	\$35,950	v/s	0%	0%	15%	-7%	-10%	0%	-9%	-13%	0%	-16%	-23%	0%	-16%	-23%	15%	
Muskoka (Distinct)	60 Years (3 Life Cycles)	12%	\$62,962	\$45,439	\$37,174	v/s	0%	0%	15%	-7%	-10%	0%	-9%	-13%	0%	-16%	-23%	0%	-16%	-23%	15%	
Ottawa (Distinct)	60 Years (3 Life Cycles)	12%	\$62,532	\$45,044	\$36,809	v/s	0%	0%	15%	-7%	-10%	0%	-9%	-13%	0%	-16%	-23%	0%	-16%	-23%	15%	
Peterborough (Distinct)	60 Years (3 Life Cycles)	12%	\$62,833	\$45,341	\$37,246	v/s	0%	0%	15%	-7%	-10%	0%	-9%	-13%	0%	-16%	-23%	0%	-16%	-23%	15%	
Kapuskasing (North)	60 Years (3 Life Cycles)	12%	\$66,212	\$48,709	\$43,622	v/s	0%	0%	16%	-8%	-11%	0%	-9%	-12%	0%	-17%	-23%	0%	-17%	-23%	16%	
Kenora (North)	60 Years (3 Life Cycles)	12%	\$65,522	\$48,009	\$41,066	v/s	0%	0%	16%	-8%	-11%	0%	-9%	-12%	0%	-17%	-23%	0%	-17%	-23%	16%	
North Bay (North)	60 Years (3 Life Cycles)	12%	\$63,086	\$45,621	\$36,891	v/s	0%	0%	15%	-7%	-10%	0%	-9%	-13%	0%	-16%	-23%	0%	-16%	-23%	15%	
Sault Ste. Marie (North)	60 Years (3 Life Cycles)	12%	\$53,698	\$39,680	\$36,493	v/s	0%	0%	16%	-8%	-12%	0%	-11%	-15%	0%	-19%	-26%	0%	-19%	-26%	16%	
Sudbury (North)	60 Years (3 Life Cycles)	12%	\$63,763	\$46,305	\$39,644	v/s	0%	0%	15%	-7%	-10%	0%	-9%	-13%	0%	-17%	-23%	0%	-17%	-23%	15%	
Timmins (North)	60 Years (3 Life Cycles)	12%	\$64,908	\$47,445	\$40,132	v/s	0%	0%	17%	-8%	-11%	0%	-9%	-12%	0%	-17%	-23%	0%	-17%	-23%	17%	
Thunder Bay (North)	60 Years (3 Life Cycles)	12%	\$65,027	\$47,543	\$38,986	v/s	0%	0%	17%	-8%	-11%	0%	-9%	-12%	0%	-17%	-23%	0%	-17%	-23%	17%	

Table 10l: % change in present values for comparative scenarios in regards to the main scenario for V.GSHP, H.GSHP (three life cycles) and Traditional HVAC Applications (five life cycles) at a discount rate of 12% for average construction scenario

			Total Present Value																		
			Main Scenario				v/s	Comparative Scenarios													
			Base Case Scenario			v/s	Carbon Taxes - (#1)			FIT - (#2)			Rebates - (#3)			(FIT+Rebates) - (#4)			(FIT+Rebates) + Carbon Taxes - (#5)		
City	Project Life Span	Discount Rate	V.GSHP	H.GSHP	Traditional	v/s	V.GSHP	H.GSHP	Traditional	V.GSHP	H.GSHP	Traditional	V.GSHP	H.GSHP	Traditional	V.GSHP	H.GSHP	Traditional	V.GSHP	H.GSHP	Traditional
Cambridge (South)	60 Years (2 Life Cycles)	5%	\$64,960	\$52,427	\$64,147	v/s	\$64,960	\$52,427	\$82,660	\$56,518	\$43,914	\$64,147	\$57,865	\$45,331	\$64,147	\$49,422	\$36,819	\$64,147	\$49,422	\$36,819	\$82,660
Chatham (South)	60 Years (2 Life Cycles)	5%	\$63,129	\$50,586	\$69,170	v/s	\$63,129	\$50,586	\$85,813	\$55,224	\$42,614	\$69,170	\$56,034	\$43,491	\$69,170	\$48,129	\$35,519	\$69,170	\$48,129	\$35,519	\$85,813
Guelph (South)	60 Years (2 Life Cycles)	5%	\$65,321	\$52,788	\$65,014	v/s	\$65,321	\$52,788	\$84,076	\$56,773	\$44,170	\$65,014	\$58,226	\$45,693	\$65,014	\$49,677	\$37,074	\$65,014	\$49,677	\$37,074	\$84,076
Hamilton (South)	60 Years (2 Life Cycles)	5%	\$64,483	\$51,950	\$72,055	v/s	\$64,483	\$51,950	\$90,098	\$56,181	\$43,577	\$72,055	\$57,388	\$44,854	\$72,055	\$49,085	\$36,482	\$72,055	\$49,085	\$36,482	\$90,098
Kingston (South)	60 Years (2 Life Cycles)	5%	\$79,085	\$62,301	\$77,445	v/s	\$79,085	\$62,301	\$96,658	\$70,039	\$53,183	\$77,445	\$71,990	\$55,206	\$77,445	\$62,944	\$46,087	\$77,445	\$62,944	\$46,087	\$96,658
Kitchener-Waterloo (South)	60 Years (2 Life Cycles)	5%	\$78,537	\$61,753	\$73,273	v/s	\$78,537	\$61,753	\$92,377	\$69,652	\$52,796	\$73,273	\$71,442	\$54,657	\$73,273	\$62,556	\$45,700	\$73,273	\$62,556	\$45,700	\$92,377
London (South)	60 Years (2 Life Cycles)	5%	\$64,967	\$52,408	\$68,258	v/s	\$64,967	\$52,408	\$86,771	\$56,522	\$43,901	\$68,258	\$57,871	\$45,312	\$68,258	\$49,427	\$36,805	\$68,258	\$49,427	\$36,805	\$86,771
Mt. Forest (South)	60 Years (2 Life Cycles)	5%	\$78,757	\$53,426	\$72,977	v/s	\$78,757	\$53,426	\$93,276	\$69,807	\$44,620	\$72,977	\$71,661	\$46,331	\$72,977	\$62,711	\$37,525	\$72,977	\$62,711	\$37,525	\$93,276
Niagara Falls (South)	60 Years (2 Life Cycles)	5%	\$63,490	\$50,957	\$70,716	v/s	\$63,490	\$50,957	\$87,552	\$55,479	\$42,876	\$70,716	\$56,395	\$43,861	\$70,716	\$48,384	\$35,781	\$70,716	\$48,384	\$35,781	\$87,552
Sarnia (South)	60 Years (2 Life Cycles)	5%	\$62,823	\$50,241	\$69,792	v/s	\$62,823	\$50,241	\$86,791	\$55,008	\$42,370	\$69,792	\$55,728	\$43,146	\$69,792	\$47,913	\$35,275	\$69,792	\$47,913	\$35,275	\$86,791
Simcoe (South)	60 Years (2 Life Cycles)	5%	\$64,055	\$51,521	\$72,880	v/s	\$64,055	\$51,521	\$90,524	\$55,878	\$43,275	\$72,880	\$56,959	\$44,426	\$72,880	\$48,782	\$36,179	\$72,880	\$48,782	\$36,179	\$90,524
St. Catharines (South)	60 Years (2 Life Cycles)	5%	\$75,210	\$49,645	\$70,967	v/s	\$75,210	\$49,645	\$87,260	\$67,302	\$41,949	\$70,967	\$68,115	\$42,549	\$70,967	\$60,206	\$34,854	\$70,967	\$60,206	\$34,854	\$87,260
Toronto (South)	60 Years (2 Life Cycles)	5%	\$77,934	\$52,462	\$71,183	v/s	\$77,934	\$52,462	\$89,732	\$69,226	\$43,940	\$71,183	\$70,839	\$45,367	\$71,183	\$62,131	\$36,844	\$71,183	\$62,131	\$36,844	\$89,732
Trenton (South)	60 Years (2 Life Cycles)	5%	\$78,221	\$61,408	\$76,803	v/s	\$78,221	\$61,408	\$95,472	\$69,429	\$52,552	\$76,803	\$71,126	\$54,313	\$76,803	\$62,333	\$45,456	\$76,803	\$62,333	\$45,456	\$95,472
Warton (South)	60 Years (2 Life Cycles)	5%	\$79,330	\$62,511	\$74,750	v/s	\$79,330	\$62,511	\$94,554	\$70,212	\$53,331	\$74,750	\$72,235	\$55,415	\$74,750	\$63,117	\$46,235	\$74,750	\$63,117	\$46,235	\$94,554
Windsor (South)	60 Years (2 Life Cycles)	5%	\$63,152	\$50,622	\$69,226	v/s	\$63,152	\$50,622	\$85,911	\$55,240	\$42,639	\$69,226	\$56,056	\$43,526	\$69,226	\$48,145	\$35,544	\$69,226	\$48,145	\$35,544	\$85,911
Barrie (Distinct)	60 Years (2 Life Cycles)	5%	\$78,863	\$62,033	\$67,268	v/s	\$78,863	\$62,033	\$86,022	\$69,882	\$52,994	\$67,268	\$71,767	\$54,938	\$67,268	\$62,786	\$45,898	\$67,268	\$62,786	\$45,898	\$86,022
Muskoka (Distinct)	60 Years (2 Life Cycles)	5%	\$79,898	\$63,068	\$69,707	v/s	\$79,898	\$63,068	\$89,770	\$70,613	\$53,725	\$69,707	\$72,802	\$55,973	\$69,707	\$63,517	\$46,629	\$69,707	\$63,517	\$46,629	\$89,770
Ottawa (Distinct)	60 Years (2 Life Cycles)	5%	\$78,950	\$62,162	\$71,833	v/s	\$78,950	\$62,162	\$91,015	\$69,943	\$53,085	\$71,833	\$71,854	\$55,067	\$71,833	\$62,848	\$45,989	\$71,833	\$62,848	\$45,989	\$91,015
Peterborough (Distinct)	60 Years (2 Life Cycles)	5%	\$79,717	\$62,930	\$72,966	v/s	\$79,717	\$62,930	\$92,963	\$70,485	\$53,627	\$72,966	\$72,622	\$55,834	\$72,966	\$63,390	\$46,531	\$72,966	\$63,390	\$46,531	\$92,963
Kapuskasing (North)	60 Years (2 Life Cycles)	5%	\$84,975	\$68,175	\$85,695	v/s	\$84,975	\$68,175	\$110,379	\$74,200	\$57,332	\$85,695	\$77,880	\$61,079	\$85,695	\$67,104	\$50,236	\$85,695	\$67,104	\$50,236	\$110,379
Kenora (North)	60 Years (2 Life Cycles)	5%	\$83,818	\$67,008	\$77,586	v/s	\$83,818	\$67,008	\$100,750	\$73,382	\$56,508	\$77,586	\$76,722	\$59,912	\$77,586	\$66,287	\$49,412	\$77,586	\$66,287	\$49,412	\$100,750
North Bay (North)	60 Years (2 Life Cycles)	5%	\$79,888	\$63,142	\$71,891	v/s	\$79,888	\$63,142	\$92,081	\$70,606	\$53,777	\$71,891	\$72,793	\$56,047	\$71,891	\$63,511	\$46,682	\$71,891	\$63,511	\$46,682	\$92,081
Sault Ste. Marie (North)	60 Years (2 Life Cycles)	5%	\$67,236	\$54,748	\$69,921	v/s	\$67,236	\$54,748	\$90,563	\$58,126	\$45,554	\$69,921	\$60,141	\$47,653	\$69,921	\$51,030	\$38,459	\$69,921	\$51,030	\$38,459	\$90,563
Sudbury (North)	60 Years (2 Life Cycles)	5%	\$80,907	\$64,171	\$77,563	v/s	\$80,907	\$64,171	\$99,200	\$71,326	\$54,504	\$77,563	\$73,811	\$57,075	\$77,563	\$64,230	\$47,408	\$77,563	\$64,230	\$47,408	\$99,200
Timmins (North)	60 Years (2 Life Cycles)	5%	\$82,606	\$65,873	\$78,336	v/s	\$82,606	\$65,873	\$102,145	\$72,526	\$55,706	\$78,336	\$75,510	\$58,777	\$78,336	\$65,430	\$48,611	\$78,336	\$65,430	\$48,611	\$102,145
Thunder Bay (North)	60 Years (2 Life Cycles)	5%	\$83,289	\$66,521	\$76,130	v/s	\$83,289	\$66,521	\$98,992	\$73,009	\$56,164	\$76,130	\$76,194	\$59,425	\$76,130	\$65,913	\$49,068	\$76,130	\$65,913	\$49,068	\$98,992

Table 11a: Rankings of the Cities Based on present values for V.GSHP, H.GSHP (two life cycles) and Traditional HVAC Applications (five life cycles) at a discount rate of 5% for improved construction scenario

			Total Present Value																		
			Main Scenario				v/s	Comparative Scenarios													
			Base Case Scenario			v/s	Carbon Taxes - (#1)			FIT - (#2)			Rebates - (#3)			(FIT+Rebates) - (#4)			(FIT+Rebates) + Carbon Taxes - (#5)		
City	Project Life Span	Discount Rate	V.GSHP	H.GSHP	Traditional	v/s	V.GSHP	H.GSHP	Traditional	V.GSHP	H.GSHP	Traditional	V.GSHP	H.GSHP	Traditional	V.GSHP	H.GSHP	Traditional	V.GSHP	H.GSHP	Traditional
Cambridge (South)	60 Years (2 Life Cycles)	5%	\$64,960	\$52,427	\$64,147	v/s	0%	0%	29%	-13%	-16%	0%	-11%	-14%	0%	-24%	-30%	0%	-24%	-30%	29%
Chatham (South)	60 Years (2 Life Cycles)	5%	\$63,129	\$50,586	\$69,170	v/s	0%	0%	24%	-13%	-16%	0%	-11%	-14%	0%	-24%	-30%	0%	-24%	-30%	24%
Guelph (South)	60 Years (2 Life Cycles)	5%	\$65,321	\$52,788	\$65,014	v/s	0%	0%	29%	-13%	-16%	0%	-11%	-13%	0%	-24%	-30%	0%	-24%	-30%	29%
Hamilton (South)	60 Years (2 Life Cycles)	5%	\$64,483	\$51,950	\$72,055	v/s	0%	0%	25%	-13%	-16%	0%	-11%	-14%	0%	-24%	-30%	0%	-24%	-30%	25%
Kingston (South)	60 Years (2 Life Cycles)	5%	\$79,085	\$62,301	\$77,445	v/s	0%	0%	25%	-11%	-15%	0%	-9%	-11%	0%	-20%	-26%	0%	-20%	-26%	25%
Kitchener-Waterloo (South)	60 Years (2 Life Cycles)	5%	\$78,537	\$61,753	\$73,273	v/s	0%	0%	26%	-11%	-15%	0%	-9%	-11%	0%	-20%	-26%	0%	-20%	-26%	26%
London (South)	60 Years (2 Life Cycles)	5%	\$64,967	\$52,408	\$68,258	v/s	0%	0%	27%	-13%	-16%	0%	-11%	-14%	0%	-24%	-30%	0%	-24%	-30%	27%
Mt. Forest (South)	60 Years (2 Life Cycles)	5%	\$78,757	\$53,426	\$72,977	v/s	0%	0%	28%	-11%	-16%	0%	-9%	-13%	0%	-20%	-30%	0%	-20%	-30%	28%
Niagara Falls (South)	60 Years (2 Life Cycles)	5%	\$63,490	\$50,957	\$70,716	v/s	0%	0%	24%	-13%	-16%	0%	-11%	-14%	0%	-24%	-30%	0%	-24%	-30%	24%
Sarnia (South)	60 Years (2 Life Cycles)	5%	\$62,823	\$50,241	\$69,792	v/s	0%	0%	24%	-12%	-16%	0%	-11%	-14%	0%	-24%	-30%	0%	-24%	-30%	24%
Simcoe (South)	60 Years (2 Life Cycles)	5%	\$64,055	\$51,521	\$72,880	v/s	0%	0%	24%	-13%	-16%	0%	-11%	-14%	0%	-24%	-30%	0%	-24%	-30%	24%
St. Catharines (South)	60 Years (2 Life Cycles)	5%	\$75,210	\$49,645	\$70,967	v/s	0%	0%	23%	-11%	-16%	0%	-9%	-14%	0%	-20%	-30%	0%	-20%	-30%	23%
Toronto (South)	60 Years (2 Life Cycles)	5%	\$77,934	\$52,462	\$71,183	v/s	0%	0%	26%	-11%	-16%	0%	-9%	-14%	0%	-20%	-30%	0%	-20%	-30%	26%
Trenton (South)	60 Years (2 Life Cycles)	5%	\$78,221	\$61,408	\$76,803	v/s	0%	0%	24%	-11%	-14%	0%	-9%	-12%	0%	-20%	-26%	0%	-20%	-26%	24%
Warton (South)	60 Years (2 Life Cycles)	5%	\$79,330	\$62,511	\$74,750	v/s	0%	0%	26%	-11%	-15%	0%	-9%	-11%	0%	-20%	-26%	0%	-20%	-26%	26%
Windsor (South)	60 Years (2 Life Cycles)	5%	\$63,152	\$50,622	\$69,226	v/s	0%	0%	24%	-13%	-16%	0%	-11%	-14%	0%	-24%	-30%	0%	-24%	-30%	24%
Barrie (Distinct)	60 Years (2 Life Cycles)	5%	\$78,863	\$62,033	\$67,268	v/s	0%	0%	28%	-11%	-15%	0%	-9%	-11%	0%	-20%	-26%	0%	-20%	-26%	28%
Muskoka (Distinct)	60 Years (2 Life Cycles)	5%	\$79,898	\$63,068	\$69,707	v/s	0%	0%	29%	-12%	-15%	0%	-9%	-11%	0%	-21%	-26%	0%	-21%	-26%	29%
Ottawa (Distinct)	60 Years (2 Life Cycles)	5%	\$78,950	\$62,162	\$71,833	v/s	0%	0%	27%	-11%	-15%	0%	-9%	-11%	0%	-20%	-26%	0%	-20%	-26%	27%
Peterborough (Distinct)	60 Years (2 Life Cycles)	5%	\$79,717	\$62,930	\$72,966	v/s	0%	0%	27%	-12%	-15%	0%	-9%	-11%	0%	-20%	-26%	0%	-20%	-26%	27%
Kapuskasing (North)	60 Years (2 Life Cycles)	5%	\$84,975	\$68,175	\$85,695	v/s	0%	0%	29%	-13%	-16%	0%	-8%	-10%	0%	-21%	-26%	0%	-21%	-26%	29%
Kenora (North)	60 Years (2 Life Cycles)	5%	\$83,818	\$67,008	\$77,586	v/s	0%	0%	30%	-12%	-16%	0%	-8%	-11%	0%	-21%	-26%	0%	-21%	-26%	30%
North Bay (North)	60 Years (2 Life Cycles)	5%	\$79,888	\$63,142	\$71,891	v/s	0%	0%	28%	-12%	-15%	0%	-9%	-11%	0%	-21%	-26%	0%	-21%	-26%	28%
Sault Ste. Marie (North)	60 Years (2 Life Cycles)	5%	\$67,236	\$54,748	\$69,921	v/s	0%	0%	30%	-14%	-17%	0%	-11%	-13%	0%	-24%	-30%	0%	-24%	-30%	30%
Sudbury (North)	60 Years (2 Life Cycles)	5%	\$80,907	\$64,171	\$77,563	v/s	0%	0%	28%	-12%	-15%	0%	-9%	-11%	0%	-21%	-26%	0%	-21%	-26%	28%
Timmins (North)	60 Years (2 Life Cycles)	5%	\$82,606	\$65,873	\$78,336	v/s	0%	0%	30%	-12%	-15%	0%	-9%	-11%	0%	-21%	-26%	0%	-21%	-26%	30%
Thunder Bay (North)	60 Years (2 Life Cycles)	5%	\$83,289	\$66,521	\$76,130	v/s	0%	0%	30%	-12%	-16%	0%	-9%	-11%	0%	-21%	-26%	0%	-21%	-26%	30%

Table 11b: % change in present values for comparative scenarios in regards to the main scenario for V.GSHP, H.GSHP (two life cycles) and Traditional HVAC Applications (five life cycles) at a discount rate of 5% for improved construction scenario

		Total Present Value																				
		Main Scenario					v/s	Comparative Scenarios														
		Base Case Scenario					v/s	Carbon Taxes - (€1)			FIT - (€2)			Rebates - (€3)			(FIT+Rebates) - (€4)			(FIT+Rebates) + Carbon Taxes - (€5)		
City	Project Life Span	Discount Rate	V.GSHP	H.GSHP	Traditional	v/s	V.GSHP	H.GSHP	Traditional	V.GSHP	H.GSHP	Traditional	V.GSHP	H.GSHP	Traditional	V.GSHP	H.GSHP	Traditional	V.GSHP	H.GSHP	Traditional	
Cambridge (South)	60 Years (2 Life Cycles)	7%	\$52,186	\$41,218	\$47,171	v/s	\$52,186	\$41,218	\$58,270	\$45,924	\$34,905	\$47,171	\$45,996	\$35,028	\$47,171	\$39,734	\$28,715	\$47,171	\$39,734	\$28,715	\$58,270	
Chatham (South)	60 Years (2 Life Cycles)	7%	\$50,849	\$39,875	\$50,963	v/s	\$50,849	\$39,875	\$60,941	\$44,987	\$33,962	\$50,963	\$44,660	\$33,685	\$50,963	\$38,797	\$27,772	\$50,963	\$38,797	\$27,772	\$60,941	
Guelph (South)	60 Years (2 Life Cycles)	7%	\$52,449	\$41,482	\$47,796	v/s	\$52,449	\$41,482	\$59,224	\$46,109	\$35,090	\$47,796	\$46,259	\$35,292	\$47,796	\$39,919	\$28,900	\$47,796	\$39,919	\$28,900	\$59,224	
Hamilton (South)	60 Years (2 Life Cycles)	7%	\$51,837	\$40,870	\$53,050	v/s	\$51,837	\$40,870	\$63,867	\$45,680	\$34,660	\$53,050	\$45,648	\$34,680	\$53,050	\$39,490	\$28,471	\$53,050	\$39,490	\$28,471	\$63,867	
Kingston (South)	60 Years (2 Life Cycles)	7%	\$64,087	\$49,410	\$57,068	v/s	\$64,087	\$49,410	\$68,587	\$57,377	\$42,647	\$57,068	\$57,897	\$43,220	\$57,068	\$51,188	\$36,458	\$57,068	\$51,188	\$36,458	\$68,587	
Kitchener-Waterloo (South)	60 Years (2 Life Cycles)	7%	\$63,687	\$49,010	\$53,924	v/s	\$63,687	\$49,010	\$65,377	\$57,097	\$42,367	\$53,924	\$57,497	\$42,820	\$53,924	\$50,907	\$36,177	\$53,924	\$50,907	\$36,177	\$65,377	
London (South)	60 Years (2 Life Cycles)	7%	\$52,190	\$41,204	\$50,222	v/s	\$52,190	\$41,204	\$61,321	\$45,927	\$34,895	\$50,222	\$46,001	\$35,014	\$50,222	\$39,738	\$28,705	\$50,222	\$39,738	\$28,705	\$61,321	
Mt. Forest (South)	60 Years (2 Life Cycles)	7%	\$63,847	\$41,947	\$53,692	v/s	\$63,847	\$41,947	\$65,861	\$57,209	\$35,416	\$53,692	\$57,657	\$35,758	\$53,692	\$51,019	\$29,227	\$53,692	\$51,019	\$29,227	\$65,861	
Niagara Falls (South)	60 Years (2 Life Cycles)	7%	\$51,113	\$40,145	\$52,089	v/s	\$51,113	\$40,145	\$62,183	\$45,171	\$34,152	\$52,089	\$44,923	\$33,956	\$52,089	\$38,982	\$27,962	\$52,089	\$38,982	\$27,962	\$62,183	
Sarnia (South)	60 Years (2 Life Cycles)	7%	\$50,626	\$39,623	\$51,412	v/s	\$50,626	\$39,623	\$61,604	\$44,830	\$33,786	\$51,412	\$44,436	\$33,433	\$51,412	\$38,640	\$27,596	\$51,412	\$38,640	\$27,596	\$61,604	
Simcoe (South)	60 Years (2 Life Cycles)	7%	\$51,525	\$40,557	\$53,708	v/s	\$51,525	\$40,557	\$64,286	\$45,460	\$34,441	\$53,708	\$45,335	\$34,367	\$53,708	\$39,271	\$28,251	\$53,708	\$39,271	\$28,251	\$64,286	
St. Catharines (South)	60 Years (2 Life Cycles)	7%	\$61,259	\$39,188	\$52,280	v/s	\$61,259	\$39,188	\$62,048	\$55,393	\$33,480	\$52,280	\$55,069	\$32,998	\$52,280	\$49,203	\$27,290	\$52,280	\$49,203	\$27,290	\$62,048	
Toronto (South)	60 Years (2 Life Cycles)	7%	\$63,247	\$41,244	\$52,406	v/s	\$63,247	\$41,244	\$63,527	\$56,788	\$34,923	\$52,406	\$57,057	\$35,054	\$52,406	\$50,598	\$28,733	\$52,406	\$50,598	\$28,733	\$63,527	
Trenton (South)	60 Years (2 Life Cycles)	7%	\$63,456	\$48,758	\$56,607	v/s	\$63,456	\$48,758	\$67,800	\$56,935	\$42,190	\$56,607	\$57,266	\$42,569	\$56,607	\$50,745	\$36,000	\$56,607	\$50,745	\$36,000	\$67,800	
Warton (South)	60 Years (2 Life Cycles)	7%	\$64,265	\$49,563	\$55,043	v/s	\$64,265	\$49,563	\$66,916	\$57,503	\$42,755	\$55,043	\$58,076	\$43,373	\$55,043	\$51,313	\$36,565	\$55,043	\$51,313	\$36,565	\$66,916	
Windsor (South)	60 Years (2 Life Cycles)	7%	\$50,866	\$39,901	\$51,004	v/s	\$50,866	\$39,901	\$61,007	\$44,998	\$33,980	\$51,004	\$44,676	\$33,711	\$51,004	\$38,808	\$27,791	\$51,004	\$38,808	\$27,791	\$61,007	
Barrie (Distinct)	60 Years (2 Life Cycles)	7%	\$63,924	\$49,215	\$49,495	v/s	\$63,924	\$49,215	\$60,739	\$57,263	\$42,510	\$49,495	\$57,735	\$43,025	\$49,495	\$51,074	\$36,321	\$49,495	\$51,074	\$36,321	\$60,739	
Muskoka (Distinct)	60 Years (2 Life Cycles)	7%	\$64,680	\$49,970	\$51,258	v/s	\$64,680	\$49,970	\$63,286	\$57,793	\$43,040	\$51,258	\$58,490	\$43,780	\$51,258	\$51,604	\$36,850	\$51,258	\$51,604	\$36,850	\$63,286	
Ottawa (Distinct)	60 Years (2 Life Cycles)	7%	\$63,988	\$49,309	\$52,872	v/s	\$63,988	\$49,309	\$64,372	\$57,308	\$42,576	\$52,872	\$57,798	\$43,119	\$52,872	\$51,118	\$36,387	\$52,872	\$51,118	\$36,387	\$64,372	
Peterborough (Distinct)	60 Years (2 Life Cycles)	7%	\$64,548	\$49,869	\$53,687	v/s	\$64,548	\$49,869	\$65,676	\$57,701	\$42,969	\$53,687	\$58,358	\$43,679	\$53,687	\$51,511	\$36,779	\$53,687	\$51,511	\$36,779	\$65,676	
Kapuskasing (North)	60 Years (2 Life Cycles)	7%	\$68,385	\$53,696	\$63,014	v/s	\$68,385	\$53,696	\$77,813	\$60,393	\$45,655	\$63,014	\$62,195	\$47,507	\$63,014	\$54,203	\$39,465	\$63,014	\$54,203	\$39,465	\$77,813	
Kenora (North)	60 Years (2 Life Cycles)	7%	\$67,540	\$52,845	\$57,016	v/s	\$67,540	\$52,845	\$70,903	\$59,801	\$45,057	\$57,016	\$61,351	\$46,655	\$57,016	\$53,611	\$38,868	\$57,016	\$53,611	\$38,868	\$70,903	
North Bay (North)	60 Years (2 Life Cycles)	7%	\$64,672	\$50,024	\$52,901	v/s	\$64,672	\$50,024	\$65,005	\$57,788	\$43,078	\$52,901	\$58,483	\$43,834	\$52,901	\$51,599	\$36,888	\$52,901	\$51,599	\$36,888	\$65,005	
Sault Ste. Marie (North)	60 Years (2 Life Cycles)	7%	\$53,847	\$42,912	\$51,406	v/s	\$53,847	\$42,912	\$63,781	\$47,090	\$36,093	\$51,406	\$47,657	\$36,722	\$51,406	\$40,900	\$29,903	\$51,406	\$40,900	\$29,903	\$63,781	
Sudbury (North)	60 Years (2 Life Cycles)	7%	\$65,416	\$50,775	\$57,070	v/s	\$65,416	\$50,775	\$70,043	\$58,310	\$43,605	\$57,070	\$59,226	\$44,585	\$57,070	\$52,120	\$37,415	\$57,070	\$52,120	\$37,415	\$70,043	
Timmins (North)	60 Years (2 Life Cycles)	7%	\$66,656	\$52,017	\$57,554	v/s	\$66,656	\$52,017	\$71,829	\$59,180	\$44,476	\$57,554	\$60,466	\$45,827	\$57,554	\$52,990	\$38,287	\$57,554	\$52,990	\$38,287	\$71,829	
Thunder Bay (North)	60 Years (2 Life Cycles)	7%	\$67,154	\$52,490	\$55,958	v/s	\$67,154	\$52,490	\$69,664	\$59,530	\$44,808	\$55,958	\$60,965	\$46,300	\$55,958	\$53,340	\$38,618	\$55,958	\$53,340	\$38,618	\$69,664	

Table 11c: Rankings of the Cities Based on present values for V.GSHP, H.GSHP (two life cycles) and Traditional HVAC Applications (five life cycles) at a discount rate of 7% for improved construction scenario

		Total Present Value																				
		Main Scenario					v/s	Comparative Scenarios														
		Base Case Scenario					v/s	Carbon Taxes - (€1)			FIT - (€2)			Rebates - (€3)			(FIT+Rebates) - (€4)			(FIT+Rebates) + Carbon Taxes - (€5)		
City	Project Life Span	Discount Rate	V.GSHP	H.GSHP	Traditional	v/s	V.GSHP	H.GSHP	Traditional	V.GSHP	H.GSHP	Traditional	V.GSHP	H.GSHP	Traditional	V.GSHP	H.GSHP	Traditional	V.GSHP	H.GSHP	Traditional	
Cambridge (South)	60 Years (2 Life Cycles)	7%	\$52,186	\$41,218	\$47,171	v/s	0%	0%	24%	-12%	-15%	0%	-12%	-15%	0%	-24%	-30%	0%	-24%	-30%	24%	
Chatham (South)	60 Years (2 Life Cycles)	7%	\$50,849	\$39,875	\$50,963	v/s	0%	0%	20%	-12%	-15%	0%	-12%	-16%	0%	-24%	-30%	0%	-24%	-30%	20%	
Guelph (South)	60 Years (2 Life Cycles)	7%	\$52,449	\$41,482	\$47,796	v/s	0%	0%	24%	-12%	-15%	0%	-12%	-15%	0%	-24%	-30%	0%	-24%	-30%	24%	
Hamilton (South)	60 Years (2 Life Cycles)	7%	\$51,837	\$40,870	\$53,050	v/s	0%	0%	20%	-12%	-15%	0%	-12%	-15%	0%	-24%	-30%	0%	-24%	-30%	20%	
Kingston (South)	60 Years (2 Life Cycles)	7%	\$64,087	\$49,410	\$57,068	v/s	0%	0%	20%	-10%	-14%	0%	-10%	-13%	0%	-20%	-26%	0%	-20%	-26%	20%	
Kitchener-Waterloo (South)	60 Years (2 Life Cycles)	7%	\$63,687	\$49,010	\$53,924	v/s	0%	0%	21%	-10%	-14%	0%	-10%	-13%	0%	-20%	-26%	0%	-20%	-26%	21%	
London (South)	60 Years (2 Life Cycles)	7%	\$52,190	\$41,204	\$50,222	v/s	0%	0%	22%	-12%	-15%	0%	-12%	-15%	0%	-24%	-30%	0%	-24%	-30%	22%	
Mt. Forest (South)	60 Years (2 Life Cycles)	7%	\$63,847	\$41,947	\$53,692	v/s	0%	0%	23%	-10%	-16%	0%	-10%	-15%	0%	-20%	-30%	0%	-20%	-30%	23%	
Niagara Falls (South)	60 Years (2 Life Cycles)	7%	\$51,113	\$40,145	\$52,089	v/s	0%	0%	19%	-12%	-15%	0%	-12%	-15%	0%	-24%	-30%	0%	-24%	-30%	19%	
Sarnia (South)	60 Years (2 Life Cycles)	7%	\$50,626	\$39,623	\$51,412	v/s	0%	0%	20%	-11%	-15%	0%	-12%	-16%	0%	-24%	-30%	0%	-24%	-30%	20%	
Simcoe (South)	60 Years (2 Life Cycles)	7%	\$51,525	\$40,557	\$53,708	v/s	0%	0%	20%	-12%	-15%	0%	-12%	-15%	0%	-24%	-30%	0%	-24%	-30%	20%	
St. Catharines (South)	60 Years (2 Life Cycles)	7%	\$61,259	\$39,188	\$52,280	v/s	0%	0%	19%	-10%	-15%	0%	-10%	-16%	0%	-20%	-30%	0%	-20%	-30%	19%	
Toronto (South)	60 Years (2 Life Cycles)	7%	\$63,247	\$41,244	\$52,406	v/s	0%	0%	21%	-10%	-15%	0%	-10%	-15%	0%	-20%	-30%	0%	-20%	-30%	21%	
Trenton (South)	60 Years (2 Life Cycles)	7%	\$63,456	\$48,758	\$56,607	v/s	0%	0%	20%	-10%	-13%	0%	-10%	-13%	0%	-20%	-26%	0%	-20%	-26%	20%	
Warton (South)	60 Years (2 Life Cycles)	7%	\$64,265	\$49,563	\$55,043	v/s	0%	0%	22%	-11%	-14%	0%	-10%	-12%	0%	-20%	-26%	0%	-20%	-26%	22%	
Windsor (South)	60 Years (2 Life Cycles)	7%	\$50,866	\$39,901	\$51,004	v/s	0%	0%	20%	-12%	-15%	0%	-12%	-16%	0%	-24%	-30%	0%	-24%	-30%	20%	
Barrie (Distinct)	60 Years (2 Life Cycles)	7%	\$63,924	\$49,215	\$49,495	v/s	0%	0%	23%	-10%	-14%	0%	-10%	-13%	0%	-20%	-26%	0%	-20%	-26%	23%	
Muskoka (Distinct)	60 Years (2 Life Cycles)	7%	\$64,680	\$49,970	\$51,258	v/s	0%	0%	23%	-11%	-14%	0%	-10%	-12%	0%	-20%	-26%	0%	-20%	-26%	23%	
Ottawa (Distinct)	60 Years (2 Life Cycles)	7%	\$63,988	\$49,309	\$52,872	v/s	0%	0%	22%	-10%	-14%	0%	-10%	-13%	0%	-20%	-26%	0%	-20%	-26%	22%	
Peterborough (Distinct)	60 Years (2 Life Cycles)	7%	\$64,548	\$49,869	\$53,687	v/s	0%	0%	22%	-11%	-14%	0%	-10%	-12%	0%	-20%	-26%	0%	-20%	-26%	22%	
Kapuskasing (North)	60 Years (2 Life Cycles)	7%	\$68,385	\$53,696	\$63,014	v/s	0%	0%	23%	-12%	-15%	0%	-9%	-12%	0%	-21%	-27%	0%	-21%	-27%	23%	
Kenora (North)	60 Years (2 Life Cycles)	7%	\$67,540	\$52,845	\$57,016	v/s	0%	0%	24%	-11%	-15%	0%	-9%	-12%	0%	-21%	-26%	0%	-21%	-26%	24%	
North Bay (North)	60 Years (2 Life Cycles)	7%	\$64,672	\$50,024	\$52,901	v/s	0%	0%	23%	-11%	-14%	0%	-10%	-12%	0%	-20%	-26%	0%	-20%	-26%	23%	
Sault Ste. Marie (North)	60 Years (2 Life Cycles)	7%	\$53,847	\$42,912	\$51,406	v/s	0%	0%	24%	-13%	-16%	0%	-11%	-14%	0%	-24%	-30%	0%	-24%	-30%	24%	
Sudbury (North)	60 Years (2 Life Cycles)	7%	\$65,416	\$50,775	\$57,070	v/s	0%	0%	23%	-11%	-14%	0%	-9%	-12%	0%	-20%	-26%	0%	-20%	-26%	23%	
Timmins (North)	60 Years (2 Life Cycles)	7%	\$66,656	\$52,017	\$57,554	v/s	0%	0%	25%	-11%	-14%	0%	-9%	-12%	0%	-21%	-26%	0%	-21%	-26%	25%	
Thunder Bay (North)	60 Years (2 Life Cycles)	7%	\$67,154	\$52,490	\$55,958	v/s	0%	0%	24%	-11%	-15%	0%	-9%	-12%	0%	-21%	-26%	0%	-21%	-26%	24%	

Table 11d: % change in present values for comparative scenarios in regards to the main scenario for V.GSHP, H.GSHP (two life cycles) and Traditional HVAC Applications (five life cycles) at a discount rate of 7% for improved construction scenario

			Total Present Value																		
			Main Scenario				v/s	Comparative Scenarios													
			Base Case Scenario			v/s	Carbon Taxes - (€1)			FIT - (€2)			Rebates - (€3)			(FIT+Rebates) - (€4)			(FIT+Rebates) + Carbon Taxes - (€5)		
City	Project Life Span	Discount Rate	V.GSHP	H.GSHP	Traditional	v/s	V.GSHP	H.GSHP	Traditional	V.GSHP	H.GSHP	Traditional	V.GSHP	H.GSHP	Traditional	V.GSHP	H.GSHP	Traditional	V.GSHP	H.GSHP	Traditional
Cambridge (South)	60 Years (2 Life Cycles)	7.5%	\$49,948	\$39,249	\$44,213	v/s	\$49,948	\$39,249	\$54,110	\$44,079	\$33,331	\$44,213	\$43,914	\$33,214	\$44,213	\$38,045	\$27,296	\$44,213	\$38,045	\$27,296	\$54,110
Chatham (South)	60 Years (2 Life Cycles)	7.5%	\$48,700	\$37,994	\$47,791	v/s	\$48,700	\$37,994	\$56,689	\$43,204	\$32,452	\$47,791	\$42,665	\$31,959	\$47,791	\$37,170	\$26,417	\$47,791	\$37,170	\$26,417	\$56,689
Guelph (South)	60 Years (2 Life Cycles)	7.5%	\$50,194	\$39,495	\$44,795	v/s	\$50,194	\$39,495	\$54,986	\$44,251	\$33,503	\$44,795	\$44,160	\$33,460	\$44,795	\$38,217	\$27,469	\$44,795	\$38,217	\$27,469	\$54,986
Hamilton (South)	60 Years (2 Life Cycles)	7.5%	\$49,623	\$38,923	\$49,737	v/s	\$49,623	\$38,923	\$59,383	\$43,851	\$33,103	\$49,737	\$43,588	\$32,889	\$49,737	\$37,817	\$27,069	\$49,737	\$37,817	\$27,069	\$59,383
Kingston (South)	60 Years (2 Life Cycles)	7.5%	\$61,465	\$47,149	\$53,519	v/s	\$61,465	\$47,149	\$63,791	\$55,176	\$40,810	\$53,519	\$55,430	\$41,115	\$53,519	\$49,141	\$34,776	\$53,519	\$49,141	\$34,776	\$63,791
Kitchener-Waterloo (South)	60 Years (2 Life Cycles)	7.5%	\$61,091	\$46,775	\$50,550	v/s	\$61,091	\$46,775	\$60,764	\$54,914	\$40,548	\$50,550	\$55,057	\$40,741	\$50,550	\$48,880	\$34,514	\$50,550	\$48,880	\$34,514	\$60,764
London (South)	60 Years (2 Life Cycles)	7.5%	\$49,952	\$39,235	\$47,078	v/s	\$49,952	\$39,235	\$56,976	\$44,082	\$33,322	\$47,078	\$43,918	\$33,201	\$47,078	\$38,048	\$27,287	\$47,078	\$38,048	\$27,287	\$56,976
Mt. Forest (South)	60 Years (2 Life Cycles)	7.5%	\$61,241	\$39,930	\$50,331	v/s	\$61,241	\$39,930	\$61,183	\$55,019	\$33,808	\$50,331	\$55,206	\$33,896	\$50,331	\$48,984	\$27,774	\$50,331	\$48,984	\$27,774	\$61,183
Niagara Falls (South)	60 Years (2 Life Cycles)	7.5%	\$48,946	\$38,246	\$48,843	v/s	\$48,946	\$38,246	\$57,844	\$43,377	\$32,629	\$48,843	\$42,911	\$32,212	\$48,843	\$37,342	\$26,594	\$48,843	\$37,342	\$26,594	\$57,844
Sarnia (South)	60 Years (2 Life Cycles)	7.5%	\$48,491	\$37,759	\$48,210	v/s	\$48,491	\$37,759	\$57,298	\$43,058	\$32,287	\$48,210	\$42,456	\$31,724	\$48,210	\$37,024	\$26,252	\$48,210	\$37,024	\$26,252	\$57,298
Simcoe (South)	60 Years (2 Life Cycles)	7.5%	\$49,330	\$38,631	\$50,368	v/s	\$49,330	\$38,631	\$59,801	\$43,646	\$32,898	\$50,368	\$43,296	\$32,597	\$50,368	\$37,612	\$26,864	\$50,368	\$37,612	\$26,864	\$59,801
St. Catharines (South)	60 Years (2 Life Cycles)	7.5%	\$58,823	\$37,352	\$49,022	v/s	\$58,823	\$37,352	\$57,733	\$53,325	\$32,002	\$49,022	\$52,788	\$31,317	\$49,022	\$47,290	\$25,967	\$49,022	\$47,290	\$25,967	\$57,733
Toronto (South)	60 Years (2 Life Cycles)	7.5%	\$60,680	\$39,273	\$49,134	v/s	\$60,680	\$39,273	\$59,051	\$54,626	\$33,348	\$49,134	\$54,646	\$33,238	\$49,134	\$48,592	\$27,313	\$49,134	\$48,592	\$27,313	\$59,051
Trenton (South)	60 Years (2 Life Cycles)	7.5%	\$60,876	\$46,540	\$53,089	v/s	\$60,876	\$46,540	\$63,071	\$54,763	\$40,384	\$53,089	\$54,841	\$40,506	\$53,089	\$48,729	\$34,349	\$53,089	\$48,729	\$34,349	\$63,071
Warton (South)	60 Years (2 Life Cycles)	7.5%	\$61,632	\$47,292	\$51,609	v/s	\$61,632	\$47,292	\$62,197	\$55,293	\$40,910	\$51,609	\$55,597	\$41,257	\$51,609	\$49,258	\$34,876	\$51,609	\$49,258	\$34,876	\$62,197
Windsor (South)	60 Years (2 Life Cycles)	7.5%	\$48,715	\$38,018	\$47,829	v/s	\$48,715	\$38,018	\$56,749	\$43,215	\$32,469	\$47,829	\$42,681	\$31,983	\$47,829	\$37,181	\$26,434	\$47,829	\$37,181	\$26,434	\$56,749
Barrie (Distinct)	60 Years (2 Life Cycles)	7.5%	\$61,313	\$46,967	\$46,399	v/s	\$61,313	\$46,967	\$56,426	\$55,070	\$40,682	\$46,399	\$55,279	\$40,932	\$46,399	\$49,035	\$34,648	\$46,399	\$49,035	\$34,648	\$56,426
Muskoka (Distinct)	60 Years (2 Life Cycles)	7.5%	\$62,019	\$47,672	\$48,042	v/s	\$62,019	\$47,672	\$58,769	\$55,564	\$41,177	\$48,042	\$55,984	\$41,638	\$48,042	\$49,529	\$35,142	\$48,042	\$49,529	\$35,142	\$58,769
Ottawa (Distinct)	60 Years (2 Life Cycles)	7.5%	\$61,372	\$47,055	\$49,568	v/s	\$61,372	\$47,055	\$59,823	\$55,111	\$40,744	\$49,568	\$55,338	\$41,020	\$49,568	\$49,077	\$34,709	\$49,568	\$49,077	\$34,709	\$59,823
Peterborough (Distinct)	60 Years (2 Life Cycles)	7.5%	\$61,896	\$47,578	\$50,327	v/s	\$61,896	\$47,578	\$61,018	\$55,478	\$41,110	\$50,327	\$55,861	\$41,543	\$50,327	\$49,443	\$35,076	\$50,327	\$49,443	\$35,076	\$61,018
Kapuskasing (North)	60 Years (2 Life Cycles)	7.5%	\$65,480	\$51,154	\$59,059	v/s	\$65,480	\$51,154	\$72,256	\$57,989	\$43,616	\$59,059	\$59,446	\$45,119	\$59,059	\$51,955	\$37,581	\$59,059	\$51,955	\$37,581	\$72,256
Kenora (North)	60 Years (2 Life Cycles)	7.5%	\$64,691	\$50,358	\$53,428	v/s	\$64,691	\$50,358	\$65,813	\$57,436	\$43,058	\$53,428	\$58,657	\$44,323	\$53,428	\$51,402	\$37,024	\$53,428	\$51,402	\$37,024	\$65,813
North Bay (North)	60 Years (2 Life Cycles)	7.5%	\$62,012	\$47,723	\$49,592	v/s	\$62,012	\$47,723	\$60,386	\$55,559	\$41,212	\$49,592	\$55,978	\$41,688	\$49,592	\$49,525	\$35,178	\$49,592	\$49,525	\$35,178	\$60,386
Sault Ste. Marie (North)	60 Years (2 Life Cycles)	7.5%	\$51,500	\$40,831	\$48,179	v/s	\$51,500	\$40,831	\$59,215	\$45,166	\$34,440	\$48,179	\$45,465	\$34,797	\$48,179	\$39,132	\$28,405	\$48,179	\$39,132	\$28,405	\$59,215
Sudbury (North)	60 Years (2 Life Cycles)	7.5%	\$62,707	\$48,424	\$53,499	v/s	\$62,707	\$48,424	\$65,067	\$56,046	\$41,703	\$53,499	\$56,672	\$42,389	\$53,499	\$50,011	\$35,669	\$53,499	\$50,011	\$35,669	\$65,067
Timmins (North)	60 Years (2 Life Cycles)	7.5%	\$63,865	\$49,584	\$53,930	v/s	\$63,865	\$49,584	\$66,659	\$56,857	\$42,516	\$53,930	\$57,830	\$43,550	\$53,930	\$50,823	\$36,482	\$53,930	\$50,823	\$36,482	\$66,659
Thunder Bay (North)	60 Years (2 Life Cycles)	7.5%	\$64,331	\$50,026	\$52,441	v/s	\$64,331	\$50,026	\$64,664	\$57,184	\$42,826	\$52,441	\$58,296	\$43,992	\$52,441	\$51,149	\$36,791	\$52,441	\$51,149	\$36,791	\$64,664

Table 11e: Rankings of the Cities Based on present values for V.GSHP, H.GSHP (two life cycles) and Traditional HVAC Applications (five life cycles) at a discount rate of 7.5% for improved construction scenario

		Total Present Value																				
		Main Scenario					v/s	Comparative Scenarios														
		Base Case Scenario					v/s	Carbon Taxes - (€1)			FIT - (€2)			Rebates - (€3)			(FIT+Rebates) - (€4)			(FIT+Rebates) + Carbon Taxes - (€5)		
City	Project Life Span	Discount Rate	V.GSHP	H.GSHP	Traditional	v/s	V.GSHP	H.GSHP	Traditional	V.GSHP	H.GSHP	Traditional	V.GSHP	H.GSHP	Traditional	V.GSHP	H.GSHP	Traditional	V.GSHP	H.GSHP	Traditional	
Cambridge (South)	60 Years (2 Life Cycles)	7.5%	\$49,948	\$39,249	\$44,213	v/s	0%	0%	22%	-12%	-15%	0%	-12%	-15%	0%	-24%	-30%	0%	-24%	-30%	22%	
Chatham (South)	60 Years (2 Life Cycles)	7.5%	\$48,700	\$37,994	\$47,791	v/s	0%	0%	19%	-11%	-15%	0%	-12%	-16%	0%	-24%	-30%	0%	-24%	-30%	19%	
Guelph (South)	60 Years (2 Life Cycles)	7.5%	\$50,194	\$39,495	\$44,795	v/s	0%	0%	23%	-12%	-15%	0%	-12%	-15%	0%	-24%	-30%	0%	-24%	-30%	23%	
Hamilton (South)	60 Years (2 Life Cycles)	7.5%	\$49,623	\$38,923	\$49,737	v/s	0%	0%	19%	-12%	-15%	0%	-12%	-16%	0%	-24%	-30%	0%	-24%	-30%	19%	
Kingston (South)	60 Years (2 Life Cycles)	7.5%	\$61,465	\$47,149	\$53,519	v/s	0%	0%	19%	-10%	-13%	0%	-10%	-13%	0%	-20%	-26%	0%	-20%	-26%	19%	
Kitchener-Waterloo (South)	60 Years (2 Life Cycles)	7.5%	\$61,091	\$46,775	\$50,550	v/s	0%	0%	20%	-10%	-13%	0%	-10%	-13%	0%	-20%	-26%	0%	-20%	-26%	20%	
London (South)	60 Years (2 Life Cycles)	7.5%	\$49,952	\$39,235	\$47,078	v/s	0%	0%	21%	-12%	-15%	0%	-12%	-15%	0%	-24%	-30%	0%	-24%	-30%	21%	
Mt. Forest (South)	60 Years (2 Life Cycles)	7.5%	\$61,241	\$39,930	\$50,331	v/s	0%	0%	22%	-10%	-15%	0%	-10%	-15%	0%	-20%	-30%	0%	-20%	-30%	22%	
Niagara Falls (South)	60 Years (2 Life Cycles)	7.5%	\$48,946	\$38,246	\$48,843	v/s	0%	0%	18%	-11%	-15%	0%	-12%	-16%	0%	-24%	-30%	0%	-24%	-30%	18%	
Sarnia (South)	60 Years (2 Life Cycles)	7.5%	\$48,491	\$37,759	\$48,210	v/s	0%	0%	19%	-11%	-14%	0%	-12%	-16%	0%	-24%	-30%	0%	-24%	-30%	19%	
Simcoe (South)	60 Years (2 Life Cycles)	7.5%	\$49,330	\$38,631	\$50,368	v/s	0%	0%	19%	-12%	-15%	0%	-12%	-16%	0%	-24%	-30%	0%	-24%	-30%	19%	
St. Catharines (South)	60 Years (2 Life Cycles)	7.5%	\$58,823	\$37,352	\$49,022	v/s	0%	0%	18%	-9%	-14%	0%	-10%	-16%	0%	-20%	-30%	0%	-20%	-30%	18%	
Toronto (South)	60 Years (2 Life Cycles)	7.5%	\$60,680	\$39,273	\$49,134	v/s	0%	0%	20%	-10%	-15%	0%	-10%	-15%	0%	-20%	-30%	0%	-20%	-30%	20%	
Trenton (South)	60 Years (2 Life Cycles)	7.5%	\$60,876	\$46,540	\$53,089	v/s	0%	0%	19%	-10%	-13%	0%	-10%	-13%	0%	-20%	-26%	0%	-20%	-26%	19%	
Warton (South)	60 Years (2 Life Cycles)	7.5%	\$61,632	\$47,292	\$51,609	v/s	0%	0%	21%	-10%	-13%	0%	-10%	-13%	0%	-20%	-26%	0%	-20%	-26%	21%	
Windsor (South)	60 Years (2 Life Cycles)	7.5%	\$48,715	\$38,018	\$47,829	v/s	0%	0%	19%	-11%	-15%	0%	-12%	-16%	0%	-24%	-30%	0%	-24%	-30%	19%	
Barrie (Distinct)	60 Years (2 Life Cycles)	7.5%	\$61,313	\$46,967	\$46,399	v/s	0%	0%	22%	-10%	-13%	0%	-10%	-13%	0%	-20%	-26%	0%	-20%	-26%	22%	
Muskoka (Distinct)	60 Years (2 Life Cycles)	7.5%	\$62,019	\$47,672	\$48,042	v/s	0%	0%	22%	-10%	-14%	0%	-10%	-13%	0%	-20%	-26%	0%	-20%	-26%	22%	
Ottawa (Distinct)	60 Years (2 Life Cycles)	7.5%	\$61,372	\$47,055	\$49,568	v/s	0%	0%	21%	-10%	-13%	0%	-10%	-13%	0%	-20%	-26%	0%	-20%	-26%	21%	
Peterborough (Distinct)	60 Years (2 Life Cycles)	7.5%	\$61,896	\$47,578	\$50,327	v/s	0%	0%	21%	-10%	-14%	0%	-10%	-13%	0%	-20%	-26%	0%	-20%	-26%	21%	
Kapuskasing (North)	60 Years (2 Life Cycles)	7.5%	\$65,480	\$51,154	\$59,059	v/s	0%	0%	22%	-11%	-15%	0%	-9%	-12%	0%	-21%	-27%	0%	-21%	-27%	22%	
Kenora (North)	60 Years (2 Life Cycles)	7.5%	\$64,691	\$50,358	\$53,428	v/s	0%	0%	23%	-11%	-14%	0%	-9%	-12%	0%	-21%	-26%	0%	-21%	-26%	23%	
North Bay (North)	60 Years (2 Life Cycles)	7.5%	\$62,012	\$47,723	\$49,592	v/s	0%	0%	22%	-10%	-14%	0%	-10%	-13%	0%	-20%	-26%	0%	-20%	-26%	22%	
Sault Ste. Marie (North)	60 Years (2 Life Cycles)	7.5%	\$51,500	\$40,831	\$48,179	v/s	0%	0%	23%	-12%	-16%	0%	-12%	-15%	0%	-24%	-30%	0%	-24%	-30%	23%	
Sudbury (North)	60 Years (2 Life Cycles)	7.5%	\$62,707	\$48,424	\$53,499	v/s	0%	0%	22%	-11%	-14%	0%	-10%	-12%	0%	-20%	-26%	0%	-20%	-26%	22%	
Timmins (North)	60 Years (2 Life Cycles)	7.5%	\$63,865	\$49,584	\$53,930	v/s	0%	0%	24%	-11%	-14%	0%	-9%	-12%	0%	-20%	-26%	0%	-20%	-26%	24%	
Thunder Bay (North)	60 Years (2 Life Cycles)	7.5%	\$64,331	\$50,026	\$52,441	v/s	0%	0%	23%	-11%	-14%	0%	-9%	-12%	0%	-20%	-26%	0%	-20%	-26%	23%	

Table 11f: % change in present values for comparative scenarios in regards to the main scenario for V.GSHP, H.GSHP (two life cycles) and Traditional HVAC Applications (five life cycles) at a discount rate of 7.5% for improved construction scenario

		Total Present Value																				
		Main Scenario					v/s	Comparative Scenarios														
		Base Case Scenario					v/s	Carbon Taxes - (€1)			FIT - (€2)			Rebates - (€3)			(FIT+Rebates) - (€4)			(FIT+Rebates) + Carbon Taxes - (€5)		
City	Project Life Span	Discount Rate	V.GSHP	H.GSHP	Traditional	v/s	V.GSHP	H.GSHP	Traditional	V.GSHP	H.GSHP	Traditional	V.GSHP	H.GSHP	Traditional	V.GSHP	H.GSHP	Traditional	V.GSHP	H.GSHP	Traditional	
Cambridge (South)	60 Years (2 Life Cycles)	8.5%	\$46,249	\$35,982	\$39,315	v/s	\$46,249	\$35,982	\$47,301	\$41,041	\$30,731	\$39,315	\$40,465	\$30,198	\$39,315	\$35,258	\$24,947	\$39,315	\$35,258	\$24,947	\$47,301	
Chatham (South)	60 Years (2 Life Cycles)	8.5%	\$45,148	\$34,875	\$42,540	v/s	\$45,148	\$34,875	\$49,720	\$40,272	\$29,957	\$42,540	\$39,364	\$29,091	\$42,540	\$34,488	\$24,174	\$42,540	\$34,488	\$24,174	\$49,720	
Guelph (South)	60 Years (2 Life Cycles)	8.5%	\$46,466	\$36,199	\$39,826	v/s	\$46,466	\$36,199	\$48,049	\$41,193	\$30,883	\$39,826	\$40,683	\$30,416	\$39,826	\$35,409	\$25,099	\$39,826	\$35,409	\$25,099	\$48,049	
Hamilton (South)	60 Years (2 Life Cycles)	8.5%	\$45,962	\$35,695	\$44,251	v/s	\$45,962	\$35,695	\$52,034	\$40,841	\$30,531	\$44,251	\$40,179	\$29,912	\$44,251	\$35,057	\$24,747	\$44,251	\$35,057	\$24,747	\$52,034	
Kingston (South)	60 Years (2 Life Cycles)	8.5%	\$57,138	\$43,405	\$47,643	v/s	\$57,138	\$43,405	\$55,931	\$51,558	\$37,780	\$47,643	\$51,354	\$37,621	\$47,643	\$45,774	\$31,996	\$47,643	\$45,774	\$31,996	\$55,931	
Kitchener-Waterloo (South)	60 Years (2 Life Cycles)	8.5%	\$56,808	\$43,075	\$44,964	v/s	\$56,808	\$43,075	\$53,205	\$51,327	\$37,550	\$44,964	\$51,025	\$37,292	\$44,964	\$45,544	\$31,766	\$44,964	\$45,544	\$31,766	\$53,205	
London (South)	60 Years (2 Life Cycles)	8.5%	\$46,253	\$35,970	\$41,873	v/s	\$46,253	\$35,970	\$49,859	\$41,044	\$30,723	\$41,873	\$40,469	\$30,187	\$41,873	\$35,260	\$24,939	\$41,873	\$35,260	\$24,939	\$49,859	
Mt. Forest (South)	60 Years (2 Life Cycles)	8.5%	\$56,940	\$36,583	\$44,765	v/s	\$56,940	\$36,583	\$53,521	\$51,419	\$31,151	\$44,765	\$51,157	\$30,799	\$44,765	\$45,636	\$25,367	\$44,765	\$45,636	\$25,367	\$53,521	
Niagara Falls (South)	60 Years (2 Life Cycles)	8.5%	\$45,365	\$35,098	\$43,467	v/s	\$45,365	\$35,098	\$50,730	\$40,423	\$30,113	\$43,467	\$39,581	\$29,314	\$43,467	\$34,640	\$24,330	\$43,467	\$34,640	\$24,330	\$50,730	
Sarnia (South)	60 Years (2 Life Cycles)	8.5%	\$44,964	\$34,668	\$42,908	v/s	\$44,964	\$34,668	\$50,241	\$40,143	\$29,812	\$42,908	\$39,180	\$28,884	\$42,908	\$34,359	\$24,029	\$42,908	\$34,359	\$24,029	\$50,241	
Simcoe (South)	60 Years (2 Life Cycles)	8.5%	\$45,704	\$35,437	\$44,840	v/s	\$45,704	\$35,437	\$52,451	\$40,661	\$30,350	\$44,840	\$39,921	\$29,654	\$44,840	\$34,877	\$24,567	\$44,840	\$34,877	\$24,567	\$52,451	
St. Catharines (South)	60 Years (2 Life Cycles)	8.5%	\$54,808	\$34,309	\$43,627	v/s	\$54,808	\$34,309	\$50,656	\$49,929	\$29,562	\$43,627	\$49,024	\$28,525	\$43,627	\$44,146	\$23,778	\$43,627	\$44,146	\$23,778	\$50,656	
Toronto (South)	60 Years (2 Life Cycles)	8.5%	\$56,446	\$36,003	\$43,717	v/s	\$56,446	\$36,003	\$51,719	\$51,074	\$30,746	\$43,717	\$50,662	\$30,220	\$43,717	\$45,290	\$24,962	\$43,717	\$45,290	\$24,962	\$51,719	
Trenton (South)	60 Years (2 Life Cycles)	8.5%	\$56,618	\$42,868	\$47,266	v/s	\$56,618	\$42,868	\$55,320	\$51,195	\$37,405	\$47,266	\$50,835	\$37,084	\$47,266	\$45,411	\$31,621	\$47,266	\$45,411	\$31,621	\$55,320	
Warton (South)	60 Years (2 Life Cycles)	8.5%	\$57,285	\$43,531	\$45,926	v/s	\$57,285	\$43,531	\$54,469	\$51,661	\$37,868	\$45,926	\$51,502	\$37,747	\$45,926	\$45,877	\$32,085	\$45,926	\$45,877	\$32,085	\$54,469	
Windsor (South)	60 Years (2 Life Cycles)	8.5%	\$45,161	\$34,896	\$42,573	v/s	\$45,161	\$34,896	\$49,771	\$40,281	\$29,972	\$42,573	\$39,378	\$29,113	\$42,573	\$34,498	\$24,189	\$42,573	\$34,498	\$24,189	\$49,771	
Barrie (Distinct)	60 Years (2 Life Cycles)	8.5%	\$57,004	\$43,244	\$41,273	v/s	\$57,004	\$43,244	\$49,363	\$51,464	\$37,668	\$41,273	\$51,221	\$37,460	\$41,273	\$45,681	\$31,884	\$41,273	\$45,681	\$31,884	\$49,363	
Muskoka (Distinct)	60 Years (2 Life Cycles)	8.5%	\$57,626	\$43,866	\$42,717	v/s	\$57,626	\$43,866	\$51,372	\$51,899	\$38,102	\$42,717	\$51,843	\$38,082	\$42,717	\$46,115	\$32,319	\$42,717	\$46,115	\$32,319	\$51,372	
Ottawa (Distinct)	60 Years (2 Life Cycles)	8.5%	\$57,057	\$43,321	\$44,097	v/s	\$57,057	\$43,321	\$52,372	\$51,501	\$37,722	\$44,097	\$51,273	\$37,538	\$44,097	\$45,717	\$31,938	\$44,097	\$45,717	\$31,938	\$52,372	
Peterborough (Distinct)	60 Years (2 Life Cycles)	8.5%	\$57,518	\$43,783	\$44,764	v/s	\$57,518	\$43,783	\$53,390	\$51,823	\$38,044	\$44,764	\$51,734	\$37,999	\$44,764	\$46,040	\$32,261	\$44,764	\$46,040	\$32,261	\$53,390	
Kapuskasing (North)	60 Years (2 Life Cycles)	8.5%	\$60,680	\$46,937	\$52,507	v/s	\$60,680	\$46,937	\$63,155	\$54,033	\$40,249	\$52,507	\$54,896	\$41,153	\$52,507	\$48,249	\$34,465	\$52,507	\$48,249	\$34,465	\$63,155	
Kenora (North)	60 Years (2 Life Cycles)	8.5%	\$59,984	\$46,235	\$47,486	v/s	\$59,984	\$46,235	\$57,478	\$53,547	\$39,758	\$47,486	\$54,200	\$40,452	\$47,486	\$47,763	\$33,975	\$47,486	\$47,763	\$33,975	\$57,478	
North Bay (North)	60 Years (2 Life Cycles)	8.5%	\$57,621	\$43,911	\$44,114	v/s	\$57,621	\$43,911	\$52,823	\$51,895	\$38,134	\$44,114	\$51,837	\$38,127	\$44,114	\$46,111	\$32,350	\$44,114	\$46,111	\$32,350	\$52,823	
Sault Ste. Marie (North)	60 Years (2 Life Cycles)	8.5%	\$47,618	\$37,378	\$42,835	v/s	\$47,618	\$37,378	\$51,739	\$41,998	\$31,707	\$42,835	\$41,834	\$31,594	\$42,835	\$36,214	\$25,923	\$42,835	\$36,214	\$25,923	\$51,739	
Sudbury (North)	60 Years (2 Life Cycles)	8.5%	\$58,233	\$44,529	\$47,585	v/s	\$58,233	\$44,529	\$56,919	\$52,323	\$38,566	\$47,585	\$52,450	\$38,746	\$47,585	\$46,540	\$32,782	\$47,585	\$46,540	\$32,782	\$56,919	
Timmins (North)	60 Years (2 Life Cycles)	8.5%	\$59,255	\$45,553	\$47,925	v/s	\$59,255	\$45,553	\$58,196	\$53,037	\$39,281	\$47,925	\$53,471	\$39,769	\$47,925	\$47,254	\$33,498	\$47,925	\$47,254	\$33,498	\$58,196	
Thunder Bay (North)	60 Years (2 Life Cycles)	8.5%	\$59,666	\$45,942	\$46,616	v/s	\$59,666	\$45,942	\$56,478	\$53,324	\$39,554	\$46,616	\$53,882	\$40,159	\$46,616	\$47,541	\$33,770	\$46,616	\$47,541	\$33,770	\$56,478	

Table 11g: Rankings of the Cities Based on present values for V.GSHP, H.GSHP (two life cycles) and Traditional HVAC Applications (five life cycles) at a discount rate of 8.5% for improved construction scenario

			Total Present Value																		
			Main Scenario			v/s	Comparative Scenarios														
			Base Case Scenario			v/s	Carbon Taxes - (#1)			FIT - (#2)			Rebates - (#3)			(FIT+Rebates) - (#4)			(FIT+Rebates) + Carbon Taxes - (#5)		
City	Project Life Span	Discount Rate	V.GSHP	H.GSHP	Traditional	v/s	V.GSHP	H.GSHP	Traditional	V.GSHP	H.GSHP	Traditional	V.GSHP	H.GSHP	Traditional	V.GSHP	H.GSHP	Traditional	V.GSHP	H.GSHP	Traditional
Cambridge (South)	60 Years (2 Life Cycles)	8.5%	\$46,249	\$35,982	\$39,315	v/s	0%	0%	20%	-11%	-15%	0%	-13%	-16%	0%	-24%	-31%	0%	-24%	-31%	20%
Chatham (South)	60 Years (2 Life Cycles)	8.5%	\$45,148	\$34,875	\$42,540	v/s	0%	0%	17%	-11%	-14%	0%	-13%	-17%	0%	-24%	-31%	0%	-24%	-31%	17%
Guelph (South)	60 Years (2 Life Cycles)	8.5%	\$46,466	\$36,199	\$39,826	v/s	0%	0%	21%	-11%	-15%	0%	-12%	-16%	0%	-24%	-31%	0%	-24%	-31%	21%
Hamilton (South)	60 Years (2 Life Cycles)	8.5%	\$45,962	\$35,695	\$44,251	v/s	0%	0%	18%	-11%	-14%	0%	-13%	-16%	0%	-24%	-31%	0%	-24%	-31%	18%
Kingston (South)	60 Years (2 Life Cycles)	8.5%	\$57,138	\$43,405	\$47,643	v/s	0%	0%	17%	-10%	-13%	0%	-10%	-13%	0%	-20%	-26%	0%	-20%	-26%	17%
Kitchener-Waterloo (South)	60 Years (2 Life Cycles)	8.5%	\$56,808	\$43,075	\$44,964	v/s	0%	0%	18%	-10%	-13%	0%	-10%	-13%	0%	-20%	-26%	0%	-20%	-26%	18%
London (South)	60 Years (2 Life Cycles)	8.5%	\$46,253	\$35,970	\$41,873	v/s	0%	0%	19%	-11%	-15%	0%	-13%	-16%	0%	-24%	-31%	0%	-24%	-31%	19%
Mt. Forest (South)	60 Years (2 Life Cycles)	8.5%	\$56,940	\$36,583	\$44,765	v/s	0%	0%	20%	-10%	-15%	0%	-10%	-16%	0%	-20%	-31%	0%	-20%	-31%	20%
Niagara Falls (South)	60 Years (2 Life Cycles)	8.5%	\$45,365	\$35,098	\$43,467	v/s	0%	0%	17%	-11%	-14%	0%	-13%	-16%	0%	-24%	-31%	0%	-24%	-31%	17%
Sarnia (South)	60 Years (2 Life Cycles)	8.5%	\$44,964	\$34,668	\$42,908	v/s	0%	0%	17%	-11%	-14%	0%	-13%	-17%	0%	-24%	-31%	0%	-24%	-31%	17%
Simcoe (South)	60 Years (2 Life Cycles)	8.5%	\$45,704	\$35,437	\$44,840	v/s	0%	0%	17%	-11%	-14%	0%	-13%	-16%	0%	-24%	-31%	0%	-24%	-31%	17%
St. Catharines (South)	60 Years (2 Life Cycles)	8.5%	\$54,808	\$34,309	\$43,627	v/s	0%	0%	16%	-9%	-14%	0%	-11%	-17%	0%	-19%	-31%	0%	-19%	-31%	16%
Toronto (South)	60 Years (2 Life Cycles)	8.5%	\$56,446	\$36,003	\$43,717	v/s	0%	0%	18%	-10%	-15%	0%	-10%	-16%	0%	-20%	-31%	0%	-20%	-31%	18%
Trenton (South)	60 Years (2 Life Cycles)	8.5%	\$56,618	\$42,868	\$47,266	v/s	0%	0%	17%	-10%	-13%	0%	-10%	-13%	0%	-20%	-26%	0%	-20%	-26%	17%
Warton (South)	60 Years (2 Life Cycles)	8.5%	\$57,285	\$43,531	\$45,926	v/s	0%	0%	19%	-10%	-13%	0%	-10%	-13%	0%	-20%	-26%	0%	-20%	-26%	19%
Windsor (South)	60 Years (2 Life Cycles)	8.5%	\$45,161	\$34,896	\$42,573	v/s	0%	0%	17%	-11%	-14%	0%	-13%	-17%	0%	-24%	-31%	0%	-24%	-31%	17%
Barrie (Distinct)	60 Years (2 Life Cycles)	8.5%	\$57,004	\$43,244	\$41,273	v/s	0%	0%	20%	-10%	-13%	0%	-10%	-13%	0%	-20%	-26%	0%	-20%	-26%	20%
Muskoka (Distinct)	60 Years (2 Life Cycles)	8.5%	\$57,626	\$43,866	\$42,717	v/s	0%	0%	20%	-10%	-13%	0%	-10%	-13%	0%	-20%	-26%	0%	-20%	-26%	20%
Ottawa (Distinct)	60 Years (2 Life Cycles)	8.5%	\$57,057	\$43,321	\$44,097	v/s	0%	0%	19%	-10%	-13%	0%	-10%	-13%	0%	-20%	-26%	0%	-20%	-26%	19%
Peterborough (Distinct)	60 Years (2 Life Cycles)	8.5%	\$57,518	\$43,783	\$44,764	v/s	0%	0%	19%	-10%	-13%	0%	-10%	-13%	0%	-20%	-26%	0%	-20%	-26%	19%
Kapuskasing (North)	60 Years (2 Life Cycles)	8.5%	\$60,680	\$46,937	\$52,507	v/s	0%	0%	20%	-11%	-14%	0%	-10%	-12%	0%	-20%	-27%	0%	-20%	-27%	20%
Kenora (North)	60 Years (2 Life Cycles)	8.5%	\$59,984	\$46,235	\$47,486	v/s	0%	0%	21%	-11%	-14%	0%	-10%	-13%	0%	-20%	-27%	0%	-20%	-27%	21%
North Bay (North)	60 Years (2 Life Cycles)	8.5%	\$57,621	\$43,911	\$44,114	v/s	0%	0%	20%	-10%	-13%	0%	-10%	-13%	0%	-20%	-26%	0%	-20%	-26%	20%
Sault Ste. Marie (North)	60 Years (2 Life Cycles)	8.5%	\$47,618	\$37,378	\$42,835	v/s	0%	0%	21%	-12%	-15%	0%	-12%	-15%	0%	-24%	-31%	0%	-24%	-31%	21%
Sudbury (North)	60 Years (2 Life Cycles)	8.5%	\$58,233	\$44,529	\$47,585	v/s	0%	0%	20%	-10%	-13%	0%	-10%	-13%	0%	-20%	-26%	0%	-20%	-26%	20%
Timmins (North)	60 Years (2 Life Cycles)	8.5%	\$59,255	\$45,553	\$47,925	v/s	0%	0%	21%	-10%	-14%	0%	-10%	-13%	0%	-20%	-26%	0%	-20%	-26%	21%
Thunder Bay (North)	60 Years (2 Life Cycles)	8.5%	\$59,666	\$45,942	\$46,616	v/s	0%	0%	21%	-11%	-14%	0%	-10%	-13%	0%	-20%	-26%	0%	-20%	-26%	21%

Table 11h: % change in present values for comparative scenarios in regards to the main scenario for V.GSHP, H.GSHP (two life cycles) and Traditional HVAC Applications (five life cycles) at a discount rate of 8.5% for improved construction scenario

		Total Present Value																				
		Main Scenario					v/s	Comparative Scenarios														
		Base Case Scenario					v/s	Carbon Taxes - (#1)			FIT - (#2)			Rebates - (#3)			(FIT+Rebates) - (#4)			(FIT+Rebates) + Carbon Taxes - (#5)		
City	Project Life Span	Discount Rate	V.GSHP	H.GSHP	Traditional	v/s	V.GSHP	H.GSHP	Traditional	V.GSHP	H.GSHP	Traditional	V.GSHP	H.GSHP	Traditional	V.GSHP	H.GSHP	Traditional	V.GSHP	H.GSHP	Traditional	
Cambridge (South)	60 Years (2 Life Cycles)	10%	\$42,137	\$32,325	\$33,830	v/s	\$42,137	\$32,325	\$39,811	\$37,692	\$27,842	\$33,830	\$36,618	\$26,806	\$33,830	\$32,173	\$22,323	\$33,830	\$32,173	\$22,323	\$39,811	
Chatham (South)	60 Years (2 Life Cycles)	10%	\$41,204	\$31,387	\$36,663	v/s	\$41,204	\$31,387	\$42,040	\$37,042	\$27,189	\$36,663	\$35,685	\$25,868	\$36,663	\$31,523	\$21,670	\$36,663	\$31,523	\$21,670	\$42,040	
Guelph (South)	60 Years (2 Life Cycles)	10%	\$42,321	\$32,509	\$34,261	v/s	\$42,321	\$32,509	\$40,419	\$37,820	\$27,971	\$34,261	\$36,802	\$26,990	\$34,261	\$32,301	\$22,452	\$34,261	\$32,301	\$22,452	\$40,419	
Hamilton (South)	60 Years (2 Life Cycles)	10%	\$41,894	\$32,082	\$38,106	v/s	\$41,894	\$32,082	\$43,935	\$37,523	\$27,673	\$38,106	\$36,375	\$26,563	\$38,106	\$32,004	\$22,154	\$38,106	\$32,004	\$22,154	\$43,935	
Kingston (South)	60 Years (2 Life Cycles)	10%	\$52,347	\$39,226	\$41,068	v/s	\$52,347	\$39,226	\$47,274	\$47,584	\$34,425	\$41,068	\$46,828	\$33,707	\$41,068	\$42,065	\$28,906	\$41,068	\$42,065	\$28,906	\$47,274	
Kitchener-Waterloo (South)	60 Years (2 Life Cycles)	10%	\$52,068	\$38,947	\$38,706	v/s	\$52,068	\$38,947	\$44,878	\$47,389	\$34,231	\$38,706	\$46,549	\$33,428	\$38,706	\$41,870	\$28,712	\$38,706	\$41,870	\$28,712	\$44,878	
London (South)	60 Years (2 Life Cycles)	10%	\$42,141	\$32,315	\$36,044	v/s	\$42,141	\$32,315	\$42,025	\$37,694	\$27,836	\$36,044	\$36,622	\$26,796	\$36,044	\$32,175	\$22,317	\$36,044	\$32,175	\$22,317	\$42,025	
Mt. Forest (South)	60 Years (2 Life Cycles)	10%	\$52,180	\$32,834	\$38,532	v/s	\$52,180	\$32,834	\$45,090	\$47,467	\$28,197	\$38,532	\$46,661	\$27,315	\$38,532	\$41,948	\$22,678	\$38,532	\$41,948	\$22,678	\$45,090	
Niagara Falls (South)	60 Years (2 Life Cycles)	10%	\$41,388	\$31,576	\$37,447	v/s	\$41,388	\$31,576	\$42,886	\$37,170	\$27,321	\$37,447	\$35,869	\$26,057	\$37,447	\$31,651	\$21,802	\$37,447	\$31,651	\$21,802	\$42,886	
Sarnia (South)	60 Years (2 Life Cycles)	10%	\$41,048	\$31,211	\$36,973	v/s	\$41,048	\$31,211	\$42,465	\$36,933	\$27,067	\$36,973	\$35,529	\$25,692	\$36,973	\$31,414	\$21,548	\$36,973	\$31,414	\$21,548	\$42,465	
Simcoe (South)	60 Years (2 Life Cycles)	10%	\$41,676	\$31,863	\$38,653	v/s	\$41,676	\$31,863	\$44,353	\$37,371	\$27,521	\$38,653	\$36,157	\$26,344	\$38,653	\$31,851	\$22,002	\$38,653	\$31,851	\$22,002	\$44,353	
St. Catharines (South)	60 Years (2 Life Cycles)	10%	\$50,373	\$30,907	\$37,585	v/s	\$50,373	\$30,907	\$42,849	\$46,208	\$26,855	\$37,585	\$44,854	\$25,388	\$37,585	\$40,689	\$21,336	\$37,585	\$40,689	\$21,336	\$42,849	
Toronto (South)	60 Years (2 Life Cycles)	10%	\$51,761	\$32,343	\$37,652	v/s	\$51,761	\$32,343	\$43,644	\$47,175	\$27,855	\$37,652	\$46,242	\$26,824	\$37,652	\$41,656	\$22,336	\$37,652	\$41,656	\$22,336	\$43,644	
Trenton (South)	60 Years (2 Life Cycles)	10%	\$51,907	\$38,771	\$40,751	v/s	\$51,907	\$38,771	\$46,782	\$47,277	\$34,108	\$40,751	\$46,388	\$33,252	\$40,751	\$41,758	\$28,589	\$40,751	\$41,758	\$28,589	\$46,782	
Warton (South)	60 Years (2 Life Cycles)	10%	\$52,472	\$39,333	\$39,564	v/s	\$52,472	\$39,333	\$45,962	\$47,671	\$34,499	\$39,564	\$46,953	\$33,814	\$39,564	\$42,152	\$28,980	\$39,564	\$42,152	\$28,980	\$45,962	
Windsor (South)	60 Years (2 Life Cycles)	10%	\$41,216	\$31,405	\$36,691	v/s	\$41,216	\$31,405	\$42,081	\$37,050	\$27,202	\$36,691	\$35,697	\$25,886	\$36,691	\$31,531	\$21,683	\$36,691	\$31,531	\$21,683	\$42,081	
Barrie (Distinct)	60 Years (2 Life Cycles)	10%	\$52,234	\$39,090	\$35,534	v/s	\$52,234	\$39,090	\$41,593	\$47,505	\$34,330	\$35,534	\$46,715	\$33,571	\$35,534	\$41,986	\$28,811	\$35,534	\$41,986	\$28,811	\$41,593	
Muskoka (Distinct)	60 Years (2 Life Cycles)	10%	\$52,761	\$39,617	\$36,752	v/s	\$52,761	\$39,617	\$43,234	\$47,872	\$34,697	\$36,752	\$47,242	\$34,098	\$36,752	\$42,353	\$29,178	\$36,752	\$42,353	\$29,178	\$43,234	
Ottawa (Distinct)	60 Years (2 Life Cycles)	10%	\$52,278	\$39,156	\$37,971	v/s	\$52,278	\$39,156	\$44,168	\$47,536	\$34,376	\$37,971	\$46,759	\$33,637	\$37,971	\$42,017	\$28,857	\$37,971	\$42,017	\$28,857	\$44,168	
Peterborough (Distinct)	60 Years (2 Life Cycles)	10%	\$52,669	\$39,547	\$38,532	v/s	\$52,669	\$39,547	\$44,993	\$47,808	\$34,648	\$38,532	\$47,150	\$34,028	\$38,532	\$42,289	\$29,129	\$38,532	\$42,289	\$29,129	\$44,993	
Kapuskasing (North)	60 Years (2 Life Cycles)	10%	\$55,348	\$42,219	\$45,166	v/s	\$55,348	\$42,219	\$53,140	\$49,674	\$36,510	\$45,166	\$49,829	\$36,700	\$45,166	\$44,155	\$30,991	\$45,166	\$44,155	\$30,991	\$53,140	
Kenora (North)	60 Years (2 Life Cycles)	10%	\$54,759	\$41,625	\$40,826	v/s	\$54,759	\$41,625	\$48,309	\$49,264	\$36,096	\$40,826	\$49,239	\$36,106	\$40,826	\$43,745	\$30,577	\$40,826	\$43,745	\$30,577	\$48,309	
North Bay (North)	60 Years (2 Life Cycles)	10%	\$52,756	\$39,655	\$37,981	v/s	\$52,756	\$39,655	\$44,504	\$47,869	\$34,724	\$37,981	\$47,237	\$34,136	\$37,981	\$42,350	\$29,205	\$37,981	\$42,350	\$29,205	\$44,504	
Sault Ste. Marie (North)	60 Years (2 Life Cycles)	10%	\$43,297	\$33,507	\$36,850	v/s	\$43,297	\$33,507	\$43,518	\$38,500	\$28,666	\$36,850	\$37,778	\$27,988	\$36,850	\$32,981	\$23,147	\$36,850	\$32,981	\$23,147	\$43,518	
Sudbury (North)	60 Years (2 Life Cycles)	10%	\$53,275	\$40,179	\$40,962	v/s	\$53,275	\$40,179	\$47,952	\$48,230	\$35,089	\$40,962	\$47,756	\$34,660	\$40,962	\$42,711	\$29,570	\$40,962	\$42,711	\$29,570	\$47,952	
Timmins (North)	60 Years (2 Life Cycles)	10%	\$54,141	\$41,046	\$41,195	v/s	\$54,141	\$41,046	\$48,887	\$48,833	\$35,693	\$41,195	\$48,622	\$35,527	\$41,195	\$43,314	\$30,174	\$41,195	\$43,314	\$30,174	\$48,887	
Thunder Bay (North)	60 Years (2 Life Cycles)	10%	\$54,489	\$41,376	\$40,090	v/s	\$54,489	\$41,376	\$47,475	\$49,076	\$35,923	\$40,090	\$48,970	\$35,857	\$40,090	\$43,557	\$30,404	\$40,090	\$43,557	\$30,404	\$47,475	

Table 11i: Rankings of the Cities Based on present values for V.GSHP, H.GSHP (two life cycles) and Traditional HVAC Applications (five life cycles) at a discount rate of 10% for improved construction scenario

		Total Present Value																			
		Main Scenario					v/s	Comparative Scenarios													
		Base Case Scenario			v/s	Carbon Taxes - (#1)			FIT - (#2)			Rebates - (#3)			(FIT+Rebates) - (#4)			(FIT+Rebates) + Carbon Taxes - (#5)			
City	Project Life Span	Discount Rate	V.GSHP	H.GSHP	Traditional	v/s	V.GSHP	H.GSHP	Traditional	V.GSHP	H.GSHP	Traditional	V.GSHP	H.GSHP	Traditional	V.GSHP	H.GSHP	Traditional	V.GSHP	H.GSHP	Traditional
Cambridge (South)	60 Years (2 Life Cycles)	10%	\$42,137	\$32,325	\$33,830	v/s	0%	0%	18%	-11%	-14%	0%	-13%	-17%	0%	-24%	-31%	0%	-24%	-31%	18%
Chatham (South)	60 Years (2 Life Cycles)	10%	\$41,204	\$31,387	\$36,663	v/s	0%	0%	15%	-10%	-13%	0%	-13%	-18%	0%	-23%	-31%	0%	-23%	-31%	15%
Guelph (South)	60 Years (2 Life Cycles)	10%	\$42,321	\$32,509	\$34,261	v/s	0%	0%	18%	-11%	-14%	0%	-13%	-17%	0%	-24%	-31%	0%	-24%	-31%	18%
Hamilton (South)	60 Years (2 Life Cycles)	10%	\$41,894	\$32,082	\$38,106	v/s	0%	0%	15%	-10%	-14%	0%	-13%	-17%	0%	-24%	-31%	0%	-24%	-31%	15%
Kingston (South)	60 Years (2 Life Cycles)	10%	\$52,347	\$39,226	\$41,068	v/s	0%	0%	15%	-9%	-12%	0%	-11%	-14%	0%	-20%	-26%	0%	-20%	-26%	15%
Kitchener-Waterloo (South)	60 Years (2 Life Cycles)	10%	\$52,068	\$38,947	\$38,706	v/s	0%	0%	16%	-9%	-12%	0%	-11%	-14%	0%	-20%	-26%	0%	-20%	-26%	16%
London (South)	60 Years (2 Life Cycles)	10%	\$42,141	\$32,315	\$36,044	v/s	0%	0%	17%	-11%	-14%	0%	-13%	-17%	0%	-24%	-31%	0%	-24%	-31%	17%
Mt. Forest (South)	60 Years (2 Life Cycles)	10%	\$52,180	\$32,834	\$38,532	v/s	0%	0%	17%	-9%	-14%	0%	-11%	-17%	0%	-20%	-31%	0%	-20%	-31%	17%
Niagara Falls (South)	60 Years (2 Life Cycles)	10%	\$41,388	\$31,576	\$37,447	v/s	0%	0%	15%	-10%	-13%	0%	-13%	-17%	0%	-24%	-31%	0%	-24%	-31%	15%
Sarnia (South)	60 Years (2 Life Cycles)	10%	\$41,048	\$31,211	\$36,973	v/s	0%	0%	15%	-10%	-13%	0%	-13%	-18%	0%	-23%	-31%	0%	-23%	-31%	15%
Simcoe (South)	60 Years (2 Life Cycles)	10%	\$41,676	\$31,863	\$38,653	v/s	0%	0%	15%	-10%	-14%	0%	-13%	-17%	0%	-24%	-31%	0%	-24%	-31%	15%
St. Catharines (South)	60 Years (2 Life Cycles)	10%	\$50,373	\$30,907	\$37,585	v/s	0%	0%	14%	-8%	-13%	0%	-11%	-18%	0%	-19%	-31%	0%	-19%	-31%	14%
Toronto (South)	60 Years (2 Life Cycles)	10%	\$51,761	\$32,343	\$37,652	v/s	0%	0%	16%	-9%	-14%	0%	-11%	-17%	0%	-20%	-31%	0%	-20%	-31%	16%
Trenton (South)	60 Years (2 Life Cycles)	10%	\$51,907	\$38,771	\$40,751	v/s	0%	0%	15%	-9%	-12%	0%	-11%	-14%	0%	-20%	-26%	0%	-20%	-26%	15%
Warton (South)	60 Years (2 Life Cycles)	10%	\$52,472	\$39,333	\$39,564	v/s	0%	0%	16%	-9%	-12%	0%	-11%	-14%	0%	-20%	-26%	0%	-20%	-26%	16%
Windsor (South)	60 Years (2 Life Cycles)	10%	\$41,216	\$31,405	\$36,691	v/s	0%	0%	15%	-10%	-13%	0%	-13%	-18%	0%	-23%	-31%	0%	-23%	-31%	15%
Barrie (Distinct)	60 Years (2 Life Cycles)	10%	\$52,234	\$39,090	\$35,534	v/s	0%	0%	17%	-9%	-12%	0%	-11%	-14%	0%	-20%	-26%	0%	-20%	-26%	17%
Muskoka (Distinct)	60 Years (2 Life Cycles)	10%	\$52,761	\$39,617	\$36,752	v/s	0%	0%	18%	-9%	-12%	0%	-10%	-14%	0%	-20%	-26%	0%	-20%	-26%	18%
Ottawa (Distinct)	60 Years (2 Life Cycles)	10%	\$52,278	\$39,156	\$37,971	v/s	0%	0%	16%	-9%	-12%	0%	-11%	-14%	0%	-20%	-26%	0%	-20%	-26%	16%
Peterborough (Distinct)	60 Years (2 Life Cycles)	10%	\$52,669	\$39,547	\$38,532	v/s	0%	0%	17%	-9%	-12%	0%	-10%	-14%	0%	-20%	-26%	0%	-20%	-26%	17%
Kapuskasing (North)	60 Years (2 Life Cycles)	10%	\$55,348	\$42,219	\$45,166	v/s	0%	0%	18%	-10%	-14%	0%	-10%	-13%	0%	-20%	-27%	0%	-20%	-27%	18%
Kenora (North)	60 Years (2 Life Cycles)	10%	\$54,759	\$41,625	\$40,826	v/s	0%	0%	18%	-10%	-13%	0%	-10%	-13%	0%	-20%	-27%	0%	-20%	-27%	18%
North Bay (North)	60 Years (2 Life Cycles)	10%	\$52,756	\$39,655	\$37,981	v/s	0%	0%	17%	-9%	-12%	0%	-10%	-14%	0%	-20%	-26%	0%	-20%	-26%	17%
Sault Ste. Marie (North)	60 Years (2 Life Cycles)	10%	\$43,297	\$33,507	\$36,850	v/s	0%	0%	18%	-11%	-14%	0%	-13%	-16%	0%	-24%	-31%	0%	-24%	-31%	18%
Sudbury (North)	60 Years (2 Life Cycles)	10%	\$53,275	\$40,179	\$40,962	v/s	0%	0%	17%	-9%	-13%	0%	-10%	-14%	0%	-20%	-26%	0%	-20%	-26%	17%
Timmins (North)	60 Years (2 Life Cycles)	10%	\$54,141	\$41,046	\$41,195	v/s	0%	0%	19%	-10%	-13%	0%	-10%	-13%	0%	-20%	-26%	0%	-20%	-26%	19%
Thunder Bay (North)	60 Years (2 Life Cycles)	10%	\$54,489	\$41,376	\$40,090	v/s	0%	0%	18%	-10%	-13%	0%	-10%	-13%	0%	-20%	-27%	0%	-20%	-27%	18%

Table 11j: % change in present values for comparative scenarios in regards to the main scenario for V.GSHP, H.GSHP (two life cycles) and Traditional HVAC Applications (five life cycles) at a discount rate of 10% for improved construction scenario

		Total Present Value																				
		Main Scenario					v/s	Comparative Scenarios														
		Base Case Scenario			v/s	Carbon Taxes - (#1)			FIT - (#2)			Rebates - (#3)			(FIT+Rebates) - (#4)			(FIT+Rebates) + Carbon Taxes - (#5)				
City	Project Life Span	Discount Rate	V.GSHP	H.GSHP	Traditional	v/s	V.GSHP	H.GSHP	Traditional	V.GSHP	H.GSHP	Traditional	V.GSHP	H.GSHP	Traditional	V.GSHP	H.GSHP	Traditional	V.GSHP	H.GSHP	Traditional	
Cambridge (South)	60 Years (2 Life Cycles)	12%	\$38,405	\$28,961	\$28,760	v/s	\$38,405	\$28,961	\$33,045	\$34,692	\$25,218	\$28,760	\$33,102	\$23,659	\$28,760	\$29,390	\$19,916	\$28,760	\$29,390	\$19,916	\$33,045	
Chatham (South)	60 Years (2 Life Cycles)	12%	\$37,631	\$28,184	\$31,235	v/s	\$37,631	\$28,184	\$35,086	\$34,155	\$24,678	\$31,235	\$32,329	\$22,882	\$31,235	\$28,853	\$19,376	\$31,235	\$28,853	\$19,376	\$35,086	
Guelph (South)	60 Years (2 Life Cycles)	12%	\$38,557	\$29,114	\$29,115	v/s	\$38,557	\$29,114	\$33,527	\$34,798	\$25,324	\$29,115	\$33,255	\$23,811	\$29,115	\$29,496	\$20,021	\$29,115	\$29,496	\$20,021	\$33,527	
Hamilton (South)	60 Years (2 Life Cycles)	12%	\$38,203	\$28,760	\$32,426	v/s	\$38,203	\$28,760	\$36,601	\$34,552	\$25,078	\$32,426	\$32,901	\$23,458	\$32,426	\$29,250	\$19,776	\$32,426	\$29,250	\$19,776	\$36,601	
Kingston (South)	60 Years (2 Life Cycles)	12%	\$48,027	\$35,405	\$34,995	v/s	\$48,027	\$35,405	\$39,442	\$44,049	\$31,395	\$34,995	\$42,725	\$30,103	\$34,995	\$38,747	\$26,093	\$34,995	\$38,747	\$26,093	\$39,442	
Kitchener-Waterloo (South)	60 Years (2 Life Cycles)	12%	\$47,796	\$35,174	\$32,919	v/s	\$47,796	\$35,174	\$37,340	\$43,888	\$31,235	\$32,919	\$42,493	\$29,871	\$32,919	\$38,586	\$25,932	\$32,919	\$38,586	\$25,932	\$37,340	
London (South)	60 Years (2 Life Cycles)	12%	\$38,407	\$28,953	\$30,655	v/s	\$38,407	\$28,953	\$34,939	\$34,694	\$25,212	\$30,655	\$33,105	\$23,651	\$30,655	\$29,392	\$19,910	\$30,655	\$29,392	\$19,910	\$34,939	
Mt. Forest (South)	60 Years (2 Life Cycles)	12%	\$47,888	\$29,383	\$32,771	v/s	\$47,888	\$29,383	\$37,469	\$43,953	\$25,511	\$32,771	\$42,586	\$24,081	\$32,771	\$38,650	\$20,209	\$32,771	\$38,650	\$20,209	\$37,469	
Niagara Falls (South)	60 Years (2 Life Cycles)	12%	\$37,784	\$28,341	\$31,884	v/s	\$37,784	\$28,341	\$35,780	\$34,261	\$24,787	\$31,884	\$32,482	\$23,038	\$31,884	\$28,959	\$19,485	\$31,884	\$28,959	\$19,485	\$35,780	
Sarnia (South)	60 Years (2 Life Cycles)	12%	\$37,502	\$28,038	\$31,490	v/s	\$37,502	\$28,038	\$35,425	\$34,066	\$24,577	\$31,490	\$32,200	\$22,736	\$31,490	\$28,763	\$19,275	\$31,490	\$28,763	\$19,275	\$35,425	
Simcoe (South)	60 Years (2 Life Cycles)	12%	\$38,022	\$28,579	\$32,940	v/s	\$38,022	\$28,579	\$37,024	\$34,427	\$24,952	\$32,940	\$32,720	\$23,276	\$32,940	\$29,124	\$19,650	\$32,940	\$29,124	\$19,650	\$37,024	
St. Catharines (South)	60 Years (2 Life Cycles)	12%	\$46,391	\$27,786	\$32,000	v/s	\$46,391	\$27,786	\$35,771	\$42,913	\$24,402	\$32,000	\$41,089	\$22,484	\$32,000	\$37,611	\$19,100	\$32,000	\$37,611	\$19,100	\$35,771	
Toronto (South)	60 Years (2 Life Cycles)	12%	\$47,541	\$28,976	\$32,047	v/s	\$47,541	\$28,976	\$36,340	\$43,712	\$25,228	\$32,047	\$42,239	\$23,674	\$32,047	\$38,409	\$19,926	\$32,047	\$38,409	\$19,926	\$36,340	
Trenton (South)	60 Years (2 Life Cycles)	12%	\$47,662	\$35,028	\$34,735	v/s	\$47,662	\$35,028	\$39,056	\$43,796	\$31,134	\$34,735	\$42,360	\$29,726	\$34,735	\$38,494	\$25,831	\$34,735	\$38,494	\$25,831	\$39,056	
Warton (South)	60 Years (2 Life Cycles)	12%	\$48,131	\$35,494	\$33,687	v/s	\$48,131	\$35,494	\$38,271	\$44,121	\$31,457	\$33,687	\$42,828	\$30,191	\$33,687	\$38,819	\$26,155	\$33,687	\$38,819	\$26,155	\$38,271	
Windsor (South)	60 Years (2 Life Cycles)	12%	\$37,641	\$28,199	\$31,257	v/s	\$37,641	\$28,199	\$35,119	\$34,162	\$24,689	\$31,257	\$32,339	\$22,897	\$31,257	\$28,860	\$19,386	\$31,257	\$28,860	\$19,386	\$35,119	
Barrie (Distinct)	60 Years (2 Life Cycles)	12%	\$47,933	\$35,292	\$30,231	v/s	\$47,933	\$35,292	\$34,572	\$43,984	\$31,317	\$30,231	\$42,631	\$29,990	\$30,231	\$38,682	\$26,015	\$30,231	\$38,682	\$26,015	\$34,572	
Muskoka (Distinct)	60 Years (2 Life Cycles)	12%	\$48,370	\$35,729	\$31,236	v/s	\$48,370	\$35,729	\$35,879	\$44,287	\$31,620	\$31,236	\$43,068	\$30,427	\$31,236	\$38,985	\$26,318	\$31,236	\$38,985	\$26,318	\$35,879	
Ottawa (Distinct)	60 Years (2 Life Cycles)	12%	\$47,970	\$35,347	\$32,309	v/s	\$47,970	\$35,347	\$36,749	\$44,009	\$31,355	\$32,309	\$42,668	\$30,044	\$32,309	\$38,707	\$26,052	\$32,309	\$38,707	\$26,052	\$36,749	
Peterborough (Distinct)	60 Years (2 Life Cycles)	12%	\$48,294	\$35,671	\$32,772	v/s	\$48,294	\$35,671	\$37,400	\$44,234	\$31,580	\$32,772	\$42,992	\$30,368	\$32,772	\$38,932	\$26,277	\$32,772	\$38,932	\$26,277	\$37,400	
Kapuskasing (North)	60 Years (2 Life Cycles)	12%	\$50,514	\$37,885	\$38,372	v/s	\$50,514	\$37,885	\$44,085	\$45,776	\$33,117	\$38,372	\$45,212	\$32,583	\$38,372	\$40,473	\$27,815	\$38,372	\$40,473	\$27,815	\$44,085	
Kenora (North)	60 Years (2 Life Cycles)	12%	\$50,026	\$37,393	\$34,661	v/s	\$50,026	\$37,393	\$40,022	\$45,436	\$32,775	\$34,661	\$44,723	\$32,090	\$34,661	\$40,134	\$27,473	\$34,661	\$40,134	\$27,473	\$40,022	
North Bay (North)	60 Years (2 Life Cycles)	12%	\$48,366	\$35,760	\$32,314	v/s	\$48,366	\$35,760	\$36,987	\$44,284	\$31,642	\$32,314	\$43,064	\$30,458	\$32,314	\$38,982	\$26,340	\$32,314	\$38,982	\$26,340	\$36,987	
Sault Ste. Marie (North)	60 Years (2 Life Cycles)	12%	\$39,366	\$29,941	\$31,315	v/s	\$39,366	\$29,941	\$36,092	\$35,359	\$25,898	\$31,315	\$34,063	\$24,639	\$31,315	\$30,057	\$20,596	\$31,315	\$30,057	\$20,596	\$36,092	
Sudbury (North)	60 Years (2 Life Cycles)	12%	\$48,796	\$36,195	\$34,839	v/s	\$48,796	\$36,195	\$39,847	\$44,583	\$31,944	\$34,839	\$43,494	\$30,892	\$34,839	\$39,281	\$26,641	\$34,839	\$39,281	\$26,641	\$39,847	
Timmins (North)	60 Years (2 Life Cycles)	12%	\$49,514	\$36,913	\$34,965	v/s	\$49,514	\$36,913	\$40,475	\$45,081	\$32,443	\$34,965	\$44,211	\$31,611	\$34,965	\$39,779	\$27,140	\$34,965	\$39,779	\$27,140	\$40,475	
Thunder Bay (North)	60 Years (2 Life Cycles)	12%	\$49,802	\$37,187	\$34,052	v/s	\$49,802	\$37,187	\$39,343	\$45,281	\$32,633	\$34,052	\$44,500	\$31,885	\$34,052	\$39,979	\$27,330	\$34,052	\$39,979	\$27,330	\$39,343	

Table 11k: Rankings of the Cities Based on present values for V.GSHP, H.GSHP (two life cycles) and Traditional HVAC Applications (five life cycles) at a discount rate of 12% for improved construction scenario

			Total Present Value																		
			Main Scenario			v/s	Comparative Scenarios														
			Base Case Scenario			v/s	Carbon Taxes - (€1)			FIT - (€2)			Rebates - (€3)			(FIT+Rebates) - (€4)			(FIT+Rebates) + Carbon Taxes - (€5)		
City	Project Life Span	Discount Rate	V.GSHP	H.GSHP	Traditional	v/s	V.GSHP	H.GSHP	Traditional	V.GSHP	H.GSHP	Traditional	V.GSHP	H.GSHP	Traditional	V.GSHP	H.GSHP	Traditional	V.GSHP	H.GSHP	Traditional
Cambridge (South)	60 Years (2 Life Cycles)	12%	\$38,405	\$28,961	\$28,760	v/s	0%	0%	15%	-10%	-13%	0%	-14%	-18%	0%	-23%	-31%	0%	-23%	-31%	15%
Chatham (South)	60 Years (2 Life Cycles)	12%	\$37,631	\$28,184	\$31,235	v/s	0%	0%	12%	-9%	-12%	0%	-14%	-19%	0%	-23%	-31%	0%	-23%	-31%	12%
Guelph (South)	60 Years (2 Life Cycles)	12%	\$38,557	\$29,114	\$29,115	v/s	0%	0%	15%	-10%	-13%	0%	-14%	-18%	0%	-24%	-31%	0%	-24%	-31%	15%
Hamilton (South)	60 Years (2 Life Cycles)	12%	\$38,203	\$28,760	\$32,426	v/s	0%	0%	13%	-10%	-13%	0%	-14%	-18%	0%	-23%	-31%	0%	-23%	-31%	13%
Kingston (South)	60 Years (2 Life Cycles)	12%	\$48,027	\$35,405	\$34,995	v/s	0%	0%	13%	-8%	-11%	0%	-11%	-15%	0%	-19%	-26%	0%	-19%	-26%	13%
Kitchener-Waterloo (South)	60 Years (2 Life Cycles)	12%	\$47,796	\$35,174	\$32,919	v/s	0%	0%	13%	-8%	-11%	0%	-11%	-15%	0%	-19%	-26%	0%	-19%	-26%	13%
London (South)	60 Years (2 Life Cycles)	12%	\$38,407	\$28,953	\$30,655	v/s	0%	0%	14%	-10%	-13%	0%	-14%	-18%	0%	-23%	-31%	0%	-23%	-31%	14%
Mt. Forest (South)	60 Years (2 Life Cycles)	12%	\$47,888	\$29,383	\$32,771	v/s	0%	0%	14%	-8%	-13%	0%	-11%	-18%	0%	-19%	-31%	0%	-19%	-31%	14%
Niagara Falls (South)	60 Years (2 Life Cycles)	12%	\$37,784	\$28,341	\$31,884	v/s	0%	0%	12%	-9%	-13%	0%	-14%	-19%	0%	-23%	-31%	0%	-23%	-31%	12%
Sarnia (South)	60 Years (2 Life Cycles)	12%	\$37,502	\$28,038	\$31,490	v/s	0%	0%	12%	-9%	-12%	0%	-14%	-19%	0%	-23%	-31%	0%	-23%	-31%	12%
Simcoe (South)	60 Years (2 Life Cycles)	12%	\$38,022	\$28,579	\$32,940	v/s	0%	0%	12%	-9%	-13%	0%	-14%	-19%	0%	-23%	-31%	0%	-23%	-31%	12%
St. Catharines (South)	60 Years (2 Life Cycles)	12%	\$46,391	\$27,786	\$32,000	v/s	0%	0%	12%	-7%	-12%	0%	-11%	-19%	0%	-19%	-31%	0%	-19%	-31%	12%
Toronto (South)	60 Years (2 Life Cycles)	12%	\$47,541	\$28,976	\$32,047	v/s	0%	0%	13%	-8%	-13%	0%	-11%	-18%	0%	-19%	-31%	0%	-19%	-31%	13%
Trenton (South)	60 Years (2 Life Cycles)	12%	\$47,662	\$35,028	\$34,735	v/s	0%	0%	12%	-8%	-11%	0%	-11%	-15%	0%	-19%	-26%	0%	-19%	-26%	12%
Warton (South)	60 Years (2 Life Cycles)	12%	\$48,131	\$35,494	\$33,687	v/s	0%	0%	14%	-8%	-11%	0%	-11%	-15%	0%	-19%	-26%	0%	-19%	-26%	14%
Windsor (South)	60 Years (2 Life Cycles)	12%	\$37,641	\$28,199	\$31,257	v/s	0%	0%	12%	-9%	-12%	0%	-14%	-19%	0%	-23%	-31%	0%	-23%	-31%	12%
Barrie (Distinct)	60 Years (2 Life Cycles)	12%	\$47,933	\$35,292	\$30,231	v/s	0%	0%	14%	-8%	-11%	0%	-11%	-15%	0%	-19%	-26%	0%	-19%	-26%	14%
Muskoka (Distinct)	60 Years (2 Life Cycles)	12%	\$48,370	\$35,729	\$31,236	v/s	0%	0%	15%	-8%	-11%	0%	-11%	-15%	0%	-19%	-26%	0%	-19%	-26%	15%
Ottawa (Distinct)	60 Years (2 Life Cycles)	12%	\$47,970	\$35,347	\$32,309	v/s	0%	0%	14%	-8%	-11%	0%	-11%	-15%	0%	-19%	-26%	0%	-19%	-26%	14%
Peterborough (Distinct)	60 Years (2 Life Cycles)	12%	\$48,294	\$35,671	\$32,772	v/s	0%	0%	14%	-8%	-11%	0%	-11%	-15%	0%	-19%	-26%	0%	-19%	-26%	14%
Kapuskasing (North)	60 Years (2 Life Cycles)	12%	\$50,514	\$37,885	\$38,372	v/s	0%	0%	15%	-9%	-13%	0%	-10%	-14%	0%	-20%	-27%	0%	-20%	-27%	15%
Kenora (North)	60 Years (2 Life Cycles)	12%	\$50,026	\$37,393	\$34,661	v/s	0%	0%	15%	-9%	-12%	0%	-11%	-14%	0%	-20%	-27%	0%	-20%	-27%	15%
North Bay (North)	60 Years (2 Life Cycles)	12%	\$48,366	\$35,760	\$32,314	v/s	0%	0%	14%	-8%	-12%	0%	-11%	-15%	0%	-19%	-26%	0%	-19%	-26%	14%
Sault Ste. Marie (North)	60 Years (2 Life Cycles)	12%	\$39,366	\$29,941	\$31,315	v/s	0%	0%	15%	-10%	-14%	0%	-13%	-18%	0%	-24%	-31%	0%	-24%	-31%	15%
Sudbury (North)	60 Years (2 Life Cycles)	12%	\$48,796	\$36,195	\$34,839	v/s	0%	0%	14%	-9%	-12%	0%	-11%	-15%	0%	-20%	-26%	0%	-20%	-26%	14%
Timmins (North)	60 Years (2 Life Cycles)	12%	\$49,514	\$36,913	\$34,965	v/s	0%	0%	16%	-9%	-12%	0%	-11%	-14%	0%	-20%	-26%	0%	-20%	-26%	16%
Thunder Bay (North)	60 Years (2 Life Cycles)	12%	\$49,802	\$37,187	\$34,052	v/s	0%	0%	16%	-9%	-12%	0%	-11%	-14%	0%	-20%	-27%	0%	-20%	-27%	16%

Table 11: % change in present values for comparative scenarios in regards to the main scenario for V.GSHP, H.GSHP (two life cycles) and Traditional HVAC Applications (five life cycles) at a discount rate of 12% for improved construction scenario

		Total Present Value																				
		Main Scenario					v/s	Comparative Scenarios														
		Base Case Scenario			v/s	Carbon Taxes - (#1)			FIT - (#2)			Rebates - (#3)			(FIT+Rebates) - (#4)			(FIT+Rebates) + Carbon Taxes - (#5)				
City	Project Life Span	Discount Rate	V.GSHP	H.GSHP	Traditional	v/s	V.GSHP	H.GSHP	Traditional	V.GSHP	H.GSHP	Traditional	V.GSHP	H.GSHP	Traditional	V.GSHP	H.GSHP	Traditional	V.GSHP	H.GSHP	Traditional	
Cambridge (South)	60 Years (3 Life Cycles)	5%	\$75,897	\$59,273	\$64,147	v/s	\$75,897	\$59,273	\$82,660	\$67,455	\$50,760	\$64,147	\$66,529	\$49,904	\$64,147	\$58,087	\$41,392	\$64,147	\$58,087	\$41,392	\$82,660	
Chatham (South)	60 Years (3 Life Cycles)	5%	\$74,066	\$57,432	\$69,170	v/s	\$74,066	\$57,432	\$85,813	\$66,161	\$49,460	\$69,170	\$64,698	\$48,064	\$69,170	\$56,793	\$40,092	\$69,170	\$56,793	\$40,092	\$85,813	
Guelph (South)	60 Years (3 Life Cycles)	5%	\$76,258	\$59,634	\$65,014	v/s	\$76,258	\$59,634	\$84,076	\$67,710	\$51,015	\$65,014	\$66,890	\$50,265	\$65,014	\$58,342	\$41,647	\$65,014	\$58,342	\$41,647	\$84,076	
Hamilton (South)	60 Years (3 Life Cycles)	5%	\$75,420	\$58,796	\$72,055	v/s	\$75,420	\$58,796	\$90,098	\$67,118	\$50,423	\$72,055	\$66,052	\$49,427	\$72,055	\$57,750	\$41,055	\$72,055	\$57,750	\$41,055	\$90,098	
Kingston (South)	60 Years (3 Life Cycles)	5%	\$93,668	\$71,429	\$77,445	v/s	\$93,668	\$71,429	\$96,658	\$84,622	\$62,311	\$77,445	\$84,300	\$62,060	\$77,445	\$75,253	\$52,942	\$77,445	\$75,253	\$52,942	\$96,658	
Kitchener-Waterloo (South)	60 Years (3 Life Cycles)	5%	\$93,120	\$70,881	\$73,273	v/s	\$93,120	\$70,881	\$92,377	\$84,235	\$61,923	\$73,273	\$83,752	\$61,512	\$73,273	\$74,866	\$52,555	\$73,273	\$74,866	\$52,555	\$92,377	
London (South)	60 Years (3 Life Cycles)	5%	\$75,904	\$59,254	\$68,258	v/s	\$75,904	\$59,254	\$86,771	\$67,460	\$50,747	\$68,258	\$66,535	\$49,885	\$68,258	\$58,091	\$41,378	\$68,258	\$58,091	\$41,378	\$86,771	
Mt. Forest (South)	60 Years (3 Life Cycles)	5%	\$93,339	\$60,272	\$72,977	v/s	\$93,339	\$60,272	\$93,276	\$84,389	\$51,466	\$72,977	\$83,971	\$50,904	\$72,977	\$75,021	\$42,098	\$72,977	\$75,021	\$42,098	\$93,276	
Niagara Falls (South)	60 Years (3 Life Cycles)	5%	\$74,427	\$57,803	\$70,716	v/s	\$74,427	\$57,803	\$87,552	\$66,417	\$49,722	\$70,716	\$65,059	\$48,434	\$70,716	\$57,048	\$40,354	\$70,716	\$57,048	\$40,354	\$87,552	
Sarnia (South)	60 Years (3 Life Cycles)	5%	\$73,760	\$57,087	\$69,792	v/s	\$73,760	\$57,087	\$86,791	\$65,945	\$49,216	\$69,792	\$64,392	\$47,719	\$69,792	\$56,577	\$39,848	\$69,792	\$56,577	\$39,848	\$86,791	
Simcoe (South)	60 Years (3 Life Cycles)	5%	\$74,992	\$58,367	\$72,880	v/s	\$74,992	\$58,367	\$90,524	\$66,815	\$50,120	\$72,880	\$65,623	\$48,999	\$72,880	\$57,447	\$40,752	\$72,880	\$57,447	\$40,752	\$90,524	
St. Catharines (South)	60 Years (3 Life Cycles)	5%	\$89,793	\$56,491	\$70,967	v/s	\$89,793	\$56,491	\$87,260	\$81,884	\$48,795	\$70,967	\$80,425	\$47,122	\$70,967	\$72,516	\$39,427	\$70,967	\$72,516	\$39,427	\$87,260	
Toronto (South)	60 Years (3 Life Cycles)	5%	\$92,517	\$59,308	\$71,183	v/s	\$92,517	\$59,308	\$89,732	\$83,809	\$50,785	\$71,183	\$83,149	\$49,940	\$71,183	\$74,440	\$41,417	\$71,183	\$74,440	\$41,417	\$89,732	
Trenton (South)	60 Years (3 Life Cycles)	5%	\$92,804	\$70,536	\$76,803	v/s	\$92,804	\$70,536	\$95,472	\$84,011	\$61,680	\$76,803	\$83,436	\$61,167	\$76,803	\$74,643	\$52,311	\$76,803	\$74,643	\$52,311	\$95,472	
Warton (South)	60 Years (3 Life Cycles)	5%	\$93,913	\$71,638	\$74,750	v/s	\$93,913	\$71,638	\$94,554	\$84,795	\$62,459	\$74,750	\$84,545	\$62,270	\$74,750	\$75,426	\$53,090	\$74,750	\$75,426	\$53,090	\$94,554	
Windsor (South)	60 Years (3 Life Cycles)	5%	\$74,089	\$57,468	\$69,226	v/s	\$74,089	\$57,468	\$85,911	\$66,177	\$49,485	\$69,226	\$64,720	\$48,099	\$69,226	\$56,809	\$40,117	\$69,226	\$56,809	\$40,117	\$85,911	
Barrie (Distinct)	60 Years (3 Life Cycles)	5%	\$93,446	\$71,161	\$67,268	v/s	\$93,446	\$71,161	\$86,022	\$84,465	\$62,122	\$67,268	\$84,077	\$61,793	\$67,268	\$75,096	\$52,753	\$67,268	\$75,096	\$52,753	\$86,022	
Muskoka (Distinct)	60 Years (3 Life Cycles)	5%	\$94,480	\$72,196	\$69,707	v/s	\$94,480	\$72,196	\$89,770	\$85,196	\$62,853	\$69,707	\$85,112	\$62,828	\$69,707	\$75,827	\$53,484	\$69,707	\$75,827	\$53,484	\$89,770	
Ottawa (Distinct)	60 Years (3 Life Cycles)	5%	\$93,533	\$71,290	\$71,833	v/s	\$93,533	\$71,290	\$91,015	\$84,526	\$62,213	\$71,833	\$84,164	\$61,922	\$71,833	\$75,158	\$52,844	\$71,833	\$75,158	\$52,844	\$91,015	
Peterborough (Distinct)	60 Years (3 Life Cycles)	5%	\$94,300	\$72,058	\$72,966	v/s	\$94,300	\$72,058	\$92,963	\$85,068	\$62,755	\$72,966	\$84,931	\$62,689	\$72,966	\$75,700	\$53,386	\$72,966	\$75,700	\$53,386	\$92,963	
Kapuskasing (North)	60 Years (3 Life Cycles)	5%	\$99,558	\$77,303	\$85,695	v/s	\$99,558	\$77,303	\$110,379	\$88,782	\$66,460	\$85,695	\$90,189	\$67,934	\$85,695	\$79,414	\$57,091	\$85,695	\$79,414	\$57,091	\$110,379	
Kenora (North)	60 Years (3 Life Cycles)	5%	\$98,400	\$76,136	\$77,586	v/s	\$98,400	\$76,136	\$100,750	\$87,965	\$65,635	\$77,586	\$89,032	\$66,767	\$77,586	\$78,596	\$56,267	\$77,586	\$78,596	\$56,267	\$100,750	
North Bay (North)	60 Years (3 Life Cycles)	5%	\$94,471	\$72,270	\$71,891	v/s	\$94,471	\$72,270	\$92,081	\$85,189	\$62,905	\$71,891	\$85,102	\$62,902	\$71,891	\$75,820	\$53,537	\$71,891	\$75,820	\$53,537	\$92,081	
Sault Ste. Marie (North)	60 Years (3 Life Cycles)	5%	\$78,173	\$61,594	\$69,921	v/s	\$78,173	\$61,594	\$90,563	\$69,063	\$52,400	\$69,921	\$68,805	\$52,226	\$69,921	\$59,694	\$43,032	\$69,921	\$59,694	\$43,032	\$90,563	
Sudbury (North)	60 Years (3 Life Cycles)	5%	\$95,489	\$73,299	\$77,563	v/s	\$95,489	\$73,299	\$99,200	\$85,908	\$63,631	\$77,563	\$86,121	\$63,930	\$77,563	\$76,540	\$54,263	\$77,563	\$76,540	\$54,263	\$99,200	
Timmins (North)	60 Years (3 Life Cycles)	5%	\$97,188	\$75,001	\$78,336	v/s	\$97,188	\$75,001	\$102,145	\$87,109	\$64,834	\$78,336	\$87,820	\$65,632	\$78,336	\$77,740	\$55,465	\$78,336	\$77,740	\$55,465	\$102,145	
Thunder Bay (North)	60 Years (3 Life Cycles)	5%	\$97,872	\$75,649	\$76,130	v/s	\$97,872	\$75,649	\$98,992	\$87,591	\$65,292	\$76,130	\$88,503	\$66,280	\$76,130	\$78,223	\$55,923	\$76,130	\$78,223	\$55,923	\$98,992	

Table 12a: Rankings of the Cities Based on present values for V.GSHP, H.GSHP (three life cycles) and Traditional HVAC Applications (five life cycles) at a discount rate of 5% for improved construction scenario

			Total Present Value																		
			Main Scenario				v/s	Comparative Scenarios													
			Base Case Scenario			v/s	Carbon Taxes - (€1)			FIT - (€2)			Rebates - (€3)			(FIT+Rebates) - (€4)			(FIT+Rebates) + Carbon Taxes - (€5)		
City	Project Life Span	Discount Rate	V.GSHP	H.GSHP	Traditional	v/s	V.GSHP	H.GSHP	Traditional	V.GSHP	H.GSHP	Traditional	V.GSHP	H.GSHP	Traditional	V.GSHP	H.GSHP	Traditional	V.GSHP	H.GSHP	Traditional
Cambridge (South)	60 Years (3 Life Cycles)	5%	\$75,897	\$59,273	\$64,147	v/s	0%	0%	29%	-11%	-14%	0%	-12%	-16%	0%	-23%	-30%	0%	-23%	-30%	29%
Chatham (South)	60 Years (3 Life Cycles)	5%	\$74,066	\$57,432	\$69,170	v/s	0%	0%	24%	-11%	-14%	0%	-13%	-16%	0%	-23%	-30%	0%	-23%	-30%	24%
Guelph (South)	60 Years (3 Life Cycles)	5%	\$76,258	\$59,634	\$65,014	v/s	0%	0%	29%	-11%	-14%	0%	-12%	-16%	0%	-23%	-30%	0%	-23%	-30%	29%
Hamilton (South)	60 Years (3 Life Cycles)	5%	\$75,420	\$58,796	\$72,055	v/s	0%	0%	25%	-11%	-14%	0%	-12%	-16%	0%	-23%	-30%	0%	-23%	-30%	25%
Kingston (South)	60 Years (3 Life Cycles)	5%	\$93,668	\$71,429	\$77,445	v/s	0%	0%	25%	-10%	-13%	0%	-10%	-13%	0%	-20%	-26%	0%	-20%	-26%	25%
Kitchener-Waterloo (South)	60 Years (3 Life Cycles)	5%	\$93,120	\$70,881	\$73,273	v/s	0%	0%	26%	-10%	-13%	0%	-10%	-13%	0%	-20%	-26%	0%	-20%	-26%	26%
London (South)	60 Years (3 Life Cycles)	5%	\$75,904	\$59,254	\$68,258	v/s	0%	0%	27%	-11%	-14%	0%	-12%	-16%	0%	-23%	-30%	0%	-23%	-30%	27%
Mt. Forest (South)	60 Years (3 Life Cycles)	5%	\$93,339	\$60,272	\$72,977	v/s	0%	0%	28%	-10%	-15%	0%	-10%	-16%	0%	-20%	-30%	0%	-20%	-30%	28%
Niagara Falls (South)	60 Years (3 Life Cycles)	5%	\$74,427	\$57,803	\$70,716	v/s	0%	0%	24%	-11%	-14%	0%	-13%	-16%	0%	-23%	-30%	0%	-23%	-30%	24%
Sarnia (South)	60 Years (3 Life Cycles)	5%	\$73,760	\$57,087	\$69,792	v/s	0%	0%	24%	-11%	-14%	0%	-13%	-16%	0%	-23%	-30%	0%	-23%	-30%	24%
Simcoe (South)	60 Years (3 Life Cycles)	5%	\$74,992	\$58,367	\$72,880	v/s	0%	0%	24%	-11%	-14%	0%	-12%	-16%	0%	-23%	-30%	0%	-23%	-30%	24%
St. Catharines (South)	60 Years (3 Life Cycles)	5%	\$89,793	\$56,491	\$70,967	v/s	0%	0%	23%	-9%	-14%	0%	-10%	-17%	0%	-19%	-30%	0%	-19%	-30%	23%
Toronto (South)	60 Years (3 Life Cycles)	5%	\$92,517	\$59,308	\$71,183	v/s	0%	0%	26%	-9%	-14%	0%	-10%	-16%	0%	-20%	-30%	0%	-20%	-30%	26%
Trenton (South)	60 Years (3 Life Cycles)	5%	\$92,804	\$70,536	\$76,803	v/s	0%	0%	24%	-9%	-13%	0%	-10%	-13%	0%	-20%	-26%	0%	-20%	-26%	24%
Warton (South)	60 Years (3 Life Cycles)	5%	\$93,913	\$71,638	\$74,750	v/s	0%	0%	26%	-10%	-13%	0%	-10%	-13%	0%	-20%	-26%	0%	-20%	-26%	26%
Windsor (South)	60 Years (3 Life Cycles)	5%	\$74,089	\$57,468	\$69,226	v/s	0%	0%	24%	-11%	-14%	0%	-13%	-16%	0%	-23%	-30%	0%	-23%	-30%	24%
Barrie (Distinct)	60 Years (3 Life Cycles)	5%	\$93,446	\$71,161	\$67,268	v/s	0%	0%	28%	-10%	-13%	0%	-10%	-13%	0%	-20%	-26%	0%	-20%	-26%	28%
Muskoka (Distinct)	60 Years (3 Life Cycles)	5%	\$94,480	\$72,196	\$69,707	v/s	0%	0%	29%	-10%	-13%	0%	-10%	-13%	0%	-20%	-26%	0%	-20%	-26%	29%
Ottawa (Distinct)	60 Years (3 Life Cycles)	5%	\$93,533	\$71,290	\$71,833	v/s	0%	0%	27%	-10%	-13%	0%	-10%	-13%	0%	-20%	-26%	0%	-20%	-26%	27%
Peterborough (Distinct)	60 Years (3 Life Cycles)	5%	\$94,300	\$72,058	\$72,966	v/s	0%	0%	27%	-10%	-13%	0%	-10%	-13%	0%	-20%	-26%	0%	-20%	-26%	27%
Kapuskasing (North)	60 Years (3 Life Cycles)	5%	\$99,558	\$77,303	\$85,695	v/s	0%	0%	29%	-11%	-14%	0%	-9%	-12%	0%	-20%	-26%	0%	-20%	-26%	29%
Kenora (North)	60 Years (3 Life Cycles)	5%	\$98,400	\$76,136	\$77,586	v/s	0%	0%	30%	-11%	-14%	0%	-10%	-12%	0%	-20%	-26%	0%	-20%	-26%	30%
North Bay (North)	60 Years (3 Life Cycles)	5%	\$94,471	\$72,270	\$71,891	v/s	0%	0%	28%	-10%	-13%	0%	-10%	-13%	0%	-20%	-26%	0%	-20%	-26%	28%
Sault Ste. Marie (North)	60 Years (3 Life Cycles)	5%	\$78,173	\$61,594	\$69,921	v/s	0%	0%	30%	-12%	-15%	0%	-12%	-15%	0%	-24%	-30%	0%	-24%	-30%	30%
Sudbury (North)	60 Years (3 Life Cycles)	5%	\$95,489	\$73,299	\$77,563	v/s	0%	0%	28%	-10%	-13%	0%	-10%	-13%	0%	-20%	-26%	0%	-20%	-26%	28%
Timmins (North)	60 Years (3 Life Cycles)	5%	\$97,188	\$75,001	\$78,336	v/s	0%	0%	30%	-10%	-14%	0%	-10%	-12%	0%	-20%	-26%	0%	-20%	-26%	30%
Thunder Bay (North)	60 Years (3 Life Cycles)	5%	\$97,872	\$75,649	\$76,130	v/s	0%	0%	30%	-11%	-14%	0%	-10%	-12%	0%	-20%	-26%	0%	-20%	-26%	30%

Table 12b: % change in present values for comparative scenarios in regards to the main scenario for V.GSHP, H.GSHP (three life cycles) and Traditional HVAC Applications (five life cycles) at a discount rate of 5% for improved construction scenario

		Total Present Value																			
		Main Scenario						Comparative Scenarios													
		Base Case Scenario			v/s	Carbon Taxes - (€1)			FIT - (€2)			Rebates - (€3)			(FIT+Rebates) - (€4)			(FIT+Rebates) + Carbon Taxes - (€5)			
City	Project Life Span	Discount Rate	V.GSHP	H.GSHP	Traditional	v/s	V.GSHP	H.GSHP	Traditional	V.GSHP	H.GSHP	Traditional	V.GSHP	H.GSHP	Traditional	V.GSHP	H.GSHP	Traditional	V.GSHP	H.GSHP	Traditional
Cambridge (South)	60 Years (3 Life Cycles)	7%	\$59,247	\$45,638	\$47,171	v/s	\$59,247	\$45,638	\$58,270	\$52,986	\$39,325	\$47,171	\$51,590	\$37,981	\$47,171	\$45,328	\$31,668	\$47,171	\$45,328	\$31,668	\$58,270
Chatham (South)	60 Years (3 Life Cycles)	7%	\$57,911	\$44,295	\$50,963	v/s	\$57,911	\$44,295	\$60,941	\$52,048	\$38,382	\$50,963	\$50,254	\$36,638	\$50,963	\$44,391	\$30,725	\$50,963	\$44,391	\$30,725	\$60,941
Guelph (South)	60 Years (3 Life Cycles)	7%	\$59,511	\$45,902	\$47,796	v/s	\$59,511	\$45,902	\$59,224	\$53,171	\$39,510	\$47,796	\$51,853	\$38,244	\$47,796	\$45,513	\$31,852	\$47,796	\$45,513	\$31,852	\$59,224
Hamilton (South)	60 Years (3 Life Cycles)	7%	\$58,899	\$45,290	\$53,050	v/s	\$58,899	\$45,290	\$63,867	\$52,741	\$39,080	\$53,050	\$51,242	\$37,633	\$53,050	\$45,084	\$31,423	\$53,050	\$45,084	\$31,423	\$63,867
Kingston (South)	60 Years (3 Life Cycles)	7%	\$73,502	\$55,303	\$57,068	v/s	\$73,502	\$55,303	\$68,587	\$66,793	\$48,541	\$57,068	\$65,845	\$47,646	\$57,068	\$59,135	\$40,884	\$57,068	\$59,135	\$40,884	\$68,587
Kitchener-Waterloo (South)	60 Years (3 Life Cycles)	7%	\$73,102	\$54,904	\$53,924	v/s	\$73,102	\$54,904	\$65,377	\$66,512	\$48,260	\$53,924	\$65,445	\$47,246	\$53,924	\$58,855	\$40,603	\$53,924	\$58,855	\$40,603	\$65,377
London (South)	60 Years (3 Life Cycles)	7%	\$59,252	\$45,624	\$50,222	v/s	\$59,252	\$45,624	\$61,321	\$52,989	\$39,315	\$50,222	\$51,595	\$37,967	\$50,222	\$45,332	\$31,658	\$50,222	\$45,332	\$31,658	\$61,321
Mt. Forest (South)	60 Years (3 Life Cycles)	7%	\$73,262	\$46,368	\$53,692	v/s	\$73,262	\$46,368	\$65,861	\$66,624	\$39,836	\$53,692	\$65,605	\$38,710	\$53,692	\$58,967	\$32,179	\$53,692	\$58,967	\$32,179	\$65,861
Niagara Falls (South)	60 Years (3 Life Cycles)	7%	\$58,174	\$44,565	\$52,089	v/s	\$58,174	\$44,565	\$62,183	\$52,233	\$38,572	\$52,089	\$50,517	\$36,908	\$52,089	\$44,576	\$30,915	\$52,089	\$44,576	\$30,915	\$62,183
Sarnia (South)	60 Years (3 Life Cycles)	7%	\$57,687	\$44,043	\$51,412	v/s	\$57,687	\$44,043	\$61,604	\$51,891	\$38,206	\$51,412	\$50,030	\$36,386	\$51,412	\$44,234	\$30,548	\$51,412	\$44,234	\$30,548	\$61,604
Simcoe (South)	60 Years (3 Life Cycles)	7%	\$58,586	\$44,977	\$53,708	v/s	\$58,586	\$44,977	\$64,286	\$52,522	\$38,861	\$53,708	\$50,929	\$37,320	\$53,708	\$44,865	\$31,204	\$53,708	\$44,865	\$31,204	\$64,286
St. Catharines (South)	60 Years (3 Life Cycles)	7%	\$70,674	\$43,608	\$52,280	v/s	\$70,674	\$43,608	\$62,048	\$64,809	\$37,900	\$52,280	\$63,017	\$35,951	\$52,280	\$57,151	\$30,243	\$52,280	\$57,151	\$30,243	\$62,048
Toronto (South)	60 Years (3 Life Cycles)	7%	\$72,662	\$45,664	\$52,406	v/s	\$72,662	\$45,664	\$63,527	\$66,203	\$39,343	\$52,406	\$65,005	\$38,007	\$52,406	\$58,546	\$31,686	\$52,406	\$58,546	\$31,686	\$63,527
Trenton (South)	60 Years (3 Life Cycles)	7%	\$72,872	\$54,652	\$56,607	v/s	\$72,872	\$54,652	\$67,800	\$66,350	\$48,084	\$56,607	\$65,214	\$46,995	\$56,607	\$58,693	\$40,426	\$56,607	\$58,693	\$40,426	\$67,800
Warton (South)	60 Years (3 Life Cycles)	7%	\$73,681	\$55,456	\$55,043	v/s	\$73,681	\$55,456	\$66,916	\$66,918	\$48,648	\$55,043	\$66,024	\$47,799	\$55,043	\$59,261	\$40,991	\$55,043	\$59,261	\$40,991	\$66,916
Windsor (South)	60 Years (3 Life Cycles)	7%	\$57,927	\$44,321	\$51,004	v/s	\$57,927	\$44,321	\$61,007	\$52,060	\$38,400	\$51,004	\$50,270	\$36,663	\$51,004	\$44,402	\$30,743	\$51,004	\$44,402	\$30,743	\$61,007
Barrie (Distinct)	60 Years (3 Life Cycles)	7%	\$73,340	\$55,108	\$49,495	v/s	\$73,340	\$55,108	\$60,739	\$66,679	\$48,404	\$49,495	\$65,682	\$47,451	\$49,495	\$59,022	\$40,747	\$49,495	\$59,022	\$40,747	\$60,739
Muskoka (Distinct)	60 Years (3 Life Cycles)	7%	\$74,095	\$55,863	\$51,258	v/s	\$74,095	\$55,863	\$63,286	\$67,209	\$48,934	\$51,258	\$66,438	\$48,206	\$51,258	\$59,551	\$41,276	\$51,258	\$59,551	\$41,276	\$63,286
Ottawa (Distinct)	60 Years (3 Life Cycles)	7%	\$73,403	\$55,202	\$52,872	v/s	\$73,403	\$55,202	\$64,372	\$66,723	\$48,470	\$52,872	\$65,746	\$47,545	\$52,872	\$59,066	\$40,813	\$52,872	\$59,066	\$40,813	\$64,372
Peterborough (Distinct)	60 Years (3 Life Cycles)	7%	\$73,963	\$55,762	\$53,687	v/s	\$73,963	\$55,762	\$65,676	\$67,116	\$48,863	\$53,687	\$66,306	\$48,105	\$53,687	\$59,459	\$41,205	\$53,687	\$59,459	\$41,205	\$65,676
Kapuskasing (North)	60 Years (3 Life Cycles)	7%	\$77,800	\$59,590	\$63,014	v/s	\$77,800	\$59,590	\$77,813	\$69,808	\$51,548	\$63,014	\$70,143	\$51,933	\$63,014	\$62,151	\$43,891	\$63,014	\$62,151	\$43,891	\$77,813
Kenora (North)	60 Years (3 Life Cycles)	7%	\$76,956	\$58,738	\$57,016	v/s	\$76,956	\$58,738	\$70,903	\$69,216	\$50,951	\$57,016	\$69,298	\$51,081	\$57,016	\$61,559	\$43,293	\$57,016	\$61,559	\$43,293	\$70,903
North Bay (North)	60 Years (3 Life Cycles)	7%	\$74,088	\$55,917	\$52,901	v/s	\$74,088	\$55,917	\$65,005	\$67,204	\$48,972	\$52,901	\$66,431	\$48,260	\$52,901	\$59,546	\$41,314	\$52,901	\$59,546	\$41,314	\$65,005
Sault Ste. Marie (North)	60 Years (3 Life Cycles)	7%	\$60,908	\$47,332	\$51,406	v/s	\$60,908	\$47,332	\$63,781	\$54,151	\$40,513	\$51,406	\$53,251	\$39,675	\$51,406	\$46,494	\$32,856	\$51,406	\$46,494	\$32,856	\$63,781
Sudbury (North)	60 Years (3 Life Cycles)	7%	\$74,831	\$56,668	\$57,070	v/s	\$74,831	\$56,668	\$70,043	\$67,725	\$49,498	\$57,070	\$67,174	\$49,011	\$57,070	\$60,068	\$41,841	\$57,070	\$60,068	\$41,841	\$70,043
Timmins (North)	60 Years (3 Life Cycles)	7%	\$76,071	\$57,910	\$57,554	v/s	\$76,071	\$57,910	\$71,829	\$68,595	\$50,370	\$57,554	\$68,414	\$50,253	\$57,554	\$60,938	\$42,712	\$57,554	\$60,938	\$42,712	\$71,829
Thunder Bay (North)	60 Years (3 Life Cycles)	7%	\$76,570	\$58,383	\$55,958	v/s	\$76,570	\$58,383	\$69,664	\$68,945	\$50,701	\$55,958	\$68,913	\$50,726	\$55,958	\$61,288	\$43,044	\$55,958	\$61,288	\$43,044	\$69,664

Table 12c: Rankings of the Cities Based on present values for V.GSHP, H.GSHP (three life cycles) and Traditional HVAC Applications (five life cycles) at a discount rate of 7% for improved construction scenario

		Total Present Value																				
		Main Scenario					v/s	Comparative Scenarios														
		Base Case Scenario			v/s	Carbon Taxes - (#1)			FIT - (#2)			Rebates - (#3)			(FIT+Rebates) - (#4)			(FIT+Rebates) + Carbon Taxes - (#5)				
City	Project Life Span	Discount Rate	V.GSHP	H.GSHP	Traditional	v/s	V.GSHP	H.GSHP	Traditional	V.GSHP	H.GSHP	Traditional	V.GSHP	H.GSHP	Traditional	V.GSHP	H.GSHP	Traditional	V.GSHP	H.GSHP	Traditional	
Cambridge (South)	60 Years (3 Life Cycles)	7%	\$59,247	\$45,638	\$47,171	v/s	0%	0%	24%	-11%	-14%	0%	-13%	-17%	0%	-23%	-31%	0%	-23%	-31%	24%	
Chatham (South)	60 Years (3 Life Cycles)	7%	\$57,911	\$44,295	\$50,963	v/s	0%	0%	20%	-10%	-13%	0%	-13%	-17%	0%	-23%	-31%	0%	-23%	-31%	20%	
Guelph (South)	60 Years (3 Life Cycles)	7%	\$59,511	\$45,902	\$47,796	v/s	0%	0%	24%	-11%	-14%	0%	-13%	-17%	0%	-24%	-31%	0%	-24%	-31%	24%	
Hamilton (South)	60 Years (3 Life Cycles)	7%	\$58,899	\$45,290	\$53,050	v/s	0%	0%	20%	-10%	-14%	0%	-13%	-17%	0%	-23%	-31%	0%	-23%	-31%	20%	
Kingston (South)	60 Years (3 Life Cycles)	7%	\$73,502	\$55,303	\$57,068	v/s	0%	0%	20%	-9%	-12%	0%	-10%	-14%	0%	-20%	-26%	0%	-20%	-26%	20%	
Kitchener-Waterloo (South)	60 Years (3 Life Cycles)	7%	\$73,102	\$54,904	\$53,924	v/s	0%	0%	21%	-9%	-12%	0%	-10%	-14%	0%	-19%	-26%	0%	-19%	-26%	21%	
London (South)	60 Years (3 Life Cycles)	7%	\$59,252	\$45,624	\$50,222	v/s	0%	0%	22%	-11%	-14%	0%	-13%	-17%	0%	-23%	-31%	0%	-23%	-31%	22%	
Mt. Forest (South)	60 Years (3 Life Cycles)	7%	\$73,262	\$46,368	\$53,692	v/s	0%	0%	23%	-9%	-14%	0%	-10%	-17%	0%	-20%	-31%	0%	-20%	-31%	23%	
Niagara Falls (South)	60 Years (3 Life Cycles)	7%	\$58,174	\$44,565	\$52,089	v/s	0%	0%	19%	-10%	-13%	0%	-13%	-17%	0%	-23%	-31%	0%	-23%	-31%	19%	
Sarnia (South)	60 Years (3 Life Cycles)	7%	\$57,687	\$44,043	\$51,412	v/s	0%	0%	20%	-10%	-13%	0%	-13%	-17%	0%	-23%	-31%	0%	-23%	-31%	20%	
Simcoe (South)	60 Years (3 Life Cycles)	7%	\$58,586	\$44,977	\$53,708	v/s	0%	0%	20%	-10%	-14%	0%	-13%	-17%	0%	-23%	-31%	0%	-23%	-31%	20%	
St. Catharines (South)	60 Years (3 Life Cycles)	7%	\$70,674	\$43,608	\$52,280	v/s	0%	0%	19%	-8%	-13%	0%	-11%	-18%	0%	-19%	-31%	0%	-19%	-31%	19%	
Toronto (South)	60 Years (3 Life Cycles)	7%	\$72,662	\$45,664	\$52,406	v/s	0%	0%	21%	-9%	-14%	0%	-11%	-17%	0%	-19%	-31%	0%	-19%	-31%	21%	
Trenton (South)	60 Years (3 Life Cycles)	7%	\$72,872	\$54,652	\$56,607	v/s	0%	0%	20%	-9%	-12%	0%	-11%	-14%	0%	-19%	-26%	0%	-19%	-26%	20%	
Warton (South)	60 Years (3 Life Cycles)	7%	\$73,681	\$55,456	\$55,043	v/s	0%	0%	22%	-9%	-12%	0%	-10%	-14%	0%	-20%	-26%	0%	-20%	-26%	22%	
Windsor (South)	60 Years (3 Life Cycles)	7%	\$57,927	\$44,321	\$51,004	v/s	0%	0%	20%	-10%	-13%	0%	-13%	-17%	0%	-23%	-31%	0%	-23%	-31%	20%	
Barrie (Distinct)	60 Years (3 Life Cycles)	7%	\$73,340	\$55,108	\$49,495	v/s	0%	0%	23%	-9%	-12%	0%	-10%	-14%	0%	-20%	-26%	0%	-20%	-26%	23%	
Muskoka (Distinct)	60 Years (3 Life Cycles)	7%	\$74,095	\$55,863	\$51,258	v/s	0%	0%	23%	-9%	-12%	0%	-10%	-14%	0%	-20%	-26%	0%	-20%	-26%	23%	
Ottawa (Distinct)	60 Years (3 Life Cycles)	7%	\$73,403	\$55,202	\$52,872	v/s	0%	0%	22%	-9%	-12%	0%	-10%	-14%	0%	-20%	-26%	0%	-20%	-26%	22%	
Peterborough (Distinct)	60 Years (3 Life Cycles)	7%	\$73,963	\$55,762	\$53,687	v/s	0%	0%	22%	-9%	-12%	0%	-10%	-14%	0%	-20%	-26%	0%	-20%	-26%	22%	
Kapuskasing (North)	60 Years (3 Life Cycles)	7%	\$77,800	\$59,590	\$63,014	v/s	0%	0%	23%	-10%	-13%	0%	-10%	-13%	0%	-20%	-26%	0%	-20%	-26%	23%	
Kenora (North)	60 Years (3 Life Cycles)	7%	\$76,956	\$58,738	\$57,016	v/s	0%	0%	24%	-10%	-13%	0%	-10%	-13%	0%	-20%	-26%	0%	-20%	-26%	24%	
North Bay (North)	60 Years (3 Life Cycles)	7%	\$74,088	\$55,917	\$52,901	v/s	0%	0%	23%	-9%	-12%	0%	-10%	-14%	0%	-20%	-26%	0%	-20%	-26%	23%	
Sault Ste. Marie (North)	60 Years (3 Life Cycles)	7%	\$60,908	\$47,332	\$51,406	v/s	0%	0%	24%	-11%	-14%	0%	-13%	-16%	0%	-24%	-31%	0%	-24%	-31%	24%	
Sudbury (North)	60 Years (3 Life Cycles)	7%	\$74,831	\$56,668	\$57,070	v/s	0%	0%	23%	-9%	-13%	0%	-10%	-14%	0%	-20%	-26%	0%	-20%	-26%	23%	
Timmins (North)	60 Years (3 Life Cycles)	7%	\$76,071	\$57,910	\$57,554	v/s	0%	0%	25%	-10%	-13%	0%	-10%	-13%	0%	-20%	-26%	0%	-20%	-26%	25%	
Thunder Bay (North)	60 Years (3 Life Cycles)	7%	\$76,570	\$58,383	\$55,958	v/s	0%	0%	24%	-10%	-13%	0%	-10%	-13%	0%	-20%	-26%	0%	-20%	-26%	24%	

Table 12d: % change in present values for comparative scenarios in regards to the main scenario for V.GSHP, H.GSHP (three life cycles) and Traditional HVAC Applications (five life cycles) at a discount rate of 7% for improved construction scenario

			Total Present Value																		
			Main Scenario				v/s	Comparative Scenarios													
			Base Case Scenario			v/s	Carbon Taxes - (#1)			FIT - (#2)			Rebates - (#3)			(FIT+Rebates) - (#4)			(FIT+Rebates) + Carbon Taxes - (#5)		
City	Project Life Span	Discount Rate	V.GSHP	H.GSHP	Traditional	v/s	V.GSHP	H.GSHP	Traditional	V.GSHP	H.GSHP	Traditional	V.GSHP	H.GSHP	Traditional	V.GSHP	H.GSHP	Traditional	V.GSHP	H.GSHP	Traditional
Cambridge (South)	60 Years (3 Life Cycles)	7.5%	\$56,331	\$43,244	\$44,213	v/s	\$56,331	\$43,244	\$54,110	\$50,462	\$37,326	\$44,213	\$48,970	\$35,883	\$44,213	\$43,101	\$29,965	\$44,213	\$43,101	\$29,965	\$54,110
Chatham (South)	60 Years (3 Life Cycles)	7.5%	\$55,082	\$41,989	\$47,791	v/s	\$55,082	\$41,989	\$56,689	\$49,587	\$36,447	\$47,791	\$47,722	\$34,628	\$47,791	\$42,226	\$29,086	\$47,791	\$42,226	\$29,086	\$56,689
Guelph (South)	60 Years (3 Life Cycles)	7.5%	\$56,577	\$43,490	\$44,795	v/s	\$56,577	\$43,490	\$54,986	\$50,634	\$37,499	\$44,795	\$49,216	\$36,129	\$44,795	\$43,273	\$30,138	\$44,795	\$43,273	\$30,138	\$54,986
Hamilton (South)	60 Years (3 Life Cycles)	7.5%	\$56,006	\$42,919	\$49,737	v/s	\$56,006	\$42,919	\$59,383	\$50,234	\$37,098	\$49,737	\$48,645	\$35,558	\$49,737	\$42,873	\$29,737	\$49,737	\$42,873	\$29,737	\$59,383
Kingston (South)	60 Years (3 Life Cycles)	7.5%	\$69,975	\$52,476	\$53,519	v/s	\$69,975	\$52,476	\$63,791	\$63,686	\$46,137	\$53,519	\$62,614	\$45,115	\$53,519	\$56,325	\$38,776	\$53,519	\$56,325	\$38,776	\$63,791
Kitchener-Waterloo (South)	60 Years (3 Life Cycles)	7.5%	\$69,601	\$52,102	\$50,550	v/s	\$69,601	\$52,102	\$60,764	\$63,424	\$45,875	\$50,550	\$62,241	\$44,741	\$50,550	\$56,063	\$38,514	\$50,550	\$56,063	\$38,514	\$60,764
London (South)	60 Years (3 Life Cycles)	7.5%	\$56,335	\$43,231	\$47,078	v/s	\$56,335	\$43,231	\$56,976	\$50,465	\$37,317	\$47,078	\$48,974	\$35,870	\$47,078	\$43,104	\$29,956	\$47,078	\$43,104	\$29,956	\$56,976
Mt. Forest (South)	60 Years (3 Life Cycles)	7.5%	\$69,751	\$43,925	\$50,331	v/s	\$69,751	\$43,925	\$61,183	\$63,529	\$37,803	\$50,331	\$62,390	\$36,564	\$50,331	\$56,168	\$30,443	\$50,331	\$56,168	\$30,443	\$61,183
Niagara Falls (South)	60 Years (3 Life Cycles)	7.5%	\$55,329	\$42,242	\$48,843	v/s	\$55,329	\$42,242	\$57,844	\$49,760	\$36,624	\$48,843	\$47,968	\$34,881	\$48,843	\$42,399	\$29,263	\$48,843	\$42,399	\$29,263	\$57,844
Sarnia (South)	60 Years (3 Life Cycles)	7.5%	\$54,874	\$41,754	\$48,210	v/s	\$54,874	\$41,754	\$57,298	\$49,441	\$36,282	\$48,210	\$47,513	\$34,393	\$48,210	\$42,080	\$28,921	\$48,210	\$42,080	\$28,921	\$57,298
Simcoe (South)	60 Years (3 Life Cycles)	7.5%	\$55,713	\$42,626	\$50,368	v/s	\$55,713	\$42,626	\$59,801	\$50,029	\$36,893	\$50,368	\$48,352	\$35,265	\$50,368	\$42,668	\$29,532	\$50,368	\$42,668	\$29,532	\$59,801
St. Catharines (South)	60 Years (3 Life Cycles)	7.5%	\$67,333	\$41,347	\$49,022	v/s	\$67,333	\$41,347	\$57,733	\$61,835	\$35,997	\$49,022	\$59,972	\$33,986	\$49,022	\$54,474	\$28,636	\$49,022	\$54,474	\$28,636	\$57,733
Toronto (South)	60 Years (3 Life Cycles)	7.5%	\$69,190	\$43,268	\$49,134	v/s	\$69,190	\$43,268	\$59,051	\$63,136	\$37,343	\$49,134	\$61,830	\$35,907	\$49,134	\$55,776	\$29,982	\$49,134	\$55,776	\$29,982	\$59,051
Trenton (South)	60 Years (3 Life Cycles)	7.5%	\$69,386	\$51,867	\$53,089	v/s	\$69,386	\$51,867	\$63,071	\$63,273	\$45,710	\$53,089	\$62,025	\$44,506	\$53,089	\$55,913	\$38,350	\$53,089	\$55,913	\$38,350	\$63,071
Warton (South)	60 Years (3 Life Cycles)	7.5%	\$70,142	\$52,619	\$51,609	v/s	\$70,142	\$52,619	\$62,197	\$63,803	\$46,237	\$51,609	\$62,781	\$45,258	\$51,609	\$56,442	\$38,876	\$51,609	\$56,442	\$38,876	\$62,197
Windsor (South)	60 Years (3 Life Cycles)	7.5%	\$55,098	\$42,013	\$47,829	v/s	\$55,098	\$42,013	\$56,749	\$49,598	\$36,464	\$47,829	\$47,737	\$34,652	\$47,829	\$42,237	\$29,103	\$47,829	\$42,237	\$29,103	\$56,749
Barrie (Distinct)	60 Years (3 Life Cycles)	7.5%	\$69,823	\$52,293	\$46,399	v/s	\$69,823	\$52,293	\$56,426	\$63,580	\$46,009	\$46,399	\$62,462	\$44,933	\$46,399	\$56,219	\$38,648	\$46,399	\$56,219	\$38,648	\$56,426
Muskoka (Distinct)	60 Years (3 Life Cycles)	7.5%	\$70,529	\$52,999	\$48,042	v/s	\$70,529	\$52,999	\$58,769	\$64,074	\$46,504	\$48,042	\$63,168	\$45,638	\$48,042	\$56,713	\$39,143	\$48,042	\$56,713	\$39,143	\$58,769
Ottawa (Distinct)	60 Years (3 Life Cycles)	7.5%	\$69,883	\$52,381	\$49,568	v/s	\$69,883	\$52,381	\$59,823	\$63,621	\$46,071	\$49,568	\$62,522	\$45,021	\$49,568	\$56,261	\$38,710	\$49,568	\$56,261	\$38,710	\$59,823
Peterborough (Distinct)	60 Years (3 Life Cycles)	7.5%	\$70,406	\$52,904	\$50,327	v/s	\$70,406	\$52,904	\$61,018	\$63,988	\$46,437	\$50,327	\$63,045	\$45,544	\$50,327	\$56,627	\$39,076	\$50,327	\$56,627	\$39,076	\$61,018
Kapuskasing (North)	60 Years (3 Life Cycles)	7.5%	\$73,991	\$56,480	\$59,059	v/s	\$73,991	\$56,480	\$72,256	\$66,500	\$48,943	\$59,059	\$66,630	\$49,120	\$59,059	\$59,139	\$41,582	\$59,059	\$59,139	\$41,582	\$72,256
Kenora (North)	60 Years (3 Life Cycles)	7.5%	\$73,201	\$55,685	\$53,428	v/s	\$73,201	\$55,685	\$65,813	\$65,947	\$48,385	\$53,428	\$65,841	\$48,324	\$53,428	\$58,586	\$41,024	\$53,428	\$58,586	\$41,024	\$65,813
North Bay (North)	60 Years (3 Life Cycles)	7.5%	\$70,522	\$53,050	\$49,592	v/s	\$70,522	\$53,050	\$60,386	\$64,070	\$46,539	\$49,592	\$63,161	\$45,689	\$49,592	\$56,709	\$39,178	\$49,592	\$56,709	\$39,178	\$60,386
Sault Ste. Marie (North)	60 Years (3 Life Cycles)	7.5%	\$57,883	\$44,826	\$48,179	v/s	\$57,883	\$44,826	\$59,215	\$51,549	\$38,435	\$48,179	\$50,522	\$37,465	\$48,179	\$44,188	\$31,074	\$48,179	\$44,188	\$31,074	\$59,215
Sudbury (North)	60 Years (3 Life Cycles)	7.5%	\$71,217	\$53,751	\$53,499	v/s	\$71,217	\$53,751	\$65,067	\$64,556	\$47,030	\$53,499	\$63,856	\$46,390	\$53,499	\$57,195	\$39,669	\$53,499	\$57,195	\$39,669	\$65,067
Timmins (North)	60 Years (3 Life Cycles)	7.5%	\$72,375	\$54,911	\$53,930	v/s	\$72,375	\$54,911	\$66,659	\$65,368	\$47,843	\$53,930	\$65,014	\$47,550	\$53,930	\$58,007	\$40,482	\$53,930	\$58,007	\$40,482	\$66,659
Thunder Bay (North)	60 Years (3 Life Cycles)	7.5%	\$72,841	\$55,353	\$52,441	v/s	\$72,841	\$55,353	\$64,664	\$65,694	\$48,153	\$52,441	\$65,480	\$47,992	\$52,441	\$58,333	\$40,792	\$52,441	\$58,333	\$40,792	\$64,664

Table 12e: Rankings of the Cities Based on present values for V.GSHP, H.GSHP (three life cycles) and Traditional HVAC Applications (five life cycles) at a discount rate of 7.5% for improved construction scenario

		Total Present Value																				
		Main Scenario					v/s	Comparative Scenarios														
		Base Case Scenario			v/s	Carbon Taxes - (€1)			FIT - (€2)			Rebates - (€3)			(FIT+Rebates) - (€4)			(FIT+Rebates) + Carbon Taxes - (€5)				
City	Project Life Span	Discount Rate	V.GSHP	H.GSHP	Traditional	v/s	V.GSHP	H.GSHP	Traditional	V.GSHP	H.GSHP	Traditional	V.GSHP	H.GSHP	Traditional	V.GSHP	H.GSHP	Traditional	V.GSHP	H.GSHP	Traditional	
Cambridge (South)	60 Years (3 Life Cycles)	7.5%	\$56,331	\$43,244	\$44,213	v/s	0%	0%	22%	-10%	-14%	0%	-13%	-17%	0%	-23%	-31%	0%	-23%	-31%	22%	
Chatham (South)	60 Years (3 Life Cycles)	7.5%	\$55,082	\$41,989	\$47,791	v/s	0%	0%	19%	-10%	-13%	0%	-13%	-18%	0%	-23%	-31%	0%	-23%	-31%	19%	
Guelph (South)	60 Years (3 Life Cycles)	7.5%	\$56,577	\$43,490	\$44,795	v/s	0%	0%	23%	-11%	-14%	0%	-13%	-17%	0%	-24%	-31%	0%	-24%	-31%	23%	
Hamilton (South)	60 Years (3 Life Cycles)	7.5%	\$56,006	\$42,919	\$49,737	v/s	0%	0%	19%	-10%	-14%	0%	-13%	-17%	0%	-23%	-31%	0%	-23%	-31%	19%	
Kingston (South)	60 Years (3 Life Cycles)	7.5%	\$69,975	\$52,476	\$53,519	v/s	0%	0%	19%	-9%	-12%	0%	-11%	-14%	0%	-20%	-26%	0%	-20%	-26%	19%	
Kitchener-Waterloo (South)	60 Years (3 Life Cycles)	7.5%	\$69,601	\$52,102	\$50,550	v/s	0%	0%	20%	-9%	-12%	0%	-11%	-14%	0%	-19%	-26%	0%	-19%	-26%	20%	
London (South)	60 Years (3 Life Cycles)	7.5%	\$56,335	\$43,231	\$47,078	v/s	0%	0%	21%	-10%	-14%	0%	-13%	-17%	0%	-23%	-31%	0%	-23%	-31%	21%	
Mt. Forest (South)	60 Years (3 Life Cycles)	7.5%	\$69,751	\$43,925	\$50,331	v/s	0%	0%	22%	-9%	-14%	0%	-11%	-17%	0%	-19%	-31%	0%	-19%	-31%	22%	
Niagara Falls (South)	60 Years (3 Life Cycles)	7.5%	\$55,329	\$42,242	\$48,843	v/s	0%	0%	18%	-10%	-13%	0%	-13%	-17%	0%	-23%	-31%	0%	-23%	-31%	18%	
Sarnia (South)	60 Years (3 Life Cycles)	7.5%	\$54,874	\$41,754	\$48,210	v/s	0%	0%	19%	-10%	-13%	0%	-13%	-18%	0%	-23%	-31%	0%	-23%	-31%	19%	
Simcoe (South)	60 Years (3 Life Cycles)	7.5%	\$55,713	\$42,626	\$50,368	v/s	0%	0%	19%	-10%	-13%	0%	-13%	-17%	0%	-23%	-31%	0%	-23%	-31%	19%	
St. Catharines (South)	60 Years (3 Life Cycles)	7.5%	\$67,333	\$41,347	\$49,022	v/s	0%	0%	18%	-8%	-13%	0%	-11%	-18%	0%	-19%	-31%	0%	-19%	-31%	18%	
Toronto (South)	60 Years (3 Life Cycles)	7.5%	\$69,190	\$43,268	\$49,134	v/s	0%	0%	20%	-9%	-14%	0%	-11%	-17%	0%	-19%	-31%	0%	-19%	-31%	20%	
Trenton (South)	60 Years (3 Life Cycles)	7.5%	\$69,386	\$51,867	\$53,089	v/s	0%	0%	19%	-9%	-12%	0%	-11%	-14%	0%	-19%	-26%	0%	-19%	-26%	19%	
Warton (South)	60 Years (3 Life Cycles)	7.5%	\$70,142	\$52,619	\$51,609	v/s	0%	0%	21%	-9%	-12%	0%	-10%	-14%	0%	-20%	-26%	0%	-20%	-26%	21%	
Windsor (South)	60 Years (3 Life Cycles)	7.5%	\$55,098	\$42,013	\$47,829	v/s	0%	0%	19%	-10%	-13%	0%	-13%	-18%	0%	-23%	-31%	0%	-23%	-31%	19%	
Barrie (Distinct)	60 Years (3 Life Cycles)	7.5%	\$69,823	\$52,293	\$46,399	v/s	0%	0%	22%	-9%	-12%	0%	-11%	-14%	0%	-19%	-26%	0%	-19%	-26%	22%	
Muskoka (Distinct)	60 Years (3 Life Cycles)	7.5%	\$70,529	\$52,999	\$48,042	v/s	0%	0%	22%	-9%	-12%	0%	-10%	-14%	0%	-20%	-26%	0%	-20%	-26%	22%	
Ottawa (Distinct)	60 Years (3 Life Cycles)	7.5%	\$69,883	\$52,381	\$49,568	v/s	0%	0%	21%	-9%	-12%	0%	-11%	-14%	0%	-19%	-26%	0%	-19%	-26%	21%	
Peterborough (Distinct)	60 Years (3 Life Cycles)	7.5%	\$70,406	\$52,904	\$50,327	v/s	0%	0%	21%	-9%	-12%	0%	-10%	-14%	0%	-20%	-26%	0%	-20%	-26%	21%	
Kapuskasing (North)	60 Years (3 Life Cycles)	7.5%	\$73,991	\$56,480	\$59,059	v/s	0%	0%	22%	-10%	-13%	0%	-10%	-13%	0%	-20%	-26%	0%	-20%	-26%	22%	
Kenora (North)	60 Years (3 Life Cycles)	7.5%	\$73,201	\$55,685	\$53,428	v/s	0%	0%	23%	-10%	-13%	0%	-10%	-13%	0%	-20%	-26%	0%	-20%	-26%	23%	
North Bay (North)	60 Years (3 Life Cycles)	7.5%	\$70,522	\$53,050	\$49,592	v/s	0%	0%	22%	-9%	-12%	0%	-10%	-14%	0%	-20%	-26%	0%	-20%	-26%	22%	
Sault Ste. Marie (North)	60 Years (3 Life Cycles)	7.5%	\$57,883	\$44,826	\$48,179	v/s	0%	0%	23%	-11%	-14%	0%	-13%	-16%	0%	-24%	-31%	0%	-24%	-31%	23%	
Sudbury (North)	60 Years (3 Life Cycles)	7.5%	\$71,217	\$53,751	\$53,499	v/s	0%	0%	22%	-9%	-13%	0%	-10%	-14%	0%	-20%	-26%	0%	-20%	-26%	22%	
Timmins (North)	60 Years (3 Life Cycles)	7.5%	\$72,375	\$54,911	\$53,930	v/s	0%	0%	24%	-10%	-13%	0%	-10%	-13%	0%	-20%	-26%	0%	-20%	-26%	24%	
Thunder Bay (North)	60 Years (3 Life Cycles)	7.5%	\$72,841	\$55,353	\$52,441	v/s	0%	0%	23%	-10%	-13%	0%	-10%	-13%	0%	-20%	-26%	0%	-20%	-26%	23%	

Table 12f: % change in present values for comparative scenarios in regards to the main scenario for V.GSHP, H.GSHP (three life cycles) and Traditional HVAC Applications (five life cycles) at a discount rate of 7.5% for improved construction scenario

		Total Present Value																			
		Main Scenario					v/s	Comparative Scenarios													
		Base Case Scenario			v/s	Carbon Taxes - (€1)			FIT - (€2)			Rebates - (€3)			(FIT+Rebates) - (€4)			(FIT+Rebates) + Carbon Taxes - (€5)			
City	Project Life Span	Discount Rate	V.GSHP	H.GSHP	Traditional	v/s	V.GSHP	H.GSHP	Traditional	V.GSHP	H.GSHP	Traditional	V.GSHP	H.GSHP	Traditional	V.GSHP	H.GSHP	Traditional	V.GSHP	H.GSHP	Traditional
Cambridge (South)	60 Years (3 Life Cycles)	8.5%	\$51,505	\$39,272	\$39,315	v/s	\$51,505	\$39,272	\$47,301	\$46,297	\$34,021	\$39,315	\$44,629	\$32,396	\$39,315	\$39,421	\$27,145	\$39,315	\$39,421	\$27,145	\$47,301
Chatham (South)	60 Years (3 Life Cycles)	8.5%	\$50,404	\$38,165	\$42,540	v/s	\$50,404	\$38,165	\$49,720	\$45,528	\$33,247	\$42,540	\$43,528	\$31,289	\$42,540	\$38,652	\$26,371	\$42,540	\$38,652	\$26,371	\$49,720
Guelph (South)	60 Years (3 Life Cycles)	8.5%	\$51,722	\$39,489	\$39,826	v/s	\$51,722	\$39,489	\$48,049	\$46,449	\$34,173	\$39,826	\$44,846	\$32,613	\$39,826	\$39,573	\$27,297	\$39,826	\$39,573	\$27,297	\$48,049
Hamilton (South)	60 Years (3 Life Cycles)	8.5%	\$51,218	\$38,985	\$44,251	v/s	\$51,218	\$38,985	\$52,034	\$46,097	\$33,820	\$44,251	\$44,342	\$32,109	\$44,251	\$39,221	\$26,945	\$44,251	\$39,221	\$26,945	\$52,034
Kingston (South)	60 Years (3 Life Cycles)	8.5%	\$64,146	\$47,791	\$47,643	v/s	\$64,146	\$47,791	\$55,931	\$58,566	\$42,167	\$47,643	\$57,270	\$40,915	\$47,643	\$51,690	\$35,291	\$47,643	\$51,690	\$35,291	\$55,931
Kitchener-Waterloo (South)	60 Years (3 Life Cycles)	8.5%	\$63,816	\$47,462	\$44,964	v/s	\$63,816	\$47,462	\$53,205	\$58,335	\$41,936	\$44,964	\$56,940	\$40,586	\$44,964	\$51,459	\$35,060	\$44,964	\$51,459	\$35,060	\$53,205
London (South)	60 Years (3 Life Cycles)	8.5%	\$51,509	\$39,260	\$41,873	v/s	\$51,509	\$39,260	\$49,859	\$46,300	\$34,013	\$41,873	\$44,633	\$32,384	\$41,873	\$39,424	\$27,137	\$41,873	\$39,424	\$27,137	\$49,859
Mt. Forest (South)	60 Years (3 Life Cycles)	8.5%	\$63,948	\$39,873	\$44,765	v/s	\$63,948	\$39,873	\$53,521	\$58,427	\$34,441	\$44,765	\$57,072	\$32,997	\$44,765	\$51,552	\$27,565	\$44,765	\$51,552	\$27,565	\$53,521
Niagara Falls (South)	60 Years (3 Life Cycles)	8.5%	\$50,621	\$38,388	\$43,467	v/s	\$50,621	\$38,388	\$50,730	\$45,679	\$33,403	\$43,467	\$43,745	\$31,512	\$43,467	\$38,804	\$26,527	\$43,467	\$38,804	\$26,527	\$50,730
Sarnia (South)	60 Years (3 Life Cycles)	8.5%	\$50,220	\$37,958	\$42,908	v/s	\$50,220	\$37,958	\$50,241	\$45,399	\$33,102	\$42,908	\$43,344	\$31,082	\$42,908	\$38,523	\$26,227	\$42,908	\$38,523	\$26,227	\$50,241
Simcoe (South)	60 Years (3 Life Cycles)	8.5%	\$50,960	\$38,727	\$44,840	v/s	\$50,960	\$38,727	\$52,451	\$45,916	\$33,640	\$44,840	\$44,084	\$31,851	\$44,840	\$39,041	\$26,764	\$44,840	\$39,041	\$26,764	\$52,451
St. Catharines (South)	60 Years (3 Life Cycles)	8.5%	\$61,816	\$37,599	\$43,627	v/s	\$61,816	\$37,599	\$50,656	\$56,937	\$32,852	\$43,627	\$54,940	\$30,723	\$43,627	\$50,061	\$25,976	\$43,627	\$50,061	\$25,976	\$50,656
Toronto (South)	60 Years (3 Life Cycles)	8.5%	\$63,454	\$39,293	\$43,717	v/s	\$63,454	\$39,293	\$51,719	\$58,082	\$34,036	\$43,717	\$56,578	\$32,417	\$43,717	\$51,206	\$27,160	\$43,717	\$51,206	\$27,160	\$51,719
Trenton (South)	60 Years (3 Life Cycles)	8.5%	\$63,626	\$47,254	\$47,266	v/s	\$63,626	\$47,254	\$55,320	\$58,203	\$41,791	\$47,266	\$56,750	\$40,378	\$47,266	\$51,327	\$34,915	\$47,266	\$51,327	\$34,915	\$55,320
Warton (South)	60 Years (3 Life Cycles)	8.5%	\$64,293	\$47,917	\$45,926	v/s	\$64,293	\$47,917	\$54,469	\$58,669	\$42,255	\$45,926	\$57,417	\$41,041	\$45,926	\$51,793	\$35,379	\$45,926	\$51,793	\$35,379	\$54,469
Windsor (South)	60 Years (3 Life Cycles)	8.5%	\$50,417	\$38,186	\$42,573	v/s	\$50,417	\$38,186	\$49,771	\$45,537	\$33,262	\$42,573	\$43,542	\$31,310	\$42,573	\$38,661	\$26,386	\$42,573	\$38,661	\$26,386	\$49,771
Barrie (Distinct)	60 Years (3 Life Cycles)	8.5%	\$64,012	\$47,630	\$41,273	v/s	\$64,012	\$47,630	\$49,363	\$58,472	\$42,054	\$41,273	\$57,136	\$40,754	\$41,273	\$51,596	\$35,178	\$41,273	\$51,596	\$35,178	\$49,363
Muskoka (Distinct)	60 Years (3 Life Cycles)	8.5%	\$64,634	\$48,253	\$42,717	v/s	\$64,634	\$48,253	\$51,372	\$58,907	\$42,489	\$42,717	\$57,759	\$41,377	\$42,717	\$52,031	\$35,613	\$42,717	\$52,031	\$35,613	\$51,372
Ottawa (Distinct)	60 Years (3 Life Cycles)	8.5%	\$64,064	\$47,708	\$44,097	v/s	\$64,064	\$47,708	\$52,372	\$58,509	\$42,108	\$44,097	\$57,189	\$40,832	\$44,097	\$51,633	\$35,232	\$44,097	\$51,633	\$35,232	\$52,372
Peterborough (Distinct)	60 Years (3 Life Cycles)	8.5%	\$64,526	\$48,169	\$44,764	v/s	\$64,526	\$48,169	\$53,390	\$58,831	\$42,431	\$44,764	\$57,650	\$41,293	\$44,764	\$51,955	\$35,555	\$44,764	\$51,955	\$35,555	\$53,390
Kapuskasing (North)	60 Years (3 Life Cycles)	8.5%	\$67,688	\$51,323	\$52,507	v/s	\$67,688	\$51,323	\$63,155	\$61,041	\$44,635	\$52,507	\$60,812	\$44,448	\$52,507	\$54,165	\$37,759	\$52,507	\$54,165	\$37,759	\$63,155
Kenora (North)	60 Years (3 Life Cycles)	8.5%	\$66,992	\$50,622	\$47,486	v/s	\$66,992	\$50,622	\$57,478	\$60,555	\$44,145	\$47,486	\$60,116	\$43,746	\$47,486	\$53,679	\$37,269	\$47,486	\$53,679	\$37,269	\$57,478
North Bay (North)	60 Years (3 Life Cycles)	8.5%	\$64,629	\$48,297	\$44,114	v/s	\$64,629	\$48,297	\$52,823	\$58,903	\$42,520	\$44,114	\$57,753	\$41,421	\$44,114	\$52,027	\$35,644	\$44,114	\$52,027	\$35,644	\$52,823
Sault Ste. Marie (North)	60 Years (3 Life Cycles)	8.5%	\$52,874	\$40,668	\$42,835	v/s	\$52,874	\$40,668	\$51,739	\$47,254	\$34,996	\$42,835	\$45,998	\$33,792	\$42,835	\$40,378	\$28,121	\$42,835	\$40,378	\$28,121	\$51,739
Sudbury (North)	60 Years (3 Life Cycles)	8.5%	\$65,241	\$48,916	\$47,585	v/s	\$65,241	\$48,916	\$56,919	\$59,331	\$42,952	\$47,585	\$58,365	\$42,040	\$47,585	\$52,455	\$36,077	\$47,585	\$52,455	\$36,077	\$56,919
Timmins (North)	60 Years (3 Life Cycles)	8.5%	\$66,263	\$49,939	\$47,925	v/s	\$66,263	\$49,939	\$58,196	\$60,045	\$43,668	\$47,925	\$59,387	\$43,063	\$47,925	\$53,169	\$36,792	\$47,925	\$53,169	\$36,792	\$58,196
Thunder Bay (North)	60 Years (3 Life Cycles)	8.5%	\$66,674	\$50,329	\$46,616	v/s	\$66,674	\$50,329	\$56,478	\$60,332	\$43,940	\$46,616	\$59,798	\$43,453	\$46,616	\$53,456	\$37,064	\$46,616	\$53,456	\$37,064	\$56,478

Table 12g: Rankings of the Cities Based on present values for V.GSHP, H.GSHP (three life cycles) and Traditional HVAC Applications (five life cycles) at a discount rate of 8.5% for improved construction scenario

Total Present Value																						
		Main Scenario					v/s	Comparative Scenarios														
		Base Case Scenario			v/s	Carbon Taxes - (€1)			FIT - (€2)			Rebates - (€3)			(FIT+Rebates) - (€4)			(FIT+Rebates) + Carbon Taxes - (€5)				
City	Project Life Span	Discount Rate	V.GSHP	H.GSHP	Traditional	v/s	V.GSHP	H.GSHP	Traditional	V.GSHP	H.GSHP	Traditional	V.GSHP	H.GSHP	Traditional	V.GSHP	H.GSHP	Traditional	V.GSHP	H.GSHP	Traditional	
Cambridge (South)	60 Years (3 Life Cycles)	8.5%	\$51,505	\$39,272	\$39,315	v/s	0%	0%	20%	-10%	-13%	0%	-13%	-18%	0%	-23%	-31%	0%	-23%	-31%	20%	
Chatham (South)	60 Years (3 Life Cycles)	8.5%	\$50,404	\$38,165	\$42,540	v/s	0%	0%	17%	-10%	-13%	0%	-14%	-18%	0%	-23%	-31%	0%	-23%	-31%	17%	
Guelph (South)	60 Years (3 Life Cycles)	8.5%	\$51,722	\$39,489	\$39,826	v/s	0%	0%	21%	-10%	-13%	0%	-13%	-17%	0%	-23%	-31%	0%	-23%	-31%	21%	
Hamilton (South)	60 Years (3 Life Cycles)	8.5%	\$51,218	\$38,985	\$44,251	v/s	0%	0%	18%	-10%	-13%	0%	-13%	-18%	0%	-23%	-31%	0%	-23%	-31%	18%	
Kingston (South)	60 Years (3 Life Cycles)	8.5%	\$64,146	\$47,791	\$47,643	v/s	0%	0%	17%	-9%	-12%	0%	-11%	-14%	0%	-19%	-26%	0%	-19%	-26%	17%	
Kitchener-Waterloo (South)	60 Years (3 Life Cycles)	8.5%	\$63,816	\$47,462	\$44,964	v/s	0%	0%	18%	-9%	-12%	0%	-11%	-14%	0%	-19%	-26%	0%	-19%	-26%	18%	
London (South)	60 Years (3 Life Cycles)	8.5%	\$51,509	\$39,260	\$41,873	v/s	0%	0%	19%	-10%	-13%	0%	-13%	-18%	0%	-23%	-31%	0%	-23%	-31%	19%	
Mt. Forest (South)	60 Years (3 Life Cycles)	8.5%	\$63,948	\$39,873	\$44,765	v/s	0%	0%	20%	-9%	-14%	0%	-11%	-17%	0%	-19%	-31%	0%	-19%	-31%	20%	
Niagara Falls (South)	60 Years (3 Life Cycles)	8.5%	\$50,621	\$38,388	\$43,467	v/s	0%	0%	17%	-10%	-13%	0%	-14%	-18%	0%	-23%	-31%	0%	-23%	-31%	17%	
Sarnia (South)	60 Years (3 Life Cycles)	8.5%	\$50,220	\$37,958	\$42,908	v/s	0%	0%	17%	-10%	-13%	0%	-14%	-18%	0%	-23%	-31%	0%	-23%	-31%	17%	
Simcoe (South)	60 Years (3 Life Cycles)	8.5%	\$50,960	\$38,727	\$44,840	v/s	0%	0%	17%	-10%	-13%	0%	-13%	-18%	0%	-23%	-31%	0%	-23%	-31%	17%	
St. Catharines (South)	60 Years (3 Life Cycles)	8.5%	\$61,816	\$37,599	\$43,627	v/s	0%	0%	16%	-8%	-13%	0%	-11%	-18%	0%	-19%	-31%	0%	-19%	-31%	16%	
Toronto (South)	60 Years (3 Life Cycles)	8.5%	\$63,454	\$39,293	\$43,717	v/s	0%	0%	18%	-8%	-13%	0%	-11%	-17%	0%	-19%	-31%	0%	-19%	-31%	18%	
Trenton (South)	60 Years (3 Life Cycles)	8.5%	\$63,626	\$47,254	\$47,266	v/s	0%	0%	17%	-9%	-12%	0%	-11%	-15%	0%	-19%	-26%	0%	-19%	-26%	17%	
Warton (South)	60 Years (3 Life Cycles)	8.5%	\$64,293	\$47,917	\$45,926	v/s	0%	0%	19%	-9%	-12%	0%	-11%	-14%	0%	-19%	-26%	0%	-19%	-26%	19%	
Windsor (South)	60 Years (3 Life Cycles)	8.5%	\$50,417	\$38,186	\$42,573	v/s	0%	0%	17%	-10%	-13%	0%	-14%	-18%	0%	-23%	-31%	0%	-23%	-31%	17%	
Barrie (Distinct)	60 Years (3 Life Cycles)	8.5%	\$64,012	\$47,630	\$41,273	v/s	0%	0%	20%	-9%	-12%	0%	-11%	-14%	0%	-19%	-26%	0%	-19%	-26%	20%	
Muskoka (Distinct)	60 Years (3 Life Cycles)	8.5%	\$64,634	\$48,253	\$42,717	v/s	0%	0%	20%	-9%	-12%	0%	-11%	-14%	0%	-19%	-26%	0%	-19%	-26%	20%	
Ottawa (Distinct)	60 Years (3 Life Cycles)	8.5%	\$64,064	\$47,708	\$44,097	v/s	0%	0%	19%	-9%	-12%	0%	-11%	-14%	0%	-19%	-26%	0%	-19%	-26%	19%	
Peterborough (Distinct)	60 Years (3 Life Cycles)	8.5%	\$64,526	\$48,169	\$44,764	v/s	0%	0%	19%	-9%	-12%	0%	-11%	-14%	0%	-19%	-26%	0%	-19%	-26%	19%	
Kapuskasing (North)	60 Years (3 Life Cycles)	8.5%	\$67,688	\$51,323	\$52,507	v/s	0%	0%	20%	-10%	-13%	0%	-10%	-13%	0%	-20%	-26%	0%	-20%	-26%	20%	
Kenora (North)	60 Years (3 Life Cycles)	8.5%	\$66,992	\$50,622	\$47,486	v/s	0%	0%	21%	-10%	-13%	0%	-10%	-14%	0%	-20%	-26%	0%	-20%	-26%	21%	
North Bay (North)	60 Years (3 Life Cycles)	8.5%	\$64,629	\$48,297	\$44,114	v/s	0%	0%	20%	-9%	-12%	0%	-11%	-14%	0%	-19%	-26%	0%	-19%	-26%	20%	
Sault Ste. Marie (North)	60 Years (3 Life Cycles)	8.5%	\$52,874	\$40,668	\$42,835	v/s	0%	0%	21%	-11%	-14%	0%	-13%	-17%	0%	-24%	-31%	0%	-24%	-31%	21%	
Sudbury (North)	60 Years (3 Life Cycles)	8.5%	\$65,241	\$48,916	\$47,585	v/s	0%	0%	20%	-9%	-12%	0%	-11%	-14%	0%	-20%	-26%	0%	-20%	-26%	20%	
Timmins (North)	60 Years (3 Life Cycles)	8.5%	\$66,263	\$49,939	\$47,925	v/s	0%	0%	21%	-9%	-13%	0%	-10%	-14%	0%	-20%	-26%	0%	-20%	-26%	21%	
Thunder Bay (North)	60 Years (3 Life Cycles)	8.5%	\$66,674	\$50,329	\$46,616	v/s	0%	0%	21%	-10%	-13%	0%	-10%	-14%	0%	-20%	-26%	0%	-20%	-26%	21%	

Table 12h: % change in present values for comparative scenarios in regards to the main scenario for V.GSHP, H.GSHP (three life cycles) and Traditional HVAC Applications (five life cycles) at a discount rate of 8.5% for improved construction scenario

		Total Present Value																				
		Main Scenario					v/s	Comparative Scenarios														
		Base Case Scenario					v/s	Carbon Taxes - (€1)			FIT - (€2)			Rebates - (€3)			FIT+Rebates - (€4)			(FIT+Rebates) + Carbon Taxes - (€5)		
City	Project Life Span	Discount Rate	V.GSHP	H.GSHP	Traditional	v/s	V.GSHP	H.GSHP	Traditional	V.GSHP	H.GSHP	Traditional	V.GSHP	H.GSHP	Traditional	V.GSHP	H.GSHP	Traditional	V.GSHP	H.GSHP	Traditional	
Cambridge (South)	60 Years (3 Life Cycles)	10%	\$46,128	\$34,823	\$33,830	v/s	\$46,128	\$34,823	\$39,811	\$41,683	\$30,340	\$33,830	\$39,780	\$28,474	\$33,830	\$35,334	\$23,992	\$33,830	\$35,334	\$23,992	\$39,811	
Chatham (South)	60 Years (3 Life Cycles)	10%	\$45,195	\$33,885	\$36,663	v/s	\$45,195	\$33,885	\$42,040	\$41,033	\$29,687	\$36,663	\$38,847	\$27,536	\$36,663	\$34,684	\$23,339	\$36,663	\$34,684	\$23,339	\$42,040	
Guelph (South)	60 Years (3 Life Cycles)	10%	\$46,312	\$35,007	\$34,261	v/s	\$46,312	\$35,007	\$40,419	\$41,811	\$30,468	\$34,261	\$39,964	\$28,658	\$34,261	\$35,462	\$24,120	\$34,261	\$35,462	\$24,120	\$40,419	
Hamilton (South)	60 Years (3 Life Cycles)	10%	\$45,885	\$34,579	\$38,106	v/s	\$45,885	\$34,579	\$43,935	\$41,513	\$30,171	\$38,106	\$39,537	\$28,231	\$38,106	\$35,165	\$23,823	\$38,106	\$35,165	\$23,823	\$43,935	
Kingston (South)	60 Years (3 Life Cycles)	10%	\$57,668	\$42,557	\$41,068	v/s	\$57,668	\$42,557	\$47,274	\$52,904	\$37,755	\$41,068	\$51,319	\$36,208	\$41,068	\$46,556	\$31,407	\$41,068	\$46,556	\$31,407	\$47,274	
Kitchener-Waterloo (South)	60 Years (3 Life Cycles)	10%	\$57,389	\$42,277	\$38,706	v/s	\$57,389	\$42,277	\$44,878	\$52,710	\$37,561	\$38,706	\$51,040	\$35,929	\$38,706	\$46,362	\$31,213	\$38,706	\$46,362	\$31,213	\$44,878	
London (South)	60 Years (3 Life Cycles)	10%	\$46,131	\$34,813	\$36,044	v/s	\$46,131	\$34,813	\$42,025	\$41,685	\$30,333	\$36,044	\$39,783	\$28,464	\$36,044	\$35,337	\$23,985	\$36,044	\$35,337	\$23,985	\$42,025	
Mt. Forest (South)	60 Years (3 Life Cycles)	10%	\$57,500	\$35,332	\$38,532	v/s	\$57,500	\$35,332	\$45,090	\$52,788	\$30,695	\$38,532	\$51,152	\$28,983	\$38,532	\$46,439	\$24,347	\$38,532	\$46,439	\$24,347	\$45,090	
Niagara Falls (South)	60 Years (3 Life Cycles)	10%	\$45,379	\$34,073	\$37,447	v/s	\$45,379	\$34,073	\$42,886	\$41,161	\$29,818	\$37,447	\$39,031	\$27,725	\$37,447	\$34,812	\$23,470	\$37,447	\$34,812	\$23,470	\$42,886	
Sarnia (South)	60 Years (3 Life Cycles)	10%	\$45,039	\$33,709	\$36,973	v/s	\$45,039	\$33,709	\$42,465	\$40,924	\$29,564	\$36,973	\$38,691	\$27,360	\$36,973	\$34,576	\$23,216	\$36,973	\$34,576	\$23,216	\$42,465	
Simcoe (South)	60 Years (3 Life Cycles)	10%	\$45,666	\$34,361	\$38,653	v/s	\$45,666	\$34,361	\$44,353	\$41,361	\$30,019	\$38,653	\$39,318	\$28,013	\$38,653	\$35,013	\$23,670	\$38,653	\$35,013	\$23,670	\$44,353	
St. Catharines (South)	60 Years (3 Life Cycles)	10%	\$55,693	\$33,405	\$37,585	v/s	\$55,693	\$33,405	\$42,849	\$51,529	\$29,353	\$37,585	\$49,345	\$27,057	\$37,585	\$45,181	\$23,004	\$37,585	\$45,181	\$23,004	\$42,849	
Toronto (South)	60 Years (3 Life Cycles)	10%	\$57,081	\$34,841	\$37,652	v/s	\$57,081	\$34,841	\$43,644	\$52,496	\$30,353	\$37,652	\$50,733	\$28,492	\$37,652	\$46,148	\$24,005	\$37,652	\$46,148	\$24,005	\$43,644	
Trenton (South)	60 Years (3 Life Cycles)	10%	\$57,228	\$42,102	\$40,751	v/s	\$57,228	\$42,102	\$46,782	\$52,598	\$37,439	\$40,751	\$50,879	\$35,753	\$40,751	\$46,249	\$31,090	\$40,751	\$46,249	\$31,090	\$46,782	
Warton (South)	60 Years (3 Life Cycles)	10%	\$57,793	\$42,663	\$39,564	v/s	\$57,793	\$42,663	\$45,962	\$52,991	\$37,830	\$39,564	\$51,444	\$36,315	\$39,564	\$46,643	\$31,482	\$39,564	\$46,643	\$31,482	\$45,962	
Windsor (South)	60 Years (3 Life Cycles)	10%	\$45,206	\$33,903	\$36,691	v/s	\$45,206	\$33,903	\$42,081	\$41,041	\$29,699	\$36,691	\$38,858	\$27,554	\$36,691	\$34,692	\$23,351	\$36,691	\$34,692	\$23,351	\$42,081	
Barrie (Distinct)	60 Years (3 Life Cycles)	10%	\$57,554	\$42,420	\$35,534	v/s	\$57,554	\$42,420	\$41,593	\$52,826	\$37,661	\$35,534	\$51,206	\$36,072	\$35,534	\$46,477	\$31,312	\$35,534	\$46,477	\$31,312	\$41,593	
Muskoka (Distinct)	60 Years (3 Life Cycles)	10%	\$58,082	\$42,948	\$36,752	v/s	\$58,082	\$42,948	\$43,234	\$53,193	\$38,028	\$36,752	\$51,733	\$36,599	\$36,752	\$46,845	\$31,680	\$36,752	\$46,845	\$31,680	\$43,234	
Ottawa (Distinct)	60 Years (3 Life Cycles)	10%	\$57,599	\$42,486	\$37,971	v/s	\$57,599	\$42,486	\$44,168	\$52,856	\$37,706	\$37,971	\$51,250	\$36,138	\$37,971	\$46,508	\$31,358	\$37,971	\$46,508	\$31,358	\$44,168	
Peterborough (Distinct)	60 Years (3 Life Cycles)	10%	\$57,990	\$42,877	\$38,532	v/s	\$57,990	\$42,877	\$44,993	\$53,129	\$37,979	\$38,532	\$51,641	\$36,529	\$38,532	\$46,780	\$31,630	\$38,532	\$46,780	\$31,630	\$44,993	
Kapuskasing (North)	60 Years (3 Life Cycles)	10%	\$60,669	\$45,550	\$45,166	v/s	\$60,669	\$45,550	\$53,140	\$54,995	\$39,840	\$45,166	\$54,321	\$39,201	\$45,166	\$48,647	\$33,492	\$45,166	\$48,647	\$33,492	\$53,140	
Kenora (North)	60 Years (3 Life Cycles)	10%	\$60,079	\$44,955	\$40,826	v/s	\$60,079	\$44,955	\$48,309	\$54,584	\$39,426	\$40,826	\$53,731	\$38,607	\$40,826	\$48,236	\$33,078	\$40,826	\$48,236	\$33,078	\$48,309	
North Bay (North)	60 Years (3 Life Cycles)	10%	\$58,077	\$42,985	\$37,981	v/s	\$58,077	\$42,985	\$44,504	\$53,189	\$38,054	\$37,981	\$51,728	\$36,637	\$37,981	\$46,841	\$31,706	\$37,981	\$46,841	\$31,706	\$44,504	
Sault Ste. Marie (North)	60 Years (3 Life Cycles)	10%	\$47,288	\$36,005	\$36,850	v/s	\$47,288	\$36,005	\$43,518	\$42,490	\$31,164	\$36,850	\$40,939	\$29,657	\$36,850	\$36,142	\$24,816	\$36,850	\$36,142	\$24,816	\$43,518	
Sudbury (North)	60 Years (3 Life Cycles)	10%	\$58,596	\$43,509	\$40,962	v/s	\$58,596	\$43,509	\$47,952	\$53,551	\$38,419	\$40,962	\$52,248	\$37,161	\$40,962	\$47,203	\$32,071	\$40,962	\$47,203	\$32,071	\$47,952	
Timmins (North)	60 Years (3 Life Cycles)	10%	\$59,462	\$44,377	\$41,195	v/s	\$59,462	\$44,377	\$48,887	\$54,154	\$39,023	\$41,195	\$53,113	\$38,028	\$41,195	\$47,806	\$32,675	\$41,195	\$47,806	\$32,675	\$48,887	
Thunder Bay (North)	60 Years (3 Life Cycles)	10%	\$59,810	\$44,707	\$40,090	v/s	\$59,810	\$44,707	\$47,475	\$54,397	\$39,253	\$40,090	\$53,461	\$38,359	\$40,090	\$48,048	\$32,905	\$40,090	\$48,048	\$32,905	\$47,475	

Table 12i: Rankings of the Cities Based on present values for V.GSHP, H.GSHP (three life cycles) and Traditional HVAC Applications (five life cycles) at a discount rate of 10% for improved construction scenario

			Total Present Value																			
			Main Scenario				v/s	Comparative Scenarios														
			Base Case Scenario			v/s	Carbon Taxes - (€1)			FIT - (€2)			Rebates - (€3)			FIT+Rebates - (€4)			(FIT+Rebates) + Carbon Taxes - (€5)			
City	Project Life Span	Discount Rate	V.GSHP	H.GSHP	Traditional	v/s	V.GSHP	H.GSHP	Traditional	V.GSHP	H.GSHP	Traditional	V.GSHP	H.GSHP	Traditional	V.GSHP	H.GSHP	Traditional	V.GSHP	H.GSHP	Traditional	
Cambridge (South)	60 Years (3 Life Cycles)	10%	\$46,128	\$34,823	\$33,830	v/s	0%	0%	18%	-10%	-13%	0%	-14%	-18%	0%	-23%	-31%	0%	-23%	-31%	18%	
Chatham (South)	60 Years (3 Life Cycles)	10%	\$45,195	\$33,885	\$36,663	v/s	0%	0%	15%	-9%	-12%	0%	-14%	-19%	0%	-23%	-31%	0%	-23%	-31%	15%	
Guelph (South)	60 Years (3 Life Cycles)	10%	\$46,312	\$35,007	\$34,261	v/s	0%	0%	18%	-10%	-13%	0%	-14%	-18%	0%	-23%	-31%	0%	-23%	-31%	18%	
Hamilton (South)	60 Years (3 Life Cycles)	10%	\$45,885	\$34,579	\$38,106	v/s	0%	0%	15%	-10%	-13%	0%	-14%	-18%	0%	-23%	-31%	0%	-23%	-31%	15%	
Kingston (South)	60 Years (3 Life Cycles)	10%	\$57,668	\$42,557	\$41,068	v/s	0%	0%	15%	-8%	-11%	0%	-11%	-15%	0%	-19%	-26%	0%	-19%	-26%	15%	
Kitchener-Waterloo (South)	60 Years (3 Life Cycles)	10%	\$57,389	\$42,277	\$38,706	v/s	0%	0%	16%	-8%	-11%	0%	-11%	-15%	0%	-19%	-26%	0%	-19%	-26%	16%	
London (South)	60 Years (3 Life Cycles)	10%	\$46,131	\$34,813	\$36,044	v/s	0%	0%	17%	-10%	-13%	0%	-14%	-18%	0%	-23%	-31%	0%	-23%	-31%	17%	
Mt. Forest (South)	60 Years (3 Life Cycles)	10%	\$57,500	\$35,332	\$38,532	v/s	0%	0%	17%	-8%	-13%	0%	-11%	-18%	0%	-19%	-31%	0%	-19%	-31%	17%	
Niagara Falls (South)	60 Years (3 Life Cycles)	10%	\$45,379	\$34,073	\$37,447	v/s	0%	0%	15%	-9%	-12%	0%	-14%	-19%	0%	-23%	-31%	0%	-23%	-31%	15%	
Sarnia (South)	60 Years (3 Life Cycles)	10%	\$45,039	\$33,709	\$36,973	v/s	0%	0%	15%	-9%	-12%	0%	-14%	-19%	0%	-23%	-31%	0%	-23%	-31%	15%	
Simcoe (South)	60 Years (3 Life Cycles)	10%	\$45,666	\$34,361	\$38,653	v/s	0%	0%	15%	-9%	-13%	0%	-14%	-18%	0%	-23%	-31%	0%	-23%	-31%	15%	
St. Catharines (South)	60 Years (3 Life Cycles)	10%	\$55,693	\$33,405	\$37,585	v/s	0%	0%	14%	-7%	-12%	0%	-11%	-19%	0%	-19%	-31%	0%	-19%	-31%	14%	
Toronto (South)	60 Years (3 Life Cycles)	10%	\$57,081	\$34,841	\$37,652	v/s	0%	0%	16%	-8%	-13%	0%	-11%	-18%	0%	-19%	-31%	0%	-19%	-31%	16%	
Trenton (South)	60 Years (3 Life Cycles)	10%	\$57,228	\$42,102	\$40,751	v/s	0%	0%	15%	-8%	-11%	0%	-11%	-15%	0%	-19%	-26%	0%	-19%	-26%	15%	
Warton (South)	60 Years (3 Life Cycles)	10%	\$57,793	\$42,663	\$39,564	v/s	0%	0%	16%	-8%	-11%	0%	-11%	-15%	0%	-19%	-26%	0%	-19%	-26%	16%	
Windsor (South)	60 Years (3 Life Cycles)	10%	\$45,206	\$33,903	\$36,691	v/s	0%	0%	15%	-9%	-12%	0%	-14%	-19%	0%	-23%	-31%	0%	-23%	-31%	15%	
Barrie (Distinct)	60 Years (3 Life Cycles)	10%	\$57,554	\$42,420	\$35,534	v/s	0%	0%	17%	-8%	-11%	0%	-11%	-15%	0%	-19%	-26%	0%	-19%	-26%	17%	
Muskoka (Distinct)	60 Years (3 Life Cycles)	10%	\$58,082	\$42,948	\$36,752	v/s	0%	0%	18%	-8%	-11%	0%	-11%	-15%	0%	-19%	-26%	0%	-19%	-26%	18%	
Ottawa (Distinct)	60 Years (3 Life Cycles)	10%	\$57,599	\$42,486	\$37,971	v/s	0%	0%	16%	-8%	-11%	0%	-11%	-15%	0%	-19%	-26%	0%	-19%	-26%	16%	
Peterborough (Distinct)	60 Years (3 Life Cycles)	10%	\$57,990	\$42,877	\$38,532	v/s	0%	0%	17%	-8%	-11%	0%	-11%	-15%	0%	-19%	-26%	0%	-19%	-26%	17%	
Kapuskasing (North)	60 Years (3 Life Cycles)	10%	\$60,669	\$45,550	\$45,166	v/s	0%	0%	18%	-9%	-13%	0%	-10%	-14%	0%	-20%	-26%	0%	-20%	-26%	18%	
Kenora (North)	60 Years (3 Life Cycles)	10%	\$60,079	\$44,955	\$40,826	v/s	0%	0%	18%	-9%	-12%	0%	-11%	-14%	0%	-20%	-26%	0%	-20%	-26%	18%	
North Bay (North)	60 Years (3 Life Cycles)	10%	\$58,077	\$42,985	\$37,981	v/s	0%	0%	17%	-8%	-11%	0%	-11%	-15%	0%	-19%	-26%	0%	-19%	-26%	17%	
Sault Ste. Marie (North)	60 Years (3 Life Cycles)	10%	\$47,288	\$36,005	\$36,850	v/s	0%	0%	18%	-10%	-13%	0%	-13%	-18%	0%	-24%	-31%	0%	-24%	-31%	18%	
Sudbury (North)	60 Years (3 Life Cycles)	10%	\$58,596	\$43,509	\$40,962	v/s	0%	0%	17%	-9%	-12%	0%	-11%	-15%	0%	-19%	-26%	0%	-19%	-26%	17%	
Timmins (North)	60 Years (3 Life Cycles)	10%	\$59,462	\$44,377	\$41,195	v/s	0%	0%	19%	-9%	-12%	0%	-11%	-14%	0%	-20%	-26%	0%	-20%	-26%	19%	
Thunder Bay (North)	60 Years (3 Life Cycles)	10%	\$59,810	\$44,707	\$40,090	v/s	0%	0%	18%	-9%	-12%	0%	-11%	-14%	0%	-20%	-26%	0%	-20%	-26%	18%	

Table 12j: % change in present values for comparative scenarios in regards to the main scenario for V.GSHP, H.GSHP (three life cycles) and Traditional HVAC Applications (five life cycles) at a discount rate of 10% for improved construction scenario

			Total Present Value																			
			Main Scenario				v/s	Comparative Scenarios														
			Base Case Scenario				v/s	Carbon Taxes - (€1)			FIT - (€2)			Rebates - (€3)			(FIT+Rebates) - (€4)			(FIT+Rebates) + Carbon Taxes - (€5)		
City	Project Life Span	Discount Rate	V.GSHP	H.GSHP	Traditional	v/s	V.GSHP	H.GSHP	Traditional	V.GSHP	H.GSHP	Traditional	V.GSHP	H.GSHP	Traditional	V.GSHP	H.GSHP	Traditional	V.GSHP	H.GSHP	Traditional	
Cambridge (South)	60 Years (3 Life Cycles)	12%	\$41,227	\$30,728	\$28,760	v/s	\$41,227	\$30,728	\$33,045	\$37,515	\$26,985	\$28,760	\$35,338	\$24,839	\$28,760	\$31,626	\$21,096	\$28,760	\$31,626	\$21,096	\$33,045	
Chatham (South)	60 Years (3 Life Cycles)	12%	\$40,454	\$29,951	\$31,235	v/s	\$40,454	\$29,951	\$35,086	\$36,978	\$26,445	\$31,235	\$34,565	\$24,062	\$31,235	\$31,089	\$20,556	\$31,235	\$31,089	\$20,556	\$35,086	
Guelph (South)	60 Years (3 Life Cycles)	12%	\$41,380	\$30,880	\$29,115	v/s	\$41,380	\$30,880	\$33,527	\$37,621	\$27,091	\$29,115	\$35,491	\$24,992	\$29,115	\$31,732	\$21,202	\$29,115	\$31,732	\$21,202	\$33,527	
Hamilton (South)	60 Years (3 Life Cycles)	12%	\$41,026	\$30,527	\$32,426	v/s	\$41,026	\$30,527	\$36,601	\$37,375	\$26,845	\$32,426	\$35,137	\$24,638	\$32,426	\$31,486	\$20,956	\$32,426	\$31,486	\$20,956	\$36,601	
Kingston (South)	60 Years (3 Life Cycles)	12%	\$51,791	\$37,761	\$34,995	v/s	\$51,791	\$37,761	\$39,442	\$47,812	\$33,751	\$34,995	\$45,902	\$31,872	\$34,995	\$41,924	\$27,862	\$34,995	\$41,924	\$27,862	\$39,442	
Kitchener-Waterloo (South)	60 Years (3 Life Cycles)	12%	\$51,559	\$37,529	\$32,919	v/s	\$51,559	\$37,529	\$37,340	\$47,652	\$33,590	\$32,919	\$45,670	\$31,640	\$32,919	\$41,763	\$27,702	\$32,919	\$41,763	\$27,702	\$37,340	
London (South)	60 Years (3 Life Cycles)	12%	\$41,230	\$30,720	\$30,655	v/s	\$41,230	\$30,720	\$34,939	\$37,517	\$26,979	\$30,655	\$35,341	\$24,831	\$30,655	\$31,628	\$21,090	\$30,655	\$31,628	\$21,090	\$34,939	
Mt. Forest (South)	60 Years (3 Life Cycles)	12%	\$51,652	\$31,150	\$32,771	v/s	\$51,652	\$31,150	\$37,469	\$47,716	\$27,278	\$32,771	\$45,763	\$25,261	\$32,771	\$41,827	\$21,389	\$32,771	\$41,827	\$21,389	\$37,469	
Niagara Falls (South)	60 Years (3 Life Cycles)	12%	\$40,606	\$30,107	\$31,884	v/s	\$40,606	\$30,107	\$35,780	\$37,084	\$26,554	\$31,884	\$34,718	\$24,218	\$31,884	\$31,195	\$20,665	\$31,884	\$31,195	\$20,665	\$35,780	
Sarnia (South)	60 Years (3 Life Cycles)	12%	\$40,325	\$29,805	\$31,490	v/s	\$40,325	\$29,805	\$35,425	\$36,888	\$26,344	\$31,490	\$34,436	\$23,916	\$31,490	\$30,999	\$20,455	\$31,490	\$30,999	\$20,455	\$35,425	
Simcoe (South)	60 Years (3 Life Cycles)	12%	\$40,845	\$30,345	\$32,940	v/s	\$40,845	\$30,345	\$37,024	\$37,249	\$26,719	\$32,940	\$34,956	\$24,457	\$32,940	\$31,360	\$20,830	\$32,940	\$31,360	\$20,830	\$37,024	
St. Catharines (South)	60 Years (3 Life Cycles)	12%	\$50,154	\$29,553	\$32,000	v/s	\$50,154	\$29,553	\$35,771	\$46,676	\$26,169	\$32,000	\$44,265	\$23,664	\$32,000	\$40,788	\$20,280	\$32,000	\$40,788	\$20,280	\$35,771	
Toronto (South)	60 Years (3 Life Cycles)	12%	\$51,305	\$30,743	\$32,047	v/s	\$51,305	\$30,743	\$36,340	\$47,475	\$26,995	\$32,047	\$45,416	\$24,854	\$32,047	\$41,586	\$21,106	\$32,047	\$41,586	\$21,106	\$36,340	
Trenton (South)	60 Years (3 Life Cycles)	12%	\$51,426	\$37,384	\$34,735	v/s	\$51,426	\$37,384	\$39,056	\$47,559	\$33,489	\$34,735	\$45,537	\$31,495	\$34,735	\$41,670	\$27,600	\$34,735	\$41,670	\$27,600	\$39,056	
Warton (South)	60 Years (3 Life Cycles)	12%	\$51,894	\$37,849	\$33,687	v/s	\$51,894	\$37,849	\$38,271	\$47,884	\$33,812	\$33,687	\$46,005	\$31,960	\$33,687	\$41,995	\$27,924	\$33,687	\$41,995	\$27,924	\$38,271	
Windsor (South)	60 Years (3 Life Cycles)	12%	\$40,464	\$29,966	\$31,257	v/s	\$40,464	\$29,966	\$35,119	\$36,985	\$26,455	\$31,257	\$34,575	\$24,077	\$31,257	\$31,096	\$20,567	\$31,257	\$31,096	\$20,567	\$35,119	
Barrie (Distinct)	60 Years (3 Life Cycles)	12%	\$51,697	\$37,648	\$30,231	v/s	\$51,697	\$37,648	\$34,572	\$47,747	\$33,673	\$30,231	\$45,808	\$31,759	\$30,231	\$41,858	\$27,784	\$30,231	\$41,858	\$27,784	\$34,572	
Muskoka (Distinct)	60 Years (3 Life Cycles)	12%	\$52,134	\$38,085	\$31,236	v/s	\$52,134	\$38,085	\$35,879	\$48,051	\$33,976	\$31,236	\$46,245	\$32,196	\$31,236	\$42,162	\$28,087	\$31,236	\$42,162	\$28,087	\$35,879	
Ottawa (Distinct)	60 Years (3 Life Cycles)	12%	\$51,733	\$37,702	\$32,309	v/s	\$51,733	\$37,702	\$36,749	\$47,773	\$33,710	\$32,309	\$45,845	\$31,813	\$32,309	\$41,884	\$27,822	\$32,309	\$41,884	\$27,822	\$36,749	
Peterborough (Distinct)	60 Years (3 Life Cycles)	12%	\$52,057	\$38,026	\$32,772	v/s	\$52,057	\$38,026	\$37,400	\$47,998	\$33,935	\$32,772	\$46,169	\$32,137	\$32,772	\$42,109	\$28,046	\$32,772	\$42,109	\$28,046	\$37,400	
Kapuskasing (North)	60 Years (3 Life Cycles)	12%	\$54,278	\$40,241	\$38,372	v/s	\$54,278	\$40,241	\$44,085	\$49,539	\$35,473	\$38,372	\$48,389	\$34,352	\$38,372	\$43,650	\$29,584	\$38,372	\$43,650	\$29,584	\$44,085	
Kenora (North)	60 Years (3 Life Cycles)	12%	\$53,789	\$39,748	\$34,661	v/s	\$53,789	\$39,748	\$40,022	\$49,200	\$35,131	\$34,661	\$47,900	\$33,859	\$34,661	\$43,311	\$29,242	\$34,661	\$43,311	\$29,242	\$40,022	
North Bay (North)	60 Years (3 Life Cycles)	12%	\$52,130	\$38,116	\$32,314	v/s	\$52,130	\$38,116	\$36,987	\$48,048	\$33,998	\$32,314	\$46,241	\$32,227	\$32,314	\$42,159	\$28,109	\$32,314	\$42,159	\$28,109	\$36,987	
Sault Ste. Marie (North)	60 Years (3 Life Cycles)	12%	\$42,188	\$31,708	\$31,315	v/s	\$42,188	\$31,708	\$36,092	\$38,182	\$27,665	\$31,315	\$36,299	\$25,819	\$31,315	\$32,293	\$21,776	\$31,315	\$32,293	\$21,776	\$36,092	
Sudbury (North)	60 Years (3 Life Cycles)	12%	\$52,560	\$38,550	\$34,839	v/s	\$52,560	\$38,550	\$39,847	\$48,346	\$34,299	\$34,839	\$46,671	\$32,661	\$34,839	\$42,458	\$28,410	\$34,839	\$42,458	\$28,410	\$39,847	
Timmins (North)	60 Years (3 Life Cycles)	12%	\$53,277	\$39,269	\$34,965	v/s	\$53,277	\$39,269	\$40,475	\$48,845	\$34,798	\$34,965	\$47,388	\$33,380	\$34,965	\$42,956	\$28,909	\$34,965	\$42,956	\$28,909	\$40,475	
Thunder Bay (North)	60 Years (3 Life Cycles)	12%	\$53,566	\$39,543	\$34,052	v/s	\$53,566	\$39,543	\$39,343	\$49,045	\$34,988	\$34,052	\$47,677	\$33,654	\$34,052	\$43,156	\$29,099	\$34,052	\$43,156	\$29,099	\$39,343	

Table 12k: Rankings of the Cities Based on present values for V.GSHP, H.GSHP (three life cycles) and Traditional HVAC Applications (five life cycles) at a discount rate of 12% for improved construction scenario

			Total Present Value																		
			Main Scenario			v/s	Comparative Scenarios														
			Base Case Scenario			v/s	Carbon Taxes - (#1)			FIT - (#2)			Rebates - (#3)			FIT+Rebates - (#4)			(FIT+Rebates) + Carbon Taxes - (#5)		
City	Project Life Span	Discount Rate	V.GSHP	H.GSHP	Traditional	v/s	V.GSHP	H.GSHP	Traditional	V.GSHP	H.GSHP	Traditional	V.GSHP	H.GSHP	Traditional	V.GSHP	H.GSHP	Traditional	V.GSHP	H.GSHP	Traditional
Cambridge (South)	60 Years (3 Life Cycles)	12%	\$41,227	\$30,728	\$28,760	v/s	0%	0%	15%	-9%	-12%	0%	-14%	-19%	0%	-23%	-31%	0%	-23%	-31%	15%
Chatham (South)	60 Years (3 Life Cycles)	12%	\$40,454	\$29,951	\$31,235	v/s	0%	0%	12%	-9%	-12%	0%	-15%	-20%	0%	-23%	-31%	0%	-23%	-31%	12%
Guelph (South)	60 Years (3 Life Cycles)	12%	\$41,380	\$30,880	\$29,115	v/s	0%	0%	15%	-9%	-12%	0%	-14%	-19%	0%	-23%	-31%	0%	-23%	-31%	15%
Hamilton (South)	60 Years (3 Life Cycles)	12%	\$41,026	\$30,527	\$32,426	v/s	0%	0%	13%	-9%	-12%	0%	-14%	-19%	0%	-23%	-31%	0%	-23%	-31%	13%
Kingston (South)	60 Years (3 Life Cycles)	12%	\$51,791	\$37,761	\$34,995	v/s	0%	0%	13%	-8%	-11%	0%	-11%	-16%	0%	-19%	-26%	0%	-19%	-26%	13%
Kitchener-Waterloo (South)	60 Years (3 Life Cycles)	12%	\$51,559	\$37,529	\$32,919	v/s	0%	0%	13%	-8%	-10%	0%	-11%	-16%	0%	-19%	-26%	0%	-19%	-26%	13%
London (South)	60 Years (3 Life Cycles)	12%	\$41,230	\$30,720	\$30,655	v/s	0%	0%	14%	-9%	-12%	0%	-14%	-19%	0%	-23%	-31%	0%	-23%	-31%	14%
Mt. Forest (South)	60 Years (3 Life Cycles)	12%	\$51,652	\$31,150	\$32,771	v/s	0%	0%	14%	-8%	-12%	0%	-11%	-19%	0%	-19%	-31%	0%	-19%	-31%	14%
Niagara Falls (South)	60 Years (3 Life Cycles)	12%	\$40,606	\$30,107	\$31,884	v/s	0%	0%	12%	-9%	-12%	0%	-15%	-20%	0%	-23%	-31%	0%	-23%	-31%	12%
Sarnia (South)	60 Years (3 Life Cycles)	12%	\$40,325	\$29,805	\$31,490	v/s	0%	0%	12%	-9%	-12%	0%	-15%	-20%	0%	-23%	-31%	0%	-23%	-31%	12%
Simcoe (South)	60 Years (3 Life Cycles)	12%	\$40,845	\$30,345	\$32,940	v/s	0%	0%	12%	-9%	-12%	0%	-14%	-19%	0%	-23%	-31%	0%	-23%	-31%	12%
St. Catharines (South)	60 Years (3 Life Cycles)	12%	\$50,154	\$29,553	\$32,000	v/s	0%	0%	12%	-7%	-11%	0%	-12%	-20%	0%	-19%	-31%	0%	-19%	-31%	12%
Toronto (South)	60 Years (3 Life Cycles)	12%	\$51,305	\$30,743	\$32,047	v/s	0%	0%	13%	-7%	-12%	0%	-11%	-19%	0%	-19%	-31%	0%	-19%	-31%	13%
Trenton (South)	60 Years (3 Life Cycles)	12%	\$51,426	\$37,384	\$34,735	v/s	0%	0%	12%	-8%	-10%	0%	-11%	-16%	0%	-19%	-26%	0%	-19%	-26%	12%
Warton (South)	60 Years (3 Life Cycles)	12%	\$51,894	\$37,849	\$33,687	v/s	0%	0%	14%	-8%	-11%	0%	-11%	-16%	0%	-19%	-26%	0%	-19%	-26%	14%
Windsor (South)	60 Years (3 Life Cycles)	12%	\$40,464	\$29,966	\$31,257	v/s	0%	0%	12%	-9%	-12%	0%	-15%	-20%	0%	-23%	-31%	0%	-23%	-31%	12%
Barrie (Distinct)	60 Years (3 Life Cycles)	12%	\$51,697	\$37,648	\$30,231	v/s	0%	0%	14%	-8%	-11%	0%	-11%	-16%	0%	-19%	-26%	0%	-19%	-26%	14%
Muskoka (Distinct)	60 Years (3 Life Cycles)	12%	\$52,134	\$38,085	\$31,236	v/s	0%	0%	15%	-8%	-11%	0%	-11%	-15%	0%	-19%	-26%	0%	-19%	-26%	15%
Ottawa (Distinct)	60 Years (3 Life Cycles)	12%	\$51,733	\$37,702	\$32,309	v/s	0%	0%	14%	-8%	-11%	0%	-11%	-16%	0%	-19%	-26%	0%	-19%	-26%	14%
Peterborough (Distinct)	60 Years (3 Life Cycles)	12%	\$52,057	\$38,026	\$32,772	v/s	0%	0%	14%	-8%	-11%	0%	-11%	-15%	0%	-19%	-26%	0%	-19%	-26%	14%
Kapuskasing (North)	60 Years (3 Life Cycles)	12%	\$54,278	\$40,241	\$38,372	v/s	0%	0%	15%	-9%	-12%	0%	-11%	-15%	0%	-20%	-26%	0%	-20%	-26%	15%
Kenora (North)	60 Years (3 Life Cycles)	12%	\$53,789	\$39,748	\$34,661	v/s	0%	0%	15%	-9%	-12%	0%	-11%	-15%	0%	-19%	-26%	0%	-19%	-26%	15%
North Bay (North)	60 Years (3 Life Cycles)	12%	\$52,130	\$38,116	\$32,314	v/s	0%	0%	14%	-8%	-11%	0%	-11%	-15%	0%	-19%	-26%	0%	-19%	-26%	14%
Sault Ste. Marie (North)	60 Years (3 Life Cycles)	12%	\$42,188	\$31,708	\$31,315	v/s	0%	0%	15%	-9%	-13%	0%	-14%	-19%	0%	-23%	-31%	0%	-23%	-31%	15%
Sudbury (North)	60 Years (3 Life Cycles)	12%	\$52,560	\$38,550	\$34,839	v/s	0%	0%	14%	-8%	-11%	0%	-11%	-15%	0%	-19%	-26%	0%	-19%	-26%	14%
Timmins (North)	60 Years (3 Life Cycles)	12%	\$53,277	\$39,269	\$34,965	v/s	0%	0%	16%	-8%	-11%	0%	-11%	-15%	0%	-19%	-26%	0%	-19%	-26%	16%
Thunder Bay (North)	60 Years (3 Life Cycles)	12%	\$53,566	\$39,543	\$34,052	v/s	0%	0%	16%	-8%	-12%	0%	-11%	-15%	0%	-19%	-26%	0%	-19%	-26%	16%

Table 12l: % change in present values for comparative scenarios in regards to the main scenario for V.GSHP, H.GSHP (three life cycles) and Traditional HVAC Applications (five life cycles) at a discount rate of 12% for improved construction scenario

3.1.3 Environmental Assessment

In this section, the use of natural gas (in cubic meters) from the traditional HVAC applications (natural gas furnace and natural gas water heater) has been translated into carbon emissions to analyze the environmental foot print in the selected twenty-seven (27) cities of Ontario.

3.1.3.1 Carbon Footprint of Traditional HVAC Applications in Ontario Cities – Average Construction Type

It is found out that St. Catharines has the lowest annual environmental footprint with 5.78 tons of CO₂ emissions produced by natural gas furnace and natural gas water heater. The total natural gas usage of St. Catharines is 3,192 cubic meters (m³) on a yearly basis. Kapuskasing is ranked at the top with the highest annual environmental footprint of 9.07 tons of CO₂ emissions. The total annual natural gas use for Kapuskasing is 5,010 cubic meters (m³). Please see Table 13 for the complete ranking.

3.1.3.2 Carbon Footprint of Traditional HVAC Applications in Ontario Cities – Improved construction Type

Similar results were achieved with the improved construction type analysis. St. Catharines occupying the top position for the least carbon footprint with a natural gas usage of 2,701 cubic meters (m³) from natural gas furnace and natural gas water heater producing 4.89 tons of CO₂ emissions. On the other hand, Kapuskasing has the highest carbon footprint with a natural gas usage of 4,092 cubic meters (m³) from natural gas furnace and natural gas water heater producing 7.41 tons of CO₂ emissions. Please see Table 14 for a detailed ranking.

3.1.3.3 Percentage (%) Difference

The switching from average to improved construction type has resulted in a decrease of CO₂ emissions between the ranges of 15% – 18% as the capacity of the natural gas furnace and natural gas water heater goes down to accommodate the heating and cooling loads. This can be seen in Table 15.

Environmental Assessment - Average Construction Type					
		Natural Gas Usage (Traditional HVAC Applications)			0.00181
#	Cities	Heating (m ³)	Hot Water (m ³)	Total (m ³)	CO ₂ Emissions (in tons)
1	St. Catharines (South)	2,237	955	3,192	5.78
2	Chatham (South)	2,235	1,003	3,238	5.86
3	Windsor (South)	2,244	1,003	3,247	5.88
4	Niagara Falls (South)	2,264	1,015	3,279	5.93
5	Sarnia (South)	2,378	950	3,328	6.02
6	Simcoe (South)	2,442	1,007	3,449	6.24
7	Hamilton (South)	2,509	1,030	3,539	6.41
8	London (South)	2,598	1,028	3,626	6.56
9	Cambridge (South)	2,609	1,029	3,638	6.58
10	Toronto (South)	2,618	1,028	3,646	6.60
11	Trenton (South)	2,638	1,033	3,671	6.64
12	Barrie (Distinct)	2,679	1,058	3,737	6.76
13	Guelph (South)	2,726	1,029	3,755	6.80
14	Kitchener-Waterloo (South)	2,726	1,036	3,762	6.81
15	Kingston (South)	2,726	1,054	3,780	6.84
16	Ottawa (Distinct)	2,786	1,047	3,833	6.94
17	Warton (South)	2,855	1,052	3,907	7.07
18	Peterborough (Distinct)	2,887	1,055	3,942	7.14
19	Muskoka (Distinct)	2,951	1,067	4,018	7.27
20	Mt. Forest (South)	3,006	1,015	4,021	7.28
21	North Bay (North)	2,987	1,061	4,048	7.33
22	Sault Ste. Marie (North)	3,071	1,059	4,130	7.48
23	Sudbury (North)	3,302	1,059	4,361	7.89
24	Thunder Bay (North)	3,506	1,106	4,612	8.35
25	Kenora (North)	3,574	1,105	4,679	8.47
26	Timmins (North)	3,785	1,051	4,836	8.75
27	Kapuskasing (North)	3,907	1,103	5,010	9.07

Note: 1 Cubic Meter of Natural Gas produces 0.00181 tons of CO₂ emissions

Table 13: Natural gas usage (in cubic meters) from traditional HVAC applications (natural gas furnace and natural gas water heater) and CO₂ emissions (in tons) produced from the Natural Gas Usage for a 2,000 square feet detached house above grade (average construction type) in the twenty-seven (27) cities (ascending order) of Ontario

Environmental Assessment - Improved Construction Type				
	Natural Gas Usage (Traditional HVAC Applications)			0.00181
Cities	Heating (m ³)	Hot Water (m ³)	Total (m ³)	CO ₂ Emissions (in tons)
St. Catharines (South)	1,746	955	2,701	4.89
Chatham (South)	1,756	1,003	2,759	4.99
Windsor (South)	1,763	1,003	2,766	5.01
Niagara Falls (South)	1,776	1,015	2,791	5.05
Sarnia (South)	1,868	950	2,818	5.10
Simcoe (South)	1,918	1,007	2,925	5.29
Hamilton (South)	1,961	1,030	2,991	5.41
Cambridge (South)	2,040	1,029	3,069	5.55
London (South)	2,041	1,028	3,069	5.55
Toronto (South)	2,047	1,028	3,075	5.57
Trenton (South)	2,062	1,033	3,095	5.60
Barrie (Distinct)	2,051	1,058	3,109	5.63
Guelph (South)	2,131	1,029	3,160	5.72
Kitchener-Waterloo (South)	2,131	1,036	3,167	5.73
Ottawa (Distinct)	2,133	1,047	3,180	5.76
Kingston (South)	2,131	1,054	3,185	5.76
Warton (South)	2,231	1,052	3,283	5.94
Peterborough (Distinct)	2,260	1,055	3,315	6.00
Muskoka (Distinct)	2,259	1,067	3,326	6.02
North Bay (North)	2,286	1,061	3,347	6.06
Mt. Forest (South)	2,350	1,015	3,365	6.09
Sault Ste. Marie (North)	2,363	1,059	3,422	6.19
Sudbury (North)	2,528	1,059	3,587	6.49
Thunder Bay (North)	2,684	1,106	3,790	6.86
Kenora (North)	2,735	1,105	3,840	6.95
Timmins (North)	2,896	1,051	3,947	7.14
Kapuskasing (North)	2,989	1,103	4,092	7.41

Note: 1 Cubic Meter of Natural Gas produces 0.00181 tons of CO₂ emissions

Table 14: Natural gas usage (in cubic meters) from traditional HVAC applications (natural gas furnace and natural gas water heater) and CO₂ emissions (in tons) produced from the Natural Gas Usage for a 2,000 square feet detached house above grade (improved construction type) in the twenty-seven (27) cities (ascending order) of Ontario

Difference (% Change) - Carbon Emissions			
	Average Construction	Improved Construction	Difference
Cities	CO ₂ Emissions (in tons)	CO ₂ Emissions (in tons)	%
Cambridge (South)	6.58	5.55	-16%
Chatham (South)	5.86	4.99	-15%
Guelph (South)	6.80	5.72	-16%
Hamilton (South)	6.41	5.41	-15%
Kingston (South)	6.84	5.76	-16%
Kitchener-Waterloo (South)	6.81	5.73	-16%
London (South)	6.56	5.55	-15%
Mt. Forest (South)	7.28	6.09	-16%
Niagara Falls (South)	5.93	5.05	-15%
Sarnia (South)	6.02	5.10	-15%
Simcoe (South)	6.24	5.29	-15%
St. Catharines (South)	5.78	4.89	-15%
Toronto (South)	6.60	5.57	-16%
Trenton (South)	6.64	5.60	-16%
Warton (South)	7.07	5.94	-16%
Windsor (South)	5.88	5.01	-15%
Barrie (Distinct)	6.76	5.63	-17%
Muskoka (Distinct)	7.27	6.02	-17%
Ottawa (Distinct)	6.94	5.76	-17%
Peterborough (Distinct)	7.14	6.00	-16%
Kapuskasing (North)	9.07	7.41	-18%
Kenora (North)	8.47	6.95	-18%
North Bay (North)	7.33	6.06	-17%
Sault Ste. Marie (North)	7.48	6.19	-17%
Sudbury (North)	7.89	6.49	-18%
Timmins (North)	8.75	7.14	-18%
Thunder Bay (North)	8.35	6.86	-18%

Table 15: % Change (switching from average to improved construction type) in CO₂ emissions (in tons) produced from the Natural Gas Usage for a 2,000 square feet detached house above grade in the twenty-seven (27) cities of Ontario

3.1.3.4 Environmental Role of GSHPs in Ontario

The deployment of ground source heat pump systems in the residential sector of Ontario can eliminate the carbon emissions generated from natural gas furnace and natural gas water heater completely. Natural gas has contributed 391.3 petajoules (see Figure 15) of energy in the residential sector of Ontario. This means 68.50% (share in comparison with other energy sources) of energy is supplied by natural gas to the Ontario residential households resulting in 19.1 megatonnes (Mt) of carbon emissions from natural gas.

In other words, replacing all the fossil fuel based traditional HVAC applications in the residential sector of Ontario with GSHP system has the potential to reduce the carbon emissions of Ontario by 21.7 megatonnes (Mt). The total carbon emissions in Ontario in the year of 2014 were 168.5 megatonnes (Mt). This replacement of traditional HVAC applications with clean and renewable ground source heat pump systems (GSHPs) will take the value of total carbon emissions in Ontario from 168.5 to 146.8 megatonnes (Mt) *i.e.* a reduction of 13% in CO₂ emissions in Ontario.

Chapter 4 – Summary and Recommendations

4.1 Summary

This study is a comprehensive evaluation of the potential for the use of ground source heat as a replacement of fossil fuel resources in Ontario. Our conclusion is that, GSHPs can provide a cost-effective substitute for building energy use with benefits of large reduction in carbon emissions. We provide detailed technical and economic data for several cities of different regions in Ontario to help establish the unique feasibility of implementing GSHPs on a large-scale in Ontario. The scope of the study is based on a detailed characterization of the geophysical parameters and identification of the ground source heat potential in twenty seven (27) cities across Ontario.

Even though, there is some economic variation of the potential in different geographical parts of Ontario (see Table 8), horizontal GSHPs emerges to be a strong winner. The order of merit of the potential and economic viability are ranked and identified for each of the cities in different regions (see Tables 9a-9l, 10a-10l, 11a-11l, 12a-12l, and Appendix F1 and F2). The corresponding greenhouse gas (GHG) reduction are also evaluated for the illustrative home (*i.e.* a 2,000 square feet detached house above grade) in each of the cities (see Tables 13, 14, and 15).

4.1.1 Technical Barriers

The technical challenges in regards to the installation of GSHPs include (Henrich, 2016):

- 1. Accurately modeling building loads and energy models:** Some contractors constantly use presets and non-specific templates to calculate energy models. This can lead to over or undersized loop fields which can lead to poor performance or even failure.
- 2. Applying the proper design progression:** Contractors routinely mischaracterize the procedure for accurately designing loop systems. This leads to poorly designed systems and higher upfront costs. Quite simply the process should include a robust feasibility study; accurately calculate building energy loads; preliminary loop design based on geologic research and available installation assets in the area; intensive feasibility study based on preliminary loop design; apply financial case for order of TC test; optimize preliminary loop design with TC test data; specify loop design; verify loop installation is in accordance with design. Understanding the capabilities of the installation assets in any given areas should be carefully analyzed. In order to manage financial pressures, be sure to select design that many installers can provide quotes on. Specifying excessively deep bores or overly unique heat exchangers will cause significant increases to the installation costs. This is a simple progression that would ultimately lead to a very high success rate.

- 3. Protection Levels:** Understanding minimum protection levels for the different forms of anti-freeze is important. The minimum concentration for propylene glycol to act as a bacterial inhibitor is 20%. But exceeding 25% can cause significant increase in pressure drop and thus costing quite a few extra kilowatts to pump. On top of that, you need to specify a protection level that will adequately freeze protect your circulating solution in all parts of the system including the heat exchanger in the heat pump itself.
- 4. Lack of Technical Knowledge:** Another large technical challenge is the basic understanding of what it takes to install these systems. Engineers have a tendency to not fully understand the ramifications of the plans they put on paper. Understanding how big some of the drilling operations are, space requirements, logistical issues and other operational procedures could go a long way to helping reduce costs of these systems.
- 5. Drilling:** There is no technical issue that cannot be overcome through the use of proper tool/equipment and well established engineering knowledge. The combination of trenchless technologies (for horizontal trenching) and percussion drilling equipment (for vertical boreholes) can install ground loops in clay as well as in granite. The geothermal industry is well equipped to drill boreholes in granite. As a matter of fact, they prefer granite as it has the best thermal conductivity and thermal diffusivity (see Table 1) that would easily reduce the overall costs of the GSHPs including installation, operational, and maintenance cost (Marco, 2016).
- 6. Space:** It is one of the most important factors impacting the installation of GSHPs. It determines the loop circuit layout, and trenching and borehole configurations of GSHPs. The trenches and boreholes have to be 15 feet apart from each other for ground heat recovery. It is usually not a problem in a detached or a single attached home where a 4 ton unit requires two boreholes (for V.GSHPs) and 4 trenches (H.GSHPs). On the contrary, lack of space or limited space would pose a technical challenge for high rise apartment buildings where a 500 ton GSHP unit needs to be installed that requires 150 vertical boreholes (Marco, 2016).

4.1.2 Economic Barriers

One of the major concerns of the consumers in the residential sector of Ontario is the high up front cost (initial investment or installation cost). It is \$5,000 per ton for H.GSHPs and \$8,000 per ton for V.GSHPs. This results in an initial investment of \$20,000 (for H.GSHP) and \$32,000 (for V.GSHP) for a 4 ton unit as compared to a \$10,000 to \$12,000 traditional energy application (fossil fuel based system) in a 2,000 square feet detached house above grade facility. However, if one considers the lifespans of GSHPs against traditional energy applications then a consumer needs to invest 2 to 3 times in the former technology as compared to 5 times in the later in a 60 year lifespan.

The lifespan of GSHPs is between 20 to 30 years whereas the traditional energy applications are good for 12 years.

The consumers need to assess the entire life cycle costing before making an investment decision. In addition, the introduction of rebates, feed-in tariffs and carbon taxes will make investments in GSHPs more lucrative and rewarding and less attractive in traditional energy applications (fossil fuel based systems).

4.1.3 Environmental Impact

The mass scale deployment of GSHPs will reduce the greenhouse (GHG) emissions substantially in the residential sector of Ontario. The overall impact for the province of Ontario would be 13% less carbon emissions if the fossil fuel based HVAC systems would be replaced by GSHPs in all the households of Ontario.

4.1.4 Strategic Planning

The deployment strategy of GSHPs should start from the most populous cities to have a strong impact on the carbon footprint. There are more household-dwelling units in cities of southern and distinct regions as compared to northern region of Ontario.

The contractors need to optimize the loop circuit layout and trenching and borehole configurations of GSHPs to reduce the life cycle costs and maximize the overall performance of the GSHPs.

The government needs to introduce incentives such as rebates and feed-in tariffs for the purchase of GSHPs and entail heavy carbon taxes on fossil fuel based traditional HVAC energy applications to support the geothermal heating and cooling industry.

The big gas companies have all the required infrastructure in place *i.e.* the high density polyethylene (HDPE) pipes beneath the ground that is currently used to distribute natural gas. The supply of these pipes connects to the residential household units in Ontario. These companies need to take a step forward towards the decarbonization of Canadian energy economy by replacing natural gas with an anti-freeze solution (ethanol for example) to extract carbon free heat from the ground to provide space heating and cooling not only to the residential sector but also includes the commercial, industrial, and institutional sectors of Ontario.

4.2 Conclusion

In this study, we have established the basis for evaluating the cost and environmental benefits of ground source heat pump systems (GSHPs) in Ontario. The results provide an economic and technical foundation for supporting investment decisions in favour of implementing GSHPs as a viable alternative to natural gas use for space heating and hot water usage in residential buildings.

4.3 Contribution

The main contribution of this study is to establish a basis of implementation of GSHPs in Ontario based on economic and environmental factors. The generation of valuable information on the technical feasibility and economic viability of GSHPs in comparison with traditional HVAC applications in twenty seven (27) cities of Ontario will provide a strong platform to the Ontario government to incentivize the geothermal heating and cooling industry.

This study will help to provide a good understanding of the financial and environmental benefits of GSHPs to the residential consumers, home builders, HVAC engineers/designers, policy makers, technology developers, and leading academic researchers.

4.4 Implications for Future Work and Recommendations

In this research project, a 2,000 square feet detached house above grade facility was designed for twenty seven (27) cities of Ontario to determine the technical and economic feasibility of ground source heat pump system (GSHPs) against tradition fossil fuel based HVAC applications for space heating, cooling and hot water usage. The future work should include multiple dwelling unit types such as single attached, bungalows, apartments, and town homes for diversified analysis of GSHPs.

R-2000 standards for construction designing should be included in the upcoming research work on top of comparing average construction design with improved construction design. Every R-2000 home is built to the stringent R-2000 Standard developed by Natural Resources Canada (NRCan) in coordination with key industry stakeholders. R-2000-certified new homes are best-in-class energy-efficient homes that include high levels of insulation, clean air features and measures to help protect the environment (NRCan, 2016c). Home building technology is continuously changing and improving through research and development. As the best-in-class energy efficiency label for 30 years, R-2000 continues to set the standard for leading-edge, energy-efficient new home construction (NRCan, 2016c). The updated R-2000 Standard came into effect in July 2012. Homes built to this new Standard will meet energy efficiency requirements that have been increased by 50 percent compared with the previous version of the standard (NRCan, 2016c).

According to the International Institute for Energy Conservation (IIEC), the R-2000 program was initiated by Energy, Mines and Resources (EMR) in 1981 with the goal of affecting the construction of energy-efficient homes in Canada by establishing a new energy performance standard, training builders to construct houses to that standard, and stimulating the demand for such homes (IIEC, 2017). With new incentives that will emerge from the Ontario Climate Change Action Plan, it is expected that a larger share of new homes will be built to R-2000 standards.

In addition, customized designs of different loop circuit types and trenching and borehole configuration arrangements in coordination with various rock/soil varieties should be considered in the technical assessment to study their impact on the financial output (life cycle cost) for the residential consumers of Ontario.

One of the next steps would also to consider different scenarios in terms of incentives and carbon taxes models to determine an ideal timeframe to reach greenhouse gas (GHG) targets by accelerating the deployment of GSHPs in the residential sector of Ontario.

The future research work should also consist of a comparison of the financial and technical evaluation between ground source heat pump (GSHP) and air source heat pump (ASHP) systems. Air-source heat pumps use the difference between outdoor air temperatures and indoor air temperatures to cool and heat your home. Many homes in moderate climates can rely on these products to heat or cool their homes year-round; however, in colder climates a supplementary heating source is usually needed (NRCan, 2017e). The evaluation of ASHPs against GSHPs would provide a sound basis for investment in specific cases. Use of either ASHPs or GSHPs will help reduce the carbon footprint of home heating and cooling needs. ASHP systems can play a significant role in Ontario's low carbon future.

References

- Abdelalim, A., O'Brien, W., & Shi, Z. (2017). Development of Sankey diagrams to visualize real HVAC performance. *Energy and Buildings*, 149, 282 – 297.
- Acchione, P. (2016). Personal Communication. HVAC systems educator/installer/contractor. [Position Title: General Manager]. Priority Mechanical Services Ltd. <http://prioritymechanical.ca/>
- Adobe Stock. (2017a). Ceiling air ventilation and air conditioning diagram. https://stock.adobe.com/ca/search?k=72835437&show_images=1&filters%5Bcontent_type%3Avideo%5D=1&filters%5Bcontent_type%3Atemplate%5D=1&filters%5Bcontent_type%3A3d%5D=1&color=&safe_search=0&safe_search=1&native_visual_search=&similar_content_id= (Purchased Image); Image #: 72835437
- Adobe Stock. (2017b). Old and dirty gas furnace. <https://stock.adobe.com/ca/stock-photo/old-and-dirty-gas-furnace/4797398> (Purchased Image); Image #: 4797398
- Allaerts, K., Coomans, M., & Salenbien, R. (2015). Hybrid ground-source heat pump system with active air source regeneration. *Energy Conversion and Management*, 90, 230 – 237.
- Ally, M., Munk, J., Baxter, V., & Gehl, A. (2015). Data, exergy, and energy analyses of a vertical-bore, ground-source heat pump for domestic water heating under simulated occupancy conditions. *Applied Thermal Engineering*, 89, 192 – 203.
- Andrachuk, M. and Smit, B. (2012): Community-based vulnerability assessment of Tuktoyaktuk, NWT, Canada to environmental and socio-economic changes; Regional Environmental Change, p. 1-19.
- Arat, H., & Arslan, O. (2017). Exergoeconomic analysis of district heating system boosted by the geothermal heat pump. *Energy*, 119, 1159 – 1170.
- Aste, N., Adhikari, R., & Manfren, M. (2013). Cost optimal analysis of heat pump technology adoption in residential reference buildings. *Renewable Energy*, 60, 615 – 624.
- Autodesk. (2015). Radiant heating and cooling. <https://sustainabilityworkshop.autodesk.com/buildings/radiant-heating-and-cooling>
- Badescu, V. (2006). Economic aspects of using ground thermal energy for passive house heating. *Renewable Energy*, 32, 895 – 903.

- Bakirci, K. (2010). Evaluation of the performance of a ground source heat pump system with series GHE (ground heat exchanger) in the cold climate region. *Energy*, 35, 3088 – 3096.
- Ball, A., Neuman, E., & Splinter, N. (2011). Analyzing the Economic Feasibility of Installing a Geothermal Heating and Cooling System for West Campus. Department of Chemical Engineering. Queen's University.
http://www.queensu.ca/sustainability/sites/webpublish.queensu.ca.suswww/files/files/TEAM_Geothermal_Final_Report.pdf
- Banks, D. (2012). An introduction to thermogeology: Ground source heating and cooling. USA: John Wiley & Sons, Ltd.
- Bazkiael, A., Niri, E., Kolahdouz, E., Weber, A., & Dargush, G. (2013). A passive design strategy for a horizontal ground source heat pump pipe operation optimization with a non – homogenous soil profile. *Energy and Buildings*, 61, 39 – 50.
- Bell, A. (2007). HVAC: Equations, Data, and Rules of Thumb. U.S.A. McGraw-Hill, 2nd Edition. <https://hvacvn.com/wp-content/uploads/2015/10/Hvac-Equations-Data-Rules-Of-Thumb.pdf>
- Benli, H. (2011). Energetic performance analysis of a ground – source heat pump system with latent heat storage for a greenhouse heating. *Energy Conversion and Management*, 52, 581 – 589.
- Boulton, K., Loughheed, M., Ford, J., Nickels, S., and Shirley, J. (2011): What we know, don't know and need to know about climate change in Inuit Nunangat: A systematic literature review and gap analysis of the Canadian Arctic.
- Brand, L., & Rose, W. (2012). Measure Guideline: High Efficiency Natural Gas Furnace. U.S. Department of Energy (DOE). National Renewable Energy Laboratory (NREL).
<http://www.nrel.gov/docs/fy13osti/55493.pdf>
- Burdick, A. (2011). Strategy guideline: Accurate heating and cooling load calculations. National Renewable Energy Laboratory. U.S Department of Energy (DOE).
<http://www.nrel.gov/docs/fy11osti/51603.pdf>
- Burdick, A. (2012). Strategy Guideline: HVAC Equipment Sizing. U.S Department of Energy (DOE). Building Technologies Program. <http://www.nrel.gov/docs/fy12osti/52991.pdf>

- Bush, C. (2010). Fundamentals of Psychrometry. Active Rain.
<http://activerain.com/blogsview/1498325/fundamentals-of-psychrometry>
- Byers, T., Dorf, R., & Nelson, A. (2009). Technology Ventures: From Idea to Enterprise. U.S.A. McGraw-Hill Science/Engineering/Math; 3rd Edition
- CGC. (2009). A buyer's guide for residential ground source heat pump systems. Canadian Geoexchange coalition (CGC). http://www.geo-exchange.ca/en/UserAttachments/article58_Residential_Geothermal_Buyers_Guide_2009.pdf
- CGC. (2010). The state of the Canadian geothermal heat pump industry 2010 – Industry survey and market analysis. Canadian Geoexchange Coalition (CGC). http://www.geo-exchange.ca/en/UserAttachments/article64_Industry%20Survey%202010_FINAL_E.pdf
- Chitwood, R., & Harriman, L. (2010). Measured Home Performance: A Guide to Best Practices for Home Energy Retrofits in California. California Energy Commission. Sacramento California.
- Cho, H., & Choi, J. (2013). The quantitative evaluation of design parameter's effects on a ground source heat pump system. Renewable Energy, 1 – 5.
- Choi, S., & Eastman, J. (1995). Enhancing thermal conductivity of fluids with nanoparticles. Energy Technology Division and Materials Science Division. Argonne National Laboratory.
http://www.iaea.org/inis/collection/NCLCollectionStore/_Public/27/043/27043758.pdf?origorigin=publication_detail
- Chua, K., Chou, S., & Yang, W. (2010). Advances in heat pump systems: A review. Applied Energy, (87) 12, 3611 – 3624.
- Chung, J., & Choi, J. (2012). Design and performance study of the ground – coupled heat pump system with an operating parameter. Renewable Energy, 42, 118 – 124.
- CMHC. (2014). Setback thermostats. Canadian Mortgage and Housing Corporation (CMHC).
http://www.cmhc-schl.gc.ca/en/co/grho/grho_002.cfm
- Downing, A. and Cuerrier, A. (2011): A synthesis of the impacts of climate change on the First Nations and Inuit of Canada; Indian Journal of Traditional Knowledge, v. 10, no. 1, p. 57-70.

- Dusseault, M. (2017). Personal Communication. Carbon Emissions from Natural Gas. Position Title: Professor, Department of Earth and Environmental Sciences. University of Waterloo. <https://uwaterloo.ca/earth-environmental-sciences/people-profiles/maurice-b-dusseault>
- Dyro, J. (2004). Clinical Engineering Handbook. U.S.A and U.K: Elsevier Academic Press. [https://books.google.ca/books?id=ElQhW2VMC&pg=PA517&lpg=PA517&dq=asure+of+the+air+volume+added+to+or+removed+from+a+space+\(normally+a+room+or+house\)+divided+by+the+volume+of+the+space&source=bl&ots=cV763JZDQ4&sig=aLFSpQKuXR1bBtvDZMARYiBMo&hl=en&sa=X&ved=0ahUKEWjj1_qehYTUAhUX8YMKHdNIB2oQ6AEITzAI#v=onepage&q=air%20changes%20per%20hour&f=false](https://books.google.ca/books?id=ElQhW2VMC&pg=PA517&lpg=PA517&dq=asure+of+the+air+volume+added+to+or+removed+from+a+space+(normally+a+room+or+house)+divided+by+the+volume+of+the+space&source=bl&ots=cV763JZDQ4&sig=aLFSpQKuXR1bBtvDZMARYiBMo&hl=en&sa=X&ved=0ahUKEWjj1_qehYTUAhUX8YMKHdNIB2oQ6AEITzAI#v=onepage&q=air%20changes%20per%20hour&f=false)
- Economy | Mortgage 101. (2010). What Is Time Value Of Money? A Dawn Journal. <http://adawnjournal.com/economy-mortgage-101/what-is-time-value-of-money>
- Egg, J., & Howard, B. (2011). Geothermal HVAC: Green heating and cooling. USA: The McGraw Hill Companies.
- Environment Canada. (2012). Annual 2011 Summary, Climate Trends and Variability Report. <http://ec.gc.ca/adsc-cmda/default.asp?lang=En&n=4A21B114-1>
- Environment Canada. (2011): Annual 2011 Summary, Climate Trends and Variability Report, online, <http://ec.gc.ca/adsc-cmda/default.asp?lang=En&n=F3D25729-1>
- Environment Canada. (2013). Canada's Emissions Trends. https://www.ec.gc.ca/ges-ghg/985F05FB-4744-4269-8C1A-D443F8A86814/1001-Canada's%20Emissions%20Trends%202013_e.pdf
- Environment Canada. (2014). Canada's Emissions Trends. http://ec.gc.ca/Publications/E998D465-B89F-4E0F-8327-01D5B0D66885/ETR_E-2014.pdf
- Environment and Climate Change Canada. (2016a). Greenhouse Gas Emissions. <https://www.ec.gc.ca/indicateurs-indicators/?lang=en&n=FBF8455E-1>
- Environment and Climate Change Canada. (2016b). Greenhouse Gas Emissions by Economic Sector. <https://www.ec.gc.ca/indicateurs-indicators/default.asp?lang=en&n=F60DB708-1>

- Environment and Climate Change Canada. (2016c). Greenhouse Gas Emissions by Province and Territory. <https://www.ec.gc.ca/indicateurs-indicators/default.asp?lang=en&n=18F3BB9C-1>
- Environment and Climate Change Canada. (2017a). Canada's Greenhouse Gas Inventory. <http://www.ec.gc.ca/ges-ghg/default.asp?lang=En&n=83A34A7A-1%20%20>
- Environment and Climate Change Canada. (2017b). Canada's 2016 greenhouse gas emissions Reference Case. <https://www.ec.gc.ca/ges-ghg/default.asp?lang=En&n=1F24D9EE-1&offset=3&toc=show>
- EPRI. (1989). Soil and rock classification for the design of ground – coupled heat pump systems. Field Manual. Cu – 6600. Electric Power Research Institute (EPRI). <http://www.epri.com/abstracts/Pages/ProductAbstract.aspx?ProductId=CU-6600%20%20%20%20%20%20%20%20%20%20%20%20&Mode=download>
- Feuvre, P. (2007). An Investigation into Ground Source Heat Pump Technology, its UK Market and Best Practice in System Design. MSc thesis. [Supervisor: Dr. Michael Kummert]. *University of Strathclyde*. http://www.esru.strath.ac.uk/Documents/MSc_2007/Le_Feuvre.pdf
- Florides, G., & Kalogirou, S. (2007). Ground heat exchangers – A review of systems, models and applications. *Renew Energy*, 32 (15), 2461 – 2478.
- Ford, J. D. (2009): Dangerous climate change and the importance of adaptation for the Arctic's Inuit population; *Environmental Research Letters*, v. 4, no. 2.
- Ford, J. D., Pearce, T., Duerden, F., Furgal, C., and Smit, B. (2010b): Climate change policy responses for Canada's Inuit population: the importance of and opportunities for adaptation; *Global Environmental Change*, v. 20, no. 1, p. 177-191.
- Fredin, P. (2009). Ground source heat pumps v/s conventional HVAC: A comparison of economic and environmental costs. *Biblioscholar dissertations*. Department of the air force: Air University. Air force institute of Technology.
- Garber, D., Choudhary, R., & Soga, K. (2013). Risk based lifetime costs assessment of a ground source heat pump (GSHP) system design: Methodology and case study. *Building and Environment*, 60, 66 – 80.
- GeoSmart Design Studio. (2016). Manual. <http://www.arboroaks.com/GeoSmartDS/Index.htm>

- GeoSmart Energy Inc. (2016). Geothermal Heating and Cooling: Variable Capacity Geothermal System. <https://geosmartenergy.com/wp-content/uploads/2016/01/PremiumVBrochure.pdf>
- Government of Canada. (2016). Annex II: Provincial and territorial key actions and collaboration opportunities with the Government of Canada. <https://www.canada.ca/en/services/environment/weather/climatechange/pan-canadian-framework/annex-key-actions-collaboration.html#on>
- Government of Canada. (2017). The Pan-Canadian Framework on Clean Growth and Climate Change: Canada's plan to address climate change and grow the economy. Government of Canada. <https://www.canada.ca/en/services/environment/weather/climatechange/pan-canadian-framework.html>; <https://www.canada.ca/content/dam/themes/environment/documents/weather1/20170125-en.pdf>
- Government of Canada. (2014). Canada's sixth national report on climate change. https://ec.gc.ca/cc/16153A64-BDA4-4DBB-A514-B159C5149B55/6458_EC_ID1180-MainBook_high_min%20FINAL-s.pdf
- Grasby, S.E., Allen, D.M., Bell, S., Chen, Z., Ferguson, G., Jessop, A., Kelman, M., Ko, M., Majorowicz, J., Moore, M., Raymond, J., & Therrien, R. (2012). Geothermal Energy Resource Potential of Canada, *Geological Survey of Canada*, Open File 6914 (revised), 322 p. doi: 10.4095/291488. Natural Resources Canada.
- Grundfos. (2017). COP (Coefficient of Performance). <http://www.grundfos.com/service-support/encyclopedia-search/cop-coefficient-of-performance.html>
- Hanova, J., Dowlatabadi, H., & Mueller, L. (2007). Ground Source Heat Pump Systems in Canada. Resources for the Future. http://www.green-erg.com/documents/Canada_GSHP.pdf
- Hartmann, D.L., Klein Tank, A.G., and Rusticucci, M. (2013): Chapter 2: Observations: Atmosphere and Surface – Final Draft Underlying Scientific-Technical Assessment; in Climate Change 2013: The Physical Science Basis. Contribution of Working Group I to the Fifth Assessment Report of the Intergovernmental Panel on Climate Change, (ed.) T.F. Stocker, D. Qin, G.-K. Plattner, M. Tignor, S. K. Allen, J. Boschung, A. Nauels, Y. Xia, V. Bex and P.M. Midgley, Cambridge University Press, Cambridge, United Kingdom and New York, NY, USA.

- Henrich, D. (2016). Personal Communication. HVAC systems educator/installer/contractor. [Position Title: Vice President]. Thermal Dynamics, Inc. <http://www.groundloopdesign.com/>
- Hepbasli, A., Akdemir, O., & Hancioglu, E. (2003). Experimental study of a closed loop vertical ground source heat pump system. *Energy Conversion and Management*, 44 (4), 527 – 548.
- Hepbasli, A. (2005). Thermodynamic analysis of a ground-source heat pump system for district heating. *International Journal of Energy Research*, 29, 671 – 687.
- Hermes, D.A. (2004). Using degree-days and plant phenology to predict pest activity. In: V. Krischik and J. Davidson, eds. IPM (Integrated Pest Management) of Midwest Landscapes, pp. 49- 59. Minnesota Agricultural Experiment Station Publication 58-07645, 316 pp. <http://cues.cfans.umn.edu/old/Web/049DegreeDays.pdf>
- Hillesheim, M., and Mosey, G. (2014). Technical Feasibility Study for Deployment of Ground-Source Heat Pump Systems: Portsmouth Naval Shipyard— Kittery, Maine. National Renewable Energy Laboratory (NREL). <http://www.nrel.gov/docs/fy15osti/62353.pdf>
- IIEC. (2017). Energy, Mines and Resources Canada, R-2000 (residential-new construction), Profile #26. <http://www.iiec.org/2015-11-12-07-41-32/results-center/profiles-by-number?id=360>
- IPCC. (2013). Summary for Policymakers; in *Climate Change 2013: The Physical Science Basis. Contribution of Working Group I to the Fifth Assessment Report of the Intergovernmental Panel on Climate Change*, (ed.) T.F. Stocker, D. Qin, G.-K. Plattner, M. Tignor, S. K. Allen, J. Boschung, Nauels, A., Xia, Y. Bex, V., P.M. Midgley, Casati, B. and Yagouti, A. (2010): Analysis of extreme temperature indices in nine Canadian communities using the Canadian Regional Climate Model projections for public health planning; Ouranos. Cambridge University Press, Cambridge, United Kingdom and New York, NY, USA.
- Kalinci, Y., & Hepbasli, A. (2009). A review of heat pump water heating systems. *Renewable and Sustainable Energy Reviews*, 13, 1211 – 1229.
- Kegel, M., Tamasauskas, J., Sunye, R., & Giguere, D. (2014). Techno-Economic Analysis of Heat Pump and Cogeneration Systems for a High Performance Midrise Apartment in the Canadian Climate. <http://docs.lib.purdue.edu/cgi/viewcontent.cgi?article=1163&context=ihpbc>

- Kensa Heat Pumps. (2017). The technology: How ground source heat pump work?
<https://www.kensaheatpumps.com/the-technology/how-gshp-works/>
- Kimia, D. (2017). Personal Communication. HVAC systems educator/installer/contractor.
[Position Title: Chief Operating Officer]. Air Makers Inc. <https://www.airmakers.ca/>
- Lemelin, H., Matthews, D., Mattina, C., McIntyre, N., Johnston, M., Koster, R., and Weenusk
First Nation at Peawanuck (2010): Climate change, wellbeing and resilience in the
Weenusk First Nation at Peawanuck: the Moccasin Telegraph goes global; Rural and
Remote Health, v. 10, no. 2, p. 1333.
- Lamin, L. (2011). Usability of thermostat controls – an example of the UCL Energy Institute.
Proceedings of Conference: People and Buildings.
http://www.healthyheating.com/downloads/Thermostats/MC2011_MC33.pdf
- Lennox. (2017). Lennox News Room. <http://www.lennoxcommercial.com/news/2007/hvac-equipment-optimal-humidity-control/>
- Leong, W., Tarnawski, V., & Aittomaki, A. (1998). Effect of soil type and moisture content on
ground heat pump performance. International Journal of Refrigeration, 21 (8), 595 – 606.
- Majorowicz, J. and Grasby, S.E. (2010). Heat flow, depth-temperature variations and stored
thermal energy for enhanced geothermal systems in Canada. Journal of Geophysics and
Engineering, 7, 232-241.
- Man, Y., Yang, H., & Wang, J. (2010). Study on hybrid ground – coupled heat pump system for
air – conditioning in hot weather areas like Hong Kong. Applied Energy, 87 (9), 2826 –
2833.
- Marco, S. (2016). Personal Communication. Ground source heat pump
educator/installer/contractor. [Position Title: Chief Executive Officer (CEO)]. Geosmart
Energy Inc. <http://www.geosmartenergy.com/home/about-us/our-team.html>
- McClymont Peace, D. and Myers, E. (2012): Community-based participatory process - Climate
change and health adaptation program for Northern First Nations and Inuit in Canada;
International Journal of Circumpolar Health, no. 71, p. 18412.
- Miller, D., & Maynes, T. (2008). Feasibility of Ground Source Heat Pumps in Alberta. Climate
Change Central.
http://greenedmonton.ca/files/GSHP_DiscussionPaper_CCC_Alberta.pdf

- Mindlin, D. (2013). Present Values, Investment Returns and Discount Rates. CDI Advisors LLC. <http://www.cdiadvisors.com/papers/cdidiscountrate.pdf>
- Morse, B.W. and Zakrisson, M. (2010): The Impact on the Inuit of Environmental Degradation to the Canadian Arctic; *Common Law World Review*, v. 39, no. 1, p. 48-68.
- Murray, M. (2008). Using degree – days to time treatments for insect pests. Utah State University. <https://climate.usurf.usu.edu/includes/pestFactSheets/degree-days08.pdf>
- National Asthma Council Australia. (2016). Indoor Humidity Levels. Sensitive Choice. <http://www.sensitivechoice.com/indoor-humidity/>
- NEB. (2016). End - Use Prices. <https://apps.neb-one.gc.ca/frppndc/dflt.aspx?GoCTemplateCulture=en-CA>
- Nguyen, H., Law, Y., Zhou, Y., Walsh, P., Leong, W., & Dworkin, S. (2016). A techno-economic analysis of heat-pump entering fluid temperatures, and CO₂ emissions for hybrid ground-source heat pump systems. *Geothermics*, 61, 24 – 34.
- Nikzad, R., & Sedigh, G. (2017). Greenhouse gas emissions and green technologies in Canada. *Environmental Development* (In Press). <http://www.sciencedirect.com/science/article/pii/S2211464516302883>
- NRCan. (2004a). Heating and Cooling With a Heat Pump. Natural Resources Canada (NRCan). <http://www.nrcan.gc.ca/sites/oe.nrcan.gc.ca/files/pdf/publications/infosource/pub/home/heating-heat-pump/booklet.pdf>
- NRCan. (2004b). Air Conditioning Your Home. Natural Resources Canada (NRCan). <http://www.holmesheating.com/media/4881/oeairconditioningguide.pdf>
- NRCan. (2005). Ground source heat pump project analysis. RET Screen International. Clean Energy Decision Support Centre. Natural Resources Canada (NRCan).
- NRCan. (2012). Water Heater Guide. Natural Resources Canada (NRCan). http://www.nrcan.gc.ca/sites/oe.nrcan.gc.ca/files/files/pdf/equipment/WaterHeaterGuide_e.pdf
- NRCan. (2016a). HVAC & Energy Systems. Natural Resources Canada (NRCan). <https://www.nrcan.gc.ca/energy/efficiency/housing/research/3937>

- NRCan. (2016b). Gas furnaces – May 2016. Natural Resources Canada (NRCan). <http://www.nrcan.gc.ca/energy/regulations-codes-standards/18441>
- NRCan. (2016c). R-2000 Homes. <http://www.nrcan.gc.ca/energy/efficiency/housing/new-homes/5085>
- NRCan. (2017a). Residential Sector – Canada. Natural Resources Canada (NRCan). http://oee.nrcan.gc.ca/corporate/statistics/neud/dpa/menus/trends/comprehensive/trends_res_ca.cfm
- NRCan. (2017b). Ground-Source Heat Pumps (Earth-Energy Systems). Natural Resources Canada (NRCan). <http://www.nrcan.gc.ca/energy/publications/efficiency/heating-heat-pump/6833>
- NRCan. (2017c). What Is a Heat Pump and How Does It Work? Natural Resources Canada (NRCan). <http://www.nrcan.gc.ca/energy/publications/efficiency/heating-heat-pump/6827>
- NRCan. (2017d). Coming to Terms with Heat Pumps. Natural Resources Canada (NRCan). <http://www.nrcan.gc.ca/energy/publications/efficiency/heating-heat-pump/6829>
- NRCan. (2017e). Air-source heat pumps. <http://www.nrcan.gc.ca/energy/products/categories/heating/heat-pumps/air-source/16022>
- NREL. (2012). Thermostat Operation. NREL Building Research. National Renewable Energy Laboratory (NREL). https://buildingsfieldtest.nrel.gov/thermostat_operation
- NREL. (2014). Gas Furnaces. NREL Building Research. National Renewable Energy Laboratory (NREL). https://buildingsfieldtest.nrel.gov/gas_furnaces
- NREL. (2017). Better duct systems for home heating and cooling. National Renewable Energy Laboratory (NREL). U.S Department of Energy (DOE). <http://www.nrel.gov/docs/fy05osti/30506.pdf>
- Omer, A. (2008). Ground – source heat pump systems and applications. Renewable and Sustainable Energy Reviews, 12 (12), 344 – 371.
- Ontario. (2016). Climate Change Strategy. <https://www.ontario.ca/page/climate-change-strategy>

- Petit, P., & Meyer, J. (1997). A techno-economic analytical comparison of the performance of air-source and horizontal-ground-source air-conditioners in South Africa. *International Journal of Energy Research*, 21 (11), 1011 – 1021.
- Pigg, S. (2003). The Electric Side of Gas Furnaces. Toronto Hydro. https://www.torontohydro.com/sites/corporate/Newsroom/Documents/www.homeenergy.org_graphics_HomeEnergy_20-6_feature.pdf
- Rad, F., Fung, A., & Leong, W. (2013). Feasibility of combined solar thermal and ground source heat pump systems in cold climate, Canada. *Energy and Buildings*, 61, 224 – 232.
- Ratehub. (2017). Prime Mortgage Rate History. <https://www.ratehub.ca/prime-mortgage-rate-history>
- RESNET. (2011). Manual J – Heating and Cooling Load Calculation – An Introduction. Residential Energy Services Network. <http://www.resnet.us/blog/manual-j-heating-and-cooling-load-calculation/>
- Saari, A., Kalamees, T., Jokisalo, J., Michelsson, R., Alanne, K., & Kurnitski, J. (2012). Financial viability of energy – efficiency measures in a new detached house design in Finland. *Applied Energy*, 92, 76 – 83.
- Saylor. (2017). Refrigeration cycles. Lecture notes on thermodynamics. <https://www.saylor.org/site/wp-content/uploads/2013/08/BolesLectureNotesThermodynamicsChapter10.pdf>
- Shet, U., Sundararajan, T., & Mallikarjuna, J.M. (2013). Simple vapor compression refrigeration system. National Programme on Technology Enhanced Learning (NPTEL). http://www.nptel.iitm.ac.in/courses/IIT-MADRAS/Applied_Thermodynamics/Module_6/6_Simple_Vapor_Compression_RS.pdf
- Shutterstock. (2017a). Ventilation ducts made of galvanized sheet. <https://www.shutterstock.com/image-photo/ventilation-ducts-made-galvanized-sheet-384938695> (Purchased Image); Image #: 384938695
- Shutterstock. (2017b). Radiant underfloor heating, heating systems, warm floor, under floor heating systems, renewable energy home concept – 3D rendering. <https://www.shutterstock.com/image-illustration/radiant-underfloor-heating-systems-warm-floor-582091894> (Purchased Image); Image #: 582091894

- Sleeth, D. (2016). Personal Communication. HVAC Computer Systems Ltd. HVAC-Calc Residential 4.0 program. <http://www.hvaccalc.com/hvac/tofc2.asp>
- Smith, K. (2008). Understanding home heating systems. Suite 101. Home Renovation/Repair.
- Statistics Canada. (2012). Analysis. <http://www.statcan.gc.ca/pub/11-526-s/2010001/partie1-eng.htm>
- Statistics Canada. (2016). Population by year, by province and territory (Number). <http://www.statcan.gc.ca/tables-tableaux/sum-som/101/cst01/demo02a-eng.htm>
- Stephens, G. (2017). Difference between an 80 & 90 percent furnace. SFGATE. <http://homeguides.sfgate.com/difference-between-80-90-percent-furnace-89472.html>
- Sullivan, S. (1997). Monitored performance of residential geothermal heat pumps in Central Texas and Southern Michigan. Sandia National Laboratories.
- The American Standard Company. (2016). Outdoor Coil Condition. Built into the Manual of GeoSmart Design Studio. <http://www.arboroaks.com/GeoSmartDS/Index.htm>
- The Linde Group. (2017). Refrigerants Environmental Data. Ozone Depletion and Global Warming Potential. Linde Gases AG. http://www.linde-gas.com/internet.global.lindegas.global/en/images/Refrigerants%20environmental%20GWPs17_111483.pdf
- Thien, R. (2012). What's the Difference Between R-22 and R-410A? AC & Heating Connect. <http://www.ac-heatingconnect.com/whats-the-difference-between-r-22-and-r-410a/>
- Trane. (2016). Gas furnaces. <https://www.trane.com/residential/en/products/heating-and-cooling/gas-furnaces.html>
- U.S DOE. (2001). Ground source heat pumps applied to federal facilities. Federal Energy Management Program. <http://smartenergy.illinois.edu/pdf/Archive/GroundSourceHeatPumpApplication.pdf>
- U.S DOE. (2011). Guide to Geothermal Heat Pumps. U.S Department of Energy (DOE). https://energy.gov/sites/prod/files/guide_to_geothermal_heat_pumps.pdf
- U.S DOE. (2017a). Geothermal Heat Pumps. U.S Department of Energy (DOE). <https://energy.gov/energysaver/geothermal-heat-pumps>
- U.S DOE. (2017b). Room air conditioners. U.S Department of Energy (DOE). <https://energy.gov/energysaver/room-air-conditioners>

- U.S DOE. (2017c). Radiant Heating. U.S Department of Energy (DOE).
<https://energy.gov/energysaver/radiant-heating>
- U.S DOE. (2017d). Radiant Cooling. U.S Department of Energy (DOE).
<https://energy.gov/energysaver/radiant-cooling>
- Vandervort, D. (2016). How a gas furnace works? Hometips. <https://www.hometips.com/how-it-works/gas-furnace-diagram.html>
- Vincent, L. A., Wang, X. L., Milewska, E. J., Wan, H., Yang, F., and Swail, V. (2012): A second generation of homogenized Canadian monthly surface air temperature for climate trend analysis; *Journal of Geophysical Research*, v. 117, D18110.
- Warren, F.J. and Lemmen, D.S. (2014). Synthesis; in *Canada in a Changing Climate: Sector Perspectives on Impacts and Adaptation*, (ed.) F.J Warren and D.S Lemmen; Government of Canada, Ottawa, ON, p. 1 – 18.
http://www.nrcan.gc.ca/sites/www.nrcan.gc.ca/files/earthsciences/pdf/assess/2014/pdf/Full-Report_Eng.pdf
- WaterFurnace. (2016). Environol.
<http://www.waterfurnace.ca/Products/Accessories/environol.php>
- Wiesemann, W., & Rustem, D. (2010). Maximizing the net present value of a project under uncertainty. *European Journal of Operational Research*, 202 (2), 356 – 367.
- Ysasi, A., Telbis, A., & Kunen, E. (2014). Thermal properties (Chapter 17). *Ground Independent Study Projects (GISP)*. Brown University.
http://www.engin.brown.edu/organizations/EWB/GISP/Callster%20-%20chapter_17.pdf;
<http://www.engin.brown.edu/organizations/EWB/GISP/proposal.htm>;
<http://www.brown.edu/academics/college/degree/course-options/independent-study>
- Zhai, X., Qu, M., Yu, X., Yang, Y., & Wang, R. (2011). A review for the applications and integrated approaches of ground – coupled heat pump systems. *Renewable and Sustainable Energy Reviews*, 15 (6), 3133 – 3140.

Appendix A1 – Type of Residential Households and % Share in Ontario

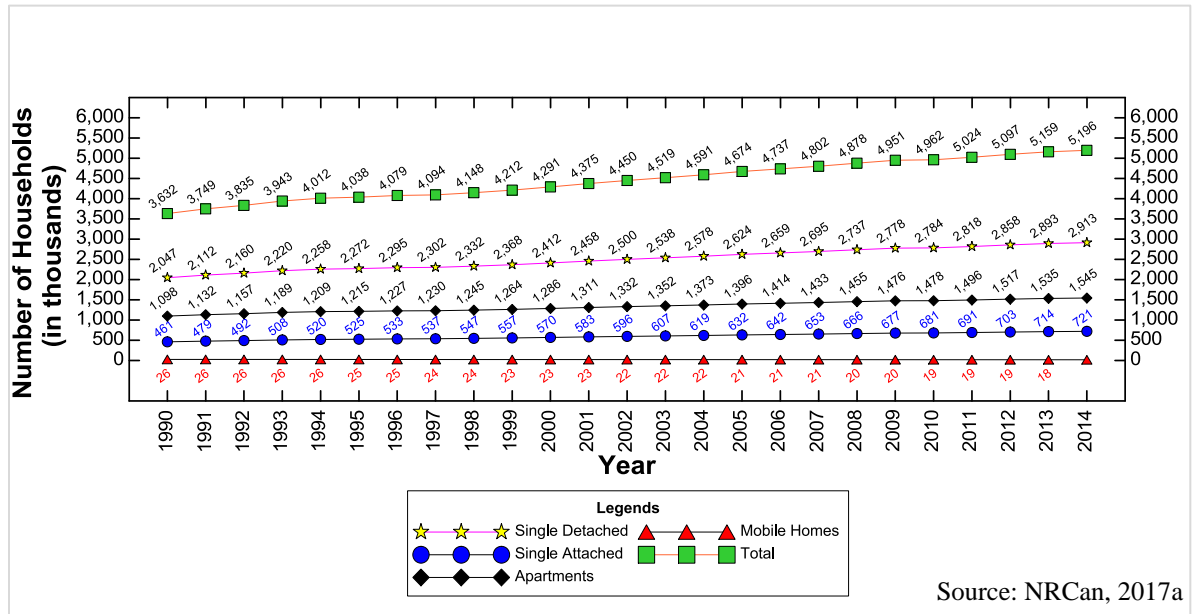

Figure A1-1.1: Number and Type of Residential Households in Ontario from 1990 to 2014

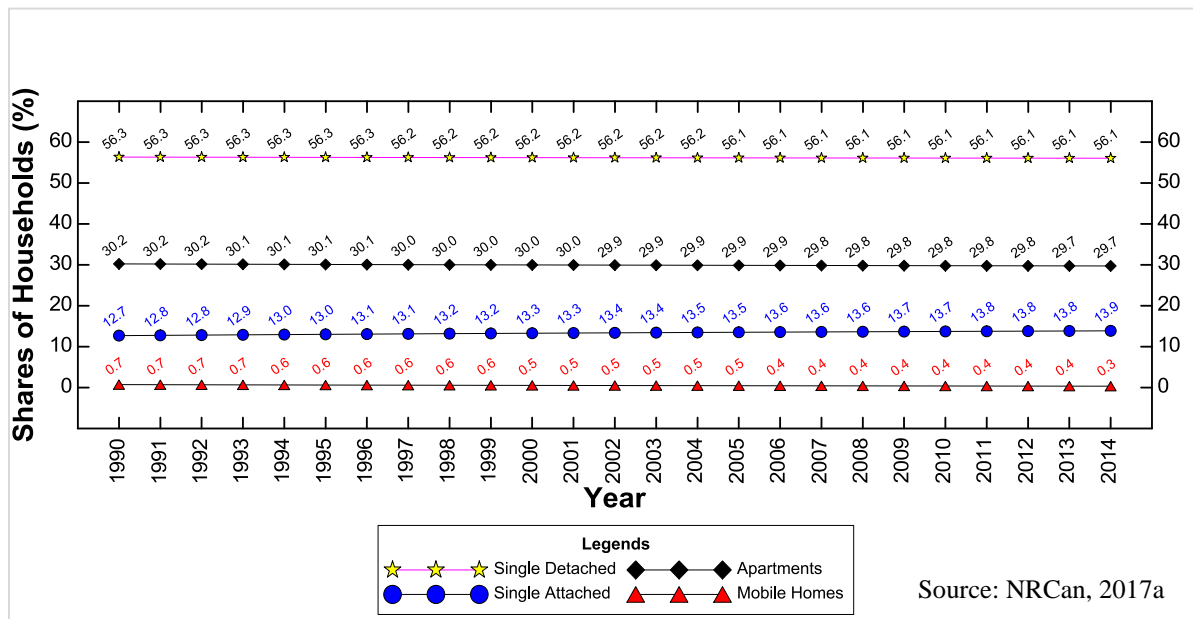

Figure A1-1.2: % Shares of Residential Households in Ontario from 1990 to 2014

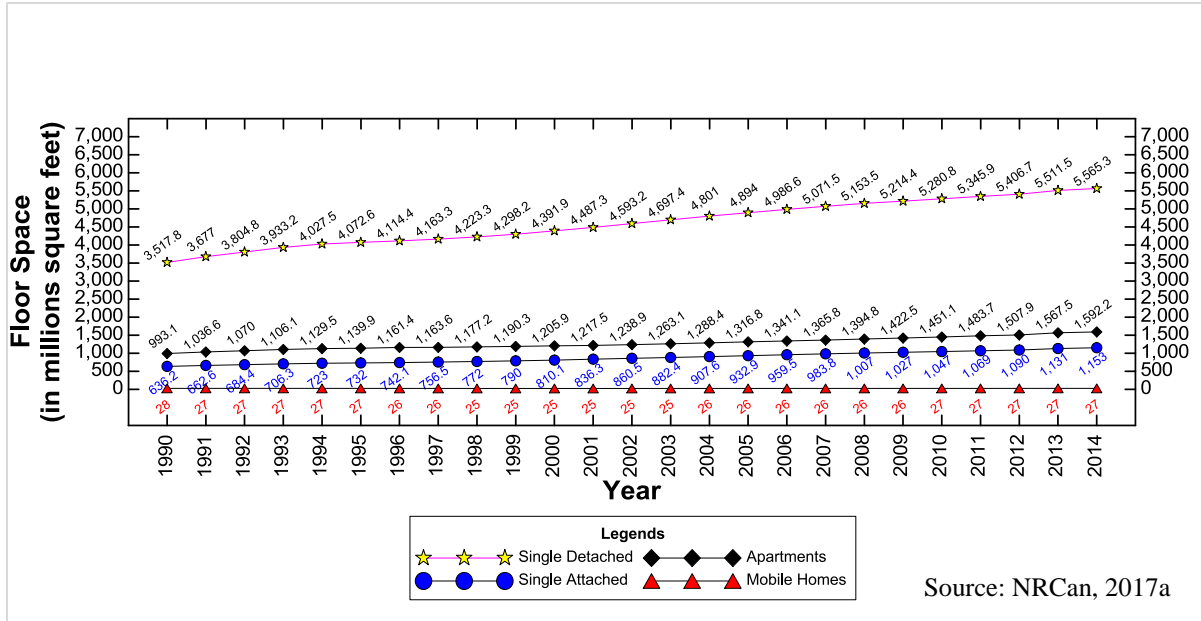

Figure A1-1.3: Cumulative Floor Space of Residential Households in Ontario from 1990 to 2014

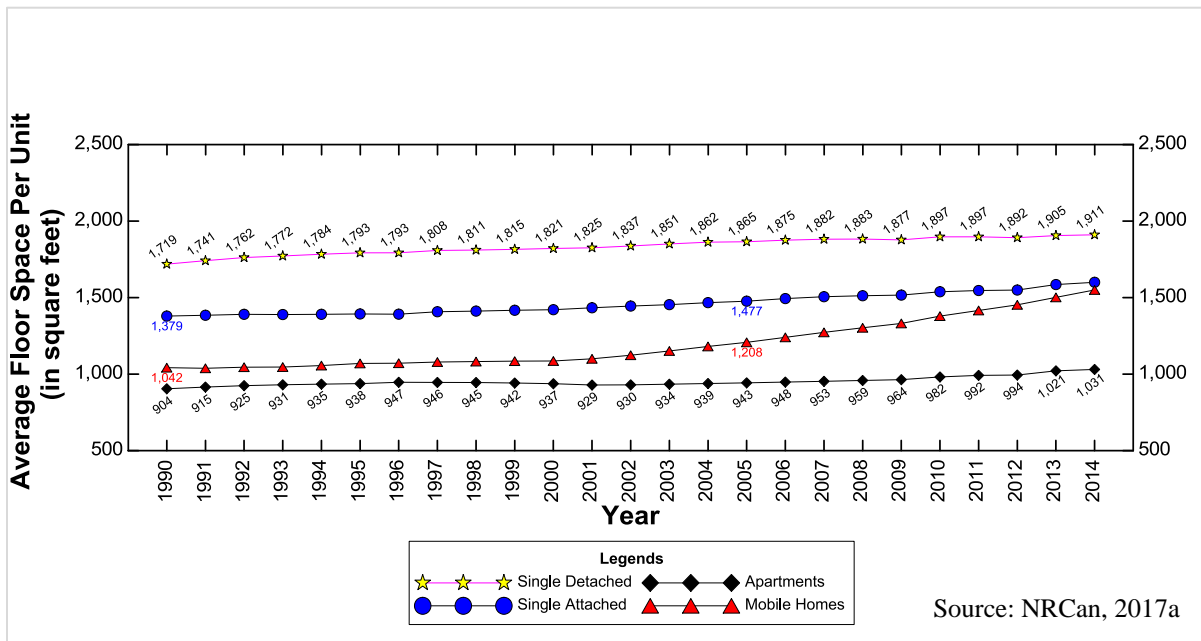

Figure A1-1.4: Average Floor Space of Residential Households in Ontario from 1990 to 2014

Appendix A2 – Total Energy Use by End-Use in the Residential Households of Ontario

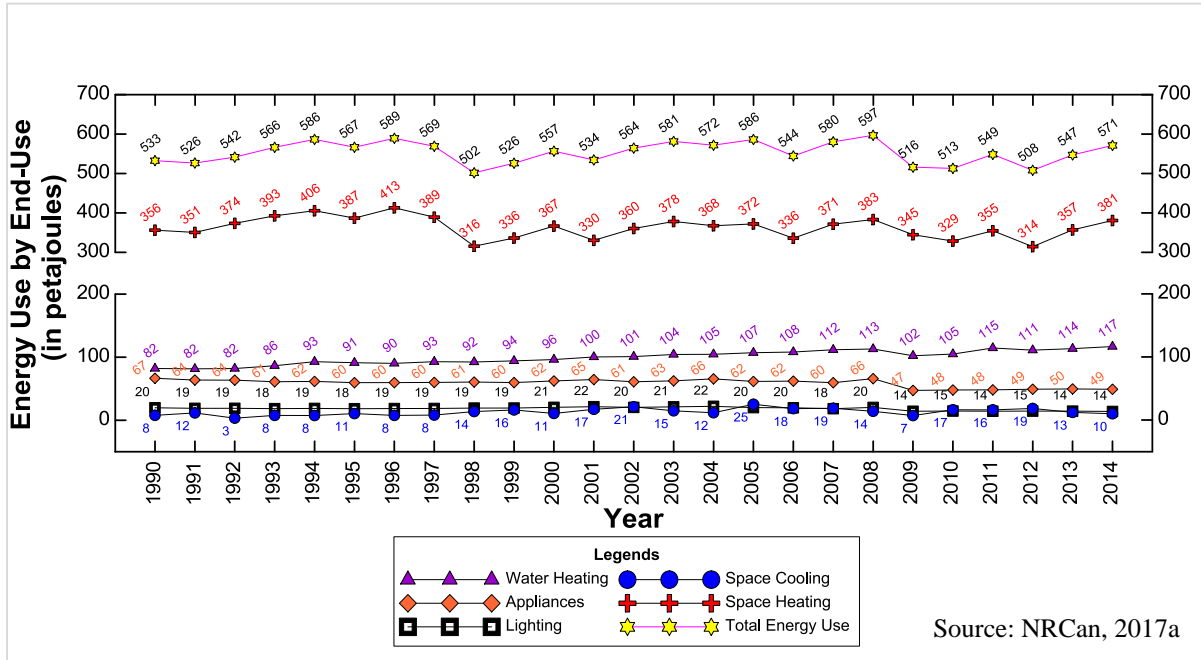

Figure A2-1.1: Total Energy Use by End-Use in the Residential Households of Ontario from 1990 to 2014

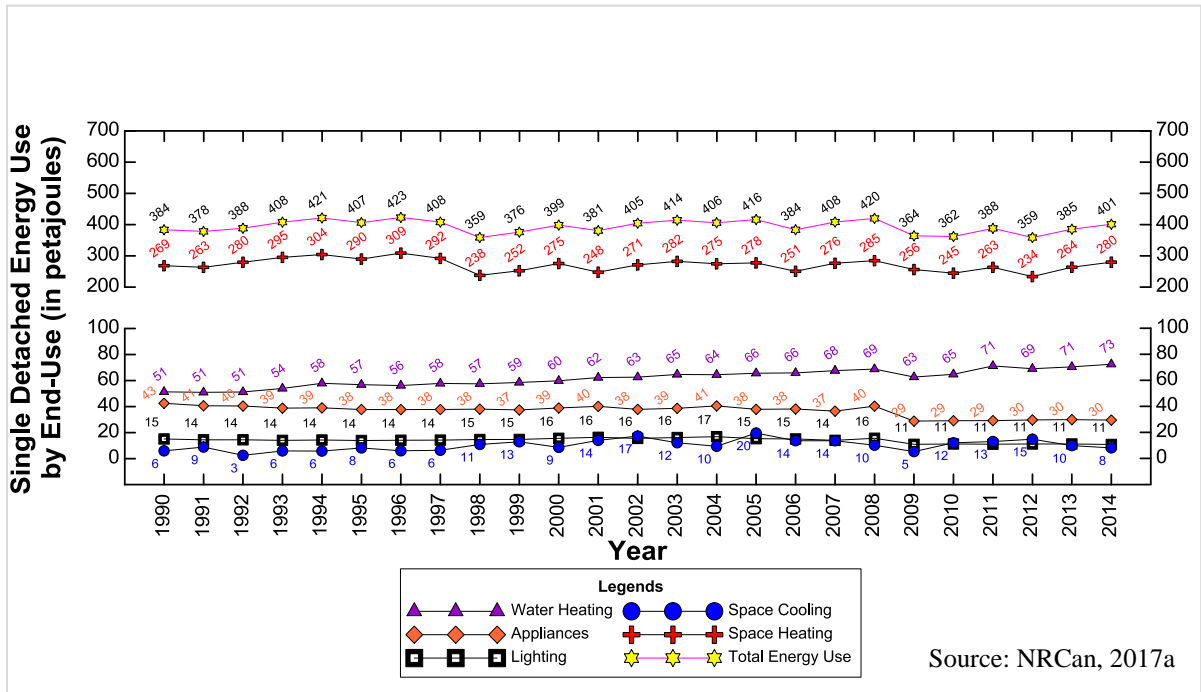

Figure A2-1.2: Total Single Detached Energy Use by End-Use in Ontario from 1990 to 2014

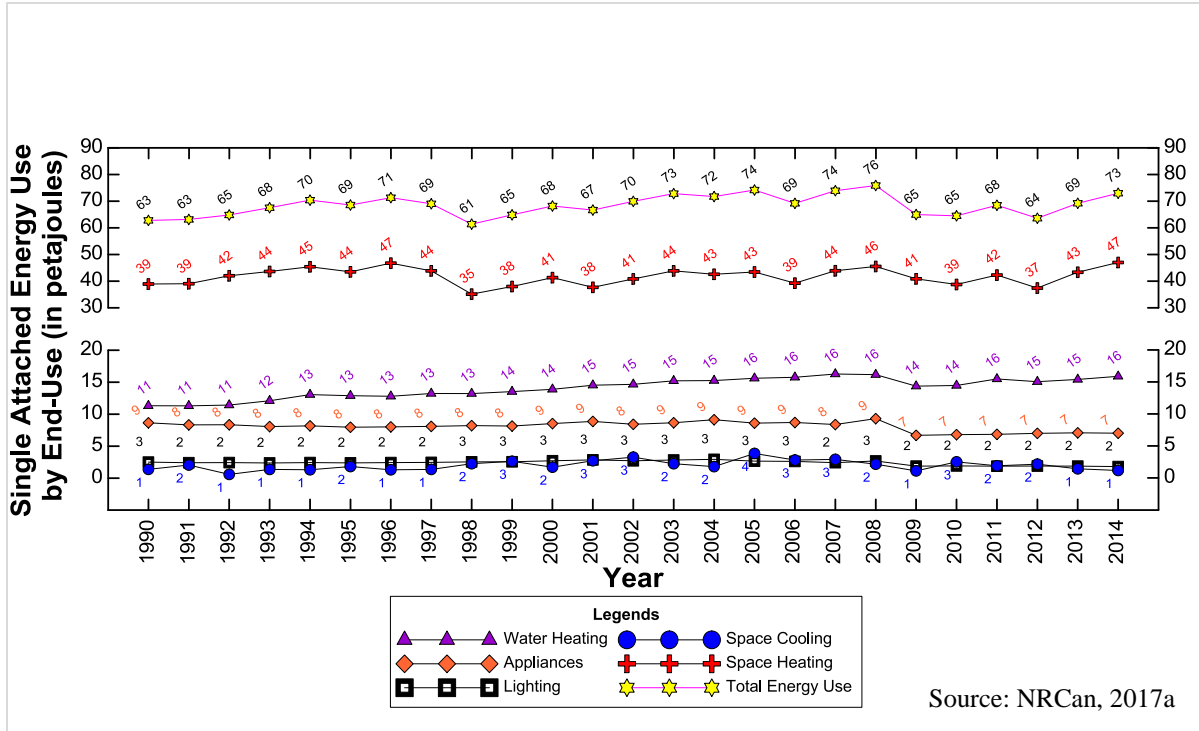

Figure A2-1.3: Total Single Attached Energy Use by End-Use in Ontario from 1990 to 2014

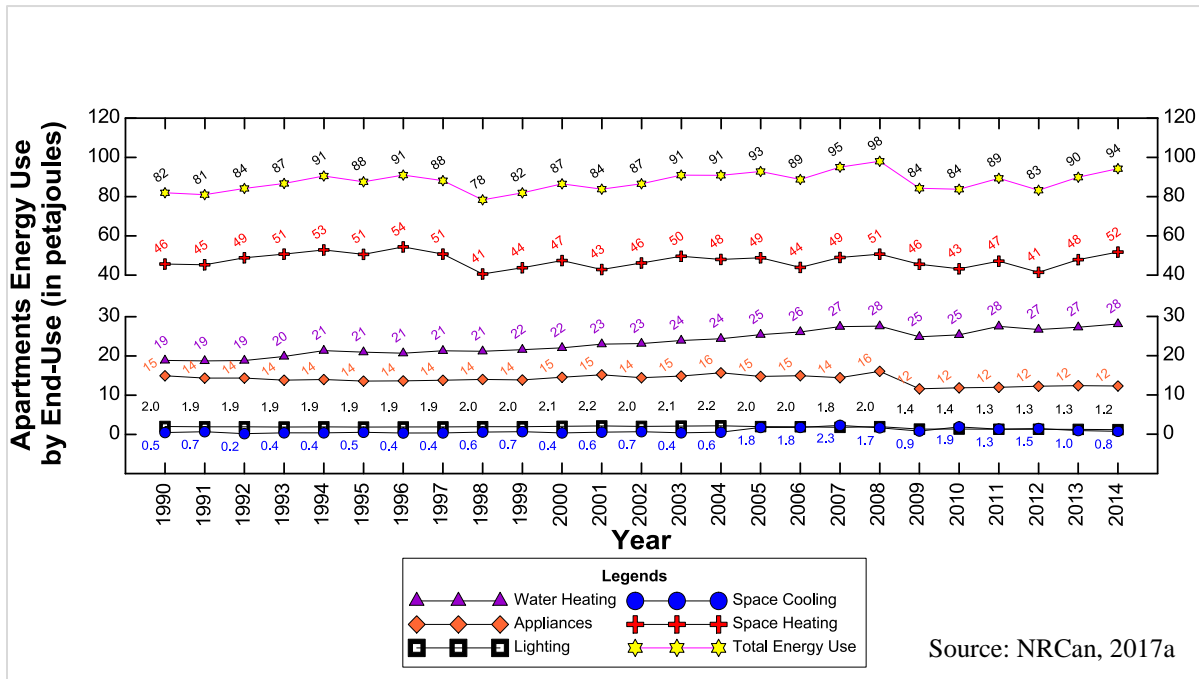
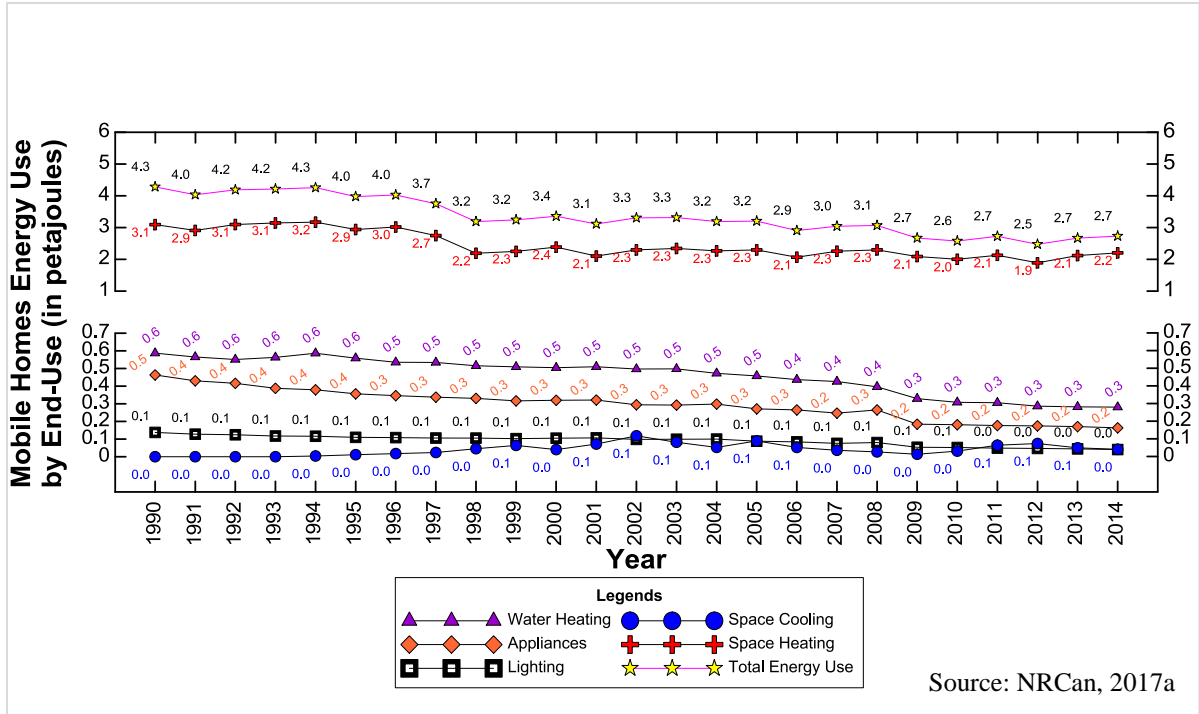

Figure A2-1.4: Total Apartments Energy Use by End-Use in Ontario from 1990 to 2014



Source: NRCan, 2017a

Figure A2-1.5: Total Mobile Homes Energy Use by End-Use in Ontario from 1990 to 2014

Appendix A3 – Total Energy Use by Energy Source in the Residential Households of Ontario

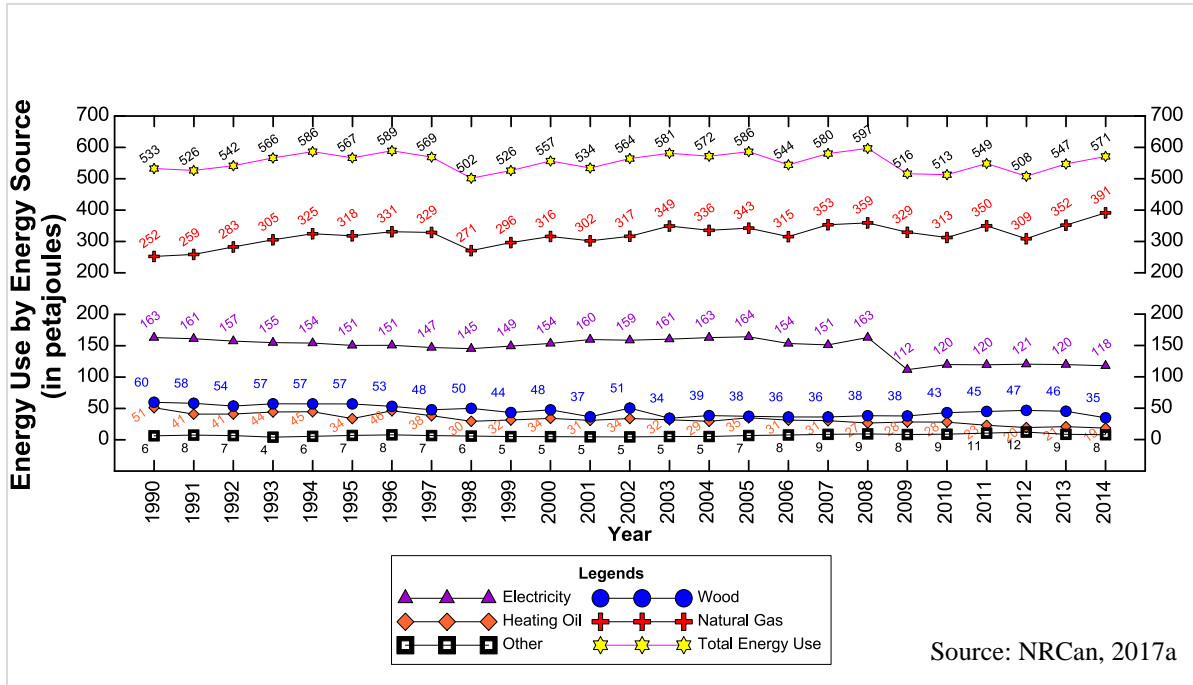

Figure A3-1.1: Total Energy Use by Energy Source in the Residential Households of Ontario from 1990 to 2014

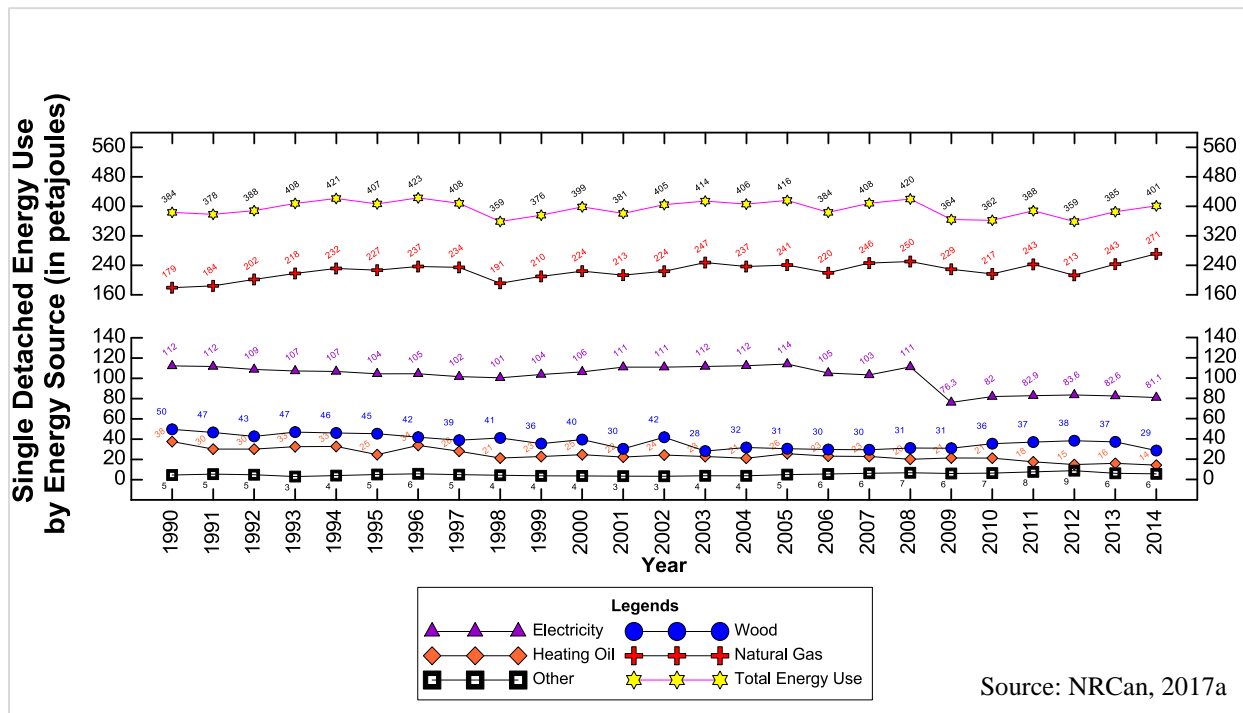

Figure A3-1.2: Total Single Detached Energy Use by Energy Source in Ontario from 1990 to 2014

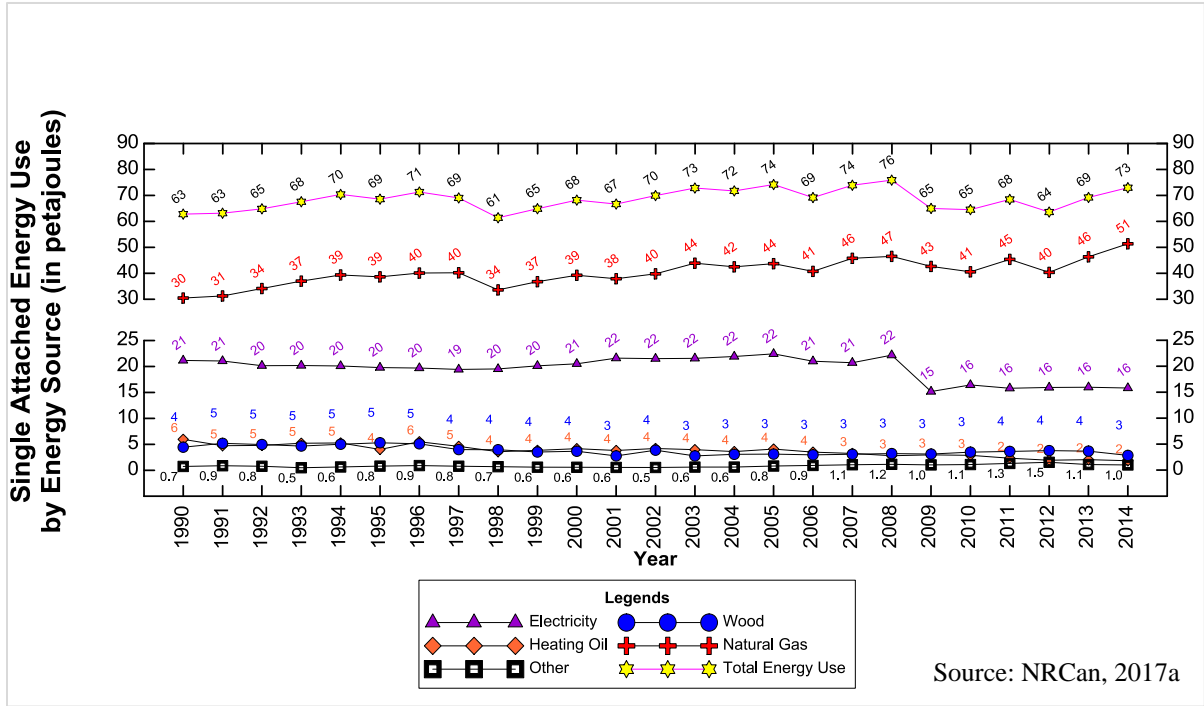

Figure A3-1.3: Total Single Attached Energy Use by Energy Source in Ontario from 1990 to 2014

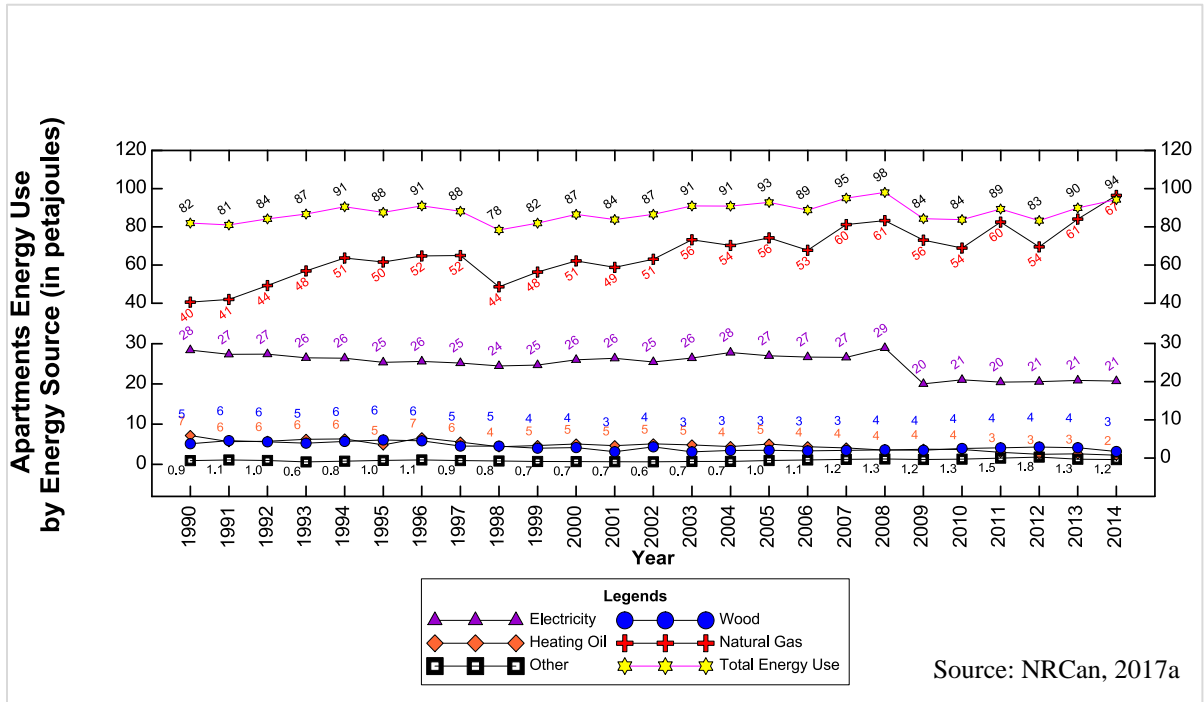
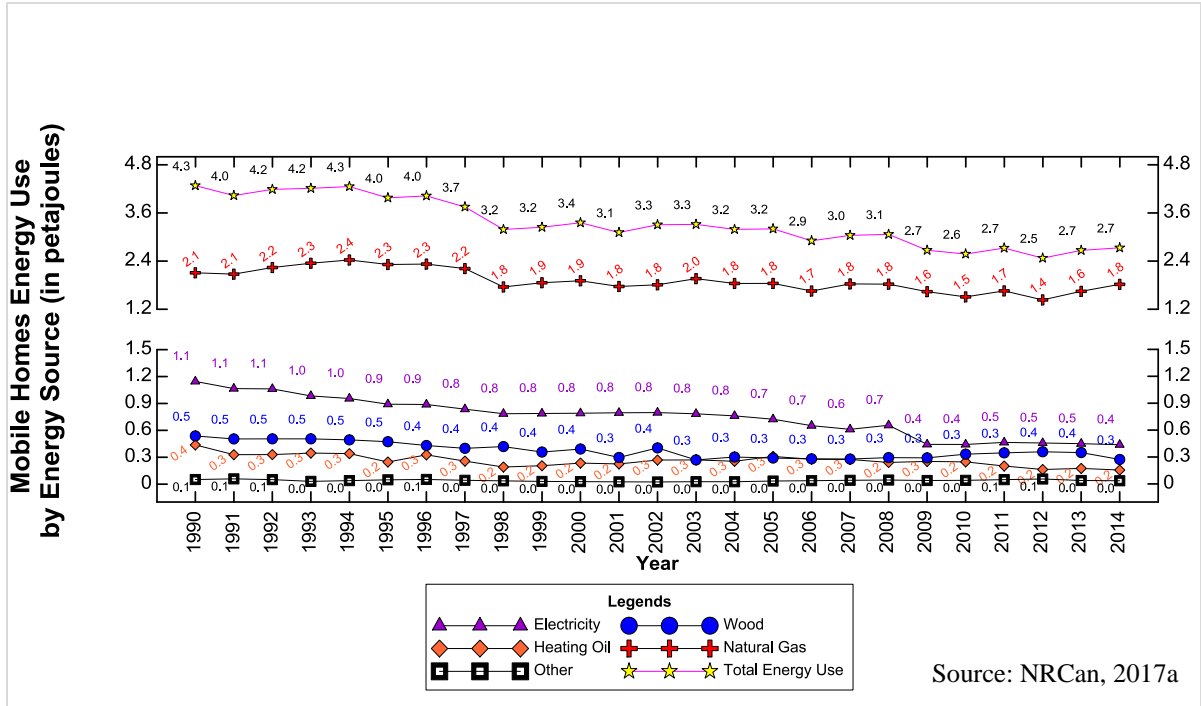

Figure A3-1.4: Total Apartments Energy Use by Energy Source in Ontario from 1990 to 2014



Source: NRCan, 2017a

Figure A3-1.5: Total Mobile Homes Energy Use by Energy Source in Ontario from 1990 to 2014

Appendix A4 – Total Energy Use by System Type in the Residential Households of Ontario

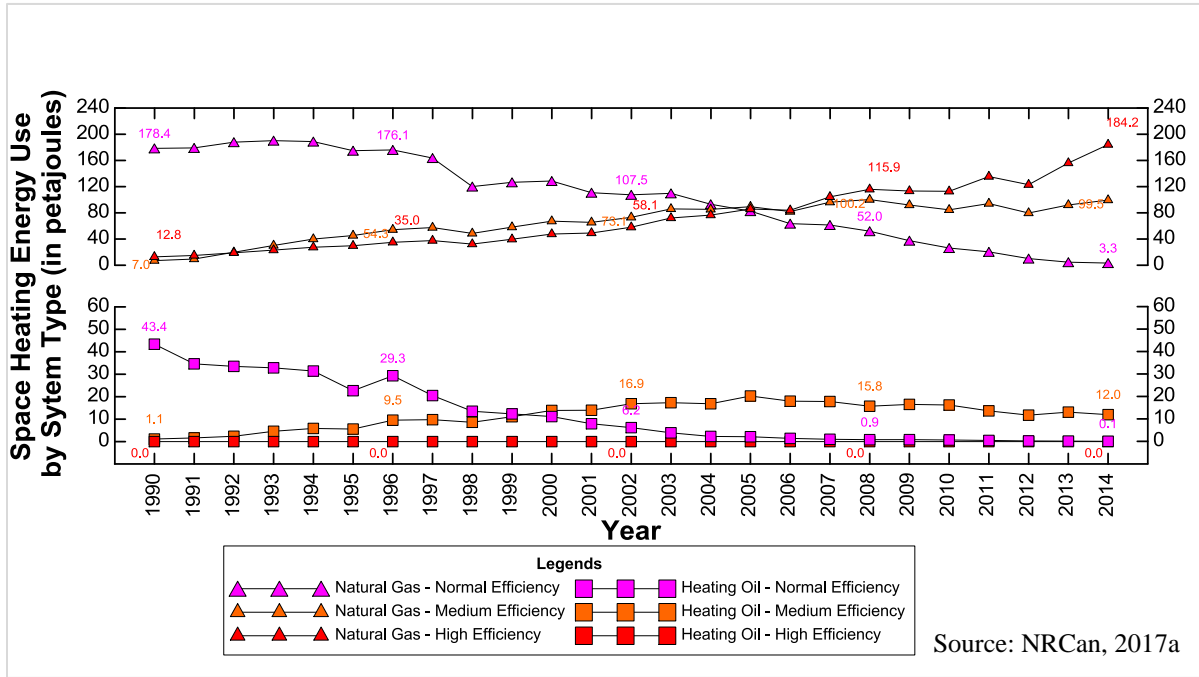

Figure A4-1.1: Total Space Heating Energy Use by System Type in Ontario from 1990 to 2014 – Part I

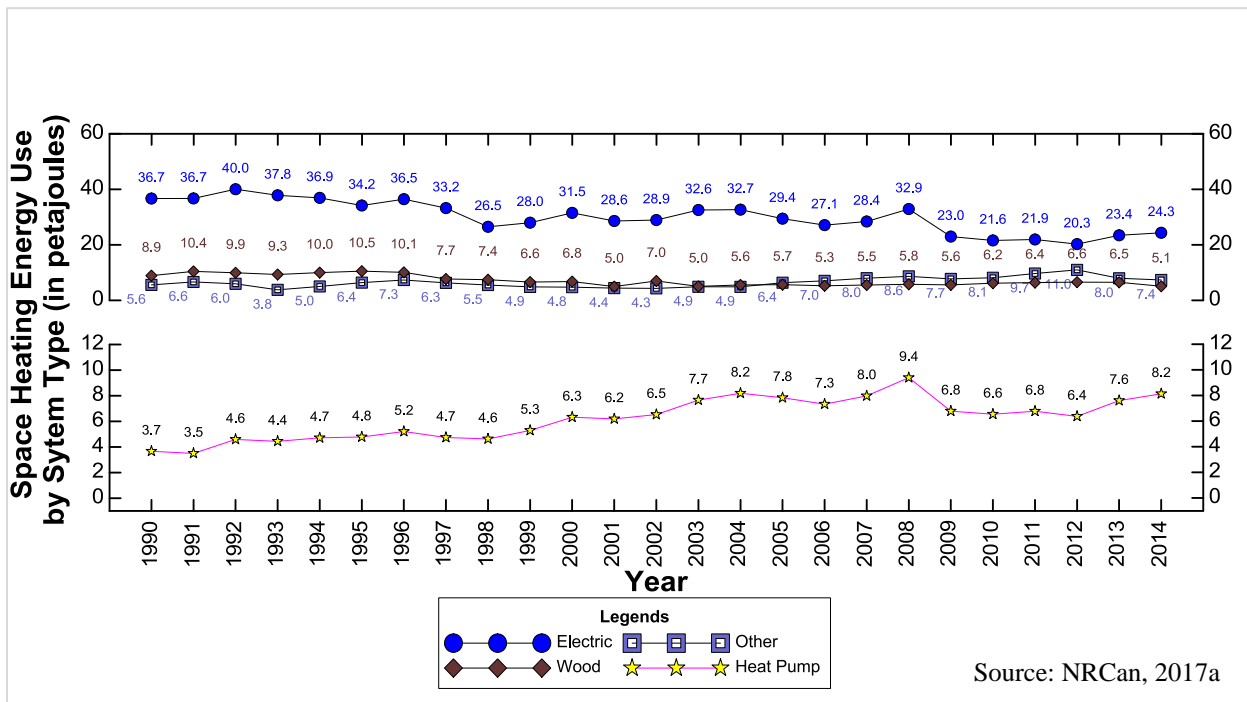

Figure A4-1.2: Total Space Heating Energy Use by System Type in Ontario from 1990 to 2014 – Part II

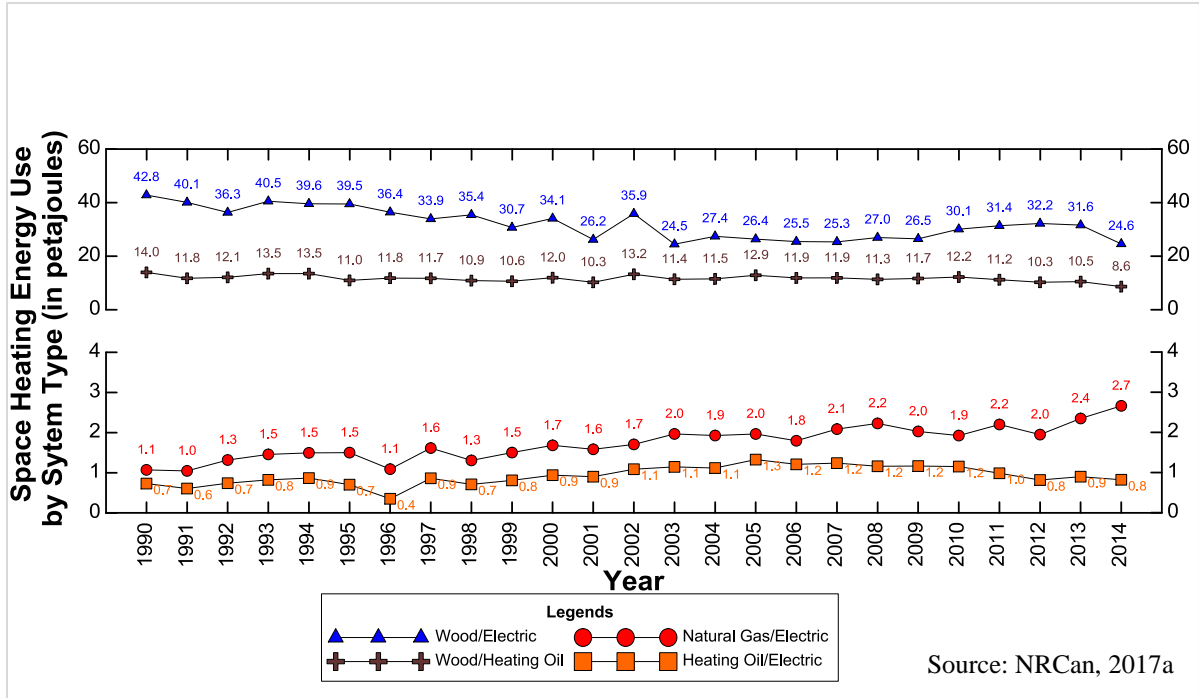

Figure A4-1.3: Total Space Heating Energy Use by System Type in Ontario from 1990 to 2014 – Part III

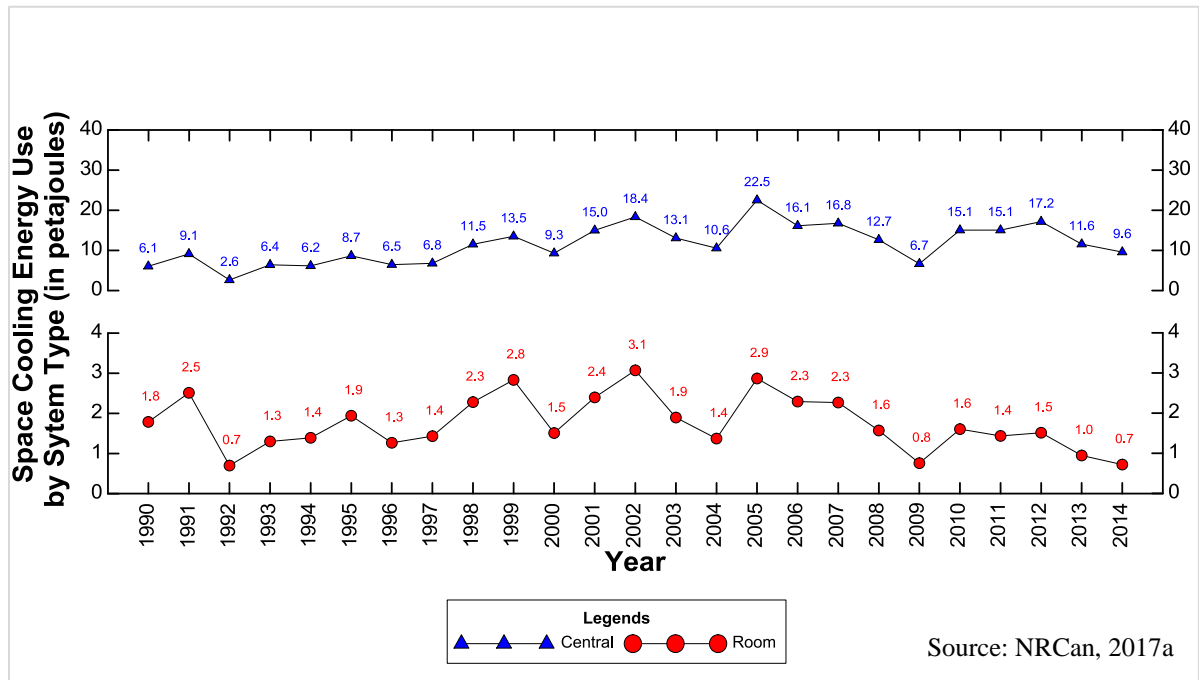

Figure A4-1.4: Total Space Cooling Energy Use by System Type in Ontario from 1990 to 2014

Appendix A5 – Total Energy System Stock in the Residential Households of Ontario

1. Heating System Stock

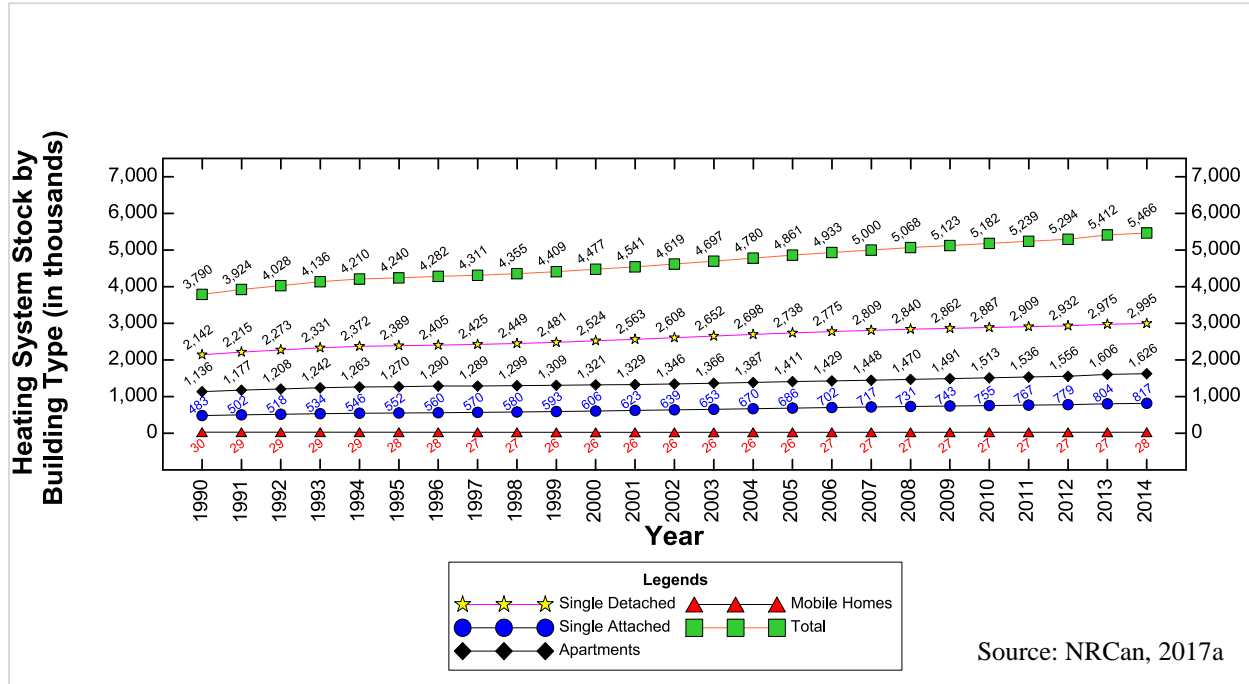

Figure A5-1.1: Heating System Stock by Building Type in Ontario from 1990 to 2014

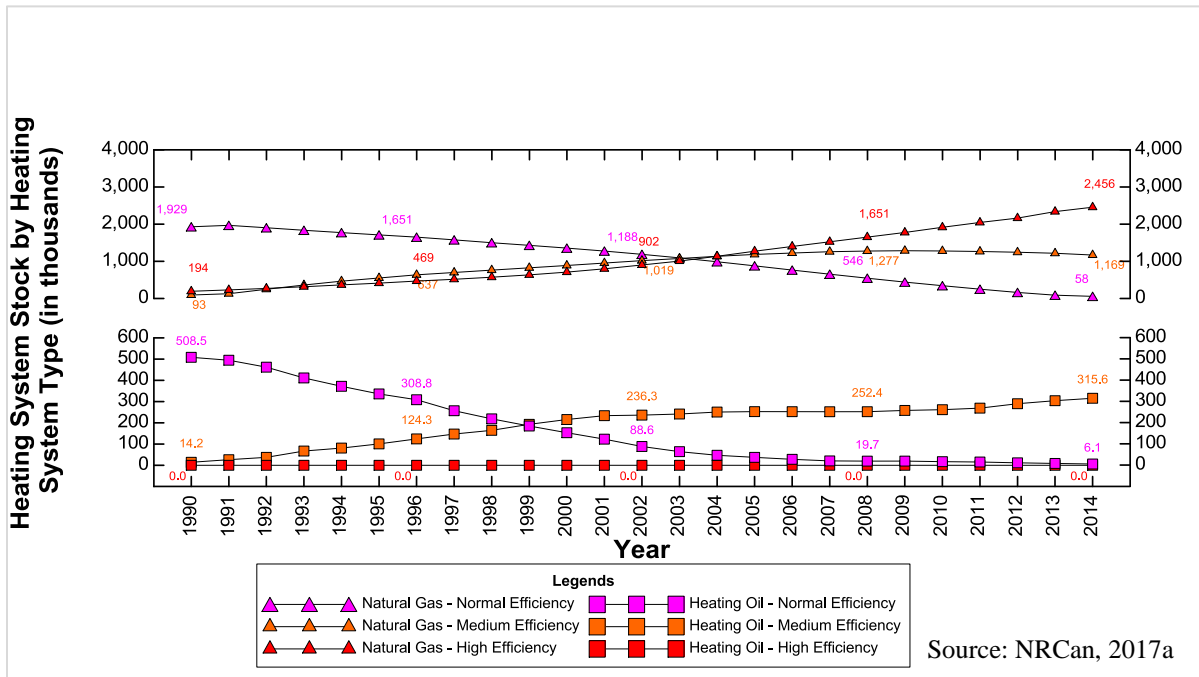

Figure A5-1.2: Heating System Stock by Heating System Type in the Residential Households of Ontario from 1990 to 2014 – Part I

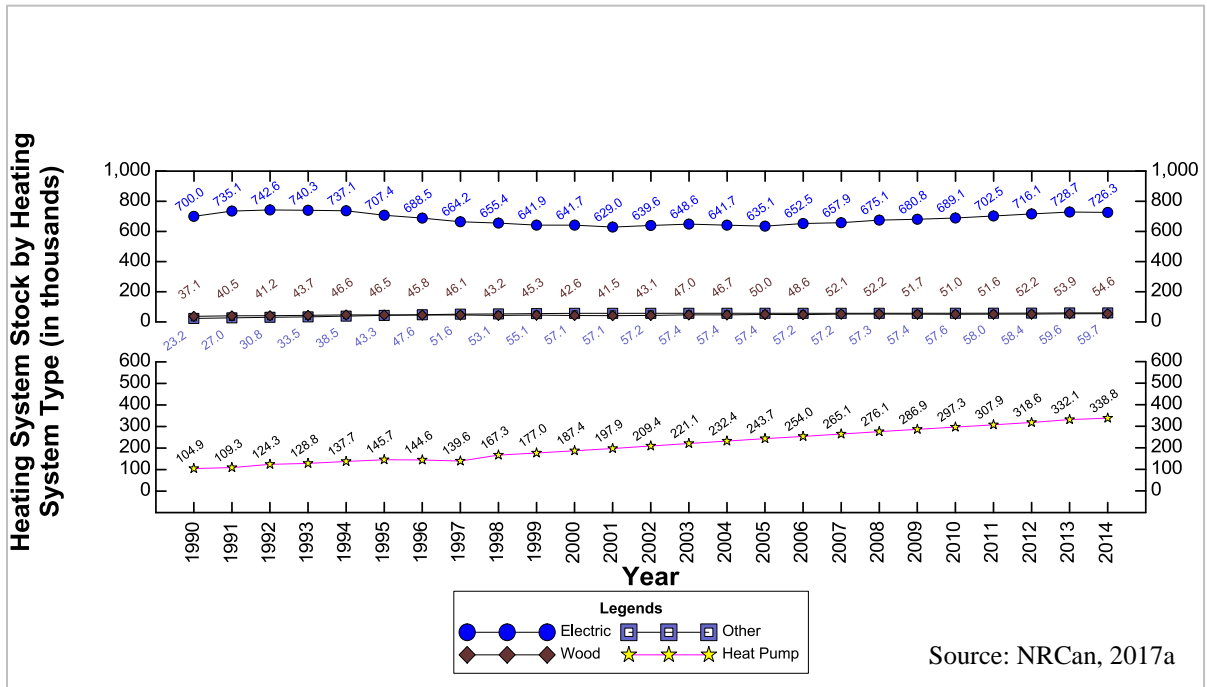

Figure A5-1.3: Heating System Stock by Heating System Type in the Residential Households of Ontario from 1990 to 2014 – Part II

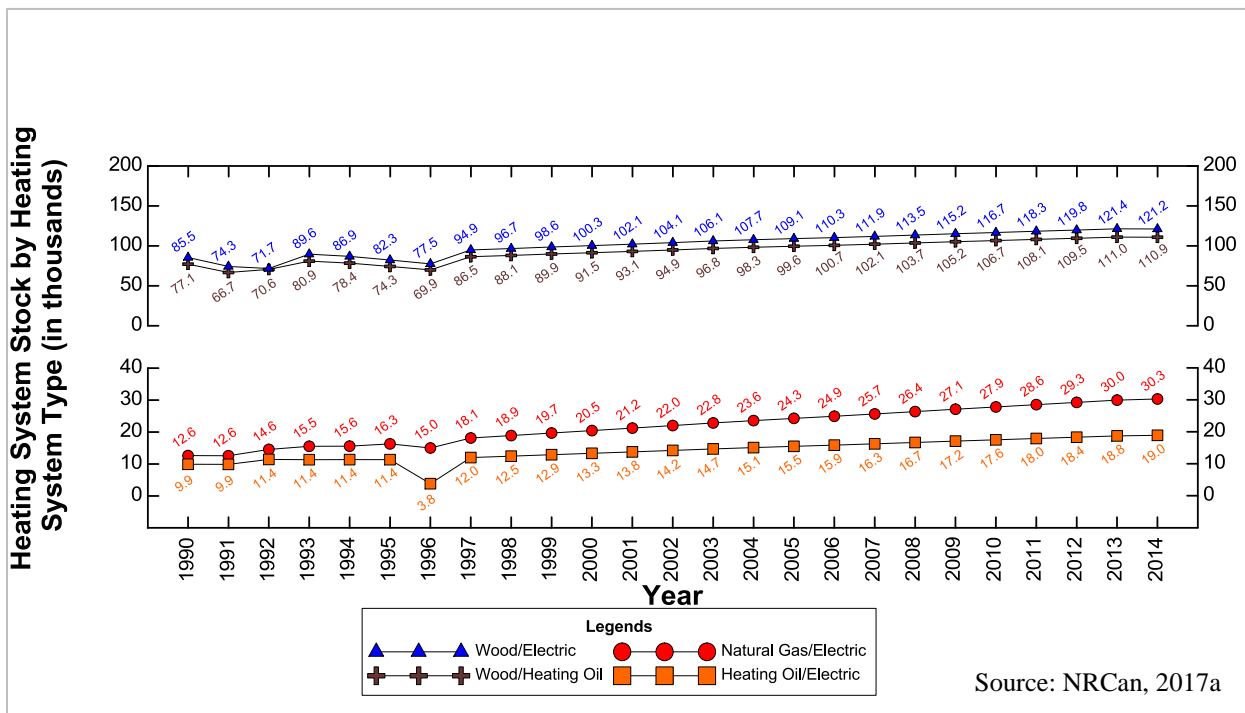

Figure A5-1.4: Heating System Stock by Heating System Type in the Residential Households of Ontario from 1990 to 2014 – Part III

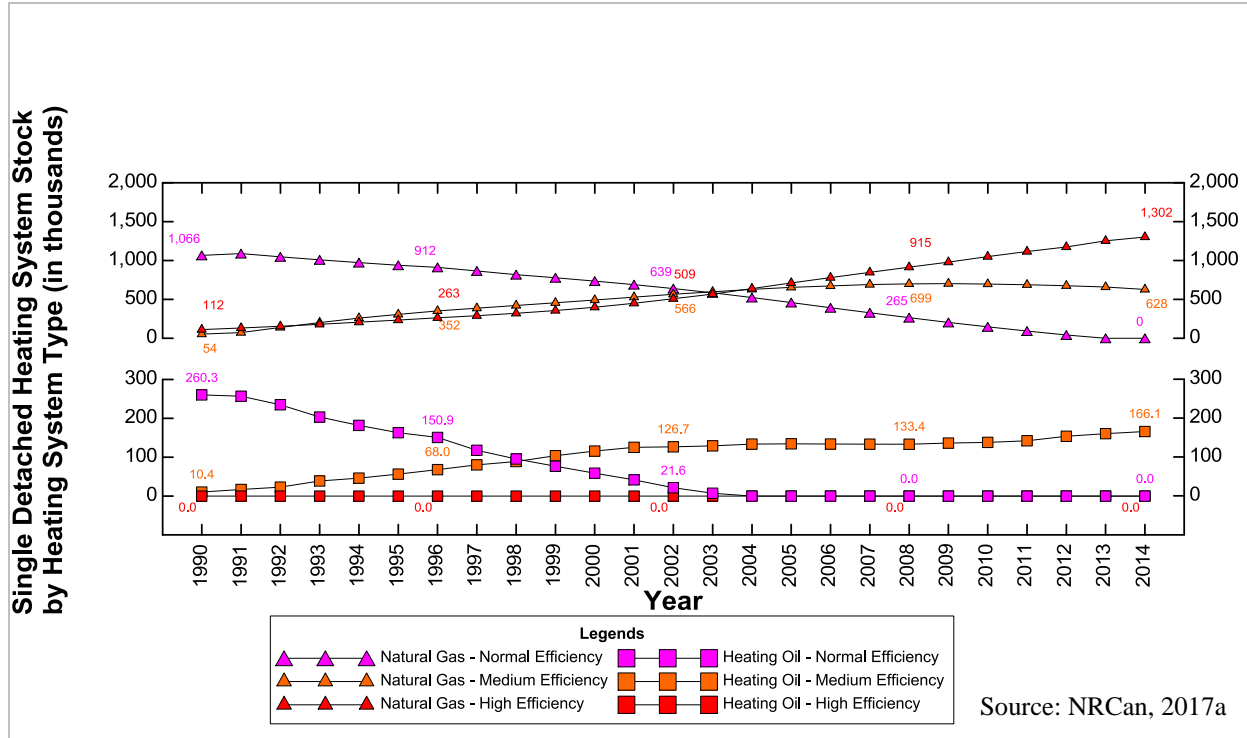

Figure A5-1.5: Single Detached Heating System Stock by Heating System Type in Ontario from 1990 to 2014 – Part I

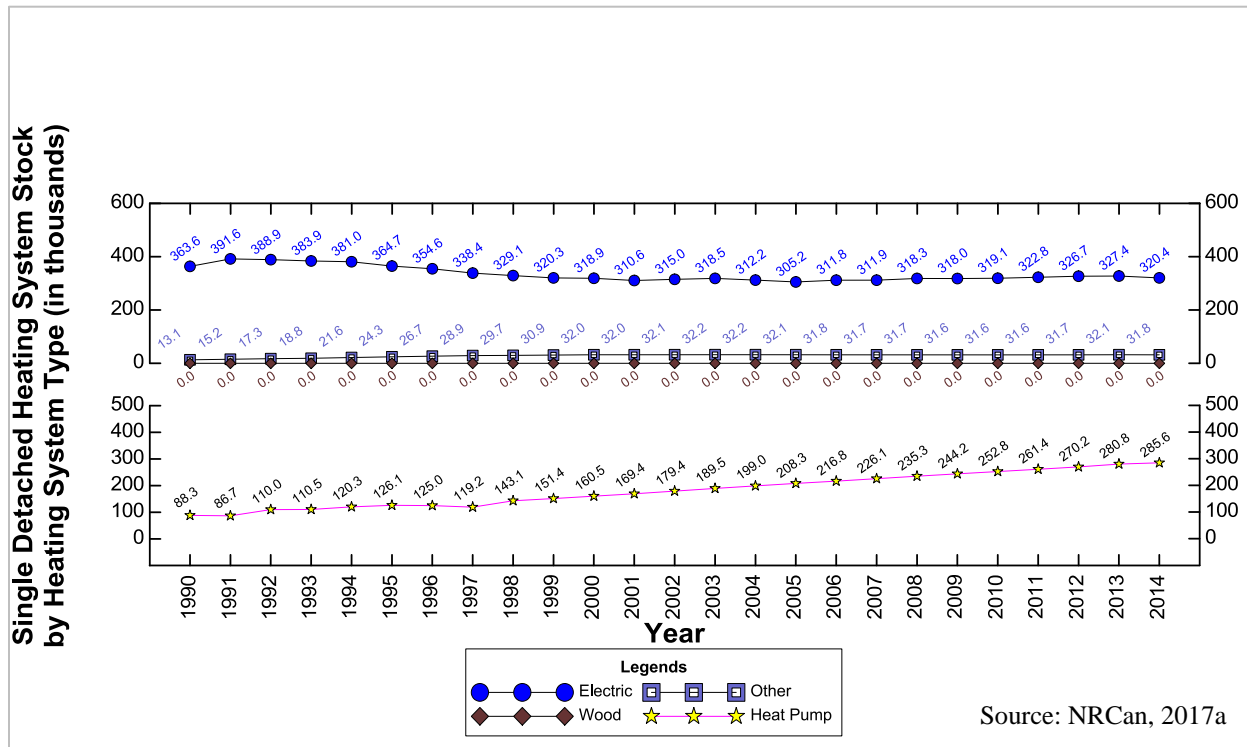

Figure A5-1.6: Single Detached Heating System Stock by Heating System Type in Ontario from 1990 to 2014 – Part II

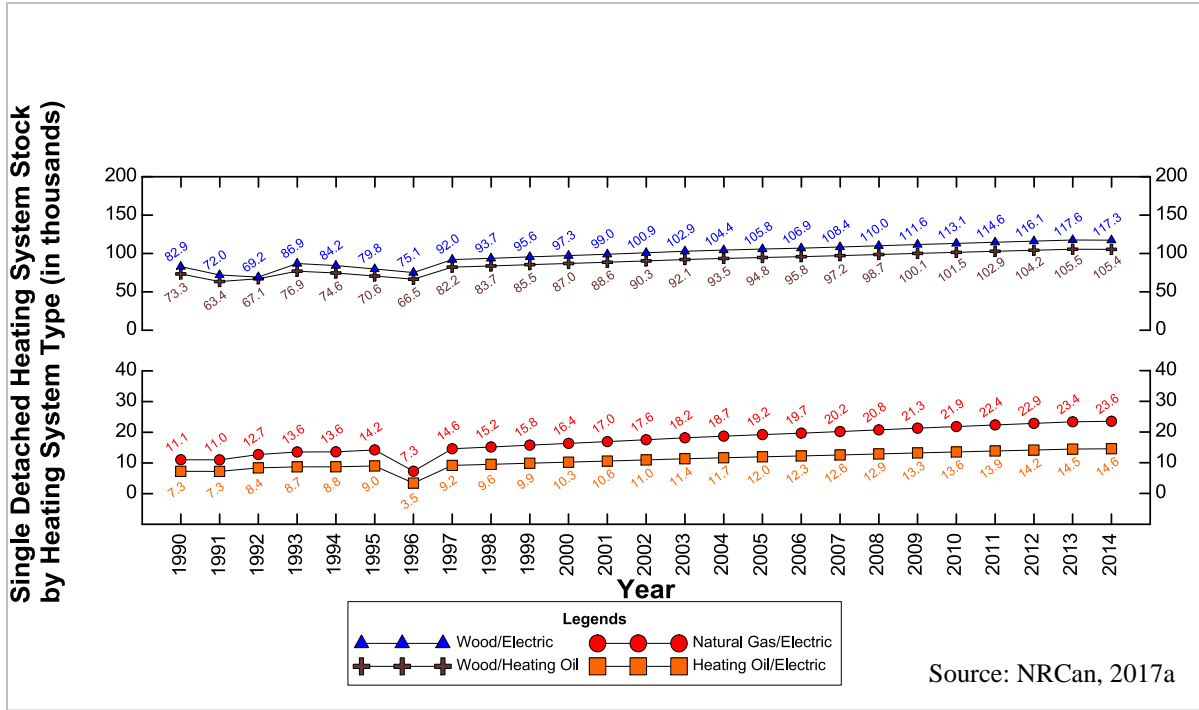

Figure A5-1.7: Single Detached Heating System Stock by Heating System Type in Ontario from 1990 to 2014 – Part III

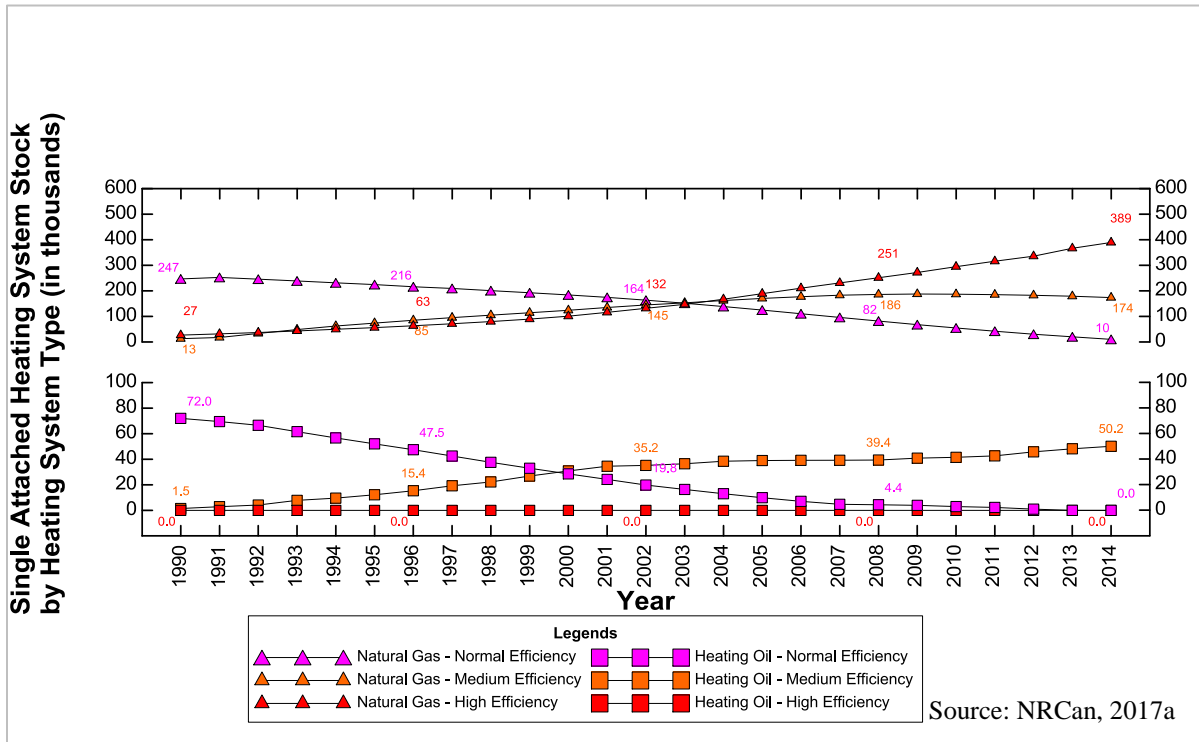

Figure A5-1.8: Single Attached Heating System Stock by Heating System Type in Ontario from 1990 to 2014 – Part I

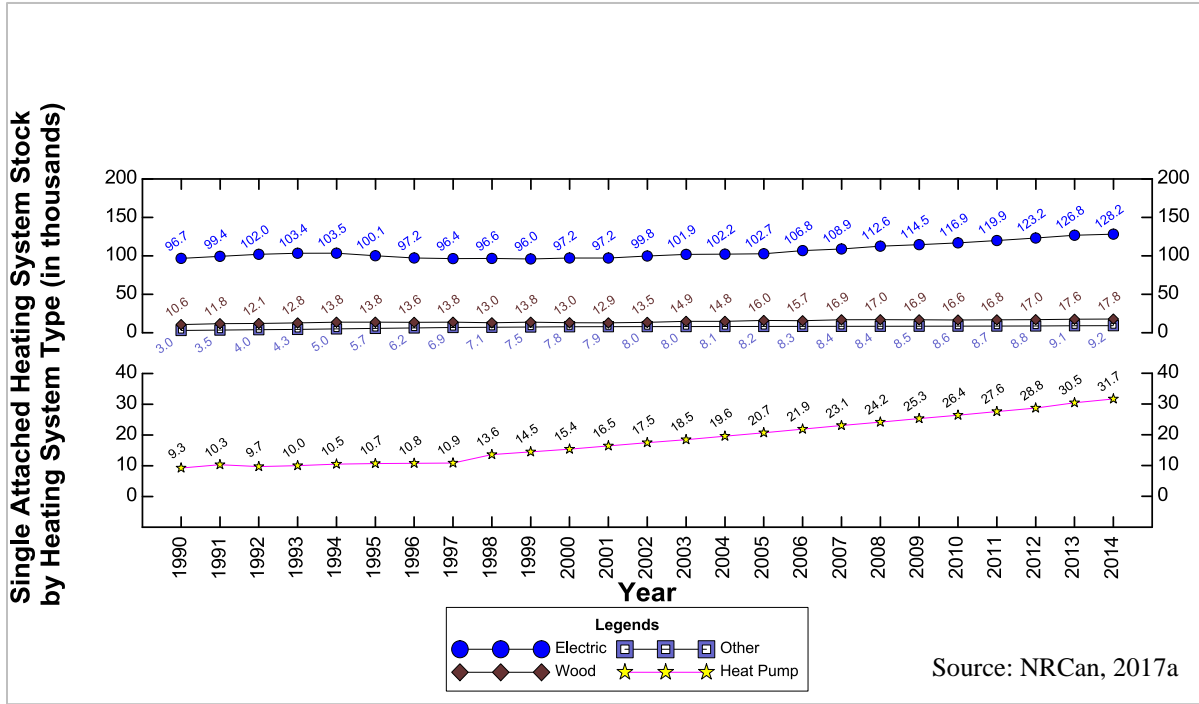

Figure A5-1.9: Single Attached Heating System Stock by Heating System Type in Ontario from 1990 to 2014 – Part II

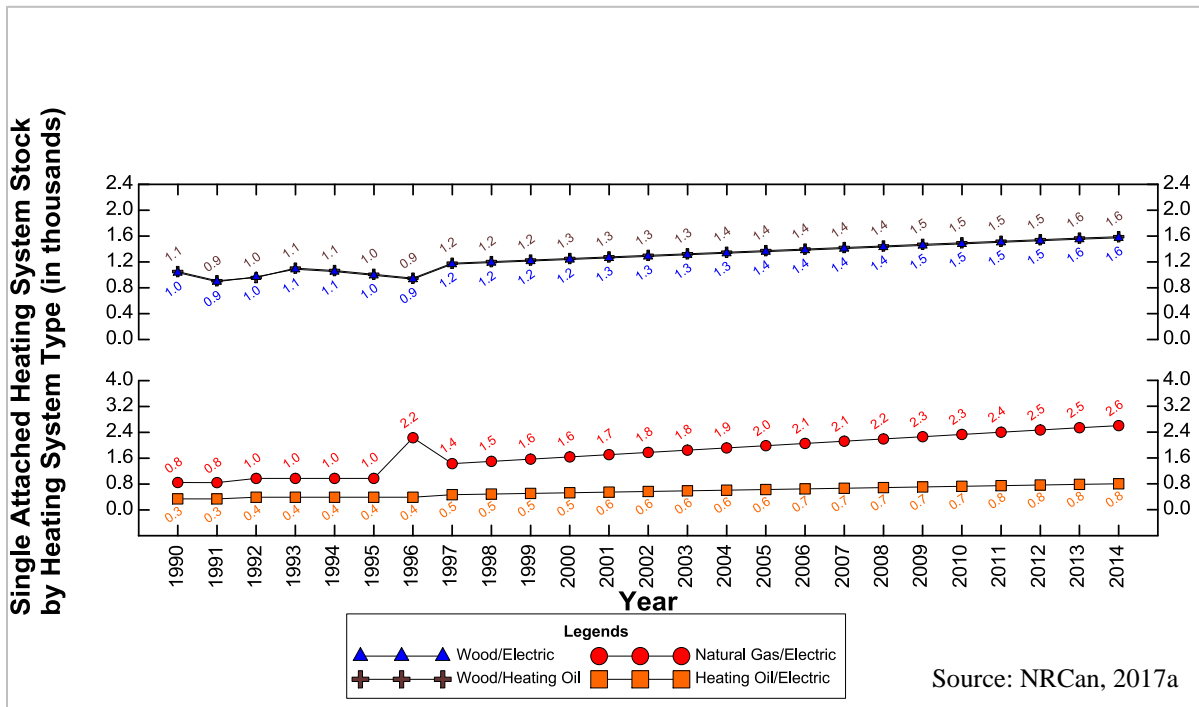

Figure A5-1.10: Single Attached Heating System Stock by Heating System Type in Ontario from 1990 to 2014 – Part III

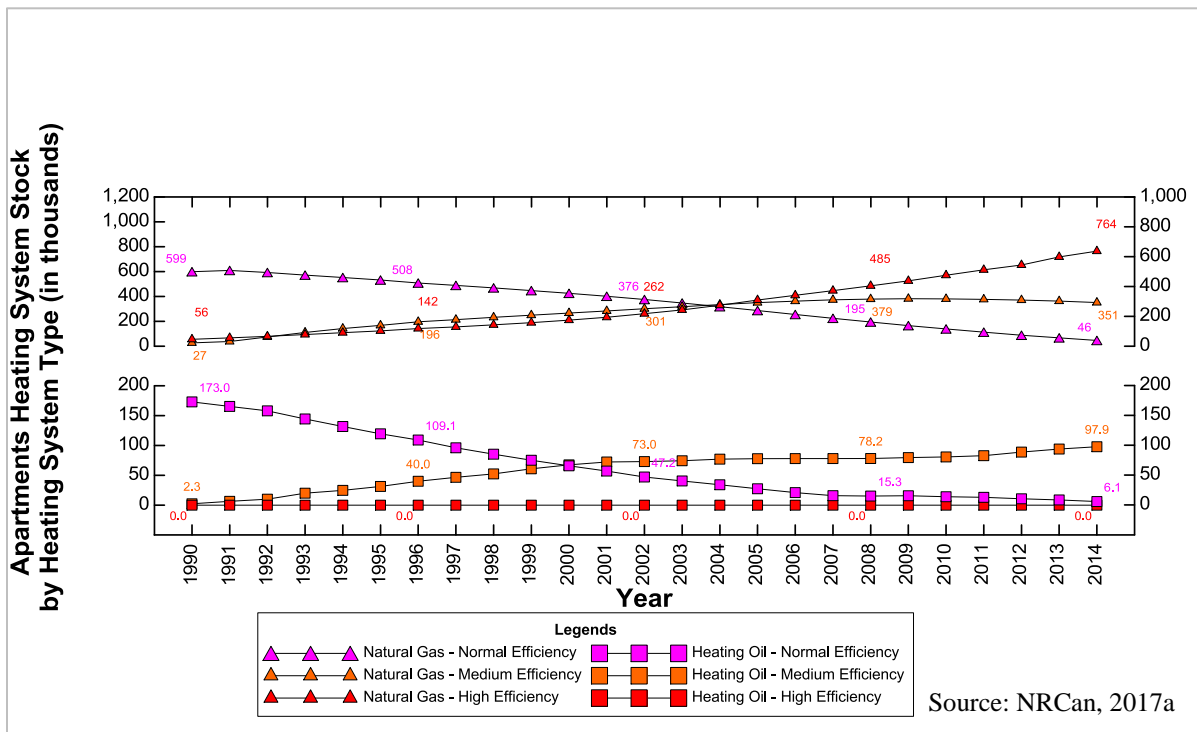

Figure A5-1.11: Apartments Heating System Stock by Heating System Type in Ontario from 1990 to 2014 – Part I

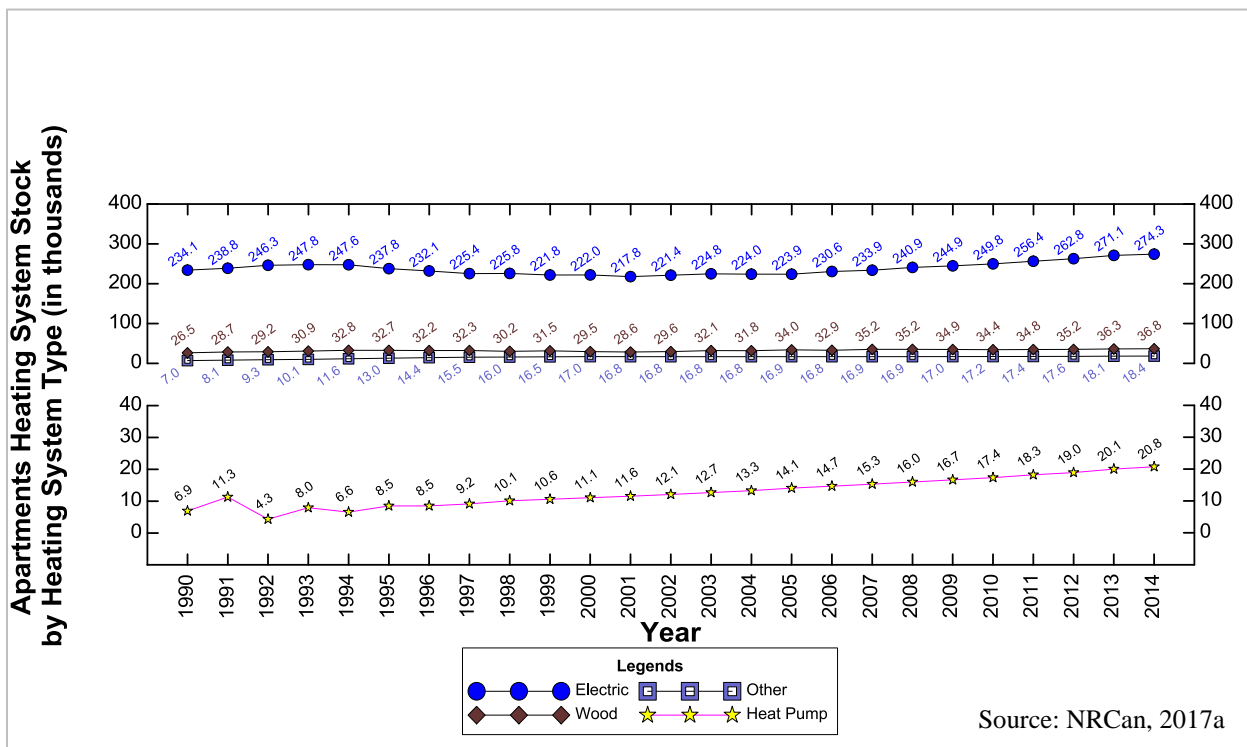

Figure A5-1.12: Apartments Heating System Stock by Heating System Type in Ontario from 1990 to 2014 – Part II

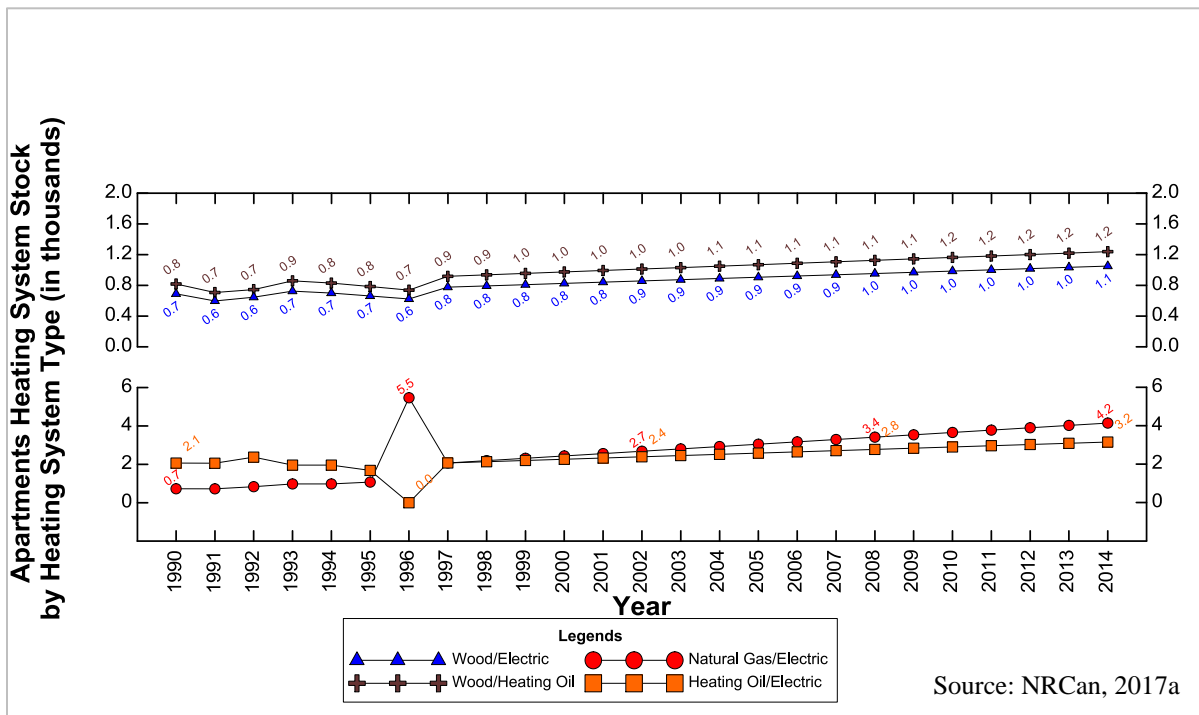

Figure A5-1.13: Apartments Heating System Stock by Heating System Type in Ontario from 1990 to 2014 – Part III

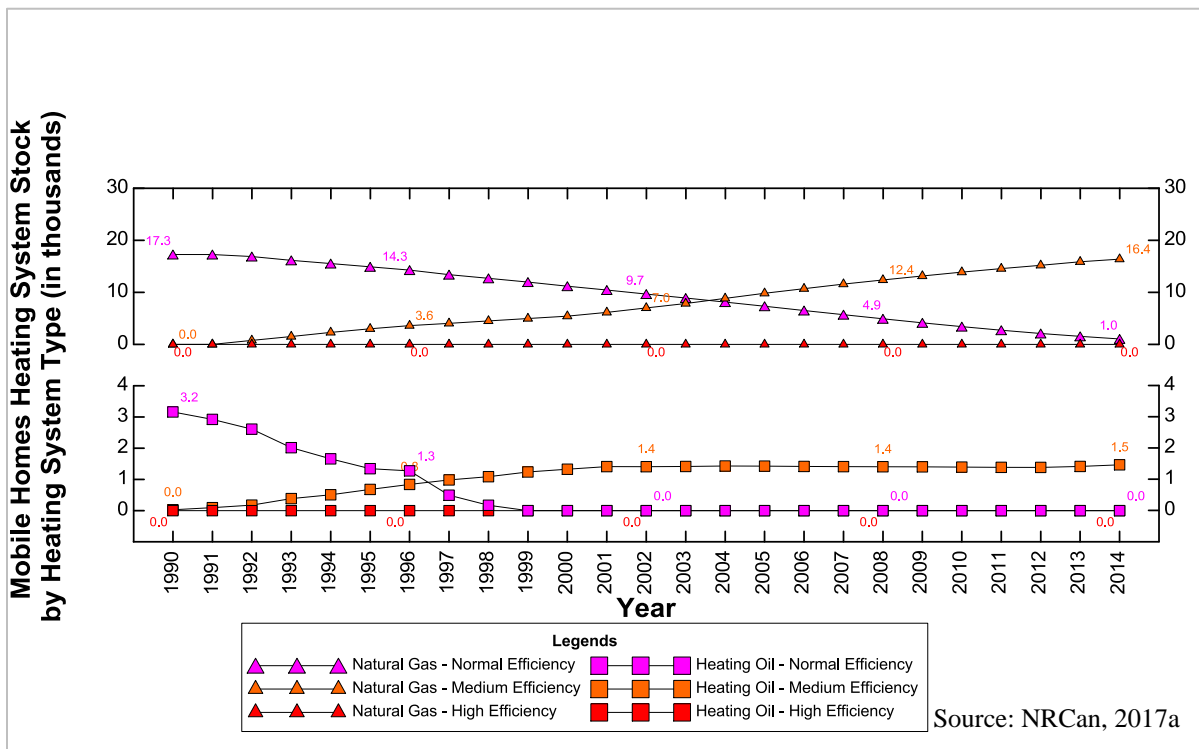

Figure A5-1.14: Mobile Homes Heating System Stock by Heating System Type in Ontario from 1990 to 2014 – Part I

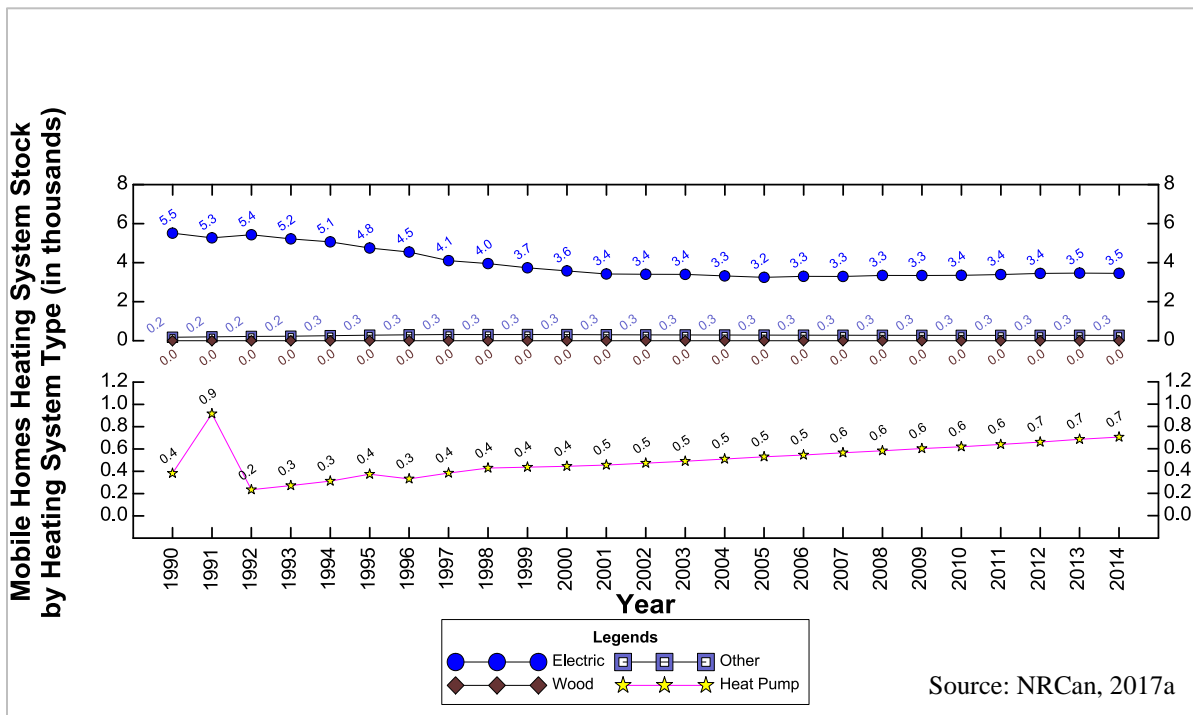

Figure A5-1.15: Mobile Homes Heating System Stock by Heating System Type in Ontario from 1990 to 2014 – Part II

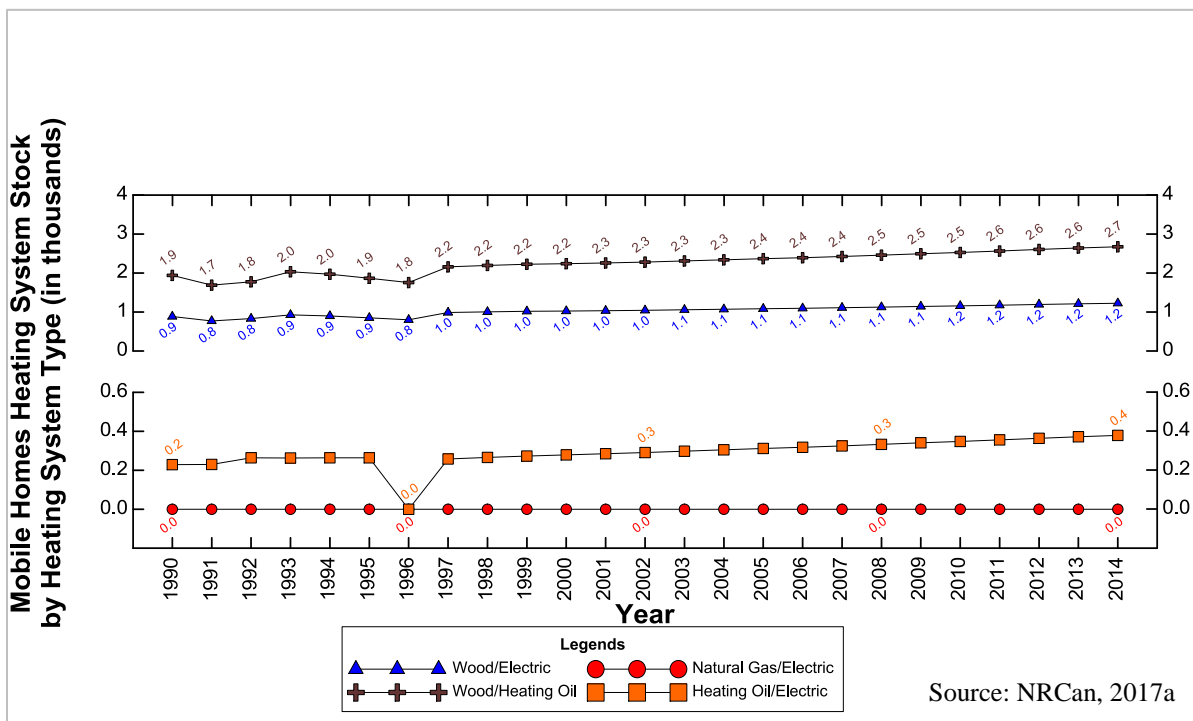

Figure A5-1.16: Mobile Homes Heating System Stock by Heating System Type in Ontario from 1990 to 2014 – Part III

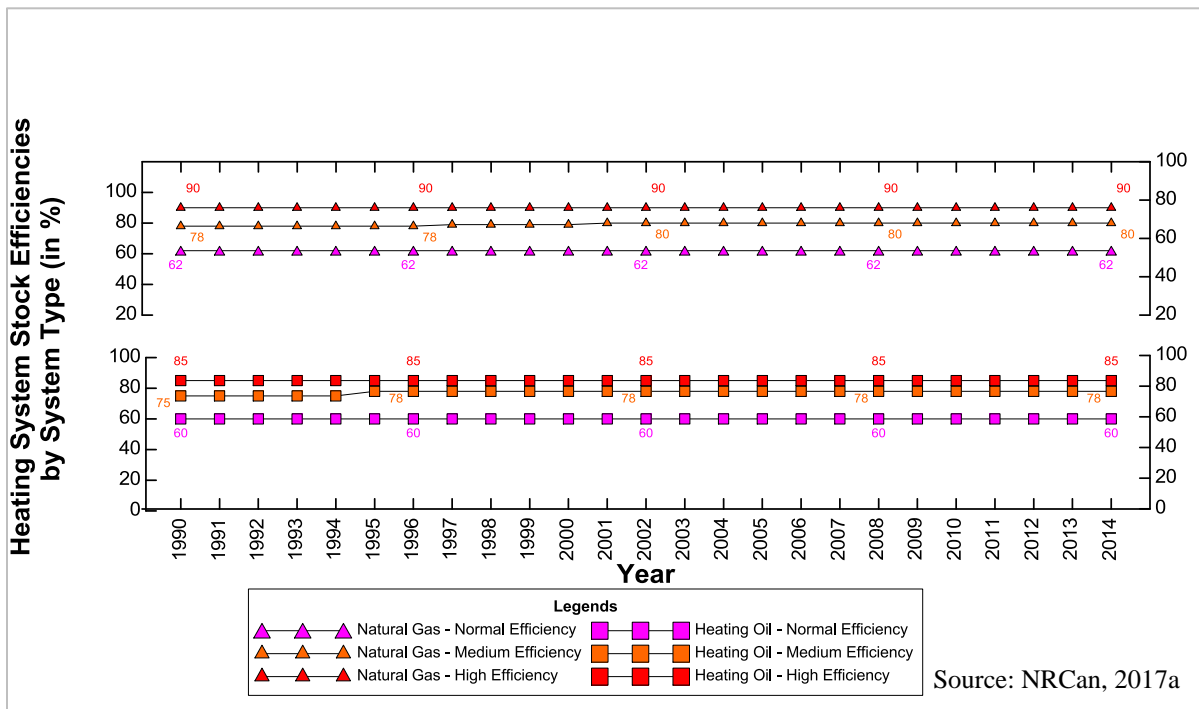

Figure A5-1.17: Heating System Stock Efficiencies by System Type in the Residential Households of Ontario from 1990 to 2014 – Part I

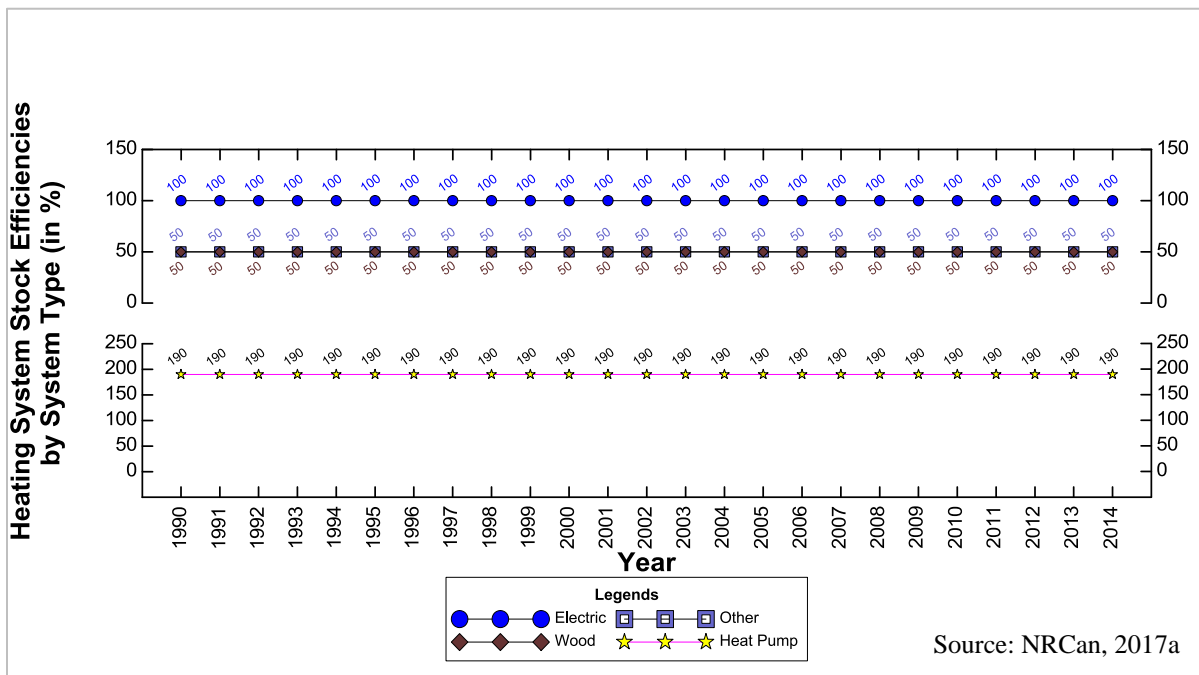

Figure A5-1.18: Heating System Stock Efficiencies by System Type in the Residential Households of Ontario from 1990 to 2014 – Part II

2. Cooling System Stock

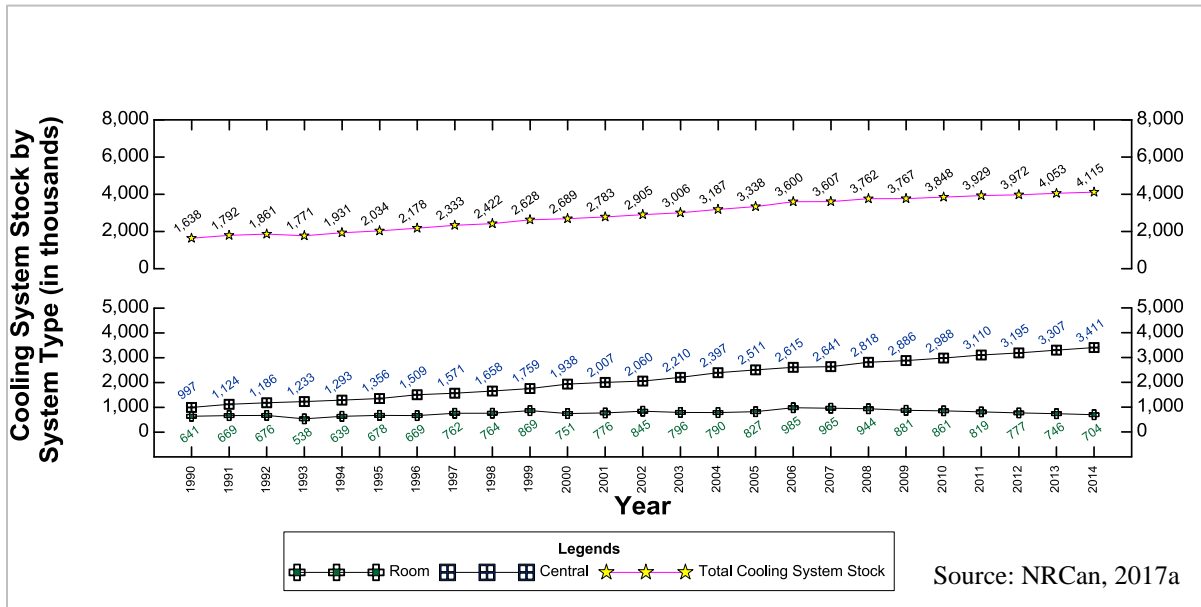

Figure A5-1.19: Cooling System Stock by System Type in the Residential Households of Ontario from 1990 to 2014

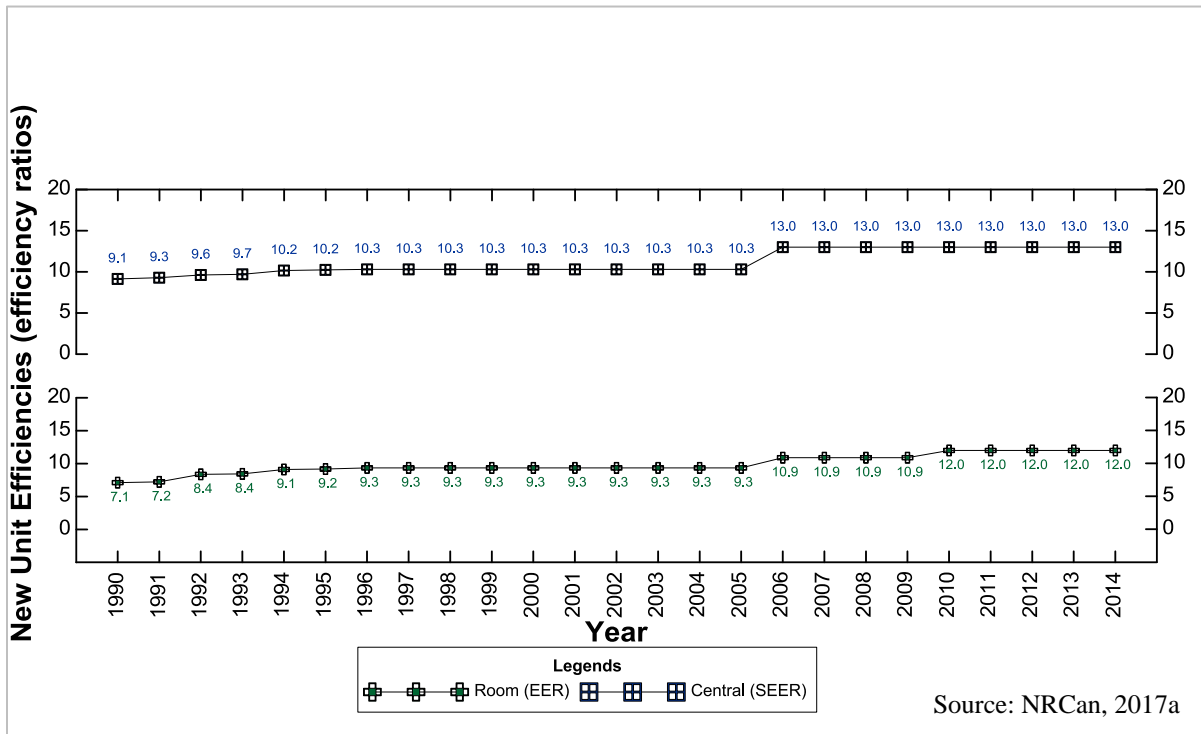

Figure A5-1.20: New Cooling Unit Efficiencies by System Type in the Residential Households of Ontario from 1990 to 2014

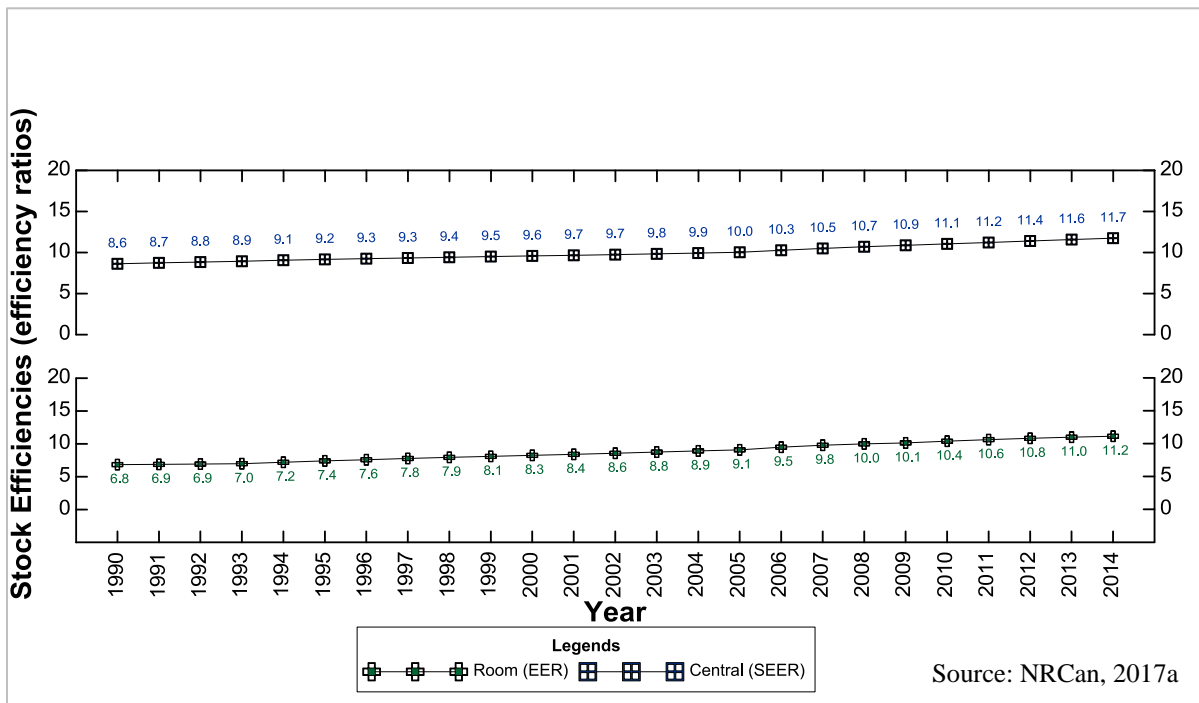

Figure A5-1.21: Cooling Stock Efficiencies by System Type in the Residential Households of Ontario from 1990 to 2014

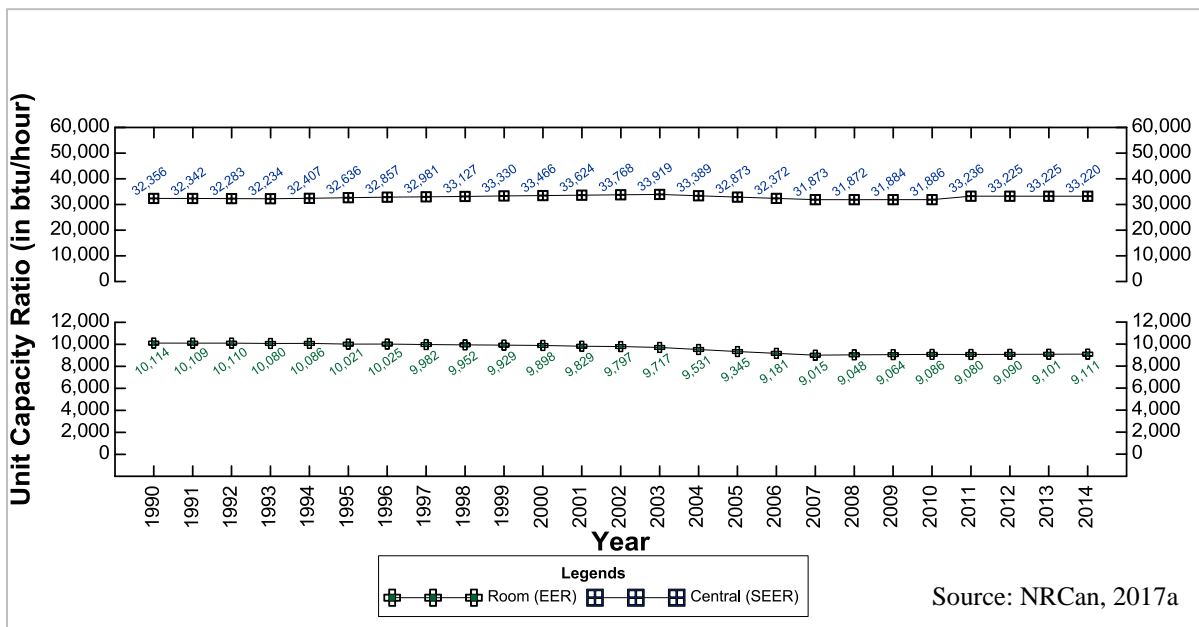

Figure A5-1.22: Unit Capacity Ratio by System Type in the Residential Households of Ontario from 1990 to 2014

3. Water Heater Stock

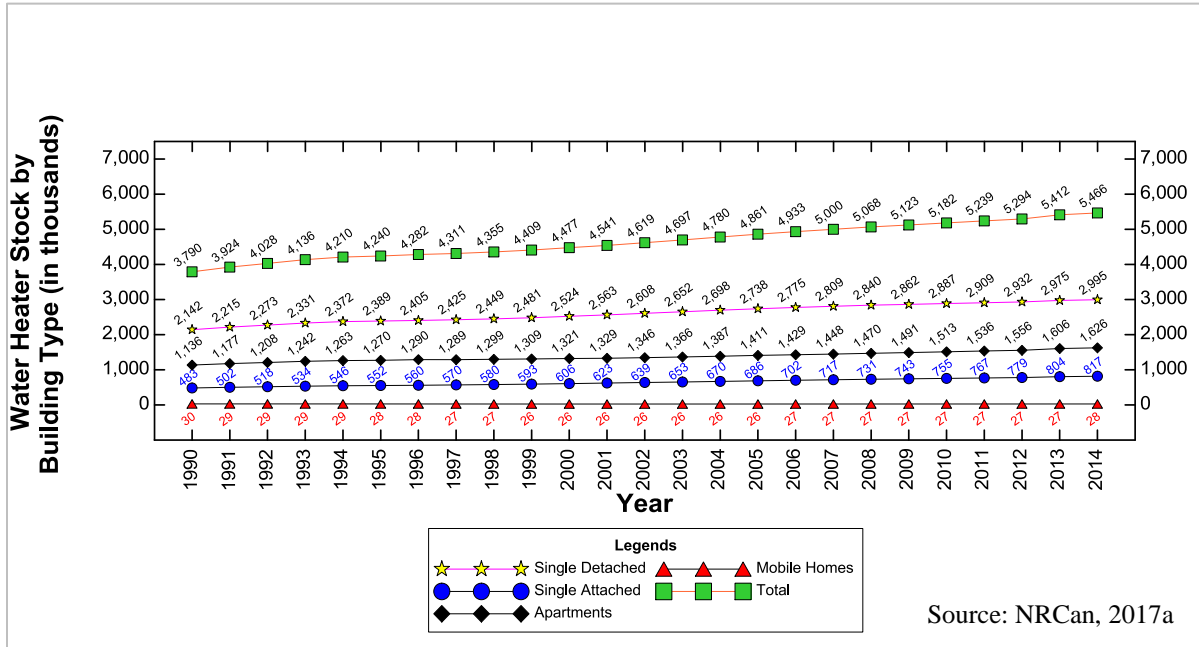

Figure A5-1.23: Water Heater Stock by Building Type in the Residential Households of Ontario from 1990 to 2014

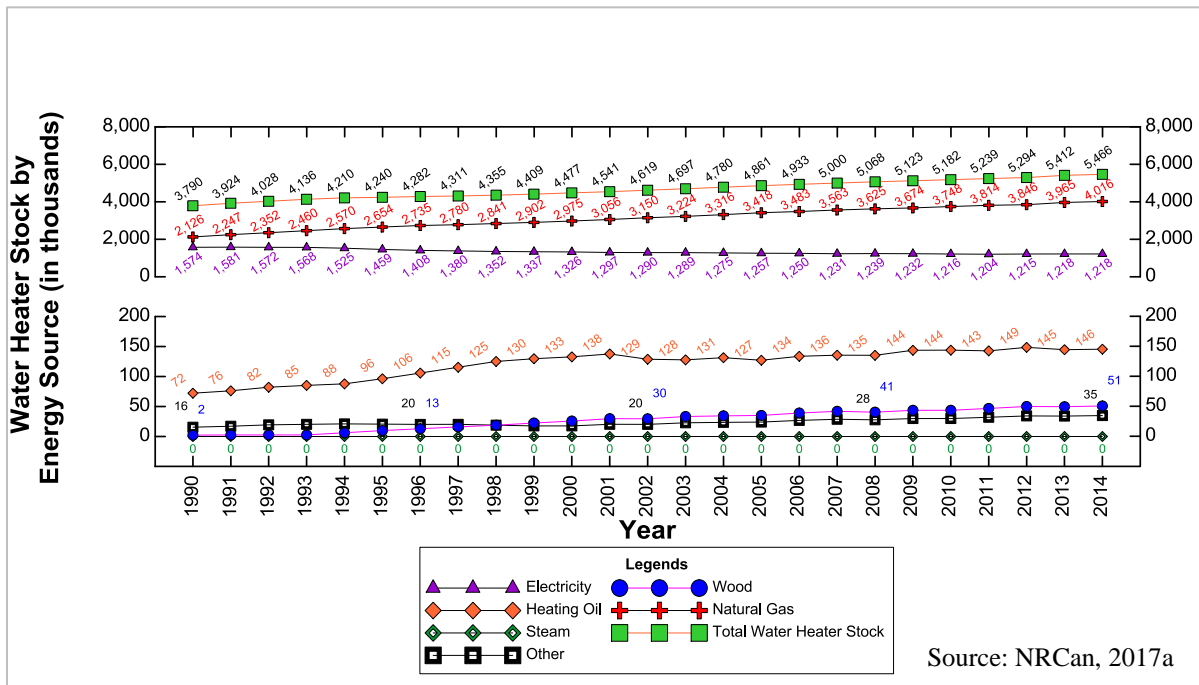

Figure A5-1.24: Water Heater Stock by Energy Source in the Residential Households of Ontario from 1990 to 2014

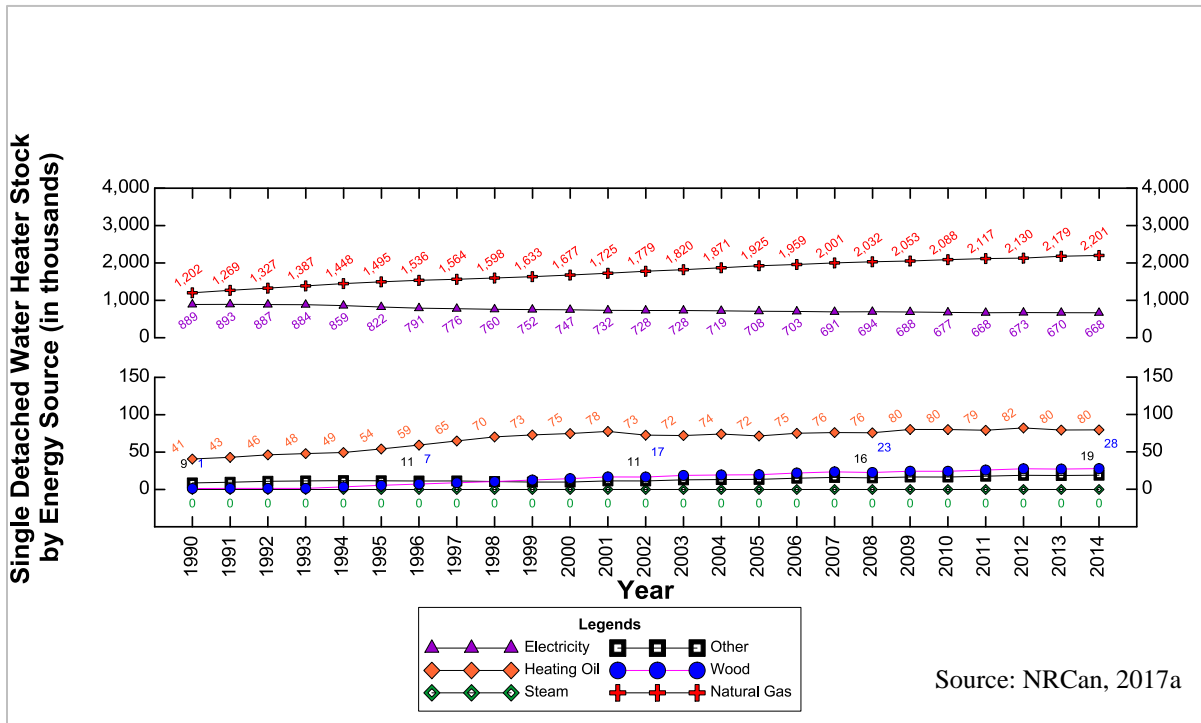

Figure A5-1.25: Single Detached Water Heater Stock by Energy Source in Ontario from 1990 to 2014

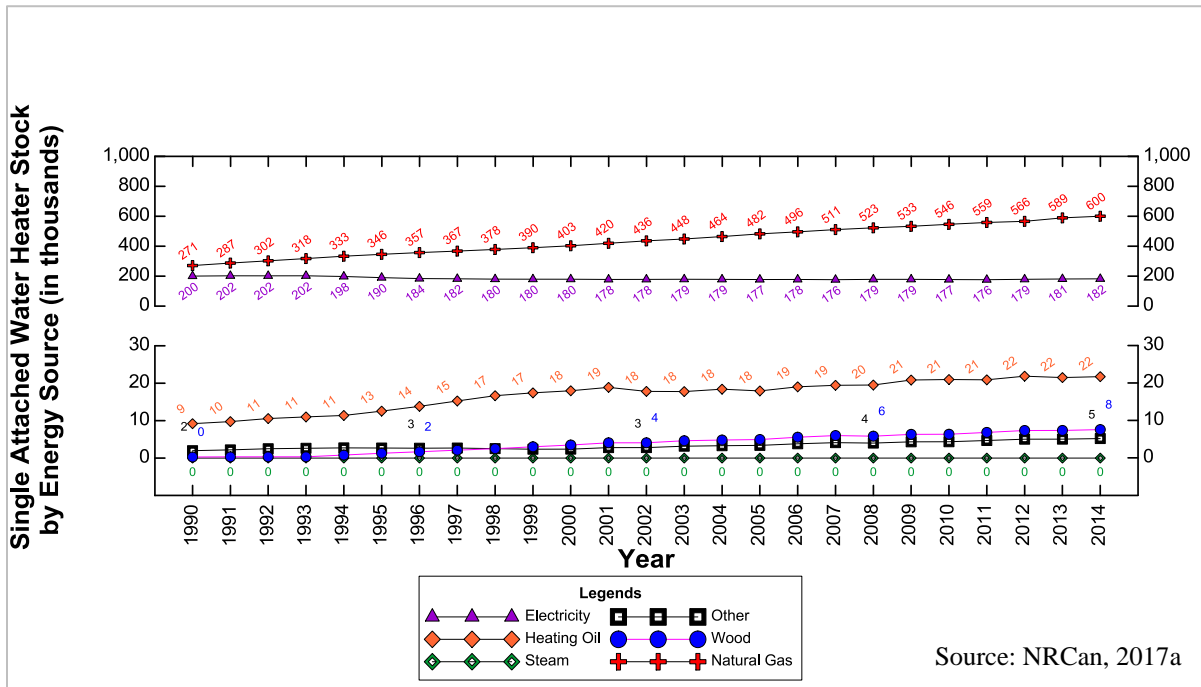

Figure A5-1.26: Single Attached Water Heater Stock by Energy Source in Ontario from 1990 to 2014

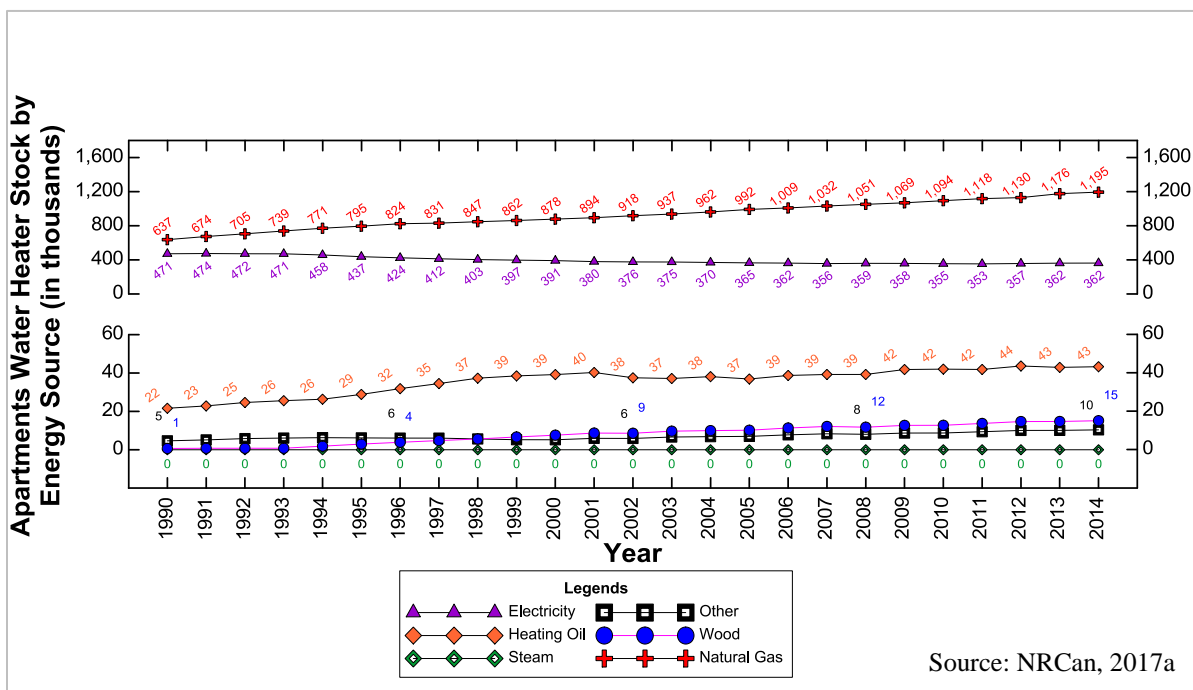

Figure A5-1.27: Apartments Water Heater Stock by Energy Source in Ontario from 1990 to 2014

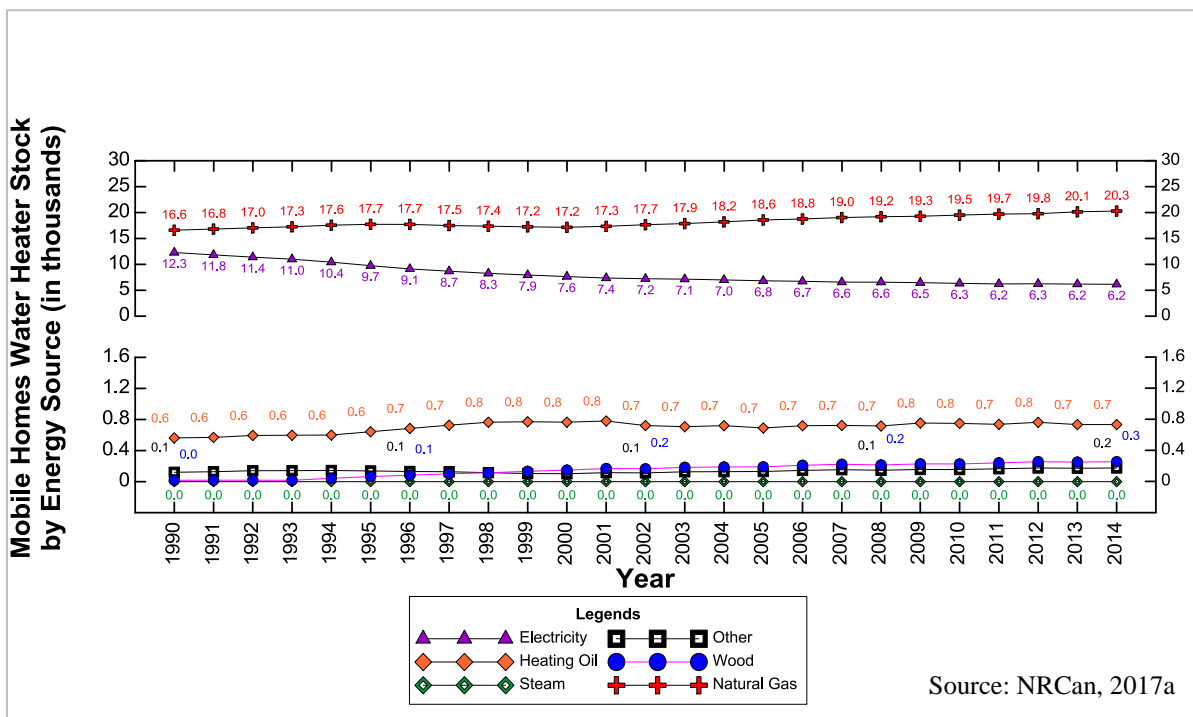

Figure A5-1.28: Mobile Homes Water Heater Stock by Energy Source in Ontario from 1990 to 2014

Appendix B1 – Annual Hourly Analysis of Heating and Cooling Loads and HVAC Units
Capacity to Cover these Loads – Average Construction Type

1. Cambridge (South) – Annual Hourly Heating and Cooling Loads Analysis and Coverage

Vertical Ground Source Heat Pump System (V.GSHPs)

Weather		Loads		GeoSmart Energy System					Auxiliary	
Air	Annual Hrs	Space Load	DHW	Geo	WF Air	WF DHW	WF Run	WF KWH	Space	DHW
°F	hours	Btuh/hr	Btuh/hr	°F	Btuh/hr	Btuh/hr	Time	kWh	kWh	kWh
87	9	26,862	2,427	63	26,862	1,859	100.0%	7	0	2
82	92	19,903	2,427	58	19,903	1,126	100.0%	49	0	38
77	227	12,945	2,427	54	13,072	599	99.0%	84	0	133
72	397	8,769	2,427	51	13,236	528	66.3%	96	0	263
67	588	0	2,427	50	0	0	0.0%	0	0	454
62	726	0	2,427	50	0	0	0.0%	0	0	561
57	732	0	2,427	50	0	0	0.0%	0	0	566
52	679	-2,040	2,427	51	8,880	976	23.0%	102	0	476
47	672	-4,743	2,427	50	8,644	949	54.9%	238	0	408
42	601	-7,445	2,427	48	8,904	993	83.6%	336	0	306
37	649	-10,148	2,427	47	11,262	1,337	90.1%	489	0	253
32	834	-12,850	2,427	45	13,614	1,687	94.4%	796	0	222
27	676	-15,552	2,427	44	15,960	2,043	97.4%	785	0	94
22	551	-18,255	2,427	42	18,300	2,406	99.8%	757	0	5
17	437	-20,957	2,427	41	20,978	2,429	99.9%	685	0	0
12	357	-23,660	2,427	40	23,681	2,429	99.9%	629	0	0
7	238	-26,362	2,427	38	26,383	2,428	99.9%	468	0	0
2	157	-29,065	2,427	37	29,085	2,428	99.9%	341	0	0
-3	86	-31,767	2,427	36	31,788	2,428	99.9%	205	0	0
-8	42	-34,469	2,427	34	34,490	2,428	99.9%	110	0	0
-13	12	-37,172	2,427	33	37,192	2,428	99.9%	34	0	0
-18	1	-39,874	2,427	32	39,894	2,428	99.9%	3	0	0
-23	1	-42,577	2,427	31	42,597	2,428	100.0%	3	0	0
Totals	8764							6216	0	3,778

Table B1-1.1: Annual analysis of heating and cooling loads (in blue and red rectangular boxes on the left side) and vertical ground source heat pump (V.GSHP) unit covering the heating and cooling loads (in blue and red circular boxes on the right side) for a 2,000 square feet detached house above grade (average construction type) in the city of Cambridge

Horizontal Ground Source Heat Pump System (H.GSHPs)

Weather		Loads		GeoSmart Energy System					Auxiliary	
Air °F	Annual Hrs hours	Space Load Btuh/hr	DHW Btuh/hr	Geo °F	WF Air Btuh/hr	WF DHW Btuh/hr	WF Run Time	WF KWH kWh	Space kWh	DHW kWh
87	9	26,862	2,427	62	26,862	1,797	100.0%	6	0	2
82	92	19,903	2,427	59	19,903	1,152	100.0%	49	0	37
77	227	12,945	2,427	56	12,963	646	99.9%	86	0	129
72	397	8,769	2,427	54	13,077	597	67.1%	99	0	256
67	588	0	2,427	50	0	0	0.0%	0	0	454
62	726	0	2,427	50	0	0	0.0%	0	0	561
57	732	0	2,427	50	0	0	0.0%	0	0	566
52	679	-2,040	2,427	47	8,199	900	24.9%	106	0	476
47	672	-4,743	2,427	46	8,036	882	59.0%	247	0	408
42	601	-7,445	2,427	45	8,887	1,010	83.8%	346	0	303
37	649	-10,148	2,427	44	11,241	1,357	90.3%	503	0	248
32	834	-12,850	2,427	43	13,591	1,709	94.5%	815	0	215
27	676	-15,552	2,427	42	15,937	2,065	97.6%	801	0	88
22	551	-18,255	2,427	41	18,279	2,426	99.9%	770	0	1
17	437	-20,957	2,427	40	20,978	2,429	99.9%	693	0	0
12	357	-23,660	2,427	39	23,681	2,429	99.9%	634	0	0
7	238	-26,362	2,427	38	26,383	2,428	99.9%	469	0	0
2	157	-29,065	2,427	37	29,085	2,428	99.9%	341	0	0
-3	86	-31,767	2,427	36	31,788	2,428	99.9%	204	0	0
-8	42	-34,469	2,427	35	34,490	2,428	99.9%	109	0	0
-13	12	-37,172	2,427	34	37,192	2,428	99.9%	34	0	0
-18	1	-39,874	2,427	33	39,895	2,428	99.9%	3	0	0
-23	1	-42,577	2,427	33	42,597	2,428	100.0%	3	0	0
Totals	8764							6319	0	3,745

Table B1-1.2: Annual analysis of heating and cooling loads (in blue and red rectangular boxes on the left side) and horizontal ground source heat pump (H.GSHP) unit covering the heating and cooling loads (in blue and red circular boxes on the right side) for a 2,000 square feet detached house above grade (average construction type) in the city of Cambridge

Traditional HVAC Applications

Weather		Loads		Fossil Furnace System				Fuel Use		
Air Temp °F	Annual hours	Space Btuh/hr	HW Load Btuh/hr	Furnace Btuh/hr	Furn Run Time	AC Cap Btuh/hr	Clg Run Time	AC kWh	Furnace ccf	HW ccf
87	9	26,862	2,427	0	00.0%	27,174	98.9%	23	0	0
82	92	19,903	2,427	0	00.0%	27,952	71.2%	180	0	4
77	227	12,945	2,427	0	00.0%	28,730	45.1%	306	0	9
72	397	8,769	2,427	0	00.0%	29,508	29.7%	390	0	16
67	588	0	2,427	0	00.0%	0	00.0%	0	0	24
62	726	0	2,427	0	00.0%	0	00.0%	0	0	30
57	732	0	2,427	0	00.0%	0	00.0%	0	0	30
52	679	-2,040	2,427	2,632	04.7%	0	00.0%	0	18	28
47	672	-4,743	2,427	5,711	11.0%	0	00.0%	0	38	28
42	601	-7,445	2,427	8,776	17.2%	0	00.0%	0	53	25
37	649	-10,148	2,427	11,827	23.5%	0	00.0%	0	77	27
32	834	-12,850	2,427	14,863	29.7%	0	00.0%	0	124	35
27	676	-15,552	2,427	17,886	36.0%	0	00.0%	0	121	28
22	551	-18,255	2,427	20,894	42.3%	0	00.0%	0	115	23
17	437	-20,957	2,427	23,888	48.5%	0	00.0%	0	104	18
12	357	-23,660	2,427	26,869	54.8%	0	00.0%	0	96	15
7	238	-26,362	2,427	29,835	61.0%	0	00.0%	0	71	10
2	157	-29,065	2,427	32,787	67.3%	0	00.0%	0	51	7
-3	86	-31,767	2,427	35,724	73.5%	0	00.0%	0	31	4
-8	42	-34,469	2,427	38,648	79.8%	0	00.0%	0	16	2
-13	12	-37,172	2,427	41,558	86.0%	0	00.0%	0	5	0
-18	1	-39,874	2,427	44,453	92.3%	0	00.0%	0	0	0
-23	1	-42,577	2,427	47,334	98.6%	0	00.0%	0	0	0
Totals	8764							899	921	363

Table B1-1.3: Annual analysis of heating and cooling loads (in blue and red rectangular boxes on the left side) and traditional HVAC applications covering the heating and cooling loads (in blue and red circular boxes on the right side) for a 2,000 square feet detached house above grade (average construction type) in the city of Cambridge

2. Chatham (South) – Annual Hourly Heating and Cooling Loads Analysis and Coverage

Vertical Ground Source Heat Pump System (V.GSHPs)

Weather		Loads		GeoSmart Energy System					Auxiliary	
Air	Annual Hrs	Space Load	DHW	Geo	WF Air	WF DHW	WF Run	WF kWh	Space	DHW
°F	hours	Btuh/hr	Btuh/hr	°F	Btuh/hr	Btuh/hr	Time	kWh	kWh	kWh
97	1	35,348	2,363	71	35,348	2,363	100.0%	1	0	0
92	15	29,242	2,363	67	29,242	2,336	100.0%	13	0	0
87	90	23,136	2,363	63	23,136	1,569	100.0%	58	0	23
82	231	17,030	2,363	59	17,030	967	100.0%	109	0	103
77	431	10,924	2,363	55	13,031	617	83.8%	136	0	253
72	646	7,260	2,363	52	13,175	554	55.1%	131	0	423
67	828	0	2,363	52	0	0	0.0%	0	0	623
62	749	0	2,363	52	0	0	0.0%	0	0	564
57	656	-847	2,363	54	9,315	1,024	9.1%	40	0	474
52	612	-3,549	2,363	53	9,077	997	39.1%	158	0	385
47	592	-6,251	2,363	51	8,840	971	70.7%	273	0	316
42	614	-8,954	2,363	50	10,177	1,165	88.0%	403	0	262
37	715	-11,656	2,363	48	12,536	1,508	93.0%	607	0	219
32	859	-14,358	2,363	47	14,889	1,857	96.4%	900	0	156
27	637	-17,061	2,363	45	17,236	2,212	99.0%	798	0	35
22	401	-19,763	2,363	44	19,784	2,365	99.9%	580	0	0
17	299	-22,465	2,363	42	22,487	2,365	99.9%	489	0	0
12	198	-25,168	2,363	41	25,189	2,365	99.9%	362	0	0
7	119	-27,870	2,363	40	27,891	2,365	99.9%	242	0	0
2	51	-30,572	2,363	38	30,593	2,364	99.9%	114	0	0
-3	18	-33,274	2,363	37	33,295	2,364	99.9%	44	0	0
-8	2	-35,977	2,363	36	35,998	2,364	99.9%	5	0	0
-13	1	-38,679	2,363	34	38,700	2,364	99.9%	3	0	0
Totals	8765							5465	0	3,835

Table B1-1.4: Annual analysis of heating and cooling loads (in blue and red rectangular boxes on the left side) and vertical ground source heat pump (V.GSHP) unit covering the heating and cooling loads (in blue and red circular boxes on the right side) for a 2,000 square feet detached house above grade (average construction type) in the city of Chatham

Horizontal Ground Source Heat Pump System (H.GSHPs)

Weather		Loads		GeoSmart Energy System					Auxiliary	
Air °F	Annual Hrs hours	Space Load Btuh/hr	DHW Btuh/hr	Geo °F	WF Air Btuh/hr	WF DHW Btuh/hr	WF Run Time	WF KWH kWh	Space kWh	DHW kWh
97	1	35,348	2,363	68	35,348	2,363	100.0%	1	0	0
92	15	29,242	2,363	65	29,242	2,230	100.0%	12	0	1
87	90	23,136	2,363	63	23,136	1,565	100.0%	57	0	23
82	231	17,030	2,363	60	17,030	1,014	100.0%	111	0	99
77	431	10,924	2,363	57	12,896	676	84.7%	140	0	246
72	646	7,260	2,363	55	12,996	632	55.9%	136	0	413
67	828	0	2,363	52	0	0	0.0%	0	0	623
62	749	0	2,363	52	0	0	0.0%	0	0	564
57	656	-847	2,363	50	8,596	944	9.8%	42	0	474
52	612	-3,549	2,363	49	8,431	926	42.1%	164	0	385
47	592	-6,251	2,363	48	8,268	908	75.6%	282	0	316
42	614	-8,954	2,363	46	10,159	1,183	88.1%	414	0	258
37	715	-11,656	2,363	45	12,515	1,528	93.1%	622	0	214
32	859	-14,358	2,363	44	14,867	1,878	96.6%	919	0	150
27	637	-17,061	2,363	43	17,215	2,233	99.1%	812	0	30
22	401	-19,763	2,363	42	19,784	2,365	99.9%	588	0	0
17	299	-22,465	2,363	41	22,486	2,365	99.9%	494	0	0
12	198	-25,168	2,363	40	25,189	2,365	99.9%	364	0	0
7	119	-27,870	2,363	39	27,891	2,365	99.9%	242	0	0
2	51	-30,572	2,363	38	30,593	2,364	99.9%	114	0	0
-3	18	-33,274	2,363	38	33,296	2,364	99.9%	44	0	0
-8	2	-35,977	2,363	37	35,998	2,364	99.9%	5	0	0
-13	1	-38,679	2,363	36	38,700	2,364	99.9%	3	0	0
Totals	8765							5567	0	3,796

Table B1-1.5: Annual analysis of heating and cooling loads (in blue and red rectangular boxes on the left side) and horizontal ground source heat pump (H.GSHP) unit covering the heating and cooling loads (in blue and red circular boxes on the right side) for a 2,000 square feet detached house above grade (average construction type) in the city of Chatham

Traditional HVAC Applications

Weather		Loads		Fossil Furnace System				Fuel Use		
Air Temp °F	Annual hours	Space Btuh/hr	HW Load Btuh/hr	Furnace Btuh/hr	Furn Run Time	AC Cap Btuh/hr	Clg Run Time	AC kWh	Furnace ccf	HW ccf
97	1	35,348	2,363	0	00.0%	35,865	98.6%	4	0	0
92	15	29,242	2,363	0	00.0%	36,954	79.1%	47	0	1
87	90	23,136	2,363	0	00.0%	38,043	60.8%	223	0	4
82	231	17,030	2,363	0	00.0%	39,132	43.5%	436	0	9
77	431	10,924	2,363	0	00.0%	40,222	27.2%	571	0	17
72	646	7,260	2,363	0	00.0%	41,311	17.6%	638	0	26
67	828	0	2,363	0	00.0%	0	00.0%	0	0	33
62	749	0	2,363	0	00.0%	0	00.0%	0	0	30
57	656	-847	2,363	1,230	02.2%	0	00.0%	0	8	27
52	612	-3,549	2,363	4,313	09.4%	0	00.0%	0	26	25
47	592	-6,251	2,363	7,381	16.5%	0	00.0%	0	44	24
42	614	-8,954	2,363	10,432	23.7%	0	00.0%	0	64	25
37	715	-11,656	2,363	13,467	30.8%	0	00.0%	0	96	29
32	859	-14,358	2,363	16,486	38.0%	0	00.0%	0	142	35
27	637	-17,061	2,363	19,489	45.1%	0	00.0%	0	124	26
22	401	-19,763	2,363	22,476	52.3%	0	00.0%	0	90	16
17	299	-22,465	2,363	25,446	59.4%	0	00.0%	0	76	12
12	198	-25,168	2,363	28,400	66.6%	0	00.0%	0	56	8
7	119	-27,870	2,363	31,339	73.7%	0	00.0%	0	37	5
2	51	-30,572	2,363	34,261	80.9%	0	00.0%	0	17	2
-3	18	-33,274	2,363	37,167	88.0%	0	00.0%	0	7	1
-8	2	-35,977	2,363	40,056	95.2%	0	00.0%	0	1	0
-13	1	-38,679	2,363	41,997	100.0%	0	00.0%	0	0	0
Totals	8765							1919	789	354

Table B1-1.6: Annual analysis of heating and cooling loads (in blue and red rectangular boxes on the left side) and traditional HVAC applications covering the heating and cooling loads (in blue and red circular boxes on the right side) for a 2,000 square feet detached house above grade (average construction type) in the city of Chatham

3. Guelph (South) – Annual Hourly Heating and Cooling Loads Analysis and Coverage

Vertical Ground Source Heat Pump System (V.GSHPs)

Weather		Loads		GeoSmart Energy System					Auxiliary	
Air	Annual Hrs	Space Load	DHW	Geo	WF Air	WF DHW	WF Run	WF kWh	Space	DHW
°F	hours	Btuh/hr	Btuh/hr	°F	Btuh/hr	Btuh/hr	Time	kWh	kWh	kWh
87	9	26,953	2,427	63	26,953	1,870	100.0%	7	0	2
82	92	19,723	2,427	58	19,723	1,109	100.0%	48	0	39
77	227	12,493	2,427	54	13,090	591	95.4%	81	0	135
72	397	8,155	2,427	51	13,260	517	61.5%	88	0	267
67	588	0	2,427	50	0	0	0.0%	0	0	454
62	726	0	2,427	50	0	0	0.0%	0	0	561
57	732	0	2,427	50	0	0	0.0%	0	0	566
52	679	-2,655	2,427	51	8,826	970	30.1%	133	0	462
47	672	-5,357	2,427	50	8,590	943	62.4%	269	0	393
42	601	-8,060	2,427	48	9,441	1,071	85.4%	363	0	289
37	649	-10,762	2,427	47	11,798	1,416	91.2%	519	0	235
32	834	-13,465	2,427	45	14,148	1,767	95.2%	834	0	198
27	676	-16,167	2,427	43	16,493	2,125	98.0%	817	0	74
22	551	-18,870	2,427	42	18,891	2,429	99.9%	782	0	0
17	437	-21,572	2,427	41	21,593	2,429	99.9%	704	0	0
12	357	-24,274	2,427	39	24,295	2,429	99.9%	646	0	0
7	238	-26,977	2,427	38	26,998	2,428	99.9%	479	0	0
2	157	-29,679	2,427	37	29,700	2,428	99.9%	349	0	0
-3	86	-32,382	2,427	35	32,402	2,428	99.9%	210	0	0
-8	42	-35,084	2,427	34	35,105	2,428	99.9%	112	0	0
-13	12	-37,787	2,427	33	37,807	2,428	99.9%	35	0	0
-18	1	-40,489	2,427	32	40,509	2,428	100.0%	3	0	0
-23	1	-43,192	2,427	30	43,211	2,428	100.0%	3	0	0
Totals	8764							6481	0	3,673

Table B1-1.7: Annual analysis of heating and cooling loads (in blue and red rectangular boxes on the left side) and vertical ground source heat pump (V.GSHP) unit covering the heating and cooling loads (in blue and red circular boxes on the right side) for a 2,000 square feet detached house above grade (average construction type) in the city of Guelph

Horizontal Ground Source Heat Pump System (H.GSHPs)

Weather		Loads		GeoSmart Energy System					Auxiliary	
Air °F	Annual Hrs hours	Space Load Btuh/hr	DHW Btuh/hr	Geo °F	WF Air Btuh/hr	WF DHW Btuh/hr	WF Run Time	WF KWH kWh	Space kWh	DHW kWh
87	9	26,953	2,427	62	26,953	1,807	100.0%	6	0	2
82	92	19,723	2,427	59	19,723	1,137	100.0%	49	0	38
77	227	12,493	2,427	56	12,975	641	96.3%	83	0	131
72	397	8,155	2,427	54	13,094	590	62.3%	92	0	260
67	588	0	2,427	50	0	0	0.0%	0	0	454
62	726	0	2,427	50	0	0	0.0%	0	0	561
57	732	0	2,427	50	0	0	0.0%	0	0	566
52	679	-2,655	2,427	47	8,162	896	32.5%	139	0	462
47	672	-5,357	2,427	46	7,999	878	67.0%	280	0	394
42	601	-8,060	2,427	45	9,423	1,088	85.5%	373	0	286
37	649	-10,762	2,427	44	11,776	1,437	91.4%	533	0	230
32	834	-13,465	2,427	43	14,125	1,790	95.3%	854	0	191
27	676	-16,167	2,427	42	16,470	2,147	98.2%	834	0	69
22	551	-18,870	2,427	40	18,890	2,429	99.9%	793	0	0
17	437	-21,572	2,427	40	21,593	2,429	99.9%	712	0	0
12	357	-24,274	2,427	39	24,295	2,429	99.9%	650	0	0
7	238	-26,977	2,427	38	26,998	2,428	99.9%	480	0	0
2	157	-29,679	2,427	37	29,700	2,428	99.9%	348	0	0
-3	86	-32,382	2,427	36	32,402	2,428	99.9%	208	0	0
-8	42	-35,084	2,427	35	35,105	2,428	99.9%	111	0	0
-13	12	-37,787	2,427	34	37,807	2,428	99.9%	34	0	0
-18	1	-40,489	2,427	33	40,509	2,428	99.9%	3	0	0
-23	1	-43,192	2,427	32	43,212	2,428	100.0%	3	0	0
Totals	8764							6584	0	3,643

Table B1-1.8: Annual analysis of heating and cooling loads (in blue and red rectangular boxes on the left side) and horizontal ground source heat pump (H.GSHP) unit covering the heating and cooling loads (in blue and red circular boxes on the right side) for a 2,000 square feet detached house above grade (average construction type) in the city of Guelph

Traditional HVAC Applications

Weather		Loads		Fossil Furnace System				Fuel Use		
Air Temp °F	Annual hours	Space Btuh/hr	HW Load Btuh/hr	Furnace Btuh/hr	Furn Run Time	AC Cap Btuh/hr	Clg Run Time	AC kWh	Furnace ccf	HW ccf
87	9	26,953	2,427	0	00.0%	27,174	99.2%	23	0	0
82	92	19,723	2,427	0	00.0%	27,952	70.6%	178	0	4
77	227	12,493	2,427	0	00.0%	28,730	43.5%	298	0	9
72	397	8,155	2,427	0	00.0%	29,508	27.6%	371	0	16
67	588	0	2,427	0	00.0%	0	00.0%	0	0	24
62	726	0	2,427	0	00.0%	0	00.0%	0	0	30
57	732	0	2,427	0	00.0%	0	00.0%	0	0	30
52	679	-2,655	2,427	3,333	06.1%	0	00.0%	0	23	28
47	672	-5,357	2,427	6,409	12.4%	0	00.0%	0	43	28
42	601	-8,060	2,427	9,471	18.7%	0	00.0%	0	57	25
37	649	-10,762	2,427	12,519	24.9%	0	00.0%	0	81	27
32	834	-13,465	2,427	15,552	31.2%	0	00.0%	0	130	35
27	676	-16,167	2,427	18,571	37.4%	0	00.0%	0	126	28
22	551	-18,870	2,427	21,577	43.7%	0	00.0%	0	119	23
17	437	-21,572	2,427	24,568	49.9%	0	00.0%	0	107	18
12	357	-24,274	2,427	27,545	56.2%	0	00.0%	0	98	15
7	238	-26,977	2,427	30,507	62.4%	0	00.0%	0	73	10
2	157	-29,679	2,427	33,456	68.7%	0	00.0%	0	53	7
-3	86	-32,382	2,427	36,391	75.0%	0	00.0%	0	31	4
-8	42	-35,084	2,427	39,311	81.2%	0	00.0%	0	17	2
-13	12	-37,787	2,427	42,217	87.5%	0	00.0%	0	5	0
-18	1	-40,489	2,427	45,110	93.7%	0	00.0%	0	0	0
-23	1	-43,192	2,427	47,988	100.0%	0	00.0%	0	0	0
Totals	8764							871	963	363

Table B1-1.9: Annual analysis of heating and cooling loads (in blue and red rectangular boxes on the left side) and traditional HVAC applications covering the heating and cooling loads (in blue and red circular boxes on the right side) for a 2,000 square feet detached house above grade (average construction type) in the city of Guelph

4. Hamilton (South) – Annual Hourly Heating and Cooling Loads Analysis and Coverage

Vertical Ground Source Heat Pump Systems (V.GSHPs)

Weather		Loads		GeoSmart Energy System					Auxiliary	
Air	Annual Hrs	Space Load	DHW	Geo	WF Air	WF DHW	WF Run	WF KWH	Space	DHW
°F	hours	Btuh/hr	Btuh/hr	°F	Btuh/hr	Btuh/hr	Time	kWh	kWh	kWh
97	1	35,165	2,357	71	35,165	2,357	100.0%	1	0	0
92	12	28,959	2,357	67	28,959	2,314	100.0%	10	0	0
87	93	22,753	2,357	63	22,753	1,539	100.0%	59	0	24
82	282	16,547	2,357	59	16,547	934	100.0%	130	0	128
77	505	10,341	2,357	54	13,043	612	79.3%	150	0	301
72	680	6,617	2,357	52	13,189	548	50.2%	125	0	451
67	732	0	2,357	52	0	0	0.0%	0	0	549
62	725	0	2,357	52	0	0	0.0%	0	0	544
57	688	-1,491	2,357	54	9,290	1,021	16.0%	74	0	480
52	620	-4,193	2,357	53	9,051	995	46.3%	189	0	374
47	586	-6,896	2,357	51	8,815	968	78.2%	298	0	298
42	628	-9,599	2,357	49	10,736	1,245	89.4%	440	0	249
37	793	-12,301	2,357	48	13,094	1,589	93.9%	709	0	218
32	792	-15,004	2,357	46	15,447	1,939	97.1%	866	0	119
27	600	-17,706	2,357	45	17,793	2,295	99.5%	780	0	14
22	438	-20,409	2,357	43	20,431	2,359	99.9%	652	0	0
17	340	-23,112	2,357	42	23,133	2,359	99.9%	570	0	0
12	244	-25,814	2,357	41	25,836	2,359	99.9%	457	0	0
7	142	-28,517	2,357	39	28,538	2,358	99.9%	294	0	0
2	71	-31,219	2,357	38	31,241	2,358	99.9%	162	0	0
-3	31	-33,922	2,357	37	33,943	2,358	99.9%	77	0	0
-8	10	-36,625	2,357	36	36,645	2,358	99.9%	27	0	0
-13	3	-39,327	2,357	34	39,348	2,358	99.9%	9	0	0
-18	1	-42,030	2,357	33	42,050	2,358	100.0%	3	0	0
Totals	9017							6084	0	3,751

Table B1-1.10: Annual analysis of heating and cooling loads (in blue and red rectangular boxes on the left side) and vertical ground source heat pump (V.GSHP) unit covering the heating and cooling loads (in blue and red circular boxes on the right side) for a 2,000 square feet detached house above grade (average construction type) in the city of Hamilton

Horizontal Ground Source Heat Pump System (H.GSHPs)

Weather		Loads		GeoSmart Energy System					Auxiliary	
Air °F	Annual Hrs hours	Space Load Btuh/hr	DHW Btuh/hr	Geo °F	WF Air Btuh/hr	WF DHW Btuh/hr	WF Run Time	WF KWH kWh	Space kWh	DHW kWh
97	1	35,165	2,357	69	35,165	2,357	100.0%	1	0	0
92	12	28,959	2,357	65	28,959	2,219	100.0%	10	0	1
87	93	22,753	2,357	63	22,753	1,544	100.0%	59	0	24
82	282	16,547	2,357	60	16,547	986	100.0%	133	0	123
77	505	10,341	2,357	57	12,896	676	80.2%	155	0	292
72	680	6,617	2,357	55	12,998	631	50.9%	131	0	441
67	732	0	2,357	52	0	0	0.0%	0	0	549
62	725	0	2,357	52	0	0	0.0%	0	0	544
57	688	-1,491	2,357	50	8,576	942	17.4%	77	0	481
52	620	-4,193	2,357	48	8,412	924	49.9%	197	0	374
47	586	-6,896	2,357	47	8,357	921	82.5%	308	0	298
42	628	-9,599	2,357	46	10,717	1,263	89.6%	452	0	245
37	793	-12,301	2,357	45	13,073	1,610	94.1%	727	0	213
32	792	-15,004	2,357	44	15,424	1,960	97.3%	885	0	113
27	600	-17,706	2,357	43	17,772	2,315	99.6%	794	0	9
22	438	-20,409	2,357	42	20,430	2,359	99.9%	660	0	0
17	340	-23,112	2,357	41	23,133	2,359	99.9%	576	0	0
12	244	-25,814	2,357	40	25,836	2,359	99.9%	459	0	0
7	142	-28,517	2,357	39	28,538	2,358	99.9%	295	0	0
2	71	-31,219	2,357	38	31,241	2,358	99.9%	161	0	0
-3	31	-33,922	2,357	37	33,943	2,358	99.9%	77	0	0
-8	10	-36,625	2,357	37	36,646	2,358	99.9%	27	0	0
-13	3	-39,327	2,357	36	39,348	2,358	99.9%	9	0	0
-18	1	-42,030	2,357	35	42,051	2,358	100.0%	3	0	0
Totals	9017							6194	0	3,708

Table B1-1.11: Annual analysis of heating and cooling loads (in blue and red rectangular boxes on the left side) and horizontal ground source heat pump (H.GSHP) unit covering the heating and cooling loads (in blue and red circular boxes on the right side) for a 2,000 square feet detached house above grade (average construction type) in the city of Hamilton

Traditional HVAC Applications

Weather		Loads		Fossil Furnace System				Fuel Use		
Air Temp °F	Annual hours	Space Btuh/hr	HW Load Btuh/hr	Furnace Btuh/hr	Furn Run Time	AC Cap Btuh/hr	Clg Run Time	AC kWh	Furnace ccf	HW ccf
97	1	35,165	2,357	0	00.0%	35,865	98.0%	4	0	0
92	12	28,959	2,357	0	00.0%	36,954	78.4%	37	0	0
87	93	22,753	2,357	0	00.0%	38,043	59.8%	228	0	4
82	282	16,547	2,357	0	00.0%	39,132	42.3%	521	0	11
77	505	10,341	2,357	0	00.0%	40,222	25.7%	646	0	20
72	680	6,617	2,357	0	00.0%	41,311	16.0%	638	0	27
67	732	0	2,357	0	00.0%	0	00.0%	0	0	30
62	725	0	2,357	0	00.0%	0	00.0%	0	0	29
57	688	-1,491	2,357	2,004	03.5%	0	00.0%	0	14	28
52	620	-4,193	2,357	5,086	09.7%	0	00.0%	0	32	25
47	586	-6,896	2,357	8,154	16.0%	0	00.0%	0	48	24
42	628	-9,599	2,357	11,208	22.2%	0	00.0%	0	70	25
37	793	-12,301	2,357	14,248	28.5%	0	00.0%	0	113	32
32	792	-15,004	2,357	17,273	34.7%	0	00.0%	0	137	32
27	600	-17,706	2,357	20,285	41.0%	0	00.0%	0	122	24
22	438	-20,409	2,357	23,282	47.2%	0	00.0%	0	102	18
17	340	-23,112	2,357	26,265	53.5%	0	00.0%	0	89	14
12	244	-25,814	2,357	29,234	59.8%	0	00.0%	0	71	10
7	142	-28,517	2,357	32,189	66.0%	0	00.0%	0	46	6
2	71	-31,219	2,357	35,130	72.3%	0	00.0%	0	25	3
-3	31	-33,922	2,357	38,057	78.5%	0	00.0%	0	12	1
-8	10	-36,625	2,357	40,969	84.8%	0	00.0%	0	4	0
-13	3	-39,327	2,357	43,868	91.0%	0	00.0%	0	1	0
-18	1	-42,030	2,357	46,752	97.3%	0	00.0%	0	0	0
Totals	9017							2073	886	364

Table B1-1.12: Annual analysis of heating and cooling loads (in blue and red rectangular boxes on the left side) and traditional HVAC applications covering the heating and cooling loads (in blue and red circular boxes on the right side) for a 2,000 square feet detached house above grade (average construction type) in the city of Hamilton

5. Kingston (South) – Annual Hourly Heating and Cooling Loads Analysis and Coverage
Vertical Ground Source Heat Pump System (V.GSHPs)

Weather		Loads		GeoSmart Energy System					Auxiliary	
Air °F	Annual Hrs hours	Space Load Btuh/hr	DHW Btuh/hr	Geo °F	WF Air Btuh/hr	WF DHW Btuh/hr	WF Run Time	WF KWH kWh	Space kWh	DHW kWh
92	1	45,901	2,466	70	45,901	2,466	100.0%	2	0	0
87	11	34,919	2,466	63	34,919	2,259	100.0%	14	0	1
82	72	23,938	2,466	57	23,938	1,305	100.0%	55	0	27
77	318	12,957	2,466	51	15,641	729	82.8%	120	0	189
72	644	6,368	2,466	47	15,875	612	40.1%	113	0	455
67	781	0	2,466	49	0	0	0.0%	0	0	613
62	779	0	2,466	49	0	0	0.0%	0	0	612
57	738	-1,739	2,466	50	10,500	1,563	16.6%	96	0	519
52	697	-4,441	2,466	49	10,244	1,529	43.4%	234	0	400
47	653	-7,143	2,466	48	9,989	1,495	71.5%	357	0	291
42	664	-9,846	2,466	47	10,747	1,597	91.6%	503	0	212
37	780	-12,548	2,466	46	13,126	1,920	95.6%	752	0	157
32	694	-15,250	2,466	44	15,499	2,249	98.4%	816	0	56
27	528	-17,953	2,466	43	17,980	2,470	99.8%	731	0	0
22	408	-20,655	2,466	42	20,682	2,469	99.9%	644	0	0
17	324	-23,357	2,466	41	23,385	2,469	99.9%	576	0	0
12	271	-26,059	2,466	40	26,087	2,469	99.9%	538	0	0
7	205	-28,762	2,466	39	28,789	2,468	99.9%	450	0	0
2	134	-31,464	2,466	38	31,491	2,468	99.9%	323	0	0
-3	77	-34,166	2,466	37	34,193	2,468	99.9%	202	0	0
-8	39	-36,869	2,466	36	36,895	2,468	99.9%	111	0	0
-13	17	-39,571	2,466	35	39,598	2,468	99.9%	52	0	0
-18	7	-42,273	2,466	34	42,300	2,468	99.9%	23	0	0
-23	2	-44,976	2,466	33	45,002	2,467	99.9%	7	0	0
Totals	8844							6720	0	3,531

Table B1-1.13: Annual analysis of heating and cooling loads (in blue and red rectangular boxes on the left side) and vertical ground source heat pump (V.GSHP) unit covering the heating and cooling loads (in blue and red circular boxes on the right side) for a 2,000 square feet detached house above grade (average construction type) in the city of Kingston

Horizontal Ground Source Heat Pump System (H.GSHPs)

Weather		Loads		GeoSmart Energy System					Auxiliary	
Air °F	Annual Hrs hours	Space Load Btuh/hr	DHW Btuh/hr	Geo °F	WF Air Btuh/hr	WF DHW Btuh/hr	WF Run Time	WF KWH kWh	Space kWh	DHW kWh
92	1	45,901	2,466	70	45,901	2,466	100.0%	1	0	0
87	11	34,919	2,466	64	34,919	2,466	100.0%	10	0	0
82	72	23,938	2,466	59	23,938	1,421	100.0%	45	0	24
77	318	12,957	2,466	54	13,042	612	99.3%	118	0	188
72	644	6,368	2,466	51	13,223	534	48.2%	113	0	453
67	781	0	2,466	49	0	0	0.0%	0	0	613
62	779	0	2,466	49	0	0	0.0%	0	0	612
57	738	-1,739	2,466	46	8,027	881	21.7%	99	0	535
52	697	-4,441	2,466	45	7,865	863	56.5%	243	0	439
47	653	-7,143	2,466	44	8,651	982	82.6%	365	0	344
42	664	-9,846	2,466	43	11,004	1,332	89.5%	505	0	269
37	780	-12,548	2,466	42	13,352	1,686	94.0%	754	0	219
32	694	-15,250	2,466	41	15,695	2,044	97.2%	817	0	106
27	528	-17,953	2,466	40	18,034	2,408	99.5%	735	0	12
22	408	-20,655	2,466	39	20,675	2,468	99.9%	647	0	0
17	324	-23,357	2,466	38	23,378	2,468	99.9%	577	0	0
12	271	-26,059	2,466	37	26,080	2,468	99.9%	536	0	0
7	205	-28,762	2,466	36	28,782	2,468	99.9%	447	0	0
2	134	-31,464	2,466	35	31,484	2,468	99.9%	320	0	0
-3	77	-34,166	2,466	34	34,187	2,467	99.9%	200	0	0
-8	39	-36,869	2,466	33	36,889	2,467	99.9%	110	0	0
-13	17	-39,571	2,466	32	39,591	2,467	99.9%	52	0	0
-18	7	-42,273	2,466	31	42,293	2,467	100.0%	23	0	0
-23	2	-44,976	2,466	31	44,995	2,467	100.0%	7	0	0
Totals	8844							6725	0	3,815

Table B1-1.14: Annual analysis of heating and cooling loads (in blue and red rectangular boxes on the left side) and horizontal ground source heat pump (H.GSHP) unit covering the heating and cooling loads (in blue and red circular boxes on the right side) for a 2,000 square feet detached house above grade (average construction type) in the city of Kingston

Traditional HVAC Applications

Weather		Loads		Fossil Furnace System				Fuel Use		
Air Temp °F	Annual hours	Space Btuh/hr	HW Load Btuh/hr	Furnace Btuh/hr	Furn Run Time	AC Cap Btuh/hr	Clg Run Time	AC kWh	Furnace ccf	HW ccf
92	1	45,901	2,466	0	00.0%	47,512	96.6%	5	0	0
87	11	34,919	2,466	0	00.0%	48,913	71.4%	40	0	0
82	72	23,938	2,466	0	00.0%	50,313	47.6%	187	0	3
77	318	12,957	2,466	0	00.0%	51,714	25.1%	514	0	13
72	644	6,368	2,466	0	00.0%	53,114	12.0%	668	0	27
67	781	0	2,466	0	00.0%	0	00.0%	0	0	33
62	779	0	2,466	0	00.0%	0	00.0%	0	0	33
57	738	-1,739	2,466	2,287	04.0%	0	00.0%	0	17	31
52	697	-4,441	2,466	5,368	10.3%	0	00.0%	0	37	29
47	653	-7,143	2,466	8,434	16.5%	0	00.0%	0	55	27
42	664	-9,846	2,466	11,486	22.8%	0	00.0%	0	76	28
37	780	-12,548	2,466	14,524	29.0%	0	00.0%	0	113	33
32	694	-15,250	2,466	17,548	35.3%	0	00.0%	0	122	29
27	528	-17,953	2,466	20,558	41.6%	0	00.0%	0	109	22
22	408	-20,655	2,466	23,554	47.8%	0	00.0%	0	96	17
17	324	-23,357	2,466	26,536	54.1%	0	00.0%	0	86	14
12	271	-26,059	2,466	29,503	60.3%	0	00.0%	0	80	11
7	205	-28,762	2,466	32,457	66.6%	0	00.0%	0	67	9
2	134	-31,464	2,466	35,396	72.8%	0	00.0%	0	47	6
-3	77	-34,166	2,466	38,321	79.1%	0	00.0%	0	30	3
-8	39	-36,869	2,466	41,232	85.3%	0	00.0%	0	16	2
-13	17	-39,571	2,466	44,129	91.6%	0	00.0%	0	8	1
-18	7	-42,273	2,466	47,011	97.9%	0	00.0%	0	3	0
-23	2	-44,976	2,466	47,997	100.0%	0	00.0%	0	1	0
Totals	8844							1413	963	372

Table B1-1.15: Annual analysis of heating and cooling loads (in blue and red rectangular boxes on the left side) and traditional HVAC applications covering the heating and cooling loads (in blue and red circular boxes on the right side) for a 2,000 square feet detached house above grade (average construction type) in the city of Kingston

6. Kitchener-Waterloo (South) – Annual Hourly Heating and Cooling Loads Analysis and Coverage

Vertical Ground Source Heat Pump Systems (V.GSHPs)

Weather		Loads		GeoSmart Energy System					Auxiliary	
Air °F	Annual Hrs hours	Space Load Btuh/hr	DHW Btuh/hr	Geo °F	WF Air Btuh/hr	WF DHW Btuh/hr	WF Run Time	WF kWh	Space kWh	DHW kWh
92	6	36,054	2,427	65	36,054	2,427	100.0%	8	0	0
87	70	27,700	2,427	60	27,700	1,678	100.0%	66	0	17
82	230	19,345	2,427	56	19,345	1,050	100.0%	140	0	101
77	440	10,991	2,427	51	15,627	737	70.3%	141	0	267
72	620	5,978	2,427	48	15,805	647	37.8%	104	0	431
67	696	0	2,427	50	0	0	0.0%	0	0	538
62	711	0	2,427	50	0	0	0.0%	0	0	549
57	677	-2,129	2,427	52	10,729	1,594	19.8%	106	0	455
52	642	-4,832	2,427	50	10,472	1,560	46.1%	232	0	349
47	591	-7,534	2,427	49	10,216	1,525	73.7%	337	0	245
42	595	-10,236	2,427	48	11,058	1,637	92.6%	463	0	173
37	730	-12,939	2,427	47	13,439	1,958	96.3%	717	0	126
32	768	-15,641	2,427	45	15,815	2,285	98.9%	914	0	41
27	623	-18,344	2,427	44	18,371	2,430	99.8%	866	0	0
22	468	-21,046	2,427	43	21,074	2,430	99.9%	740	0	0
17	370	-23,749	2,427	42	23,776	2,429	99.9%	658	0	0
12	262	-26,451	2,427	41	26,479	2,429	99.9%	519	0	0
7	162	-29,153	2,427	40	29,181	2,429	99.9%	354	0	0
2	92	-31,856	2,427	39	31,883	2,429	99.9%	221	0	0
-3	44	-34,558	2,427	38	34,586	2,428	99.9%	115	0	0
-8	18	-37,261	2,427	37	37,288	2,428	99.9%	51	0	0
-13	6	-39,963	2,427	36	39,990	2,428	99.9%	18	0	0
-18	2	-42,666	2,427	35	42,692	2,428	99.9%	7	0	0
-23	1	-45,368	2,427	34	45,394	2,428	99.9%	4	0	0
Totals	8824							6782	0	3,291

Table B1-1.16: Annual analysis of heating and cooling loads (in blue and red rectangular boxes on the left side) and vertical ground source heat pump (V.GSHP) unit covering the heating and cooling loads (in blue and red circular boxes on the right side) for a 2,000 square feet detached house above grade (average construction type) in the city of Kitchener-Waterloo

Horizontal Ground Source Heat Pump Systems (H.GSHPs)

Weather		Loads		GeoSmart Energy System					Auxiliary	
Air °F	Annual Hrs hours	Space Load Btuh/hr	DHW Btuh/hr	Geo °F	WF Air Btuh/hr	WF DHW Btuh/hr	WF Run Time	WF kWh	Space kWh	DHW kWh
92	6	36,054	2,427	67	36,054	2,427	100.0%	6	0	0
87	70	27,700	2,427	63	27,700	1,885	100.0%	52	0	12
82	230	19,345	2,427	59	19,345	1,106	100.0%	119	0	97
77	440	10,991	2,427	55	13,016	623	84.4%	140	0	266
72	620	5,978	2,427	53	13,153	564	45.4%	104	0	429
67	696	0	2,427	50	0	0	0.0%	0	0	538
62	711	0	2,427	50	0	0	0.0%	0	0	549
57	677	-2,129	2,427	47	8,193	899	26.0%	111	0	473
52	642	-4,832	2,427	46	8,031	881	60.2%	240	0	388
47	591	-7,534	2,427	45	8,964	1,021	84.0%	344	0	295
42	595	-10,236	2,427	44	11,318	1,369	90.4%	465	0	225
37	730	-12,939	2,427	43	13,668	1,721	94.7%	719	0	185
32	768	-15,641	2,427	42	16,014	2,077	97.7%	915	0	97
27	623	-18,344	2,427	41	18,364	2,429	99.9%	875	0	0
22	468	-21,046	2,427	40	21,067	2,429	99.9%	745	0	0
17	370	-23,749	2,427	39	23,769	2,429	99.9%	660	0	0
12	262	-26,451	2,427	38	26,472	2,428	99.9%	518	0	0
7	162	-29,153	2,427	37	29,174	2,428	99.9%	353	0	0
2	92	-31,856	2,427	36	31,877	2,428	99.9%	219	0	0
-3	44	-34,558	2,427	35	34,579	2,428	99.9%	114	0	0
-8	18	-37,261	2,427	34	37,281	2,428	99.9%	50	0	0
-13	6	-39,963	2,427	33	39,983	2,428	99.9%	18	0	0
-18	2	-42,666	2,427	32	42,686	2,428	100.0%	6	0	0
-23	1	-45,368	2,427	32	45,388	2,428	100.0%	3	0	0
Totals	8824							6777	0	3,555

Table B1-1.17: Annual analysis of heating and cooling loads (in blue and red rectangular boxes on the left side) and horizontal ground source heat pump (H.GSHP) unit covering the heating and cooling loads (in blue and red circular boxes on the right side) for a 2,000 square feet detached house above grade (average construction type) in the city of Kitchener-Waterloo

Traditional HVAC Applications

Weather		Loads		Fossil Furnace System				Fuel Use		
Air Temp °F	Annual hours	Space Btuh/hr	HW Load Btuh/hr	Furnace Btuh/hr	Furn Run Time	AC Cap Btuh/hr	Clg Run Time	AC kWh	Furnace ccf	HW ccf
92	6	36,054	2,427	0	00.0%	36,954	97.6%	22	0	0
87	70	27,700	2,427	0	00.0%	38,043	72.8%	199	0	3
82	230	19,345	2,427	0	00.0%	39,132	49.4%	477	0	10
77	440	10,991	2,427	0	00.0%	40,222	27.3%	585	0	18
72	620	5,978	2,427	0	00.0%	41,311	14.5%	550	0	26
67	696	0	2,427	0	00.0%	0	00.0%	0	0	29
62	711	0	2,427	0	00.0%	0	00.0%	0	0	29
57	677	-2,129	2,427	2,733	04.9%	0	00.0%	0	19	28
52	642	-4,832	2,427	5,812	11.2%	0	00.0%	0	37	27
47	591	-7,534	2,427	8,876	17.4%	0	00.0%	0	52	24
42	595	-10,236	2,427	11,927	23.7%	0	00.0%	0	71	25
37	730	-12,939	2,427	14,963	30.0%	0	00.0%	0	109	30
32	768	-15,641	2,427	17,985	36.2%	0	00.0%	0	138	32
27	623	-18,344	2,427	20,993	42.5%	0	00.0%	0	131	26
22	468	-21,046	2,427	23,987	48.7%	0	00.0%	0	112	19
17	370	-23,749	2,427	26,966	55.0%	0	00.0%	0	100	15
12	262	-26,451	2,427	29,932	61.2%	0	00.0%	0	78	11
7	162	-29,153	2,427	32,883	67.5%	0	00.0%	0	53	7
2	92	-31,856	2,427	35,821	73.7%	0	00.0%	0	33	4
-3	44	-34,558	2,427	38,744	80.0%	0	00.0%	0	17	2
-8	18	-37,261	2,427	41,653	86.3%	0	00.0%	0	7	1
-13	6	-39,963	2,427	44,548	92.5%	0	00.0%	0	3	0
-18	2	-42,666	2,427	47,429	98.8%	0	00.0%	0	1	0
-23	1	-45,368	2,427	47,997	100.0%	0	00.0%	0	0	0
Totals	8824							1834	963	366

Table B1-1.18: Annual analysis of heating and cooling loads (in blue and red rectangular boxes on the left side) and traditional HVAC applications covering the heating and cooling loads (in blue and red circular boxes on the right side) for a 2,000 square feet detached house above grade (average construction type) in the city of Kitchener-Waterloo

7. London (South) – Annual Hourly Heating and Cooling Loads Analysis and Coverage
Vertical Ground Source Heat Pump Systems (V.GSHPs)

Weather		Loads		GeoSmart Energy System					Auxiliary	
Air °F	Annual Hrs hours	Space Load Btuh/hr	DHW Btuh/hr	Geo °F	WF Air Btuh/hr	WF DHW Btuh/hr	WF Run Time	WF KWH kWh	Space kWh	DHW kWh
92	3	32,327	2,424	67	32,327	2,424	100.0%	3	0	0
87	52	25,259	2,424	62	25,259	1,678	100.0%	35	0	12
82	169	18,190	2,424	57	18,190	981	100.0%	82	0	78
77	343	11,122	2,424	53	13,138	571	84.7%	107	0	212
72	554	6,881	2,424	50	13,304	498	51.7%	103	0	382
67	719	0	2,424	50	0	0	0.0%	0	0	555
62	735	0	2,424	50	0	0	0.0%	0	0	567
57	679	-1,226	2,424	52	8,967	985	13.7%	61	0	495
52	658	-3,928	2,424	51	8,730	959	45.0%	192	0	417
47	594	-6,630	2,424	49	8,495	933	78.0%	296	0	321
42	590	-9,332	2,424	47	10,549	1,232	88.5%	410	0	251
37	707	-12,035	2,424	46	12,903	1,580	93.3%	631	0	214
32	898	-14,737	2,424	44	15,251	1,934	96.6%	985	0	159
27	671	-17,439	2,424	43	17,592	2,294	99.1%	878	0	32
22	466	-20,141	2,424	41	20,162	2,426	99.9%	702	0	0
17	339	-22,843	2,424	40	22,864	2,426	99.9%	577	0	0
12	258	-25,545	2,424	39	25,566	2,425	99.9%	491	0	0
7	172	-28,247	2,424	37	28,268	2,425	99.9%	362	0	0
2	91	-30,950	2,424	36	30,970	2,425	99.9%	211	0	0
-3	49	-33,652	2,424	35	33,672	2,425	99.9%	124	0	0
-8	16	-36,354	2,424	34	36,374	2,425	99.9%	44	0	0
-13	3	-39,056	2,424	32	39,076	2,425	99.9%	9	0	0
Totals	8766							6303	0	3,695

Table B1-1.19: Annual analysis of heating and cooling loads (in blue and red rectangular boxes on the left side) and vertical ground source heat pump (V.GSHP) unit covering the heating and cooling loads (in blue and red circular boxes on the right side) for a 2,000 square feet detached house above grade (average construction type) in the city of London

Horizontal Ground Source Heat Pump System (H.GSHPs)

Weather		Loads		GeoSmart Energy System					Auxiliary	
Air °F	Annual Hrs hours	Space Load Btuh/hr	DHW Btuh/hr	Geo °F	WF Air Btuh/hr	WF DHW Btuh/hr	WF Run Time	WF KWH kWh	Space kWh	DHW kWh
92	3	32,327	2,424	65	32,327	2,400	100.0%	3	0	0
87	52	25,259	2,424	61	25,259	1,630	100.0%	35	0	13
82	169	18,190	2,424	58	18,190	1,011	100.0%	83	0	76
77	343	11,122	2,424	55	13,018	623	85.4%	110	0	207
72	554	6,881	2,424	53	13,134	572	52.4%	107	0	375
67	719	0	2,424	50	0	0	0.0%	0	0	555
62	735	0	2,424	50	0	0	0.0%	0	0	567
57	679	-1,226	2,424	48	8,293	910	14.8%	63	0	495
52	658	-3,928	2,424	47	8,130	892	48.3%	199	0	418
47	594	-6,630	2,424	46	8,174	904	81.1%	306	0	320
42	590	-9,332	2,424	45	10,531	1,250	88.6%	420	0	247
37	707	-12,035	2,424	43	12,882	1,600	93.4%	646	0	209
32	898	-14,737	2,424	42	15,230	1,954	96.8%	1005	0	152
27	671	-17,439	2,424	41	17,573	2,313	99.2%	892	0	27
22	466	-20,141	2,424	40	20,162	2,426	99.9%	710	0	0
17	339	-22,843	2,424	39	22,864	2,426	99.9%	581	0	0
12	258	-25,545	2,424	38	25,566	2,425	99.9%	492	0	0
7	172	-28,247	2,424	38	28,268	2,425	99.9%	362	0	0
2	91	-30,950	2,424	37	30,970	2,425	99.9%	210	0	0
-3	49	-33,652	2,424	36	33,672	2,425	99.9%	123	0	0
-8	16	-36,354	2,424	35	36,374	2,425	99.9%	44	0	0
-13	3	-39,056	2,424	34	39,077	2,425	99.9%	9	0	0
Totals	8766							6398	0	3,661

Table B1-1.20: Annual analysis of heating and cooling loads (in blue and red rectangular boxes on the left side) and horizontal ground source heat pump (H.GSHP) unit covering the heating and cooling loads (in blue and red circular boxes on the right side) for a 2,000 square feet detached house above grade (average construction type) in the city of London

Traditional HVAC Applications

Weather		Loads		Fossil Furnace System				Fuel Use		
Air Temp °F	Annual hours	Space Btuh/hr	HW Load Btuh/hr	Furnace Btuh/hr	Furn Run Time	AC Cap Btuh/hr	Clg Run Time	AC kWh	Furnace ccf	HW ccf
92	3	32,327	2,424	0	00.0%	36,954	87.5%	10	0	0
87	52	25,259	2,424	0	00.0%	38,043	66.4%	138	0	2
82	169	18,190	2,424	0	00.0%	39,132	46.5%	335	0	7
77	343	11,122	2,424	0	00.0%	40,222	27.7%	460	0	14
72	554	6,881	2,424	0	00.0%	41,311	16.7%	531	0	23
67	719	0	2,424	0	00.0%	0	00.0%	0	0	30
62	735	0	2,424	0	00.0%	0	00.0%	0	0	30
57	679	-1,226	2,424	1,664	03.2%	0	00.0%	0	11	28
52	658	-3,928	2,424	4,745	10.4%	0	00.0%	0	31	27
47	594	-6,630	2,424	7,810	17.5%	0	00.0%	0	46	25
42	590	-9,332	2,424	10,858	24.7%	0	00.0%	0	64	24
37	707	-12,035	2,424	13,891	31.8%	0	00.0%	0	98	29
32	898	-14,737	2,424	16,908	39.0%	0	00.0%	0	152	37
27	671	-17,439	2,424	19,908	46.1%	0	00.0%	0	134	28
22	466	-20,141	2,424	22,892	53.3%	0	00.0%	0	107	19
17	339	-22,843	2,424	25,860	60.4%	0	00.0%	0	88	14
12	258	-25,545	2,424	28,812	67.6%	0	00.0%	0	74	11
7	172	-28,247	2,424	31,748	74.7%	0	00.0%	0	55	7
2	91	-30,950	2,424	34,668	81.9%	0	00.0%	0	32	4
-3	49	-33,652	2,424	37,571	89.0%	0	00.0%	0	18	2
-8	16	-36,354	2,424	40,458	96.2%	0	00.0%	0	6	1
-13	3	-39,056	2,424	41,997	100.0%	0	00.0%	0	1	0
Totals	8766							1474	918	363

Table B1-1.21: Annual analysis of heating and cooling loads (in blue and red rectangular boxes on the left side) and traditional HVAC applications covering the heating and cooling loads (in blue and red circular boxes on the right side) for a 2,000 square feet detached house above grade (average construction type) in the city of London

8. Mount Forest (South) – Annual Hourly Heating and Cooling Loads Analysis and Coverage

Vertical Ground Source Heat Pump System (V.GSHPs)

Weather		Loads		GeoSmart Energy System					Auxiliary	
Air °F	Annual Hrs hours	Space Load Btuh/hr	DHW Btuh/hr	Geo °F	WF Air Btuh/hr	WF DHW Btuh/hr	WF Run Time	WF KWH kWh	Space kWh	DHW kWh
92	1	36,267	2,427	70	36,267	2,427	100.0%	1	0	0
87	20	28,006	2,427	64	28,006	2,000	100.0%	15	0	3
82	104	19,746	2,427	58	19,746	1,111	100.0%	54	0	44
77	248	11,485	2,427	53	13,129	574	87.5%	80	0	152
72	426	6,529	2,427	50	13,324	490	49.0%	75	0	297
67	590	0	2,427	50	0	0	0.0%	0	0	456
62	697	0	2,427	50	0	0	0.0%	0	0	539
57	710	-1,579	2,427	52	8,920	980	17.7%	82	0	509
52	665	-4,281	2,427	50	8,684	954	49.3%	212	0	414
47	624	-6,984	2,427	49	8,501	935	82.2%	329	0	330
42	594	-9,686	2,427	47	10,860	1,278	89.2%	428	0	243
37	688	-12,389	2,427	46	13,213	1,627	93.8%	633	0	197
32	769	-15,091	2,427	44	15,560	1,982	97.0%	865	0	124
27	679	-17,794	2,427	42	17,901	2,343	99.4%	908	0	21
22	533	-20,496	2,427	41	20,517	2,429	99.9%	818	0	0
17	443	-23,199	2,427	40	23,220	2,429	99.9%	766	0	0
12	344	-25,901	2,427	38	25,922	2,429	99.9%	664	0	0
7	235	-28,604	2,427	37	28,624	2,428	99.9%	502	0	0
2	147	-31,306	2,427	36	31,327	2,428	99.9%	346	0	0
-3	79	-34,009	2,427	35	34,029	2,428	99.9%	203	0	0
-8	37	-36,711	2,427	33	36,731	2,428	99.9%	104	0	0
-13	13	-39,414	2,427	32	39,434	2,428	99.9%	39	0	0
-18	3	-42,116	2,427	31	42,136	2,428	100.0%	10	0	0
-23	1	-44,819	2,427	30	44,838	2,428	100.0%	4	0	0
Totals	8650							7138	0	3,328

Table B1-1.22: Annual analysis of heating and cooling loads (in blue and red rectangular boxes on the left side) and vertical ground source heat pump (V.GSHP) unit covering the heating and cooling loads (in blue and red circular boxes on the right side) for a 2,000 square feet detached house above grade (average construction type) in the city of Mount Forest

Horizontal Ground Source Heat Pump System (H.GSHPs)

Weather		Loads		GeoSmart Energy System					Auxiliary	
Air °F	Annual Hrs hours	Space Load Btuh/hr	DHW Btuh/hr	Geo °F	WF Air Btuh/hr	WF DHW Btuh/hr	WF Run Time	WF Kw/H kWh	Space kWh	DHW kWh
92	1	36,267	2,427	67	36,267	2,427	100.0%	1	0	0
87	20	28,006	2,427	63	28,006	1,917	100.0%	15	0	3
82	104	19,746	2,427	59	19,746	1,139	100.0%	55	0	43
77	248	11,485	2,427	55	13,003	629	88.3%	83	0	148
72	426	6,529	2,427	53	13,138	570	49.7%	78	0	291
67	590	0	2,427	50	0	0	0.0%	0	0	456
62	697	0	2,427	50	0	0	0.0%	0	0	539
57	710	-1,579	2,427	47	8,227	903	19.2%	86	0	510
52	665	-4,281	2,427	46	8,064	885	53.1%	220	0	414
47	624	-6,984	2,427	45	8,484	951	82.3%	338	0	327
42	594	-9,686	2,427	44	10,839	1,298	89.4%	440	0	240
37	688	-12,389	2,427	43	13,190	1,649	93.9%	649	0	192
32	769	-15,091	2,427	42	15,537	2,004	97.1%	884	0	117
27	679	-17,794	2,427	41	17,879	2,364	99.5%	924	0	16
22	533	-20,496	2,427	40	20,517	2,429	99.9%	828	0	0
17	443	-23,199	2,427	39	23,219	2,429	99.9%	772	0	0
12	344	-25,901	2,427	38	25,922	2,428	99.9%	667	0	0
7	235	-28,604	2,427	37	28,624	2,428	99.9%	502	0	0
2	147	-31,306	2,427	36	31,327	2,428	99.9%	344	0	0
-3	79	-34,009	2,427	35	34,029	2,428	99.9%	201	0	0
-8	37	-36,711	2,427	34	36,732	2,428	99.9%	102	0	0
-13	13	-39,414	2,427	34	39,434	2,428	99.9%	39	0	0
-18	3	-42,116	2,427	33	42,136	2,428	100.0%	10	0	0
-23	1	-44,819	2,427	32	44,839	2,428	100.0%	3	0	0
Totals	8650							7240	0	3,295

Table B1-1.23: Annual analysis of heating and cooling loads (in blue and red rectangular boxes on the left side) and horizontal ground source heat pump (H.GSHP) unit covering the heating and cooling loads (in blue and red circular boxes on the right side) for a 2,000 square feet detached house above grade (average construction type) in the city of Mount Forest

Traditional HVAC Applications

Weather		Loads		Fossil Furnace System				Fuel Use		
Air Temp °F	Annual hours	Space Btuh/hr	HW Load Btuh/hr	Furnace Btuh/hr	Furn Run Time	AC Cap Btuh/hr	Clg Run Time	AC kWh	Furnace ccf	HW ccf
92	1	36,267	2,427	0	00.0%	36,954	98.1%	4	0	0
87	20	28,006	2,427	0	00.0%	38,043	73.6%	57	0	1
82	104	19,746	2,427	0	00.0%	39,132	50.5%	219	0	4
77	248	11,485	2,427	0	00.0%	40,222	28.6%	340	0	10
72	426	6,529	2,427	0	00.0%	41,311	15.8%	396	0	18
67	590	0	2,427	0	00.0%	0	00.0%	0	0	24
62	697	0	2,427	0	00.0%	0	00.0%	0	0	29
57	710	-1,579	2,427	2,104	03.7%	0	00.0%	0	15	29
52	665	-4,281	2,427	5,186	09.9%	0	00.0%	0	34	28
47	624	-6,984	2,427	8,253	16.2%	0	00.0%	0	52	26
42	594	-9,686	2,427	11,307	22.4%	0	00.0%	0	67	25
37	688	-12,389	2,427	14,346	28.7%	0	00.0%	0	99	29
32	769	-15,091	2,427	17,371	34.9%	0	00.0%	0	134	32
27	679	-17,794	2,427	20,382	41.2%	0	00.0%	0	138	28
22	533	-20,496	2,427	23,379	47.4%	0	00.0%	0	125	22
17	443	-23,199	2,427	26,361	53.7%	0	00.0%	0	117	18
12	344	-25,901	2,427	29,330	60.0%	0	00.0%	0	101	14
7	235	-28,604	2,427	32,284	66.2%	0	00.0%	0	76	10
2	147	-31,306	2,427	35,224	72.5%	0	00.0%	0	52	6
-3	79	-34,009	2,427	38,150	78.7%	0	00.0%	0	30	3
-8	37	-36,711	2,427	41,062	85.0%	0	00.0%	0	15	2
-13	13	-39,414	2,427	43,960	91.2%	0	00.0%	0	6	1
-18	3	-42,116	2,427	46,844	97.5%	0	00.0%	0	1	0
-23	1	-44,819	2,427	47,997	100.0%	0	00.0%	0	0	0
Totals	8650							1016	1,062	359

Table B1-1.24: Annual analysis of heating and cooling loads (in blue and red rectangular boxes on the left side) and traditional HVAC applications covering the heating and cooling loads (in blue and red circular boxes on the right side) for a 2,000 square feet detached house above grade (average construction type) in the city of Mount Forest

9. Niagara Falls (South) – Annual Hourly Heating and Cooling Loads Analysis and Coverage
Vertical Ground Source Heat Pump System (V.GSHPs)

Weather		Loads		GeoSmart Energy System					Auxiliary	
Air	Annual Hrs	Space Load	DHW	Geo	WF Air	WF DHW	WF Run	WF Kw/H	Space	DHW
°F	hours	Btuh/hr	Btuh/hr	°F	Btuh/hr	Btuh/hr	Time	kWh	kWh	kWh
97	1	39,128	2,393	73	39,128	2,393	100.0%	1	0	0
92	15	31,983	2,393	68	31,983	2,393	100.0%	14	0	0
87	76	24,838	2,393	63	24,838	1,698	100.0%	52	0	17
82	232	17,693	2,393	58	17,693	982	100.0%	112	0	104
77	396	10,548	2,393	53	13,103	586	80.5%	118	0	242
72	621	6,261	2,393	50	13,271	512	47.2%	106	0	425
67	755	0	2,393	51	0	0	0.0%	0	0	575
62	771	0	2,393	51	0	0	0.0%	0	0	588
57	752	-1,846	2,393	53	9,070	997	20.3%	101	0	525
52	727	-4,548	2,393	51	8,833	970	51.5%	244	0	438
47	643	-7,250	2,393	50	8,709	960	83.2%	348	0	326
42	684	-9,953	2,393	48	11,070	1,301	89.9%	501	0	266
37	796	-12,655	2,393	47	13,425	1,648	94.3%	740	0	213
32	821	-15,357	2,393	45	15,773	2,001	97.4%	930	0	116
27	605	-18,059	2,393	43	18,116	2,361	99.7%	813	0	8
22	427	-20,762	2,393	42	20,783	2,396	99.9%	655	0	0
17	230	-23,464	2,393	41	23,485	2,395	99.9%	397	0	0
12	125	-26,166	2,393	39	26,188	2,395	99.9%	241	0	0
7	66	-28,869	2,393	38	28,890	2,395	99.9%	141	0	0
2	19	-31,571	2,393	37	31,592	2,395	99.9%	44	0	0
-3	2	-34,273	2,393	36	34,294	2,395	99.9%	5	0	0
Totals	8764							5563	0	3,845

Table B1-1.25: Annual analysis of heating and cooling loads (in blue and red rectangular boxes on the left side) and vertical ground source heat pump (V.GSHP) unit covering the heating and cooling loads (in blue and red circular boxes on the right side) for a 2,000 square feet detached house above grade (average construction type) in the city of Niagara Falls

Horizontal Ground Source Heat Pump System (H.GSHPs)

Weather		Loads		GeoSmart Energy System					Auxiliary	
Air	Annual Hrs	Space Load	DHW	Geo	WF Air	WF DHW	WF Run	WF KWH	Space	DHW
°F	hours	Btuh/hr	Btuh/hr	°F	Btuh/hr	Btuh/hr	Time	kWh	kWh	kWh
97	1	39,128	2,393	69	39,128	2,393	100.0%	1	0	0
92	15	31,983	2,393	66	31,983	2,393	100.0%	13	0	0
87	76	24,838	2,393	62	24,838	1,662	100.0%	51	0	18
82	232	17,693	2,393	59	17,693	1,019	100.0%	113	0	102
77	396	10,548	2,393	56	12,971	643	81.3%	122	0	236
72	621	6,261	2,393	54	13,088	592	47.8%	111	0	417
67	755	0	2,393	51	0	0	0.0%	0	0	575
62	771	0	2,393	51	0	0	0.0%	0	0	588
57	752	-1,846	2,393	48	8,398	922	22.0%	105	0	525
52	727	-4,548	2,393	47	8,235	904	55.2%	253	0	439
47	643	-7,250	2,393	46	8,694	975	83.4%	357	0	324
42	684	-9,953	2,393	45	11,051	1,320	90.1%	514	0	262
37	796	-12,655	2,393	44	13,404	1,669	94.4%	757	0	207
32	821	-15,357	2,393	43	15,752	2,022	97.5%	949	0	110
27	605	-18,059	2,393	42	18,097	2,380	99.8%	825	0	4
22	427	-20,762	2,393	41	20,783	2,396	99.9%	662	0	0
17	230	-23,464	2,393	40	23,485	2,395	99.9%	400	0	0
12	125	-26,166	2,393	39	26,188	2,395	99.9%	241	0	0
7	66	-28,869	2,393	38	28,890	2,395	99.9%	140	0	0
2	19	-31,571	2,393	37	31,592	2,395	99.9%	44	0	0
-3	2	-34,273	2,393	36	34,294	2,395	99.9%	5	0	0
Totals	8764							5665	0	3,806

Table B1-1.26: Annual analysis of heating and cooling loads (in blue and red rectangular boxes on the left side) and horizontal ground source heat pump (H.GSHP) unit covering the heating and cooling loads (in blue and red circular boxes on the right side) for a 2,000 square feet detached house above grade (average construction type) in the city of Niagara Falls

Traditional HVAC Applications

Weather		Loads		Fossil Furnace System				Fuel Use		
Air Temp	Annual	Space	HW Load	Furnace	Furn Run	AC Cap	Clg Run	AC	Furnace	HW
°F	hours	Btuh/hr	Btuh/hr	Btuh/hr	Time	Btuh/hr	Time	kWh	ccf	ccf
97	1	39,128	2,393	0	00.0%	40,988	95.5%	4	0	0
92	15	31,983	2,393	0	00.0%	42,233	75.7%	52	0	1
87	76	24,838	2,393	0	00.0%	43,478	57.1%	206	0	3
82	232	17,693	2,393	0	00.0%	44,723	39.6%	467	0	9
77	396	10,548	2,393	0	00.0%	45,968	22.9%	538	0	16
72	621	6,261	2,393	0	00.0%	47,212	13.3%	602	0	25
67	755	0	2,393	0	00.0%	0	00.0%	0	0	31
62	771	0	2,393	0	00.0%	0	00.0%	0	0	32
57	752	-1,846	2,393	2,334	05.7%	0	00.0%	0	18	31
52	727	-4,548	2,393	5,408	14.0%	0	00.0%	0	39	30
47	643	-7,250	2,393	8,464	22.4%	0	00.0%	0	54	26
42	684	-9,953	2,393	11,500	30.7%	0	00.0%	0	79	28
37	796	-12,655	2,393	14,518	39.1%	0	00.0%	0	116	33
32	821	-15,357	2,393	17,517	47.4%	0	00.0%	0	144	34
27	605	-18,059	2,393	20,498	55.7%	0	00.0%	0	124	25
22	427	-20,762	2,393	23,459	64.1%	0	00.0%	0	100	17
17	230	-23,464	2,393	26,401	72.4%	0	00.0%	0	61	9
12	125	-26,166	2,393	29,325	80.8%	0	00.0%	0	37	5
7	66	-28,869	2,393	32,230	89.1%	0	00.0%	0	21	3
2	19	-31,571	2,393	35,116	97.4%	0	00.0%	0	7	1
-3	2	-34,273	2,393	35,997	100.0%	0	00.0%	0	1	0
Totals	8764							1868	800	359

Table B1-1.27: Annual analysis of heating and cooling loads (in blue and red rectangular boxes on the left side) and traditional HVAC applications covering the heating and cooling loads (in blue and red circular boxes on the right side) for a 2,000 square feet detached house above grade (average construction type) in the city of Niagara Falls

10. Sarnia (South) – Annual Hourly Heating and Cooling Loads Analysis and Coverage

Vertical Ground Source Heat Pump System (V.GSHPs)

Weather		Loads		GeoSmart Energy System					Auxiliary	
Air °F	Annual Hrs hours	Space Load Btuh/hr	DHW Btuh/hr	Geo °F	WF Air Btuh/hr	WF DHW Btuh/hr	WF Run Time	WF KWH kWh	Space kWh	DHW kWh
97	2	35,952	2,424	69	35,952	2,424	100.0%	2	0	0
92	23	29,349	2,424	65	29,349	2,182	100.0%	19	0	2
87	112	22,746	2,424	60	22,746	1,406	100.0%	68	0	36
82	254	16,144	2,424	56	16,144	818	100.0%	111	0	130
77	422	9,541	2,424	52	13,200	544	72.3%	112	0	273
72	597	5,579	2,424	49	13,356	476	41.8%	89	0	423
67	672	0	2,424	50	0	0	0.0%	0	0	519
62	653	0	2,424	50	0	0	0.0%	0	0	504
57	614	-2,528	2,424	51	8,853	973	28.6%	114	0	420
52	572	-5,230	2,424	50	8,617	946	60.7%	224	0	337
47	526	-7,932	2,424	48	9,327	1,054	85.0%	312	0	256
42	575	-10,635	2,424	47	11,684	1,399	91.0%	454	0	211
37	724	-13,337	2,424	45	14,036	1,749	95.0%	717	0	176
32	727	-16,039	2,424	44	16,380	2,106	97.9%	871	0	84
27	551	-18,742	2,424	42	18,763	2,426	99.9%	776	0	0
22	401	-21,444	2,424	41	21,465	2,426	99.9%	642	0	0
17	299	-24,146	2,424	39	24,167	2,426	99.9%	537	0	0
12	195	-26,849	2,424	38	26,869	2,425	99.9%	390	0	0
7	108	-29,551	2,424	37	29,572	2,425	99.9%	239	0	0
2	50	-32,253	2,424	36	32,274	2,425	99.9%	121	0	0
-3	19	-34,956	2,424	34	34,976	2,425	99.9%	50	0	0
-8	7	-37,658	2,424	33	37,678	2,425	99.9%	20	0	0
-13	2	-40,360	2,424	32	40,380	2,425	100.0%	6	0	0
Totals	8105							5873	0	3,369

Table B1-1.28: Annual analysis of heating and cooling loads (in blue and red rectangular boxes on the left side) and vertical ground source heat pump (V.GSHP) unit covering the heating and cooling loads (in blue and red circular boxes on the right side) for a 2,000 square feet detached house above grade (average construction type) in the city of Sarnia

Horizontal Ground Source Heat Pump System (H.GSHPs)

Weather		Loads		GeoSmart Energy System					Auxiliary	
Air °F	Annual Hrs hours	Space Load Btuh/hr	DHW Btuh/hr	Geo °F	WF Air Btuh/hr	WF DHW Btuh/hr	WF Run Time	WF KWH kWh	Space kWh	DHW kWh
97	2	35,952	2,424	66	35,952	2,424	100.0%	2	0	0
92	23	29,349	2,424	63	29,349	2,057	100.0%	18	0	3
87	112	22,746	2,424	60	22,746	1,393	100.0%	68	0	37
82	254	16,144	2,424	57	16,144	858	100.0%	113	0	127
77	422	9,541	2,424	54	13,061	604	73.0%	115	0	266
72	597	5,579	2,424	52	13,169	557	42.4%	93	0	416
67	672	0	2,424	50	0	0	0.0%	0	0	519
62	653	0	2,424	50	0	0	0.0%	0	0	504
57	614	-2,528	2,424	47	8,214	902	30.8%	119	0	420
52	572	-5,230	2,424	46	8,052	884	65.0%	232	0	337
47	526	-7,932	2,424	45	9,310	1,070	85.2%	321	0	253
42	575	-10,635	2,424	44	11,665	1,418	91.2%	465	0	207
37	724	-13,337	2,424	43	14,015	1,770	95.2%	733	0	170
32	727	-16,039	2,424	42	16,360	2,126	98.0%	886	0	78
27	551	-18,742	2,424	41	18,762	2,426	99.9%	786	0	0
22	401	-21,444	2,424	40	21,465	2,426	99.9%	647	0	0
17	299	-24,146	2,424	39	24,167	2,426	99.9%	540	0	0
12	195	-26,849	2,424	38	26,869	2,425	99.9%	390	0	0
7	108	-29,551	2,424	37	29,572	2,425	99.9%	238	0	0
2	50	-32,253	2,424	36	32,274	2,425	99.9%	120	0	0
-3	19	-34,956	2,424	35	34,976	2,425	99.9%	50	0	0
-8	7	-37,658	2,424	34	37,678	2,425	99.9%	20	0	0
-13	2	-40,360	2,424	34	40,381	2,425	99.9%	6	0	0
Totals	8105							5961	0	3,337

Table B1-1.29: Annual analysis of heating and cooling loads (in blue and red rectangular boxes on the left side) and horizontal ground source heat pump (H.GSHP) unit covering the heating and cooling loads (in blue and red circular boxes on the right side) for a 2,000 square feet detached house above grade (average construction type) in the city of Sarnia

Traditional HVAC Applications

Weather		Loads		Fossil Furnace System				Fuel Use		
Air Temp °F	Annual hours	Space Btuh/hr	HW Load Btuh/hr	Furnace Btuh/hr	Furn Run Time	AC Cap Btuh/hr	Clg Run Time	AC kWh	Furnace ccf	HW ccf
97	2	35,952	2,424	0	00.0%	40,988	87.7%	8	0	0
92	23	29,349	2,424	0	00.0%	42,233	69.5%	74	0	1
87	112	22,746	2,424	0	00.0%	43,478	52.3%	284	0	5
82	254	16,144	2,424	0	00.0%	44,723	36.1%	479	0	11
77	422	9,541	2,424	0	00.0%	45,968	20.8%	539	0	17
72	597	5,579	2,424	0	00.0%	47,212	11.8%	546	0	25
67	672	0	2,424	0	00.0%	0	00.0%	0	0	28
62	653	0	2,424	0	00.0%	0	00.0%	0	0	27
57	614	-2,528	2,424	3,150	06.7%	0	00.0%	0	19	25
52	572	-5,230	2,424	6,224	13.8%	0	00.0%	0	36	24
47	526	-7,932	2,424	9,281	21.0%	0	00.0%	0	49	22
42	575	-10,635	2,424	12,322	28.1%	0	00.0%	0	71	24
37	724	-13,337	2,424	15,347	35.3%	0	00.0%	0	111	30
32	727	-16,039	2,424	18,356	42.4%	0	00.0%	0	133	30
27	551	-18,742	2,424	21,349	49.6%	0	00.0%	0	118	23
22	401	-21,444	2,424	24,325	56.7%	0	00.0%	0	98	17
17	299	-24,146	2,424	27,286	63.9%	0	00.0%	0	82	12
12	195	-26,849	2,424	30,230	71.0%	0	00.0%	0	59	8
7	108	-29,551	2,424	33,158	78.2%	0	00.0%	0	36	4
2	50	-32,253	2,424	36,070	85.3%	0	00.0%	0	18	2
-3	19	-34,956	2,424	38,966	92.5%	0	00.0%	0	7	1
-8	7	-37,658	2,424	41,846	99.6%	0	00.0%	0	3	0
-13	2	-40,360	2,424	41,997	100.0%	0	00.0%	0	1	0
Totals	8105							1930	840	336

Table B1-1.30: Annual analysis of heating and cooling loads (in blue and red rectangular boxes on the left side) and traditional HVAC applications covering the heating and cooling loads (in blue and red circular boxes on the right side) for a 2,000 square feet detached house above grade (average construction type) in the city of Sarnia

11. Simcoe (South) – Annual Hourly Heating and Cooling Loads Analysis and Coverage

Vertical Ground Source Heat Pump System (V.GSHPs)

Weather		Loads		GeoSmart Energy System					Auxiliary	
Air	Annual Hrs	Space Load	DHW	Geo	WF Air	WF DHW	WF Run	WF KWH	Space	DHW
°F	hours	Btuh/hr	Btuh/hr	°F	Btuh/hr	Btuh/hr	Time	kWh	kWh	kWh
97	1	37,987	2,411	71	37,987	2,411	100.0%	1	0	0
92	7	31,229	2,411	66	31,229	2,411	100.0%	6	0	0
87	56	24,471	2,411	62	24,471	1,616	100.0%	37	0	14
82	190	17,712	2,411	58	17,712	958	100.0%	91	0	88
77	379	10,954	2,411	53	13,121	578	83.5%	117	0	233
72	578	6,899	2,411	50	13,281	508	51.9%	108	0	395
67	699	0	2,411	51	0	0	0.0%	0	0	537
62	730	0	2,411	51	0	0	0.0%	0	0	561
57	707	-1,209	2,411	52	9,032	992	13.4%	62	0	513
52	649	-3,912	2,411	51	8,794	966	44.5%	188	0	410
47	598	-6,614	2,411	49	8,559	940	77.3%	297	0	321
42	612	-9,317	2,411	48	10,527	1,226	88.5%	423	0	259
37	735	-12,019	2,411	46	12,883	1,573	93.3%	653	0	221
32	780	-14,722	2,411	45	15,232	1,926	96.7%	851	0	137
27	617	-17,425	2,411	43	17,574	2,285	99.1%	803	0	29
22	443	-20,127	2,411	42	20,148	2,414	99.9%	664	0	0
17	333	-22,830	2,411	40	22,851	2,414	99.9%	564	0	0
12	239	-25,532	2,411	39	25,553	2,413	99.9%	452	0	0
7	151	-28,235	2,411	38	28,256	2,413	99.9%	317	0	0
2	81	-30,938	2,411	37	30,958	2,413	99.9%	187	0	0
-3	35	-33,640	2,411	35	33,661	2,413	99.9%	88	0	0
-8	10	-36,343	2,411	34	36,363	2,413	99.9%	28	0	0
-13	3	-39,045	2,411	33	39,066	2,413	99.9%	9	0	0
Totals	8633							5945	0	3,716

Table B1-1.31: Annual analysis of heating and cooling loads (in blue and red rectangular boxes on the left side) and vertical ground source heat pump (V.GSHP) unit covering the heating and cooling loads (in blue and red circular boxes on the right side) for a 2,000 square feet detached house above grade (average construction type) in the city of Simcoe

Horizontal Ground Source Heat Pump System (H.GSHPs)

Weather		Loads		GeoSmart Energy System					Auxiliary	
Air °F	Annual Hrs hours	Space Load Btuh/hr	DHW Btuh/hr	Geo °F	WF Air Btuh/hr	WF DHW Btuh/hr	WF Run Time	WF KWH kWh	Space kWh	DHW kWh
97	1	37,987	2,411	68	37,987	2,411	100.0%	1	0	0
92	7	31,229	2,411	65	31,229	2,326	100.0%	6	0	0
87	56	24,471	2,411	62	24,471	1,594	100.0%	37	0	15
82	190	17,712	2,411	59	17,712	1,001	100.0%	92	0	85
77	379	10,954	2,411	55	12,987	636	84.3%	121	0	226
72	578	6,899	2,411	54	13,097	588	52.7%	113	0	387
67	699	0	2,411	51	0	0	0.0%	0	0	537
62	730	0	2,411	51	0	0	0.0%	0	0	561
57	707	-1,209	2,411	48	8,322	914	14.5%	65	0	513
52	649	-3,912	2,411	47	8,158	895	47.9%	195	0	410
47	598	-6,614	2,411	46	8,151	899	81.1%	307	0	320
42	612	-9,317	2,411	45	10,508	1,245	88.7%	435	0	255
37	735	-12,019	2,411	44	12,860	1,595	93.5%	669	0	216
32	780	-14,722	2,411	43	15,209	1,949	96.8%	870	0	130
27	617	-17,425	2,411	41	17,553	2,307	99.3%	818	0	24
22	443	-20,127	2,411	41	20,148	2,414	99.9%	673	0	0
17	333	-22,830	2,411	40	22,851	2,414	99.9%	569	0	0
12	239	-25,532	2,411	39	25,553	2,413	99.9%	454	0	0
7	151	-28,235	2,411	38	28,256	2,413	99.9%	317	0	0
2	81	-30,938	2,411	37	30,958	2,413	99.9%	186	0	0
-3	35	-33,640	2,411	36	33,661	2,413	99.9%	88	0	0
-8	10	-36,343	2,411	35	36,363	2,413	99.9%	27	0	0
-13	3	-39,045	2,411	34	39,066	2,413	99.9%	9	0	0
Totals	8633							6051	0	3,678

Table B1-1.32: Annual analysis of heating and cooling loads (in blue and red rectangular boxes on the left side) and horizontal ground source heat pump (H.GSHP) unit covering the heating and cooling loads (in blue and red circular boxes on the right side) for a 2,000 square feet detached house above grade (average construction type) in the city of Simcoe

Traditional HVAC Applications

Weather		Loads		Fossil Furnace System				Fuel Use		
Air Temp °F	Annual hours	Space Btuh/hr	HW Load Btuh/hr	Furnace Btuh/hr	Furn Run Time	AC Cap Btuh/hr	Clg Run Time	AC kWh	Furnace ccf	HW ccf
97	1	37,987	2,411	0	00.0%	40,988	92.7%	4	0	0
92	7	31,229	2,411	0	00.0%	42,233	73.9%	24	0	0
87	56	24,471	2,411	0	00.0%	43,478	56.3%	150	0	2
82	190	17,712	2,411	0	00.0%	44,723	39.6%	383	0	8
77	379	10,954	2,411	0	00.0%	45,968	23.8%	527	0	16
72	578	6,899	2,411	0	00.0%	47,212	14.6%	589	0	24
67	699	0	2,411	0	00.0%	0	00.0%	0	0	29
62	730	0	2,411	0	00.0%	0	00.0%	0	0	30
57	707	-1,209	2,411	1,644	03.2%	0	00.0%	0	12	29
52	649	-3,912	2,411	4,726	10.3%	0	00.0%	0	31	27
47	598	-6,614	2,411	7,791	17.5%	0	00.0%	0	47	25
42	612	-9,317	2,411	10,841	24.6%	0	00.0%	0	66	25
37	735	-12,019	2,411	13,874	31.8%	0	00.0%	0	102	30
32	780	-14,722	2,411	16,891	38.9%	0	00.0%	0	132	32
27	617	-17,425	2,411	19,892	46.1%	0	00.0%	0	123	25
22	443	-20,127	2,411	22,877	53.2%	0	00.0%	0	101	18
17	333	-22,830	2,411	25,846	60.4%	0	00.0%	0	86	14
12	239	-25,532	2,411	28,798	67.5%	0	00.0%	0	69	10
7	151	-28,235	2,411	31,734	74.7%	0	00.0%	0	48	6
2	81	-30,938	2,411	34,655	81.8%	0	00.0%	0	28	3
-3	35	-33,640	2,411	37,559	89.0%	0	00.0%	0	13	1
-8	10	-36,343	2,411	40,447	96.1%	0	00.0%	0	4	0
-13	3	-39,045	2,411	41,997	100.0%	0	00.0%	0	1	0
Totals	8633							1677	862	356

Table B1-1.33: Annual analysis of heating and cooling loads (in blue and red rectangular boxes on the left side) and traditional HVAC applications covering the heating and cooling loads (in blue and red circular boxes on the right side) for a 2,000 square feet detached house above grade (average construction type) in the city of Simcoe

12. Saint Catharines (South) – Annual Hourly Heating and Cooling Loads Analysis and Coverage

Vertical Ground Source Heat Pump System (V.GSHPs)

Weather		Loads		GeoSmart Energy System					Auxiliary	
Air °F	Annual Hrs hours	Space Load Btuh/hr	DHW Btuh/hr	Geo °F	WF Air Btuh/hr	WF DHW Btuh/hr	WF Run Time	WF kWh	Space kWh	DHW kWh
97	1	39,567	2,357	75	39,567	2,357	100.0%	1	0	0
92	16	32,222	2,357	69	32,222	2,357	100.0%	15	0	0
87	108	24,878	2,357	64	24,878	1,784	100.0%	75	0	20
82	289	17,534	2,357	59	17,534	1,019	100.0%	141	0	123
77	501	10,189	2,357	54	13,048	609	78.1%	146	0	300
72	668	5,783	2,357	51	13,221	534	43.7%	106	0	452
67	706	0	2,357	52	0	0	0.0%	0	0	530
62	688	0	2,357	52	0	0	0.0%	0	0	516
57	651	-2,324	2,357	54	9,216	1,013	25.2%	109	0	436
52	606	-5,027	2,357	52	8,978	986	56.0%	223	0	348
47	611	-7,729	2,357	51	9,101	1,010	84.9%	349	0	292
42	661	-10,431	2,357	49	11,463	1,350	91.0%	502	0	237
37	741	-13,134	2,357	47	13,819	1,696	95.0%	708	0	176
32	663	-15,836	2,357	46	16,170	2,048	97.9%	767	0	74
27	491	-18,538	2,357	44	18,560	2,359	99.9%	668	0	0
22	385	-21,241	2,357	43	21,262	2,359	99.9%	595	0	0
17	289	-23,943	2,357	42	23,964	2,359	99.9%	502	0	0
12	170	-26,645	2,357	40	26,667	2,359	99.9%	329	0	0
7	80	-29,348	2,357	39	29,369	2,358	99.9%	171	0	0
2	31	-32,050	2,357	38	32,071	2,358	99.9%	73	0	0
-3	8	-34,752	2,357	36	34,773	2,358	99.9%	20	0	0
-8	2	-37,454	2,357	35	37,475	2,358	99.9%	6	0	0
Totals	8366							5507	0	3,504

Table B1-1.34: Annual analysis of heating and cooling loads (in blue and red rectangular boxes on the left side) and vertical ground source heat pump (V.GSHP) unit covering the heating and cooling loads (in blue and red circular boxes on the right side) for a 2,000 square feet detached house above grade (average construction type) in the city of Saint Catharines

Horizontal Ground Source Heat Pump System (H.GSHPs)

Weather		Loads		GeoSmart Energy System					Auxiliary	
Air	Annual Hrs	Space Load	DHW	Geo	WF Air	WF DHW	WF Run	WF KWH	Space	DHW
°F	hours	Btuh/hr	Btuh/hr	°F	Btuh/hr	Btuh/hr	Time	kWh	kWh	kWh
97	1	39,567	2,357	71	39,567	2,357	100.0%	1	0	0
92	16	32,222	2,357	67	32,222	2,357	100.0%	15	0	0
87	108	24,878	2,357	64	24,878	1,762	100.0%	75	0	20
82	289	17,534	2,357	60	17,534	1,067	100.0%	143	0	119
77	501	10,189	2,357	57	12,900	674	79.0%	151	0	291
72	668	5,783	2,357	55	13,021	621	44.4%	111	0	443
67	706	0	2,357	52	0	0	0.0%	0	0	530
62	688	0	2,357	52	0	0	0.0%	0	0	516
57	651	-2,324	2,357	49	8,525	936	27.3%	114	0	436
52	606	-5,027	2,357	48	8,362	918	60.1%	231	0	348
47	611	-7,729	2,357	47	9,085	1,026	85.1%	358	0	289
42	661	-10,431	2,357	46	11,443	1,370	91.2%	516	0	233
37	741	-13,134	2,357	45	13,797	1,717	95.2%	725	0	170
32	663	-15,836	2,357	44	16,147	2,069	98.1%	782	0	69
27	491	-18,538	2,357	43	18,559	2,359	99.9%	678	0	0
22	385	-21,241	2,357	42	21,262	2,359	99.9%	602	0	0
17	289	-23,943	2,357	41	23,964	2,359	99.9%	506	0	0
12	170	-26,645	2,357	40	26,667	2,359	99.9%	330	0	0
7	80	-29,348	2,357	39	29,369	2,358	99.9%	171	0	0
2	31	-32,050	2,357	38	32,071	2,358	99.9%	72	0	0
-3	8	-34,752	2,357	37	34,773	2,358	99.9%	20	0	0
-8	2	-37,454	2,357	36	37,475	2,358	99.9%	5	0	0
Totals	8366							5608	0	3,465

Table B1-1.35: Annual analysis of heating and cooling loads (in blue and red rectangular boxes on the left side) and horizontal ground source heat pump (H.GSHP) unit covering the heating and cooling loads (in blue and red circular boxes on the right side) for a 2,000 square feet detached house above grade (average construction type) in the city of Saint Catharines

Traditional HVAC Applications

Weather		Loads		Fossil Furnace System				Fuel Use		
Air Temp °F	Annual hours	Space Btuh/hr	HW Load Btuh/hr	Furnace Btuh/hr	Furn Run Time	AC Cap Btuh/hr	Clg Run Time	AC kWh	Furnace ccf	HW ccf
97	1	39,567	2,357	0	00.0%	40,988	96.5%	4	0	0
92	16	32,222	2,357	0	00.0%	42,233	76.3%	55	0	1
87	108	24,878	2,357	0	00.0%	43,478	57.2%	293	0	4
82	289	17,534	2,357	0	00.0%	44,723	39.2%	578	0	12
77	501	10,189	2,357	0	00.0%	45,968	22.2%	666	0	20
72	668	5,783	2,357	0	00.0%	47,212	12.2%	622	0	27
67	706	0	2,357	0	00.0%	0	00.0%	0	0	28
62	688	0	2,357	0	00.0%	0	00.0%	0	0	28
57	651	-2,324	2,357	2,918	06.1%	0	00.0%	0	19	26
52	606	-5,027	2,357	5,993	13.3%	0	00.0%	0	36	24
47	611	-7,729	2,357	9,051	20.4%	0	00.0%	0	55	25
42	661	-10,431	2,357	12,094	27.6%	0	00.0%	0	80	27
37	741	-13,134	2,357	15,120	34.7%	0	00.0%	0	112	30
32	663	-15,836	2,357	18,130	41.9%	0	00.0%	0	120	27
27	491	-18,538	2,357	21,124	49.0%	0	00.0%	0	104	20
22	385	-21,241	2,357	24,102	56.2%	0	00.0%	0	93	16
17	289	-23,943	2,357	27,064	63.3%	0	00.0%	0	78	12
12	170	-26,645	2,357	30,009	70.5%	0	00.0%	0	51	7
7	80	-29,348	2,357	32,939	77.6%	0	00.0%	0	26	3
2	31	-32,050	2,357	35,852	84.8%	0	00.0%	0	11	1
-3	8	-34,752	2,357	38,749	91.9%	0	00.0%	0	3	0
-8	2	-37,454	2,357	41,630	99.1%	0	00.0%	0	1	0
Totals	8366							2218	790	337

Table B1-1.36: Annual analysis of heating and cooling loads (in blue and red rectangular boxes on the left side) and traditional HVAC applications covering the heating and cooling loads (in blue and red circular boxes on the right side) for a 2,000 square feet detached house above grade (average construction type) in the city of Saint Catharines

13. Toronto (South) – Annual Hourly Heating and Cooling Loads Analysis and Coverage
Vertical Ground Source Heat Pump System (V.GSHPs)

Weather		Loads		GeoSmart Energy System					Auxiliary	
Air °F	Annual Hrs hours	Space Load Btuh/hr	DHW Btuh/hr	Geo °F	WF Air Btuh/hr	WF DHW Btuh/hr	WF Run Time	WF KWH kWh	Space kWh	DHW kWh
97	1	34,956	2,424	69	34,956	2,424	100.0%	1	0	0
92	17	28,826	2,424	64	28,826	2,113	100.0%	14	0	2
87	70	22,696	2,424	60	22,696	1,401	100.0%	42	0	23
82	178	16,566	2,424	56	16,566	850	100.0%	80	0	89
77	329	10,436	2,424	52	13,165	559	79.3%	96	0	208
72	517	6,758	2,424	50	13,309	496	50.8%	94	0	358
67	675	0	2,424	50	0	0	0.0%	0	0	521
62	717	0	2,424	50	0	0	0.0%	0	0	553
57	698	-1,348	2,424	52	8,956	984	15.1%	69	0	506
52	667	-4,050	2,424	50	8,720	958	46.5%	201	0	420
47	635	-6,753	2,424	49	8,485	932	79.6%	323	0	340
42	625	-9,455	2,424	47	10,656	1,247	88.7%	439	0	262
37	771	-12,157	2,424	46	13,010	1,595	93.4%	695	0	229
32	896	-14,859	2,424	44	15,357	1,950	96.8%	991	0	153
27	626	-17,561	2,424	43	17,698	2,310	99.2%	825	0	26
22	446	-20,264	2,424	41	20,285	2,426	99.9%	676	0	0
17	337	-22,966	2,424	40	22,987	2,426	99.9%	576	0	0
12	245	-25,668	2,424	39	25,689	2,425	99.9%	468	0	0
7	159	-28,370	2,424	37	28,391	2,425	99.9%	337	0	0
2	92	-31,072	2,424	36	31,093	2,425	99.9%	214	0	0
-3	45	-33,775	2,424	35	33,795	2,425	99.9%	115	0	0
-8	16	-36,477	2,424	34	36,497	2,425	99.9%	44	0	0
-13	3	-39,179	2,424	32	39,199	2,425	99.9%	9	0	0
-18	1	-41,881	2,424	31	41,901	2,425	100.0%	3	0	0
-23	1	-44,583	2,424	30	44,603	2,425	100.0%	3	0	0
Totals	8767							6316	0	3,690

Table B1-1.37: Annual analysis of heating and cooling loads (in blue and red rectangular boxes on the left side) and vertical ground source heat pump (V.GSHP) unit covering the heating and cooling loads (in blue and red circular boxes on the right side) for a 2,000 square feet detached house above grade (average construction type) in the city of Toronto

Horizontal Ground Source Heat Pump System (H.GSHPs)

Weather		Loads		GeoSmart Energy System					Auxiliary	
Air °F	Annual Hrs hours	Space Load Btuh/hr	DHW Btuh/hr	Geo °F	WF Air Btuh/hr	WF DHW Btuh/hr	WF Run Time	WF KWH kWh	Space kWh	DHW kWh
97	1	34,956	2,424	66	34,956	2,424	100.0%	1	0	0
92	17	28,826	2,424	63	28,826	2,018	100.0%	13	0	2
87	70	22,696	2,424	60	22,696	1,403	100.0%	42	0	23
82	178	16,566	2,424	58	16,566	898	100.0%	81	0	86
77	329	10,436	2,424	55	13,023	621	80.1%	99	0	202
72	517	6,758	2,424	53	13,123	577	51.5%	99	0	350
67	675	0	2,424	50	0	0	0.0%	0	0	521
62	717	0	2,424	50	0	0	0.0%	0	0	553
57	698	-1,348	2,424	47	8,248	905	16.3%	72	0	506
52	667	-4,050	2,424	46	8,085	887	50.1%	209	0	420
47	635	-6,753	2,424	45	8,280	921	81.6%	333	0	338
42	625	-9,455	2,424	44	10,636	1,267	88.9%	452	0	258
37	771	-12,157	2,424	43	12,987	1,618	93.6%	713	0	223
32	896	-14,859	2,424	42	15,334	1,973	96.9%	1013	0	146
27	626	-17,561	2,424	41	17,676	2,332	99.4%	840	0	21
22	446	-20,264	2,424	40	20,284	2,426	99.9%	685	0	0
17	337	-22,966	2,424	39	22,987	2,426	99.9%	582	0	0
12	245	-25,668	2,424	38	25,689	2,425	99.9%	470	0	0
7	159	-28,370	2,424	37	28,391	2,425	99.9%	337	0	0
2	92	-31,072	2,424	36	31,093	2,425	99.9%	214	0	0
-3	45	-33,775	2,424	35	33,795	2,425	99.9%	114	0	0
-8	16	-36,477	2,424	35	36,497	2,425	99.9%	44	0	0
-13	3	-39,179	2,424	34	39,199	2,425	99.9%	9	0	0
-18	1	-41,881	2,424	33	41,901	2,425	100.0%	3	0	0
-23	1	-44,583	2,424	32	44,603	2,425	100.0%	3	0	0
Totals	8767							6428	0	3,651

Table B1-1.38: Annual analysis of heating and cooling loads (in blue and red rectangular boxes on the left side) and horizontal ground source heat pump (H.GSHP) unit covering the heating and cooling loads (in blue and red circular boxes on the right side) for a 2,000 square feet detached house above grade (average construction type) in the city of Toronto

Traditional HVAC Applications

Weather		Loads		Fossil Furnace System				Fuel Use		
Air Temp °F	Annual hours	Space Btuh/hr	HW Load Btuh/hr	Furnace Btuh/hr	Furn Run Time	AC Cap Btuh/hr	Clg Run Time	AC kWh	Furnace ccf	HW ccf
97	1	34,956	2,424	0	00.0%	35,865	97.5%	4	0	0
92	17	28,826	2,424	0	00.0%	36,954	78.0%	52	0	1
87	70	22,696	2,424	0	00.0%	38,043	59.7%	171	0	3
82	178	16,566	2,424	0	00.0%	39,132	42.3%	329	0	7
77	329	10,436	2,424	0	00.0%	40,222	25.9%	423	0	14
72	517	6,758	2,424	0	00.0%	41,311	16.4%	490	0	21
67	675	0	2,424	0	00.0%	0	00.0%	0	0	28
62	717	0	2,424	0	00.0%	0	00.0%	0	0	30
57	698	-1,348	2,424	1,841	03.1%	0	00.0%	0	13	29
52	667	-4,050	2,424	4,923	09.4%	0	00.0%	0	33	28
47	635	-6,753	2,424	7,992	15.6%	0	00.0%	0	51	26
42	625	-9,455	2,424	11,046	21.9%	0	00.0%	0	69	26
37	771	-12,157	2,424	14,086	28.1%	0	00.0%	0	109	32
32	896	-14,859	2,424	17,112	34.4%	0	00.0%	0	153	37
27	626	-17,561	2,424	20,124	40.7%	0	00.0%	0	126	26
22	446	-20,264	2,424	23,121	46.9%	0	00.0%	0	103	18
17	337	-22,966	2,424	26,105	53.2%	0	00.0%	0	88	14
12	245	-25,668	2,424	29,074	59.4%	0	00.0%	0	71	10
7	159	-28,370	2,424	32,029	65.7%	0	00.0%	0	51	7
2	92	-31,072	2,424	34,971	71.9%	0	00.0%	0	32	4
-3	45	-33,775	2,424	37,898	78.2%	0	00.0%	0	17	2
-8	16	-36,477	2,424	40,810	84.4%	0	00.0%	0	7	1
-13	3	-39,179	2,424	43,709	90.7%	0	00.0%	0	1	0
-18	1	-41,881	2,424	46,594	96.9%	0	00.0%	0	0	0
-23	1	-44,583	2,424	47,997	100.0%	0	00.0%	0	0	0
Totals	8767							1470	925	363

Table B1-1.39: Annual analysis of heating and cooling loads (in blue and red rectangular boxes on the left side) and traditional HVAC applications covering the heating and cooling loads (in blue and red circular boxes on the right side) for a 2,000 square feet detached house above grade (average construction type) in the city of Toronto

14. Trenton (South) – Annual Hourly Heating and Cooling Loads Analysis and Coverage
Vertical Ground Source Heat Pump System (V.GSHPs)

Weather		Loads		GeoSmart Energy System					Auxiliary	
Air	Annual Hrs	Space Load	DHW	Geo	WF Air	WF DHW	WF Run	WF KWH	Space	DHW
°F	hours	Btuh/hr	Btuh/hr	°F	Btuh/hr	Btuh/hr	Time	kwh	kwh	kwh
97	1	42,577	2,436	74	42,577	2,436	100.0%	1	0	0
92	4	34,788	2,436	68	34,788	2,436	100.0%	4	0	0
87	25	26,999	2,436	63	26,999	1,854	100.0%	18	0	5
82	123	19,209	2,436	58	19,209	1,050	100.0%	62	0	54
77	344	11,420	2,436	53	13,149	566	86.9%	110	0	213
72	593	6,746	2,436	49	13,332	486	50.6%	107	0	414
67	740	0	2,436	50	0	0	0.0%	0	0	574
62	726	0	2,436	50	0	0	0.0%	0	0	563
57	723	-1,361	2,436	52	8,892	977	15.3%	72	0	526
52	661	-4,064	2,436	50	8,656	951	46.9%	200	0	419
47	648	-6,766	2,436	49	8,421	925	80.3%	331	0	349
42	633	-9,469	2,436	47	10,676	1,253	88.7%	447	0	267
37	779	-12,171	2,436	45	13,029	1,602	93.4%	706	0	233
32	783	-14,874	2,436	44	15,376	1,957	96.7%	870	0	135
27	533	-17,576	2,436	42	17,717	2,319	99.2%	706	0	23
22	422	-20,279	2,436	41	20,300	2,438	99.9%	643	0	0
17	343	-22,981	2,436	40	23,002	2,438	99.9%	590	0	0
12	262	-25,684	2,436	38	25,705	2,438	99.9%	503	0	0
7	191	-28,386	2,436	37	28,407	2,437	99.9%	407	0	0
2	113	-31,089	2,436	36	31,109	2,437	99.9%	265	0	0
-3	68	-33,791	2,436	34	33,812	2,437	99.9%	174	0	0
-8	37	-36,494	2,436	33	36,514	2,437	99.9%	103	0	0
-13	12	-39,196	2,436	32	39,216	2,437	99.9%	36	0	0
-18	3	-41,899	2,436	31	41,919	2,437	100.0%	10	0	0
-23	1	-44,601	2,436	29	44,621	2,437	100.0%	4	0	0
Totals	8768							6371	0	3,775

Table B1-1.40: Annual analysis of heating and cooling loads (in blue and red rectangular boxes on the left side) and vertical ground source heat pump (V.GSHP) unit covering the heating and cooling loads (in blue and red circular boxes on the right side) for a 2,000 square feet detached house above grade (average construction type) in the city of Trenton

Horizontal Ground Source Heat Pump System (H.GSHPs)

Weather		Loads		GeoSmart Energy System					Auxiliary	
Air °F	Annual Hrs hours	Space Load Btuh/hr	DHW Btuh/hr	Geo °F	WF Air Btuh/hr	WF DHW Btuh/hr	WF Run Time	WF KWH kWh	Space kWh	DHW kWh
97	1	42,577	2,436	69	42,577	2,436	100.0%	1	0	0
92	4	34,788	2,436	65	34,788	2,436	100.0%	4	0	0
87	25	26,999	2,436	62	26,999	1,777	100.0%	18	0	5
82	123	19,209	2,436	58	19,209	1,073	100.0%	63	0	53
77	344	11,420	2,436	55	13,031	617	87.6%	113	0	208
72	593	6,746	2,436	52	13,159	561	51.3%	112	0	406
67	740	0	2,436	50	0	0	0.0%	0	0	574
62	726	0	2,436	50	0	0	0.0%	0	0	563
57	723	-1,361	2,436	47	8,219	902	16.6%	75	0	526
52	661	-4,064	2,436	46	8,056	884	50.4%	208	0	419
47	648	-6,766	2,436	45	8,302	925	81.5%	341	0	347
42	633	-9,469	2,436	44	10,657	1,272	88.8%	459	0	263
37	779	-12,171	2,436	43	13,008	1,623	93.6%	723	0	228
32	783	-14,874	2,436	42	15,355	1,978	96.9%	888	0	130
27	533	-17,576	2,436	41	17,697	2,338	99.3%	717	0	19
22	422	-20,279	2,436	40	20,299	2,438	99.9%	650	0	0
17	343	-22,981	2,436	39	23,002	2,438	99.9%	594	0	0
12	262	-25,684	2,436	38	25,705	2,438	99.9%	505	0	0
7	191	-28,386	2,436	37	28,407	2,437	99.9%	406	0	0
2	113	-31,089	2,436	36	31,109	2,437	99.9%	263	0	0
-3	68	-33,791	2,436	35	33,812	2,437	99.9%	172	0	0
-8	37	-36,494	2,436	34	36,514	2,437	99.9%	102	0	0
-13	12	-39,196	2,436	33	39,217	2,437	99.9%	36	0	0
-18	3	-41,899	2,436	33	41,919	2,437	100.0%	10	0	0
-23	1	-44,601	2,436	32	44,621	2,437	100.0%	3	0	0
Totals	8768							6462	0	3,741

Table B1-1.41: Annual analysis of heating and cooling loads (in blue and red rectangular boxes on the left side) and horizontal ground source heat pump (H.GSHP) unit covering the heating and cooling loads (in blue and red circular boxes on the right side) for a 2,000 square feet detached house above grade (average construction type) in the city of Trenton

Traditional HVAC Applications

Weather		Loads		Fossil Furnace System				Fuel Use		
Air Temp °F	Annual hours	Space Btuh/hr	HW Load Btuh/hr	Furnace Btuh/hr	Furn Run Time	AC Cap Btuh/hr	Clg Run Time	AC kWh	Furnace ccf	HW ccf
97	1	42,577	2,436	0	00.0%	46,112	92.3%	5	0	0
92	4	34,788	2,436	0	00.0%	47,512	73.2%	15	0	0
87	25	26,999	2,436	0	00.0%	48,913	55.2%	74	0	1
82	123	19,209	2,436	0	00.0%	50,313	38.2%	272	0	5
77	344	11,420	2,436	0	00.0%	51,714	22.1%	513	0	14
72	593	6,746	2,436	0	00.0%	53,114	12.7%	633	0	25
67	740	0	2,436	0	00.0%	0	00.0%	0	0	31
62	726	0	2,436	0	00.0%	0	00.0%	0	0	30
57	723	-1,361	2,436	1,856	03.2%	0	00.0%	0	13	30
52	661	-4,064	2,436	4,939	09.4%	0	00.0%	0	33	27
47	648	-6,766	2,436	8,007	15.7%	0	00.0%	0	52	27
42	633	-9,469	2,436	11,062	21.9%	0	00.0%	0	70	26
37	779	-12,171	2,436	14,102	28.2%	0	00.0%	0	110	32
32	783	-14,874	2,436	17,128	34.4%	0	00.0%	0	134	33
27	533	-17,576	2,436	20,140	40.7%	0	00.0%	0	107	22
22	422	-20,279	2,436	23,138	46.9%	0	00.0%	0	98	18
17	343	-22,981	2,436	26,122	53.2%	0	00.0%	0	90	14
12	262	-25,684	2,436	29,091	59.5%	0	00.0%	0	76	11
7	191	-28,386	2,436	32,047	65.7%	0	00.0%	0	61	8
2	113	-31,089	2,436	34,988	72.0%	0	00.0%	0	40	5
-3	68	-33,791	2,436	37,916	78.2%	0	00.0%	0	26	3
-8	37	-36,494	2,436	40,829	84.5%	0	00.0%	0	15	2
-13	12	-39,196	2,436	43,728	90.7%	0	00.0%	0	5	0
-18	3	-41,899	2,436	46,613	97.0%	0	00.0%	0	1	0
-23	1	-44,601	2,436	47,997	100.0%	0	00.0%	0	0	0
Totals	8768							1511	932	365

Table B1-1.42: Annual analysis of heating and cooling loads (in blue and red rectangular boxes on the left side) and traditional HVAC applications covering the heating and cooling loads (in blue and red circular boxes on the right side) for a 2,000 square feet detached house above grade (average construction type) in the city of Trenton

15. Wiarnton (South) – Annual Hourly Heating and Cooling Loads Analysis and Coverage
Vertical Ground Source Heat Pump System (V.GSHPs)

Weather		Loads		GeoSmart Energy System					Auxiliary	
Air	Annual Hrs	Space Load	DHW	Geo	WF Air	WF DHW	WF Run	WF KWH	Space	DHW
°F	hours	Btuh/hr	Btuh/hr	°F	Btuh/hr	Btuh/hr	Time	kWh	kWh	kWh
92	1	42,078	2,499	66	42,078	2,499	100.0%	2	0	0
87	19	32,165	2,499	60	32,165	1,911	100.0%	21	0	4
82	86	22,252	2,499	55	22,252	1,132	100.0%	60	0	37
77	225	12,339	2,499	49	15,734	683	78.4%	79	0	141
72	436	6,391	2,499	46	15,946	577	40.1%	75	0	315
67	633	0	2,499	48	0	0	0.0%	0	0	504
62	745	0	2,499	48	0	0	0.0%	0	0	593
57	753	-1,716	2,499	49	10,278	1,534	16.7%	97	0	538
52	707	-4,418	2,499	48	10,022	1,499	44.1%	239	0	414
47	662	-7,120	2,499	47	9,768	1,465	72.9%	365	0	302
42	654	-9,822	2,499	46	10,755	1,599	91.3%	500	0	216
37	784	-12,524	2,499	44	13,130	1,925	95.4%	763	0	166
32	816	-15,226	2,499	43	15,501	2,256	98.2%	970	0	74
27	656	-17,929	2,499	42	17,955	2,503	99.9%	919	0	0
22	511	-20,631	2,499	41	20,658	2,503	99.9%	817	0	0
17	404	-23,333	2,499	40	23,360	2,502	99.9%	728	0	0
12	282	-26,035	2,499	39	26,062	2,502	99.9%	567	0	0
7	175	-28,737	2,499	38	28,764	2,502	99.9%	389	0	0
2	97	-31,439	2,499	37	31,466	2,502	99.9%	237	0	0
-3	47	-34,141	2,499	36	34,168	2,501	99.9%	125	0	0
-8	19	-36,844	2,499	35	36,870	2,501	99.9%	55	0	0
-13	6	-39,546	2,499	34	39,572	2,501	99.9%	19	0	0
-18	2	-42,248	2,499	33	42,274	2,501	99.9%	7	0	0
-23	1	-44,950	2,499	32	44,976	2,501	99.9%	4	0	0
Totals	8721							7036	0	3,303

Table B1-1.43: Annual analysis of heating and cooling loads (in blue and red rectangular boxes on the left side) and vertical ground source heat pump (V.GSHP) unit covering the heating and cooling loads (in blue and red circular boxes on the right side) for a 2,000 square feet detached house above grade (average construction type) in the city of Wiarnton

Horizontal Ground Source Heat Pump System (H.GSHPs)

Weather		Loads		GeoSmart Energy System					Auxiliary	
Air °F	Annual Hrs hours	Space Load Btuh/hr	DHW Btuh/hr	Geo °F	WF Air Btuh/hr	WF DHW Btuh/hr	WF Run Time	WF KWH kWh	Space kWh	DHW kWh
92	1	42,078	2,499	66	42,078	2,499	100.0%	1	0	0
87	19	32,165	2,499	62	32,165	2,116	100.0%	16	0	2
82	86	22,252	2,499	57	22,252	1,185	100.0%	48	0	36
77	225	12,339	2,499	53	13,151	565	93.8%	78	0	141
72	436	6,391	2,499	50	13,313	494	48.0%	75	0	314
67	633	0	2,499	48	0	0	0.0%	0	0	504
62	745	0	2,499	48	0	0	0.0%	0	0	593
57	753	-1,716	2,499	45	7,935	871	21.6%	101	0	554
52	707	-4,418	2,499	44	7,773	853	56.8%	246	0	454
47	662	-7,120	2,499	43	8,657	987	82.2%	371	0	356
42	654	-9,822	2,499	42	11,008	1,338	89.2%	499	0	272
37	784	-12,524	2,499	41	13,354	1,693	93.8%	761	0	228
32	816	-15,226	2,499	40	15,696	2,053	97.0%	965	0	132
27	656	-17,929	2,499	39	18,034	2,417	99.4%	918	0	20
22	511	-20,631	2,499	38	20,651	2,502	99.9%	816	0	0
17	404	-23,333	2,499	37	23,353	2,502	99.9%	724	0	0
12	282	-26,035	2,499	36	26,055	2,501	99.9%	562	0	0
7	175	-28,737	2,499	35	28,757	2,501	99.9%	384	0	0
2	97	-31,439	2,499	34	31,460	2,501	99.9%	233	0	0
-3	47	-34,141	2,499	34	34,162	2,501	99.9%	123	0	0
-8	19	-36,844	2,499	33	36,864	2,501	99.9%	54	0	0
-13	6	-39,546	2,499	32	39,566	2,501	99.9%	18	0	0
-18	2	-42,248	2,499	31	42,268	2,501	100.0%	7	0	0
-23	1	-44,950	2,499	30	44,970	2,501	100.0%	4	0	0
Totals	8721							7005	0	3,606

Table B1-1.44: Annual analysis of heating and cooling loads (in blue and red rectangular boxes on the left side) and horizontal ground source heat pump (H.GSHP) unit covering the heating and cooling loads (in blue and red circular boxes on the right side) for a 2,000 square feet detached house above grade (average construction type) in the city of Wiarnton

Traditional HVAC Applications

Weather		Loads		Fossil Furnace System				Fuel Use		
Air Temp °F	Annual hours	Space Btuh/hr	HW Load Btuh/hr	Furnace Btuh/hr	Furn Run Time	AC Cap Btuh/hr	Clg Run Time	AC kWh	Furnace ccf	HW ccf
92	1	42,078	2,499	0	00.0%	42,233	99.6%	4	0	0
87	19	32,165	2,499	0	00.0%	43,478	74.0%	63	0	1
82	86	22,252	2,499	0	00.0%	44,723	49.8%	205	0	4
77	225	12,339	2,499	0	00.0%	45,968	26.8%	338	0	10
72	436	6,391	2,499	0	00.0%	47,212	13.5%	427	0	19
67	633	0	2,499	0	00.0%	0	00.0%	0	0	27
62	745	0	2,499	0	00.0%	0	00.0%	0	0	32
57	753	-1,716	2,499	2,261	04.0%	0	00.0%	0	17	32
52	707	-4,418	2,499	5,341	10.2%	0	00.0%	0	38	30
47	662	-7,120	2,499	8,408	16.5%	0	00.0%	0	56	28
42	654	-9,822	2,499	11,460	22.7%	0	00.0%	0	75	28
37	784	-12,524	2,499	14,498	29.0%	0	00.0%	0	114	33
32	816	-15,226	2,499	17,522	35.2%	0	00.0%	0	143	35
27	656	-17,929	2,499	20,532	41.5%	0	00.0%	0	135	28
22	511	-20,631	2,499	23,527	47.8%	0	00.0%	0	120	22
17	404	-23,333	2,499	26,509	54.0%	0	00.0%	0	107	17
12	282	-26,035	2,499	29,476	60.3%	0	00.0%	0	83	12
7	175	-28,737	2,499	32,430	66.5%	0	00.0%	0	57	7
2	97	-31,439	2,499	35,369	72.8%	0	00.0%	0	34	4
-3	47	-34,141	2,499	38,294	79.0%	0	00.0%	0	18	2
-8	19	-36,844	2,499	41,205	85.3%	0	00.0%	0	8	1
-13	6	-39,546	2,499	44,102	91.5%	0	00.0%	0	3	0
-18	2	-42,248	2,499	46,984	97.8%	0	00.0%	0	1	0
-23	1	-44,950	2,499	47,997	100.0%	0	00.0%	0	0	0
Totals	8721							1037	1,008	372

Table B1-1.45: Annual analysis of heating and cooling loads (in blue and red rectangular boxes on the left side) and traditional HVAC applications covering the heating and cooling loads (in blue and red circular boxes on the right side) for a 2,000 square feet detached house above grade (average construction type) in the city of Wiarnton

16. Windsor (South) – Annual Hourly Heating and Cooling Loads Analysis and Coverage

Vertical Ground Source Heat Pump System (V.GSHPs)

Weather		Loads		GeoSmart Energy System					Auxiliary	
Air °F	Annual Hrs hours	Space Load Btuh/hr	DHW Btuh/hr	Geo °F	WF Air Btuh/hr	WF DHW Btuh/hr	WF Run Time	WF KWH kWh	Space kWh	DHW kWh
97	1	35,141	2,363	71	35,141	2,363	100.0%	1	0	0
92	15	29,069	2,363	66	29,069	2,312	100.0%	13	0	0
87	90	22,998	2,363	63	22,998	1,554	100.0%	57	0	23
82	231	16,926	2,363	59	16,926	958	100.0%	109	0	103
77	431	10,854	2,363	55	13,034	616	83.3%	135	0	254
72	646	7,211	2,363	52	13,177	554	54.7%	130	0	424
67	828	0	2,363	52	0	0	0.0%	0	0	623
62	749	0	2,363	52	0	0	0.0%	0	0	564
57	656	-896	2,363	54	9,311	1,023	9.6%	42	0	473
52	612	-3,598	2,363	53	9,072	997	39.7%	160	0	383
47	592	-6,300	2,363	51	8,836	971	71.3%	275	0	315
42	614	-9,003	2,363	50	10,220	1,172	88.1%	405	0	260
37	715	-11,705	2,363	48	12,578	1,515	93.1%	610	0	217
32	859	-14,407	2,363	46	14,931	1,864	96.5%	903	0	154
27	637	-17,110	2,363	45	17,278	2,219	99.0%	800	0	34
22	401	-19,812	2,363	43	19,834	2,365	99.9%	582	0	0
17	299	-22,514	2,363	42	22,536	2,365	99.9%	490	0	0
12	198	-25,217	2,363	41	25,238	2,365	99.9%	363	0	0
7	119	-27,919	2,363	40	27,940	2,365	99.9%	242	0	0
2	51	-30,621	2,363	38	30,642	2,364	99.9%	114	0	0
-3	18	-33,324	2,363	37	33,345	2,364	99.9%	44	0	0
-8	2	-36,026	2,363	36	36,047	2,364	99.9%	5	0	0
-13	1	-38,728	2,363	34	38,749	2,364	99.9%	3	0	0
Totals	8765							5483	0	3,828

Table B1-1.46: Annual analysis of heating and cooling loads (in blue and red rectangular boxes on the left side) and vertical ground source heat pump (V.GSHP) unit covering the heating and cooling loads (in blue and red circular boxes on the right side) for a 2,000 square feet detached house above grade (average construction type) in the city of Windsor

Horizontal Ground Source Heat Pump System (H.GSHPs)

Weather		Loads		GeoSmart Energy System					Auxiliary	
Air °F	Annual Hrs hours	Space Load Btuh/hr	DHW Btuh/hr	Geo °F	WF Air Btuh/hr	WF DHW Btuh/hr	WF Run Time	WF kWh	Space kWh	DHW kWh
97	1	35,141	2,363	68	35,141	2,363	100.0%	1	0	0
92	15	29,069	2,363	65	29,069	2,217	100.0%	12	0	1
87	90	22,998	2,363	63	22,998	1,557	100.0%	57	0	23
82	231	16,926	2,363	60	16,926	1,009	100.0%	111	0	100
77	431	10,854	2,363	57	12,893	677	84.2%	139	0	246
72	646	7,211	2,363	55	12,992	634	55.5%	135	0	414
67	828	0	2,363	52	0	0	0.0%	0	0	623
62	749	0	2,363	52	0	0	0.0%	0	0	564
57	656	-896	2,363	50	8,578	942	10.4%	44	0	473
52	612	-3,598	2,363	48	8,414	924	42.8%	167	0	384
47	592	-6,300	2,363	47	8,250	906	76.4%	285	0	315
42	614	-9,003	2,363	46	10,201	1,189	88.3%	416	0	257
37	715	-11,705	2,363	45	12,557	1,535	93.2%	625	0	212
32	859	-14,407	2,363	44	14,909	1,886	96.6%	923	0	148
27	637	-17,110	2,363	43	17,256	2,240	99.2%	815	0	29
22	401	-19,812	2,363	42	19,833	2,365	99.9%	590	0	0
17	299	-22,514	2,363	41	22,536	2,365	99.9%	495	0	0
12	198	-25,217	2,363	40	25,238	2,365	99.9%	365	0	0
7	119	-27,919	2,363	39	27,940	2,365	99.9%	243	0	0
2	51	-30,621	2,363	38	30,643	2,364	99.9%	114	0	0
-3	18	-33,324	2,363	37	33,345	2,364	99.9%	44	0	0
-8	2	-36,026	2,363	37	36,047	2,364	99.9%	5	0	0
-13	1	-38,728	2,363	36	38,749	2,364	99.9%	3	0	0
Totals	8765							5590	0	3,787

Table B1-1.47: Annual analysis of heating and cooling loads (in blue and red rectangular boxes on the left side) and horizontal ground source heat pump (H.GSHP) unit covering the heating and cooling loads (in blue and red circular boxes on the right side) for a 2,000 square feet detached house above grade (average construction type) in the city of Windsor

Traditional HVAC Applications

Weather		Loads		Fossil Furnace System				Fuel Use		
Air Temp	Annual	Space	HW Load	Furnace	Furn Run	AC Cap	Clg Run	AC	Furnace	HW
*F	hours	Btuh/hr	Btuh/hr	Btuh/hr	Time	Btuh/hr	Time	kWh	ccf	ccf
97	1	35,141	2,363	0	00.0%	35,865	98.0%	4	0	0
92	15	29,069	2,363	0	00.0%	36,954	78.7%	46	0	1
87	90	22,998	2,363	0	00.0%	38,043	60.5%	222	0	4
82	231	16,926	2,363	0	00.0%	39,132	43.3%	434	0	9
77	431	10,854	2,363	0	00.0%	40,222	27.0%	569	0	17
72	646	7,211	2,363	0	00.0%	41,311	17.5%	636	0	26
67	828	0	2,363	0	00.0%	0	00.0%	0	0	33
62	749	0	2,363	0	00.0%	0	00.0%	0	0	30
57	656	-896	2,363	1,286	02.4%	0	00.0%	0	8	27
52	612	-3,598	2,363	4,369	09.5%	0	00.0%	0	27	25
47	592	-6,300	2,363	7,437	16.7%	0	00.0%	0	44	24
42	614	-9,003	2,363	10,487	23.8%	0	00.0%	0	64	25
37	715	-11,705	2,363	13,522	31.0%	0	00.0%	0	97	29
32	859	-14,407	2,363	16,541	38.1%	0	00.0%	0	142	35
27	637	-17,110	2,363	19,543	45.3%	0	00.0%	0	124	26
22	401	-19,812	2,363	22,530	52.4%	0	00.0%	0	90	16
17	299	-22,514	2,363	25,500	59.6%	0	00.0%	0	76	12
12	198	-25,217	2,363	28,454	66.7%	0	00.0%	0	56	8
7	119	-27,919	2,363	31,392	73.9%	0	00.0%	0	37	5
2	51	-30,621	2,363	34,314	81.0%	0	00.0%	0	18	2
-3	18	-33,324	2,363	37,219	88.2%	0	00.0%	0	7	1
-8	2	-36,026	2,363	40,109	95.3%	0	00.0%	0	1	0
-13	1	-38,728	2,363	41,997	100.0%	0	00.0%	0	0	0
Totals	8765							1911	793	354

Table B1-1.48: Annual analysis of heating and cooling loads (in blue and red rectangular boxes on the left side) and traditional HVAC applications covering the heating and cooling loads (in blue and red circular boxes on the right side) for a 2,000 square feet detached house above grade (average construction type) in the city of Windsor

17. Barrie (Distinct) – Annual Hourly Heating and Cooling Loads Analysis and Coverage
Vertical Ground Source Heat Pump System (V.GSHPs)

Weather		Loads		GeoSmart Energy System					Auxiliary	
Air	Annual Hrs	Space Load	DHW	Geo	WF Air	WF DHW	WF Run	WF kWh	Space	DHW
°F	hours	Btuh/hr	Btuh/hr	°F	Btuh/hr	Btuh/hr	Time	kWh	kWh	kWh
92	1	32,223	2,499	60	32,223	1,916	100.0%	1	0	0
87	23	25,308	2,499	57	25,308	1,346	100.0%	19	0	8
82	105	18,393	2,499	53	18,393	892	100.0%	58	0	54
77	234	11,478	2,499	49	15,765	668	72.8%	76	0	150
72	404	7,329	2,499	47	15,913	594	46.1%	81	0	286
67	590	0	2,499	48	0	0	0.0%	0	0	470
62	701	0	2,499	48	0	0	0.0%	0	0	558
57	693	-195	2,499	50	10,422	1,553	1.9%	10	0	545
52	669	-2,703	2,499	49	10,184	1,521	26.5%	137	0	447
47	649	-5,211	2,499	48	9,947	1,489	52.4%	260	0	355
42	629	-7,720	2,499	47	9,712	1,458	79.5%	377	0	269
37	681	-10,228	2,499	45	11,111	1,647	92.0%	542	0	213
32	852	-12,736	2,499	44	13,316	1,950	95.6%	843	0	172
27	649	-15,244	2,499	43	15,516	2,258	98.2%	772	0	58
22	482	-17,752	2,499	42	17,779	2,503	99.8%	669	0	0
17	363	-20,260	2,499	41	20,287	2,503	99.9%	571	0	0
12	309	-22,768	2,499	40	22,795	2,502	99.9%	544	0	0
7	254	-25,276	2,499	39	25,303	2,502	99.9%	495	0	0
2	179	-27,785	2,499	38	27,811	2,502	99.9%	384	0	0
-3	140	-30,293	2,499	37	30,319	2,502	99.9%	329	0	0
-8	78	-32,801	2,499	36	32,827	2,501	99.9%	199	0	0
-13	49	-35,309	2,499	35	35,335	2,501	99.9%	135	0	0
-18	20	-37,817	2,499	34	37,843	2,501	99.9%	60	0	0
-23	10	-40,325	2,499	34	40,351	2,501	99.9%	32	0	0
-28	3	-42,833	2,499	33	42,859	2,501	99.9%	10	0	0
-33	1	-45,342	2,499	32	45,367	2,501	99.9%	4	0	0
Totals	8768							6607	0	3,585

Table B1-1.49: Annual analysis of heating and cooling loads (in blue and red rectangular boxes on the left side) and vertical ground source heat pump (V.GSHP) unit covering the heating and cooling loads (in blue and red circular boxes on the right side) for a 2,000 square feet detached house above grade (average construction type) in the city of Barrie

Horizontal Ground Source Heat Pump System (H.GSHPs)

Weather		Loads		GeoSmart Energy System					Auxiliary	
Air	Annual Hrs	Space Load	DHW	Geo	WF Air	WF DHW	WF Run	WF kWh	Space	DHW
°F	hours	Btuh/hr	Btuh/hr	°F	Btuh/hr	Btuh/hr	Time	kWh	kWh	kWh
92	1	32,223	2,499	59	32,223	1,817	100.0%	1	0	0
87	23	25,308	2,499	56	25,308	1,334	100.0%	19	0	9
82	105	18,393	2,499	54	18,393	930	100.0%	59	0	52
77	234	11,478	2,499	51	15,629	735	73.4%	78	0	146
72	404	7,329	2,499	50	15,732	684	46.6%	84	0	281
67	590	0	2,499	48	0	0	0.0%	0	0	470
62	701	0	2,499	48	0	0	0.0%	0	0	558
57	693	-195	2,499	46	9,591	1,441	2.0%	11	0	545
52	669	-2,703	2,499	45	9,427	1,419	28.7%	143	0	446
47	649	-5,211	2,499	44	9,263	1,398	56.3%	270	0	354
42	629	-7,720	2,499	44	9,101	1,376	84.8%	391	0	267
37	681	-10,228	2,499	43	11,105	1,653	92.1%	557	0	212
32	852	-12,736	2,499	42	13,306	1,960	95.7%	865	0	169
27	649	-15,244	2,499	41	15,503	2,271	98.3%	790	0	55
22	482	-17,752	2,499	41	17,778	2,503	99.9%	682	0	0
17	363	-20,260	2,499	40	20,287	2,503	99.9%	579	0	0
12	309	-22,768	2,499	39	22,795	2,502	99.9%	550	0	0
7	254	-25,276	2,499	38	25,303	2,502	99.9%	500	0	0
2	179	-27,785	2,499	38	27,811	2,502	99.9%	386	0	0
-3	140	-30,293	2,499	37	30,319	2,502	99.9%	329	0	0
-8	78	-32,801	2,499	36	32,828	2,501	99.9%	199	0	0
-13	49	-35,309	2,499	36	35,336	2,501	99.9%	135	0	0
-18	20	-37,817	2,499	35	37,844	2,501	99.9%	59	0	0
-23	10	-40,325	2,499	34	40,352	2,501	99.9%	32	0	0
-28	3	-42,833	2,499	34	42,860	2,501	99.9%	10	0	0
-33	1	-45,342	2,499	33	45,368	2,501	99.9%	4	0	0
Totals	8768							6731	0	3,564

Table B1-1.50: Annual analysis of heating and cooling loads (in blue and red rectangular boxes on the left side) and horizontal ground source heat pump (H.GSHP) unit covering the heating and cooling loads (in blue and red circular boxes on the right side) for a 2,000 square feet detached house above grade (average construction type) in the city of Barrie

Traditional HVAC Applications

Weather		Loads		Fossil Furnace System				Fuel Use		
Air Temp °F	Annual hours	Space Btuh/hr	HW Load Btuh/hr	Furnace Btuh/hr	Furn Run Time	AC Cap Btuh/hr	Clg Run Time	AC kWh	Furnace ccf	HW ccf
92	1	32,223	2,499	0	00.0%	36,954	87.2%	3	0	0
87	23	25,308	2,499	0	00.0%	38,043	66.5%	61	0	1
82	105	18,393	2,499	0	00.0%	39,132	47.0%	210	0	4
77	234	11,478	2,499	0	00.0%	40,222	28.5%	320	0	10
72	404	7,329	2,499	0	00.0%	41,311	17.7%	401	0	17
67	590	0	2,499	0	00.0%	0	00.0%	0	0	25
62	701	0	2,499	0	00.0%	0	00.0%	0	0	30
57	693	-195	2,499	521	00.5%	0	00.0%	0	4	30
52	669	-2,703	2,499	3,388	06.3%	0	00.0%	0	23	29
47	649	-5,211	2,499	6,243	12.1%	0	00.0%	0	41	28
42	629	-7,720	2,499	9,086	17.9%	0	00.0%	0	57	27
37	681	-10,228	2,499	11,917	23.7%	0	00.0%	0	81	29
32	852	-12,736	2,499	14,735	29.5%	0	00.0%	0	126	36
27	649	-15,244	2,499	17,541	35.3%	0	00.0%	0	114	28
22	482	-17,752	2,499	20,335	41.1%	0	00.0%	0	98	21
17	363	-20,260	2,499	23,117	46.9%	0	00.0%	0	84	15
12	309	-22,768	2,499	25,887	52.7%	0	00.0%	0	80	13
7	254	-25,276	2,499	28,645	58.5%	0	00.0%	0	73	11
2	179	-27,785	2,499	31,390	64.3%	0	00.0%	0	56	8
-3	140	-30,293	2,499	34,123	70.1%	0	00.0%	0	48	6
-8	78	-32,801	2,499	36,844	75.9%	0	00.0%	0	29	3
-13	49	-35,309	2,499	39,553	81.7%	0	00.0%	0	19	2
-18	20	-37,817	2,499	42,250	87.5%	0	00.0%	0	8	1
-23	10	-40,325	2,499	44,935	93.3%	0	00.0%	0	4	0
-28	3	-42,833	2,499	47,607	99.2%	0	00.0%	0	1	0
-33	1	-45,342	2,499	47,997	100.0%	0	00.0%	0	0	0
Totals	8768							996	946	374

Table B1-1.51: Annual analysis of heating and cooling loads (in blue and red rectangular boxes on the left side) and traditional HVAC applications covering the heating and cooling loads (in blue and red circular boxes on the right side) for a 2,000 square feet detached house above grade (average construction type) in the city of Barrie

18. Muskoka (Distinct) – Annual Hourly Heating and Cooling Loads Analysis and Coverage
Vertical Ground Source Heat Pump System (V.GSHPs)

Weather		Loads		GeoSmart Energy System					Auxiliary	
Air °F	Annual Hrs hours	Space Load Btuh/hr	DHW Btuh/hr	Geo °F	WF Air Btuh/hr	WF DHW Btuh/hr	WF Run Time	WF KWH kWh	Space kWh	DHW kWh
92	4	32,626	2,499	61	32,626	1,953	100.0%	4	0	1
87	32	25,233	2,499	57	25,233	1,341	100.0%	26	0	12
82	116	17,840	2,499	52	17,840	861	100.0%	62	0	61
77	261	10,447	2,499	48	15,802	649	66.1%	76	0	172
72	439	6,011	2,499	46	15,960	570	37.7%	71	0	319
67	598	0	2,499	48	0	0	0.0%	0	0	476
62	698	0	2,499	48	0	0	0.0%	0	0	556
57	707	-1,513	2,499	49	10,297	1,536	14.7%	81	0	512
52	670	-4,021	2,499	48	10,059	1,504	40.0%	206	0	405
47	640	-6,529	2,499	47	9,823	1,473	66.5%	323	0	310
42	624	-9,037	2,499	46	10,063	1,505	89.8%	439	0	228
37	711	-11,545	2,499	45	12,270	1,806	94.1%	638	0	181
32	770	-14,053	2,499	44	14,472	2,111	97.1%	842	0	110
27	655	-16,561	2,499	43	16,669	2,421	99.3%	849	0	20
22	495	-19,069	2,499	42	19,095	2,503	99.9%	735	0	0
17	391	-21,577	2,499	41	21,604	2,503	99.9%	653	0	0
12	320	-24,085	2,499	40	24,112	2,502	99.9%	595	0	0
7	245	-26,593	2,499	39	26,619	2,502	99.9%	503	0	0
2	175	-29,101	2,499	38	29,127	2,502	99.9%	394	0	0
-3	124	-31,609	2,499	37	31,635	2,502	99.9%	304	0	0
-8	81	-34,116	2,499	36	34,143	2,501	99.9%	216	0	0
-13	46	-36,624	2,499	35	36,651	2,501	99.9%	132	0	0
-18	23	-39,132	2,499	34	39,159	2,501	99.9%	71	0	0
-23	11	-41,640	2,499	33	41,666	2,501	99.9%	36	0	0
-28	5	-44,148	2,499	32	44,174	2,501	99.9%	18	0	0
-33	2	-46,656	2,499	31	46,682	2,501	99.9%	8	0	0
Totals	8843							7281	0	3,362

Table B1-1.52: Annual analysis of heating and cooling loads (in blue and red rectangular boxes on the left side) and vertical ground source heat pump (V.GSHP) unit covering the heating and cooling loads (in blue and red circular boxes on the right side) for a 2,000 square feet detached house above grade (average construction type) in the city of Muskoka

Horizontal Ground Source Heat Pump System (H.GSHPs)

Weather		Loads		GeoSmart Energy System					Auxiliary	
Air	Annual Hrs	Space Load	DHW	Geo	WF Air	WF DHW	WF Run	WF kWh	Space	DHW
°F	hours	Btuh/hr	Btuh/hr	°F	Btuh/hr	Btuh/hr	Time	kWh	kWh	kWh
92	4	32,626	2,499	59	32,626	1,848	100.0%	4	0	1
87	32	25,233	2,499	56	25,233	1,329	100.0%	26	0	12
82	116	17,840	2,499	54	17,840	901	100.0%	63	0	59
77	261	10,447	2,499	51	15,655	723	66.7%	79	0	168
72	439	6,011	2,499	49	15,765	668	38.1%	74	0	314
67	598	0	2,499	48	0	0	0.0%	0	0	476
62	698	0	2,499	48	0	0	0.0%	0	0	556
57	707	-1,513	2,499	46	9,505	1,430	15.9%	84	0	512
52	670	-4,021	2,499	45	9,341	1,408	43.0%	214	0	404
47	640	-6,529	2,499	44	9,178	1,386	71.1%	335	0	308
42	624	-9,037	2,499	43	10,059	1,508	89.8%	452	0	228
37	711	-11,545	2,499	42	12,261	1,814	94.2%	655	0	179
32	770	-14,053	2,499	42	14,460	2,123	97.2%	863	0	107
27	655	-16,561	2,499	41	16,655	2,435	99.4%	867	0	16
22	495	-19,069	2,499	40	19,095	2,503	99.9%	747	0	0
17	391	-21,577	2,499	39	21,603	2,503	99.9%	662	0	0
12	320	-24,085	2,499	39	24,111	2,502	99.9%	601	0	0
7	245	-26,593	2,499	38	26,619	2,502	99.9%	506	0	0
2	175	-29,101	2,499	37	29,127	2,502	99.9%	395	0	0
-3	124	-31,609	2,499	37	31,635	2,502	99.9%	304	0	0
-8	81	-34,116	2,499	36	34,143	2,501	99.9%	215	0	0
-13	46	-36,624	2,499	35	36,651	2,501	99.9%	131	0	0
-18	23	-39,132	2,499	35	39,159	2,501	99.9%	70	0	0
-23	11	-41,640	2,499	34	41,667	2,501	99.9%	36	0	0
-28	5	-44,148	2,499	34	44,175	2,501	99.9%	17	0	0
-33	2	-46,656	2,499	33	46,682	2,501	99.9%	7	0	0
Totals	8843							7409	0	3,339

Table B1-1.53: Annual analysis of heating and cooling loads (in blue and red rectangular boxes on the left side) and horizontal ground source heat pump (H.GSHP) unit covering the heating and cooling loads (in blue and red circular boxes on the right side) for a 2,000 square feet detached house above grade (average construction type) in the city of Muskoka

Traditional HVAC Applications

Weather		Loads		Fossil Furnace System				Fuel Use		
Air Temp °F	Annual hours	Space Btuh/hr	HW Load Btuh/hr	Furnace Btuh/hr	Furn Run Time	AC Cap Btuh/hr	Clg Run Time	AC kWh	Furnace ccf	HW ccf
92	4	32,626	2,499	0	00.0%	36,954	88.3%	14	0	0
87	32	25,233	2,499	0	00.0%	38,043	66.3%	85	0	1
82	116	17,840	2,499	0	00.0%	39,132	45.6%	227	0	5
77	261	10,447	2,499	0	00.0%	40,222	26.0%	336	0	11
72	439	6,011	2,499	0	00.0%	41,311	14.6%	391	0	19
67	598	0	2,499	0	00.0%	0	00.0%	0	0	25
62	698	0	2,499	0	00.0%	0	00.0%	0	0	30
57	707	-1,513	2,499	2,029	03.5%	0	00.0%	0	14	30
52	670	-4,021	2,499	4,889	09.3%	0	00.0%	0	33	29
47	640	-6,529	2,499	7,738	15.1%	0	00.0%	0	50	27
42	624	-9,037	2,499	10,574	20.9%	0	00.0%	0	66	27
37	711	-11,545	2,499	13,398	26.7%	0	00.0%	0	95	30
32	770	-14,053	2,499	16,210	32.5%	0	00.0%	0	125	33
27	655	-16,561	2,499	19,010	38.3%	0	00.0%	0	125	28
22	495	-19,069	2,499	21,797	44.1%	0	00.0%	0	108	21
17	391	-21,577	2,499	24,573	49.9%	0	00.0%	0	96	17
12	320	-24,085	2,499	27,336	55.8%	0	00.0%	0	87	14
7	245	-26,593	2,499	30,087	61.6%	0	00.0%	0	74	10
2	175	-29,101	2,499	32,826	67.4%	0	00.0%	0	57	7
-3	124	-31,609	2,499	35,552	73.2%	0	00.0%	0	44	5
-8	81	-34,116	2,499	38,267	79.0%	0	00.0%	0	31	3
-13	46	-36,624	2,499	40,969	84.8%	0	00.0%	0	19	2
-18	23	-39,132	2,499	43,659	90.6%	0	00.0%	0	10	1
-23	11	-41,640	2,499	46,338	96.4%	0	00.0%	0	5	0
-28	5	-44,148	2,499	47,997	100.0%	0	00.0%	0	2	0
-33	2	-46,656	2,499	47,997	100.0%	0	00.0%	0	1	0
Totals	8843							1052	1,042	377

Table B1-1.54: Annual analysis of heating and cooling loads (in blue and red rectangular boxes on the left side) and traditional HVAC applications covering the heating and cooling loads (in blue and red circular boxes on the right side) for a 2,000 square feet detached house above grade (average construction type) in the city of Muskoka

19. Peterborough (Distinct) – Annual Hourly Heating and Cooling Loads Analysis and Coverage

Vertical Ground Source Heat Pump System (V.GSHPs)

Weather		Loads		GeoSmart Energy System					Auxiliary	
Air °F	Annual Hrs hours	Space Load Btuh/hr	DHW Btuh/hr	Geo °F	WF Air Btuh/hr	WF DHW Btuh/hr	WF Run Time	WF kWh	Space kWh	DHW kWh
92	7	31,579	2,466	61	31,579	1,936	100.0%	8	0	1
87	70	24,469	2,466	57	24,469	1,344	100.0%	55	0	25
82	230	17,359	2,466	53	17,359	876	100.0%	121	0	116
77	424	10,249	2,466	49	15,737	681	65.1%	123	0	273
72	593	5,983	2,466	47	15,889	605	37.7%	97	0	423
67	682	0	2,466	49	0	0	0.0%	0	0	536
62	696	0	2,466	49	0	0	0.0%	0	0	547
57	672	-2,125	2,466	50	10,464	1,559	20.3%	107	0	460
52	634	-4,828	2,466	49	10,207	1,524	47.3%	232	0	352
47	603	-7,530	2,466	48	9,953	1,490	75.7%	348	0	257
42	612	-10,233	2,466	47	11,088	1,643	92.3%	482	0	185
37	747	-12,936	2,466	45	13,467	1,967	96.1%	743	0	137
32	731	-15,638	2,466	44	15,839	2,296	98.7%	882	0	46
27	568	-18,341	2,466	43	18,368	2,470	99.9%	802	0	0
22	449	-21,044	2,466	42	21,071	2,469	99.9%	722	0	0
17	354	-23,746	2,466	41	23,774	2,469	99.9%	640	0	0
12	274	-26,449	2,466	40	26,476	2,469	99.9%	552	0	0
7	198	-29,152	2,466	39	29,179	2,468	99.9%	440	0	0
2	130	-31,854	2,466	38	31,881	2,468	99.9%	317	0	0
-3	80	-34,557	2,466	37	34,584	2,468	99.9%	213	0	0
-8	47	-37,259	2,466	36	37,286	2,468	99.9%	136	0	0
-13	26	-39,962	2,466	35	39,989	2,468	99.9%	81	0	0
-18	13	-42,665	2,466	34	42,691	2,468	99.9%	44	0	0
-23	7	-45,367	2,466	33	45,393	2,467	99.9%	25	0	0
-28	4	-48,070	2,466	32	48,096	2,467	99.9%	15	0	0
-33	1	-50,773	2,466	31	50,798	2,467	99.9%	4	0	0
Totals	8852							7189	0	3,359

Table B1-1.55: Annual analysis of heating and cooling loads (in blue and red rectangular boxes on the left side) and vertical ground source heat pump (V.GSHP) unit covering the heating and cooling loads (in blue and red circular boxes on the right side) for a 2,000 square feet detached house above grade (average construction type) in the city of Peterborough

Horizontal Ground Source Heat Pump System (H.GSHPs)

Weather		Loads		GeoSmart Energy System					Auxiliary	
Air	Annual Hrs	Space Load	DHW	Geo	WF Air	WF DHW	WF Run	WF kWh	Space	DHW
°F	hours	Btuh/hr	Btuh/hr	°F	Btuh/hr	Btuh/hr	Time	kWh	kWh	kWh
92	7	31,579	2,466	60	31,579	1,881	100.0%	8	0	1
87	70	24,469	2,466	58	24,469	1,367	100.0%	56	0	24
82	230	17,359	2,466	55	17,359	938	100.0%	124	0	112
77	424	10,249	2,466	52	15,556	772	65.9%	129	0	264
72	593	5,983	2,466	51	15,662	719	38.2%	103	0	414
67	682	0	2,466	49	0	0	0.0%	0	0	536
62	696	0	2,466	49	0	0	0.0%	0	0	547
57	672	-2,125	2,466	46	9,587	1,441	22.2%	112	0	459
52	634	-4,828	2,466	45	9,410	1,417	51.3%	242	0	351
47	603	-7,530	2,466	44	9,234	1,394	81.5%	363	0	255
42	612	-10,233	2,466	43	11,082	1,648	92.3%	497	0	184
37	747	-12,936	2,466	43	13,455	1,978	96.1%	765	0	134
32	731	-15,638	2,466	42	15,823	2,311	98.8%	906	0	42
27	568	-18,341	2,466	41	18,368	2,470	99.9%	821	0	0
22	449	-21,044	2,466	40	21,070	2,469	99.9%	736	0	0
17	354	-23,746	2,466	39	23,773	2,469	99.9%	651	0	0
12	274	-26,449	2,466	39	26,476	2,469	99.9%	559	0	0
7	198	-29,152	2,466	38	29,178	2,468	99.9%	444	0	0
2	130	-31,854	2,466	37	31,881	2,468	99.9%	319	0	0
-3	80	-34,557	2,466	37	34,584	2,468	99.9%	213	0	0
-8	47	-37,259	2,466	36	37,286	2,468	99.9%	135	0	0
-13	26	-39,962	2,466	35	39,989	2,468	99.9%	81	0	0
-18	13	-42,665	2,466	34	42,691	2,468	99.9%	43	0	0
-23	7	-45,367	2,466	34	45,394	2,467	99.9%	25	0	0
-28	4	-48,070	2,466	33	48,096	2,467	99.9%	15	0	0
-33	1	-50,773	2,466	32	50,799	2,467	99.9%	4	0	0
Totals	8852							7350	0	3,325

Table B1-1.56: Annual analysis of heating and cooling loads (in blue and red rectangular boxes on the left side) and horizontal ground source heat pump (H.GSHP) unit covering the heating and cooling loads (in blue and red circular boxes on the right side) for a 2,000 square feet detached house above grade (average construction type) in the city of Peterborough

Traditional HVAC Applications

Weather		Loads		Fossil Furnace System				Fuel Use		
Air Temp	Annual	Space	HW Load	Furnace	Furn Run	AC Cap	Clg Run	AC	Furnace	HW
°F	hours	Btuh/hr	Btuh/hr	Btuh/hr	Time	Btuh/hr	Time	kWh	ccf	ccf
92	7	31,579	2,466	0	00.0%	31,675	99.7%	22	0	0
87	70	24,469	2,466	0	00.0%	32,608	75.0%	175	0	3
82	230	17,359	2,466	0	00.0%	33,542	51.8%	423	0	10
77	424	10,249	2,466	0	00.0%	34,476	29.7%	512	0	18
72	593	5,983	2,466	0	00.0%	35,409	16.9%	491	0	25
67	682	0	2,466	0	00.0%	0	00.0%	0	0	29
62	696	0	2,466	0	00.0%	0	00.0%	0	0	29
57	672	-2,125	2,466	2,766	04.4%	0	00.0%	0	19	28
52	634	-4,828	2,466	5,847	09.9%	0	00.0%	0	37	27
47	603	-7,530	2,466	8,915	15.5%	0	00.0%	0	54	25
42	612	-10,233	2,466	11,971	21.1%	0	00.0%	0	73	26
37	747	-12,936	2,466	15,014	26.6%	0	00.0%	0	112	31
32	731	-15,638	2,466	18,045	32.2%	0	00.0%	0	132	31
27	568	-18,341	2,466	21,063	37.7%	0	00.0%	0	120	24
22	449	-21,044	2,466	24,069	43.3%	0	00.0%	0	108	19
17	354	-23,746	2,466	27,062	48.9%	0	00.0%	0	96	15
12	274	-26,449	2,466	30,042	54.4%	0	00.0%	0	82	12
7	198	-29,152	2,466	33,010	60.0%	0	00.0%	0	65	8
2	130	-31,854	2,466	35,965	65.5%	0	00.0%	0	47	5
-3	80	-34,557	2,466	38,908	71.1%	0	00.0%	0	31	3
-8	47	-37,259	2,466	41,838	76.7%	0	00.0%	0	20	2
-13	26	-39,962	2,466	44,756	82.2%	0	00.0%	0	12	1
-18	13	-42,665	2,466	47,661	87.8%	0	00.0%	0	6	1
-23	7	-45,367	2,466	50,553	93.3%	0	00.0%	0	4	0
-28	4	-48,070	2,466	53,433	98.9%	0	00.0%	0	2	0
-33	1	-50,773	2,466	53,996	100.0%	0	00.0%	0	1	0
Totals	8852							1623	1,020	372

Table B1-1.57: Annual analysis of heating and cooling loads (in blue and red rectangular boxes on the left side) and traditional HVAC applications covering the heating and cooling loads (in blue and red circular boxes on the right side) for a 2,000 square feet detached house above grade (average construction type) in the city of Peterborough

20. Ottawa (Distinct) – Annual Hourly Heating and Cooling Loads Analysis and Coverage

Vertical Ground Source Heat Pump System (V.GSHPs)

Weather		Loads		GeoSmart Energy System					Auxiliary	
Air °F	Annual Hrs hours	Space Load Btuh/hr	DHW Btuh/hr	Geo °F	WF Air Btuh/hr	WF DHW Btuh/hr	WF Run Time	WF KWH kWh	Space kWh	DHW kWh
97	1	35,301	2,472	63	35,301	2,282	100.0%	1	0	0
92	9	29,023	2,472	60	29,023	1,696	100.0%	9	0	2
87	50	22,745	2,472	56	22,745	1,210	100.0%	36	0	20
82	161	16,466	2,472	53	16,466	818	100.0%	79	0	85
77	319	10,188	2,472	49	15,752	674	64.7%	92	0	207
72	512	6,421	2,472	47	15,887	607	40.4%	90	0	363
67	690	0	2,472	49	0	0	0.0%	0	0	543
62	712	0	2,472	49	0	0	0.0%	0	0	561
57	672	-1,104	2,472	51	10,520	1,566	10.5%	55	0	494
52	621	-3,613	2,472	49	10,281	1,534	35.1%	169	0	382
47	551	-6,121	2,472	48	10,044	1,502	60.9%	258	0	273
42	556	-8,630	2,472	47	9,809	1,471	88.0%	371	0	209
37	653	-11,138	2,472	46	11,891	1,752	93.7%	560	0	173
32	705	-13,647	2,472	45	14,096	2,054	96.8%	742	0	108
27	564	-16,155	2,472	44	16,297	2,362	99.1%	706	0	24
22	476	-18,664	2,472	43	18,691	2,476	99.9%	685	0	0
17	389	-21,172	2,472	42	21,199	2,475	99.9%	631	0	0
12	340	-23,681	2,472	41	23,708	2,475	99.9%	615	0	0
7	275	-26,189	2,472	40	26,216	2,475	99.9%	550	0	0
2	212	-28,698	2,472	39	28,725	2,474	99.9%	465	0	0
-3	150	-31,206	2,472	38	31,233	2,474	99.9%	359	0	0
-8	86	-33,714	2,472	37	33,741	2,474	99.9%	223	0	0
-13	44	-36,223	2,472	36	36,250	2,474	99.9%	124	0	0
-18	15	-38,731	2,472	35	38,758	2,474	99.9%	45	0	0
-23	4	-41,240	2,472	34	41,266	2,474	99.9%	13	0	0
-28	1	-43,748	2,472	33	43,774	2,474	99.9%	3	0	0
-33	1	-46,257	2,472	32	46,283	2,473	99.9%	4	0	0
Totals	8769							6883	0	3,444

Table B1-1.58: Annual analysis of heating and cooling loads (in blue and red rectangular boxes on the left side) and vertical ground source heat pump (V.GSHP) unit covering the heating and cooling loads (in blue and red circular boxes on the right side) for a 2,000 square feet detached house above grade (average construction type) in the city of Ottawa

Horizontal Ground Source Heat Pump System (H.GSHPs)

Weather		Loads		GeoSmart Energy System					Auxiliary	
Air	Annual Hrs	Space Load	DHW	Geo	WF Air	WF DHW	WF Run	WF kWh	Space	DHW
°F	hours	Btuh/hr	Btuh/hr	°F	Btuh/hr	Btuh/hr	Time	kWh	kWh	kWh
97	1	35,301	2,472	62	35,301	2,173	100.0%	1	0	0
92	9	29,023	2,472	59	29,023	1,677	100.0%	9	0	2
87	50	22,745	2,472	57	22,745	1,248	100.0%	36	0	19
82	161	16,466	2,472	54	16,466	885	100.0%	81	0	81
77	319	10,188	2,472	52	15,567	766	65.4%	96	0	200
72	512	6,421	2,472	51	15,660	720	41.0%	95	0	355
67	690	0	2,472	49	0	0	0.0%	0	0	543
62	712	0	2,472	49	0	0	0.0%	0	0	561
57	672	-1,104	2,472	46	9,602	1,443	11.5%	58	0	494
52	621	-3,613	2,472	45	9,437	1,421	38.3%	177	0	381
47	551	-6,121	2,472	45	9,274	1,399	66.0%	269	0	272
42	556	-8,630	2,472	44	9,678	1,455	89.2%	384	0	208
37	653	-11,138	2,472	43	11,882	1,759	93.7%	578	0	171
32	705	-13,647	2,472	42	14,082	2,067	96.9%	764	0	105
27	564	-16,155	2,472	41	16,279	2,378	99.2%	725	0	20
22	476	-18,664	2,472	41	18,690	2,476	99.9%	701	0	0
17	389	-21,172	2,472	40	21,199	2,475	99.9%	643	0	0
12	340	-23,681	2,472	39	23,707	2,475	99.9%	625	0	0
7	275	-26,189	2,472	39	26,216	2,475	99.9%	557	0	0
2	212	-28,698	2,472	38	28,724	2,474	99.9%	470	0	0
-3	150	-31,206	2,472	37	31,233	2,474	99.9%	362	0	0
-8	86	-33,714	2,472	37	33,741	2,474	99.9%	224	0	0
-13	44	-36,223	2,472	36	36,250	2,474	99.9%	124	0	0
-18	15	-38,731	2,472	35	38,758	2,474	99.9%	45	0	0
-23	4	-41,240	2,472	35	41,266	2,474	99.9%	13	0	0
-28	1	-43,748	2,472	34	43,775	2,474	99.9%	3	0	0
-33	1	-46,257	2,472	33	46,283	2,474	99.9%	4	0	0
Totals	8769							7046	0	3,413

Table B1-1.59: Annual analysis of heating and cooling loads (in blue and red rectangular boxes on the left side) and horizontal ground source heat pump (H.GSHP) unit covering the heating and cooling loads (in blue and red circular boxes on the right side) for a 2,000 square feet detached house above grade (average construction type) in the city of Ottawa

Traditional HVAC Applications

Weather		Loads		Fossil Furnace System				Fuel Use		
Air Temp °F	Annual hours	Space Btuh/hr	HW Load Btuh/hr	Furnace Btuh/hr	Furn Run Time	AC Cap Btuh/hr	Clg Run Time	AC kWh	Furnace ccf	HW ccf
97	1	35,301	2,472	0	00.0%	35,865	98.4%	4	0	0
92	9	29,023	2,472	0	00.0%	36,954	78.5%	28	0	0
87	50	22,745	2,472	0	00.0%	38,043	59.8%	123	0	2
82	161	16,466	2,472	0	00.0%	39,132	42.1%	297	0	7
77	319	10,188	2,472	0	00.0%	40,222	25.3%	404	0	13
72	512	6,421	2,472	0	00.0%	41,311	15.5%	472	0	22
67	690	0	2,472	0	00.0%	0	00.0%	0	0	29
62	712	0	2,472	0	00.0%	0	00.0%	0	0	30
57	672	-1,104	2,472	1,562	02.6%	0	00.0%	0	10	28
52	621	-3,613	2,472	4,425	08.4%	0	00.0%	0	27	26
47	551	-6,121	2,472	7,276	14.2%	0	00.0%	0	40	23
42	556	-8,630	2,472	10,115	20.0%	0	00.0%	0	56	23
37	653	-11,138	2,472	12,941	25.8%	0	00.0%	0	85	28
32	705	-13,647	2,472	15,756	31.6%	0	00.0%	0	111	30
27	564	-16,155	2,472	18,558	37.4%	0	00.0%	0	105	24
22	476	-18,664	2,472	21,348	43.2%	0	00.0%	0	102	20
17	389	-21,172	2,472	24,126	49.0%	0	00.0%	0	94	16
12	340	-23,681	2,472	26,892	54.8%	0	00.0%	0	91	14
7	275	-26,189	2,472	29,645	60.6%	0	00.0%	0	82	12
2	212	-28,698	2,472	32,386	66.4%	0	00.0%	0	69	9
-3	150	-31,206	2,472	35,116	72.2%	0	00.0%	0	53	6
-8	86	-33,714	2,472	37,833	78.0%	0	00.0%	0	33	4
-13	44	-36,223	2,472	40,537	83.8%	0	00.0%	0	18	2
-18	15	-38,731	2,472	43,230	89.7%	0	00.0%	0	6	1
-23	4	-41,240	2,472	45,911	95.5%	0	00.0%	0	2	0
-28	1	-43,748	2,472	47,997	100.0%	0	00.0%	0	0	0
-33	1	-46,257	2,472	47,997	100.0%	0	00.0%	0	0	0
Totals	8769							1327	984	370

Table B1-1.60: Annual analysis of heating and cooling loads (in blue and red rectangular boxes on the left side) and traditional HVAC applications covering the heating and cooling loads (in blue and red circular boxes on the right side) for a 2,000 square feet detached house above grade (average construction type) in the city of Ottawa

21. Kapuskasing (North) – Annual Hourly Heating and Cooling Loads Analysis and Coverage

Vertical Ground Source Heat Pump System (V.GSHPs)

Weather		Loads		GeoSmart Energy System					Auxiliary	
Air	Annual Hrs	Space Load	DHW	Geo	WF Air	WF DHW	WF Run	WF KWH	Space	DHW
°F	hours	Btuh/hr	Btuh/hr	°F	Btuh/hr	Btuh/hr	Time	kWh	kWh	kWh
97	1	45,717	2,621	64	45,717	2,621	100.0%	2	0	0
92	6	37,106	2,621	59	37,106	2,059	100.0%	7	0	1
87	30	28,494	2,621	54	28,494	1,346	100.0%	26	0	12
82	87	19,883	2,621	50	19,883	809	100.0%	49	0	50
77	171	11,272	2,621	45	16,031	534	70.3%	51	0	122
72	283	6,105	2,621	42	16,216	442	37.6%	44	0	221
67	410	0	2,621	44	0	0	0.0%	0	0	342
62	525	0	2,621	44	0	0	0.0%	0	0	438
57	588	-1,420	2,621	46	9,487	1,428	15.0%	66	0	451
52	615	-3,929	2,621	44	9,252	1,396	42.5%	193	0	397
47	611	-6,437	2,621	43	9,019	1,365	71.4%	318	0	320
42	594	-8,946	2,621	42	10,084	1,513	88.7%	431	0	242
37	632	-11,454	2,621	41	12,282	1,823	93.3%	587	0	185
32	656	-13,962	2,621	40	14,475	2,138	96.5%	746	0	117
27	579	-16,471	2,621	39	16,664	2,457	98.8%	782	0	35
22	457	-18,979	2,621	38	19,005	2,624	99.9%	712	0	0
17	399	-21,488	2,621	37	21,513	2,624	99.9%	699	0	0
12	380	-23,996	2,621	36	24,022	2,624	99.9%	742	0	0
7	355	-26,504	2,621	35	26,530	2,623	99.9%	766	0	0
2	321	-29,013	2,621	34	29,038	2,623	99.9%	760	0	0
-3	287	-31,521	2,621	33	31,547	2,623	99.9%	741	0	0
-8	249	-34,030	2,621	32	34,055	2,623	99.9%	697	0	0
-13	198	-36,538	2,621	31	36,563	2,623	99.9%	599	0	0
-18	141	-39,046	2,621	30	39,071	2,623	99.9%	459	0	0
-23	90	-41,555	2,621	29	41,579	2,622	99.9%	314	0	0
-28	53	-44,063	2,621	29	44,088	2,622	99.9%	198	0	0
-33	27	-46,572	2,621	28	46,596	2,622	99.9%	107	0	0
Totals	8745							10095	0	2,935

Table B1-1.61: Annual analysis of heating and cooling loads (in blue and red rectangular boxes on the left side) and vertical ground source heat pump (V.GSHP) unit covering the heating and cooling loads (in blue and red circular boxes on the right side) for a 2,000 square feet detached house above grade (average construction type) in the city of Kapuskasing

Horizontal Ground Source Heat Pump System (H.GSHPs)

Weather		Loads		GeoSmart Energy System					Auxiliary	
Air	Annual Hrs	Space Load	DHW	Geo	WF Air	WF DHW	WF Run	WF KWH	Space	DHW
°F	hours	Btuh/hr	Btuh/hr	°F	Btuh/hr	Btuh/hr	Time	kWh	kWh	kWh
97	1	45,717	2,621	60	45,717	2,601	100.0%	2	0	0
92	6	37,106	2,621	57	37,106	1,891	100.0%	7	0	1
87	30	28,494	2,621	54	28,494	1,307	100.0%	26	0	13
82	87	19,883	2,621	50	19,883	844	100.0%	50	0	49
77	171	11,272	2,621	47	15,885	607	71.0%	53	0	119
72	283	6,105	2,621	45	16,014	543	38.1%	46	0	218
67	410	0	2,621	44	0	0	0.0%	0	0	342
62	525	0	2,621	44	0	0	0.0%	0	0	438
57	588	-1,420	2,621	42	8,665	1,317	16.4%	69	0	450
52	615	-3,929	2,621	41	8,504	1,296	46.2%	202	0	396
47	611	-6,437	2,621	40	8,343	1,274	77.2%	332	0	319
42	594	-8,946	2,621	39	10,076	1,520	88.8%	446	0	240
37	632	-11,454	2,621	38	12,269	1,836	93.4%	606	0	183
32	656	-13,962	2,621	38	14,458	2,154	96.6%	768	0	113
27	579	-16,471	2,621	37	16,644	2,477	99.0%	802	0	31
22	457	-18,979	2,621	36	19,004	2,624	99.9%	726	0	0
17	399	-21,488	2,621	35	21,513	2,624	99.9%	711	0	0
12	380	-23,996	2,621	35	24,021	2,624	99.9%	752	0	0
7	355	-26,504	2,621	34	26,530	2,623	99.9%	773	0	0
2	321	-29,013	2,621	33	29,038	2,623	99.9%	764	0	0
-3	287	-31,521	2,621	33	31,547	2,623	99.9%	743	0	0
-8	249	-34,030	2,621	32	34,055	2,623	99.9%	697	0	0
-13	198	-36,538	2,621	32	36,563	2,623	99.9%	596	0	0
-18	141	-39,046	2,621	31	39,071	2,623	99.9%	455	0	0
-23	90	-41,555	2,621	30	41,580	2,622	99.9%	310	0	0
-28	53	-44,063	2,621	30	44,088	2,622	99.9%	195	0	0
-33	27	-46,572	2,621	29	46,596	2,622	99.9%	105	0	0
Totals	8745							10237	0	2,913

Table B1-1.62: Annual analysis of heating and cooling loads (in blue and red rectangular boxes on the left side) and horizontal ground source heat pump (H.GSHP) unit covering the heating and cooling loads (in blue and red circular boxes on the right side) for a 2,000 square feet detached house above grade (average construction type) in the city of Kapuskasing

Traditional HVAC Applications

Weather		Loads		Fossil Furnace System				Fuel Use		
Air Temp °F	Annual hours	Space Btuh/hr	HW Load Btuh/hr	Furnace Btuh/hr	Furn Run Time	AC Cap Btuh/hr	Clg Run Time	AC kWh	Furnace ccf	HW ccf
97	1	45,717	2,621	0	00.0%	46,112	99.1%	5	0	0
92	6	37,106	2,621	0	00.0%	47,512	78.1%	24	0	0
87	30	28,494	2,621	0	00.0%	48,913	58.3%	93	0	1
82	87	19,883	2,621	0	00.0%	50,313	39.5%	197	0	4
77	171	11,272	2,621	0	00.0%	51,714	21.8%	253	0	8
72	283	6,105	2,621	0	00.0%	53,114	11.5%	288	0	13
67	410	0	2,621	0	00.0%	0	00.0%	0	0	18
62	525	0	2,621	0	00.0%	0	00.0%	0	0	23
57	588	-1,420	2,621	1,923	03.3%	0	00.0%	0	11	26
52	615	-3,929	2,621	4,785	09.1%	0	00.0%	0	29	27
47	611	-6,437	2,621	7,634	14.9%	0	00.0%	0	47	27
42	594	-8,946	2,621	10,471	20.7%	0	00.0%	0	62	26
37	632	-11,454	2,621	13,296	26.5%	0	00.0%	0	84	28
32	656	-13,962	2,621	16,109	32.3%	0	00.0%	0	106	29
27	579	-16,471	2,621	18,910	38.1%	0	00.0%	0	109	26
22	457	-18,979	2,621	21,698	43.9%	0	00.0%	0	99	20
17	399	-21,488	2,621	24,474	49.7%	0	00.0%	0	98	18
12	380	-23,996	2,621	27,238	55.5%	0	00.0%	0	104	17
7	355	-26,504	2,621	29,990	61.4%	0	00.0%	0	106	16
2	321	-29,013	2,621	32,730	67.2%	0	00.0%	0	105	14
-3	287	-31,521	2,621	35,458	73.0%	0	00.0%	0	102	13
-8	249	-34,030	2,621	38,173	78.8%	0	00.0%	0	95	11
-13	198	-36,538	2,621	40,876	84.6%	0	00.0%	0	81	9
-18	141	-39,046	2,621	43,567	90.4%	0	00.0%	0	61	6
-23	90	-41,555	2,621	46,246	96.2%	0	00.0%	0	42	4
-28	53	-44,063	2,621	47,997	100.0%	0	00.0%	0	25	2
-33	27	-46,572	2,621	47,997	100.0%	0	00.0%	0	13	1
Totals	8745							859	1,380	390

Table B1-1.63: Annual analysis of heating and cooling loads (in blue and red rectangular boxes on the left side) and traditional HVAC applications covering the heating and cooling loads (in blue and red circular boxes on the right side) for a 2,000 square feet detached house above grade (average construction type) in the city of Kapuskasing

22. Kenora (North) – Annual Hourly Heating and Cooling Loads Analysis and Coverage

Vertical Ground Source Heat Pump System (V.GSHPs)

Weather		Loads		GeoSmart Energy System					Auxiliary	
Air °F	Annual Hrs hours	Space Load Btuh/hr	DHW Btuh/hr	Geo °F	WF Air Btuh/hr	WF DHW Btuh/hr	WF Run Time	WF KWH kWh	Space kWh	DHW kWh
92	4	37,021	2,621	59	37,021	2,051	100.0%	5	0	1
87	25	28,488	2,621	54	28,488	1,345	100.0%	22	0	10
82	95	19,955	2,621	50	19,955	813	100.0%	54	0	55
77	216	11,422	2,621	45	16,026	537	71.3%	65	0	154
72	373	6,302	2,621	42	16,209	446	38.9%	59	0	291
67	543	0	2,621	44	0	0	0.0%	0	0	453
62	663	0	2,621	44	0	0	0.0%	0	0	553
57	673	-1,223	2,621	46	9,506	1,430	12.9%	65	0	522
52	620	-3,731	2,621	44	9,271	1,399	40.2%	184	0	406
47	561	-6,240	2,621	43	9,038	1,367	69.0%	283	0	300
42	525	-8,748	2,621	42	9,910	1,489	88.3%	373	0	218
37	537	-11,256	2,621	41	12,109	1,798	93.0%	490	0	162
32	559	-13,765	2,621	40	14,303	2,113	96.2%	626	0	105
27	527	-16,273	2,621	39	16,491	2,432	98.7%	703	0	37
22	466	-18,782	2,621	38	18,807	2,624	99.9%	718	0	0
17	424	-21,290	2,621	37	21,316	2,624	99.9%	736	0	0
12	383	-23,798	2,621	36	23,824	2,624	99.9%	742	0	0
7	342	-26,307	2,621	35	26,332	2,623	99.9%	732	0	0
2	302	-28,815	2,621	34	28,841	2,623	99.9%	710	0	0
-3	266	-31,324	2,621	33	31,349	2,623	99.9%	682	0	0
-8	228	-33,832	2,621	32	33,857	2,623	99.9%	634	0	0
-13	181	-36,340	2,621	31	36,365	2,623	99.9%	544	0	0
-18	123	-38,849	2,621	30	38,874	2,623	99.9%	398	0	0
-23	71	-41,357	2,621	29	41,382	2,622	99.9%	246	0	0
-28	35	-43,866	2,621	29	43,890	2,622	99.9%	130	0	0
-33	13	-46,374	2,621	28	46,398	2,622	99.9%	51	0	0
Totals	8755							9255	0	3,268

Table B1-1.64: Annual analysis of heating and cooling loads (in blue and red rectangular boxes on the left side) and vertical ground source heat pump (V.GSHP) unit covering the heating and cooling loads (in blue and red circular boxes on the right side) for a 2,000 square feet detached house above grade (average construction type) in the city of Kenora

Horizontal Ground Source Heat Pump System (H.GSHPs)

Weather		Loads		GeoSmart Energy System					Auxiliary	
Air	Annual Hrs	Space Load	DHW	Geo	WF Air	WF DHW	WF Run	WF kWh	Space	DHW
°F	hours	Btuh/hr	Btuh/hr	°F	Btuh/hr	Btuh/hr	Time	kWh	kWh	kWh
92	4	37,021	2,621	57	37,021	1,885	100.0%	5	0	1
87	25	28,488	2,621	54	28,488	1,307	100.0%	22	0	10
82	95	19,955	2,621	50	19,955	847	100.0%	55	0	54
77	216	11,422	2,621	47	15,881	609	71.9%	68	0	150
72	373	6,302	2,621	45	16,009	546	39.4%	62	0	286
67	543	0	2,621	44	0	0	0.0%	0	0	453
62	663	0	2,621	44	0	0	0.0%	0	0	553
57	673	-1,223	2,621	42	8,678	1,319	14.1%	68	0	522
52	620	-3,731	2,621	41	8,516	1,297	43.8%	193	0	405
47	561	-6,240	2,621	40	8,356	1,276	74.7%	295	0	298
42	525	-8,748	2,621	39	9,903	1,496	88.3%	386	0	217
37	537	-11,256	2,621	38	12,096	1,811	93.1%	506	0	160
32	559	-13,765	2,621	38	14,286	2,129	96.4%	645	0	101
27	527	-16,273	2,621	37	16,472	2,451	98.8%	721	0	33
22	466	-18,782	2,621	36	18,807	2,624	99.9%	733	0	0
17	424	-21,290	2,621	35	21,315	2,624	99.9%	749	0	0
12	383	-23,798	2,621	35	23,824	2,624	99.9%	752	0	0
7	342	-26,307	2,621	34	26,332	2,623	99.9%	739	0	0
2	302	-28,815	2,621	34	28,840	2,623	99.9%	714	0	0
-3	266	-31,324	2,621	33	31,349	2,623	99.9%	684	0	0
-8	228	-33,832	2,621	32	33,857	2,623	99.9%	634	0	0
-13	181	-36,340	2,621	32	36,365	2,623	99.9%	542	0	0
-18	123	-38,849	2,621	31	38,874	2,623	99.9%	395	0	0
-23	71	-41,357	2,621	30	41,382	2,622	99.9%	244	0	0
-28	35	-43,866	2,621	30	43,890	2,622	99.9%	128	0	0
-33	13	-46,374	2,621	29	46,399	2,622	99.9%	50	0	0
Totals	8755							9391	0	3,245

Table B1-1.65: Annual analysis of heating and cooling loads (in blue and red rectangular boxes on the left side) and horizontal ground source heat pump (H.GSHP) unit covering the heating and cooling loads (in blue and red circular boxes on the right side) for a 2,000 square feet detached house above grade (average construction type) in the city of Kenora

Traditional HVAC Applications

Weather		Loads		Fossil Furnace System				Fuel Use		
Air Temp °F	Annual hours	Space Btuh/hr	HW Load Btuh/hr	Furnace Btuh/hr	Furn Run Time	AC Cap Btuh/hr	Clg Run Time	AC kWh	Furnace ccf	HW ccf
92	4	37,021	2,621	0	00.0%	42,233	87.7%	15	0	0
87	25	28,488	2,621	0	00.0%	43,478	65.5%	75	0	1
82	95	19,955	2,621	0	00.0%	44,723	44.6%	209	0	4
77	216	11,422	2,621	0	00.0%	45,968	24.8%	309	0	10
72	373	6,302	2,621	0	00.0%	47,212	13.3%	363	0	17
67	543	0	2,621	0	00.0%	0	00.0%	0	0	24
62	663	0	2,621	0	00.0%	0	00.0%	0	0	30
57	673	-1,223	2,621	1,697	02.8%	0	00.0%	0	11	30
52	620	-3,731	2,621	4,560	08.6%	0	00.0%	0	28	28
47	561	-6,240	2,621	7,410	14.4%	0	00.0%	0	42	25
42	525	-8,748	2,621	10,248	20.2%	0	00.0%	0	54	23
37	537	-11,256	2,621	13,074	26.1%	0	00.0%	0	70	24
32	559	-13,765	2,621	15,888	31.9%	0	00.0%	0	89	25
27	527	-16,273	2,621	18,689	37.7%	0	00.0%	0	98	23
22	466	-18,782	2,621	21,479	43.5%	0	00.0%	0	100	21
17	424	-21,290	2,621	24,256	49.3%	0	00.0%	0	103	19
12	383	-23,798	2,621	27,021	55.1%	0	00.0%	0	103	17
7	342	-26,307	2,621	29,774	60.9%	0	00.0%	0	102	15
2	302	-28,815	2,621	32,515	66.7%	0	00.0%	0	98	13
-3	266	-31,324	2,621	35,243	72.5%	0	00.0%	0	94	12
-8	228	-33,832	2,621	37,960	78.3%	0	00.0%	0	87	10
-13	181	-36,340	2,621	40,664	84.1%	0	00.0%	0	74	8
-18	123	-38,849	2,621	43,356	89.9%	0	00.0%	0	53	5
-23	71	-41,357	2,621	46,036	95.7%	0	00.0%	0	33	3
-28	35	-43,866	2,621	47,997	100.0%	0	00.0%	0	17	2
-33	13	-46,374	2,621	47,997	100.0%	0	00.0%	0	6	1
Totals	8755							971	1,262	390

Table B1-1.66: Annual analysis of heating and cooling loads (in blue and red rectangular boxes on the left side) and traditional HVAC applications covering the heating and cooling loads (in blue and red circular boxes on the right side) for a 2,000 square feet detached house above grade (average construction type) in the city of Kenora

23. North Bay (North) – Annual Hourly Heating and Cooling Loads Analysis and Coverage
Vertical Ground Source Heat Pump System (V.GSHPs)

Weather		Loads		GeoSmart Energy System					Auxiliary	
Air °F	Annual Hrs hours	Space Load Btuh/hr	DHW Btuh/hr	Geo °F	WF Air Btuh/hr	WF DHW Btuh/hr	WF Run Time	WF KWH kWh	Space kWh	DHW kWh
92	1	34,514	2,509	61	34,514	2,108	100.0%	1	0	0
87	12	26,908	2,509	57	26,908	1,450	100.0%	10	0	4
82	59	19,302	2,509	53	19,302	933	100.0%	34	0	30
77	173	11,696	2,509	49	15,777	662	74.1%	57	0	111
72	359	7,133	2,509	46	15,939	580	44.7%	69	0	257
67	580	0	2,509	47	0	0	0.0%	0	0	463
62	724	0	2,509	47	0	0	0.0%	0	0	578
57	731	-392	2,509	50	10,342	1,542	3.8%	22	0	570
52	678	-2,900	2,509	49	10,104	1,510	28.7%	150	0	448
47	605	-5,408	2,509	47	9,867	1,479	54.8%	252	0	327
42	573	-7,916	2,509	46	9,632	1,447	82.2%	354	0	241
37	624	-10,424	2,509	45	11,291	1,673	92.3%	507	0	192
32	694	-12,932	2,509	44	13,495	1,977	95.8%	700	0	136
27	613	-15,440	2,509	43	15,694	2,285	98.4%	741	0	51
22	499	-17,948	2,509	42	17,975	2,512	99.9%	703	0	0
17	431	-20,456	2,509	41	20,483	2,512	99.9%	686	0	0
12	381	-22,964	2,509	40	22,991	2,511	99.9%	678	0	0
7	322	-25,472	2,509	39	25,499	2,511	99.9%	635	0	0
2	252	-27,980	2,509	38	28,007	2,511	99.9%	547	0	0
-3	188	-30,488	2,509	37	30,515	2,511	99.9%	446	0	0
-8	129	-32,996	2,509	36	33,023	2,511	99.9%	333	0	0
-13	77	-35,504	2,509	35	35,531	2,510	99.9%	215	0	0
-18	38	-38,012	2,509	34	38,039	2,510	99.9%	114	0	0
-23	15	-40,520	2,509	33	40,546	2,510	99.9%	48	0	0
-28	5	-43,029	2,509	32	43,054	2,510	99.9%	17	0	0
-33	1	-45,537	2,509	31	45,562	2,510	99.9%	4	0	0
Totals	8764							7325	0	3,409

Table B1-1.67: Annual analysis of heating and cooling loads (in blue and red rectangular boxes on the left side) and vertical ground source heat pump (V.GSHP) unit covering the heating and cooling loads (in blue and red circular boxes on the right side) for a 2,000 square feet detached house above grade (average construction type) in the city of North Bay

Horizontal Ground Source Heat Pump System (H.GSHPs)

Weather		Loads		GeoSmart Energy System					Auxiliary	
Air	Annual Hrs	Space Load	DHW	Geo	WF Air	WF DHW	WF Run	WF kWh	Space	DHW
°F	hours	Btuh/hr	Btuh/hr	°F	Btuh/hr	Btuh/hr	Time	kWh	kWh	kWh
92	1	34,514	2,509	60	34,514	2,016	100.0%	1	0	0
87	12	26,908	2,509	57	26,908	1,454	100.0%	10	0	4
82	59	19,302	2,509	54	19,302	990	100.0%	35	0	29
77	173	11,696	2,509	51	15,606	747	74.9%	59	0	107
72	359	7,133	2,509	50	15,719	690	45.4%	73	0	251
67	580	0	2,509	47	0	0	0.0%	0	0	463
62	724	0	2,509	47	0	0	0.0%	0	0	578
57	731	-392	2,509	45	9,398	1,416	4.2%	23	0	570
52	678	-2,900	2,509	44	9,234	1,394	31.4%	157	0	447
47	605	-5,408	2,509	44	9,072	1,372	59.6%	264	0	326
42	573	-7,916	2,509	43	9,081	1,374	87.2%	369	0	239
37	624	-10,424	2,509	42	11,283	1,680	92.4%	525	0	190
32	694	-12,932	2,509	41	13,481	1,990	95.9%	723	0	133
27	613	-15,440	2,509	40	15,676	2,302	98.5%	763	0	47
22	499	-17,948	2,509	40	17,974	2,512	99.9%	721	0	0
17	431	-20,456	2,509	39	20,482	2,512	99.9%	701	0	0
12	381	-22,964	2,509	38	22,990	2,511	99.9%	691	0	0
7	322	-25,472	2,509	38	25,499	2,511	99.9%	645	0	0
2	252	-27,980	2,509	37	28,007	2,511	99.9%	554	0	0
-3	188	-30,488	2,509	36	30,515	2,511	99.9%	450	0	0
-8	129	-32,996	2,509	36	33,023	2,511	99.9%	334	0	0
-13	77	-35,504	2,509	35	35,531	2,510	99.9%	215	0	0
-18	38	-38,012	2,509	34	38,039	2,510	99.9%	114	0	0
-23	15	-40,520	2,509	34	40,547	2,510	99.9%	48	0	0
-28	5	-43,029	2,509	33	43,054	2,510	99.9%	17	0	0
-33	1	-45,537	2,509	32	45,562	2,510	99.9%	4	0	0
Totals	8764							7497	0	3,385

Table B1-1.68: Annual analysis of heating and cooling loads (in blue and red rectangular boxes on the left side) and horizontal ground source heat pump (H.GSHP) unit covering the heating and cooling loads (in blue and red circular boxes on the right side) for a 2,000 square feet detached house above grade (average construction type) in the city of North Bay

Traditional HVAC Applications

Weather		Loads		Fossil Furnace System				Fuel Use		
Air Temp °F	Annual hours	Space Btuh/hr	HW Load Btuh/hr	Furnace Btuh/hr	Furn Run Time	AC Cap Btuh/hr	Clg Run Time	AC kWh	Furnace ccf	HW ccf
92	1	34,514	2,509	0	00.0%	36,954	93.4%	4	0	0
87	12	26,908	2,509	0	00.0%	38,043	70.7%	33	0	1
82	59	19,302	2,509	0	00.0%	39,132	49.3%	122	0	3
77	173	11,696	2,509	0	00.0%	40,222	29.1%	240	0	7
72	359	7,133	2,509	0	00.0%	41,311	17.3%	351	0	15
67	580	0	2,509	0	00.0%	0	00.0%	0	0	25
62	724	0	2,509	0	00.0%	0	00.0%	0	0	31
57	731	-392	2,509	746	00.9%	0	00.0%	0	5	31
52	678	-2,900	2,509	3,612	06.7%	0	00.0%	0	24	29
47	605	-5,408	2,509	6,466	12.5%	0	00.0%	0	39	26
42	573	-7,916	2,509	9,308	18.3%	0	00.0%	0	53	25
37	624	-10,424	2,509	12,138	24.1%	0	00.0%	0	76	27
32	694	-12,932	2,509	14,955	29.9%	0	00.0%	0	104	30
27	613	-15,440	2,509	17,760	35.7%	0	00.0%	0	109	26
22	499	-17,948	2,509	20,553	41.5%	0	00.0%	0	103	21
17	431	-20,456	2,509	23,334	47.4%	0	00.0%	0	101	18
12	381	-22,964	2,509	26,103	53.2%	0	00.0%	0	99	16
7	322	-25,472	2,509	28,859	59.0%	0	00.0%	0	93	14
2	252	-27,980	2,509	31,604	64.8%	0	00.0%	0	80	11
-3	188	-30,488	2,509	34,336	70.6%	0	00.0%	0	65	8
-8	129	-32,996	2,509	37,056	76.4%	0	00.0%	0	48	6
-13	77	-35,504	2,509	39,764	82.2%	0	00.0%	0	31	3
-18	38	-38,012	2,509	42,460	88.0%	0	00.0%	0	16	2
-23	15	-40,520	2,509	45,143	93.8%	0	00.0%	0	7	1
-28	5	-43,029	2,509	47,814	99.6%	0	00.0%	0	2	0
-33	1	-45,537	2,509	47,997	100.0%	0	00.0%	0	0	0
Totals	8764							750	1,055	375

Table B1-1.69: Annual analysis of heating and cooling loads (in blue and red rectangular boxes on the left side) and traditional HVAC applications covering the heating and cooling loads (in blue and red circular boxes on the right side) for a 2,000 square feet detached house above grade (average construction type) in the city of North Bay

24. Sault Ste. Marie (North) – Annual Hourly Heating and Cooling Loads Analysis and Coverage

Vertical Ground Source Heat Pump System (V.GSHPs)

Weather		Loads		GeoSmart Energy System					Auxiliary	
Air °F	Annual Hrs hours	Space Load Btuh/hr	DHW Btuh/hr	Geo °F	WF Air Btuh/hr	WF DHW Btuh/hr	WF Run Time	WF Kw/H kWh	Space kWh	DHW kWh
92	1	32,640	2,509	64	32,640	2,377	100.0%	1	0	0
87	18	25,238	2,509	59	25,238	1,489	100.0%	12	0	6
82	89	17,836	2,509	54	17,836	835	100.0%	41	0	47
77	191	10,434	2,509	50	13,325	489	78.3%	54	0	129
72	329	5,993	2,509	47	13,500	413	44.4%	51	0	244
67	490	0	2,509	47	0	0	0.0%	0	0	391
62	659	0	2,509	47	0	0	0.0%	0	0	526
57	714	-1,532	2,509	49	8,500	933	18.0%	82	0	532
52	725	-4,041	2,509	48	8,282	909	48.8%	223	0	477
47	658	-6,549	2,509	46	8,181	902	80.1%	333	0	374
42	624	-9,058	2,509	45	10,366	1,224	87.4%	431	0	286
37	668	-11,566	2,509	43	12,547	1,552	92.2%	588	0	229
32	842	-14,074	2,509	42	14,722	1,885	95.6%	906	0	189
27	683	-16,583	2,509	41	16,891	2,224	98.2%	872	0	71
22	523	-19,091	2,509	39	19,112	2,511	99.9%	775	0	0
17	431	-21,600	2,509	38	21,620	2,511	99.9%	718	0	0
12	368	-24,108	2,509	37	24,129	2,511	99.9%	683	0	0
7	281	-26,617	2,509	35	26,637	2,510	99.9%	576	0	0
2	201	-29,125	2,509	34	29,145	2,510	99.9%	453	0	0
-3	126	-31,634	2,509	33	31,654	2,510	99.9%	310	0	0
-8	77	-34,142	2,509	32	34,162	2,510	99.9%	206	0	0
-13	32	-36,651	2,509	31	36,670	2,510	99.9%	92	0	0
-18	13	-39,159	2,509	30	39,179	2,510	100.0%	40	0	0
-23	3	-41,668	2,509	29	41,687	2,510	100.0%	10	0	0
Totals	8746							7455	0	3,503

Table B1-1.70: Annual analysis of heating and cooling loads (in blue and red rectangular boxes on the left side) and vertical ground source heat pump (V.GSHP) unit covering the heating and cooling loads (in blue and red circular boxes on the right side) for a 2,000 square feet detached house above grade (average construction type) in the city of Sault Ste. Marie

Horizontal Ground Source Heat Pump System (H.GSHPs)

Weather		Loads		GeoSmart Energy System					Auxiliary	
Air °F	Annual Hrs hours	Space Load Btuh/hr	DHW Btuh/hr	Geo °F	WF Air Btuh/hr	WF DHW Btuh/hr	WF Run Time	WF KWH kWh	Space kWh	DHW kWh
92	1	32,640	2,509	62	32,640	2,192	100.0%	1	0	0
87	18	25,238	2,509	59	25,238	1,453	100.0%	11	0	6
82	89	17,836	2,509	55	17,836	872	100.0%	41	0	46
77	191	10,434	2,509	52	13,187	549	79.1%	55	0	126
72	329	5,993	2,509	50	13,309	496	45.0%	53	0	239
67	490	0	2,509	47	0	0	0.0%	0	0	391
62	659	0	2,509	47	0	0	0.0%	0	0	526
57	714	-1,532	2,509	45	7,808	856	19.6%	86	0	532
52	725	-4,041	2,509	44	7,658	840	52.8%	233	0	477
47	658	-6,549	2,509	43	8,163	919	80.2%	343	0	371
42	624	-9,058	2,509	42	10,345	1,245	87.6%	444	0	282
37	668	-11,566	2,509	41	12,522	1,576	92.4%	605	0	224
32	842	-14,074	2,509	40	14,696	1,910	95.8%	928	0	182
27	683	-16,583	2,509	39	16,866	2,248	98.3%	890	0	65
22	523	-19,091	2,509	38	19,111	2,511	99.9%	786	0	0
17	431	-21,600	2,509	37	21,620	2,511	99.9%	726	0	0
12	368	-24,108	2,509	36	24,129	2,511	99.9%	688	0	0
7	281	-26,617	2,509	35	26,637	2,510	99.9%	578	0	0
2	201	-29,125	2,509	34	29,145	2,510	99.9%	452	0	0
-3	126	-31,634	2,509	34	31,654	2,510	99.9%	308	0	0
-8	77	-34,142	2,509	33	34,162	2,510	99.9%	204	0	0
-13	32	-36,651	2,509	32	36,671	2,510	99.9%	91	0	0
-18	13	-39,159	2,509	31	39,179	2,510	99.9%	40	0	0
-23	3	-41,668	2,509	30	41,687	2,510	100.0%	10	0	0
Totals	8746							7574	0	3,470

Table B1-1.71: Annual analysis of heating and cooling loads (in blue and red rectangular boxes on the left side) and horizontal ground source heat pump (H.GSHP) unit covering the heating and cooling loads (in blue and red circular boxes on the right side) for a 2,000 square feet detached house above grade (average construction type) in the city of Sault Ste. Marie

Traditional HVAC Applications

Weather		Loads		Fossil Furnace System				Fuel Use		
Air Temp °F	Annual hours	Space Btuh/hr	HW Load Btuh/hr	Furnace Btuh/hr	Furn Run Time	AC Cap Btuh/hr	Clg Run Time	AC kWh	Furnace ccf	HW ccf
92	1	32,640	2,509	0	00.0%	36,954	88.3%	3	0	0
87	18	25,238	2,509	0	00.0%	38,043	66.3%	48	0	1
82	89	17,836	2,509	0	00.0%	39,132	45.6%	174	0	4
77	191	10,434	2,509	0	00.0%	40,222	25.9%	246	0	8
72	329	5,993	2,509	0	00.0%	41,311	14.5%	292	0	14
67	490	0	2,509	0	00.0%	0	00.0%	0	0	21
62	659	0	2,509	0	00.0%	0	00.0%	0	0	28
57	714	-1,532	2,509	2,014	04.1%	0	00.0%	0	14	31
52	725	-4,041	2,509	4,873	10.7%	0	00.0%	0	35	31
47	658	-6,549	2,509	7,718	17.3%	0	00.0%	0	51	28
42	624	-9,058	2,509	10,549	24.0%	0	00.0%	0	66	27
37	668	-11,566	2,509	13,366	30.6%	0	00.0%	0	89	29
32	842	-14,074	2,509	16,170	37.2%	0	00.0%	0	136	36
27	683	-16,583	2,509	18,959	43.9%	0	00.0%	0	129	29
22	523	-19,091	2,509	21,735	50.5%	0	00.0%	0	114	22
17	431	-21,600	2,509	24,497	57.1%	0	00.0%	0	106	18
12	368	-24,108	2,509	27,244	63.8%	0	00.0%	0	100	16
7	281	-26,617	2,509	29,978	70.4%	0	00.0%	0	84	12
2	201	-29,125	2,509	32,698	77.1%	0	00.0%	0	66	9
-3	126	-31,634	2,509	35,404	83.7%	0	00.0%	0	45	5
-8	77	-34,142	2,509	38,096	90.3%	0	00.0%	0	29	3
-13	32	-36,651	2,509	40,775	97.0%	0	00.0%	0	13	1
-18	13	-39,159	2,509	41,997	100.0%	0	00.0%	0	5	1
-23	3	-41,668	2,509	41,997	100.0%	0	00.0%	0	1	0
Totals	8746							763	1,084	374

Table B1-1.72: Annual analysis of heating and cooling loads (in blue and red rectangular boxes on the left side) and traditional HVAC applications covering the heating and cooling loads (in blue and red circular boxes on the right side) for a 2,000 square feet detached house above grade (average construction type) in the city of Sault Ste. Marie

25. Sudbury (North) – Annual Hourly Heating and Cooling Loads Analysis and Coverage
Vertical Ground Source Heat Pump System (V.GSHPs)

Weather		Loads		GeoSmart Energy System					Auxiliary	
Air °F	Annual Hrs hours	Space Load Btuh/hr	DHW Btuh/hr	Geo °F	WF Air Btuh/hr	WF DHW Btuh/hr	WF Run Time	WF KWH kWh	Space kWh	DHW kWh
97	1	37,733	2,509	63	37,733	2,432	100.0%	1	0	0
92	4	30,828	2,509	59	30,828	1,771	100.0%	4	0	1
87	29	23,924	2,509	56	23,924	1,230	100.0%	22	0	12
82	91	17,019	2,509	52	17,019	804	100.0%	46	0	49
77	201	10,115	2,509	48	15,833	634	63.9%	56	0	135
72	353	5,972	2,509	46	15,980	560	37.4%	56	0	258
67	540	0	2,509	47	0	0	0.0%	0	0	431
62	677	0	2,509	47	0	0	0.0%	0	0	541
57	708	-1,553	2,509	49	10,232	1,527	15.2%	83	0	513
52	665	-4,061	2,509	48	9,994	1,496	40.6%	207	0	403
47	588	-6,569	2,509	47	9,759	1,464	67.3%	299	0	285
42	556	-9,077	2,509	46	10,106	1,511	89.8%	394	0	204
37	624	-11,585	2,509	45	12,312	1,813	94.1%	563	0	160
32	691	-14,093	2,509	43	14,514	2,119	97.1%	761	0	99
27	604	-16,601	2,509	42	16,711	2,430	99.3%	788	0	18
22	490	-19,110	2,509	41	19,136	2,512	99.9%	732	0	0
17	425	-21,618	2,509	40	21,645	2,512	99.9%	714	0	0
12	384	-24,126	2,509	39	24,153	2,511	99.9%	718	0	0
7	337	-26,634	2,509	38	26,661	2,511	99.9%	696	0	0
2	268	-29,142	2,509	37	29,169	2,511	99.9%	607	0	0
-3	205	-31,650	2,509	36	31,677	2,511	99.9%	506	0	0
-8	145	-34,158	2,509	36	34,185	2,510	99.9%	388	0	0
-13	86	-36,666	2,509	35	36,693	2,510	99.9%	248	0	0
-18	44	-39,175	2,509	34	39,201	2,510	99.9%	137	0	0
-23	19	-41,683	2,509	33	41,709	2,510	99.9%	63	0	0
-28	7	-44,191	2,509	32	44,217	2,510	99.9%	25	0	0
-33	2	-46,699	2,509	31	46,724	2,510	99.9%	8	0	0
Totals	8744							8121	0	3,110

Table B1-1.73: Annual analysis of heating and cooling loads (in blue and red rectangular boxes on the left side) and vertical ground source heat pump (V.GSHP) unit covering the heating and cooling loads (in blue and red circular boxes on the right side) for a 2,000 square feet detached house above grade (average construction type) in the city of Sudbury

Horizontal Ground Source Heat Pump System (H.GSHPs)

Weather		Loads		GeoSmart Energy System					Auxiliary	
Air	Annual Hrs	Space Load	DHW	Geo	WF Air	WF DHW	WF Run	WF Kw/H	Space	DHW
°F	hours	Btuh/hr	Btuh/hr	°F	Btuh/hr	Btuh/hr	Time	kWh	kWh	kWh
97	1	37,733	2,509	61	37,733	2,284	100.0%	1	0	0
92	4	30,828	2,509	59	30,828	1,731	100.0%	4	0	1
87	29	23,924	2,509	56	23,924	1,261	100.0%	22	0	12
82	91	17,019	2,509	53	17,019	869	100.0%	47	0	48
77	201	10,115	2,509	51	15,645	727	64.6%	59	0	130
72	353	5,972	2,509	49	15,748	676	37.9%	60	0	253
67	540	0	2,509	47	0	0	0.0%	0	0	431
62	677	0	2,509	47	0	0	0.0%	0	0	541
57	708	-1,553	2,509	45	9,322	1,405	16.7%	87	0	513
52	665	-4,061	2,509	44	9,159	1,384	44.3%	217	0	401
47	588	-6,569	2,509	43	8,996	1,362	73.0%	313	0	284
42	556	-9,077	2,509	42	10,101	1,515	89.9%	408	0	203
37	624	-11,585	2,509	42	12,301	1,823	94.2%	582	0	157
32	691	-14,093	2,509	41	14,498	2,134	97.2%	785	0	96
27	604	-16,601	2,509	40	16,691	2,449	99.5%	810	0	14
22	490	-19,110	2,509	39	19,136	2,512	99.9%	749	0	0
17	425	-21,618	2,509	39	21,644	2,512	99.9%	728	0	0
12	384	-24,126	2,509	38	24,152	2,511	99.9%	730	0	0
7	337	-26,634	2,509	37	26,660	2,511	99.9%	705	0	0
2	268	-29,142	2,509	37	29,169	2,511	99.9%	613	0	0
-3	205	-31,650	2,509	36	31,677	2,511	99.9%	509	0	0
-8	145	-34,158	2,509	35	34,185	2,510	99.9%	389	0	0
-13	86	-36,666	2,509	35	36,693	2,510	99.9%	249	0	0
-18	44	-39,175	2,509	34	39,201	2,510	99.9%	136	0	0
-23	19	-41,683	2,509	33	41,709	2,510	99.9%	63	0	0
-28	7	-44,191	2,509	33	44,217	2,510	99.9%	25	0	0
-33	2	-46,699	2,509	32	46,725	2,510	99.9%	7	0	0
Totals	8744							8300	0	3,084

Table B1-1.74: Annual analysis of heating and cooling loads (in blue and red rectangular boxes on the left side) and horizontal ground source heat pump (H.GSHP) unit covering the heating and cooling loads (in blue and red circular boxes on the right side) for a 2,000 square feet detached house above grade (average construction type) in the city of Sudbury

Traditional HVAC Applications

Weather		Loads		Fossil Furnace System				Fuel Use		
Air Temp °F	Annual hours	Space Btuh/hr	HW Load Btuh/hr	Furnace Btuh/hr	Furn Run Time	AC Cap Btuh/hr	Clg Run Time	AC kWh	Furnace ccf	HW ccf
97	1	37,733	2,509	0	00.0%	40,988	92.1%	4	0	0
92	4	30,828	2,509	0	00.0%	42,233	73.0%	13	0	0
87	29	23,924	2,509	0	00.0%	43,478	55.0%	76	0	1
82	91	17,019	2,509	0	00.0%	44,723	38.1%	178	0	4
77	201	10,115	2,509	0	00.0%	45,968	22.0%	266	0	9
72	353	5,972	2,509	0	00.0%	47,212	12.6%	334	0	15
67	540	0	2,509	0	00.0%	0	00.0%	0	0	23
62	677	0	2,509	0	00.0%	0	00.0%	0	0	29
57	708	-1,553	2,509	2,075	03.6%	0	00.0%	0	15	30
52	665	-4,061	2,509	4,935	09.4%	0	00.0%	0	33	28
47	588	-6,569	2,509	7,784	15.2%	0	00.0%	0	46	25
42	556	-9,077	2,509	10,620	21.0%	0	00.0%	0	59	24
37	624	-11,585	2,509	13,444	26.8%	0	00.0%	0	84	27
32	691	-14,093	2,509	16,256	32.6%	0	00.0%	0	112	30
27	604	-16,601	2,509	19,055	38.4%	0	00.0%	0	115	26
22	490	-19,110	2,509	21,843	44.2%	0	00.0%	0	107	21
17	425	-21,618	2,509	24,618	50.0%	0	00.0%	0	105	18
12	384	-24,126	2,509	27,381	55.8%	0	00.0%	0	105	16
7	337	-26,634	2,509	30,132	61.7%	0	00.0%	0	102	14
2	268	-29,142	2,509	32,871	67.5%	0	00.0%	0	88	11
-3	205	-31,650	2,509	35,598	73.3%	0	00.0%	0	73	9
-8	145	-34,158	2,509	38,312	79.1%	0	00.0%	0	56	6
-13	86	-36,666	2,509	41,014	84.9%	0	00.0%	0	35	4
-18	44	-39,175	2,509	43,705	90.7%	0	00.0%	0	19	2
-23	19	-41,683	2,509	46,383	96.5%	0	00.0%	0	9	1
-28	7	-44,191	2,509	47,997	100.0%	0	00.0%	0	3	0
-33	2	-46,699	2,509	47,997	100.0%	0	00.0%	0	1	0
Totals	8744							872	1,166	374

Table B1-1.75: Annual analysis of heating and cooling loads (in blue and red rectangular boxes on the left side) and traditional HVAC applications covering the heating and cooling loads (in blue and red circular boxes on the right side) for a 2,000 square feet detached house above grade (average construction type) in the city of Sudbury

26. Thunder Bay (North) – Annual Hourly Heating and Cooling Loads Analysis and Coverage

Vertical Ground Source Heat Pump System (V.GSHPs)

Weather		Loads		GeoSmart Energy System					Auxiliary	
Air °F	Annual Hrs hours	Space Load Btuh/hr	DHW Btuh/hr	Geo °F	WF Air Btuh/hr	WF DHW Btuh/hr	WF Run Time	WF Kw/H kWh	Space kWh	DHW kWh
92	1	36,202	2,621	59	36,202	1,976	100.0%	1	0	0
87	19	27,861	2,621	54	27,861	1,300	100.0%	16	0	8
82	67	19,520	2,621	49	19,520	790	100.0%	37	0	39
77	139	11,179	2,621	45	16,034	533	69.7%	41	0	100
72	256	6,175	2,621	42	16,213	443	38.1%	40	0	200
67	403	0	2,621	44	0	0	0.0%	0	0	336
62	587	0	2,621	44	0	0	0.0%	0	0	490
57	701	-1,350	2,621	46	9,494	1,428	14.2%	74	0	540
52	756	-3,858	2,621	44	9,259	1,397	41.7%	233	0	491
47	681	-6,367	2,621	43	9,026	1,366	70.5%	351	0	360
42	610	-8,875	2,621	42	10,022	1,505	88.6%	439	0	250
37	673	-11,383	2,621	41	12,220	1,814	93.2%	621	0	200
32	758	-13,891	2,621	40	14,414	2,129	96.4%	858	0	137
27	627	-16,400	2,621	39	16,602	2,448	98.8%	843	0	40
22	478	-18,908	2,621	38	18,934	2,624	99.9%	742	0	0
17	364	-21,416	2,621	37	21,442	2,624	99.9%	636	0	0
12	345	-23,925	2,621	36	23,950	2,624	99.9%	672	0	0
7	325	-26,433	2,621	35	26,458	2,623	99.9%	699	0	0
2	268	-28,941	2,621	34	28,967	2,623	99.9%	633	0	0
-3	248	-31,449	2,621	33	31,475	2,623	99.9%	639	0	0
-8	198	-33,958	2,621	32	33,983	2,623	99.9%	553	0	0
-13	134	-36,466	2,621	31	36,491	2,623	99.9%	404	0	0
-18	72	-38,974	2,621	30	38,999	2,623	99.9%	234	0	0
-23	39	-41,483	2,621	29	41,507	2,622	99.9%	136	0	0
-28	16	-43,991	2,621	29	44,015	2,622	99.9%	60	0	0
-33	2	-46,499	2,621	28	46,523	2,622	99.9%	8	0	0
Totals	8767							8969	0	3,191

Table B1-1.76: Annual analysis of heating and cooling loads (in blue and red rectangular boxes on the left side) and vertical ground source heat pump (V.GSHP) unit covering the heating and cooling loads (in blue and red circular boxes on the right side) for a 2,000 square feet detached house above grade (average construction type) in the city of Thunder Bay

Horizontal Ground Source Heat Pump System (H.GSHPs)

Weather		Loads		GeoSmart Energy System					Auxiliary	
Air	Annual Hrs	Space Load	DHW	Geo	WF Air	WF DHW	WF Run	WF kWh	Space	DHW
°F	hours	Btuh/hr	Btuh/hr	°F	Btuh/hr	Btuh/hr	Time	kWh	kWh	kWh
92	1	36,202	2,621	57	36,202	1,824	100.0%	1	0	0
87	19	27,861	2,621	54	27,861	1,269	100.0%	16	0	8
82	67	19,520	2,621	50	19,520	827	100.0%	38	0	38
77	139	11,179	2,621	47	15,887	606	70.4%	43	0	97
72	256	6,175	2,621	45	16,012	544	38.6%	42	0	197
67	403	0	2,621	44	0	0	0.0%	0	0	336
62	587	0	2,621	44	0	0	0.0%	0	0	490
57	701	-1,350	2,621	42	8,670	1,318	15.6%	78	0	539
52	756	-3,858	2,621	41	8,508	1,296	45.3%	244	0	490
47	681	-6,367	2,621	40	8,348	1,275	76.3%	366	0	358
42	610	-8,875	2,621	39	10,014	1,512	88.6%	455	0	249
37	673	-11,383	2,621	38	12,207	1,827	93.3%	642	0	197
32	758	-13,891	2,621	38	14,396	2,145	96.5%	883	0	133
27	627	-16,400	2,621	37	16,582	2,467	98.9%	865	0	36
22	478	-18,908	2,621	36	18,933	2,624	99.9%	757	0	0
17	364	-21,416	2,621	35	21,442	2,624	99.9%	647	0	0
12	345	-23,925	2,621	35	23,950	2,624	99.9%	681	0	0
7	325	-26,433	2,621	34	26,458	2,623	99.9%	706	0	0
2	268	-28,941	2,621	33	28,967	2,623	99.9%	637	0	0
-3	248	-31,449	2,621	33	31,475	2,623	99.9%	640	0	0
-8	198	-33,958	2,621	32	33,983	2,623	99.9%	553	0	0
-13	134	-36,466	2,621	32	36,491	2,623	99.9%	403	0	0
-18	72	-38,974	2,621	31	38,999	2,623	99.9%	232	0	0
-23	39	-41,483	2,621	30	41,508	2,622	99.9%	134	0	0
-28	16	-43,991	2,621	30	44,016	2,622	99.9%	59	0	0
-33	2	-46,499	2,621	29	46,524	2,622	99.9%	8	0	0
Totals	8767							9126	0	3,168

Table B1-1.77: Annual analysis of heating and cooling loads (in blue and red rectangular boxes on the left side) and horizontal ground source heat pump (H.GSHP) unit covering the heating and cooling loads (in blue and red circular boxes on the right side) for a 2,000 square feet detached house above grade (average construction type) in the city of Thunder Bay

Traditional HVAC Applications

Weather		Loads		Fossil Furnace System				Fuel Use		
Air Temp °F	Annual hours	Space Btuh/hr	HW Load Btuh/hr	Furnace Btuh/hr	Furn Run Time	AC Cap Btuh/hr	Clg Run Time	AC kWh	Furnace ccf	HW ccf
92	1	36,202	2,621	0	00.0%	36,954	98.0%	4	0	0
87	19	27,861	2,621	0	00.0%	38,043	73.2%	54	0	1
82	67	19,520	2,621	0	00.0%	39,132	49.9%	140	0	3
77	139	11,179	2,621	0	00.0%	40,222	27.8%	187	0	6
72	256	6,175	2,621	0	00.0%	41,311	14.9%	231	0	11
67	403	0	2,621	0	00.0%	0	00.0%	0	0	18
62	587	0	2,621	0	00.0%	0	00.0%	0	0	26
57	701	-1,350	2,621	1,843	03.1%	0	00.0%	0	13	31
52	756	-3,858	2,621	4,705	08.9%	0	00.0%	0	36	34
47	681	-6,367	2,621	7,554	14.7%	0	00.0%	0	51	30
42	610	-8,875	2,621	10,392	20.5%	0	00.0%	0	63	27
37	673	-11,383	2,621	13,217	26.3%	0	00.0%	0	89	30
32	758	-13,891	2,621	16,030	32.2%	0	00.0%	0	122	34
27	627	-16,400	2,621	18,831	38.0%	0	00.0%	0	118	28
22	478	-18,908	2,621	21,619	43.8%	0	00.0%	0	103	21
17	364	-21,416	2,621	24,396	49.6%	0	00.0%	0	89	16
12	345	-23,925	2,621	27,160	55.4%	0	00.0%	0	94	15
7	325	-26,433	2,621	29,912	61.2%	0	00.0%	0	97	14
2	268	-28,941	2,621	32,652	67.0%	0	00.0%	0	88	12
-3	248	-31,449	2,621	35,380	72.8%	0	00.0%	0	88	11
-8	198	-33,958	2,621	38,095	78.6%	0	00.0%	0	75	9
-13	134	-36,466	2,621	40,799	84.4%	0	00.0%	0	55	6
-18	72	-38,974	2,621	43,490	90.2%	0	00.0%	0	31	3
-23	39	-41,483	2,621	46,169	96.0%	0	00.0%	0	18	2
-28	16	-43,991	2,621	47,997	100.0%	0	00.0%	0	8	1
-33	2	-46,499	2,621	47,997	100.0%	0	00.0%	0	1	0
Totals	8767							616	1,238	391

Table B1-1.78: Annual analysis of heating and cooling loads (in blue and red rectangular boxes on the left side) and traditional HVAC applications covering the heating and cooling loads (in blue and red circular boxes on the right side) for a 2,000 square feet detached house above grade (average construction type) in the city of Thunder Bay

27. Timmins (North) – Annual Hourly Heating and Cooling Loads Analysis and Coverage
Vertical Ground Source Heat Pump System (V.GSHPs)

Weather		Loads		GeoSmart Energy System					Auxiliary	
Air °F	Annual Hrs hours	Space Load Btuh/hr	DHW Btuh/hr	Geo °F	WF Air Btuh/hr	WF DHW Btuh/hr	WF Run Time	WF KWH kWh	Space kWh	DHW kWh
97	1	34,247	2,509	61	34,247	2,083	100.0%	1	0	0
92	8	28,053	2,509	58	28,053	1,539	100.0%	7	0	2
87	34	21,858	2,509	54	21,858	1,091	100.0%	23	0	15
82	92	15,663	2,509	51	15,663	733	100.0%	42	0	52
77	180	9,468	2,509	48	15,856	622	59.7%	47	0	123
72	295	5,752	2,509	46	15,988	556	36.0%	45	0	217
67	422	0	2,509	47	0	0	0.0%	0	0	337
62	544	0	2,509	47	0	0	0.0%	0	0	435
57	618	-1,774	2,509	49	10,211	1,525	17.4%	83	0	442
52	636	-4,282	2,509	48	9,973	1,493	42.9%	209	0	378
47	609	-6,791	2,509	47	9,738	1,461	69.7%	321	0	289
42	583	-9,299	2,509	46	10,302	1,538	90.3%	423	0	208
37	628	-11,808	2,509	44	12,508	1,840	94.4%	578	0	154
32	660	-14,316	2,509	43	14,709	2,146	97.3%	738	0	88
27	577	-16,825	2,509	42	16,906	2,458	99.5%	763	0	12
22	472	-19,333	2,509	41	19,360	2,512	99.9%	712	0	0
17	411	-21,841	2,509	40	21,868	2,512	99.9%	697	0	0
12	380	-24,350	2,509	39	24,377	2,511	99.9%	717	0	0
7	345	-26,858	2,509	38	26,885	2,511	99.9%	718	0	0
2	301	-29,367	2,509	37	29,394	2,511	99.9%	687	0	0
-3	263	-31,875	2,509	36	31,902	2,511	99.9%	654	0	0
-8	223	-34,384	2,509	35	34,410	2,510	99.9%	601	0	0
-13	167	-36,892	2,509	35	36,919	2,510	99.9%	486	0	0
-18	111	-39,401	2,509	34	39,427	2,510	99.9%	347	0	0
-23	65	-41,909	2,509	33	41,935	2,510	99.9%	218	0	0
-28	36	-44,418	2,509	32	44,443	2,510	99.9%	129	0	0
-33	19	-46,926	2,509	31	46,952	2,510	99.9%	72	0	0
Totals	8680							9319	0	2,752

Table B1-1.79: Annual analysis of heating and cooling loads (in blue and red rectangular boxes on the left side) and vertical ground source heat pump (V.GSHP) unit covering the heating and cooling loads (in blue and red circular boxes on the right side) for a 2,000 square feet detached house above grade (average construction type) in the city of Timmins

Horizontal Ground Source Heat Pump System (H.GSHPs)

Weather		Loads		GeoSmart Energy System					Auxiliary	
Air °F	Annual Hrs hours	Space Load Btuh/hr	DHW Btuh/hr	Geo °F	WF Air Btuh/hr	WF DHW Btuh/hr	WF Run Time	WF KWH kWh	Space kWh	DHW kWh
97	1	34,247	2,509	60	34,247	1,994	100.0%	1	0	0
92	8	28,053	2,509	58	28,053	1,533	100.0%	7	0	2
87	34	21,858	2,509	55	21,858	1,136	100.0%	23	0	15
82	92	15,663	2,509	53	15,663	801	100.0%	43	0	50
77	180	9,468	2,509	51	15,661	719	60.5%	49	0	119
72	295	5,752	2,509	49	15,754	673	36.5%	48	0	213
67	422	0	2,509	47	0	0	0.0%	0	0	337
62	544	0	2,509	47	0	0	0.0%	0	0	435
57	618	-1,774	2,509	45	9,308	1,403	19.1%	87	0	441
52	636	-4,282	2,509	44	9,145	1,382	46.8%	219	0	377
47	609	-6,791	2,509	43	8,982	1,360	75.6%	335	0	287
42	583	-9,299	2,509	42	10,296	1,542	90.3%	438	0	207
37	628	-11,808	2,509	41	12,496	1,850	94.5%	597	0	152
32	660	-14,316	2,509	41	14,693	2,162	97.4%	761	0	85
27	577	-16,825	2,509	40	16,886	2,477	99.6%	784	0	8
22	472	-19,333	2,509	39	19,359	2,512	99.9%	729	0	0
17	411	-21,841	2,509	39	21,868	2,512	99.9%	711	0	0
12	380	-24,350	2,509	38	24,376	2,511	99.9%	729	0	0
7	345	-26,858	2,509	37	26,885	2,511	99.9%	728	0	0
2	301	-29,367	2,509	37	29,393	2,511	99.9%	694	0	0
-3	263	-31,875	2,509	36	31,902	2,511	99.9%	658	0	0
-8	223	-34,384	2,509	35	34,410	2,510	99.9%	603	0	0
-13	167	-36,892	2,509	35	36,919	2,510	99.9%	486	0	0
-18	111	-39,401	2,509	34	39,427	2,510	99.9%	346	0	0
-23	65	-41,909	2,509	33	41,935	2,510	99.9%	216	0	0
-28	36	-44,418	2,509	33	44,444	2,510	99.9%	128	0	0
-33	19	-46,926	2,509	32	46,952	2,510	99.9%	71	0	0
Totals	8680							9495	0	2,727

Table B1-1.80: Annual analysis of heating and cooling loads (in blue and red rectangular boxes on the left side) and horizontal ground source heat pump (H.GSHP) unit covering the heating and cooling loads (in blue and red circular boxes on the right side) for a 2,000 square feet detached house above grade (average construction type) in the city of Timmins

Traditional HVAC Applications

Weather		Loads		Fossil Furnace System				Fuel Use		
Air Temp °F	Annual hours	Space Btuh/hr	HW Load Btuh/hr	Furnace Btuh/hr	Furn Run Time	AC Cap Btuh/hr	Clg Run Time	AC kWh	Furnace ccf	HW ccf
97	1	34,247	2,509	0	00.0%	35,865	95.5%	4	0	0
92	8	28,053	2,509	0	00.0%	36,954	75.9%	24	0	0
87	34	21,858	2,509	0	00.0%	38,043	57.5%	81	0	1
82	92	15,663	2,509	0	00.0%	39,132	40.0%	163	0	4
77	180	9,468	2,509	0	00.0%	40,222	23.5%	217	0	8
72	295	5,752	2,509	0	00.0%	41,311	13.9%	257	0	13
67	422	0	2,509	0	00.0%	0	00.0%	0	0	18
62	544	0	2,509	0	00.0%	0	00.0%	0	0	23
57	618	-1,774	2,509	2,327	04.1%	0	00.0%	0	14	26
52	636	-4,282	2,509	5,187	09.9%	0	00.0%	0	33	27
47	609	-6,791	2,509	8,035	15.7%	0	00.0%	0	49	26
42	583	-9,299	2,509	10,870	21.5%	0	00.0%	0	63	25
37	628	-11,808	2,509	13,694	27.3%	0	00.0%	0	86	27
32	660	-14,316	2,509	16,505	33.1%	0	00.0%	0	109	28
27	577	-16,825	2,509	19,304	38.9%	0	00.0%	0	111	25
22	472	-19,333	2,509	22,090	44.8%	0	00.0%	0	104	20
17	411	-21,841	2,509	24,865	50.6%	0	00.0%	0	102	18
12	380	-24,350	2,509	27,628	56.4%	0	00.0%	0	105	16
7	345	-26,858	2,509	30,378	62.2%	0	00.0%	0	105	15
2	301	-29,367	2,509	33,116	68.0%	0	00.0%	0	100	13
-3	263	-31,875	2,509	35,842	73.8%	0	00.0%	0	94	11
-8	223	-34,384	2,509	38,556	79.6%	0	00.0%	0	86	10
-13	167	-36,892	2,509	41,257	85.4%	0	00.0%	0	69	7
-18	111	-39,401	2,509	43,947	91.2%	0	00.0%	0	49	5
-23	65	-41,909	2,509	46,624	97.0%	0	00.0%	0	30	3
-28	36	-44,418	2,509	47,997	100.0%	0	00.0%	0	17	2
-33	19	-46,926	2,509	47,997	100.0%	0	00.0%	0	9	1
Totals	8680							746	1,337	371

Table B1-1.81: Annual analysis of heating and cooling loads (in blue and red rectangular boxes on the left side) and traditional HVAC applications covering the heating and cooling loads (in blue and red circular boxes on the right side) for a 2,000 square feet detached house above grade (average construction type) in the city of Timmins

**Appendix B2 – Annual Hourly Analysis of Heating and Cooling Loads and HVAC Units
Capacity to Cover these Loads – Improved Construction Type**

**1. Cambridge (South) – Annual Hourly Heating and Cooling Loads Analysis and Coverage
Vertical Ground Source Heat Pump System (V.GSHPs)**

Weather		Loads		GeoSmart Energy System					Auxiliary	
Air °F	Annual Hrs hours	Space Load Btuh/hr	DHW Btuh/hr	Geo °F	WF Air Btuh/hr	WF DHW Btuh/hr	WF Run Time	WF KWH kWh	Space kWh	DHW kWh
87	9	25,305	2,427	68	25,305	2,125	100.0%	8	0	1
82	92	18,213	2,427	62	18,213	1,215	100.0%	51	0	35
77	227	11,121	2,427	55	11,121	587	100.0%	68	0	133
72	397	6,866	2,427	51	9,238	423	74.3%	69	0	267
67	588	0	2,427	50	0	0	0.0%	0	0	454
62	726	0	2,427	50	0	0	0.0%	0	0	561
57	732	0	2,427	50	0	0	0.0%	0	0	566
52	679	-1,597	2,427	51	6,421	874	24.9%	74	0	478
47	672	-3,713	2,427	50	6,273	845	59.2%	173	0	412
42	601	-5,829	2,427	48	7,299	977	79.9%	246	0	315
37	649	-7,945	2,427	46	9,161	1,230	86.7%	367	0	281
32	834	-10,060	2,427	45	11,018	1,489	91.3%	607	0	283
27	676	-12,176	2,427	43	12,867	1,755	94.6%	606	0	165
22	551	-14,292	2,427	42	14,710	2,027	97.2%	591	0	80
17	437	-16,408	2,427	40	16,546	2,307	99.2%	548	0	19
12	357	-18,523	2,427	39	18,539	2,429	99.9%	510	0	0
7	238	-20,639	2,427	37	20,655	2,428	99.9%	380	0	0
2	157	-22,755	2,427	36	22,771	2,428	99.9%	278	0	0
-3	86	-24,871	2,427	35	24,886	2,428	99.9%	168	0	0
-8	42	-26,986	2,427	33	27,002	2,428	99.9%	90	0	0
-13	12	-29,102	2,427	32	29,117	2,428	99.9%	28	0	0
-18	1	-31,218	2,427	31	31,233	2,428	100.0%	3	0	0
-23	1	-33,334	2,427	30	33,349	2,428	100.0%	3	0	0
Totals	8764							4868	0	4,052

Table B2-1.1: Annual analysis of heating and cooling loads (in blue and red rectangular boxes on the left side) and vertical ground source heat pump (V.GSHP) unit covering the heating and cooling loads (in blue and red circular boxes on the right side) for a 2,000 square feet detached house above grade (improved construction type) in the city of Cambridge

Horizontal Ground Source Heat Pump System (H.GSHPs)

Weather		Loads		GeoSmart Energy System					Auxiliary	
Air °F	Annual Hrs hours	Space Load Btuh/hr	DHW Btuh/hr	Geo °F	WF Air Btuh/hr	WF DHW Btuh/hr	WF Run Time	WF KWH kWh	Space kWh	DHW kWh
87	9	25,305	2,427	66	25,305	1,958	100.0%	8	0	1
82	92	18,213	2,427	61	18,213	1,197	100.0%	51	0	36
77	227	11,121	2,427	57	11,121	627	100.0%	70	0	130
72	397	6,866	2,427	54	9,110	470	75.4%	73	0	262
67	588	0	2,427	50	0	0	0.0%	0	0	454
62	726	0	2,427	50	0	0	0.0%	0	0	561
57	732	0	2,427	50	0	0	0.0%	0	0	566
52	679	-1,597	2,427	47	6,035	799	26.5%	77	0	479
47	672	-3,713	2,427	46	5,934	779	62.6%	180	0	415
42	601	-5,829	2,427	45	7,308	967	79.8%	255	0	317
37	649	-7,945	2,427	44	9,164	1,227	86.7%	379	0	282
32	834	-10,060	2,427	43	11,014	1,492	91.3%	624	0	283
27	676	-12,176	2,427	41	12,860	1,761	94.7%	619	0	163
22	551	-14,292	2,427	40	14,702	2,035	97.2%	600	0	79
17	437	-16,408	2,427	39	16,538	2,315	99.2%	554	0	18
12	357	-18,523	2,427	38	18,539	2,429	99.9%	513	0	0
7	238	-20,639	2,427	37	20,655	2,428	99.9%	380	0	0
2	157	-22,755	2,427	36	22,771	2,428	99.9%	277	0	0
-3	86	-24,871	2,427	35	24,886	2,428	99.9%	166	0	0
-8	42	-26,986	2,427	34	27,002	2,428	99.9%	89	0	0
-13	12	-29,102	2,427	34	29,118	2,428	99.9%	27	0	0
-18	1	-31,218	2,427	33	31,233	2,428	100.0%	2	0	0
-23	1	-33,334	2,427	32	33,349	2,428	100.0%	3	0	0
Totals	8764							4948	0	4,046

Table B2-1.2: Annual analysis of heating and cooling loads (in blue and red rectangular boxes on the left side) and horizontal ground source heat pump (H.GSHP) unit covering the heating and cooling loads (in blue and red circular boxes on the right side) for a 2,000 square feet detached house above grade (improved construction type) in the city of Cambridge

Traditional HVAC Applications

Weather		Loads		Fossil Furnace System				Fuel Use		
Air Temp °F	Annual hours	Space Btuh/hr	HW Load Btuh/hr	Furnace Btuh/hr	Furn Run Time	AC Cap Btuh/hr	Clg Run Time	AC kWh	Furnace ccf	HW ccf
87	9	25,305	2,427	0	00.0%	27,174	93.1%	22	0	0
82	92	18,213	2,427	0	00.0%	27,952	65.2%	168	0	4
77	227	11,121	2,427	0	00.0%	28,730	38.7%	274	0	9
72	397	6,866	2,427	0	00.0%	29,508	23.3%	332	0	16
67	588	0	2,427	0	00.0%	0	00.0%	0	0	24
62	726	0	2,427	0	00.0%	0	00.0%	0	0	30
57	732	0	2,427	0	00.0%	0	00.0%	0	0	30
52	679	-1,597	2,427	2,050	04.9%	0	00.0%	0	14	28
47	672	-3,713	2,427	4,460	11.5%	0	00.0%	0	30	28
42	601	-5,829	2,427	6,859	18.0%	0	00.0%	0	41	25
37	649	-7,945	2,427	9,246	24.5%	0	00.0%	0	60	27
32	834	-10,060	2,427	11,621	31.1%	0	00.0%	0	97	35
27	676	-12,176	2,427	13,985	37.6%	0	00.0%	0	95	28
22	551	-14,292	2,427	16,337	44.1%	0	00.0%	0	90	23
17	437	-16,408	2,427	18,678	50.6%	0	00.0%	0	82	18
12	357	-18,523	2,427	21,007	57.2%	0	00.0%	0	75	15
7	238	-20,639	2,427	23,325	63.7%	0	00.0%	0	56	10
2	157	-22,755	2,427	25,631	70.2%	0	00.0%	0	40	7
-3	86	-24,871	2,427	27,925	76.8%	0	00.0%	0	24	4
-8	42	-26,986	2,427	30,208	83.3%	0	00.0%	0	13	2
-13	12	-29,102	2,427	32,480	89.8%	0	00.0%	0	4	0
-18	1	-31,218	2,427	34,740	96.4%	0	00.0%	0	0	0
-23	1	-33,334	2,427	35,997	100.0%	0	00.0%	0	0	0
Totals	8764							796	720	363

Table B2-1.3: Annual analysis of heating and cooling loads (in blue and red rectangular boxes on the left side) and traditional HVAC applications covering the heating and cooling loads (in blue and red circular boxes on the right side) for a 2,000 square feet detached house above grade (improved construction type) in the city of Cambridge

2. Chatham (South) – Annual Hourly Heating and Cooling Loads Analysis and Coverage
Vertical Ground Source Heat Pump System (V.GSHPs)

Weather		Loads		GeoSmart Energy System					Auxiliary	
Air °F	Annual Hrs hours	Space Load Btuh/hr	DHW Btuh/hr	Geo °F	WF Air Btuh/hr	WF DHW Btuh/hr	WF Run Time	WF KWH kWh	Space kWh	DHW kWh
97	1	33,105	2,363	78	33,105	2,363	100.0%	1	0	0
92	15	27,144	2,363	72	27,144	2,363	100.0%	16	0	0
87	90	21,183	2,363	66	21,183	1,683	100.0%	65	0	19
82	231	15,222	2,363	61	15,222	998	100.0%	106	0	100
77	431	9,261	2,363	56	9,261	508	100.0%	109	0	255
72	646	5,684	2,363	52	9,189	441	61.9%	95	0	430
67	828	0	2,363	52	0	0	0.0%	0	0	623
62	749	0	2,363	52	0	0	0.0%	0	0	564
57	656	-663	2,363	54	6,676	923	9.9%	29	0	474
52	612	-2,778	2,363	53	6,526	894	42.6%	114	0	386
47	592	-4,894	2,363	51	6,409	869	76.4%	198	0	320
42	614	-7,010	2,363	49	8,278	1,115	84.7%	298	0	277
37	715	-9,125	2,363	48	10,142	1,367	90.0%	458	0	258
32	859	-11,241	2,363	46	11,999	1,625	93.7%	689	0	230
27	637	-13,357	2,363	44	13,850	1,889	96.4%	618	0	110
22	401	-15,472	2,363	43	15,694	2,161	98.6%	459	0	30
17	299	-17,588	2,363	41	17,605	2,365	99.9%	394	0	0
12	198	-19,704	2,363	40	19,720	2,365	99.9%	293	0	0
7	119	-21,819	2,363	39	21,836	2,365	99.9%	196	0	0
2	51	-23,935	2,363	37	23,951	2,364	99.9%	93	0	0
-3	18	-26,051	2,363	36	26,067	2,364	99.9%	36	0	0
-8	2	-28,166	2,363	35	28,182	2,364	99.9%	4	0	0
-13	1	-30,282	2,363	33	30,298	2,364	99.9%	2	0	0
Totals	8765							4275	0	4,077

Table B2-1.4: Annual analysis of heating and cooling loads (in blue and red rectangular boxes on the left side) and vertical ground source heat pump (V.GSHP) unit covering the heating and cooling loads (in blue and red circular boxes on the right side) for a 2,000 square feet detached house above grade (improved construction type) in the city of Chatham

Horizontal Ground Source Heat Pump System (H.GSHPs)

Weather		Loads		GeoSmart Energy System					Auxiliary	
Air	Annual Hrs	Space Load	DHW	Geo	WF Air	WF DHW	WF Run	WF kWh	Space	DHW
°F	hours	Btuh/hr	Btuh/hr	°F	Btuh/hr	Btuh/hr	Time	kWh	kWh	kWh
97	1	33,105	2,363	73	33,105	2,363	100.0%	1	0	0
92	15	27,144	2,363	69	27,144	2,356	100.0%	15	0	0
87	90	21,183	2,363	65	21,183	1,615	100.0%	64	0	21
82	231	15,222	2,363	61	15,222	1,016	100.0%	107	0	99
77	431	9,261	2,363	58	9,261	551	100.0%	114	0	249
72	646	5,684	2,363	55	9,043	495	62.9%	101	0	422
67	828	0	2,363	52	0	0	0.0%	0	0	623
62	749	0	2,363	52	0	0	0.0%	0	0	564
57	656	-663	2,363	50	6,266	843	10.6%	30	0	475
52	612	-2,778	2,363	48	6,163	823	45.1%	119	0	388
47	592	-4,894	2,363	47	6,424	854	76.2%	205	0	323
42	614	-7,010	2,363	46	8,285	1,107	84.6%	308	0	279
37	715	-9,125	2,363	45	10,142	1,366	90.0%	471	0	258
32	859	-11,241	2,363	44	11,995	1,628	93.7%	705	0	229
27	637	-13,357	2,363	43	13,843	1,896	96.5%	629	0	108
22	401	-15,472	2,363	42	15,686	2,168	98.6%	465	0	29
17	299	-17,588	2,363	41	17,604	2,365	99.9%	397	0	0
12	198	-19,704	2,363	40	19,720	2,365	99.9%	294	0	0
7	119	-21,819	2,363	39	21,836	2,365	99.9%	196	0	0
2	51	-23,935	2,363	38	23,951	2,364	99.9%	92	0	0
-3	18	-26,051	2,363	37	26,067	2,364	99.9%	36	0	0
-8	2	-28,166	2,363	36	28,183	2,364	99.9%	4	0	0
-13	1	-30,282	2,363	35	30,298	2,364	99.9%	2	0	0
Totals	8765							4356	0	4,067

Table B2-1.5: Annual analysis of heating and cooling loads (in blue and red rectangular boxes on the left side) and horizontal ground source heat pump (H.GSHP) unit covering the heating and cooling loads (in blue and red circular boxes on the right side) for a 2,000 square feet detached house above grade (improved construction type) in the city of Chatham

Traditional HVAC Applications

Weather		Loads		Fossil Furnace System				Fuel Use		
Air Temp	Annual	Space	HW Load	Furnace	Furn Run	AC Cap	Clg Run	AC	Furnace	HW
°F	hours	Btuh/hr	Btuh/hr	Btuh/hr	Time	Btuh/hr	Time	kWh	ccf	ccf
97	1	33,105	2,363	0	00.0%	35,865	92.3%	4	0	0
92	15	27,144	2,363	0	00.0%	36,954	73.5%	44	0	1
87	90	21,183	2,363	0	00.0%	38,043	55.7%	209	0	4
82	231	15,222	2,363	0	00.0%	39,132	38.9%	402	0	9
77	431	9,261	2,363	0	00.0%	40,222	23.0%	513	0	17
72	646	5,684	2,363	0	00.0%	41,311	13.8%	558	0	26
67	828	0	2,363	0	00.0%	0	00.0%	0	0	33
62	749	0	2,363	0	00.0%	0	00.0%	0	0	30
57	656	-663	2,363	982	02.0%	0	00.0%	0	6	27
52	612	-2,778	2,363	3,397	08.6%	0	00.0%	0	21	25
47	592	-4,894	2,363	5,801	15.1%	0	00.0%	0	34	24
42	614	-7,010	2,363	8,193	21.6%	0	00.0%	0	50	25
37	715	-9,125	2,363	10,573	28.2%	0	00.0%	0	76	29
32	859	-11,241	2,363	12,942	34.7%	0	00.0%	0	111	35
27	637	-13,357	2,363	15,299	41.2%	0	00.0%	0	97	26
22	401	-15,472	2,363	17,645	47.8%	0	00.0%	0	71	16
17	299	-17,588	2,363	19,979	54.3%	0	00.0%	0	60	12
12	198	-19,704	2,363	22,302	60.8%	0	00.0%	0	44	8
7	119	-21,819	2,363	24,613	67.3%	0	00.0%	0	29	5
2	51	-23,935	2,363	26,912	73.9%	0	00.0%	0	14	2
-3	18	-26,051	2,363	29,200	80.4%	0	00.0%	0	5	1
-8	2	-28,166	2,363	31,477	86.9%	0	00.0%	0	1	0
-13	1	-30,282	2,363	33,742	93.5%	0	00.0%	0	0	0
Totals	8765							1730	620	354

Table B2-1.6: Annual analysis of heating and cooling loads (in blue and red rectangular boxes on the left side) and traditional HVAC applications covering the heating and cooling loads (in blue and red circular boxes on the right side) for a 2,000 square feet detached house above grade (improved construction type) in the city of Chatham

3. Guelph (South) – Annual Hourly Heating and Cooling Loads Analysis and Coverage
Vertical Ground Source Heat Pump System (V.GSHPs)

Weather		Loads		GeoSmart Energy System					Auxiliary	
Air °F	Annual Hrs hours	Space Load Btuh/hr	DHW Btuh/hr	Geo °F	WF Air Btuh/hr	WF DHW Btuh/hr	WF Run Time	WF KWH kWh	Space kWh	DHW kWh
87	9	25,402	2,427	68	25,402	2,139	100.0%	8	0	1
82	92	18,087	2,427	61	18,087	1,202	100.0%	51	0	36
77	227	10,773	2,427	55	10,773	563	100.0%	66	0	135
72	397	6,384	2,427	51	9,259	415	69.0%	64	0	271
67	588	0	2,427	50	0	0	0.0%	0	0	454
62	726	0	2,427	50	0	0	0.0%	0	0	561
57	732	0	2,427	50	0	0	0.0%	0	0	566
52	679	-2,079	2,427	51	6,387	867	32.5%	96	0	464
47	672	-4,194	2,427	49	6,240	838	67.2%	196	0	399
42	601	-6,310	2,427	48	7,723	1,034	81.7%	267	0	303
37	649	-8,426	2,427	46	9,584	1,288	87.9%	391	0	267
32	834	-10,542	2,427	44	11,439	1,549	92.2%	639	0	265
27	676	-12,657	2,427	43	13,287	1,816	95.3%	633	0	150
22	551	-14,773	2,427	41	15,128	2,090	97.7%	613	0	68
17	437	-16,889	2,427	40	16,962	2,372	99.6%	567	0	9
12	357	-19,005	2,427	38	19,021	2,429	99.9%	524	0	0
7	238	-21,120	2,427	37	21,136	2,428	99.9%	390	0	0
2	157	-23,236	2,427	36	23,252	2,428	99.9%	285	0	0
-3	86	-25,352	2,427	34	25,368	2,428	99.9%	171	0	0
-8	42	-27,468	2,427	33	27,483	2,428	99.9%	92	0	0
-13	12	-29,583	2,427	32	29,599	2,428	99.9%	28	0	0
-18	1	-31,699	2,427	31	31,714	2,428	100.0%	3	0	0
-23	1	-33,815	2,427	29	33,830	2,428	100.0%	3	0	0
Totals	8764							5084	0	3,948

Table B2-1.7: Annual analysis of heating and cooling loads (in blue and red rectangular boxes on the left side) and vertical ground source heat pump (V.GSHP) unit covering the heating and cooling loads (in blue and red circular boxes on the right side) for a 2,000 square feet detached house above grade (improved construction type) in the city of Guelph

Horizontal Ground Source Heat Pump System (H.GSHPs)

Weather		Loads		GeoSmart Energy System					Auxiliary	
Air	Annual Hrs	Space Load	DHW	Geo	WF Air	WF DHW	WF Run	WF KWH	Space	DHW
°F	hours	Btuh/hr	Btuh/hr	°F	Btuh/hr	Btuh/hr	Time	kWh	kWh	kWh
87	9	25,402	2,427	66	25,402	1,969	100.0%	8	0	1
82	92	18,087	2,427	61	18,087	1,185	100.0%	51	0	36
77	227	10,773	2,427	56	10,773	604	100.0%	68	0	132
72	397	6,384	2,427	54	9,124	465	70.0%	67	0	266
67	588	0	2,427	50	0	0	0.0%	0	0	454
62	726	0	2,427	50	0	0	0.0%	0	0	561
57	732	0	2,427	50	0	0	0.0%	0	0	566
52	679	-2,079	2,427	47	6,012	794	34.6%	101	0	465
47	672	-4,194	2,427	46	5,911	774	71.0%	204	0	402
42	601	-6,310	2,427	45	7,731	1,026	81.6%	277	0	304
37	649	-8,426	2,427	43	9,585	1,287	87.9%	403	0	268
32	834	-10,542	2,427	42	11,435	1,552	92.2%	655	0	264
27	676	-12,657	2,427	41	13,280	1,823	95.3%	646	0	148
22	551	-14,773	2,427	40	15,120	2,098	97.7%	622	0	66
17	437	-16,889	2,427	39	16,955	2,379	99.6%	572	0	8
12	357	-19,005	2,427	38	19,021	2,429	99.9%	526	0	0
7	238	-21,120	2,427	37	21,136	2,428	99.9%	389	0	0
2	157	-23,236	2,427	36	23,252	2,428	99.9%	283	0	0
-3	86	-25,352	2,427	35	25,368	2,428	99.9%	170	0	0
-8	42	-27,468	2,427	34	27,483	2,428	99.9%	90	0	0
-13	12	-29,583	2,427	33	29,599	2,428	99.9%	28	0	0
-18	1	-31,699	2,427	32	31,715	2,428	100.0%	3	0	0
-23	1	-33,815	2,427	32	33,830	2,428	100.0%	3	0	0
Totals	8764							5164	0	3,942

Table B2-1.8: Annual analysis of heating and cooling loads (in blue and red rectangular boxes on the left side) and horizontal ground source heat pump (H.GSHP) unit covering the heating and cooling loads (in blue and red circular boxes on the right side) for a 2,000 square feet detached house above grade (improved construction type) in the city of Guelph

Traditional HVAC Applications

Weather		Loads		Fossil Furnace System				Fuel Use		
Air Temp	Annual	Space	HW Load	Furnace	Furn Run	AC Cap	Clg Run	AC	Furnace	HW
°F	hours	Btuh/hr	Btuh/hr	Btuh/hr	Time	Btuh/hr	Time	kWh	ccf	ccf
87	9	25,402	2,427	0	00.0%	27,174	93.5%	22	0	0
82	92	18,087	2,427	0	00.0%	27,952	64.7%	167	0	4
77	227	10,773	2,427	0	00.0%	28,730	37.5%	268	0	9
72	397	6,384	2,427	0	00.0%	29,508	21.6%	317	0	16
67	588	0	2,427	0	00.0%	0	00.0%	0	0	24
62	726	0	2,427	0	00.0%	0	00.0%	0	0	30
57	732	0	2,427	0	00.0%	0	00.0%	0	0	30
52	679	-2,079	2,427	2,600	06.4%	0	00.0%	0	18	28
47	672	-4,194	2,427	5,007	12.9%	0	00.0%	0	34	28
42	601	-6,310	2,427	7,403	19.5%	0	00.0%	0	44	25
37	649	-8,426	2,427	9,787	26.0%	0	00.0%	0	64	27
32	834	-10,542	2,427	12,160	32.5%	0	00.0%	0	101	35
27	676	-12,657	2,427	14,521	39.1%	0	00.0%	0	98	28
22	551	-14,773	2,427	16,871	45.6%	0	00.0%	0	93	23
17	437	-16,889	2,427	19,209	52.1%	0	00.0%	0	84	18
12	357	-19,005	2,427	21,535	58.7%	0	00.0%	0	77	15
7	238	-21,120	2,427	23,850	65.2%	0	00.0%	0	57	10
2	157	-23,236	2,427	26,154	71.7%	0	00.0%	0	41	7
-3	86	-25,352	2,427	28,446	78.2%	0	00.0%	0	24	4
-8	42	-27,468	2,427	30,726	84.8%	0	00.0%	0	13	2
-13	12	-29,583	2,427	32,995	91.3%	0	00.0%	0	4	0
-18	1	-31,699	2,427	35,252	97.8%	0	00.0%	0	0	0
-23	1	-33,815	2,427	35,997	100.0%	0	00.0%	0	0	0
Totals	8764							774	753	363

Table B2-1.9: Annual analysis of heating and cooling loads (in blue and red rectangular boxes on the left side) and traditional HVAC applications covering the heating and cooling loads (in blue and red circular boxes on the right side) for a 2,000 square feet detached house above grade (improved construction type) in the city of Guelph

4. Hamilton (South) – Annual Hourly Heating and Cooling Loads Analysis and Coverage
Vertical Ground Source Heat Pump System (V.GSHPs)

Weather		Loads		GeoSmart Energy System					Auxiliary	
Air	Annual Hrs	Space Load	DHW	Geo	WF Air	WF DHW	WF Run	WF KWH	Space	DHW
°F	hours	Btuh/hr	Btuh/hr	°F	Btuh/hr	Btuh/hr	Time	kWh	kWh	kWh
97	1	33,130	2,357	79	33,130	2,357	100.0%	1	0	0
92	12	27,054	2,357	72	27,054	2,357	100.0%	13	0	0
87	93	20,978	2,357	66	20,978	1,667	100.0%	67	0	20
82	282	14,902	2,357	61	14,902	974	100.0%	127	0	124
77	505	8,826	2,357	55	9,045	494	97.6%	122	0	302
72	680	5,181	2,357	52	9,201	436	56.3%	91	0	457
67	732	0	2,357	52	0	0	0.0%	0	0	549
62	725	0	2,357	52	0	0	0.0%	0	0	544
57	688	-1,167	2,357	54	6,658	920	17.5%	53	0	481
52	620	-3,283	2,357	52	6,508	891	50.4%	137	0	377
47	586	-5,399	2,357	51	6,849	928	78.8%	217	0	303
42	628	-7,515	2,357	49	8,718	1,174	86.2%	327	0	269
37	793	-9,631	2,357	47	10,581	1,427	91.0%	537	0	267
32	792	-11,747	2,357	46	12,437	1,686	94.4%	665	0	193
27	600	-13,863	2,357	44	14,287	1,952	97.0%	605	0	88
22	438	-15,979	2,357	43	16,130	2,224	99.1%	518	0	21
17	340	-18,094	2,357	41	18,111	2,359	99.9%	460	0	0
12	244	-20,210	2,357	40	20,227	2,359	99.9%	370	0	0
7	142	-22,326	2,357	38	22,343	2,358	99.9%	239	0	0
2	71	-24,442	2,357	37	24,458	2,358	99.9%	132	0	0
-3	31	-26,558	2,357	36	26,574	2,358	99.9%	63	0	0
-8	10	-28,674	2,357	35	28,690	2,358	99.9%	22	0	0
-13	3	-30,790	2,357	33	30,806	2,358	99.9%	7	0	0
-18	1	-32,906	2,357	32	32,921	2,358	100.0%	3	0	0
Totals	9017							4777	0	3,996

Table B2-1.10: Annual analysis of heating and cooling loads (in blue and red rectangular boxes on the left side) and vertical ground source heat pump (V.GSHP) unit covering the heating and cooling loads (in blue and red circular boxes on the right side) for a 2,000 square feet detached house above grade (improved construction type) in the city of Hamilton

Horizontal Ground Source Heat Pump System (H.GSHPs)

Weather		Loads		GeoSmart Energy System					Auxiliary	
Air	Annual Hrs	Space Load	DHW	Geo	WF Air	WF DHW	WF Run	WF KWH	Space	DHW
°F	hours	Btuh/hr	Btuh/hr	°F	Btuh/hr	Btuh/hr	Time	kWh	kWh	kWh
97	1	33,130	2,357	73	33,130	2,357	100.0%	1	0	0
92	12	27,054	2,357	69	27,054	2,357	100.0%	12	0	0
87	93	20,978	2,357	65	20,978	1,607	100.0%	65	0	22
82	282	14,902	2,357	61	14,902	998	100.0%	129	0	122
77	505	8,826	2,357	58	8,937	534	98.8%	127	0	294
72	680	5,181	2,357	55	9,045	494	57.3%	96	0	449
67	732	0	2,357	52	0	0	0.0%	0	0	549
62	725	0	2,357	52	0	0	0.0%	0	0	544
57	688	-1,167	2,357	49	6,253	841	18.7%	56	0	482
52	620	-3,283	2,357	48	6,150	821	53.4%	143	0	379
47	586	-5,399	2,357	47	6,862	913	78.7%	224	0	306
42	628	-7,515	2,357	46	8,723	1,168	86.1%	338	0	270
37	793	-9,631	2,357	45	10,580	1,427	91.0%	552	0	267
32	792	-11,747	2,357	44	12,432	1,691	94.5%	681	0	191
27	600	-13,863	2,357	43	14,280	1,959	97.1%	616	0	87
22	438	-15,979	2,357	42	16,122	2,232	99.1%	525	0	20
17	340	-18,094	2,357	41	18,111	2,359	99.9%	463	0	0
12	244	-20,210	2,357	40	20,227	2,359	99.9%	371	0	0
7	142	-22,326	2,357	39	22,343	2,358	99.9%	239	0	0
2	71	-24,442	2,357	38	24,459	2,358	99.9%	131	0	0
-3	31	-26,558	2,357	37	26,574	2,358	99.9%	62	0	0
-8	10	-28,674	2,357	36	28,690	2,358	99.9%	22	0	0
-13	3	-30,790	2,357	35	30,806	2,358	99.9%	7	0	0
-18	1	-32,906	2,357	34	32,922	2,358	100.0%	3	0	0
Totals	9017							4863	0	3,983

Table B2-1.11: Annual analysis of heating and cooling loads (in blue and red rectangular boxes on the left side) and horizontal ground source heat pump (H.GSHP) unit covering the heating and cooling loads (in blue and red circular boxes on the right side) for a 2,000 square feet detached house above grade (improved construction type) in the city of Hamilton

Traditional HVAC Applications

Weather		Loads		Fossil Furnace System				Fuel Use		
Air Temp °F	Annual hours	Space Btuh/hr	HW Load Btuh/hr	Furnace Btuh/hr	Furn Run Time	AC Cap Btuh/hr	Clg Run Time	AC kWh	Furnace ccf	HW ccf
97	1	33,130	2,357	0	00.0%	35,865	92.4%	4	0	0
92	12	27,054	2,357	0	00.0%	36,954	73.2%	35	0	0
87	93	20,978	2,357	0	00.0%	38,043	55.1%	214	0	4
82	282	14,902	2,357	0	00.0%	39,132	38.1%	483	0	11
77	505	8,826	2,357	0	00.0%	40,222	21.9%	584	0	20
72	680	5,181	2,357	0	00.0%	41,311	12.5%	561	0	27
67	732	0	2,357	0	00.0%	0	00.0%	0	0	30
62	725	0	2,357	0	00.0%	0	00.0%	0	0	29
57	688	-1,167	2,357	1,559	03.6%	0	00.0%	0	11	28
52	620	-3,283	2,357	3,972	10.1%	0	00.0%	0	25	25
47	586	-5,399	2,357	6,373	16.7%	0	00.0%	0	37	24
42	628	-7,515	2,357	8,762	23.2%	0	00.0%	0	55	25
37	793	-9,631	2,357	11,140	29.7%	0	00.0%	0	88	32
32	792	-11,747	2,357	13,506	36.3%	0	00.0%	0	107	32
27	600	-13,863	2,357	15,861	42.8%	0	00.0%	0	95	24
22	438	-15,979	2,357	18,204	49.3%	0	00.0%	0	80	18
17	340	-18,094	2,357	20,536	55.8%	0	00.0%	0	70	14
12	244	-20,210	2,357	22,856	62.4%	0	00.0%	0	56	10
7	142	-22,326	2,357	25,165	68.9%	0	00.0%	0	36	6
2	71	-24,442	2,357	27,462	75.4%	0	00.0%	0	19	3
-3	31	-26,558	2,357	29,747	82.0%	0	00.0%	0	9	1
-8	10	-28,674	2,357	32,021	88.5%	0	00.0%	0	3	0
-13	3	-30,790	2,357	34,284	95.0%	0	00.0%	0	1	0
-18	1	-32,906	2,357	35,997	100.0%	0	00.0%	0	0	0
Totals	9017							1881	693	364

Table B2-1.12: Annual analysis of heating and cooling loads (in blue and red rectangular boxes on the left side) and traditional HVAC applications covering the heating and cooling loads (in blue and red circular boxes on the right side) for a 2,000 square feet detached house above grade (improved construction type) in the city of Hamilton

5. Kingston (South) – Annual Hourly Heating and Cooling Loads Analysis and Coverage
Vertical Ground Source Heat Pump System (V.GSHPs)

Weather		Loads		GeoSmart Energy System					Auxiliary	
Air °F	Annual Hrs hours	Space Load Btuh/hr	DHW Btuh/hr	Geo °F	WF Air Btuh/hr	WF DHW Btuh/hr	WF Run Time	WF Kw/H kWh	Space kWh	DHW kWh
92	1	44,126	2,466	74	44,126	2,466	100.0%	1	0	0
87	11	33,254	2,466	66	33,254	2,466	100.0%	10	0	0
82	72	22,381	2,466	59	22,381	1,289	100.0%	42	0	27
77	318	11,509	2,466	52	13,203	542	87.2%	101	0	202
72	644	4,986	2,466	47	13,459	431	37.0%	84	0	473
67	781	0	2,466	49	0	0	0.0%	0	0	613
62	779	0	2,466	49	0	0	0.0%	0	0	612
57	738	-1,361	2,466	51	8,735	959	15.6%	75	0	544
52	697	-3,477	2,466	49	8,550	939	40.7%	182	0	463
47	653	-5,592	2,466	48	8,367	919	66.8%	277	0	385
42	664	-7,708	2,466	47	9,162	1,037	84.1%	388	0	337
37	780	-9,824	2,466	46	11,006	1,309	89.3%	576	0	322
32	694	-11,939	2,466	45	12,846	1,584	92.9%	622	0	220
27	528	-14,055	2,466	43	14,682	1,863	95.7%	559	0	115
22	408	-16,171	2,466	42	16,515	2,146	97.9%	500	0	47
17	324	-18,286	2,466	41	18,343	2,432	99.7%	452	0	4
12	271	-20,402	2,466	40	20,422	2,469	99.9%	420	0	0
7	205	-22,517	2,466	39	22,538	2,468	99.9%	350	0	0
2	134	-24,633	2,466	38	24,654	2,468	99.9%	250	0	0
-3	77	-26,749	2,466	37	26,769	2,468	99.9%	156	0	0
-8	39	-28,864	2,466	36	28,885	2,468	99.9%	85	0	0
-13	17	-30,980	2,466	35	31,000	2,468	99.9%	40	0	0
-18	7	-33,096	2,466	34	33,116	2,468	99.9%	18	0	0
-23	2	-35,211	2,466	33	35,231	2,467	99.9%	5	0	0
Totals	8844							5194	0	4,365

Table B2-1.13: Annual analysis of heating and cooling loads (in blue and red rectangular boxes on the left side) and vertical ground source heat pump (V.GSHP) unit covering the heating and cooling loads (in blue and red circular boxes on the right side) for a 2,000 square feet detached house above grade (improved construction type) in the city of Kingston

Horizontal Ground Source Heat Pump System (H.GSHPs)

Weather		Loads		GeoSmart Energy System					Auxiliary	
Air	Annual Hrs	Space Load	DHW	Geo	WF Air	WF DHW	WF Run	WF kWh	Space	DHW
°F	hours	Btuh/hr	Btuh/hr	°F	Btuh/hr	Btuh/hr	Time	kWh	kWh	kWh
92	1	44,126	2,466	69	44,126	2,466	100.0%	1	0	0
87	11	33,254	2,466	64	33,254	2,386	100.0%	10	0	0
82	72	22,381	2,466	59	22,381	1,285	100.0%	42	0	27
77	318	11,509	2,466	54	13,082	595	88.0%	104	0	197
72	644	4,986	2,466	51	13,261	517	37.6%	88	0	466
67	781	0	2,466	49	0	0	0.0%	0	0	613
62	779	0	2,466	49	0	0	0.0%	0	0	612
57	738	-1,361	2,466	46	8,050	883	16.9%	78	0	544
52	697	-3,477	2,466	45	7,923	869	43.9%	189	0	463
47	653	-5,592	2,466	45	7,796	855	71.7%	288	0	385
42	664	-7,708	2,466	44	9,143	1,055	84.3%	399	0	333
37	780	-9,824	2,466	43	10,985	1,329	89.4%	592	0	317
32	694	-11,939	2,466	42	12,823	1,606	93.1%	638	0	215
27	528	-14,055	2,466	41	14,659	1,885	95.9%	572	0	111
22	408	-16,171	2,466	40	16,492	2,168	98.0%	510	0	44
17	324	-18,286	2,466	40	18,323	2,453	99.8%	460	0	2
12	271	-20,402	2,466	39	20,422	2,468	99.9%	425	0	0
7	205	-22,517	2,466	38	22,538	2,468	99.9%	353	0	0
2	134	-24,633	2,466	37	24,654	2,468	99.9%	251	0	0
-3	77	-26,749	2,466	37	26,769	2,468	99.9%	156	0	0
-8	39	-28,864	2,466	36	28,885	2,468	99.9%	85	0	0
-13	17	-30,980	2,466	35	31,000	2,468	99.9%	40	0	0
-18	7	-33,096	2,466	34	33,116	2,468	99.9%	18	0	0
-23	2	-35,211	2,466	34	35,231	2,467	99.9%	5	0	0
Totals	8844							5304	0	4,330

Table B2-1.14: Annual analysis of heating and cooling loads (in blue and red rectangular boxes on the left side) and horizontal ground source heat pump (H.GSHP) unit covering the heating and cooling loads (in blue and red circular boxes on the right side) for a 2,000 square feet detached house above grade (improved construction type) in the city of Kingston

Traditional HVAC Applications

Weather		Loads		Fossil Furnace System				Fuel Use		
Air Temp °F	Annual hours	Space Btuh/hr	HW Load Btuh/hr	Furnace Btuh/hr	Furn Run Time	AC Cap Btuh/hr	Clg Run Time	AC kWh	Furnace ccf	HW ccf
92	1	44,126	2,466	0	00.0%	47,512	92.9%	5	0	0
87	11	33,254	2,466	0	00.0%	48,913	68.0%	38	0	0
82	72	22,381	2,466	0	00.0%	50,313	44.5%	178	0	3
77	318	11,509	2,466	0	00.0%	51,714	22.3%	477	0	13
72	644	4,986	2,466	0	00.0%	53,114	09.4%	597	0	27
67	781	0	2,466	0	00.0%	0	00.0%	0	0	33
62	779	0	2,466	0	00.0%	0	00.0%	0	0	33
57	738	-1,361	2,466	1,781	04.2%	0	00.0%	0	13	31
52	697	-3,477	2,466	4,192	10.7%	0	00.0%	0	29	29
47	653	-5,592	2,466	6,592	17.3%	0	00.0%	0	43	27
42	664	-7,708	2,466	8,980	23.8%	0	00.0%	0	60	28
37	780	-9,824	2,466	11,356	30.3%	0	00.0%	0	89	33
32	694	-11,939	2,466	13,721	36.8%	0	00.0%	0	95	29
27	528	-14,055	2,466	16,074	43.4%	0	00.0%	0	85	22
22	408	-16,171	2,466	18,416	49.9%	0	00.0%	0	75	17
17	324	-18,286	2,466	20,747	56.4%	0	00.0%	0	67	14
12	271	-20,402	2,466	23,065	63.0%	0	00.0%	0	63	11
7	205	-22,517	2,466	25,373	69.5%	0	00.0%	0	52	9
2	134	-24,633	2,466	27,668	76.0%	0	00.0%	0	37	6
-3	77	-26,749	2,466	29,953	82.6%	0	00.0%	0	23	3
-8	39	-28,864	2,466	32,225	89.1%	0	00.0%	0	13	2
-13	17	-30,980	2,466	34,486	95.6%	0	00.0%	0	6	1
-18	7	-33,096	2,466	35,997	100.0%	0	00.0%	0	3	0
-23	2	-35,211	2,466	35,997	100.0%	0	00.0%	0	1	0
Totals	8844							1294	752	372

Table B2-1.15: Annual analysis of heating and cooling loads (in blue and red rectangular boxes on the left side) and traditional HVAC applications covering the heating and cooling loads (in blue and red circular boxes on the right side) for a 2,000 square feet detached house above grade (improved construction type) in the city of Kingston

6. Kitchener-Waterloo (South) – Annual Hourly Heating and Cooling Loads Analysis and Coverage

Vertical Ground Source Heat Pump System (V.GSHPs)

Weather		Loads		GeoSmart Energy System					Auxiliary	
Air °F	Annual Hrs hours	Space Load Btuh/hr	DHW Btuh/hr	Geo °F	WF Air Btuh/hr	WF DHW Btuh/hr	WF Run Time	WF KWH kWh	Space kWh	DHW kWh
92	6	34,146	2,427	68	34,146	2,427	100.0%	6	0	0
87	70	25,961	2,427	62	25,961	1,752	100.0%	49	0	15
82	230	17,776	2,427	57	17,776	942	100.0%	109	0	109
77	440	9,591	2,427	52	13,203	542	72.6%	117	0	285
72	620	4,680	2,427	48	13,397	458	34.9%	77	0	448
67	696	0	2,427	50	0	0	0.0%	0	0	538
62	711	0	2,427	50	0	0	0.0%	0	0	549
57	677	-1,667	2,427	52	8,913	979	18.7%	83	0	484
52	642	-3,783	2,427	50	8,727	959	43.3%	180	0	411
47	591	-5,898	2,427	49	8,543	938	69.0%	262	0	335
42	595	-8,014	2,427	48	9,401	1,065	85.2%	357	0	288
37	730	-10,130	2,427	47	11,247	1,335	90.1%	550	0	285
32	768	-12,246	2,427	46	13,089	1,608	93.6%	698	0	225
27	623	-14,361	2,427	44	14,927	1,885	96.2%	666	0	122
22	468	-16,477	2,427	43	16,761	2,166	98.3%	577	0	44
17	370	-18,593	2,427	42	18,614	2,429	99.9%	518	0	0
12	262	-20,709	2,427	41	20,730	2,429	99.9%	406	0	0
7	162	-22,824	2,427	40	22,845	2,429	99.9%	276	0	0
2	92	-24,940	2,427	39	24,961	2,429	99.9%	171	0	0
-3	44	-27,056	2,427	38	27,077	2,428	99.9%	89	0	0
-8	18	-29,172	2,427	37	29,192	2,428	99.9%	39	0	0
-13	6	-31,287	2,427	36	31,308	2,428	99.9%	14	0	0
-18	2	-33,403	2,427	35	33,423	2,428	99.9%	5	0	0
-23	1	-35,519	2,427	34	35,539	2,428	99.9%	3	0	0
Totals	8824							5250	0	4,137

Table B2-1.16: Annual analysis of heating and cooling loads (in blue and red rectangular boxes on the left side) and vertical ground source heat pump (V.GSHP) unit covering the heating and cooling loads (in blue and red circular boxes on the right side) for a 2,000 square feet detached house above grade (improved construction type) in the city of Kitchener-Waterloo

Horizontal Ground Source Heat Pump System (H.GSHPs)

Weather		Loads		GeoSmart Energy System					Auxiliary	
Air	Annual Hrs	Space Load	DHW	Geo	WF Air	WF DHW	WF Run	WF kWh	Space	DHW
°F	hours	Btuh/hr	Btuh/hr	°F	Btuh/hr	Btuh/hr	Time	kWh	kWh	kWh
92	6	34,146	2,427	66	34,146	2,427	100.0%	6	0	0
87	70	25,961	2,427	62	25,961	1,706	100.0%	48	0	16
82	230	17,776	2,427	58	17,776	983	100.0%	111	0	106
77	440	9,591	2,427	54	13,055	607	73.5%	121	0	278
72	620	4,680	2,427	52	13,189	548	35.5%	81	0	441
67	696	0	2,427	50	0	0	0.0%	0	0	538
62	711	0	2,427	50	0	0	0.0%	0	0	549
57	677	-1,667	2,427	47	8,221	902	20.3%	86	0	484
52	642	-3,783	2,427	46	8,094	888	46.7%	187	0	411
47	591	-5,898	2,427	46	7,967	874	74.0%	271	0	335
42	595	-8,014	2,427	45	9,383	1,082	85.4%	367	0	285
37	730	-10,130	2,427	44	11,226	1,355	90.2%	565	0	280
32	768	-12,246	2,427	43	13,066	1,630	93.7%	716	0	220
27	623	-14,361	2,427	42	14,904	1,908	96.4%	681	0	117
22	468	-16,477	2,427	41	16,739	2,188	98.4%	588	0	41
17	370	-18,593	2,427	41	18,613	2,429	99.9%	526	0	0
12	262	-20,709	2,427	40	20,729	2,429	99.9%	411	0	0
7	162	-22,824	2,427	39	22,845	2,429	99.9%	278	0	0
2	92	-24,940	2,427	38	24,961	2,429	99.9%	172	0	0
-3	44	-27,056	2,427	38	27,077	2,428	99.9%	89	0	0
-8	18	-29,172	2,427	37	29,192	2,428	99.9%	39	0	0
-13	6	-31,287	2,427	36	31,308	2,428	99.9%	14	0	0
-18	2	-33,403	2,427	36	33,424	2,428	99.9%	5	0	0
-23	1	-35,519	2,427	35	35,539	2,428	99.9%	3	0	0
Totals	8824							5365	0	4,099

Table B2-1.17: Annual analysis of heating and cooling loads (in blue and red rectangular boxes on the left side) and horizontal ground source heat pump (H.GSHP) unit covering the heating and cooling loads (in blue and red circular boxes on the right side) for a 2,000 square feet detached house above grade (improved construction type) in the city of Kitchener-Waterloo

Traditional HVAC Applications

Weather		Loads		Fossil Furnace System				Fuel Use		
Air Temp °F	Annual hours	Space Btuh/hr	HW Load Btuh/hr	Furnace Btuh/hr	Furn Run Time	AC Cap Btuh/hr	Clg Run Time	AC kWh	Furnace ccf	HW ccf
92	6	34,146	2,427	0	00.0%	36,954	92.4%	21	0	0
87	70	25,961	2,427	0	00.0%	38,043	68.2%	190	0	3
82	230	17,776	2,427	0	00.0%	39,132	45.4%	448	0	10
77	440	9,591	2,427	0	00.0%	40,222	23.8%	536	0	18
72	620	4,680	2,427	0	00.0%	41,311	11.3%	487	0	26
67	696	0	2,427	0	00.0%	0	00.0%	0	0	29
62	711	0	2,427	0	00.0%	0	00.0%	0	0	29
57	677	-1,667	2,427	2,130	05.1%	0	00.0%	0	14	28
52	642	-3,783	2,427	4,539	11.7%	0	00.0%	0	29	27
47	591	-5,898	2,427	6,938	18.2%	0	00.0%	0	41	24
42	595	-8,014	2,427	9,324	24.7%	0	00.0%	0	55	25
37	730	-10,130	2,427	11,699	31.3%	0	00.0%	0	85	30
32	768	-12,246	2,427	14,062	37.8%	0	00.0%	0	108	32
27	623	-14,361	2,427	16,414	44.3%	0	00.0%	0	102	26
22	468	-16,477	2,427	18,755	50.9%	0	00.0%	0	88	19
17	370	-18,593	2,427	21,083	57.4%	0	00.0%	0	78	15
12	262	-20,709	2,427	23,401	63.9%	0	00.0%	0	61	11
7	162	-22,824	2,427	25,706	70.4%	0	00.0%	0	42	7
2	92	-24,940	2,427	28,001	77.0%	0	00.0%	0	26	4
-3	44	-27,056	2,427	30,283	83.5%	0	00.0%	0	13	2
-8	18	-29,172	2,427	32,554	90.0%	0	00.0%	0	6	1
-13	6	-31,287	2,427	34,814	96.6%	0	00.0%	0	2	0
-18	2	-33,403	2,427	35,997	100.0%	0	00.0%	0	1	0
-23	1	-35,519	2,427	35,997	100.0%	0	00.0%	0	0	0
Totals	8824							1681	753	366

Table B2-1.18: Annual analysis of heating and cooling loads (in blue and red rectangular boxes on the left side) and traditional HVAC applications covering the heating and cooling loads (in blue and red circular boxes on the right side) for a 2,000 square feet detached house above grade (improved construction type) in the city of Kitchener-Waterloo

7. London (South) – Annual Hourly Heating and Cooling Loads Analysis and Coverage Vertical Ground Source Heat Pump System (V.GSHPs)

Weather		Loads		GeoSmart Energy System					Auxiliary	
Air °F	Annual Hrs hours	Space Load Btuh/hr	DHW Btuh/hr	Geo °F	WF Air Btuh/hr	WF DHW Btuh/hr	WF Run Time	WF kWh	Space kWh	DHW kWh
92	3	30,113	2,424	73	30,113	2,424	100.0%	4	0	0
87	52	23,245	2,424	66	23,245	1,836	100.0%	41	0	10
82	169	16,376	2,424	60	16,376	1,031	100.0%	82	0	75
77	343	9,508	2,424	54	9,508	483	100.0%	86	0	212
72	554	5,387	2,424	50	9,297	401	57.9%	74	0	387
67	719	0	2,424	50	0	0	0.0%	0	0	555
62	735	0	2,424	50	0	0	0.0%	0	0	567
57	679	-960	2,424	52	6,475	884	14.8%	44	0	496
52	658	-3,075	2,424	50	6,327	855	48.6%	139	0	421
47	594	-5,191	2,424	49	6,733	902	77.1%	215	0	327
42	590	-7,306	2,424	47	8,597	1,153	85.0%	305	0	271
37	707	-9,422	2,424	45	10,455	1,410	90.1%	479	0	260
32	898	-11,537	2,424	44	12,307	1,673	93.7%	758	0	245
27	671	-13,653	2,424	42	14,152	1,943	96.5%	682	0	117
22	466	-15,768	2,424	41	15,990	2,221	98.6%	558	0	35
17	339	-17,884	2,424	39	17,900	2,426	99.9%	467	0	0
12	258	-19,999	2,424	38	20,015	2,425	99.9%	398	0	0
7	172	-22,115	2,424	36	22,131	2,425	99.9%	295	0	0
2	91	-24,230	2,424	35	24,246	2,425	99.9%	172	0	0
-3	49	-26,346	2,424	34	26,361	2,425	99.9%	102	0	0
-8	16	-28,461	2,424	33	28,477	2,425	99.9%	36	0	0
-13	3	-30,577	2,424	31	30,592	2,425	100.0%	7	0	0
Totals	8766							4947	0	3,976

Table B2-1.19: Annual analysis of heating and cooling loads (in blue and red rectangular boxes on the left side) and vertical ground source heat pump (V.GSHP) unit covering the heating and cooling loads (in blue and red circular boxes on the right side) for a 2,000 square feet detached house above grade (improved construction type) in the city of London

Horizontal Ground Source Heat Pump System (H.GSHPs)

Weather		Loads		GeoSmart Energy System					Auxiliary	
Air	Annual Hrs	Space Load	DHW	Geo	WF Air	WF DHW	WF Run	WF kWh	Space	DHW
*F	hours	Btuh/hr	Btuh/hr	*F	Btuh/hr	Btuh/hr	Time	kWh	kWh	kWh
92	3	30,113	2,424	69	30,113	2,424	100.0%	3	0	0
87	52	23,245	2,424	64	23,245	1,711	100.0%	39	0	12
82	169	16,376	2,424	60	16,376	1,028	100.0%	82	0	75
77	343	9,508	2,424	56	9,508	521	100.0%	89	0	208
72	554	5,387	2,424	53	9,158	452	58.8%	78	0	381
67	719	0	2,424	50	0	0	0.0%	0	0	555
62	735	0	2,424	50	0	0	0.0%	0	0	567
57	679	-960	2,424	48	6,092	810	15.8%	46	0	496
52	658	-3,075	2,424	47	5,990	790	51.3%	145	0	423
47	594	-5,191	2,424	45	6,744	890	77.0%	223	0	329
42	590	-7,306	2,424	44	8,601	1,148	84.9%	315	0	272
37	707	-9,422	2,424	43	10,454	1,411	90.1%	492	0	259
32	898	-11,537	2,424	42	12,302	1,678	93.8%	774	0	243
27	671	-13,653	2,424	41	14,145	1,950	96.5%	693	0	116
22	466	-15,768	2,424	40	15,983	2,227	98.7%	563	0	34
17	339	-17,884	2,424	39	17,900	2,426	99.9%	469	0	0
12	258	-19,999	2,424	38	20,015	2,425	99.9%	398	0	0
7	172	-22,115	2,424	37	22,131	2,425	99.9%	294	0	0
2	91	-24,230	2,424	36	24,246	2,425	99.9%	171	0	0
-3	49	-26,346	2,424	35	26,361	2,425	99.9%	100	0	0
-8	16	-28,461	2,424	34	28,477	2,425	99.9%	36	0	0
-13	3	-30,577	2,424	33	30,592	2,425	99.9%	7	0	0
Totals	8766							5018	0	3,970

Table B2-1.20: Annual analysis of heating and cooling loads (in blue and red rectangular boxes on the left side) and horizontal ground source heat pump (H.GSHP) unit covering the heating and cooling loads (in blue and red circular boxes on the right side) for a 2,000 square feet detached house above grade (improved construction type) in the city of London

Traditional HVAC Applications

Weather		Loads		Fossil Furnace System				Fuel Use		
Air Temp	Annual	Space	HW Load	Furnace	Furn Run	AC Cap	Clg Run	AC	Furnace	HW
°F	hours	Btuh/hr	Btuh/hr	Btuh/hr	Time	Btuh/hr	Time	kWh	ccf	ccf
92	3	30,113	2,424	0	00.0%	31,675	95.1%	9	0	0
87	52	23,245	2,424	0	00.0%	32,608	71.3%	125	0	2
82	169	16,376	2,424	0	00.0%	33,542	48.8%	298	0	7
77	343	9,508	2,424	0	00.0%	34,476	27.6%	394	0	14
72	554	5,387	2,424	0	00.0%	35,409	15.2%	433	0	23
67	719	0	2,424	0	00.0%	0	00.0%	0	0	30
62	735	0	2,424	0	00.0%	0	00.0%	0	0	30
57	679	-960	2,424	1,322	03.0%	0	00.0%	0	9	28
52	658	-3,075	2,424	3,735	09.5%	0	00.0%	0	25	27
47	594	-5,191	2,424	6,137	16.0%	0	00.0%	0	36	25
42	590	-7,306	2,424	8,527	22.6%	0	00.0%	0	50	24
37	707	-9,422	2,424	10,905	29.1%	0	00.0%	0	77	29
32	898	-11,537	2,424	13,272	35.6%	0	00.0%	0	119	37
27	671	-13,653	2,424	15,628	42.1%	0	00.0%	0	105	28
22	466	-15,768	2,424	17,972	48.7%	0	00.0%	0	84	19
17	339	-17,884	2,424	20,304	55.2%	0	00.0%	0	69	14
12	258	-19,999	2,424	22,625	61.7%	0	00.0%	0	58	11
7	172	-22,115	2,424	24,934	68.3%	0	00.0%	0	43	7
2	91	-24,230	2,424	27,232	74.8%	0	00.0%	0	25	4
-3	49	-26,346	2,424	29,518	81.3%	0	00.0%	0	14	2
-8	16	-28,461	2,424	31,793	87.8%	0	00.0%	0	5	1
-13	3	-30,577	2,424	34,056	94.4%	0	00.0%	0	1	0
Totals	8766							1258	721	363

Table B2-1.21: Annual analysis of heating and cooling loads (in blue and red rectangular boxes on the left side) and traditional HVAC applications covering the heating and cooling loads (in blue and red circular boxes on the right side) for a 2,000 square feet detached house above grade (improved construction type) in the city of London

8. Mount Forest (South) – Annual Hourly Heating and Cooling Loads Analysis and Coverage

Vertical Ground Source Heat Pump System (V.GSHPs)

Weather		Loads		GeoSmart Energy System					Auxiliary	
Air	Annual Hrs	Space Load	DHW	Geo	WF Air	WF DHW	WF Run	WF KWH	Space	DHW
°F	hours	Btuh/hr	Btuh/hr	°F	Btuh/hr	Btuh/hr	Time	kWh	kWh	kWh
92	1	34,127	2,427	68	34,127	2,427	100.0%	1	0	0
87	20	26,067	2,427	62	26,067	1,765	100.0%	14	0	4
82	104	18,007	2,427	57	18,007	961	100.0%	50	0	49
77	248	9,947	2,427	52	13,189	548	75.4%	69	0	159
72	426	5,112	2,427	49	13,380	465	38.2%	58	0	305
67	590	0	2,427	50	0	0	0.0%	0	0	456
62	697	0	2,427	50	0	0	0.0%	0	0	539
57	710	-1,236	2,427	52	8,951	983	13.8%	64	0	518
52	665	-3,352	2,427	51	8,765	963	38.2%	165	0	436
47	624	-5,468	2,427	50	8,580	942	63.7%	255	0	363
42	594	-7,583	2,427	48	9,025	1,011	84.0%	338	0	298
37	688	-9,699	2,427	47	10,871	1,280	89.2%	496	0	282
32	769	-11,815	2,427	46	12,714	1,552	92.9%	674	0	241
27	679	-13,931	2,427	45	14,553	1,829	95.7%	703	0	146
22	533	-16,047	2,427	43	16,388	2,109	97.9%	639	0	61
17	443	-18,163	2,427	42	18,220	2,393	99.7%	606	0	6
12	344	-20,278	2,427	41	20,299	2,429	99.9%	522	0	0
7	235	-22,394	2,427	40	22,415	2,429	99.9%	393	0	0
2	147	-24,510	2,427	39	24,531	2,429	99.9%	268	0	0
-3	79	-26,626	2,427	38	26,647	2,428	99.9%	157	0	0
-8	37	-28,742	2,427	37	28,763	2,428	99.9%	79	0	0
-13	13	-30,858	2,427	36	30,878	2,428	99.9%	30	0	0
-18	3	-32,973	2,427	35	32,994	2,428	99.9%	7	0	0
-23	1	-35,089	2,427	34	35,110	2,428	99.9%	3	0	0
Totals	8650							5593	0	3,863

Table B2-1.22: Annual analysis of heating and cooling loads (in blue and red rectangular boxes on the left side) and vertical ground source heat pump (V.GSHP) unit covering the heating and cooling loads (in blue and red circular boxes on the right side) for a 2,000 square feet detached house above grade (improved construction type) in the city of Mount Forest

Horizontal Ground Source Heat Pump System (H.GSHPs)

Weather		Loads		GeoSmart Energy System					Auxiliary	
Air	Annual Hrs	Space Load	DHW	Geo	WF Air	WF DHW	WF Run	WF kWh	Space	DHW
°F	hours	Btuh/hr	Btuh/hr	°F	Btuh/hr	Btuh/hr	Time	kWh	kWh	kWh
92	1	34,127	2,427	72	34,127	2,427	100.0%	1	0	0
87	20	26,067	2,427	66	26,067	2,051	100.0%	18	0	2
82	104	18,007	2,427	61	18,007	1,178	100.0%	57	0	41
77	248	9,947	2,427	56	9,947	550	100.0%	68	0	148
72	426	5,112	2,427	53	9,162	451	55.8%	57	0	295
67	590	0	2,427	50	0	0	0.0%	0	0	456
62	697	0	2,427	50	0	0	0.0%	0	0	539
57	710	-1,236	2,427	47	6,053	802	20.4%	62	0	512
52	665	-3,352	2,427	46	5,951	782	56.3%	160	0	421
47	624	-5,468	2,427	45	6,991	923	78.2%	248	0	339
42	594	-7,583	2,427	44	8,847	1,182	85.7%	330	0	267
37	688	-9,699	2,427	43	10,699	1,446	90.7%	495	0	244
32	769	-11,815	2,427	42	12,546	1,715	94.2%	682	0	199
27	679	-13,931	2,427	41	14,388	1,988	96.8%	720	0	108
22	533	-16,047	2,427	39	16,225	2,267	98.9%	659	0	31
17	443	-18,163	2,427	38	18,179	2,429	99.9%	624	0	0
12	344	-20,278	2,427	37	20,294	2,428	99.9%	540	0	0
7	235	-22,394	2,427	36	22,410	2,428	99.9%	408	0	0
2	147	-24,510	2,427	36	24,526	2,428	99.9%	280	0	0
-3	79	-26,626	2,427	35	26,642	2,428	99.9%	164	0	0
-8	37	-28,742	2,427	34	28,758	2,428	99.9%	83	0	0
-13	13	-30,858	2,427	33	30,873	2,428	99.9%	32	0	0
-18	3	-32,973	2,427	32	32,989	2,428	100.0%	8	0	0
-23	1	-35,089	2,427	31	35,105	2,428	100.0%	3	0	0
Totals	8650							5700	0	3,603

Table B2-1.23: Annual analysis of heating and cooling loads (in blue and red rectangular boxes on the left side) and horizontal ground source heat pump (H.GSHP) unit covering the heating and cooling loads (in blue and red circular boxes on the right side) for a 2,000 square feet detached house above grade (improved construction type) in the city of Mount Forest

Traditional HVAC Applications

Weather		Loads		Fossil Furnace System				Fuel Use		
Air Temp °F	Annual hours	Space Btuh/hr	HW Load Btuh/hr	Furnace Btuh/hr	Furn Run Time	AC Cap Btuh/hr	Clg Run Time	AC kWh	Furnace ccf	HW ccf
92	1	34,127	2,427	0	00.0%	36,954	92.3%	4	0	0
87	20	26,067	2,427	0	00.0%	38,043	68.5%	54	0	1
82	104	18,007	2,427	0	00.0%	39,132	46.0%	204	0	4
77	248	9,947	2,427	0	00.0%	40,222	24.7%	309	0	10
72	426	5,112	2,427	0	00.0%	41,311	12.4%	349	0	18
67	590	0	2,427	0	00.0%	0	00.0%	0	0	24
62	697	0	2,427	0	00.0%	0	00.0%	0	0	29
57	710	-1,236	2,427	1,638	03.8%	0	00.0%	0	12	29
52	665	-3,352	2,427	4,050	10.3%	0	00.0%	0	27	28
47	624	-5,468	2,427	6,450	16.9%	0	00.0%	0	40	26
42	594	-7,583	2,427	8,839	23.4%	0	00.0%	0	53	25
37	688	-9,699	2,427	11,217	29.9%	0	00.0%	0	77	29
32	769	-11,815	2,427	13,583	36.5%	0	00.0%	0	104	32
27	679	-13,931	2,427	15,937	43.0%	0	00.0%	0	108	28
22	533	-16,047	2,427	18,280	49.5%	0	00.0%	0	97	22
17	443	-18,163	2,427	20,611	56.1%	0	00.0%	0	91	18
12	344	-20,278	2,427	22,931	62.6%	0	00.0%	0	79	14
7	235	-22,394	2,427	25,239	69.1%	0	00.0%	0	59	10
2	147	-24,510	2,427	27,535	75.6%	0	00.0%	0	40	6
-3	79	-26,626	2,427	29,820	82.2%	0	00.0%	0	24	3
-8	37	-28,742	2,427	32,094	88.7%	0	00.0%	0	12	2
-13	13	-30,858	2,427	34,356	95.2%	0	00.0%	0	4	1
-18	3	-32,973	2,427	35,997	100.0%	0	00.0%	0	1	0
-23	1	-35,089	2,427	35,997	100.0%	0	00.0%	0	0	0
Totals	8650							920	830	359

Table B2-1.24: Annual analysis of heating and cooling loads (in blue and red rectangular boxes on the left side) and traditional HVAC applications covering the heating and cooling loads (in blue and red circular boxes on the right side) for a 2,000 square feet detached house above grade (improved construction type) in the city of Mount Forest

9. Niagara Falls (South) – Annual Hourly Heating and Cooling Loads Analysis and Coverage

Vertical Ground Source Heat Pump System (V.GSHPs)

Weather		Loads		GeoSmart Energy System					Auxiliary	
Air °F	Annual Hrs hours	Space Load Btuh/hr	DHW Btuh/hr	Geo °F	WF Air Btuh/hr	WF DHW Btuh/hr	WF Run Time	WF KWH kWh	Space kWh	DHW kWh
97	1	37,010	2,393	82	37,010	2,393	100.0%	2	0	0
92	15	30,030	2,393	74	30,030	2,393	100.0%	18	0	0
87	76	23,050	2,393	67	23,050	1,875	100.0%	61	0	13
82	232	16,070	2,393	61	16,070	1,042	100.0%	112	0	100
77	396	9,090	2,393	54	9,091	477	100.0%	97	0	242
72	621	4,902	2,393	51	9,270	411	52.9%	76	0	430
67	755	0	2,393	51	0	0	0.0%	0	0	575
62	771	0	2,393	51	0	0	0.0%	0	0	588
57	752	-1,445	2,393	53	6,531	895	22.1%	73	0	526
52	727	-3,561	2,393	51	6,382	866	55.8%	177	0	442
47	643	-5,676	2,393	49	7,131	959	79.6%	253	0	334
42	684	-7,792	2,393	48	8,996	1,209	86.6%	375	0	293
37	796	-9,908	2,393	46	10,855	1,465	91.3%	563	0	268
32	821	-12,023	2,393	44	12,708	1,728	94.6%	717	0	198
27	605	-14,139	2,393	43	14,554	1,997	97.1%	632	0	87
22	427	-16,254	2,393	41	16,393	2,274	99.2%	523	0	19
17	230	-18,370	2,393	40	18,386	2,395	99.9%	321	0	0
12	125	-20,486	2,393	38	20,502	2,395	99.9%	195	0	0
7	66	-22,601	2,393	37	22,618	2,395	99.9%	114	0	0
2	19	-24,717	2,393	36	24,733	2,395	99.9%	36	0	0
-3	2	-26,833	2,393	35	26,849	2,395	99.9%	4	0	0
Totals	8764							4351	0	4,114

Table B2-1.25: Annual analysis of heating and cooling loads (in blue and red rectangular boxes on the left side) and vertical ground source heat pump (V.GSHP) unit covering the heating and cooling loads (in blue and red circular boxes on the right side) for a 2,000 square feet detached house above grade (improved construction type) in the city of Niagara Falls

Horizontal Ground Source Heat Pump System (H.GSHPs)

Weather		Loads		GeoSmart Energy System					Auxiliary	
Air	Annual Hrs	Space Load	DHW	Geo	WF Air	WF DHW	WF Run	WF kWh	Space	DHW
°F	hours	Btuh/hr	Btuh/hr	°F	Btuh/hr	Btuh/hr	Time	kWh	kWh	kWh
97	1	37,010	2,393	75	37,010	2,393	100.0%	2	0	0
92	15	30,030	2,393	70	30,030	2,393	100.0%	17	0	0
87	76	23,050	2,393	65	23,050	1,758	100.0%	58	0	15
82	232	16,070	2,393	61	16,070	1,046	100.0%	113	0	100
77	396	9,090	2,393	56	9,090	517	100.0%	100	0	237
72	621	4,902	2,393	54	9,120	466	53.7%	81	0	424
67	755	0	2,393	51	0	0	0.0%	0	0	575
62	771	0	2,393	51	0	0	0.0%	0	0	588
57	752	-1,445	2,393	48	6,150	821	23.5%	76	0	527
52	727	-3,561	2,393	47	6,048	801	58.9%	184	0	445
47	643	-5,676	2,393	46	7,141	948	79.5%	262	0	336
42	684	-7,792	2,393	45	9,000	1,205	86.6%	386	0	294
37	796	-9,908	2,393	44	10,853	1,467	91.3%	578	0	267
32	821	-12,023	2,393	43	12,702	1,733	94.7%	732	0	197
27	605	-14,139	2,393	42	14,547	2,004	97.2%	642	0	86
22	427	-16,254	2,393	40	16,386	2,280	99.2%	528	0	18
17	230	-18,370	2,393	39	18,386	2,395	99.9%	322	0	0
12	125	-20,486	2,393	39	20,502	2,395	99.9%	195	0	0
7	66	-22,601	2,393	38	22,618	2,395	99.9%	114	0	0
2	19	-24,717	2,393	37	24,733	2,395	99.9%	36	0	0
-3	2	-26,833	2,393	36	26,849	2,395	99.9%	4	0	0
Totals	8764							4430	0	4,108

Table B2-1.26: Annual analysis of heating and cooling loads (in blue and red rectangular boxes on the left side) and horizontal ground source heat pump (H.GSHP) unit covering the heating and cooling loads (in blue and red circular boxes on the right side) for a 2,000 square feet detached house above grade (improved construction type) in the city of Niagara Falls

Traditional HVAC Applications

Weather		Loads		Fossil Furnace System				Fuel Use		
Air Temp °F	Annual hours	Space Btuh/hr	HW Load Btuh/hr	Furnace Btuh/hr	Furn Run Time	AC Cap Btuh/hr	Clg Run Time	AC kWh	Furnace ccf	HW ccf
97	1	37,010	2,393	0	00.0%	40,988	90.3%	4	0	0
92	15	30,030	2,393	0	00.0%	42,233	71.1%	49	0	1
87	76	23,050	2,393	0	00.0%	43,478	53.0%	194	0	3
82	232	16,070	2,393	0	00.0%	44,723	35.9%	436	0	9
77	396	9,090	2,393	0	00.0%	45,968	19.8%	491	0	16
72	621	4,902	2,393	0	00.0%	47,212	10.4%	535	0	25
67	755	0	2,393	0	00.0%	0	00.0%	0	0	31
62	771	0	2,393	0	00.0%	0	00.0%	0	0	32
57	752	-1,445	2,393	1,839	05.4%	0	00.0%	0	14	31
52	727	-3,561	2,393	4,247	13.2%	0	00.0%	0	31	30
47	643	-5,676	2,393	6,641	21.0%	0	00.0%	0	43	26
42	684	-7,792	2,393	9,021	28.9%	0	00.0%	0	62	28
37	796	-9,908	2,393	11,387	36.7%	0	00.0%	0	91	33
32	821	-12,023	2,393	13,740	44.5%	0	00.0%	0	113	34
27	605	-14,139	2,393	16,079	52.4%	0	00.0%	0	97	25
22	427	-16,254	2,393	18,404	60.2%	0	00.0%	0	79	17
17	230	-18,370	2,393	20,715	68.0%	0	00.0%	0	48	9
12	125	-20,486	2,393	23,012	75.9%	0	00.0%	0	29	5
7	66	-22,601	2,393	25,295	83.7%	0	00.0%	0	17	3
2	19	-24,717	2,393	27,565	91.5%	0	00.0%	0	5	1
-3	2	-26,833	2,393	29,820	99.4%	0	00.0%	0	1	0
Totals	8764							1710	627	359

Table B2-1.27: Annual analysis of heating and cooling loads (in blue and red rectangular boxes on the left side) and traditional HVAC applications covering the heating and cooling loads (in blue and red circular boxes on the right side) for a 2,000 square feet detached house above grade (improved construction type) in the city of Niagara Falls

10. Sarnia (South) – Annual Hourly Heating and Cooling Loads Analysis and Coverage Vertical Ground Source Heat Pump System (V.GSHPs)

Weather		Loads		GeoSmart Energy System					Auxiliary	
Air °F	Annual Hrs hours	Space Load Btuh/hr	DHW Btuh/hr	Geo °F	WF Air Btuh/hr	WF DHW Btuh/hr	WF Run Time	WF KWH kWh	Space kWh	DHW kWh
97	2	33,711	2,424	77	33,711	2,424	100.0%	3	0	0
92	23	27,332	2,424	70	27,332	2,424	100.0%	23	0	0
87	112	20,953	2,424	64	20,953	1,537	100.0%	76	0	32
82	254	14,574	2,424	58	14,574	863	100.0%	106	0	126
77	422	8,195	2,424	53	9,176	446	89.3%	90	0	272
72	597	4,368	2,424	49	9,340	385	46.8%	63	0	427
67	672	0	2,424	50	0	0	0.0%	0	0	519
62	653	0	2,424	50	0	0	0.0%	0	0	504
57	614	-1,979	2,424	51	6,403	870	30.9%	83	0	421
52	572	-4,095	2,424	50	6,256	841	65.5%	163	0	341
47	526	-6,210	2,424	48	7,632	1,022	81.4%	230	0	267
42	575	-8,326	2,424	46	9,494	1,276	87.7%	342	0	239
37	724	-10,442	2,424	45	11,349	1,536	92.0%	548	0	233
32	727	-12,557	2,424	43	13,198	1,802	95.1%	674	0	164
27	551	-14,673	2,424	41	15,039	2,076	97.6%	608	0	70
22	401	-16,789	2,424	40	16,873	2,357	99.5%	516	0	10
17	299	-18,904	2,424	39	18,920	2,426	99.9%	436	0	0
12	195	-21,020	2,424	37	21,036	2,425	99.9%	317	0	0
7	108	-23,135	2,424	36	23,151	2,425	99.9%	195	0	0
2	50	-25,251	2,424	35	25,267	2,425	99.9%	99	0	0
-3	19	-27,367	2,424	33	27,382	2,425	99.9%	41	0	0
-8	7	-29,482	2,424	32	29,498	2,425	99.9%	17	0	0
-13	2	-31,598	2,424	31	31,613	2,425	100.0%	5	0	0
Totals	8105							4633	0	3,624

Table B2-1.28: Annual analysis of heating and cooling loads (in blue and red rectangular boxes on the left side) and vertical ground source heat pump (V.GSHP) unit covering the heating and cooling loads (in blue and red circular boxes on the right side) for a 2,000 square feet detached house above grade (improved construction type) in the city of Sarnia

Horizontal Ground Source Heat Pump System (H.GSHPs)

Weather		Loads		GeoSmart Energy System					Auxiliary	
Air	Annual Hrs	Space Load	DHW	Geo	WF Air	WF DHW	WF Run	WF kWh	Space	DHW
°F	hours	Btuh/hr	Btuh/hr	°F	Btuh/hr	Btuh/hr	Time	kWh	kWh	kWh
97	2	33,711	2,424	71	33,711	2,424	100.0%	3	0	0
92	23	27,332	2,424	67	27,332	2,206	100.0%	22	0	2
87	112	20,953	2,424	63	20,953	1,463	100.0%	74	0	34
82	254	14,574	2,424	59	14,574	878	100.0%	107	0	125
77	422	8,195	2,424	55	9,074	483	90.3%	94	0	267
72	597	4,368	2,424	52	9,188	441	47.5%	67	0	421
67	672	0	2,424	50	0	0	0.0%	0	0	519
62	653	0	2,424	50	0	0	0.0%	0	0	504
57	614	-1,979	2,424	47	6,043	800	32.7%	86	0	423
52	572	-4,095	2,424	46	5,941	780	68.9%	169	0	344
47	526	-6,210	2,424	45	7,640	1,014	81.3%	237	0	268
42	575	-8,326	2,424	44	9,495	1,274	87.7%	351	0	239
37	724	-10,442	2,424	43	11,345	1,539	92.0%	561	0	232
32	727	-12,557	2,424	42	13,191	1,808	95.2%	686	0	163
27	551	-14,673	2,424	40	15,032	2,083	97.6%	616	0	68
22	401	-16,789	2,424	39	16,868	2,362	99.5%	520	0	9
17	299	-18,904	2,424	38	18,920	2,426	99.9%	437	0	0
12	195	-21,020	2,424	37	21,036	2,425	99.9%	316	0	0
7	108	-23,135	2,424	36	23,151	2,425	99.9%	193	0	0
2	50	-25,251	2,424	36	25,267	2,425	99.9%	98	0	0
-3	19	-27,367	2,424	35	27,383	2,425	99.9%	40	0	0
-8	7	-29,482	2,424	34	29,498	2,425	99.9%	16	0	0
-13	2	-31,598	2,424	33	31,614	2,425	100.0%	5	0	0
Totals	8105							4699	0	3,617

Table B2-1.29: Annual analysis of heating and cooling loads (in blue and red rectangular boxes on the left side) and horizontal ground source heat pump (H.GSHP) unit covering the heating and cooling loads (in blue and red circular boxes on the right side) for a 2,000 square feet detached house above grade (improved construction type) in the city of Sarnia

Traditional HVAC Applications

Weather		Loads		Fossil Furnace System				Fuel Use		
Air Temp °F	Annual hours	Space Btuh/hr	HW Load Btuh/hr	Furnace Btuh/hr	Furn Run Time	AC Cap Btuh/hr	Clg Run Time	AC kWh	Furnace ccf	HW ccf
97	2	33,711	2,424	0	00.0%	35,865	94.0%	7	0	0
92	23	27,332	2,424	0	00.0%	36,954	74.0%	68	0	1
87	112	20,953	2,424	0	00.0%	38,043	55.1%	258	0	5
82	254	14,574	2,424	0	00.0%	39,132	37.2%	428	0	11
77	422	8,195	2,424	0	00.0%	40,222	20.4%	466	0	17
72	597	4,368	2,424	0	00.0%	41,311	10.6%	454	0	25
67	672	0	2,424	0	00.0%	0	00.0%	0	0	28
62	653	0	2,424	0	00.0%	0	00.0%	0	0	27
57	614	-1,979	2,424	2,486	06.1%	0	00.0%	0	15	25
52	572	-4,095	2,424	4,894	12.6%	0	00.0%	0	28	24
47	526	-6,210	2,424	7,290	19.2%	0	00.0%	0	38	22
42	575	-8,326	2,424	9,675	25.7%	0	00.0%	0	56	24
37	724	-10,442	2,424	12,048	32.2%	0	00.0%	0	87	30
32	727	-12,557	2,424	14,410	38.8%	0	00.0%	0	105	30
27	551	-14,673	2,424	16,760	45.3%	0	00.0%	0	92	23
22	401	-16,789	2,424	19,098	51.8%	0	00.0%	0	77	17
17	299	-18,904	2,424	21,425	58.3%	0	00.0%	0	64	12
12	195	-21,020	2,424	23,741	64.9%	0	00.0%	0	46	8
7	108	-23,135	2,424	26,045	71.4%	0	00.0%	0	28	4
2	50	-25,251	2,424	28,337	77.9%	0	00.0%	0	14	2
-3	19	-27,367	2,424	30,618	84.5%	0	00.0%	0	6	1
-8	7	-29,482	2,424	32,887	91.0%	0	00.0%	0	2	0
-13	2	-31,598	2,424	35,145	97.5%	0	00.0%	0	1	0
Totals	8105							1682	660	336

Table B2-1.30: Annual analysis of heating and cooling loads (in blue and red rectangular boxes on the left side) and traditional HVAC applications covering the heating and cooling loads (in blue and red circular boxes on the right side) for a 2,000 square feet detached house above grade (improved construction type) in the city of Sarnia

11. Simcoe (South) – Annual Hourly Heating and Cooling Loads Analysis and Coverage Vertical Ground Source Heat Pump System (V.GSHPs)

Weather		Loads		GeoSmart Energy System					Auxiliary	
Air °F	Annual Hrs hours	Space Load Btuh/hr	DHW Btuh/hr	Geo °F	WF Air Btuh/hr	WF DHW Btuh/hr	WF Run Time	WF KwH kWh	Space kWh	DHW kWh
97	1	36,274	2,411	80	36,274	2,411	100.0%	2	0	0
92	7	29,563	2,411	73	29,563	2,411	100.0%	8	0	0
87	56	22,851	2,411	66	22,851	1,808	100.0%	44	0	11
82	190	16,140	2,411	60	16,140	1,024	100.0%	91	0	84
77	379	9,428	2,411	54	9,428	486	100.0%	95	0	232
72	578	5,401	2,411	50	9,277	408	58.2%	78	0	400
67	699	0	2,411	51	0	0	0.0%	0	0	537
62	730	0	2,411	51	0	0	0.0%	0	0	561
57	707	-946	2,411	52	6,512	891	14.5%	45	0	514
52	649	-3,062	2,411	51	6,363	862	48.1%	136	0	413
47	598	-5,178	2,411	49	6,709	901	77.2%	216	0	327
42	612	-7,294	2,411	47	8,575	1,151	85.1%	315	0	279
37	735	-9,410	2,411	46	10,435	1,407	90.2%	495	0	268
32	780	-11,526	2,411	44	12,288	1,669	93.8%	655	0	210
27	617	-13,642	2,411	43	14,134	1,938	96.5%	624	0	106
22	443	-15,758	2,411	41	15,973	2,215	98.7%	527	0	32
17	333	-17,874	2,411	40	17,890	2,414	99.9%	456	0	0
12	239	-19,990	2,411	38	20,006	2,413	99.9%	367	0	0
7	151	-22,106	2,411	37	22,122	2,413	99.9%	258	0	0
2	81	-24,222	2,411	36	24,237	2,413	99.9%	153	0	0
-3	35	-26,337	2,411	34	26,353	2,413	99.9%	72	0	0
-8	10	-28,453	2,411	33	28,469	2,413	99.9%	23	0	0
-13	3	-30,569	2,411	32	30,585	2,413	99.9%	7	0	0
Totals	8633							4666	0	3,973

Table B2-1.31: Annual analysis of heating and cooling loads (in blue and red rectangular boxes on the left side) and vertical ground source heat pump (V.GSHP) unit covering the heating and cooling loads (in blue and red circular boxes on the right side) for a 2,000 square feet detached house above grade (improved construction type) in the city of Simcoe

Horizontal Ground Source Heat Pump System (H.GSHPs)

Weather		Loads		GeoSmart Energy System					Auxiliary	
Air	Annual Hrs	Space Load	DHW	Geo	WF Air	WF DHW	WF Run	WF kWh	Space	DHW
°F	hours	Btuh/hr	Btuh/hr	°F	Btuh/hr	Btuh/hr	Time	kWh	kWh	kWh
97	1	36,274	2,411	74	36,274	2,411	100.0%	1	0	0
92	7	29,563	2,411	69	29,563	2,411	100.0%	8	0	0
87	56	22,851	2,411	65	22,851	1,706	100.0%	42	0	13
82	190	16,140	2,411	60	16,140	1,033	100.0%	92	0	83
77	379	9,428	2,411	56	9,428	529	100.0%	99	0	227
72	578	5,401	2,411	54	9,128	463	59.2%	83	0	393
67	699	0	2,411	51	0	0	0.0%	0	0	537
62	730	0	2,411	51	0	0	0.0%	0	0	561
57	707	-946	2,411	48	6,108	813	15.5%	47	0	515
52	649	-3,062	2,411	47	6,006	793	51.0%	142	0	415
47	598	-5,178	2,411	46	6,722	887	77.0%	224	0	329
42	612	-7,294	2,411	44	8,580	1,145	85.0%	325	0	280
37	735	-9,410	2,411	43	10,433	1,407	90.2%	510	0	267
32	780	-11,526	2,411	42	12,282	1,674	93.8%	670	0	209
27	617	-13,642	2,411	41	14,126	1,946	96.6%	636	0	105
22	443	-15,758	2,411	40	15,965	2,223	98.7%	534	0	31
17	333	-17,874	2,411	39	17,890	2,414	99.9%	459	0	0
12	239	-19,990	2,411	38	20,006	2,413	99.9%	368	0	0
7	151	-22,106	2,411	37	22,122	2,413	99.9%	257	0	0
2	81	-24,222	2,411	36	24,238	2,413	99.9%	151	0	0
-3	35	-26,337	2,411	35	26,353	2,413	99.9%	71	0	0
-8	10	-28,453	2,411	34	28,469	2,413	99.9%	22	0	0
-13	3	-30,569	2,411	33	30,585	2,413	99.9%	7	0	0
Totals	8633							4748	0	3,964

Table B2-1.32: Annual analysis of heating and cooling loads (in blue and red rectangular boxes on the left side) and horizontal ground source heat pump (H.GSHP) unit covering the heating and cooling loads (in blue and red circular boxes on the right side) for a 2,000 square feet detached house above grade (improved construction type) in the city of Simcoe

Traditional HVAC Applications

Weather		Loads		Fossil Furnace System				Fuel Use		
Air Temp °F	Annual hours	Space Btuh/hr	HW Load Btuh/hr	Furnace Btuh/hr	Furn Run Time	AC Cap Btuh/hr	Clg Run Time	AC kWh	Furnace ccf	HW ccf
97	1	36,274	2,411	0	00.0%	40,988	88.5%	4	0	0
92	7	29,563	2,411	0	00.0%	42,233	70.0%	23	0	0
87	56	22,851	2,411	0	00.0%	43,478	52.6%	142	0	2
82	190	16,140	2,411	0	00.0%	44,723	36.1%	358	0	8
77	379	9,428	2,411	0	00.0%	45,968	20.5%	480	0	16
72	578	5,401	2,411	0	00.0%	47,212	11.4%	521	0	24
67	699	0	2,411	0	00.0%	0	00.0%	0	0	29
62	730	0	2,411	0	00.0%	0	00.0%	0	0	30
57	707	-946	2,411	1,307	02.9%	0	00.0%	0	9	29
52	649	-3,062	2,411	3,721	09.5%	0	00.0%	0	24	27
47	598	-5,178	2,411	6,123	16.0%	0	00.0%	0	37	25
42	612	-7,294	2,411	8,513	22.5%	0	00.0%	0	52	25
37	735	-9,410	2,411	10,892	29.0%	0	00.0%	0	80	30
32	780	-11,526	2,411	13,260	35.6%	0	00.0%	0	103	32
27	617	-13,642	2,411	15,616	42.1%	0	00.0%	0	96	25
22	443	-15,758	2,411	17,960	48.6%	0	00.0%	0	80	18
17	333	-17,874	2,411	20,293	55.2%	0	00.0%	0	68	14
12	239	-19,990	2,411	22,615	61.7%	0	00.0%	0	54	10
7	151	-22,106	2,411	24,925	68.2%	0	00.0%	0	38	6
2	81	-24,222	2,411	27,223	74.8%	0	00.0%	0	22	3
-3	35	-26,337	2,411	29,510	81.3%	0	00.0%	0	10	1
-8	10	-28,453	2,411	31,785	87.8%	0	00.0%	0	3	0
-13	3	-30,569	2,411	34,048	94.3%	0	00.0%	0	1	0
Totals	8633							1528	677	356

Table B2-1.33: Annual analysis of heating and cooling loads (in blue and red rectangular boxes on the left side) and traditional HVAC applications covering the heating and cooling loads (in blue and red circular boxes on the right side) for a 2,000 square feet detached house above grade (improved construction type) in the city of Simcoe

12. Saint Catharines (South) – Annual Hourly Heating and Cooling Loads Analysis and Coverage

Vertical Ground Source Heat Pump System (V.GSHPs)

Weather		Loads		GeoSmart Energy System					Auxiliary	
Air	Annual Hrs	Space Load	DHW	Geo	WF Air	WF DHW	WF Run	WF KWH	Space	DHW
°F	hours	Btuh/hr	Btuh/hr	°F	Btuh/hr	Btuh/hr	Time	kWh	kWh	kWh
97	1	37,354	2,357	73	37,354	2,357	100.0%	1	0	0
92	16	30,217	2,357	68	30,217	2,357	100.0%	14	0	0
87	108	23,081	2,357	63	23,081	1,575	100.0%	69	0	27
82	289	15,945	2,357	58	15,945	884	100.0%	129	0	136
77	501	8,809	2,357	53	13,103	586	67.2%	125	0	313
72	668	4,527	2,357	51	13,271	513	34.1%	82	0	464
67	706	0	2,357	52	0	0	0.0%	0	0	530
62	688	0	2,357	52	0	0	0.0%	0	0	516
57	651	-1,820	2,357	54	9,261	1,018	19.7%	85	0	447
52	606	-3,935	2,357	53	9,074	997	43.4%	174	0	371
47	611	-6,051	2,357	52	8,889	977	68.1%	272	0	329
42	661	-8,167	2,357	50	9,484	1,065	86.1%	397	0	303
37	741	-10,282	2,357	49	11,333	1,331	90.7%	555	0	271
32	663	-12,398	2,357	48	13,179	1,601	94.1%	598	0	180
27	491	-14,514	2,357	47	15,020	1,875	96.6%	519	0	85
22	385	-16,629	2,357	45	16,859	2,152	98.6%	468	0	29
17	289	-18,745	2,357	44	18,766	2,359	99.9%	397	0	0
12	170	-20,861	2,357	43	20,882	2,359	99.9%	258	0	0
7	80	-22,976	2,357	42	22,998	2,359	99.9%	133	0	0
2	31	-25,092	2,357	41	25,113	2,359	99.9%	56	0	0
-3	8	-27,208	2,357	40	27,229	2,359	99.9%	16	0	0
-8	2	-29,323	2,357	39	29,344	2,358	99.9%	4	0	0
Totals	8366							4355	0	4,001

Table B2-1.34: Annual analysis of heating and cooling loads (in blue and red rectangular boxes on the left side) and vertical ground source heat pump (V.GSHP) unit covering the heating and cooling loads (in blue and red circular boxes on the right side) for a 2,000 square feet detached house above grade (improved construction type) in the city of Saint Catharines

Horizontal Ground Source Heat Pump System (H.GSHPs)

Weather		Loads		GeoSmart Energy System					Auxiliary	
Air	Annual Hrs	Space Load	DHW	Geo	WF Air	WF DHW	WF Run	WF kWh	Space	DHW
°F	hours	Btuh/hr	Btuh/hr	°F	Btuh/hr	Btuh/hr	Time	kWh	kWh	kWh
97	1	37,354	2,357	77	37,354	2,357	100.0%	2	0	0
92	16	30,217	2,357	71	30,217	2,357	100.0%	19	0	0
87	108	23,081	2,357	67	23,081	1,852	100.0%	86	0	17
82	289	15,945	2,357	62	15,945	1,093	100.0%	143	0	116
77	501	8,809	2,357	58	8,938	534	98.6%	126	0	292
72	668	4,527	2,357	55	9,065	487	49.9%	82	0	450
67	706	0	2,357	52	0	0	0.0%	0	0	530
62	688	0	2,357	52	0	0	0.0%	0	0	516
57	651	-1,820	2,357	49	6,221	835	29.3%	83	0	438
52	606	-3,935	2,357	48	6,119	815	64.3%	168	0	354
47	611	-6,051	2,357	47	7,436	992	81.4%	263	0	302
42	661	-8,167	2,357	46	9,296	1,247	87.9%	388	0	265
37	741	-10,282	2,357	45	11,151	1,508	92.2%	553	0	228
32	663	-12,398	2,357	43	13,001	1,773	95.4%	604	0	141
27	491	-14,514	2,357	42	14,847	2,042	97.8%	530	0	56
22	385	-16,629	2,357	41	16,688	2,317	99.6%	482	0	6
17	289	-18,745	2,357	40	18,761	2,359	99.9%	408	0	0
12	170	-20,861	2,357	39	20,877	2,359	99.9%	267	0	0
7	80	-22,976	2,357	38	22,993	2,358	99.9%	138	0	0
2	31	-25,092	2,357	37	25,108	2,358	99.9%	59	0	0
-3	8	-27,208	2,357	36	27,224	2,358	99.9%	17	0	0
-8	2	-29,323	2,357	36	29,339	2,358	99.9%	4	0	0
Totals	8366							4420	0	3,711

Table B2-1.35: Annual analysis of heating and cooling loads (in blue and red rectangular boxes on the left side) and horizontal ground source heat pump (H.GSHP) unit covering the heating and cooling loads (in blue and red circular boxes on the right side) for a 2,000 square feet detached house above grade (improved construction type) in the city of Saint Catharines

Traditional HVAC Applications

Weather		Loads		Fossil Furnace System				Fuel Use		
Air Temp	Annual	Space	HW Load	Furnace	Furn Run	AC Cap	Clg Run	AC	Furnace	HW
°F	hours	Btuh/hr	Btuh/hr	Btuh/hr	Time	Btuh/hr	Time	kWh	ccf	ccf
97	1	37,354	2,357	0	00.0%	40,988	91.1%	4	0	0
92	16	30,217	2,357	0	00.0%	42,233	71.5%	53	0	1
87	108	23,081	2,357	0	00.0%	43,478	53.1%	277	0	4
82	289	15,945	2,357	0	00.0%	44,723	35.7%	540	0	12
77	501	8,809	2,357	0	00.0%	45,968	19.2%	610	0	20
72	668	4,527	2,357	0	00.0%	47,212	09.6%	556	0	27
67	706	0	2,357	0	00.0%	0	00.0%	0	0	28
62	688	0	2,357	0	00.0%	0	00.0%	0	0	28
57	651	-1,820	2,357	2,266	06.7%	0	00.0%	0	15	26
52	606	-3,935	2,357	4,672	14.6%	0	00.0%	0	28	24
47	611	-6,051	2,357	7,063	22.4%	0	00.0%	0	43	25
42	661	-8,167	2,357	9,441	30.2%	0	00.0%	0	62	27
37	741	-10,282	2,357	11,805	38.1%	0	00.0%	0	87	30
32	663	-12,398	2,357	14,155	45.9%	0	00.0%	0	94	27
27	491	-14,514	2,357	16,492	53.8%	0	00.0%	0	81	20
22	385	-16,629	2,357	18,814	61.6%	0	00.0%	0	72	16
17	289	-18,745	2,357	21,123	69.4%	0	00.0%	0	61	12
12	170	-20,861	2,357	23,417	77.3%	0	00.0%	0	40	7
7	80	-22,976	2,357	25,698	85.1%	0	00.0%	0	21	3
2	31	-25,092	2,357	27,965	92.9%	0	00.0%	0	9	1
-3	8	-27,208	2,357	29,998	100.0%	0	00.0%	0	2	0
-8	2	-29,323	2,357	29,998	100.0%	0	00.0%	0	1	0
Totals	8366							2039	616	337

Table B2-1.36: Annual analysis of heating and cooling loads (in blue and red rectangular boxes on the left side) and traditional HVAC applications covering the heating and cooling loads (in blue and red circular boxes on the right side) for a 2,000 square feet detached house above grade (improved construction type) in the city of Saint Catharines

13. Toronto (South) – Annual Hourly Heating and Cooling Loads Analysis and Coverage Vertical Ground Source Heat Pump System (V.GSHPs)

Weather		Loads		GeoSmart Energy System					Auxiliary	
Air °F	Annual Hrs hours	Space Load Btuh/hr	DHW Btuh/hr	Geo °F	WF Air Btuh/hr	WF DHW Btuh/hr	WF Run Time	WF KWH kWh	Space kWh	DHW kWh
97	1	32,999	2,424	67	32,999	2,424	100.0%	1	0	0
92	17	26,976	2,424	63	26,976	1,881	100.0%	12	0	3
87	70	20,952	2,424	59	20,952	1,228	100.0%	39	0	27
82	178	14,929	2,424	55	14,929	729	100.0%	73	0	96
77	329	8,905	2,424	51	13,225	533	67.3%	81	0	216
72	517	5,291	2,424	49	13,367	471	39.6%	73	0	368
67	675	0	2,424	50	0	0	0.0%	0	0	521
62	717	0	2,424	50	0	0	0.0%	0	0	553
57	698	-1,056	2,424	52	8,982	987	11.8%	54	0	513
52	667	-3,171	2,424	51	8,796	966	36.0%	156	0	441
47	635	-5,287	2,424	50	8,612	946	61.4%	251	0	373
42	625	-7,402	2,424	49	8,864	987	83.5%	348	0	318
37	771	-9,518	2,424	47	10,711	1,255	88.9%	546	0	321
32	896	-11,633	2,424	46	12,554	1,528	92.7%	773	0	288
27	626	-13,749	2,424	45	14,393	1,803	95.5%	639	0	140
22	446	-15,864	2,424	44	16,229	2,083	97.8%	528	0	55
17	337	-17,980	2,424	42	18,060	2,367	99.6%	455	0	7
12	245	-20,095	2,424	41	20,116	2,426	99.9%	368	0	0
7	159	-22,211	2,424	40	22,232	2,426	99.9%	263	0	0
2	92	-24,327	2,424	39	24,348	2,426	99.9%	167	0	0
-3	45	-26,442	2,424	38	26,463	2,425	99.9%	89	0	0
-8	16	-28,558	2,424	37	28,578	2,425	99.9%	34	0	0
-13	3	-30,673	2,424	36	30,694	2,425	99.9%	7	0	0
-18	1	-32,789	2,424	35	32,809	2,425	99.9%	2	0	0
-23	1	-34,904	2,424	34	34,925	2,425	99.9%	3	0	0
Totals	8767							4962	0	4,240

Table B2-1.37: Annual analysis of heating and cooling loads (in blue and red rectangular boxes on the left side) and vertical ground source heat pump (V.GSHP) unit covering the heating and cooling loads (in blue and red circular boxes on the right side) for a 2,000 square feet detached house above grade (improved construction type) in the city of Toronto

Horizontal Ground Source Heat Pump System (H.GSHPs)

Weather		Loads		GeoSmart Energy System					Auxiliary	
Air	Annual Hrs	Space Load	DHW	Geo	WF Air	WF DHW	WF Run	WF kWh	Space	DHW
°F	hours	Btuh/hr	Btuh/hr	°F	Btuh/hr	Btuh/hr	Time	kWh	kWh	kWh
97	1	32,999	2,424	71	32,999	2,424	100.0%	1	0	0
92	17	26,976	2,424	67	26,976	2,178	100.0%	16	0	1
87	70	20,952	2,424	63	20,952	1,476	100.0%	47	0	21
82	178	14,929	2,424	59	14,929	916	100.0%	77	0	85
77	329	8,905	2,424	55	9,041	495	98.5%	80	0	203
72	517	5,291	2,424	53	9,149	456	57.8%	72	0	356
67	675	0	2,424	50	0	0	0.0%	0	0	521
62	717	0	2,424	50	0	0	0.0%	0	0	553
57	698	-1,056	2,424	47	6,066	804	17.4%	52	0	508
52	667	-3,171	2,424	46	5,964	785	53.2%	152	0	426
47	635	-5,287	2,424	45	6,829	901	77.4%	244	0	349
42	625	-7,402	2,424	44	8,686	1,159	85.2%	339	0	286
37	771	-9,518	2,424	43	10,538	1,423	90.3%	544	0	280
32	896	-11,633	2,424	42	12,385	1,691	93.9%	782	0	238
27	626	-13,749	2,424	41	14,227	1,964	96.6%	654	0	105
22	446	-15,864	2,424	40	16,065	2,242	98.8%	545	0	30
17	337	-17,980	2,424	39	17,996	2,426	99.9%	470	0	0
12	245	-20,095	2,424	38	20,111	2,425	99.9%	381	0	0
7	159	-22,211	2,424	37	22,227	2,425	99.9%	274	0	0
2	92	-24,327	2,424	36	24,342	2,425	99.9%	174	0	0
-3	45	-26,442	2,424	35	26,458	2,425	99.9%	93	0	0
-8	16	-28,558	2,424	34	28,573	2,425	99.9%	36	0	0
-13	3	-30,673	2,424	33	30,689	2,425	99.9%	7	0	0
-18	1	-32,789	2,424	32	32,804	2,425	100.0%	3	0	0
-23	1	-34,904	2,424	31	34,920	2,425	100.0%	3	0	0
Totals	8767							5043	0	3,962

Table B2-1.38: Annual analysis of heating and cooling loads (in blue and red rectangular boxes on the left side) and horizontal ground source heat pump (H.GSHP) unit covering the heating and cooling loads (in blue and red circular boxes on the right side) for a 2,000 square feet detached house above grade (improved construction type) in the city of Toronto

Traditional HVAC Applications

Weather		Loads		Fossil Furnace System				Fuel Use		
Air Temp °F	Annual hours	Space Btuh/hr	HW Load Btuh/hr	Furnace Btuh/hr	Furn Run Time	AC Cap Btuh/hr	Clg Run Time	AC kWh	Furnace ccf	HW ccf
97	1	32,999	2,424	0	00.0%	35,865	92.0%	4	0	0
92	17	26,976	2,424	0	00.0%	36,954	73.0%	50	0	1
87	70	20,952	2,424	0	00.0%	38,043	55.1%	161	0	3
82	178	14,929	2,424	0	00.0%	39,132	38.1%	305	0	7
77	329	8,905	2,424	0	00.0%	40,222	22.1%	382	0	14
72	517	5,291	2,424	0	00.0%	41,311	12.8%	431	0	21
67	675	0	2,424	0	00.0%	0	00.0%	0	0	28
62	717	0	2,424	0	00.0%	0	00.0%	0	0	30
57	698	-1,056	2,424	1,431	03.3%	0	00.0%	0	10	29
52	667	-3,171	2,424	3,844	09.8%	0	00.0%	0	26	28
47	635	-5,287	2,424	6,245	16.3%	0	00.0%	0	40	26
42	625	-7,402	2,424	8,635	22.8%	0	00.0%	0	54	26
37	771	-9,518	2,424	11,013	29.4%	0	00.0%	0	85	32
32	896	-11,633	2,424	13,380	35.9%	0	00.0%	0	120	37
27	626	-13,749	2,424	15,735	42.4%	0	00.0%	0	98	26
22	446	-15,864	2,424	18,078	49.0%	0	00.0%	0	81	18
17	337	-17,980	2,424	20,410	55.5%	0	00.0%	0	69	14
12	245	-20,095	2,424	22,730	62.0%	0	00.0%	0	56	10
7	159	-22,211	2,424	25,039	68.6%	0	00.0%	0	40	7
2	92	-24,327	2,424	27,337	75.1%	0	00.0%	0	25	4
-3	45	-26,442	2,424	29,622	81.6%	0	00.0%	0	13	2
-8	16	-28,558	2,424	31,897	88.1%	0	00.0%	0	5	1
-13	3	-30,673	2,424	34,159	94.7%	0	00.0%	0	1	0
-18	1	-32,789	2,424	35,997	100.0%	0	00.0%	0	0	0
-23	1	-34,904	2,424	35,997	100.0%	0	00.0%	0	0	0
Totals	8767							1333	723	363

Table B2-1.39: Annual analysis of heating and cooling loads (in blue and red rectangular boxes on the left side) and traditional HVAC applications covering the heating and cooling loads (in blue and red circular boxes on the right side) for a 2,000 square feet detached house above grade (improved construction type) in the city of Toronto

14. Trenton (South) – Annual Hourly Heating and Cooling Loads Analysis and Coverage Vertical Ground Source Heat Pump System (V.GSHPs)

Weather		Loads		GeoSmart Energy System					Auxiliary	
Air °F	Annual Hrs hours	Space Load Btuh/hr	DHW Btuh/hr	Geo °F	WF Air Btuh/hr	WF DHW Btuh/hr	WF Run Time	WF KWH kwh	Space kwh	DHW kwh
97	1	41,130	2,436	73	41,130	2,436	100.0%	1	0	0
92	4	33,337	2,436	67	33,337	2,436	100.0%	4	0	0
87	25	25,544	2,436	62	25,544	1,683	100.0%	17	0	6
82	123	17,751	2,436	57	17,751	928	100.0%	58	0	59
77	344	9,958	2,436	52	13,206	541	75.4%	95	0	222
72	593	5,282	2,436	48	13,390	461	39.4%	83	0	426
67	740	0	2,436	50	0	0	0.0%	0	0	574
62	726	0	2,436	50	0	0	0.0%	0	0	563
57	723	-1,066	2,436	52	8,918	980	12.0%	57	0	534
52	661	-3,182	2,436	51	8,733	959	36.4%	156	0	439
47	648	-5,297	2,436	49	8,548	939	62.0%	258	0	383
42	633	-7,413	2,436	48	8,883	992	83.5%	354	0	324
37	779	-9,529	2,436	47	10,729	1,261	88.8%	554	0	326
32	783	-11,645	2,436	46	12,572	1,534	92.6%	678	0	253
27	533	-13,761	2,436	44	14,410	1,810	95.5%	547	0	120
22	422	-15,877	2,436	43	16,246	2,091	97.7%	502	0	53
17	343	-17,992	2,436	42	18,077	2,375	99.5%	466	0	8
12	262	-20,108	2,436	41	20,129	2,438	99.9%	396	0	0
7	191	-22,224	2,436	40	22,245	2,438	99.9%	318	0	0
2	113	-24,340	2,436	39	24,361	2,438	99.9%	206	0	0
-3	68	-26,456	2,436	38	26,477	2,438	99.9%	135	0	0
-8	37	-28,572	2,436	37	28,592	2,437	99.9%	79	0	0
-13	12	-30,687	2,436	36	30,708	2,437	99.9%	28	0	0
-18	3	-32,803	2,436	35	32,824	2,437	99.9%	7	0	0
-23	1	-34,919	2,436	34	34,939	2,437	99.9%	3	0	0
Totals	8768							5000	0	4,290

Table B2-1.40: Annual analysis of heating and cooling loads (in blue and red rectangular boxes on the left side) and vertical ground source heat pump (V.GSHP) unit covering the heating and cooling loads (in blue and red circular boxes on the right side) for a 2,000 square feet detached house above grade (improved construction type) in the city of Trenton

Horizontal Ground Source Heat Pump System (H.GSHPs)

Weather		Loads		GeoSmart Energy System					Auxiliary	
Air	Annual Hrs	Space Load	DHW	Geo	WF Air	WF DHW	WF Run	WF kWh	Space	DHW
°F	hours	Btuh/hr	Btuh/hr	°F	Btuh/hr	Btuh/hr	Time	kWh	kWh	kWh
97	1	41,130	2,436	69	41,130	2,436	100.0%	1	0	0
92	4	33,337	2,436	65	33,337	2,436	100.0%	4	0	0
87	25	25,544	2,436	61	25,544	1,632	100.0%	17	0	6
82	123	17,751	2,436	58	17,751	961	100.0%	59	0	58
77	344	9,958	2,436	54	13,071	599	76.2%	98	0	217
72	593	5,282	2,436	52	13,199	544	40.0%	87	0	419
67	740	0	2,436	50	0	0	0.0%	0	0	574
62	726	0	2,436	50	0	0	0.0%	0	0	563
57	723	-1,066	2,436	47	8,237	904	12.9%	59	0	534
52	661	-3,182	2,436	47	8,109	890	39.2%	162	0	439
47	648	-5,297	2,436	46	7,982	876	66.4%	267	0	383
42	633	-7,413	2,436	45	8,866	1,007	83.6%	363	0	321
37	779	-9,529	2,436	44	10,710	1,279	89.0%	568	0	322
32	783	-11,645	2,436	43	12,551	1,554	92.8%	695	0	248
27	533	-13,761	2,436	42	14,389	1,831	95.6%	559	0	116
22	422	-15,877	2,436	42	16,225	2,111	97.9%	511	0	50
17	343	-17,992	2,436	41	18,057	2,394	99.6%	473	0	5
12	262	-20,108	2,436	40	20,129	2,438	99.9%	400	0	0
7	191	-22,224	2,436	39	22,245	2,438	99.9%	320	0	0
2	113	-24,340	2,436	38	24,361	2,438	99.9%	207	0	0
-3	68	-26,456	2,436	38	26,477	2,438	99.9%	135	0	0
-8	37	-28,572	2,436	37	28,592	2,437	99.9%	79	0	0
-13	12	-30,687	2,436	36	30,708	2,437	99.9%	28	0	0
-18	3	-32,803	2,436	36	32,824	2,437	99.9%	7	0	0
-23	1	-34,919	2,436	35	34,940	2,437	99.9%	3	0	0
Totals	8768							5102	0	4,255

Table B2-1.41: Annual analysis of heating and cooling loads (in blue and red rectangular boxes on the left side) and horizontal ground source heat pump (H.GSHP) unit covering the heating and cooling loads (in blue and red circular boxes on the right side) for a 2,000 square feet detached house above grade (improved construction type) in the city of Trenton

Traditional HVAC Applications

Weather		Loads		Fossil Furnace System				Fuel Use		
Air Temp °F	Annual hours	Space Btuh/hr	HW Load Btuh/hr	Furnace Btuh/hr	Furn Run Time	AC Cap Btuh/hr	Clg Run Time	AC kWh	Furnace ccf	HW ccf
97	1	41,130	2,436	0	00.0%	46,112	89.2%	4	0	0
92	4	33,337	2,436	0	00.0%	47,512	70.2%	15	0	0
87	25	25,544	2,436	0	00.0%	48,913	52.2%	71	0	1
82	123	17,751	2,436	0	00.0%	50,313	35.3%	257	0	5
77	344	9,958	2,436	0	00.0%	51,714	19.3%	472	0	14
72	593	5,282	2,436	0	00.0%	53,114	09.9%	564	0	25
67	740	0	2,436	0	00.0%	0	00.0%	0	0	31
62	726	0	2,436	0	00.0%	0	00.0%	0	0	30
57	723	-1,066	2,436	1,443	03.3%	0	00.0%	0	10	30
52	661	-3,182	2,436	3,856	09.8%	0	00.0%	0	25	27
47	648	-5,297	2,436	6,258	16.4%	0	00.0%	0	41	27
42	633	-7,413	2,436	8,647	22.9%	0	00.0%	0	55	26
37	779	-9,529	2,436	11,026	29.4%	0	00.0%	0	86	32
32	783	-11,645	2,436	13,393	35.9%	0	00.0%	0	105	33
27	533	-13,761	2,436	15,748	42.5%	0	00.0%	0	84	22
22	422	-15,877	2,436	18,092	49.0%	0	00.0%	0	76	18
17	343	-17,992	2,436	20,424	55.5%	0	00.0%	0	70	14
12	262	-20,108	2,436	22,744	62.1%	0	00.0%	0	60	11
7	191	-22,224	2,436	25,054	68.6%	0	00.0%	0	48	8
2	113	-24,340	2,436	27,351	75.1%	0	00.0%	0	31	5
-3	68	-26,456	2,436	29,637	81.7%	0	00.0%	0	20	3
-8	37	-28,572	2,436	31,911	88.2%	0	00.0%	0	12	2
-13	12	-30,687	2,436	34,174	94.7%	0	00.0%	0	4	0
-18	3	-32,803	2,436	35,997	100.0%	0	00.0%	0	1	0
-23	1	-34,919	2,436	35,997	100.0%	0	00.0%	0	0	0
Totals	8768							1383	728	365

Table B2-1.42: Annual analysis of heating and cooling loads (in blue and red rectangular boxes on the left side) and traditional HVAC applications covering the heating and cooling loads (in blue and red circular boxes on the right side) for a 2,000 square feet detached house above grade (improved construction type) in the city of Trenton

15. Wiarnton (South) – Annual Hourly Heating and Cooling Loads Analysis and Coverage Vertical Ground Source Heat Pump System (V.GSHPs)

Weather		Loads		GeoSmart Energy System					Auxiliary	
Air °F	Annual Hrs hours	Space Load Btuh/hr	DHW Btuh/hr	Geo °F	WF Air Btuh/hr	WF DHW Btuh/hr	WF Run Time	WF KWH kWh	Space kWh	DHW kWh
92	1	40,062	2,499	70	40,062	2,499	100.0%	1	0	0
87	19	30,324	2,499	63	30,324	2,098	100.0%	15	0	2
82	86	20,585	2,499	57	20,585	1,067	100.0%	45	0	39
77	225	10,846	2,499	50	13,291	504	81.6%	66	0	150
72	436	5,003	2,499	46	13,522	404	37.0%	56	0	326
67	633	0	2,499	48	0	0	0.0%	0	0	504
62	745	0	2,499	48	0	0	0.0%	0	0	593
57	753	-1,343	2,499	49	8,564	940	15.7%	76	0	564
52	707	-3,459	2,499	48	8,380	920	41.3%	185	0	477
47	662	-5,574	2,499	47	8,197	900	68.0%	283	0	398
42	654	-7,690	2,499	46	9,169	1,045	83.9%	384	0	338
37	784	-9,805	2,499	45	11,011	1,318	89.0%	584	0	331
32	816	-11,921	2,499	43	12,849	1,595	92.8%	738	0	265
27	656	-14,036	2,499	42	14,684	1,876	95.6%	701	0	148
22	511	-16,152	2,499	41	16,514	2,160	97.8%	633	0	63
17	404	-18,267	2,499	40	18,340	2,449	99.6%	570	0	8
12	282	-20,383	2,499	39	20,403	2,502	99.9%	443	0	0
7	175	-22,498	2,499	38	22,518	2,502	99.9%	302	0	0
2	97	-24,614	2,499	37	24,634	2,501	99.9%	183	0	0
-3	47	-26,729	2,499	36	26,749	2,501	99.9%	96	0	0
-8	19	-28,844	2,499	35	28,865	2,501	99.9%	42	0	0
-13	6	-30,960	2,499	34	30,980	2,501	99.9%	14	0	0
-18	2	-33,075	2,499	33	33,095	2,501	99.9%	5	0	0
-23	1	-35,191	2,499	32	35,211	2,501	99.9%	3	0	0
Totals	8721							5428	0	4,206

Table B2-1.43: Annual analysis of heating and cooling loads (in blue and red rectangular boxes on the left side) and vertical ground source heat pump (V.GSHP) unit covering the heating and cooling loads (in blue and red circular boxes on the right side) for a 2,000 square feet detached house above grade (improved construction type) in the city of Wiarnton

Horizontal Ground Source Heat Pump System (H.GSHPs)

Weather		Loads		GeoSmart Energy System					Auxiliary	
Air	Annual Hrs	Space Load	DHW	Geo	WF Air	WF DHW	WF Run	WF KWH	Space	DHW
°F	hours	Btuh/hr	Btuh/hr	°F	Btuh/hr	Btuh/hr	Time	kWh	kWh	kWh
92	1	40,062	2,499	65	40,062	2,499	100.0%	1	0	0
87	19	30,324	2,499	61	30,324	1,921	100.0%	15	0	4
82	86	20,585	2,499	56	20,585	1,056	100.0%	45	0	40
77	225	10,846	2,499	52	13,191	547	82.2%	68	0	147
72	436	5,003	2,499	49	13,352	478	37.5%	58	0	322
67	633	0	2,499	48	0	0	0.0%	0	0	504
62	745	0	2,499	48	0	0	0.0%	0	0	593
57	753	-1,343	2,499	46	7,957	873	16.9%	79	0	564
52	707	-3,459	2,499	45	7,830	859	44.2%	192	0	477
47	662	-5,574	2,499	44	7,704	845	72.4%	292	0	398
42	654	-7,690	2,499	43	9,153	1,060	84.0%	394	0	335
37	784	-9,805	2,499	42	10,993	1,335	89.2%	598	0	327
32	816	-11,921	2,499	41	12,831	1,613	92.9%	754	0	260
27	656	-14,036	2,499	41	14,665	1,894	95.7%	714	0	144
22	511	-16,152	2,499	40	16,497	2,177	97.9%	642	0	60
17	404	-18,267	2,499	39	18,326	2,463	99.7%	577	0	6
12	282	-20,383	2,499	38	20,403	2,502	99.9%	446	0	0
7	175	-22,498	2,499	37	22,518	2,502	99.9%	303	0	0
2	97	-24,614	2,499	37	24,634	2,501	99.9%	183	0	0
-3	47	-26,729	2,499	36	26,749	2,501	99.9%	96	0	0
-8	19	-28,844	2,499	35	28,865	2,501	99.9%	42	0	0
-13	6	-30,960	2,499	35	30,980	2,501	99.9%	14	0	0
-18	2	-33,075	2,499	34	33,096	2,501	99.9%	5	0	0
-23	1	-35,191	2,499	33	35,211	2,501	99.9%	3	0	0
Totals	8721							5520	0	4,179

Table B2-1.44: Annual analysis of heating and cooling loads (in blue and red rectangular boxes on the left side) and horizontal ground source heat pump (H.GSHP) unit covering the heating and cooling loads (in blue and red circular boxes on the right side) for a 2,000 square feet detached house above grade (improved construction type) in the city of Wiarion

Traditional HVAC Applications

Weather		Loads		Fossil Furnace System				Fuel Use		
Air Temp °F	Annual hours	Space Btuh/hr	HW Load Btuh/hr	Furnace Btuh/hr	Furn Run Time	AC Cap Btuh/hr	Clg Run Time	AC kWh	Furnace ccf	HW ccf
92	1	40,062	2,499	0	00.0%	42,233	94.9%	4	0	0
87	19	30,324	2,499	0	00.0%	43,478	69.7%	60	0	1
82	86	20,585	2,499	0	00.0%	44,723	46.0%	193	0	4
77	225	10,846	2,499	0	00.0%	45,968	23.6%	311	0	10
72	436	5,003	2,499	0	00.0%	47,212	10.6%	379	0	19
67	633	0	2,499	0	00.0%	0	00.0%	0	0	27
62	745	0	2,499	0	00.0%	0	00.0%	0	0	32
57	753	-1,343	2,499	1,760	04.1%	0	00.0%	0	13	32
52	707	-3,459	2,499	4,171	10.7%	0	00.0%	0	29	30
47	662	-5,574	2,499	6,571	17.2%	0	00.0%	0	43	28
42	654	-7,690	2,499	8,959	23.7%	0	00.0%	0	59	28
37	784	-9,805	2,499	11,335	30.3%	0	00.0%	0	89	33
32	816	-11,921	2,499	13,700	36.8%	0	00.0%	0	112	35
27	656	-14,036	2,499	16,054	43.3%	0	00.0%	0	105	28
22	511	-16,152	2,499	18,395	49.9%	0	00.0%	0	94	22
17	404	-18,267	2,499	20,726	56.4%	0	00.0%	0	84	17
12	282	-20,383	2,499	23,044	62.9%	0	00.0%	0	65	12
7	175	-22,498	2,499	25,352	69.4%	0	00.0%	0	44	7
2	97	-24,614	2,499	27,647	76.0%	0	00.0%	0	27	4
-3	47	-26,729	2,499	29,931	82.5%	0	00.0%	0	14	2
-8	19	-28,844	2,499	32,204	89.0%	0	00.0%	0	6	1
-13	6	-30,960	2,499	34,465	95.6%	0	00.0%	0	2	0
-18	2	-33,075	2,499	35,997	100.0%	0	00.0%	0	1	0
-23	1	-35,191	2,499	35,997	100.0%	0	00.0%	0	0	0
Totals	8721							947	788	372

Table B2-1.45: Annual analysis of heating and cooling loads (in blue and red rectangular boxes on the left side) and traditional HVAC applications covering the heating and cooling loads (in blue and red circular boxes on the right side) for a 2,000 square feet detached house above grade (improved construction type) in the city of Wiarnton

16. Windsor (South) – Annual Hourly Heating and Cooling Loads Analysis and Coverage Vertical Ground Source Heat Pump System (V.GSHPs)

Weather		Loads		GeoSmart Energy System					Auxiliary	
Air °F	Annual Hrs hours	Space Load Btuh/hr	DHW Btuh/hr	Geo °F	WF Air Btuh/hr	WF DHW Btuh/hr	WF Run Time	WF kWh	Space kWh	DHW kWh
97	1	33,010	2,363	78	33,010	2,363	100.0%	1	0	0
92	15	27,061	2,363	72	27,061	2,363	100.0%	16	0	0
87	90	21,112	2,363	66	21,112	1,673	100.0%	65	0	20
82	231	15,164	2,363	61	15,164	992	100.0%	106	0	101
77	431	9,215	2,363	56	9,215	505	100.0%	109	0	255
72	646	5,646	2,363	52	9,191	440	61.4%	94	0	430
67	828	0	2,363	52	0	0	0.0%	0	0	623
62	749	0	2,363	52	0	0	0.0%	0	0	564
57	656	-701	2,363	54	6,673	923	10.5%	30	0	473
52	612	-2,817	2,363	52	6,523	893	43.2%	116	0	385
47	592	-4,933	2,363	51	6,443	874	76.6%	200	0	319
42	614	-7,048	2,363	49	8,312	1,120	84.8%	300	0	276
37	715	-9,164	2,363	48	10,176	1,371	90.1%	460	0	257
32	859	-11,280	2,363	46	12,033	1,629	93.7%	692	0	229
27	637	-13,395	2,363	44	13,883	1,894	96.5%	620	0	109
22	401	-15,511	2,363	43	15,727	2,166	98.6%	460	0	29
17	299	-17,627	2,363	41	17,643	2,365	99.9%	395	0	0
12	198	-19,742	2,363	40	19,759	2,365	99.9%	294	0	0
7	119	-21,858	2,363	39	21,874	2,365	99.9%	196	0	0
2	51	-23,974	2,363	37	23,990	2,364	99.9%	93	0	0
-3	18	-26,089	2,363	36	26,105	2,364	99.9%	36	0	0
-8	2	-28,205	2,363	35	28,221	2,364	99.9%	4	0	0
-13	1	-30,320	2,363	33	30,336	2,364	99.9%	2	0	0
Totals	8765							4290	0	4,070

Table B2-1.46: Annual analysis of heating and cooling loads (in blue and red rectangular boxes on the left side) and vertical ground source heat pump (V.GSHP) unit covering the heating and cooling loads (in blue and red circular boxes on the right side) for a 2,000 square feet detached house above grade (improved construction type) in the city of Windsor

Horizontal Ground Source Heat Pump Systems (H.GSHPs)

Weather		Loads		GeoSmart Energy System					Auxiliary	
Air °F	Annual Hrs hours	Space Load Btuh/hr	DHW Btuh/hr	Geo °F	WF Air Btuh/hr	WF DHW Btuh/hr	WF Run Time	WF KWH kWh	Space kWh	DHW kWh
97	1	33,010	2,363	73	33,010	2,363	100.0%	1	0	0
92	15	27,061	2,363	69	27,061	2,352	100.0%	15	0	0
87	90	21,112	2,363	65	21,112	1,612	100.0%	63	0	22
82	231	15,164	2,363	61	15,164	1,014	100.0%	107	0	99
77	431	9,215	2,363	58	9,215	550	100.0%	113	0	249
72	646	5,646	2,363	55	9,040	496	62.4%	100	0	422
67	828	0	2,363	52	0	0	0.0%	0	0	623
62	749	0	2,363	52	0	0	0.0%	0	0	564
57	656	-701	2,363	50	6,256	841	11.2%	32	0	474
52	612	-2,817	2,363	48	6,153	821	45.8%	121	0	387
47	592	-4,933	2,363	47	6,458	858	76.4%	207	0	322
42	614	-7,048	2,363	46	8,319	1,112	84.7%	310	0	278
37	715	-9,164	2,363	45	10,176	1,370	90.1%	474	0	257
32	859	-11,280	2,363	44	12,028	1,633	93.8%	709	0	227
27	637	-13,395	2,363	43	13,876	1,901	96.5%	632	0	107
22	401	-15,511	2,363	42	15,719	2,173	98.7%	467	0	28
17	299	-17,627	2,363	41	17,643	2,365	99.9%	398	0	0
12	198	-19,742	2,363	40	19,759	2,365	99.9%	295	0	0
7	119	-21,858	2,363	39	21,874	2,365	99.9%	196	0	0
2	51	-23,974	2,363	38	23,990	2,364	99.9%	92	0	0
-3	18	-26,089	2,363	37	26,105	2,364	99.9%	36	0	0
-8	2	-28,205	2,363	36	28,221	2,364	99.9%	4	0	0
-13	1	-30,320	2,363	35	30,337	2,364	99.9%	2	0	0
Totals	8765							4375	0	4,059

Table B2-1.47: Annual analysis of heating and cooling loads (in blue and red rectangular boxes on the left side) and horizontal ground source heat pump (H.GSHP) unit covering the heating and cooling loads (in blue and red circular boxes on the right side) for a 2,000 square feet detached house above grade (improved construction type) in the city of Windsor

Traditional HVAC Applications

Weather		Loads		Fossil Furnace System				Fuel Use		
Air Temp °F	Annual hours	Space Btuh/hr	HW Load Btuh/hr	Furnace Btuh/hr	Furn Run Time	AC Cap Btuh/hr	Clg Run Time	AC kWh	Furnace ccf	HW ccf
97	1	33,010	2,363	0	00.0%	35,865	92.0%	4	0	0
92	15	27,061	2,363	0	00.0%	36,954	73.2%	44	0	1
87	90	21,112	2,363	0	00.0%	38,043	55.5%	209	0	4
82	231	15,164	2,363	0	00.0%	39,132	38.7%	401	0	9
77	431	9,215	2,363	0	00.0%	40,222	22.9%	512	0	17
72	646	5,646	2,363	0	00.0%	41,311	13.7%	556	0	26
67	828	0	2,363	0	00.0%	0	00.0%	0	0	33
62	749	0	2,363	0	00.0%	0	00.0%	0	0	30
57	656	-701	2,363	1,026	02.2%	0	00.0%	0	7	27
52	612	-2,817	2,363	3,441	08.7%	0	00.0%	0	21	25
47	592	-4,933	2,363	5,844	15.2%	0	00.0%	0	35	24
42	614	-7,048	2,363	8,236	21.8%	0	00.0%	0	51	25
37	715	-9,164	2,363	10,616	28.3%	0	00.0%	0	76	29
32	859	-11,280	2,363	12,985	34.8%	0	00.0%	0	112	35
27	637	-13,395	2,363	15,342	41.3%	0	00.0%	0	98	26
22	401	-15,511	2,363	17,687	47.9%	0	00.0%	0	71	16
17	299	-17,627	2,363	20,021	54.4%	0	00.0%	0	60	12
12	198	-19,742	2,363	22,344	60.9%	0	00.0%	0	44	8
7	119	-21,858	2,363	24,655	67.5%	0	00.0%	0	29	5
2	51	-23,974	2,363	26,954	74.0%	0	00.0%	0	14	2
-3	18	-26,089	2,363	29,242	80.5%	0	00.0%	0	5	1
-8	2	-28,205	2,363	31,518	87.1%	0	00.0%	0	1	0
-13	1	-30,320	2,363	33,783	93.6%	0	00.0%	0	0	0
Totals	8765							1725	622	354

Table B2-1.48: Annual analysis of heating and cooling loads (in blue and red rectangular boxes on the left side) and traditional HVAC applications covering the heating and cooling loads (in blue and red circular boxes on the right side) for a 2,000 square feet detached house above grade (improved construction type) in the city of Windsor

17. Barrie (Distinct) – Annual Hourly Heating and Cooling Loads Analysis and Coverage Vertical Ground Source Heat Pump System (V.GSHPs)

Weather		Loads		GeoSmart Energy System					Auxiliary	
Air °F	Annual Hrs hours	Space Load Btuh/hr	DHW Btuh/hr	Geo °F	WF Air Btuh/hr	WF DHW Btuh/hr	WF Run Time	WF kWh	Space kWh	DHW kWh
92	1	30,909	2,499	63	30,909	2,174	100.0%	1	0	0
87	23	23,883	2,499	59	23,883	1,371	100.0%	14	0	8
82	105	16,857	2,499	54	16,857	776	100.0%	46	0	58
77	234	9,830	2,499	49	13,331	486	73.7%	62	0	160
72	404	5,615	2,499	47	13,497	414	41.6%	59	0	299
67	590	0	2,499	48	0	0	0.0%	0	0	470
62	701	0	2,499	48	0	0	0.0%	0	0	558
57	693	-149	2,499	50	8,668	952	1.7%	8	0	548
52	669	-2,071	2,499	49	8,500	933	24.4%	104	0	484
47	649	-3,992	2,499	48	8,333	915	47.9%	197	0	426
42	629	-5,914	2,499	47	8,167	896	72.4%	286	0	371
37	681	-7,835	2,499	46	9,296	1,063	84.3%	408	0	348
32	852	-9,757	2,499	45	10,969	1,312	88.9%	631	0	362
27	649	-11,678	2,499	44	12,639	1,563	92.4%	575	0	218
22	482	-13,600	2,499	43	14,306	1,817	95.1%	499	0	118
17	363	-15,521	2,499	41	15,969	2,075	97.2%	431	0	56
12	309	-17,443	2,499	40	17,629	2,336	98.9%	415	0	18
7	254	-19,364	2,499	39	19,384	2,502	99.9%	380	0	0
2	179	-21,285	2,499	38	21,306	2,502	99.9%	293	0	0
-3	140	-23,207	2,499	37	23,227	2,502	99.9%	249	0	0
-8	78	-25,128	2,499	36	25,149	2,501	99.9%	150	0	0
-13	49	-27,050	2,499	36	27,070	2,501	99.9%	102	0	0
-18	20	-28,971	2,499	35	28,991	2,501	99.9%	45	0	0
-23	10	-30,893	2,499	34	30,913	2,501	99.9%	24	0	0
-28	3	-32,814	2,499	33	32,834	2,501	99.9%	8	0	0
-33	1	-34,736	2,499	32	34,755	2,501	99.9%	3	0	0
Totals	8768							4988	0	4,502

Table B2-1.49: Annual analysis of heating and cooling loads (in blue and red rectangular boxes on the left side) and vertical ground source heat pump (V.GSHP) unit covering the heating and cooling loads (in blue and red circular boxes on the right side) for a 2,000 square feet detached house above grade (improved construction type) in the city of Barrie

Horizontal Ground Source Heat Pump System (H.GSHPs)

Weather		Loads		GeoSmart Energy System					Auxiliary	
Air	Annual Hrs	Space Load	DHW	Geo	WF Air	WF DHW	WF Run	WF kWh	Space	DHW
°F	hours	Btuh/hr	Btuh/hr	°F	Btuh/hr	Btuh/hr	Time	kWh	kWh	kWh
92	1	30,909	2,499	61	30,909	1,982	100.0%	1	0	0
87	23	23,883	2,499	58	23,883	1,319	100.0%	14	0	9
82	105	16,857	2,499	55	16,857	797	100.0%	46	0	57
77	234	9,830	2,499	51	13,219	535	74.4%	63	0	157
72	404	5,615	2,499	49	13,335	485	42.1%	61	0	295
67	590	0	2,499	48	0	0	0.0%	0	0	470
62	701	0	2,499	48	0	0	0.0%	0	0	558
57	693	-149	2,499	46	8,029	881	1.9%	8	0	548
52	669	-2,071	2,499	45	7,914	868	26.2%	108	0	484
47	649	-3,992	2,499	45	7,799	855	51.2%	204	0	426
42	629	-5,914	2,499	44	7,684	843	77.0%	295	0	371
37	681	-7,835	2,499	43	9,280	1,079	84.4%	418	0	344
32	852	-9,757	2,499	42	10,951	1,329	89.1%	646	0	357
27	649	-11,678	2,499	42	12,620	1,581	92.5%	588	0	214
22	482	-13,600	2,499	41	14,287	1,835	95.2%	508	0	115
17	363	-15,521	2,499	40	15,952	2,092	97.3%	438	0	54
12	309	-17,443	2,499	39	17,614	2,351	99.0%	420	0	17
7	254	-19,364	2,499	39	19,384	2,502	99.9%	383	0	0
2	179	-21,285	2,499	38	21,306	2,502	99.9%	294	0	0
-3	140	-23,207	2,499	37	23,227	2,502	99.9%	250	0	0
-8	78	-25,128	2,499	37	25,149	2,501	99.9%	150	0	0
-13	49	-27,050	2,499	36	27,070	2,501	99.9%	101	0	0
-18	20	-28,971	2,499	35	28,991	2,501	99.9%	44	0	0
-23	10	-30,893	2,499	35	30,913	2,501	99.9%	24	0	0
-28	3	-32,814	2,499	34	32,834	2,501	99.9%	8	0	0
-33	1	-34,736	2,499	33	34,756	2,501	99.9%	3	0	0
Totals	8768							5075	0	4,476

Table B2-1.50: Annual analysis of heating and cooling loads (in blue and red rectangular boxes on the left side) and horizontal ground source heat pump (H.GSHP) unit covering the heating and cooling loads (in blue and red circular boxes on the right side) for a 2,000 square feet detached house above grade (improved construction type) in the city of Barrie

Traditional HVAC Applications

Weather		Loads		Fossil Furnace System				Fuel Use		
Air Temp °F	Annual hours	Space Btuh/hr	HW Load Btuh/hr	Furnace Btuh/hr	Furn Run Time	AC Cap Btuh/hr	Clg Run Time	AC kWh	Furnace ccf	HW ccf
92	1	30,909	2,499	0	00.0%	31,675	97.6%	3	0	0
87	23	23,883	2,499	0	00.0%	32,608	73.2%	56	0	1
82	105	16,857	2,499	0	00.0%	33,542	50.3%	189	0	4
77	234	9,830	2,499	0	00.0%	34,476	28.5%	275	0	10
72	404	5,615	2,499	0	00.0%	35,409	15.9%	323	0	17
67	590	0	2,499	0	00.0%	0	00.0%	0	0	25
62	701	0	2,499	0	00.0%	0	00.0%	0	0	30
57	693	-149	2,499	395	00.5%	0	00.0%	0	3	30
52	669	-2,071	2,499	2,591	06.4%	0	00.0%	0	17	29
47	649	-3,992	2,499	4,778	12.3%	0	00.0%	0	31	28
42	629	-5,914	2,499	6,955	18.3%	0	00.0%	0	44	27
37	681	-7,835	2,499	9,123	24.2%	0	00.0%	0	62	29
32	852	-9,757	2,499	11,281	30.1%	0	00.0%	0	96	36
27	649	-11,678	2,499	13,430	36.0%	0	00.0%	0	87	28
22	482	-13,600	2,499	15,569	42.0%	0	00.0%	0	75	21
17	363	-15,521	2,499	17,699	47.9%	0	00.0%	0	64	15
12	309	-17,443	2,499	19,819	53.8%	0	00.0%	0	61	13
7	254	-19,364	2,499	21,929	59.8%	0	00.0%	0	56	11
2	179	-21,285	2,499	24,031	65.7%	0	00.0%	0	43	8
-3	140	-23,207	2,499	26,122	71.6%	0	00.0%	0	37	6
-8	78	-25,128	2,499	28,204	77.6%	0	00.0%	0	22	3
-13	49	-27,050	2,499	30,277	83.5%	0	00.0%	0	15	2
-18	20	-28,971	2,499	32,340	89.4%	0	00.0%	0	6	1
-23	10	-30,893	2,499	34,393	95.3%	0	00.0%	0	3	0
-28	3	-32,814	2,499	35,997	100.0%	0	00.0%	0	1	0
-33	1	-34,736	2,499	35,997	100.0%	0	00.0%	0	0	0
Totals	8768							846	724	374

Table B2-1.51: Annual analysis of heating and cooling loads (in blue and red rectangular boxes on the left side) and traditional HVAC applications covering the heating and cooling loads (in blue and red circular boxes on the right side) for a 2,000 square feet detached house above grade (improved construction type) in the city of Barrie

18. Muskoka (Distinct) – Annual Hourly Heating and Cooling Loads Analysis and Coverage

Vertical Ground Source Heat Pump System (V.GSHPs)

Weather		Loads		GeoSmart Energy System						Auxiliary	
Air °F	Annual Hrs hours	Space Load Btuh/hr	DHW Btuh/hr	Geo °F	WF Air Btuh/hr	WF DHW Btuh/hr	WF Run Time	WF kWh	Space kWh	DHW kWh	
92	4	31,389	2,499	64	31,389	2,236	100.0%	3	0	0	
87	32	23,949	2,499	59	23,949	1,377	100.0%	20	0	11	
82	116	16,509	2,499	54	16,509	752	100.0%	50	0	65	
77	261	9,069	2,499	49	13,361	473	67.9%	63	0	181	
72	439	4,605	2,499	46	13,537	397	34.0%	52	0	331	
67	598	0	2,499	48	0	0	0.0%	0	0	476	
62	698	0	2,499	48	0	0	0.0%	0	0	556	
57	707	-1,159	2,499	50	8,580	942	13.5%	61	0	534	
52	670	-3,080	2,499	48	8,412	924	36.6%	156	0	461	
47	640	-5,001	2,499	47	8,246	905	60.7%	245	0	398	
42	624	-6,923	2,499	46	8,500	947	81.4%	332	0	343	
37	711	-8,844	2,499	45	10,175	1,193	86.9%	479	0	331	
32	770	-10,765	2,499	44	11,846	1,443	90.9%	629	0	291	
27	655	-12,687	2,499	43	13,514	1,696	93.9%	631	0	189	
22	495	-14,608	2,499	42	15,179	1,952	96.2%	552	0	98	
17	391	-16,529	2,499	41	16,840	2,212	98.2%	496	0	41	
12	320	-18,451	2,499	40	18,499	2,475	99.7%	457	0	3	
7	245	-20,372	2,499	39	20,392	2,502	99.9%	384	0	0	
2	175	-22,293	2,499	38	22,314	2,502	99.9%	299	0	0	
-3	124	-24,215	2,499	37	24,235	2,502	99.9%	230	0	0	
-8	81	-26,136	2,499	36	26,156	2,501	99.9%	162	0	0	
-13	46	-28,057	2,499	35	28,078	2,501	99.9%	99	0	0	
-18	23	-29,979	2,499	34	29,999	2,501	99.9%	53	0	0	
-23	11	-31,900	2,499	33	31,920	2,501	99.9%	27	0	0	
-28	5	-33,821	2,499	32	33,841	2,501	99.9%	13	0	0	
-33	2	-35,743	2,499	32	35,762	2,501	99.9%	6	0	0	
Totals	8843							5500	0	4,309	

Table B2-1.52: Annual analysis of heating and cooling loads (in blue and red rectangular boxes on the left side) and vertical ground source heat pump (V.GSHP) unit covering the heating and cooling loads (in blue and red circular boxes on the right side) for a 2,000 square feet detached house above grade (improved construction type) in the city of Muskoka

Horizontal Ground Source Heat Pump System (H.GSHPs)

Weather		Loads		GeoSmart Energy System					Auxiliary	
Air	Annual Hrs	Space Load	DHW	Geo	WF Air	WF DHW	WF Run	WF KWH	Space	DHW
°F	hours	Btuh/hr	Btuh/hr	°F	Btuh/hr	Btuh/hr	Time	kWh	kWh	kWh
92	4	31,389	2,499	61	31,389	2,033	100.0%	3	0	1
87	32	23,949	2,499	58	23,949	1,324	100.0%	19	0	12
82	116	16,509	2,499	55	16,509	774	100.0%	50	0	64
77	261	9,069	2,499	51	13,240	526	68.5%	65	0	178
72	439	4,605	2,499	49	13,362	473	34.5%	54	0	327
67	598	0	2,499	48	0	0	0.0%	0	0	476
62	698	0	2,499	48	0	0	0.0%	0	0	556
57	707	-1,159	2,499	46	7,968	874	14.5%	64	0	534
52	670	-3,080	2,499	45	7,853	861	39.2%	162	0	461
47	640	-5,001	2,499	44	7,738	849	64.6%	253	0	398
42	624	-6,923	2,499	43	8,485	961	81.6%	340	0	341
37	711	-8,844	2,499	43	10,157	1,210	87.1%	490	0	327
32	770	-10,765	2,499	42	11,827	1,461	91.0%	643	0	287
27	655	-12,687	2,499	41	13,495	1,714	94.0%	644	0	185
22	495	-14,608	2,499	40	15,161	1,970	96.4%	561	0	95
17	391	-16,529	2,499	40	16,824	2,228	98.2%	503	0	39
12	320	-18,451	2,499	39	18,485	2,488	99.8%	461	0	2
7	245	-20,372	2,499	38	20,392	2,502	99.9%	387	0	0
2	175	-22,293	2,499	38	22,314	2,502	99.9%	301	0	0
-3	124	-24,215	2,499	37	24,235	2,502	99.9%	230	0	0
-8	81	-26,136	2,499	36	26,156	2,501	99.9%	162	0	0
-13	46	-28,057	2,499	36	28,078	2,501	99.9%	99	0	0
-18	23	-29,979	2,499	35	29,999	2,501	99.9%	53	0	0
-23	11	-31,900	2,499	34	31,920	2,501	99.9%	27	0	0
-28	5	-33,821	2,499	34	33,841	2,501	99.9%	13	0	0
-33	2	-35,743	2,499	33	35,763	2,501	99.9%	5	0	0
Totals	8843							5590	0	4,281

Table B2-1.53: Annual analysis of heating and cooling loads (in blue and red rectangular boxes on the left side) and horizontal ground source heat pump (H.GSHP) unit covering the heating and cooling loads (in blue and red circular boxes on the right side) for a 2,000 square feet detached house above grade (improved construction type) in the city of Muskoka

Traditional HVAC Applications

Weather		Loads		Fossil Furnace System				Fuel Use		
Air Temp °F	Annual hours	Space Btuh/hr	HW Load Btuh/hr	Furnace Btuh/hr	Furn Run Time	AC Cap Btuh/hr	Clg Run Time	AC kWh	Furnace ccf	HW ccf
92	4	31,389	2,499	0	00.0%	31,675	99.1%	13	0	0
87	32	23,949	2,499	0	00.0%	32,608	73.4%	79	0	1
82	116	16,509	2,499	0	00.0%	33,542	49.2%	205	0	5
77	261	9,069	2,499	0	00.0%	34,476	26.3%	290	0	11
72	439	4,605	2,499	0	00.0%	35,409	13.0%	316	0	19
67	598	0	2,499	0	00.0%	0	00.0%	0	0	25
62	698	0	2,499	0	00.0%	0	00.0%	0	0	30
57	707	-1,159	2,499	1,549	03.6%	0	00.0%	0	11	30
52	670	-3,080	2,499	3,741	09.5%	0	00.0%	0	25	29
47	640	-5,001	2,499	5,922	15.4%	0	00.0%	0	38	27
42	624	-6,923	2,499	8,094	21.4%	0	00.0%	0	51	27
37	711	-8,844	2,499	10,257	27.3%	0	00.0%	0	73	30
32	770	-10,765	2,499	12,410	33.2%	0	00.0%	0	96	33
27	655	-12,687	2,499	14,554	39.2%	0	00.0%	0	95	28
22	495	-14,608	2,499	16,688	45.1%	0	00.0%	0	83	21
17	391	-16,529	2,499	18,812	51.0%	0	00.0%	0	74	17
12	320	-18,451	2,499	20,927	56.9%	0	00.0%	0	67	14
7	245	-20,372	2,499	23,033	62.9%	0	00.0%	0	56	10
2	175	-22,293	2,499	25,129	68.8%	0	00.0%	0	44	7
-3	124	-24,215	2,499	27,215	74.7%	0	00.0%	0	34	5
-8	81	-26,136	2,499	29,292	80.7%	0	00.0%	0	24	3
-13	46	-28,057	2,499	31,360	86.6%	0	00.0%	0	14	2
-18	23	-29,979	2,499	33,418	92.5%	0	00.0%	0	8	1
-23	11	-31,900	2,499	35,466	98.5%	0	00.0%	0	4	0
-28	5	-33,821	2,499	35,997	100.0%	0	00.0%	0	2	0
-33	2	-35,743	2,499	35,997	100.0%	0	00.0%	0	1	0
Totals	8843							903	798	377

Table B2-1.54: Annual analysis of heating and cooling loads (in blue and red rectangular boxes on the left side) and traditional HVAC applications covering the heating and cooling loads (in blue and red circular boxes on the right side) for a 2,000 square feet detached house above grade (improved construction type) in the city of Muskoka

19. Peterborough (Distinct) – Annual Hourly Heating and Cooling Loads Analysis and Coverage

Vertical Ground Source Heat Pump System (V.GSHPs)

Weather		Loads		GeoSmart Energy System						Auxiliary	
Air °F	Annual Hrs hours	Space Load Btuh/hr	DHW Btuh/hr	Geo °F	WF Air Btuh/hr	WF DHW Btuh/hr	WF Run Time	WF KWH kWh	Space kWh	DHW kWh	
92	7	29,866	2,466	64	29,866	2,132	100.0%	6	0	1	
87	70	22,871	2,466	59	22,871	1,336	100.0%	42	0	25	
82	230	15,876	2,466	55	15,876	748	100.0%	97	0	126	
77	424	8,881	2,466	50	13,306	498	66.7%	102	0	288	
72	593	4,684	2,466	47	13,471	426	34.8%	72	0	438	
67	682	0	2,466	49	0	0	0.0%	0	0	536	
62	696	0	2,466	49	0	0	0.0%	0	0	547	
57	672	-1,664	2,466	50	8,709	957	19.1%	83	0	489	
52	634	-3,780	2,466	49	8,524	936	44.3%	180	0	414	
47	603	-5,896	2,466	48	8,341	916	70.7%	270	0	349	
42	612	-8,012	2,466	47	9,426	1,076	85.0%	371	0	302	
37	747	-10,128	2,466	46	11,270	1,348	89.9%	569	0	298	
32	731	-12,244	2,466	44	13,110	1,624	93.4%	672	0	221	
27	568	-14,360	2,466	43	14,946	1,903	96.1%	615	0	115	
22	449	-16,476	2,466	42	16,779	2,187	98.2%	561	0	46	
17	354	-18,592	2,466	41	18,612	2,469	99.9%	503	0	0	
12	274	-20,708	2,466	40	20,728	2,468	99.9%	431	0	0	
7	198	-22,824	2,466	39	22,844	2,468	99.9%	342	0	0	
2	130	-24,940	2,466	38	24,960	2,468	99.9%	245	0	0	
-3	80	-27,056	2,466	37	27,076	2,468	99.9%	164	0	0	
-8	47	-29,172	2,466	36	29,192	2,468	99.9%	104	0	0	
-13	26	-31,288	2,466	35	31,308	2,468	99.9%	62	0	0	
-18	13	-33,404	2,466	34	33,424	2,468	99.9%	33	0	0	
-23	7	-35,520	2,466	33	35,540	2,467	99.9%	19	0	0	
-28	4	-37,636	2,466	32	37,655	2,467	99.9%	12	0	0	
-33	1	-39,751	2,466	31	39,771	2,467	100.0%	3	0	0	
Totals	8852							5559	0	4,195	

Table B2-1.55: Annual analysis of heating and cooling loads (in blue and red rectangular boxes on the left side) and vertical ground source heat pump (V.GSHP) unit covering the heating and cooling loads (in blue and red circular boxes on the right side) for a 2,000 square feet detached house above grade (improved construction type) in the city of Peterborough

Horizontal Ground Source Heat Pump System (H.GSHPs)

Weather		Loads		GeoSmart Energy System					Auxiliary	
Air	Annual Hrs	Space Load	DHW	Geo	WF Air	WF DHW	WF Run	WF kWh	Space	DHW
°F	hours	Btuh/hr	Btuh/hr	°F	Btuh/hr	Btuh/hr	Time	kWh	kWh	kWh
92	7	29,866	2,466	62	29,866	2,005	100.0%	5	0	1
87	70	22,871	2,466	59	22,871	1,327	100.0%	41	0	25
82	230	15,876	2,466	56	15,876	792	100.0%	99	0	123
77	424	8,881	2,466	53	13,154	564	67.5%	105	0	282
72	593	4,684	2,466	51	13,269	514	35.3%	76	0	431
67	682	0	2,466	49	0	0	0.0%	0	0	536
62	696	0	2,466	49	0	0	0.0%	0	0	547
57	672	-1,664	2,466	46	8,032	881	20.7%	87	0	489
52	634	-3,780	2,466	45	7,905	867	47.8%	187	0	414
47	603	-5,896	2,466	44	7,778	853	75.8%	280	0	349
42	612	-8,012	2,466	44	9,408	1,094	85.2%	382	0	299
37	747	-10,128	2,466	43	11,249	1,369	90.0%	584	0	294
32	731	-12,244	2,466	42	13,088	1,646	93.6%	689	0	216
27	568	-14,360	2,466	41	14,923	1,926	96.2%	629	0	111
22	449	-16,476	2,466	40	16,756	2,209	98.3%	572	0	42
17	354	-18,592	2,466	39	18,612	2,469	99.9%	510	0	0
12	274	-20,708	2,466	39	20,728	2,468	99.9%	436	0	0
7	198	-22,824	2,466	38	22,844	2,468	99.9%	345	0	0
2	130	-24,940	2,466	37	24,960	2,468	99.9%	247	0	0
-3	80	-27,056	2,466	37	27,076	2,468	99.9%	164	0	0
-8	47	-29,172	2,466	36	29,192	2,468	99.9%	104	0	0
-13	26	-31,288	2,466	35	31,308	2,468	99.9%	62	0	0
-18	13	-33,404	2,466	34	33,424	2,468	99.9%	33	0	0
-23	7	-35,520	2,466	34	35,540	2,467	99.9%	19	0	0
-28	4	-37,636	2,466	33	37,656	2,467	99.9%	12	0	0
-33	1	-39,751	2,466	32	39,772	2,467	99.9%	3	0	0
Totals	8852							5672	0	4,158

Table B2-1.56: Annual analysis of heating and cooling loads (in blue and red rectangular boxes on the left side) and horizontal ground source heat pump (H.GSHP) unit covering the heating and cooling loads (in blue and red circular boxes on the right side) for a 2,000 square feet detached house above grade (improved construction type) in the city of Peterborough

Traditional HVAC Applications

Weather		Loads		Fossil Furnace System				Fuel Use		
Air Temp °F	Annual hours	Space Btuh/hr	HW Load Btuh/hr	Furnace Btuh/hr	Furn Run Time	AC Cap Btuh/hr	Clg Run Time	AC kWh	Furnace ccf	HW ccf
92	7	29,866	2,466	0	00.0%	31,675	94.3%	21	0	0
87	70	22,871	2,466	0	00.0%	32,608	70.1%	166	0	3
82	230	15,876	2,466	0	00.0%	33,542	47.3%	396	0	10
77	424	8,881	2,466	0	00.0%	34,476	25.8%	465	0	18
72	593	4,684	2,466	0	00.0%	35,409	13.2%	431	0	25
67	682	0	2,466	0	00.0%	0	00.0%	0	0	29
62	696	0	2,466	0	00.0%	0	00.0%	0	0	29
57	672	-1,664	2,466	2,164	04.4%	0	00.0%	0	15	28
52	634	-3,780	2,466	4,576	10.0%	0	00.0%	0	29	27
47	603	-5,896	2,466	6,978	15.6%	0	00.0%	0	42	25
42	612	-8,012	2,466	9,370	21.2%	0	00.0%	0	57	26
37	747	-10,128	2,466	11,753	26.8%	0	00.0%	0	88	31
32	731	-12,244	2,466	14,125	32.4%	0	00.0%	0	103	31
27	568	-14,360	2,466	16,488	38.0%	0	00.0%	0	94	24
22	449	-16,476	2,466	18,840	43.6%	0	00.0%	0	85	19
17	354	-18,592	2,466	21,183	49.2%	0	00.0%	0	75	15
12	274	-20,708	2,466	23,516	54.8%	0	00.0%	0	64	12
7	198	-22,824	2,466	25,839	60.4%	0	00.0%	0	51	8
2	130	-24,940	2,466	28,152	66.0%	0	00.0%	0	37	5
-3	80	-27,056	2,466	30,455	71.6%	0	00.0%	0	24	3
-8	47	-29,172	2,466	32,748	77.2%	0	00.0%	0	15	2
-13	26	-31,288	2,466	35,032	82.8%	0	00.0%	0	9	1
-18	13	-33,404	2,466	37,305	88.4%	0	00.0%	0	5	1
-23	7	-35,520	2,466	39,569	94.0%	0	00.0%	0	3	0
-28	4	-37,636	2,466	41,822	99.6%	0	00.0%	0	2	0
-33	1	-39,751	2,466	41,997	100.0%	0	00.0%	0	0	0
Totals	8852							1479	798	372

Table B2-1.57: Annual analysis of heating and cooling loads (in blue and red rectangular boxes on the left side) and traditional HVAC applications covering the heating and cooling loads (in blue and red circular boxes on the right side) for a 2,000 square feet detached house above grade (improved construction type) in the city of Peterborough

20. Ottawa (Distinct) – Annual Hourly Heating and Cooling Loads Analysis and Coverage

Vertical Ground Source Heat Pump System (V.GSHPs)

Weather		Loads		GeoSmart Energy System					Auxiliary	
Air °F	Annual Hrs hours	Space Load Btuh/hr	DHW Btuh/hr	Geo °F	WF Air Btuh/hr	WF DHW Btuh/hr	WF Run Time	WF KWH kWh	Space kWh	DHW kWh
97	1	33,870	2,472	66	33,870	2,472	100.0%	1	0	0
92	9	27,576	2,472	62	27,576	1,833	100.0%	7	0	2
87	50	21,283	2,472	58	21,283	1,174	100.0%	27	0	21
82	161	14,989	2,472	54	14,989	680	100.0%	65	0	92
77	319	8,696	2,472	50	13,324	489	65.3%	75	0	219
72	512	4,919	2,472	47	13,473	425	36.5%	65	0	378
67	690	0	2,472	49	0	0	0.0%	0	0	543
62	712	0	2,472	49	0	0	0.0%	0	0	561
57	672	-846	2,472	51	8,749	961	9.7%	42	0	509
52	621	-2,768	2,472	50	8,581	942	32.3%	129	0	429
47	551	-4,690	2,472	48	8,414	924	55.7%	195	0	343
42	556	-6,612	2,472	47	8,248	905	80.2%	281	0	309
37	653	-8,533	2,472	46	9,886	1,145	86.3%	421	0	309
32	705	-10,455	2,472	45	11,559	1,393	90.4%	555	0	272
27	564	-12,377	2,472	44	13,230	1,644	93.6%	526	0	168
22	476	-14,299	2,472	43	14,897	1,898	96.0%	514	0	99
17	389	-16,221	2,472	42	16,561	2,155	97.9%	479	0	45
12	340	-18,143	2,472	41	18,222	2,416	99.6%	472	0	7
7	275	-20,064	2,472	40	20,085	2,475	99.9%	421	0	0
2	212	-21,986	2,472	39	22,007	2,474	99.9%	354	0	0
-3	150	-23,908	2,472	38	23,929	2,474	99.9%	272	0	0
-8	86	-25,830	2,472	37	25,850	2,474	99.9%	169	0	0
-13	44	-27,752	2,472	36	27,772	2,474	99.9%	93	0	0
-18	15	-29,673	2,472	35	29,694	2,474	99.9%	34	0	0
-23	4	-31,595	2,472	34	31,615	2,474	99.9%	10	0	0
-28	1	-33,517	2,472	33	33,537	2,474	99.9%	3	0	0
-33	1	-35,439	2,472	33	35,459	2,473	99.9%	3	0	0
Totals	8769							5211	0	4,305

Table B2-1.58: Annual analysis of heating and cooling loads (in blue and red rectangular boxes on the left side) and vertical ground source heat pump (V.GSHP) unit covering the heating and cooling loads (in blue and red circular boxes on the right side) for a 2,000 square feet detached house above grade (improved construction type) in the city of Ottawa

Horizontal Ground Source Heat Pump System (H.GSHPs)

Weather		Loads		GeoSmart Energy System					Auxiliary	
Air	Annual Hrs	Space Load	DHW	Geo	WF Air	WF DHW	WF Run	WF KWH	Space	DHW
°F	hours	Btuh/hr	Btuh/hr	°F	Btuh/hr	Btuh/hr	Time	kWh	kWh	kWh
97	1	33,870	2,472	64	33,870	2,445	100.0%	1	0	0
92	9	27,576	2,472	61	27,576	1,756	100.0%	6	0	2
87	50	21,283	2,472	58	21,283	1,186	100.0%	28	0	20
82	161	14,989	2,472	55	14,989	728	100.0%	66	0	89
77	319	8,696	2,472	52	13,167	558	66.0%	77	0	214
72	512	4,919	2,472	51	13,271	513	37.1%	69	0	372
67	690	0	2,472	49	0	0	0.0%	0	0	543
62	712	0	2,472	49	0	0	0.0%	0	0	561
57	672	-846	2,472	46	8,041	882	10.5%	44	0	509
52	621	-2,768	2,472	45	7,926	870	34.9%	134	0	429
47	551	-4,690	2,472	45	7,811	857	60.0%	203	0	344
42	556	-6,612	2,472	44	8,192	916	80.7%	289	0	307
37	653	-8,533	2,472	43	9,866	1,164	86.5%	434	0	305
32	705	-10,455	2,472	42	11,537	1,414	90.6%	570	0	267
27	564	-12,377	2,472	42	13,206	1,667	93.7%	539	0	163
22	476	-14,299	2,472	41	14,873	1,921	96.1%	526	0	95
17	389	-16,221	2,472	40	16,538	2,178	98.1%	489	0	42
12	340	-18,143	2,472	39	18,200	2,438	99.7%	480	0	5
7	275	-20,064	2,472	39	20,085	2,475	99.9%	426	0	0
2	212	-21,986	2,472	38	22,007	2,474	99.9%	358	0	0
-3	150	-23,908	2,472	37	23,928	2,474	99.9%	274	0	0
-8	86	-25,830	2,472	37	25,850	2,474	99.9%	169	0	0
-13	44	-27,752	2,472	36	27,772	2,474	99.9%	93	0	0
-18	15	-29,673	2,472	35	29,694	2,474	99.9%	34	0	0
-23	4	-31,595	2,472	35	31,616	2,474	99.9%	10	0	0
-28	1	-33,517	2,472	34	33,537	2,474	99.9%	3	0	0
-33	1	-35,439	2,472	33	35,459	2,474	99.9%	3	0	0
Totals	8769							5325	0	4,266

Table B2-1.59: Annual analysis of heating and cooling loads (in blue and red rectangular boxes on the left side) and horizontal ground source heat pump (H.GSHP) unit covering the heating and cooling loads (in blue and red circular boxes on the right side) for a 2,000 square feet detached house above grade (improved construction type) in the city of Ottawa

Traditional HVAC Applications

Weather		Loads		Fossil Furnace System				Fuel Use		
Air Temp	Annual	Space	HW Load	Furnace	Furn Run	AC Cap	Clg Run	AC	Furnace	HW
°F	hours	Btuh/hr	Btuh/hr	Btuh/hr	Time	Btuh/hr	Time	kWh	ccf	ccf
97	1	33,870	2,472	0	00.0%	35,865	94.4%	4	0	0
92	9	27,576	2,472	0	00.0%	36,954	74.6%	27	0	0
87	50	21,283	2,472	0	00.0%	38,043	55.9%	117	0	2
82	161	14,989	2,472	0	00.0%	39,132	38.3%	277	0	7
77	319	8,696	2,472	0	00.0%	40,222	21.6%	365	0	13
72	512	4,919	2,472	0	00.0%	41,311	11.9%	412	0	22
67	690	0	2,472	0	00.0%	0	00.0%	0	0	29
62	712	0	2,472	0	00.0%	0	00.0%	0	0	30
57	672	-846	2,472	1,192	02.6%	0	00.0%	0	8	28
52	621	-2,768	2,472	3,385	08.5%	0	00.0%	0	21	26
47	551	-4,690	2,472	5,569	14.5%	0	00.0%	0	31	23
42	556	-6,612	2,472	7,743	20.4%	0	00.0%	0	43	23
37	653	-8,533	2,472	9,908	26.3%	0	00.0%	0	65	28
32	705	-10,455	2,472	12,063	32.3%	0	00.0%	0	85	30
27	564	-12,377	2,472	14,209	38.2%	0	00.0%	0	80	24
22	476	-14,299	2,472	16,345	44.1%	0	00.0%	0	78	20
17	389	-16,221	2,472	18,472	50.1%	0	00.0%	0	72	16
12	340	-18,143	2,472	20,589	56.0%	0	00.0%	0	70	14
7	275	-20,064	2,472	22,696	61.9%	0	00.0%	0	62	12
2	212	-21,986	2,472	24,794	67.9%	0	00.0%	0	53	9
-3	150	-23,908	2,472	26,883	73.8%	0	00.0%	0	40	6
-8	86	-25,830	2,472	28,962	79.7%	0	00.0%	0	25	4
-13	44	-27,752	2,472	31,031	85.7%	0	00.0%	0	14	2
-18	15	-29,673	2,472	33,091	91.6%	0	00.0%	0	5	1
-23	4	-31,595	2,472	35,142	97.5%	0	00.0%	0	1	0
-28	1	-33,517	2,472	35,997	100.0%	0	00.0%	0	0	0
-33	1	-35,439	2,472	35,997	100.0%	0	00.0%	0	0	0
Totals	8769							1201	753	370

Table B2-1.60: Annual analysis of heating and cooling loads (in blue and red rectangular boxes on the left side) and traditional HVAC applications covering the heating and cooling loads (in blue and red circular boxes on the right side) for a 2,000 square feet detached house above grade (improved construction type) in the city of Ottawa

21. Kapuskasing (North) – Annual Hourly Heating and Cooling Loads Analysis and Coverage

Vertical Ground Source Heat Pump System (V.GSHPs)

Weather		Loads		GeoSmart Energy System					Auxiliary	
Air	Annual Hrs	Space Load	DHW	Geo	WF Air	WF DHW	WF Run	WF kWh	Space	DHW
°F	hours	Btuh/hr	Btuh/hr	°F	Btuh/hr	Btuh/hr	Time	kWh	kWh	kWh
97	1	45,373	2,621	70	45,373	2,621	100.0%	1	0	0
92	6	36,526	2,621	63	36,526	2,550	100.0%	6	0	0
87	30	27,679	2,621	57	27,679	1,486	100.0%	20	0	11
82	87	18,832	2,621	51	18,832	750	100.0%	39	0	52
77	171	9,985	2,621	46	13,554	390	73.7%	44	0	127
72	283	4,677	2,621	42	13,764	298	34.0%	32	0	227
67	410	0	2,621	44	0	0	0.0%	0	0	342
62	525	0	2,621	44	0	0	0.0%	0	0	438
57	588	-1,088	2,621	46	7,957	873	13.7%	50	0	468
52	615	-3,010	2,621	45	7,792	855	38.6%	146	0	449
47	611	-4,932	2,621	44	7,628	836	64.7%	240	0	405
42	594	-6,853	2,621	42	8,525	973	80.4%	324	0	348
37	632	-8,775	2,621	41	10,193	1,226	86.1%	438	0	315
32	656	-10,697	2,621	40	11,859	1,482	90.2%	554	0	268
27	579	-12,619	2,621	39	13,521	1,742	93.3%	579	0	183
22	457	-14,540	2,621	38	15,179	2,005	95.8%	529	0	102
17	399	-16,462	2,621	37	16,834	2,272	97.8%	527	0	51
12	380	-18,384	2,621	36	18,485	2,542	99.5%	566	0	11
7	355	-20,306	2,621	35	20,325	2,623	99.9%	583	0	0
2	321	-22,227	2,621	34	22,247	2,623	99.9%	576	0	0
-3	287	-24,149	2,621	33	24,169	2,623	99.9%	559	0	0
-8	249	-26,071	2,621	32	26,090	2,623	99.9%	524	0	0
-13	198	-27,993	2,621	31	28,012	2,623	99.9%	448	0	0
-18	141	-29,914	2,621	30	29,934	2,623	99.9%	342	0	0
-23	90	-31,836	2,621	30	31,855	2,622	99.9%	234	0	0
-28	53	-33,758	2,621	29	33,777	2,622	99.9%	147	0	0
-33	27	-35,680	2,621	28	35,699	2,622	99.9%	79	0	0
Totals	8745							7587	0	3,798

Table B2-1.61: Annual analysis of heating and cooling loads (in blue and red rectangular boxes on the left side) and vertical ground source heat pump (V.GSHP) unit covering the heating and cooling loads (in blue and red circular boxes on the right side) for a 2,000 square feet detached house above grade (improved construction type) in the city of Kapuskasing

Horizontal Ground Source Heat Pump System (H.GSHPs)

Weather		Loads		GeoSmart Energy System					Auxiliary	
Air	Annual Hrs	Space Load	DHW	Geo	WF Air	WF DHW	WF Run	WF KWH	Space	DHW
°F	hours	Btuh/hr	Btuh/hr	°F	Btuh/hr	Btuh/hr	Time	kWh	kWh	kWh
97	1	45,373	2,621	64	45,373	2,621	100.0%	1	0	0
92	6	36,526	2,621	60	36,526	2,221	100.0%	5	0	1
87	30	27,679	2,621	56	27,679	1,381	100.0%	19	0	12
82	87	18,832	2,621	52	18,832	761	100.0%	39	0	52
77	171	9,985	2,621	48	13,437	441	74.3%	45	0	125
72	283	4,677	2,621	45	13,583	377	34.4%	34	0	225
67	410	0	2,621	44	0	0	0.0%	0	0	342
62	525	0	2,621	44	0	0	0.0%	0	0	438
57	588	-1,088	2,621	42	7,323	803	14.9%	52	0	468
52	615	-3,010	2,621	41	7,210	790	41.7%	152	0	449
47	611	-4,932	2,621	40	7,097	777	69.5%	250	0	405
42	594	-6,853	2,621	39	8,506	992	80.6%	334	0	345
37	632	-8,775	2,621	39	10,172	1,247	86.3%	451	0	311
32	656	-10,697	2,621	38	11,836	1,505	90.4%	569	0	263
27	579	-12,619	2,621	37	13,497	1,765	93.5%	593	0	179
22	457	-14,540	2,621	36	15,156	2,028	95.9%	540	0	98
17	399	-16,462	2,621	36	16,813	2,293	97.9%	536	0	48
12	380	-18,384	2,621	35	18,467	2,560	99.6%	573	0	9
7	355	-20,306	2,621	34	20,325	2,623	99.9%	589	0	0
2	321	-22,227	2,621	34	22,247	2,623	99.9%	579	0	0
-3	287	-24,149	2,621	33	24,169	2,623	99.9%	560	0	0
-8	249	-26,071	2,621	32	26,090	2,623	99.9%	524	0	0
-13	198	-27,993	2,621	32	28,012	2,623	99.9%	447	0	0
-18	141	-29,914	2,621	31	29,934	2,623	99.9%	340	0	0
-23	90	-31,836	2,621	30	31,855	2,622	99.9%	231	0	0
-28	53	-33,758	2,621	30	33,777	2,622	99.9%	145	0	0
-33	27	-35,680	2,621	29	35,699	2,622	99.9%	78	0	0
Totals	8745							7687	0	3,769

Table B2-1.62: Annual analysis of heating and cooling loads (in blue and red rectangular boxes on the left side) and horizontal ground source heat pump (H.GSHP) unit covering the heating and cooling loads (in blue and red circular boxes on the right side) for a 2,000 square feet detached house above grade (improved construction type) in the city of Kapuskasing

Traditional HVAC Applications

Weather		Loads		Fossil Furnace System				Fuel Use		
Air Temp °F	Annual hours	Space Btuh/hr	HW Load Btuh/hr	Furnace Btuh/hr	Furn Run Time	AC Cap Btuh/hr	Clg Run Time	AC kWh	Furnace ccf	HW ccf
97	1	45,373	2,621	0	00.0%	46,112	98.4%	5	0	0
92	6	36,526	2,621	0	00.0%	47,512	76.9%	23	0	0
87	30	27,679	2,621	0	00.0%	48,913	56.6%	91	0	1
82	87	18,832	2,621	0	00.0%	50,313	37.4%	189	0	4
77	171	9,985	2,621	0	00.0%	51,714	19.3%	235	0	8
72	283	4,677	2,621	0	00.0%	53,114	08.8%	255	0	13
67	410	0	2,621	0	00.0%	0	00.0%	0	0	18
62	525	0	2,621	0	00.0%	0	00.0%	0	0	23
57	588	-1,088	2,621	1,469	03.4%	0	00.0%	0	9	26
52	615	-3,010	2,621	3,661	09.3%	0	00.0%	0	23	27
47	611	-4,932	2,621	5,843	15.2%	0	00.0%	0	36	27
42	594	-6,853	2,621	8,016	21.2%	0	00.0%	0	48	26
37	632	-8,775	2,621	10,180	27.1%	0	00.0%	0	64	28
32	656	-10,697	2,621	12,334	33.0%	0	00.0%	0	81	29
27	579	-12,619	2,621	14,478	38.9%	0	00.0%	0	84	26
22	457	-14,540	2,621	16,613	44.9%	0	00.0%	0	76	20
17	399	-16,462	2,621	18,738	50.8%	0	00.0%	0	75	18
12	380	-18,384	2,621	20,854	56.7%	0	00.0%	0	79	17
7	355	-20,306	2,621	22,960	62.7%	0	00.0%	0	82	16
2	321	-22,227	2,621	25,057	68.6%	0	00.0%	0	80	14
-3	287	-24,149	2,621	27,144	74.5%	0	00.0%	0	78	13
-8	249	-26,071	2,621	29,222	80.5%	0	00.0%	0	73	11
-13	198	-27,993	2,621	31,290	86.4%	0	00.0%	0	62	9
-18	141	-29,914	2,621	33,349	92.3%	0	00.0%	0	47	6
-23	90	-31,836	2,621	35,398	98.3%	0	00.0%	0	32	4
-28	53	-33,758	2,621	35,997	100.0%	0	00.0%	0	19	2
-33	27	-35,680	2,621	35,997	100.0%	0	00.0%	0	10	1
Totals	8745							799	1,056	390

Table B2-1.63: Annual analysis of heating and cooling loads (in blue and red rectangular boxes on the left side) and traditional HVAC applications covering the heating and cooling loads (in blue and red circular boxes on the right side) for a 2,000 square feet detached house above grade (improved construction type) in the city of Kapuskasing

22. Kenora (North) – Annual Hourly Heating and Cooling Loads Analysis and Coverage

Vertical Ground Source Heat Pump System (V.GSHPs)

Weather		Loads		GeoSmart Energy System					Auxiliary	
Air °F	Annual Hrs hours	Space Load Btuh/hr	DHW Btuh/hr	Geo °F	WF Air Btuh/hr	WF DHW Btuh/hr	WF Run Time	WF KWH kWh	Space kWh	DHW kWh
92	4	36,420	2,621	63	36,420	2,535	100.0%	4	0	0
87	25	27,644	2,621	57	27,644	1,483	100.0%	17	0	9
82	95	18,869	2,621	52	18,869	753	100.0%	43	0	57
77	216	10,094	2,621	46	13,550	391	74.5%	56	0	160
72	373	4,829	2,621	42	13,758	301	35.1%	44	0	299
67	543	0	2,621	44	0	0	0.0%	0	0	453
62	663	0	2,621	44	0	0	0.0%	0	0	553
57	673	-937	2,621	46	7,970	874	11.8%	49	0	540
52	620	-2,858	2,621	45	7,805	856	36.6%	139	0	456
47	561	-4,780	2,621	44	7,641	838	62.6%	213	0	375
42	525	-6,702	2,621	43	8,393	954	79.9%	280	0	311
37	537	-8,624	2,621	41	10,062	1,206	85.7%	366	0	271
32	559	-10,545	2,621	40	11,728	1,462	89.9%	465	0	233
27	527	-12,467	2,621	39	13,390	1,722	93.1%	520	0	171
22	466	-14,389	2,621	38	15,048	1,984	95.6%	534	0	107
17	424	-16,311	2,621	37	16,703	2,251	97.6%	555	0	57
12	383	-18,232	2,621	36	18,355	2,521	99.3%	565	0	14
7	342	-20,154	2,621	35	20,174	2,623	99.9%	558	0	0
2	302	-22,076	2,621	34	22,095	2,623	99.9%	538	0	0
-3	266	-23,998	2,621	33	24,017	2,623	99.9%	515	0	0
-8	228	-25,919	2,621	32	25,939	2,623	99.9%	477	0	0
-13	181	-27,841	2,621	31	27,861	2,623	99.9%	408	0	0
-18	123	-29,763	2,621	30	29,782	2,623	99.9%	297	0	0
-23	71	-31,685	2,621	30	31,704	2,622	99.9%	183	0	0
-28	35	-33,606	2,621	29	33,625	2,622	99.9%	96	0	0
-33	13	-35,528	2,621	28	35,547	2,622	99.9%	38	0	0
Totals	8755							6960	0	4,066

Table B2-1.64: Annual analysis of heating and cooling loads (in blue and red rectangular boxes on the left side) and vertical ground source heat pump (V.GSHP) unit covering the heating and cooling loads (in blue and red circular boxes on the right side) for a 2,000 square feet detached house above grade (improved construction type) in the city of Kenora

Horizontal Ground Source Heat Pump System (H.GSHPs)

Weather		Loads		GeoSmart Energy System					Auxiliary	
Air	Annual Hrs	Space Load	DHW	Geo	WF Air	WF DHW	WF Run	WF kWh	Space	DHW
°F	hours	Btuh/hr	Btuh/hr	°F	Btuh/hr	Btuh/hr	Time	kWh	kWh	kWh
92	4	36,420	2,621	60	36,420	2,209	100.0%	4	0	1
87	25	27,644	2,621	56	27,644	1,378	100.0%	16	0	10
82	95	18,869	2,621	52	18,869	763	100.0%	43	0	56
77	216	10,094	2,621	48	13,434	442	75.1%	57	0	157
72	373	4,829	2,621	45	13,579	379	35.6%	46	0	295
67	543	0	2,621	44	0	0	0.0%	0	0	453
62	663	0	2,621	44	0	0	0.0%	0	0	553
57	673	-937	2,621	42	7,332	804	12.8%	51	0	540
52	620	-2,858	2,621	41	7,218	791	39.6%	146	0	456
47	561	-4,780	2,621	40	7,105	778	67.3%	222	0	375
42	525	-6,702	2,621	39	8,374	972	80.0%	289	0	308
37	537	-8,624	2,621	39	10,041	1,227	85.9%	377	0	268
32	559	-10,545	2,621	38	11,705	1,484	90.1%	478	0	228
27	527	-12,467	2,621	37	13,366	1,744	93.3%	533	0	167
22	466	-14,389	2,621	36	15,025	2,007	95.8%	545	0	104
17	424	-16,311	2,621	36	16,682	2,272	97.8%	565	0	54
12	383	-18,232	2,621	35	18,336	2,539	99.4%	573	0	12
7	342	-20,154	2,621	34	20,174	2,623	99.9%	563	0	0
2	302	-22,076	2,621	34	22,095	2,623	99.9%	541	0	0
-3	266	-23,998	2,621	33	24,017	2,623	99.9%	516	0	0
-8	228	-25,919	2,621	32	25,939	2,623	99.9%	477	0	0
-13	181	-27,841	2,621	32	27,861	2,623	99.9%	406	0	0
-18	123	-29,763	2,621	31	29,782	2,623	99.9%	295	0	0
-23	71	-31,685	2,621	30	31,704	2,623	99.9%	181	0	0
-28	35	-33,606	2,621	30	33,626	2,622	99.9%	95	0	0
-33	13	-35,528	2,621	29	35,547	2,622	99.9%	37	0	0
Totals	8755							7057	0	4,037

Table B2-1.65: Annual analysis of heating and cooling loads (in blue and red rectangular boxes on the left side) and horizontal ground source heat pump (H.GSHP) unit covering the heating and cooling loads (in blue and red circular boxes on the right side) for a 2,000 square feet detached house above grade (improved construction type) in the city of Kenora

Traditional HVAC Applications

Weather		Loads		Fossil Furnace System				Fuel Use		
Air Temp °F	Annual hours	Space Btuh/hr	HW Load Btuh/hr	Furnace Btuh/hr	Furn Run Time	AC Cap Btuh/hr	Clg Run Time	AC kWh	Furnace ccf	HW ccf
92	4	36,420	2,621	0	00.0%	36,954	98.6%	15	0	0
87	25	27,644	2,621	0	00.0%	38,043	72.7%	71	0	1
82	95	18,869	2,621	0	00.0%	39,132	48.2%	193	0	4
77	216	10,094	2,621	0	00.0%	40,222	25.1%	272	0	10
72	373	4,829	2,621	0	00.0%	41,311	11.7%	297	0	17
67	543	0	2,621	0	00.0%	0	00.0%	0	0	24
62	663	0	2,621	0	00.0%	0	00.0%	0	0	30
57	673	-937	2,621	1,296	02.9%	0	00.0%	0	9	30
52	620	-2,858	2,621	3,488	08.8%	0	00.0%	0	22	28
47	561	-4,780	2,621	5,672	14.8%	0	00.0%	0	32	25
42	525	-6,702	2,621	7,845	20.7%	0	00.0%	0	41	23
37	537	-8,624	2,621	10,010	26.6%	0	00.0%	0	54	24
32	559	-10,545	2,621	12,164	32.5%	0	00.0%	0	68	25
27	527	-12,467	2,621	14,309	38.5%	0	00.0%	0	75	23
22	466	-14,389	2,621	16,445	44.4%	0	00.0%	0	77	21
17	424	-16,311	2,621	18,571	50.3%	0	00.0%	0	79	19
12	383	-18,232	2,621	20,688	56.3%	0	00.0%	0	79	17
7	342	-20,154	2,621	22,795	62.2%	0	00.0%	0	78	15
2	302	-22,076	2,621	24,892	68.1%	0	00.0%	0	75	13
-3	266	-23,998	2,621	26,980	74.1%	0	00.0%	0	72	12
-8	228	-25,919	2,621	29,059	80.0%	0	00.0%	0	66	10
-13	181	-27,841	2,621	31,128	85.9%	0	00.0%	0	56	8
-18	123	-29,763	2,621	33,187	91.9%	0	00.0%	0	41	5
-23	71	-31,685	2,621	35,237	97.8%	0	00.0%	0	25	3
-28	35	-33,606	2,621	35,997	100.0%	0	00.0%	0	13	2
-33	13	-35,528	2,621	35,997	100.0%	0	00.0%	0	5	1
Totals	8755							848	966	390

Table B2-1.66: Annual analysis of heating and cooling loads (in blue and red rectangular boxes on the left side) and traditional HVAC applications covering the heating and cooling loads (in blue and red circular boxes on the right side) for a 2,000 square feet detached house above grade (improved construction type) in the city of Kenora

23. North Bay (North) – Annual Hourly Heating and Cooling Loads Analysis and Coverage

Vertical Ground Source Heat Pump System (V.GSHPs)

Weather		Loads		GeoSmart Energy System					Auxiliary	
Air	Annual Hrs	Space Load	DHW	Geo	WF Air	WF DHW	WF Run	WF KWH	Space	DHW
°F	hours	Btuh/hr	Btuh/hr	°F	Btuh/hr	Btuh/hr	Time	kWh	kWh	kWh
92	1	34,889	2,509	66	34,889	2,509	100.0%	1	0	0
87	12	26,716	2,509	60	26,716	1,647	100.0%	8	0	3
82	59	18,542	2,509	55	18,542	888	100.0%	28	0	30
77	173	10,368	2,509	50	13,327	488	77.8%	48	0	117
72	359	5,464	2,509	46	13,521	404	40.4%	50	0	268
67	580	0	2,509	47	0	0	0.0%	0	0	463
62	724	0	2,509	47	0	0	0.0%	0	0	578
57	731	-300	2,509	50	8,608	945	3.5%	16	0	576
52	678	-2,221	2,509	49	8,440	927	26.3%	114	0	489
47	605	-4,143	2,509	48	8,273	908	50.1%	191	0	396
42	573	-6,064	2,509	47	8,108	890	74.8%	268	0	336
37	624	-7,986	2,509	45	9,433	1,086	84.7%	381	0	316
32	694	-9,907	2,509	44	11,105	1,334	89.2%	524	0	291
27	613	-11,828	2,509	43	12,774	1,586	92.6%	552	0	203
22	499	-13,750	2,509	42	14,440	1,842	95.2%	524	0	120
17	431	-15,671	2,509	41	16,103	2,100	97.3%	519	0	64
12	381	-17,592	2,509	40	17,762	2,362	99.0%	518	0	21
7	322	-19,514	2,509	39	19,534	2,511	99.9%	487	0	0
2	252	-21,435	2,509	38	21,456	2,511	99.9%	417	0	0
-3	188	-23,357	2,509	37	23,377	2,511	99.9%	338	0	0
-8	129	-25,278	2,509	36	25,298	2,511	99.9%	251	0	0
-13	77	-27,199	2,509	35	27,220	2,510	99.9%	161	0	0
-18	38	-29,121	2,509	34	29,141	2,510	99.9%	86	0	0
-23	15	-31,042	2,509	33	31,062	2,510	99.9%	36	0	0
-28	5	-32,964	2,509	33	32,983	2,510	99.9%	13	0	0
-33	1	-34,885	2,509	32	34,905	2,510	99.9%	3	0	0
Totals	8764							5534	0	4,273

Table B2-1.67: Annual analysis of heating and cooling loads (in blue and red rectangular boxes on the left side) and vertical ground source heat pump (V.GSHP) unit covering the heating and cooling loads (in blue and red circular boxes on the right side) for a 2,000 square feet detached house above grade (improved construction type) in the city of North Bay

Horizontal Ground Source Heat Pump System (H.GSHPs)

Weather		Loads		GeoSmart Energy System					Auxiliary	
Air	Annual Hrs	Space Load	DHW	Geo	WF Air	WF DHW	WF Run	WF kWh	Space	DHW
°F	hours	Btuh/hr	Btuh/hr	°F	Btuh/hr	Btuh/hr	Time	kWh	kWh	kWh
92	1	34,889	2,509	63	34,889	2,450	100.0%	1	0	0
87	12	26,716	2,509	59	26,716	1,587	100.0%	8	0	4
82	59	18,542	2,509	56	18,542	921	100.0%	28	0	30
77	173	10,368	2,509	52	13,189	548	78.6%	50	0	114
72	359	5,464	2,509	50	13,324	490	41.0%	53	0	264
67	580	0	2,509	47	0	0	0.0%	0	0	463
62	724	0	2,509	47	0	0	0.0%	0	0	578
57	731	-300	2,509	45	7,882	865	3.8%	17	0	576
52	678	-2,221	2,509	44	7,767	852	28.6%	119	0	489
47	605	-4,143	2,509	44	7,652	839	54.1%	199	0	396
42	573	-6,064	2,509	43	7,741	856	78.3%	278	0	335
37	624	-7,986	2,509	42	9,413	1,105	84.8%	393	0	312
32	694	-9,907	2,509	41	11,082	1,357	89.4%	539	0	286
27	613	-11,828	2,509	41	12,750	1,610	92.8%	567	0	198
22	499	-13,750	2,509	40	14,415	1,866	95.4%	537	0	116
17	431	-15,671	2,509	39	16,078	2,125	97.5%	530	0	60
12	381	-17,592	2,509	38	17,739	2,385	99.2%	528	0	17
7	322	-19,514	2,509	38	19,534	2,511	99.9%	494	0	0
2	252	-21,435	2,509	37	21,455	2,511	99.9%	421	0	0
-3	188	-23,357	2,509	36	23,377	2,511	99.9%	341	0	0
-8	129	-25,278	2,509	36	25,298	2,511	99.9%	252	0	0
-13	77	-27,199	2,509	35	27,220	2,510	99.9%	162	0	0
-18	38	-29,121	2,509	34	29,141	2,510	99.9%	85	0	0
-23	15	-31,042	2,509	34	31,062	2,510	99.9%	36	0	0
-28	5	-32,964	2,509	33	32,984	2,510	99.9%	13	0	0
-33	1	-34,885	2,509	32	34,905	2,510	99.9%	3	0	0
Totals	8764							5655	0	4,240

Table B2-1.68: Annual analysis of heating and cooling loads (in blue and red rectangular boxes on the left side) and horizontal ground source heat pump (H.GSHP) unit covering the heating and cooling loads (in blue and red circular boxes on the right side) for a 2,000 square feet detached house above grade (improved construction type) in the city of North Bay

Traditional HVAC Applications

Weather		Loads		Fossil Furnace System				Fuel Use		
Air Temp	Annual	Space	HW Load	Furnace	Furn Run	AC Cap	Clg Run	AC	Furnace	HW
*F	hours	Btuh/hr	Btuh/hr	Btuh/hr	Time	Btuh/hr	Time	kWh	ccf	ccf
92	1	34,889	2,509	0	00.0%	36,954	94.4%	4	0	0
87	12	26,716	2,509	0	00.0%	38,043	70.2%	33	0	1
82	59	18,542	2,509	0	00.0%	39,132	47.4%	119	0	3
77	173	10,368	2,509	0	00.0%	40,222	25.8%	222	0	7
72	359	5,464	2,509	0	00.0%	41,311	13.2%	304	0	15
67	580	0	2,509	0	00.0%	0	00.0%	0	0	25
62	724	0	2,509	0	00.0%	0	00.0%	0	0	31
57	731	-300	2,509	567	00.9%	0	00.0%	0	4	31
52	678	-2,221	2,509	2,762	06.9%	0	00.0%	0	19	29
47	605	-4,143	2,509	4,948	12.8%	0	00.0%	0	30	26
42	573	-6,064	2,509	7,125	18.7%	0	00.0%	0	41	25
37	624	-7,986	2,509	9,292	24.6%	0	00.0%	0	58	27
32	694	-9,907	2,509	11,449	30.6%	0	00.0%	0	79	30
27	613	-11,828	2,509	13,597	36.5%	0	00.0%	0	83	26
22	499	-13,750	2,509	15,736	42.4%	0	00.0%	0	79	21
17	431	-15,671	2,509	17,865	48.4%	0	00.0%	0	77	18
12	381	-17,592	2,509	19,984	54.3%	0	00.0%	0	76	16
7	322	-19,514	2,509	22,094	60.2%	0	00.0%	0	71	14
2	252	-21,435	2,509	24,194	66.2%	0	00.0%	0	61	11
-3	188	-23,357	2,509	26,285	72.1%	0	00.0%	0	49	8
-8	129	-25,278	2,509	28,366	78.0%	0	00.0%	0	37	6
-13	77	-27,199	2,509	30,438	83.9%	0	00.0%	0	23	3
-18	38	-29,121	2,509	32,500	89.9%	0	00.0%	0	12	2
-23	15	-31,042	2,509	34,553	95.8%	0	00.0%	0	5	1
-28	5	-32,964	2,509	35,997	100.0%	0	00.0%	0	2	0
-33	1	-34,885	2,509	35,997	100.0%	0	00.0%	0	0	0
Totals	8764							681	807	375

Table B2-1.69: Annual analysis of heating and cooling loads (in blue and red rectangular boxes on the left side) and traditional HVAC applications covering the heating and cooling loads (in blue and red circular boxes on the right side) for a 2,000 square feet detached house above grade (improved construction type) in the city of North Bay

24. Sault Ste. Marie (North) – Annual Hourly Heating and Cooling Loads Analysis and Coverage

Vertical Ground Source Heat Pump System (V.GSHPs)

Weather		Loads		GeoSmart Energy System					Auxiliary	
Air	Annual Hrs	Space Load	DHW	Geo	WF Air	WF DHW	WF Run	WF kWh	Space	DHW
*F	hours	Btuh/hr	Btuh/hr	*F	Btuh/hr	Btuh/hr	Time	kWh	kWh	kWh
92	1	31,400	2,509	71	31,400	2,509	100.0%	1	0	0
87	18	23,953	2,509	64	23,953	1,748	100.0%	14	0	4
82	89	16,506	2,509	57	16,506	928	100.0%	41	0	45
77	191	9,060	2,509	51	9,272	410	97.7%	43	0	128
72	329	4,592	2,509	47	9,464	340	48.5%	35	0	246
67	490	0	2,509	47	0	0	0.0%	0	0	391
62	659	0	2,509	47	0	0	0.0%	0	0	526
57	714	-1,174	2,509	49	6,209	832	18.9%	58	0	535
52	725	-3,096	2,509	48	6,076	806	51.0%	159	0	484
47	658	-5,017	2,509	46	6,665	881	75.3%	237	0	387
42	624	-6,939	2,509	45	8,354	1,113	83.1%	315	0	315
37	668	-8,861	2,509	43	10,038	1,351	88.3%	438	0	280
32	842	-10,783	2,509	42	11,716	1,595	92.0%	682	0	279
27	683	-12,705	2,509	40	13,388	1,844	94.9%	663	0	165
22	523	-14,627	2,509	39	15,054	2,099	97.2%	595	0	78
17	431	-16,548	2,509	37	16,714	2,361	99.0%	564	0	23
12	368	-18,470	2,509	36	18,486	2,511	99.9%	544	0	0
7	281	-20,392	2,509	35	20,407	2,510	99.9%	460	0	0
2	201	-22,314	2,509	34	22,329	2,510	99.9%	362	0	0
-3	126	-24,236	2,509	33	24,251	2,510	99.9%	248	0	0
-8	77	-26,158	2,509	31	26,173	2,510	99.9%	165	0	0
-13	32	-28,079	2,509	30	28,094	2,510	99.9%	74	0	0
-18	13	-30,001	2,509	29	30,016	2,510	100.0%	33	0	0
-23	3	-31,923	2,509	28	31,938	2,510	100.0%	8	0	0
Totals	8746							5739	0	3,887

Table B2-1.70: Annual analysis of heating and cooling loads (in blue and red rectangular boxes on the left side) and vertical ground source heat pump (V.GSHP) unit covering the heating and cooling loads (in blue and red circular boxes on the right side) for a 2,000 square feet detached house above grade (improved construction type) in the city of Sault Ste. Marie

Horizontal Ground Source Heat Pump System (H.GSHPs)

Weather		Loads		GeoSmart Energy System					Auxiliary	
Air	Annual Hrs	Space Load	DHW	Geo	WF Air	WF DHW	WF Run	WF kWh	Space	DHW
°F	hours	Btuh/hr	Btuh/hr	°F	Btuh/hr	Btuh/hr	Time	kWh	kWh	kWh
92	1	31,400	2,509	67	31,400	2,509	100.0%	1	0	0
87	18	23,953	2,509	62	23,953	1,620	100.0%	13	0	5
82	89	16,506	2,509	57	16,506	931	100.0%	41	0	45
77	191	9,060	2,509	53	9,173	447	98.8%	45	0	126
72	329	4,592	2,509	50	9,306	398	49.3%	37	0	242
67	490	0	2,509	47	0	0	0.0%	0	0	391
62	659	0	2,509	47	0	0	0.0%	0	0	526
57	714	-1,174	2,509	45	5,815	756	20.2%	61	0	536
52	725	-3,096	2,509	44	5,724	738	54.1%	166	0	487
47	658	-5,017	2,509	43	6,675	870	75.2%	247	0	389
42	624	-6,939	2,509	42	8,357	1,109	83.0%	327	0	315
37	668	-8,861	2,509	41	10,035	1,353	88.3%	451	0	279
32	842	-10,783	2,509	40	11,709	1,601	92.1%	700	0	277
27	683	-12,705	2,509	39	13,378	1,853	95.0%	677	0	163
22	523	-14,627	2,509	38	15,044	2,109	97.2%	604	0	76
17	431	-16,548	2,509	37	16,704	2,370	99.1%	571	0	22
12	368	-18,470	2,509	36	18,486	2,511	99.9%	547	0	0
7	281	-20,392	2,509	35	20,407	2,510	99.9%	460	0	0
2	201	-22,314	2,509	34	22,329	2,510	99.9%	361	0	0
-3	126	-24,236	2,509	33	24,251	2,510	99.9%	246	0	0
-8	77	-26,158	2,509	32	26,173	2,510	99.9%	163	0	0
-13	32	-28,079	2,509	31	28,095	2,510	99.9%	73	0	0
-18	13	-30,001	2,509	31	30,016	2,510	99.9%	32	0	0
-23	3	-31,923	2,509	30	31,938	2,510	100.0%	8	0	0
Totals	8746							5832	0	3,881

Table B2-1.71: Annual analysis of heating and cooling loads (in blue and red rectangular boxes on the left side) and horizontal ground source heat pump (H.GSHP) unit covering the heating and cooling loads (in blue and red circular boxes on the right side) for a 2,000 square feet detached house above grade (improved construction type) in the city of Sault Ste. Marie

Traditional HVAC Applications

Weather		Loads		Fossil Furnace System				Fuel Use		
Air Temp °F	Annual hours	Space Btuh/hr	HW Load Btuh/hr	Furnace Btuh/hr	Furn Run Time	AC Cap Btuh/hr	Clg Run Time	AC kWh	Furnace ccf	HW ccf
92	1	31,400	2,509	0	00.0%	31,675	99.1%	3	0	0
87	18	23,953	2,509	0	00.0%	32,608	73.5%	44	0	1
82	89	16,506	2,509	0	00.0%	33,542	49.2%	158	0	4
77	191	9,060	2,509	0	00.0%	34,476	26.3%	212	0	8
72	329	4,592	2,509	0	00.0%	35,409	13.0%	236	0	14
67	490	0	2,509	0	00.0%	0	00.0%	0	0	21
62	659	0	2,509	0	00.0%	0	00.0%	0	0	28
57	714	-1,174	2,509	1,567	03.6%	0	00.0%	0	11	31
52	725	-3,096	2,509	3,758	09.6%	0	00.0%	0	27	31
47	658	-5,017	2,509	5,940	15.5%	0	00.0%	0	39	28
42	624	-6,939	2,509	8,113	21.4%	0	00.0%	0	51	27
37	668	-8,861	2,509	10,276	27.3%	0	00.0%	0	69	29
32	842	-10,783	2,509	12,430	33.3%	0	00.0%	0	105	36
27	683	-12,705	2,509	14,574	39.2%	0	00.0%	0	100	29
22	523	-14,627	2,509	16,708	45.1%	0	00.0%	0	87	22
17	431	-16,548	2,509	18,833	51.1%	0	00.0%	0	81	18
12	368	-18,470	2,509	20,949	57.0%	0	00.0%	0	77	16
7	281	-20,392	2,509	23,055	62.9%	0	00.0%	0	65	12
2	201	-22,314	2,509	25,151	68.9%	0	00.0%	0	51	9
-3	126	-24,236	2,509	27,238	74.8%	0	00.0%	0	34	5
-8	77	-26,158	2,509	29,315	80.7%	0	00.0%	0	23	3
-13	32	-28,079	2,509	31,383	86.7%	0	00.0%	0	10	1
-18	13	-30,001	2,509	33,442	92.6%	0	00.0%	0	4	1
-23	3	-31,923	2,509	35,490	98.5%	0	00.0%	0	1	0
Totals	8746							654	834	374

Table B2-1.72: Annual analysis of heating and cooling loads (in blue and red rectangular boxes on the left side) and traditional HVAC applications covering the heating and cooling loads (in blue and red circular boxes on the right side) for a 2,000 square feet detached house above grade (improved construction type) in the city of Sault Ste. Marie

25. Sudbury (North) – Annual Hourly Heating and Cooling Loads Analysis and Coverage

Vertical Ground Source Heat Pump System (V.GSHPs)

Weather		Loads		GeoSmart Energy System					Auxiliary	
Air	Annual Hrs	Space Load	DHW	Geo	WF Air	WF DHW	WF Run	WF kWh	Space	DHW
°F	hours	Btuh/hr	Btuh/hr	°F	Btuh/hr	Btuh/hr	Time	kWh	kWh	kWh
97	1	37,702	2,509	68	37,702	2,509	100.0%	1	0	0
92	4	30,500	2,509	63	30,500	2,095	100.0%	3	0	1
87	29	23,299	2,509	58	23,299	1,296	100.0%	17	0	11
82	91	16,097	2,509	53	16,097	713	100.0%	38	0	52
77	201	8,896	2,509	49	13,385	463	66.5%	47	0	141
72	353	4,575	2,509	46	13,556	389	33.7%	41	0	267
67	540	0	2,509	47	0	0	0.0%	0	0	431
62	677	0	2,509	47	0	0	0.0%	0	0	541
57	708	-1,189	2,509	49	8,530	937	13.9%	63	0	536
52	665	-3,111	2,509	48	8,363	918	37.2%	157	0	459
47	588	-5,032	2,509	47	8,197	900	61.4%	227	0	366
42	556	-6,954	2,509	46	8,534	953	81.5%	298	0	307
37	624	-8,875	2,509	45	10,208	1,200	86.9%	423	0	291
32	691	-10,797	2,509	44	11,879	1,451	90.9%	568	0	262
27	604	-12,718	2,509	43	13,547	1,704	93.9%	585	0	175
22	490	-14,640	2,509	42	15,211	1,961	96.2%	549	0	97
17	425	-16,561	2,509	41	16,872	2,221	98.2%	542	0	44
12	384	-18,483	2,509	39	18,530	2,485	99.7%	551	0	4
7	337	-20,404	2,509	38	20,425	2,511	99.9%	531	0	0
2	268	-22,326	2,509	38	22,346	2,511	99.9%	461	0	0
-3	205	-24,247	2,509	37	24,268	2,511	99.9%	383	0	0
-8	145	-26,169	2,509	36	26,189	2,510	99.9%	292	0	0
-13	86	-28,090	2,509	35	28,110	2,510	99.9%	186	0	0
-18	44	-30,012	2,509	34	30,032	2,510	99.9%	102	0	0
-23	19	-31,933	2,509	33	31,953	2,510	99.9%	47	0	0
-28	7	-33,855	2,509	32	33,875	2,510	99.9%	19	0	0
-33	2	-35,776	2,509	31	35,796	2,510	99.9%	6	0	0
Totals	8744							6138	0	3,985

Table B2-1.73: Annual analysis of heating and cooling loads (in blue and red rectangular boxes on the left side) and vertical ground source heat pump (V.GSHP) unit covering the heating and cooling loads (in blue and red circular boxes on the right side) for a 2,000 square feet detached house above grade (improved construction type) in the city of Sudbury

Horizontal Ground Source Heat Pump System (H.GSHPs)

Weather		Loads		GeoSmart Energy System					Auxiliary	
Air	Annual Hrs	Space Load	DHW	Geo	WF Air	WF DHW	WF Run	WF kWh	Space	DHW
°F	hours	Btuh/hr	Btuh/hr	°F	Btuh/hr	Btuh/hr	Time	kWh	kWh	kWh
97	1	37,702	2,509	64	37,702	2,509	100.0%	1	0	0
92	4	30,500	2,509	61	30,500	1,962	100.0%	3	0	1
87	29	23,299	2,509	58	23,299	1,286	100.0%	17	0	11
82	91	16,097	2,509	55	16,097	758	100.0%	39	0	51
77	201	8,896	2,509	51	13,229	531	67.2%	49	0	138
72	353	4,575	2,509	49	13,348	479	34.3%	43	0	264
67	540	0	2,509	47	0	0	0.0%	0	0	431
62	677	0	2,509	47	0	0	0.0%	0	0	541
57	708	-1,189	2,509	45	7,829	859	15.2%	66	0	536
52	665	-3,111	2,509	44	7,714	846	40.3%	164	0	459
47	588	-5,032	2,509	43	7,599	833	66.2%	236	0	366
42	556	-6,954	2,509	43	8,515	971	81.7%	307	0	304
37	624	-8,875	2,509	42	10,186	1,221	87.1%	435	0	287
32	691	-10,797	2,509	41	11,855	1,474	91.1%	584	0	257
27	604	-12,718	2,509	40	13,522	1,729	94.1%	601	0	170
22	490	-14,640	2,509	40	15,186	1,986	96.4%	562	0	93
17	425	-16,561	2,509	39	16,848	2,245	98.3%	553	0	41
12	384	-18,483	2,509	38	18,507	2,507	99.9%	560	0	1
7	337	-20,404	2,509	37	20,424	2,511	99.9%	538	0	0
2	268	-22,326	2,509	37	22,346	2,511	99.9%	466	0	0
-3	205	-24,247	2,509	36	24,267	2,511	99.9%	385	0	0
-8	145	-26,169	2,509	35	26,189	2,510	99.9%	293	0	0
-13	86	-28,090	2,509	35	28,110	2,510	99.9%	187	0	0
-18	44	-30,012	2,509	34	30,032	2,510	99.9%	102	0	0
-23	19	-31,933	2,509	33	31,953	2,510	99.9%	47	0	0
-28	7	-33,855	2,509	33	33,875	2,510	99.9%	18	0	0
-33	2	-35,776	2,509	32	35,796	2,510	99.9%	6	0	0
Totals	8744							6264	0	3,949

Table B2-1.74: Annual analysis of heating and cooling loads (in blue and red rectangular boxes on the left side) and horizontal ground source heat pump (H.GSHP) unit covering the heating and cooling loads (in blue and red circular boxes on the right side) for a 2,000 square feet detached house above grade (improved construction type) in the city of Sudbury

Traditional HVAC Applications

Weather		Loads		Fossil Furnace System				Fuel Use		
Air Temp °F	Annual hours	Space Btuh/hr	HW Load Btuh/hr	Furnace Btuh/hr	Furn Run Time	AC Cap Btuh/hr	Clg Run Time	AC kWh	Furnace ccf	HW ccf
97	1	37,702	2,509	0	00.0%	40,988	92.0%	4	0	0
92	4	30,500	2,509	0	00.0%	42,233	72.2%	13	0	0
87	29	23,299	2,509	0	00.0%	43,478	53.6%	75	0	1
82	91	16,097	2,509	0	00.0%	44,723	36.0%	171	0	4
77	201	8,896	2,509	0	00.0%	45,968	19.4%	246	0	9
72	353	4,575	2,509	0	00.0%	47,212	09.7%	295	0	15
67	540	0	2,509	0	00.0%	0	00.0%	0	0	23
62	677	0	2,509	0	00.0%	0	00.0%	0	0	29
57	708	-1,189	2,509	1,585	03.7%	0	00.0%	0	11	30
52	665	-3,111	2,509	3,776	09.6%	0	00.0%	0	25	28
47	588	-5,032	2,509	5,957	15.5%	0	00.0%	0	35	25
42	556	-6,954	2,509	8,130	21.5%	0	00.0%	0	45	24
37	624	-8,875	2,509	10,292	27.4%	0	00.0%	0	64	27
32	691	-10,797	2,509	12,445	33.3%	0	00.0%	0	86	30
27	604	-12,718	2,509	14,589	39.3%	0	00.0%	0	88	26
22	490	-14,640	2,509	16,723	45.2%	0	00.0%	0	82	21
17	425	-16,561	2,509	18,848	51.1%	0	00.0%	0	80	18
12	384	-18,483	2,509	20,963	57.0%	0	00.0%	0	80	16
7	337	-20,404	2,509	23,068	63.0%	0	00.0%	0	78	14
2	268	-22,326	2,509	25,164	68.9%	0	00.0%	0	67	11
-3	205	-24,247	2,509	27,251	74.8%	0	00.0%	0	56	9
-8	145	-26,169	2,509	29,328	80.8%	0	00.0%	0	43	6
-13	86	-28,090	2,509	31,395	86.7%	0	00.0%	0	27	4
-18	44	-30,012	2,509	33,453	92.6%	0	00.0%	0	15	2
-23	19	-31,933	2,509	35,501	98.6%	0	00.0%	0	7	1
-28	7	-33,855	2,509	35,997	100.0%	0	00.0%	0	3	0
-33	2	-35,776	2,509	35,997	100.0%	0	00.0%	0	1	0
Totals	8744							804	893	374

Table B2-1.75: Annual analysis of heating and cooling loads (in blue and red rectangular boxes on the left side) and traditional HVAC applications covering the heating and cooling loads (in blue and red circular boxes on the right side) for a 2,000 square feet detached house above grade (improved construction type) in the city of Sudbury

26. Thunder Bay (North) – Annual Hourly Heating and Cooling Loads Analysis and Coverage

Vertical Ground Source Heat Pump System (V.GSHPs)

Weather		Loads		GeoSmart Energy System					Auxiliary	
Air °F	Annual Hrs hours	Space Load Btuh/hr	DHW Btuh/hr	Geo °F	WF Air Btuh/hr	WF DHW Btuh/hr	WF Run Time	WF kWh	Space kWh	DHW kWh
92	1	36,052	2,621	63	36,052	2,484	100.0%	1	0	0
87	19	27,351	2,621	57	27,351	1,453	100.0%	12	0	7
82	67	18,651	2,621	51	18,651	738	100.0%	30	0	40
77	139	9,951	2,621	46	13,555	389	73.4%	35	0	103
72	256	4,731	2,621	42	13,762	299	34.4%	29	0	205
67	403	0	2,621	44	0	0	0.0%	0	0	336
62	587	0	2,621	44	0	0	0.0%	0	0	490
57	701	-1,034	2,621	46	7,962	874	13.0%	56	0	560
52	756	-2,956	2,621	45	7,797	855	37.9%	176	0	553
47	681	-4,878	2,621	44	7,632	837	63.9%	265	0	452
42	610	-6,799	2,621	42	8,478	966	80.2%	330	0	359
37	673	-8,721	2,621	41	10,146	1,219	86.0%	464	0	337
32	758	-10,642	2,621	40	11,811	1,475	90.1%	637	0	312
27	627	-12,564	2,621	39	13,473	1,735	93.3%	624	0	200
22	478	-14,486	2,621	38	15,132	1,998	95.7%	552	0	108
17	364	-16,407	2,621	37	16,786	2,264	97.7%	479	0	47
12	345	-18,329	2,621	36	18,437	2,534	99.4%	512	0	11
7	325	-20,250	2,621	35	20,270	2,623	99.9%	533	0	0
2	268	-22,172	2,621	34	22,191	2,623	99.9%	479	0	0
-3	248	-24,094	2,621	33	24,113	2,623	99.9%	482	0	0
-8	198	-26,015	2,621	32	26,035	2,623	99.9%	416	0	0
-13	134	-27,937	2,621	31	27,956	2,623	99.9%	303	0	0
-18	72	-29,859	2,621	30	29,878	2,623	99.9%	174	0	0
-23	39	-31,780	2,621	30	31,799	2,622	99.9%	101	0	0
-28	16	-33,702	2,621	29	33,721	2,622	99.9%	44	0	0
-33	2	-35,623	2,621	28	35,642	2,622	99.9%	6	0	0
Totals	8767							6740	0	4,122

Table B2-1.76: Annual analysis of heating and cooling loads (in blue and red rectangular boxes on the left side) and vertical ground source heat pump (V.GSHP) unit covering the heating and cooling loads (in blue and red circular boxes on the right side) for a 2,000 square feet detached house above grade (improved construction type) in the city of Thunder Bay

Horizontal Ground Source Heat Pump System (H.GSHPs)

Weather		Loads		GeoSmart Energy System					Auxiliary	
Air	Annual Hrs	Space Load	DHW	Geo	WF Air	WF DHW	WF Run	WF kWh	Space	DHW
°F	hours	Btuh/hr	Btuh/hr	°F	Btuh/hr	Btuh/hr	Time	kWh	kWh	kWh
92	1	36,052	2,621	60	36,052	2,170	100.0%	1	0	0
87	19	27,351	2,621	56	27,351	1,354	100.0%	12	0	8
82	67	18,651	2,621	52	18,651	751	100.0%	30	0	40
77	139	9,951	2,621	48	13,438	440	74.1%	36	0	102
72	256	4,731	2,621	45	13,581	378	34.8%	31	0	203
67	403	0	2,621	44	0	0	0.0%	0	0	336
62	587	0	2,621	44	0	0	0.0%	0	0	490
57	701	-1,034	2,621	42	7,326	803	14.1%	59	0	560
52	756	-2,956	2,621	41	7,213	790	41.0%	184	0	553
47	681	-4,878	2,621	40	7,100	778	68.7%	275	0	453
42	610	-6,799	2,621	39	8,458	985	80.4%	340	0	355
37	673	-8,721	2,621	39	10,125	1,240	86.1%	477	0	333
32	758	-10,642	2,621	38	11,788	1,498	90.3%	654	0	306
27	627	-12,564	2,621	37	13,450	1,758	93.4%	639	0	196
22	478	-14,486	2,621	36	15,109	2,020	95.9%	563	0	104
17	364	-16,407	2,621	36	16,765	2,285	97.9%	488	0	45
12	345	-18,329	2,621	35	18,419	2,553	99.5%	519	0	9
7	325	-20,250	2,621	34	20,270	2,623	99.9%	538	0	0
2	268	-22,172	2,621	34	22,191	2,623	99.9%	482	0	0
-3	248	-24,094	2,621	33	24,113	2,623	99.9%	483	0	0
-8	198	-26,015	2,621	32	26,035	2,623	99.9%	415	0	0
-13	134	-27,937	2,621	32	27,956	2,623	99.9%	302	0	0
-18	72	-29,859	2,621	31	29,878	2,623	99.9%	173	0	0
-23	39	-31,780	2,621	30	31,799	2,623	99.9%	100	0	0
-28	16	-33,702	2,621	30	33,721	2,622	99.9%	44	0	0
-33	2	-35,623	2,621	29	35,642	2,622	99.9%	6	0	0
Totals	8767							6851	0	4,092

Table B2-1.77: Annual analysis of heating and cooling loads (in blue and red rectangular boxes on the left side) and horizontal ground source heat pump (H.GSHP) unit covering the heating and cooling loads (in blue and red circular boxes on the right side) for a 2,000 square feet detached house above grade (improved construction type) in the city of Thunder Bay

Traditional HVAC Applications

Weather		Loads		Fossil Furnace System				Fuel Use		
Air Temp °F	Annual hours	Space Btuh/hr	HW Load Btuh/hr	Furnace Btuh/hr	Furn Run Time	AC Cap Btuh/hr	Clg Run Time	AC kWh	Furnace ccf	HW ccf
92	1	36,052	2,621	0	00.0%	36,954	97.6%	4	0	0
87	19	27,351	2,621	0	00.0%	38,043	71.9%	54	0	1
82	67	18,651	2,621	0	00.0%	39,132	47.7%	135	0	3
77	139	9,951	2,621	0	00.0%	40,222	24.7%	173	0	6
72	256	4,731	2,621	0	00.0%	41,311	11.5%	202	0	11
67	403	0	2,621	0	00.0%	0	00.0%	0	0	18
62	587	0	2,621	0	00.0%	0	00.0%	0	0	26
57	701	-1,034	2,621	1,407	03.2%	0	00.0%	0	10	31
52	756	-2,956	2,621	3,599	09.1%	0	00.0%	0	27	34
47	681	-4,878	2,621	5,782	15.1%	0	00.0%	0	39	30
42	610	-6,799	2,621	7,955	21.0%	0	00.0%	0	49	27
37	673	-8,721	2,621	10,119	26.9%	0	00.0%	0	68	30
32	758	-10,642	2,621	12,273	32.8%	0	00.0%	0	93	34
27	627	-12,564	2,621	14,417	38.8%	0	00.0%	0	90	28
22	478	-14,486	2,621	16,552	44.7%	0	00.0%	0	79	21
17	364	-16,407	2,621	18,678	50.6%	0	00.0%	0	68	16
12	345	-18,329	2,621	20,794	56.6%	0	00.0%	0	72	15
7	325	-20,250	2,621	22,900	62.5%	0	00.0%	0	74	14
2	268	-22,172	2,621	24,997	68.4%	0	00.0%	0	67	12
-3	248	-24,094	2,621	27,084	74.4%	0	00.0%	0	67	11
-8	198	-26,015	2,621	29,162	80.3%	0	00.0%	0	58	9
-13	134	-27,937	2,621	31,230	86.2%	0	00.0%	0	42	6
-18	72	-29,859	2,621	33,289	92.2%	0	00.0%	0	24	3
-23	39	-31,780	2,621	35,338	98.1%	0	00.0%	0	14	2
-28	16	-33,702	2,621	35,997	100.0%	0	00.0%	0	6	1
-33	2	-35,623	2,621	35,997	100.0%	0	00.0%	0	1	0
Totals	8767							568	948	391

Table B2-1.78: Annual analysis of heating and cooling loads (in blue and red rectangular boxes on the left side) and traditional HVAC applications covering the heating and cooling loads (in blue and red circular boxes on the right side) for a 2,000 square feet detached house above grade (improved construction type) in the city of Thunder Bay

27. Timmins (North) – Annual Hourly Heating and Cooling Loads Analysis and Coverage

Vertical Ground Source Heat Pump System (V.GSHPs)

Weather		Loads		GeoSmart Energy System					Auxiliary	
Air	Annual Hrs	Space Load	DHW	Geo	WF Air	WF DHW	WF Run	WF KWH	Space	DHW
°F	hours	Btuh/hr	Btuh/hr	°F	Btuh/hr	Btuh/hr	Time	kWh	kWh	kWh
97	1	33,504	2,509	65	33,504	2,497	100.0%	1	0	0
92	8	27,179	2,509	61	27,179	1,698	100.0%	6	0	2
87	34	20,853	2,509	56	20,853	1,074	100.0%	18	0	16
82	92	14,527	2,509	52	14,527	613	100.0%	36	0	56
77	180	8,202	2,509	48	13,413	451	61.2%	39	0	128
72	295	4,406	2,509	45	13,562	386	32.5%	33	0	224
67	422	0	2,509	47	0	0	0.0%	0	0	337
62	544	0	2,509	47	0	0	0.0%	0	0	435
57	618	-1,359	2,509	49	8,515	935	16.0%	63	0	464
52	636	-3,281	2,509	48	8,348	916	39.3%	158	0	435
47	609	-5,202	2,509	47	8,182	898	63.6%	243	0	376
42	583	-7,124	2,509	46	8,682	975	82.1%	319	0	317
37	628	-9,046	2,509	45	10,356	1,223	87.3%	433	0	288
32	660	-10,968	2,509	44	12,027	1,473	91.2%	551	0	245
27	577	-12,890	2,509	43	13,695	1,727	94.1%	567	0	162
22	472	-14,811	2,509	42	15,359	1,984	96.4%	535	0	89
17	411	-16,733	2,509	40	17,021	2,245	98.3%	530	0	40
12	380	-18,655	2,509	39	18,678	2,508	99.9%	551	0	0
7	345	-20,577	2,509	38	20,597	2,511	99.9%	548	0	0
2	301	-22,499	2,509	37	22,519	2,511	99.9%	522	0	0
-3	263	-24,420	2,509	37	24,441	2,511	99.9%	494	0	0
-8	223	-26,342	2,509	36	26,362	2,510	99.9%	452	0	0
-13	167	-28,264	2,509	35	28,284	2,510	99.9%	364	0	0
-18	111	-30,186	2,509	34	30,206	2,510	99.9%	260	0	0
-23	65	-32,107	2,509	33	32,127	2,510	99.9%	162	0	0
-28	36	-34,029	2,509	32	34,049	2,510	99.9%	96	0	0
-33	19	-35,951	2,509	31	35,971	2,510	99.9%	54	0	0
Totals	8680							7036	0	3,614

Table B2-1.79: Annual analysis of heating and cooling loads (in blue and red rectangular boxes on the left side) and vertical ground source heat pump (V.GSHP) unit covering the heating and cooling loads (in blue and red circular boxes on the right side) for a 2,000 square feet detached house above grade (improved construction type) in the city of Timmins

Horizontal Ground Source Heat Pump System (H.GSHPs)

Weather		Loads		GeoSmart Energy System					Auxiliary	
Air	Annual Hrs	Space Load	DHW	Geo	WF Air	WF DHW	WF Run	WF KWH	Space	DHW
°F	hours	Btuh/hr	Btuh/hr	°F	Btuh/hr	Btuh/hr	Time	kWh	kWh	kWh
97	1	33,504	2,509	62	33,504	2,289	100.0%	1	0	0
92	8	27,179	2,509	60	27,179	1,631	100.0%	5	0	2
87	34	20,853	2,509	57	20,853	1,090	100.0%	18	0	15
82	92	14,527	2,509	54	14,527	662	100.0%	37	0	54
77	180	8,202	2,509	51	13,248	522	61.9%	40	0	125
72	295	4,406	2,509	49	13,353	477	33.0%	35	0	221
67	422	0	2,509	47	0	0	0.0%	0	0	337
62	544	0	2,509	47	0	0	0.0%	0	0	435
57	618	-1,359	2,509	45	7,818	858	17.4%	66	0	464
52	636	-3,281	2,509	44	7,703	845	42.6%	165	0	435
47	609	-5,202	2,509	43	7,589	832	68.6%	253	0	376
42	583	-7,124	2,509	43	8,663	993	82.2%	329	0	314
37	628	-9,046	2,509	42	10,335	1,244	87.5%	446	0	284
32	660	-10,968	2,509	41	12,003	1,496	91.4%	567	0	240
27	577	-12,890	2,509	40	13,670	1,751	94.3%	582	0	158
22	472	-14,811	2,509	39	15,334	2,009	96.6%	548	0	85
17	411	-16,733	2,509	39	16,996	2,268	98.5%	541	0	36
12	380	-18,655	2,509	38	18,675	2,511	99.9%	559	0	0
7	345	-20,577	2,509	37	20,597	2,511	99.9%	555	0	0
2	301	-22,499	2,509	37	22,519	2,511	99.9%	527	0	0
-3	263	-24,420	2,509	36	24,440	2,511	99.9%	498	0	0
-8	223	-26,342	2,509	35	26,362	2,510	99.9%	454	0	0
-13	167	-28,264	2,509	35	28,284	2,510	99.9%	365	0	0
-18	111	-30,186	2,509	34	30,206	2,510	99.9%	259	0	0
-23	65	-32,107	2,509	33	32,127	2,510	99.9%	161	0	0
-28	36	-34,029	2,509	33	34,049	2,510	99.9%	95	0	0
-33	19	-35,951	2,509	32	35,971	2,510	99.9%	53	0	0
Totals	8680							7160	0	3,582

Table B2-1.80: Annual analysis of heating and cooling loads (in blue and red rectangular boxes on the left side) and horizontal ground source heat pump (H.GSHP) unit covering the heating and cooling loads (in blue and red circular boxes on the right side) for a 2,000 square feet detached house above grade (improved construction type) in the city of Timmins

Traditional HVAC Applications

Weather		Loads		Fossil Furnace System				Fuel Use		
Air Temp °F	Annual hours	Space Btuh/hr	HW Load Btuh/hr	Furnace Btuh/hr	Furn Run Time	AC Cap Btuh/hr	Clg Run Time	AC kWh	Furnace ccf	HW ccf
97	1	33,504	2,509	0	00.0%	35,865	93.4%	4	0	0
92	8	27,179	2,509	0	00.0%	36,954	73.5%	24	0	0
87	34	20,853	2,509	0	00.0%	38,043	54.8%	78	0	1
82	92	14,527	2,509	0	00.0%	39,132	37.1%	155	0	4
77	180	8,202	2,509	0	00.0%	40,222	20.4%	199	0	8
72	295	4,406	2,509	0	00.0%	41,311	10.7%	225	0	13
67	422	0	2,509	0	00.0%	0	00.0%	0	0	18
62	544	0	2,509	0	00.0%	0	00.0%	0	0	23
57	618	-1,359	2,509	1,778	04.2%	0	00.0%	0	11	26
52	636	-3,281	2,509	3,969	10.1%	0	00.0%	0	25	27
47	609	-5,202	2,509	6,150	16.1%	0	00.0%	0	37	26
42	583	-7,124	2,509	8,322	22.0%	0	00.0%	0	49	25
37	628	-9,046	2,509	10,484	27.9%	0	00.0%	0	66	27
32	660	-10,968	2,509	12,637	33.9%	0	00.0%	0	83	28
27	577	-12,890	2,509	14,780	39.8%	0	00.0%	0	85	25
22	472	-14,811	2,509	16,913	45.7%	0	00.0%	0	80	20
17	411	-16,733	2,509	19,037	51.6%	0	00.0%	0	78	18
12	380	-18,655	2,509	21,152	57.6%	0	00.0%	0	80	16
7	345	-20,577	2,509	23,257	63.5%	0	00.0%	0	80	15
2	301	-22,499	2,509	25,352	69.4%	0	00.0%	0	76	13
-3	263	-24,420	2,509	27,438	75.4%	0	00.0%	0	72	11
-8	223	-26,342	2,509	29,515	81.3%	0	00.0%	0	66	10
-13	167	-28,264	2,509	31,581	87.2%	0	00.0%	0	53	7
-18	111	-30,186	2,509	33,639	93.2%	0	00.0%	0	37	5
-23	65	-32,107	2,509	35,687	99.1%	0	00.0%	0	23	3
-28	36	-34,029	2,509	35,997	100.0%	0	00.0%	0	13	2
-33	19	-35,951	2,509	35,997	100.0%	0	00.0%	0	7	1
Totals	8680							684	1,023	371

Table B2-1.81: Annual analysis of heating and cooling loads (in blue and red rectangular boxes on the left side) and traditional HVAC applications covering the heating and cooling loads (in blue and red circular boxes on the right side) for a 2,000 square feet detached house above grade (improved construction type) in the city of Timmins

Appendix C – Electricity and Natural Gas Rates Forecasting

Table C-1.1 : Ontario Utility Rates (Year 2005 – 2075)					
Year	Electricity Rates		Year	Natural Gas Rates	
	\$/Gigajoule	\$/KWh		\$/Gigajoule	\$/cubic meter
2005	30.72	0.1106	2005	15.27	0.5842
2006	33.90	0.1220	2006	17.65	0.6752
2007	35.96	0.1295	2007	15.89	0.6079
2008	33.61	0.1210	2008	15.33	0.5865
2009	33.19	0.1195	2009	13.30	0.5088
2010	36.49	0.1314	2010	12.85	0.4916
2011	40.54	0.1459	2011	11.41	0.4365
2012	41.57	0.1497	2012	10.80	0.4132
2013	36.83	0.1326	2013	10.23	0.3914
2014	39.77	0.1432	2014	9.86	0.3772
2015	40.58	0.1461	2015	8.35	0.3194
2016	41.69	0.1501	2016	9.04	0.3458
2017 F	42.83	0.1542	2017 F	9.38	0.3588
2018 F	43.97	0.1583	2018 F	9.72	0.3718
2019 F	45.15	0.1625	2019 F	9.87	0.3776
2020 F	46.33	0.1668	2020 F	10.04	0.3841
2021 F	45.04	0.1621	2021 F	10.15	0.3883
2022 F	45.26	0.1629	2022 F	10.27	0.3929
2023 F	45.52	0.1639	2023 F	10.37	0.3967
2024 F	45.78	0.1648	2024 F	10.47	0.4005
2025 F	46.00	0.1656	2025 F	10.56	0.4040
2026 F	46.26	0.1665	2026 F	10.64	0.4070
2027 F	46.51	0.1674	2027 F	10.71	0.4097
2028 F	46.74	0.1683	2028 F	10.78	0.4124
2029 F	46.99	0.1692	2029 F	10.85	0.4151
2030 F	47.25	0.1701	2030 F	10.90	0.4170
2031 F	47.32	0.1704	2031 F	10.95	0.4189
2032 F	47.36	0.1705	2032 F	10.99	0.4204
2033 F	47.43	0.1707	2033 F	11.04	0.4223
2034 F	47.51	0.1710	2034 F	11.10	0.4246
2035 F	47.58	0.1713	2035 F	11.15	0.4265
2036 F	47.62	0.1714	2036 F	11.21	0.4288
2037 F	47.69	0.1717	2037 F	11.27	0.4311
2038 F	47.77	0.1720	2038 F	11.32	0.4331
2039 F	47.84	0.1722	2039 F	11.38	0.4353
2040 F	47.88	0.1724	2040 F	11.44	0.4376
Forecasted at a rate of 0.58% (Year 2041 - 2075)			Forecasted at a rate of 0.99% (Year 2041 - 2075)		
2041 F	48.16	0.1734	2041 F	11.55	0.4420
2042 F	48.44	0.1744	2042 F	11.67	0.4463
2043 F	48.72	0.1754	2043 F	11.78	0.4507
2044 F	49.00	0.1764	2044 F	11.90	0.4552
2045 F	49.28	0.1774	2045 F	12.02	0.4596
2046 F	49.57	0.1784	2046 F	12.13	0.4642
2047 F	49.85	0.1795	2047 F	12.25	0.4688
2048 F	50.14	0.1805	2048 F	12.37	0.4734
2049 F	50.43	0.1816	2049 F	12.50	0.4780
2050 F	50.72	0.1826	2050 F	12.62	0.4828
2051 F	51.02	0.1837	2051 F	12.74	0.4875
2052 F	51.31	0.1847	2052 F	12.87	0.4923
2053 F	51.61	0.1858	2053 F	13.00	0.4972
2054 F	51.91	0.1869	2054 F	13.12	0.5021
2055 F	52.21	0.1879	2055 F	13.25	0.5070
2056 F	52.51	0.1890	2056 F	13.38	0.5120
2057 F	52.81	0.1901	2057 F	13.52	0.5171
2058 F	53.12	0.1912	2058 F	13.65	0.5222
2059 F	53.43	0.1923	2059 F	13.78	0.5273
2060 F	53.73	0.1934	2060 F	13.92	0.5325
2061 F	54.05	0.1946	2061 F	14.06	0.5378
2062 F	54.36	0.1957	2062 F	14.20	0.5431
2063 F	54.67	0.1968	2063 F	14.34	0.5484
2064 F	54.99	0.1980	2064 F	14.48	0.5538
2065 F	55.31	0.1991	2065 F	14.62	0.5593
2066 F	55.63	0.2003	2066 F	14.76	0.5648
2067 F	55.95	0.2014	2067 F	14.91	0.5704
2068 F	56.27	0.2026	2068 F	15.06	0.5760
2069 F	56.60	0.2038	2069 F	15.21	0.5817
2070 F	56.93	0.2049	2070 F	15.35	0.5874
2071 F	57.25	0.2061	2071 F	15.51	0.5932
2072 F	57.59	0.2073	2072 F	15.66	0.5991
2073 F	57.92	0.2085	2073 F	15.81	0.6050
2074 F	58.25	0.2097	2074 F	15.97	0.6109
2075 F	58.59	0.2109	2075 F	16.13	0.6169

Conversion Formula	
Gigajoules (GJ)	Kilowatt-Hour (KWh)
1	277.78
Gigajoules (GJ)	Cubic Meter (m ³)
1	26.14

Compound Annual Growth Rate (Year 2016 – 2040)	
Electricity Rates	Natural Gas Rates
0.58%	0.99%

Source: National Energy Board (NEB)

Link: <https://apps.neb-one.gc.ca/ftppndc/dflt.aspx?GoCTemplateCulture=en-CA>

Appendix D1 – Annual Operating Costs of HVAC Systems in Ontario Cities – Average Construction Type

1. Cambridge (South) – Annual Operating Costs

Vertical Ground Source Heat Pump (V.GSHP)

Base Case Scenario											Feed in Tariff (FIT)		
V.GSHP													
#	Year	Electricity Rates	Heating	Heating Operating Cost	Cooling	Cooling Operating Cost	Hot Water	Hot Water Operating Cost	Total	Total Operating Cost	Incentives (\$/kWh)	FIT	Operating Cost
		\$/kWh	kWh	\$	kWh	\$	kWh	\$	kWh	\$		\$/kWh	\$
1	2016	0.1501	5,378	\$807	235	\$35	4,382	\$658	9,995	\$1,500	0.05	0.1001	\$1,000.33
2	2017	0.1542	5,378	\$829	235	\$36	4,382	\$676	9,995	\$1,541	0.05	0.1042	\$1,041.35
3	2018	0.1583	5,378	\$851	235	\$37	4,382	\$694	9,995	\$1,582	0.05	0.1083	\$1,082.37
4	2019	0.1625	5,378	\$874	235	\$38	4,382	\$712	9,995	\$1,625	0.05	0.1125	\$1,124.82
5	2020	0.1668	5,378	\$897	235	\$39	4,382	\$731	9,995	\$1,667	0.05	0.1168	\$1,167.28
6	2021	0.1621	5,378	\$872	235	\$38	4,382	\$711	9,995	\$1,621	0.05	0.1121	\$1,120.87
7	2022	0.1629	5,378	\$876	235	\$38	4,382	\$714	9,995	\$1,629	0.05	0.1129	\$1,128.78
8	2023	0.1639	5,378	\$881	235	\$39	4,382	\$718	9,995	\$1,638	0.05	0.1139	\$1,138.14
9	2024	0.1648	5,378	\$886	235	\$39	4,382	\$722	9,995	\$1,647	0.05	0.1148	\$1,147.49
10	2025	0.1656	5,378	\$891	235	\$39	4,382	\$726	9,995	\$1,655	0.05	0.1156	\$1,155.41
11	2026	0.1665	5,378	\$896	235	\$39	4,382	\$730	9,995	\$1,665	0.05	0.1165	\$1,164.76
12	2027	0.1674	5,378	\$900	235	\$39	4,382	\$734	9,995	\$1,674	0.05	0.1174	\$1,173.76
13	2028	0.1683	5,378	\$905	235	\$40	4,382	\$737	9,995	\$1,682	0.05	0.1183	\$1,182.04
14	2029	0.1692	5,378	\$910	235	\$40	4,382	\$741	9,995	\$1,691	0.05	0.1192	\$1,191.03
15	2030	0.1701	5,378	\$915	235	\$40	4,382	\$745	9,995	\$1,700	0.05	0.1201	\$1,200.39
16	2031	0.1704	5,378	\$916	235	\$40	4,382	\$746	9,995	\$1,703	0.05	0.1204	\$1,202.90
17	2032	0.1705	5,378	\$917	235	\$40	4,382	\$747	9,995	\$1,704	0.05	0.1205	\$1,204.34
18	2033	0.1707	5,378	\$918	235	\$40	4,382	\$748	9,995	\$1,707	0.05	0.1207	\$1,206.86
19	2034	0.1710	5,378	\$920	235	\$40	4,382	\$749	9,995	\$1,709	0.05	0.1210	\$1,209.74
20	2035	0.1713	5,378	\$921	235	\$40	4,382	\$751	9,995	\$1,712	0.05	0.1213	\$1,212.26
21	2036	0.1714	5,378	\$922	235	\$40	4,382	\$751	9,995	\$1,713	0.05	0.1214	\$1,213.70
22	2037	0.1717	5,378	\$923	235	\$40	4,382	\$752	9,995	\$1,716	0.05	0.1217	\$1,216.22
23	2038	0.1720	5,378	\$925	235	\$40	4,382	\$754	9,995	\$1,719	0.05	0.1220	\$1,219.10
24	2039	0.1722	5,378	\$926	235	\$40	4,382	\$755	9,995	\$1,721	0.05	0.1222	\$1,221.62
25	2040	0.1724	5,378	\$927	235	\$41	4,382	\$755	9,995	\$1,723	0.05	0.1224	\$1,223.05
26	2041	0.1734	5,378	\$932	235	\$41	4,382	\$760	9,995	\$1,733	0.05	0.1234	\$1,233.02
27	2042	0.1744	5,378	\$938	235	\$41	4,382	\$764	9,995	\$1,743	0.05	0.1244	\$1,243.04
28	2043	0.1754	5,378	\$943	235	\$41	4,382	\$768	9,995	\$1,753	0.05	0.1254	\$1,253.15
29	2044	0.1764	5,378	\$949	235	\$41	4,382	\$773	9,995	\$1,763	0.05	0.1264	\$1,263.27
30	2045	0.1774	5,378	\$954	235	\$42	4,382	\$777	9,995	\$1,773	0.05	0.1274	\$1,273.47
31	2046	0.1784	5,378	\$960	235	\$42	4,382	\$782	9,995	\$1,783	0.05	0.1284	\$1,283.72
32	2047	0.1795	5,378	\$965	235	\$42	4,382	\$786	9,995	\$1,794	0.05	0.1295	\$1,294.04
33	2048	0.1805	5,378	\$971	235	\$42	4,382	\$791	9,995	\$1,804	0.05	0.1305	\$1,304.42
34	2049	0.1816	5,378	\$976	235	\$43	4,382	\$796	9,995	\$1,815	0.05	0.1316	\$1,314.85
35	2050	0.1826	5,378	\$982	235	\$43	4,382	\$800	9,995	\$1,825	0.05	0.1326	\$1,325.35
36	2051	0.1837	5,378	\$988	235	\$43	4,382	\$805	9,995	\$1,836	0.05	0.1337	\$1,335.91
37	2052	0.1847	5,378	\$993	235	\$43	4,382	\$809	9,995	\$1,846	0.05	0.1347	\$1,346.53
38	2053	0.1858	5,378	\$999	235	\$44	4,382	\$814	9,995	\$1,857	0.05	0.1358	\$1,357.21
39	2054	0.1869	5,378	\$1,005	235	\$44	4,382	\$819	9,995	\$1,868	0.05	0.1369	\$1,367.95
40	2055	0.1879	5,378	\$1,011	235	\$44	4,382	\$824	9,995	\$1,879	0.05	0.1379	\$1,378.76
41	2056	0.1890	5,378	\$1,017	235	\$44	4,382	\$828	9,995	\$1,889	0.05	0.1390	\$1,389.62
42	2057	0.1901	5,378	\$1,022	235	\$45	4,382	\$833	9,995	\$1,900	0.05	0.1401	\$1,400.55
43	2058	0.1912	5,378	\$1,028	235	\$45	4,382	\$838	9,995	\$1,911	0.05	0.1412	\$1,411.54
44	2059	0.1923	5,378	\$1,034	235	\$45	4,382	\$843	9,995	\$1,922	0.05	0.1423	\$1,422.60
45	2060	0.1934	5,378	\$1,040	235	\$45	4,382	\$848	9,995	\$1,933	0.05	0.1434	\$1,433.72
46	2061	0.1946	5,378	\$1,046	235	\$46	4,382	\$853	9,995	\$1,945	0.05	0.1446	\$1,444.91
47	2062	0.1957	5,378	\$1,052	235	\$46	4,382	\$858	9,995	\$1,956	0.05	0.1457	\$1,456.16
48	2063	0.1968	5,378	\$1,059	235	\$46	4,382	\$862	9,995	\$1,967	0.05	0.1468	\$1,467.47
49	2064	0.1980	5,378	\$1,065	235	\$47	4,382	\$867	9,995	\$1,979	0.05	0.1480	\$1,478.85
50	2065	0.1991	5,378	\$1,071	235	\$47	4,382	\$872	9,995	\$1,990	0.05	0.1491	\$1,490.30
51	2066	0.2003	5,378	\$1,077	235	\$47	4,382	\$878	9,995	\$2,002	0.05	0.1503	\$1,501.81
52	2067	0.2014	5,378	\$1,083	235	\$47	4,382	\$883	9,995	\$2,013	0.05	0.1514	\$1,513.39
53	2068	0.2026	5,378	\$1,089	235	\$48	4,382	\$888	9,995	\$2,025	0.05	0.1526	\$1,525.03
54	2069	0.2038	5,378	\$1,096	235	\$48	4,382	\$893	9,995	\$2,036	0.05	0.1538	\$1,536.75
55	2070	0.2049	5,378	\$1,102	235	\$48	4,382	\$898	9,995	\$2,048	0.05	0.1549	\$1,548.53
56	2071	0.2061	5,378	\$1,108	235	\$48	4,382	\$903	9,995	\$2,060	0.05	0.1561	\$1,560.38
57	2072	0.2073	5,378	\$1,115	235	\$49	4,382	\$908	9,995	\$2,072	0.05	0.1573	\$1,572.29
58	2073	0.2085	5,378	\$1,121	235	\$49	4,382	\$914	9,995	\$2,084	0.05	0.1585	\$1,584.28
59	2074	0.2097	5,378	\$1,128	235	\$49	4,382	\$919	9,995	\$2,096	0.05	0.1597	\$1,596.34
60	2075	0.2109	5,378	\$1,134	235	\$50	4,382	\$924	9,995	\$2,108	0.05	0.1609	\$1,608.46

Table D1-1.1: Annual Operating Costs (V.GSHP) of a 2,000 square feet detached house above grade (average construction type) in the city of Cambridge (two life cycles and three life cycles for a 60 year project lifespan); base case scenario in comparison with feed in-tariff (FIT) scenario. In the FIT scenario, an incentive of \$0.05/KWh is provided on electricity bills throughout the project lifespan

Horizontal Ground Source Heat Pump (H.GSHP)

Base Case Scenario											Feed in Tariff (FIT)		
H.GSHP													
#	Year	Electricity Rates \$/kWh	Heating kWh	Heating Operating Cost \$	Cooling kWh	Cooling Operating Cost \$	Hot Water kWh	Hot Water Operating Cost \$	Total kWh	Total Operating Cost \$	Incentives (\$/kWh)	FIT \$/kWh	Operating Cost
1	2016	0.1501	5,460	\$819	241	\$36	4,363	\$655	10,064	\$1,510	0.05	0.1001	\$1,007.23
2	2017	0.1542	5,460	\$842	241	\$37	4,363	\$673	10,064	\$1,552	0.05	0.1042	\$1,048.54
3	2018	0.1583	5,460	\$864	241	\$38	4,363	\$691	10,064	\$1,593	0.05	0.1083	\$1,089.84
4	2019	0.1625	5,460	\$887	241	\$39	4,363	\$709	10,064	\$1,636	0.05	0.1125	\$1,132.59
5	2020	0.1668	5,460	\$911	241	\$40	4,363	\$728	10,064	\$1,679	0.05	0.1168	\$1,175.34
6	2021	0.1621	5,460	\$885	241	\$39	4,363	\$707	10,064	\$1,632	0.05	0.1121	\$1,128.60
7	2022	0.1629	5,460	\$890	241	\$39	4,363	\$711	10,064	\$1,640	0.05	0.1129	\$1,136.57
8	2023	0.1639	5,460	\$895	241	\$39	4,363	\$715	10,064	\$1,649	0.05	0.1139	\$1,145.99
9	2024	0.1648	5,460	\$900	241	\$40	4,363	\$719	10,064	\$1,659	0.05	0.1148	\$1,155.41
10	2025	0.1656	5,460	\$904	241	\$40	4,363	\$723	10,064	\$1,667	0.05	0.1156	\$1,163.39
11	2026	0.1665	5,460	\$909	241	\$40	4,363	\$727	10,064	\$1,676	0.05	0.1165	\$1,172.80
12	2027	0.1674	5,460	\$914	241	\$40	4,363	\$731	10,064	\$1,685	0.05	0.1174	\$1,181.86
13	2028	0.1683	5,460	\$919	241	\$41	4,363	\$734	10,064	\$1,693	0.05	0.1183	\$1,190.20
14	2029	0.1692	5,460	\$924	241	\$41	4,363	\$738	10,064	\$1,702	0.05	0.1192	\$1,199.25
15	2030	0.1701	5,460	\$929	241	\$41	4,363	\$742	10,064	\$1,712	0.05	0.1201	\$1,208.67
16	2031	0.1704	5,460	\$930	241	\$41	4,363	\$743	10,064	\$1,714	0.05	0.1204	\$1,211.21
17	2032	0.1705	5,460	\$931	241	\$41	4,363	\$744	10,064	\$1,716	0.05	0.1205	\$1,212.66
18	2033	0.1707	5,460	\$932	241	\$41	4,363	\$745	10,064	\$1,718	0.05	0.1207	\$1,215.19
19	2034	0.1710	5,460	\$934	241	\$41	4,363	\$746	10,064	\$1,721	0.05	0.1210	\$1,218.09
20	2035	0.1713	5,460	\$935	241	\$41	4,363	\$747	10,064	\$1,724	0.05	0.1213	\$1,220.63
21	2036	0.1714	5,460	\$936	241	\$41	4,363	\$748	10,064	\$1,725	0.05	0.1214	\$1,222.08
22	2037	0.1717	5,460	\$937	241	\$41	4,363	\$749	10,064	\$1,728	0.05	0.1217	\$1,224.61
23	2038	0.1720	5,460	\$939	241	\$41	4,363	\$750	10,064	\$1,731	0.05	0.1220	\$1,227.51
24	2039	0.1722	5,460	\$940	241	\$42	4,363	\$751	10,064	\$1,733	0.05	0.1222	\$1,230.05
25	2040	0.1724	5,460	\$941	241	\$42	4,363	\$752	10,064	\$1,735	0.05	0.1224	\$1,231.50
26	2041	0.1734	5,460	\$947	241	\$42	4,363	\$756	10,064	\$1,745	0.05	0.1234	\$1,241.53
27	2042	0.1744	5,460	\$952	241	\$42	4,363	\$761	10,064	\$1,755	0.05	0.1244	\$1,251.63
28	2043	0.1754	5,460	\$958	241	\$42	4,363	\$765	10,064	\$1,765	0.05	0.1254	\$1,261.78
29	2044	0.1764	5,460	\$963	241	\$43	4,363	\$770	10,064	\$1,775	0.05	0.1264	\$1,271.99
30	2045	0.1774	5,460	\$969	241	\$43	4,363	\$774	10,064	\$1,785	0.05	0.1274	\$1,282.26
31	2046	0.1784	5,460	\$974	241	\$43	4,363	\$779	10,064	\$1,796	0.05	0.1284	\$1,292.59
32	2047	0.1795	5,460	\$980	241	\$43	4,363	\$783	10,064	\$1,806	0.05	0.1295	\$1,302.97
33	2048	0.1805	5,460	\$986	241	\$44	4,363	\$788	10,064	\$1,817	0.05	0.1305	\$1,313.42
34	2049	0.1816	5,460	\$991	241	\$44	4,363	\$792	10,064	\$1,827	0.05	0.1316	\$1,323.93
35	2050	0.1826	5,460	\$997	241	\$44	4,363	\$797	10,064	\$1,838	0.05	0.1326	\$1,334.50
36	2051	0.1837	5,460	\$1,003	241	\$44	4,363	\$801	10,064	\$1,848	0.05	0.1337	\$1,345.13
37	2052	0.1847	5,460	\$1,009	241	\$45	4,363	\$806	10,064	\$1,859	0.05	0.1347	\$1,355.82
38	2053	0.1858	5,460	\$1,014	241	\$45	4,363	\$811	10,064	\$1,870	0.05	0.1358	\$1,366.58
39	2054	0.1869	5,460	\$1,020	241	\$45	4,363	\$815	10,064	\$1,881	0.05	0.1369	\$1,377.39
40	2055	0.1879	5,460	\$1,026	241	\$45	4,363	\$820	10,064	\$1,891	0.05	0.1379	\$1,388.27
41	2056	0.1890	5,460	\$1,032	241	\$46	4,363	\$825	10,064	\$1,902	0.05	0.1390	\$1,399.22
42	2057	0.1901	5,460	\$1,038	241	\$46	4,363	\$830	10,064	\$1,913	0.05	0.1401	\$1,410.22
43	2058	0.1912	5,460	\$1,044	241	\$46	4,363	\$834	10,064	\$1,924	0.05	0.1412	\$1,421.29
44	2059	0.1923	5,460	\$1,050	241	\$46	4,363	\$839	10,064	\$1,936	0.05	0.1423	\$1,432.42
45	2060	0.1934	5,460	\$1,056	241	\$47	4,363	\$844	10,064	\$1,947	0.05	0.1434	\$1,443.62
46	2061	0.1946	5,460	\$1,062	241	\$47	4,363	\$849	10,064	\$1,958	0.05	0.1446	\$1,454.88
47	2062	0.1957	5,460	\$1,068	241	\$47	4,363	\$854	10,064	\$1,969	0.05	0.1457	\$1,466.21
48	2063	0.1968	5,460	\$1,075	241	\$47	4,363	\$859	10,064	\$1,981	0.05	0.1468	\$1,477.60
49	2064	0.1980	5,460	\$1,081	241	\$48	4,363	\$864	10,064	\$1,992	0.05	0.1480	\$1,489.06
50	2065	0.1991	5,460	\$1,087	241	\$48	4,363	\$869	10,064	\$2,004	0.05	0.1491	\$1,500.59
51	2066	0.2003	5,460	\$1,093	241	\$48	4,363	\$874	10,064	\$2,015	0.05	0.1503	\$1,512.18
52	2067	0.2014	5,460	\$1,100	241	\$49	4,363	\$879	10,064	\$2,027	0.05	0.1514	\$1,523.84
53	2068	0.2026	5,460	\$1,106	241	\$49	4,363	\$884	10,064	\$2,039	0.05	0.1526	\$1,535.56
54	2069	0.2038	5,460	\$1,112	241	\$49	4,363	\$889	10,064	\$2,051	0.05	0.1538	\$1,547.36
55	2070	0.2049	5,460	\$1,119	241	\$49	4,363	\$894	10,064	\$2,062	0.05	0.1549	\$1,559.22
56	2071	0.2061	5,460	\$1,125	241	\$50	4,363	\$899	10,064	\$2,074	0.05	0.1561	\$1,571.15
57	2072	0.2073	5,460	\$1,132	241	\$50	4,363	\$904	10,064	\$2,086	0.05	0.1573	\$1,583.15
58	2073	0.2085	5,460	\$1,138	241	\$50	4,363	\$910	10,064	\$2,098	0.05	0.1585	\$1,595.22
59	2074	0.2097	5,460	\$1,145	241	\$51	4,363	\$915	10,064	\$2,111	0.05	0.1597	\$1,607.36
60	2075	0.2109	5,460	\$1,152	241	\$51	4,363	\$920	10,064	\$2,123	0.05	0.1609	\$1,619.57

Table D1-1.2: Annual Operating Costs (H.GSHP) of a 2,000 square feet detached house above grade (average construction type) in the city of Cambridge (two life cycles and three life cycles for a 60 year project lifespan); base case scenario in comparison with feed in-tariff (FIT) scenario. In the FIT scenario, an incentive of \$0.05/KWh is provided on electricity bills throughout the project lifespan

Traditional HVAC Applications

Base Case Scenario																Carbon Taxes						
#	Year	Traditional														Conversion of m ³ Into Tons	Total Tons	Carbon Tax	Operating Costs			
		Electricity Rates	Natural Gas Rates	Heating		Heating Operating Cost	Heating Operating Cost	Total Heating Operating Cost	Cooling	Cooling Operating Cost	Hot Water	Hot Water Operating Cost	Total	Total	Total Electricity Operating Cost					Total Natural Gas Operating Cost	Total	
		\$/KWh	\$/m ³	KWh (Electricity)	m ³ (Gas)	\$(Electricity)	\$(Gas)	\$	KWh	\$	m ³	\$	KWh	m ³	\$(KWh)					\$(m ³)	\$	
1	2016	0.1501	0.3458	1,348	2,609	\$202	\$902	\$1,105	899	\$135	1,029	\$356	2,247	3,638	337	\$1,258	\$1,595	6.58	6.58	\$10	\$65.85	\$1,661.21
2	2017	0.1542	0.3588	1,348	2,609	\$208	\$936	\$1,144	899	\$139	1,029	\$159	2,247	3,638	346	\$1,305	\$1,652	6.58	6.58	\$20	\$131.70	\$1,783.60
3	2018	0.1583	0.3718	1,348	2,609	\$213	\$970	\$1,184	899	\$142	1,029	\$163	2,247	3,638	356	\$1,353	\$1,708	6.58	6.58	\$30	\$197.54	\$1,905.99
4	2019	0.1625	0.3776	1,348	2,609	\$219	\$985	\$1,204	899	\$146	1,029	\$167	2,247	3,638	365	\$1,374	\$1,739	6.58	6.58	\$40	\$263.39	\$2,002.26
5	2020	0.1668	0.3841	1,348	2,609	\$225	\$1,002	\$1,227	899	\$150	1,029	\$172	2,247	3,638	375	\$1,397	\$1,772	6.58	6.58	\$50	\$329.24	\$2,101.31
6	2021	0.1621	0.3883	1,348	2,609	\$219	\$1,013	\$1,232	899	\$146	1,029	\$167	2,247	3,638	364	\$1,413	\$1,777	6.58	6.58	\$60	\$395.09	\$2,172.03
7	2022	0.1629	0.3929	1,348	2,609	\$220	\$1,025	\$1,245	899	\$146	1,029	\$168	2,247	3,638	366	\$1,429	\$1,795	6.58	6.58	\$70	\$460.93	\$2,256.36
8	2023	0.1639	0.3967	1,348	2,609	\$221	\$1,035	\$1,256	899	\$147	1,029	\$169	2,247	3,638	368	\$1,443	\$1,811	6.58	6.58	\$80	\$526.78	\$2,338.23
9	2024	0.1648	0.4005	1,348	2,609	\$222	\$1,045	\$1,267	899	\$148	1,029	\$170	2,247	3,638	370	\$1,457	\$1,827	6.58	6.58	\$90	\$592.63	\$2,420.10
10	2025	0.1656	0.4040	1,348	2,609	\$223	\$1,054	\$1,277	899	\$149	1,029	\$170	2,247	3,638	372	\$1,470	\$1,842	6.58	6.58	\$100	\$658.48	\$2,500.25
11	2026	0.1665	0.4070	1,348	2,609	\$224	\$1,062	\$1,286	899	\$150	1,029	\$171	2,247	3,638	374	\$1,481	\$1,855	6.58	6.58	\$110	\$724.33	\$2,579.34
12	2027	0.1674	0.4097	1,348	2,609	\$226	\$1,069	\$1,295	899	\$151	1,029	\$172	2,247	3,638	376	\$1,491	\$1,867	6.58	6.58	\$120	\$790.17	\$2,656.95
13	2028	0.1683	0.4124	1,348	2,609	\$227	\$1,076	\$1,303	899	\$151	1,029	\$173	2,247	3,638	378	\$1,500	\$1,878	6.58	6.58	\$130	\$856.02	\$2,734.40
14	2029	0.1692	0.4151	1,348	2,609	\$228	\$1,083	\$1,311	899	\$152	1,029	\$174	2,247	3,638	380	\$1,510	\$1,890	6.58	6.58	\$140	\$921.87	\$2,812.01
15	2030	0.1701	0.4170	1,348	2,609	\$229	\$1,088	\$1,317	899	\$153	1,029	\$175	2,247	3,638	382	\$1,517	\$1,899	6.58	6.58	\$150	\$987.72	\$2,886.92
16	2031	0.1704	0.4189	1,348	2,609	\$230	\$1,093	\$1,323	899	\$153	1,029	\$175	2,247	3,638	383	\$1,524	\$1,907	6.58	6.58	\$160	\$1,053.56	\$2,960.29
17	2032	0.1705	0.4204	1,348	2,609	\$230	\$1,097	\$1,327	899	\$153	1,029	\$175	2,247	3,638	383	\$1,530	\$1,913	6.58	6.58	\$170	\$1,119.41	\$3,032.03
18	2033	0.1707	0.4223	1,348	2,609	\$230	\$1,102	\$1,332	899	\$154	1,029	\$176	2,247	3,638	384	\$1,536	\$1,920	6.58	6.58	\$180	\$1,185.26	\$3,105.41
19	2034	0.1710	0.4246	1,348	2,609	\$231	\$1,108	\$1,338	899	\$154	1,029	\$176	2,247	3,638	384	\$1,543	\$1,928	6.58	6.58	\$190	\$1,251.11	\$3,180.75
20	2035	0.1713	0.4265	1,348	2,609	\$231	\$1,113	\$1,344	899	\$154	1,029	\$176	2,247	3,638	385	\$1,552	\$1,937	6.58	6.58	\$200	\$1,316.96	\$3,254.62
21	2036	0.1714	0.4288	1,348	2,609	\$231	\$1,119	\$1,350	899	\$154	1,029	\$177	2,247	3,638	385	\$1,560	\$1,945	6.58	6.58	\$210	\$1,382.80	\$3,328.15
22	2037	0.1717	0.4311	1,348	2,609	\$231	\$1,125	\$1,356	899	\$154	1,029	\$177	2,247	3,638	386	\$1,568	\$1,954	6.58	6.58	\$220	\$1,448.65	\$3,402.91
23	2038	0.1720	0.4331	1,348	2,609	\$232	\$1,130	\$1,362	899	\$155	1,029	\$177	2,247	3,638	386	\$1,575	\$1,962	6.58	6.58	\$230	\$1,514.50	\$3,476.36
24	2039	0.1722	0.4353	1,348	2,609	\$232	\$1,136	\$1,368	899	\$155	1,029	\$177	2,247	3,638	387	\$1,584	\$1,971	6.58	6.58	\$240	\$1,580.35	\$3,551.13
25	2040	0.1724	0.4376	1,348	2,609	\$232	\$1,142	\$1,374	899	\$155	1,029	\$177	2,247	3,638	387	\$1,592	\$1,979	6.58	6.58	\$250	\$1,646.20	\$3,625.65
26	2041	0.1734	0.4420	1,348	2,609	\$234	\$1,153	\$1,387	899	\$156	1,029	\$178	2,247	3,638	390	\$1,608	\$1,997	6.58	6.58	\$260	\$1,712.04	\$3,709.43
27	2042	0.1744	0.4463	1,348	2,609	\$235	\$1,164	\$1,399	899	\$157	1,029	\$179	2,247	3,638	392	\$1,624	\$2,015	6.58	6.58	\$270	\$1,777.89	\$3,793.39
28	2043	0.1754	0.4507	1,348	2,609	\$236	\$1,176	\$1,412	899	\$158	1,029	\$180	2,247	3,638	394	\$1,640	\$2,034	6.58	6.58	\$280	\$1,843.74	\$3,877.51
29	2044	0.1764	0.4552	1,348	2,609	\$238	\$1,188	\$1,425	899	\$159	1,029	\$182	2,247	3,638	396	\$1,656	\$2,052	6.58	6.58	\$290	\$1,909.59	\$3,961.80
30	2045	0.1774	0.4606	1,348	2,609	\$239	\$1,199	\$1,438	899	\$159	1,029	\$183	2,247	3,638	399	\$1,672	\$2,071	6.58	6.58	\$300	\$1,975.44	\$4,046.17
31	2046	0.1784	0.4642	1,348	2,609	\$241	\$1,211	\$1,452	899	\$160	1,029	\$184	2,247	3,638	401	\$1,689	\$2,090	6.58	6.58	\$310	\$2,041.28	\$4,130.91
32	2047	0.1795	0.4688	1,348	2,609	\$242	\$1,223	\$1,465	899	\$161	1,029	\$185	2,247	3,638	403	\$1,705	\$2,109	6.58	6.58	\$320	\$2,107.13	\$4,215.73
33	2048	0.1805	0.4734	1,348	2,609	\$243	\$1,235	\$1,478	899	\$162	1,029	\$186	2,247	3,638	406	\$1,722	\$2,128	6.58	6.58	\$330	\$2,172.98	\$4,300.72
34	2049	0.1816	0.4780	1,348	2,609	\$245	\$1,247	\$1,492	899	\$163	1,029	\$187	2,247	3,638	408	\$1,739	\$2,147	6.58	6.58	\$340	\$2,238.83	\$4,385.89
35	2050	0.1826	0.4828	1,348	2,609	\$246	\$1,260	\$1,506	899	\$164	1,029	\$188	2,247	3,638	410	\$1,756	\$2,167	6.58	6.58	\$350	\$2,304.67	\$4,471.25
36	2051	0.1837	0.4875	1,348	2,609	\$248	\$1,272	\$1,519	899	\$165	1,029	\$189	2,247	3,638	413	\$1,774	\$2,186	6.58	6.58	\$360	\$2,370.52	\$4,556.78
37	2052	0.1847	0.4923	1,348	2,609	\$249	\$1,284	\$1,533	899	\$166	1,029	\$190	2,247	3,638	415	\$1,791	\$2,206	6.58	6.58	\$370	\$2,436.37	\$4,642.50
38	2053	0.1858	0.4972	1,348	2,609	\$250	\$1,297	\$1,548	899	\$167	1,029	\$191	2,247	3,638	417	\$1,809	\$2,226	6.58	6.58	\$380	\$2,502.22	\$4,728.41
39	2054	0.1869	0.5021	1,348	2,609	\$252	\$1,310	\$1,562	899	\$168	1,029	\$192	2,247	3,638	420	\$1,827	\$2,246	6.58	6.58	\$390	\$2,568.06	\$4,814.50
40	2055	0.1879	0.5070	1,348	2,609	\$253	\$1,323	\$1,576	899	\$169	1,029	\$193	2,247	3,638	422	\$1,845	\$2,267	6.58	6.58	\$400	\$2,633.91	\$4,900.75
41	2056	0.1890	0.5120	1,348	2,609	\$255	\$1,336	\$1,591	899	\$170	1,029	\$195	2,247	3,638	425	\$1,863	\$2,288	6.58	6.58	\$410	\$2,699.76	\$4,987.27
42	2057	0.1901	0.5171	1,348	2,609	\$256	\$1,349	\$1,605	899	\$171	1,029	\$196	2,247	3,638	427	\$1,881	\$2,308	6.58	6.58	\$420	\$2,765.61	\$5,073.94
43	2058	0.1912	0.5222	1,348	2,609	\$258	\$1,362	\$1,620	899	\$172	1,029	\$197	2,247	3,638	430	\$1,900	\$2,329	6.58	6.58	\$430	\$2,831.46	\$5,160.80
44	2059	0.1923	0.5273	1,348	2,609	\$259	\$1,376	\$1,635	899	\$173	1,029	\$198	2,247	3,638	432	\$1,918	\$2,351	6.58	6.58	\$440	\$2,897.30	\$5,247.86
45	2060	0.1934	0.5325	1,348	2,609	\$261	\$1,389	\$1,650	899	\$174	1,029	\$199	2,247	3,638	435	\$1,937	\$2,372	6.58	6.58	\$450	\$2,963.15	\$5,335.12
46	2061	0.1946	0.5378	1,348	2,609	\$262	\$1,403	\$1,665	899	\$175	1,029	\$200	2,247	3,638	437	\$1,956	\$2,394	6.58	6.58	\$460	\$3,029.00	\$5,422.59
47	2062	0.1957	0.5431	1,348	2,609	\$264	\$1,417	\$1,681	899	\$176	1,029	\$201	2,247	3,638	440	\$1,976	\$2,415	6.58	6.58	\$470	\$3,094.85	\$5,510.25
48	2063	0.1968	0.5484	1,348	2,609	\$265	\$1,431	\$1,696	899	\$177	1,029	\$203	2,247	3,638	442	\$1,995	\$2,437	6.58	6.58	\$480	\$3,160.69	\$5,598.12
49	2064	0.1980	0.5538	1,348	2,609	\$267	\$1,445	\$1,712	899	\$178	1,029	\$204	2,247	3,638	445	\$2,015	\$2,460	6.58	6.58	\$490	\$3,226.54	\$5,686.20
50	2065	0.1991	0.5593	1,348	2,609	\$268	\$1,459	\$1,728	899	\$179	1,029	\$205	2,247	3,638	447	\$2,035	\$2,482	6.58	6.58	\$500	\$3,292.39	\$5,774.48
51	2066	0.2003	0.5648	1,348	2,609	\$270	\$1,474	\$1,744	899	\$180	1,029	\$206	2,247	3,638	450	\$2,055	\$2,505	6.58	6.58	\$510	\$3,358.24	\$5,862.98
52	2067	0.2014	0.5704	1,348	2,609	\$272	\$1,488	\$1,760	899	\$181	1,029	\$207	2,247	3,638	453	\$2,075	\$2,528	6.58	6.58	\$520	\$3,424.09	\$5,951.69
53	2068	0.2026	0.5760	1,348	2,609	\$273	\$1,503	\$1,776	899	\$182	1,029	\$208	2,247	3,638	455	\$2,095	\$2,551	6.58	6.58	\$530	\$3,489.93	\$6,040.61
54																						

2. Chatham (South) – Annual Operating Costs

Vertical Ground Source Heat Pump (V.GSHP)

Base Case Scenario												Feed in Tariff (FIT)		
#	Year	Electricity Rates		Heating		Cooling		Hot Water		Total	Total Operating Cost	FIT		
		\$/KWh	KWh	\$	KWh	\$	KWh	\$	KWh			\$	Incentives (\$/KWh)	Operating Cost
1	2016	0.1501	4,504	\$676	447	\$67	4,349	\$653	9,300	\$1,396	0.05	0.1001	\$930.77	
2	2017	0.1542	4,504	\$694	447	\$69	4,349	\$671	9,300	\$1,434	0.05	0.1042	\$968.94	
3	2018	0.1583	4,504	\$713	447	\$71	4,349	\$688	9,300	\$1,472	0.05	0.1083	\$1,007.10	
4	2019	0.1623	4,504	\$732	447	\$73	4,349	\$707	9,300	\$1,512	0.05	0.1123	\$1,046.61	
5	2020	0.1668	4,504	\$751	447	\$75	4,349	\$725	9,300	\$1,551	0.05	0.1168	\$1,086.12	
6	2021	0.1621	4,504	\$730	447	\$72	4,349	\$705	9,300	\$1,508	0.05	0.1121	\$1,042.93	
7	2022	0.1629	4,504	\$734	447	\$73	4,349	\$709	9,300	\$1,515	0.05	0.1129	\$1,050.29	
8	2023	0.1639	4,504	\$738	447	\$73	4,349	\$713	9,300	\$1,524	0.05	0.1139	\$1,059.00	
9	2024	0.1648	4,504	\$742	447	\$74	4,349	\$717	9,300	\$1,533	0.05	0.1148	\$1,067.70	
10	2025	0.1656	4,504	\$746	447	\$74	4,349	\$720	9,300	\$1,540	0.05	0.1156	\$1,075.07	
11	2026	0.1665	4,504	\$750	447	\$74	4,349	\$724	9,300	\$1,549	0.05	0.1165	\$1,083.77	
12	2027	0.1674	4,504	\$754	447	\$75	4,349	\$728	9,300	\$1,557	0.05	0.1174	\$1,092.14	
13	2028	0.1683	4,504	\$758	447	\$75	4,349	\$732	9,300	\$1,565	0.05	0.1183	\$1,099.84	
14	2029	0.1692	4,504	\$762	447	\$76	4,349	\$736	9,300	\$1,573	0.05	0.1192	\$1,108.21	
15	2030	0.1701	4,504	\$766	447	\$76	4,349	\$740	9,300	\$1,582	0.05	0.1201	\$1,116.92	
16	2031	0.1704	4,504	\$767	447	\$76	4,349	\$741	9,300	\$1,584	0.05	0.1204	\$1,119.26	
17	2032	0.1705	4,504	\$768	447	\$76	4,349	\$741	9,300	\$1,586	0.05	0.1205	\$1,120.60	
18	2033	0.1707	4,504	\$769	447	\$76	4,349	\$743	9,300	\$1,588	0.05	0.1207	\$1,122.94	
19	2034	0.1710	4,504	\$770	447	\$76	4,349	\$744	9,300	\$1,591	0.05	0.1210	\$1,125.62	
20	2035	0.1713	4,504	\$771	447	\$77	4,349	\$745	9,300	\$1,593	0.05	0.1213	\$1,127.97	
21	2036	0.1714	4,504	\$772	447	\$77	4,349	\$746	9,300	\$1,594	0.05	0.1214	\$1,129.30	
22	2037	0.1717	4,504	\$773	447	\$77	4,349	\$747	9,300	\$1,597	0.05	0.1217	\$1,131.65	
23	2038	0.1720	4,504	\$775	447	\$77	4,349	\$748	9,300	\$1,599	0.05	0.1220	\$1,134.33	
24	2039	0.1722	4,504	\$776	447	\$77	4,349	\$749	9,300	\$1,602	0.05	0.1222	\$1,136.67	
25	2040	0.1724	4,504	\$776	447	\$77	4,349	\$750	9,300	\$1,603	0.05	0.1224	\$1,138.01	
26	2041	0.1734	4,504	\$781	447	\$78	4,349	\$754	9,300	\$1,612	0.05	0.1234	\$1,147.28	
27	2042	0.1744	4,504	\$785	447	\$78	4,349	\$758	9,300	\$1,622	0.05	0.1244	\$1,156.61	
28	2043	0.1754	4,504	\$790	447	\$78	4,349	\$763	9,300	\$1,631	0.05	0.1254	\$1,165.99	
29	2044	0.1764	4,504	\$794	447	\$79	4,349	\$767	9,300	\$1,640	0.05	0.1264	\$1,175.43	
30	2045	0.1774	4,504	\$799	447	\$79	4,349	\$772	9,300	\$1,650	0.05	0.1274	\$1,184.92	
31	2046	0.1784	4,504	\$804	447	\$80	4,349	\$776	9,300	\$1,659	0.05	0.1284	\$1,194.46	
32	2047	0.1795	4,504	\$808	447	\$80	4,349	\$781	9,300	\$1,669	0.05	0.1295	\$1,204.06	
33	2048	0.1805	4,504	\$813	447	\$81	4,349	\$785	9,300	\$1,679	0.05	0.1305	\$1,213.71	
34	2049	0.1816	4,504	\$818	447	\$81	4,349	\$790	9,300	\$1,688	0.05	0.1316	\$1,223.43	
35	2050	0.1826	4,504	\$822	447	\$82	4,349	\$794	9,300	\$1,698	0.05	0.1326	\$1,233.19	
36	2051	0.1837	4,504	\$827	447	\$82	4,349	\$799	9,300	\$1,708	0.05	0.1337	\$1,243.02	
37	2052	0.1847	4,504	\$832	447	\$83	4,349	\$803	9,300	\$1,718	0.05	0.1347	\$1,252.90	
38	2053	0.1858	4,504	\$837	447	\$83	4,349	\$808	9,300	\$1,728	0.05	0.1358	\$1,262.84	
39	2054	0.1869	4,504	\$842	447	\$84	4,349	\$813	9,300	\$1,738	0.05	0.1369	\$1,272.83	
40	2055	0.1879	4,504	\$847	447	\$84	4,349	\$817	9,300	\$1,748	0.05	0.1379	\$1,282.88	
41	2056	0.1890	4,504	\$851	447	\$84	4,349	\$822	9,300	\$1,758	0.05	0.1390	\$1,292.99	
42	2057	0.1901	4,504	\$856	447	\$85	4,349	\$827	9,300	\$1,768	0.05	0.1401	\$1,303.16	
43	2058	0.1912	4,504	\$861	447	\$85	4,349	\$832	9,300	\$1,778	0.05	0.1412	\$1,313.39	
44	2059	0.1923	4,504	\$866	447	\$86	4,349	\$836	9,300	\$1,789	0.05	0.1423	\$1,323.68	
45	2060	0.1934	4,504	\$871	447	\$86	4,349	\$841	9,300	\$1,799	0.05	0.1434	\$1,334.03	
46	2061	0.1946	4,504	\$876	447	\$87	4,349	\$846	9,300	\$1,809	0.05	0.1446	\$1,344.44	
47	2062	0.1957	4,504	\$881	447	\$87	4,349	\$851	9,300	\$1,820	0.05	0.1457	\$1,354.90	
48	2063	0.1968	4,504	\$886	447	\$88	4,349	\$856	9,300	\$1,830	0.05	0.1468	\$1,365.43	
49	2064	0.1980	4,504	\$892	447	\$88	4,349	\$861	9,300	\$1,841	0.05	0.1480	\$1,376.02	
50	2065	0.1991	4,504	\$897	447	\$89	4,349	\$866	9,300	\$1,852	0.05	0.1491	\$1,386.67	
51	2066	0.2003	4,504	\$902	447	\$90	4,349	\$871	9,300	\$1,862	0.05	0.1503	\$1,397.38	
52	2067	0.2014	4,504	\$907	447	\$90	4,349	\$876	9,300	\$1,873	0.05	0.1514	\$1,408.15	
53	2068	0.2026	4,504	\$912	447	\$91	4,349	\$881	9,300	\$1,884	0.05	0.1526	\$1,418.99	
54	2069	0.2038	4,504	\$918	447	\$91	4,349	\$886	9,300	\$1,895	0.05	0.1538	\$1,429.89	
55	2070	0.2049	4,504	\$923	447	\$92	4,349	\$891	9,300	\$1,906	0.05	0.1549	\$1,440.85	
56	2071	0.2061	4,504	\$928	447	\$92	4,349	\$896	9,300	\$1,917	0.05	0.1561	\$1,451.88	
57	2072	0.2073	4,504	\$934	447	\$93	4,349	\$902	9,300	\$1,928	0.05	0.1573	\$1,462.96	
58	2073	0.2085	4,504	\$939	447	\$93	4,349	\$907	9,300	\$1,939	0.05	0.1585	\$1,474.12	
59	2074	0.2097	4,504	\$945	447	\$94	4,349	\$912	9,300	\$1,950	0.05	0.1597	\$1,485.34	
60	2075	0.2109	4,504	\$950	447	\$94	4,349	\$917	9,300	\$1,962	0.05	0.1609	\$1,496.62	

Table D1-1.4: Annual Operating Costs (V.GSHP) of a 2,000 square feet detached house above grade (average construction type) in the city of Chatham (two life cycles and three life cycles for a 60 year project lifespan); base case scenario in comparison with feed in-tariff (FIT) scenario. In the FIT scenario, an incentive of \$0.05/KWh is provided on electricity bills throughout the project lifespan

Horizontal Ground Source Heat Pump (H.GSHP)

Base Case Scenario												Feed in Tariff (FIT)		
H.GSHP												FIT		
#	Year	Electricity Rates	Heating	Heating Operating Cost	Cooling	Cooling Operating Cost	Hot Water	Hot Water Operating Cost	Total	Total Operating Cost	Incentives (\$/KWh)	Operating Cost	Operating Cost	
		\$/KWh	KWh	\$	KWh	\$	KWh	\$	KWh	\$		\$/KWh		
1	2016	0.1501	4,582	\$688	458	\$69	4,323	\$649	9,363	\$1,405	0.05	0.1001	\$937.08	
2	2017	0.1542	4,582	\$706	458	\$71	4,323	\$667	9,363	\$1,444	0.05	0.1042	\$975.50	
3	2018	0.1583	4,582	\$725	458	\$72	4,323	\$684	9,363	\$1,482	0.05	0.1083	\$1,013.93	
4	2019	0.1625	4,582	\$745	458	\$74	4,323	\$703	9,363	\$1,522	0.05	0.1125	\$1,053.70	
5	2020	0.1668	4,582	\$764	458	\$76	4,323	\$721	9,363	\$1,562	0.05	0.1168	\$1,093.47	
6	2021	0.1621	4,582	\$743	458	\$74	4,323	\$701	9,363	\$1,518	0.05	0.1121	\$1,049.99	
7	2022	0.1629	4,582	\$747	458	\$75	4,323	\$704	9,363	\$1,526	0.05	0.1129	\$1,057.41	
8	2023	0.1639	4,582	\$751	458	\$75	4,323	\$708	9,363	\$1,534	0.05	0.1139	\$1,066.17	
9	2024	0.1648	4,582	\$755	458	\$75	4,323	\$712	9,363	\$1,543	0.05	0.1148	\$1,074.93	
10	2025	0.1656	4,582	\$759	458	\$76	4,323	\$716	9,363	\$1,551	0.05	0.1156	\$1,082.35	
11	2026	0.1665	4,582	\$763	458	\$76	4,323	\$720	9,363	\$1,559	0.05	0.1165	\$1,091.11	
12	2027	0.1674	4,582	\$767	458	\$77	4,323	\$724	9,363	\$1,568	0.05	0.1174	\$1,099.54	
13	2028	0.1683	4,582	\$771	458	\$77	4,323	\$727	9,363	\$1,575	0.05	0.1183	\$1,107.99	
14	2029	0.1692	4,582	\$775	458	\$77	4,323	\$731	9,363	\$1,584	0.05	0.1192	\$1,115.72	
15	2030	0.1701	4,582	\$779	458	\$78	4,323	\$735	9,363	\$1,593	0.05	0.1201	\$1,124.48	
16	2031	0.1704	4,582	\$781	458	\$78	4,323	\$736	9,363	\$1,595	0.05	0.1204	\$1,126.84	
17	2032	0.1705	4,582	\$781	458	\$78	4,323	\$737	9,363	\$1,596	0.05	0.1205	\$1,128.19	
18	2033	0.1707	4,582	\$782	458	\$78	4,323	\$738	9,363	\$1,599	0.05	0.1207	\$1,130.55	
19	2034	0.1710	4,582	\$784	458	\$78	4,323	\$739	9,363	\$1,601	0.05	0.1210	\$1,133.25	
20	2035	0.1713	4,582	\$785	458	\$78	4,323	\$740	9,363	\$1,604	0.05	0.1213	\$1,135.61	
21	2036	0.1714	4,582	\$785	458	\$79	4,323	\$741	9,363	\$1,605	0.05	0.1214	\$1,136.95	
22	2037	0.1717	4,582	\$787	458	\$79	4,323	\$742	9,363	\$1,607	0.05	0.1217	\$1,139.31	
23	2038	0.1720	4,582	\$788	458	\$79	4,323	\$743	9,363	\$1,610	0.05	0.1220	\$1,142.01	
24	2039	0.1722	4,582	\$789	458	\$79	4,323	\$745	9,363	\$1,613	0.05	0.1222	\$1,144.37	
25	2040	0.1724	4,582	\$790	458	\$79	4,323	\$745	9,363	\$1,614	0.05	0.1224	\$1,145.72	
26	2041	0.1734	4,582	\$794	458	\$79	4,323	\$749	9,363	\$1,623	0.05	0.1234	\$1,155.05	
27	2042	0.1744	4,582	\$799	458	\$80	4,323	\$754	9,363	\$1,633	0.05	0.1244	\$1,164.44	
28	2043	0.1754	4,582	\$804	458	\$80	4,323	\$758	9,363	\$1,642	0.05	0.1254	\$1,173.89	
29	2044	0.1764	4,582	\$808	458	\$81	4,323	\$763	9,363	\$1,652	0.05	0.1264	\$1,183.39	
30	2045	0.1774	4,582	\$813	458	\$81	4,323	\$767	9,363	\$1,661	0.05	0.1274	\$1,192.94	
31	2046	0.1784	4,582	\$818	458	\$82	4,323	\$771	9,363	\$1,671	0.05	0.1284	\$1,202.55	
32	2047	0.1795	4,582	\$822	458	\$82	4,323	\$776	9,363	\$1,680	0.05	0.1295	\$1,212.22	
33	2048	0.1805	4,582	\$827	458	\$83	4,323	\$780	9,363	\$1,690	0.05	0.1305	\$1,221.94	
34	2049	0.1816	4,582	\$832	458	\$83	4,323	\$785	9,363	\$1,700	0.05	0.1316	\$1,231.71	
35	2050	0.1826	4,582	\$837	458	\$84	4,323	\$789	9,363	\$1,710	0.05	0.1326	\$1,241.55	
36	2051	0.1837	4,582	\$842	458	\$84	4,323	\$794	9,363	\$1,720	0.05	0.1337	\$1,251.44	
37	2052	0.1847	4,582	\$846	458	\$85	4,323	\$799	9,363	\$1,730	0.05	0.1347	\$1,261.38	
38	2053	0.1858	4,582	\$851	458	\$85	4,323	\$803	9,363	\$1,740	0.05	0.1358	\$1,271.39	
39	2054	0.1869	4,582	\$856	458	\$86	4,323	\$808	9,363	\$1,750	0.05	0.1369	\$1,281.45	
40	2055	0.1879	4,582	\$861	458	\$86	4,323	\$812	9,363	\$1,760	0.05	0.1379	\$1,291.57	
41	2056	0.1890	4,582	\$866	458	\$87	4,323	\$817	9,363	\$1,770	0.05	0.1390	\$1,301.75	
42	2057	0.1901	4,582	\$871	458	\$87	4,323	\$822	9,363	\$1,780	0.05	0.1401	\$1,311.99	
43	2058	0.1912	4,582	\$876	458	\$88	4,323	\$827	9,363	\$1,790	0.05	0.1412	\$1,322.29	
44	2059	0.1923	4,582	\$881	458	\$88	4,323	\$831	9,363	\$1,801	0.05	0.1423	\$1,332.65	
45	2060	0.1934	4,582	\$886	458	\$89	4,323	\$836	9,363	\$1,811	0.05	0.1434	\$1,343.07	
46	2061	0.1946	4,582	\$891	458	\$89	4,323	\$841	9,363	\$1,822	0.05	0.1446	\$1,353.54	
47	2062	0.1957	4,582	\$897	458	\$90	4,323	\$846	9,363	\$1,832	0.05	0.1457	\$1,364.08	
48	2063	0.1968	4,582	\$902	458	\$90	4,323	\$851	9,363	\$1,843	0.05	0.1468	\$1,374.68	
49	2064	0.1980	4,582	\$907	458	\$91	4,323	\$856	9,363	\$1,853	0.05	0.1480	\$1,385.34	
50	2065	0.1991	4,582	\$912	458	\$91	4,323	\$861	9,363	\$1,864	0.05	0.1491	\$1,396.06	
51	2066	0.2003	4,582	\$918	458	\$92	4,323	\$866	9,363	\$1,875	0.05	0.1503	\$1,406.85	
52	2067	0.2014	4,582	\$923	458	\$92	4,323	\$871	9,363	\$1,886	0.05	0.1514	\$1,417.69	
53	2068	0.2026	4,582	\$928	458	\$93	4,323	\$876	9,363	\$1,897	0.05	0.1526	\$1,428.60	
54	2069	0.2038	4,582	\$934	458	\$93	4,323	\$881	9,363	\$1,908	0.05	0.1538	\$1,439.58	
55	2070	0.2049	4,582	\$939	458	\$94	4,323	\$886	9,363	\$1,919	0.05	0.1549	\$1,450.61	
56	2071	0.2061	4,582	\$944	458	\$94	4,323	\$891	9,363	\$1,930	0.05	0.1561	\$1,461.71	
57	2072	0.2073	4,582	\$950	458	\$95	4,323	\$896	9,363	\$1,941	0.05	0.1573	\$1,472.88	
58	2073	0.2085	4,582	\$955	458	\$95	4,323	\$901	9,363	\$1,952	0.05	0.1585	\$1,484.10	
59	2074	0.2097	4,582	\$961	458	\$96	4,323	\$907	9,363	\$1,964	0.05	0.1597	\$1,495.40	
60	2075	0.2109	4,582	\$966	458	\$97	4,323	\$912	9,363	\$1,975	0.05	0.1609	\$1,506.76	

Table D1-1.5: Annual Operating Costs (H.GSHP) of a 2,000 square feet detached house above grade (average construction type) in the city of Chatham (two life cycles and three life cycles for a 60 year project lifespan); base case scenario in comparison with feed in-tariff (FIT) scenario. In the FIT scenario, an incentive of \$0.05/KWh is provided on electricity bills throughout the project lifespan

Traditional HVAC Applications

Base Case Scenario															Carbon Taxes							
#	Year	Electricity Rates \$/KWh	Natural Gas Rates \$/m ³	Traditional											Total	Conversion of m ³ into Tons	Total Tons	Carbon Tax	Operating Costs			
				Heating		Heating Operating Cost \$ (Electricity)	Heating Operating Cost \$ (Gas)	Total Heating Operating Cost \$	Cooling KWh	Cooling Operating Cost \$	Hot Water m ³	Hot Water Operating Cost \$	Total KWh	Total m ³						Total Electricity Operating Cost \$ (KWh)	Total Natural Gas Operating Cost \$ (m ³)	
				KWh (Electricity)	m ³ (Gas)																	
1	2016	0.1501	0.3458	1,523	2,235	\$229	\$773	\$1,002	1,919	\$288	1,003	\$347	3,442	3,238	517	\$1,120	\$1,636	5.86	5.86	\$10	\$58.61	\$1,694.99
2	2017	0.1542	0.3588	1,523	2,235	\$235	\$802	\$1,037	1,919	\$296	1,003	\$347	3,442	3,238	531	\$1,162	\$1,693	5.86	5.86	\$20	\$117.22	\$1,809.84
3	2018	0.1583	0.3718	1,523	2,235	\$241	\$831	\$1,072	1,919	\$304	1,003	\$347	3,442	3,238	545	\$1,204	\$1,749	5.86	5.86	\$30	\$175.82	\$1,924.69
4	2019	0.1625	0.3776	1,523	2,235	\$248	\$844	\$1,091	1,919	\$312	1,003	\$347	3,442	3,238	559	\$1,223	\$1,782	5.86	5.86	\$40	\$234.43	\$2,016.50
5	2020	0.1668	0.3841	1,523	2,235	\$254	\$858	\$1,112	1,919	\$320	1,003	\$347	3,442	3,238	574	\$1,244	\$1,818	5.86	5.86	\$50	\$293.04	\$2,110.79
6	2021	0.1621	0.3883	1,523	2,235	\$247	\$868	\$1,115	1,919	\$311	1,003	\$347	3,442	3,238	558	\$1,257	\$1,815	5.86	5.86	\$60	\$351.65	\$2,167.04
7	2022	0.1629	0.3929	1,523	2,235	\$248	\$878	\$1,126	1,919	\$313	1,003	\$347	3,442	3,238	561	\$1,272	\$1,833	5.86	5.86	\$70	\$410.25	\$2,243.24
8	2023	0.1639	0.3967	1,523	2,235	\$250	\$887	\$1,136	1,919	\$314	1,003	\$347	3,442	3,238	564	\$1,285	\$1,849	5.86	5.86	\$80	\$468.86	\$2,317.45
9	2024	0.1648	0.4005	1,523	2,235	\$251	\$895	\$1,146	1,919	\$316	1,003	\$347	3,442	3,238	567	\$1,297	\$1,864	5.86	5.86	\$90	\$527.47	\$2,391.67
10	2025	0.1656	0.4040	1,523	2,235	\$252	\$903	\$1,155	1,919	\$318	1,003	\$347	3,442	3,238	570	\$1,308	\$1,878	5.86	5.86	\$100	\$586.08	\$2,464.15
11	2026	0.1665	0.4070	1,523	2,235	\$254	\$910	\$1,163	1,919	\$320	1,003	\$347	3,442	3,238	573	\$1,318	\$1,891	5.86	5.86	\$110	\$644.69	\$2,535.89
12	2027	0.1674	0.4097	1,523	2,235	\$255	\$916	\$1,171	1,919	\$321	1,003	\$347	3,442	3,238	576	\$1,327	\$1,903	5.86	5.86	\$120	\$703.29	\$2,606.27
13	2028	0.1683	0.4124	1,523	2,235	\$256	\$922	\$1,178	1,919	\$323	1,003	\$347	3,442	3,238	579	\$1,335	\$1,914	5.86	5.86	\$130	\$761.90	\$2,676.40
14	2029	0.1692	0.4151	1,523	2,235	\$258	\$928	\$1,185	1,919	\$325	1,003	\$347	3,442	3,238	582	\$1,344	\$1,926	5.86	5.86	\$140	\$820.51	\$2,746.77
15	2030	0.1701	0.4170	1,523	2,235	\$259	\$932	\$1,191	1,919	\$326	1,003	\$347	3,442	3,238	585	\$1,350	\$1,936	5.86	5.86	\$150	\$879.12	\$2,814.80
16	2031	0.1704	0.4189	1,523	2,235	\$259	\$936	\$1,196	1,919	\$327	1,003	\$347	3,442	3,238	586	\$1,356	\$1,943	5.86	5.86	\$160	\$937.72	\$2,880.46
17	2032	0.1705	0.4204	1,523	2,235	\$260	\$940	\$1,199	1,919	\$327	1,003	\$347	3,442	3,238	587	\$1,361	\$1,948	5.86	5.86	\$170	\$996.33	\$2,944.52
18	2033	0.1707	0.4223	1,523	2,235	\$260	\$944	\$1,204	1,919	\$328	1,003	\$347	3,442	3,238	588	\$1,368	\$1,955	5.86	5.86	\$180	\$1,054.94	\$3,010.19
19	2034	0.1710	0.4246	1,523	2,235	\$260	\$949	\$1,210	1,919	\$328	1,003	\$347	3,442	3,238	589	\$1,375	\$1,964	5.86	5.86	\$190	\$1,113.55	\$3,077.22
20	2035	0.1713	0.4265	1,523	2,235	\$261	\$953	\$1,214	1,919	\$329	1,003	\$347	3,442	3,238	590	\$1,381	\$1,971	5.86	5.86	\$200	\$1,172.16	\$3,142.89
21	2036	0.1714	0.4288	1,523	2,235	\$261	\$958	\$1,220	1,919	\$329	1,003	\$347	3,442	3,238	590	\$1,389	\$1,979	5.86	5.86	\$210	\$1,230.76	\$3,209.43
22	2037	0.1717	0.4311	1,523	2,235	\$261	\$964	\$1,225	1,919	\$329	1,003	\$347	3,442	3,238	591	\$1,396	\$1,987	5.86	5.86	\$220	\$1,289.37	\$3,276.33
23	2038	0.1720	0.4331	1,523	2,235	\$262	\$968	\$1,230	1,919	\$330	1,003	\$347	3,442	3,238	592	\$1,402	\$1,994	5.86	5.86	\$230	\$1,347.98	\$3,342.13
24	2039	0.1722	0.4353	1,523	2,235	\$262	\$973	\$1,235	1,919	\$330	1,003	\$347	3,442	3,238	593	\$1,410	\$2,002	5.86	5.86	\$240	\$1,406.59	\$3,409.03
25	2040	0.1724	0.4376	1,523	2,235	\$263	\$978	\$1,241	1,919	\$331	1,003	\$347	3,442	3,238	593	\$1,417	\$2,010	5.86	5.86	\$250	\$1,465.20	\$3,475.57
26	2041	0.1734	0.4420	1,523	2,235	\$264	\$988	\$1,252	1,919	\$333	1,003	\$347	3,442	3,238	597	\$1,431	\$2,028	5.86	5.86	\$260	\$1,523.80	\$3,551.58
27	2042	0.1744	0.4463	1,523	2,235	\$266	\$998	\$1,263	1,919	\$335	1,003	\$347	3,442	3,238	600	\$1,445	\$2,045	5.86	5.86	\$270	\$1,582.41	\$3,627.75
28	2043	0.1754	0.4507	1,523	2,235	\$267	\$1,007	\$1,274	1,919	\$337	1,003	\$347	3,442	3,238	604	\$1,459	\$2,063	5.86	5.86	\$280	\$1,641.02	\$3,704.08
29	2044	0.1764	0.4552	1,523	2,235	\$269	\$1,017	\$1,286	1,919	\$338	1,003	\$347	3,442	3,238	607	\$1,474	\$2,081	5.86	5.86	\$290	\$1,699.63	\$3,780.57
30	2045	0.1774	0.4596	1,523	2,235	\$270	\$1,027	\$1,298	1,919	\$340	1,003	\$347	3,442	3,238	611	\$1,488	\$2,099	5.86	5.86	\$300	\$1,758.23	\$3,857.22
31	2046	0.1784	0.4642	1,523	2,235	\$272	\$1,037	\$1,309	1,919	\$342	1,003	\$347	3,442	3,238	614	\$1,503	\$2,117	5.86	5.86	\$310	\$1,816.84	\$3,934.03
32	2047	0.1795	0.4688	1,523	2,235	\$273	\$1,048	\$1,321	1,919	\$344	1,003	\$347	3,442	3,238	618	\$1,518	\$2,136	5.86	5.86	\$320	\$1,875.45	\$4,011.01
33	2048	0.1805	0.4734	1,523	2,235	\$275	\$1,058	\$1,333	1,919	\$346	1,003	\$347	3,442	3,238	621	\$1,533	\$2,154	5.86	5.86	\$330	\$1,934.06	\$4,088.15
34	2049	0.1816	0.4780	1,523	2,235	\$277	\$1,068	\$1,345	1,919	\$348	1,003	\$347	3,442	3,238	625	\$1,548	\$2,173	5.86	5.86	\$340	\$1,992.67	\$4,165.47
35	2050	0.1826	0.4828	1,523	2,235	\$278	\$1,079	\$1,357	1,919	\$350	1,003	\$347	3,442	3,238	629	\$1,563	\$2,192	5.86	5.86	\$350	\$2,051.27	\$4,242.95
36	2051	0.1837	0.4875	1,523	2,235	\$280	\$1,090	\$1,369	1,919	\$352	1,003	\$347	3,442	3,238	632	\$1,579	\$2,211	5.86	5.86	\$360	\$2,109.88	\$4,320.61
37	2052	0.1847	0.4923	1,523	2,235	\$281	\$1,100	\$1,382	1,919	\$354	1,003	\$347	3,442	3,238	636	\$1,594	\$2,230	5.86	5.86	\$370	\$2,168.49	\$4,398.43
38	2053	0.1858	0.4972	1,523	2,235	\$283	\$1,111	\$1,394	1,919	\$357	1,003	\$347	3,442	3,238	639	\$1,610	\$2,249	5.86	5.86	\$380	\$2,227.10	\$4,476.44
39	2054	0.1869	0.5021	1,523	2,235	\$285	\$1,122	\$1,407	1,919	\$359	1,003	\$347	3,442	3,238	643	\$1,626	\$2,269	5.86	5.86	\$390	\$2,285.70	\$4,554.62
40	2055	0.1879	0.5070	1,523	2,235	\$286	\$1,133	\$1,419	1,919	\$361	1,003	\$347	3,442	3,238	647	\$1,642	\$2,289	5.86	5.86	\$400	\$2,344.31	\$4,632.97
41	2056	0.1890	0.5120	1,523	2,235	\$288	\$1,144	\$1,432	1,919	\$363	1,003	\$347	3,442	3,238	651	\$1,658	\$2,309	5.86	5.86	\$410	\$2,402.92	\$4,711.51
42	2057	0.1901	0.5171	1,523	2,235	\$290	\$1,156	\$1,445	1,919	\$365	1,003	\$347	3,442	3,238	654	\$1,674	\$2,329	5.86	5.86	\$420	\$2,461.53	\$4,790.23
43	2058	0.1912	0.5222	1,523	2,235	\$291	\$1,167	\$1,458	1,919	\$367	1,003	\$347	3,442	3,238	658	\$1,691	\$2,349	5.86	5.86	\$430	\$2,520.14	\$4,869.13
44	2059	0.1923	0.5273	1,523	2,235	\$293	\$1,179	\$1,471	1,919	\$369	1,003	\$347	3,442	3,238	662	\$1,707	\$2,369	5.86	5.86	\$440	\$2,578.74	\$4,948.21
45	2060	0.1934	0.5325	1,523	2,235	\$295	\$1,190	\$1,485	1,919	\$371	1,003	\$347	3,442	3,238	666	\$1,724	\$2,390	5.86	5.86	\$450	\$2,637.35	\$5,027.48
46	2061	0.1946	0.5378	1,523	2,235	\$296	\$1,202	\$1,498	1,919	\$373	1,003	\$347	3,442	3,238	670	\$1,741	\$2,411	5.86	5.86	\$460	\$2,695.96	\$5,106.94
47	2062	0.1957	0.5431	1,523	2,235	\$298	\$1,214	\$1,512	1,919	\$376	1,003	\$347	3,442	3,238	674	\$1,758	\$2,432	5.86	5.86	\$470	\$2,754.57	\$5,186.59
48	2063	0.1968	0.5484	1,523	2,235	\$300	\$1,226	\$1,525	1,919	\$378	1,003	\$347	3,442	3,238	677	\$1,776	\$2,453	5.86	5.86	\$480	\$2,813.17	\$5,266.43
49	2064	0.1980	0.5538	1,523	2,235	\$301	\$1,238	\$1,539	1,919	\$380	1,003	\$347	3,442	3,238	681	\$1,793	\$2,475	5.86	5.86	\$490	\$2,871.78	\$5,346.47
50	2065	0.1991	0.5593	1,523	2,235	\$303	\$1,250	\$1,553	1,919	\$382	1,003	\$347	3,442	3,238	685	\$1,811	\$2,496	5.86	5.86	\$500	\$2,930.39	\$5,426.69
51	2066	0.2003	0.5648	1,523	2,235	\$305	\$1,262	\$1,567	1,919	\$384	1,003	\$347	3,442	3,238	689	\$1,829	\$2,518	5.86	5.86	\$510	\$2,989.00	\$5,507.12
52	2067	0.2014	0.5704	1,523	2,235	\$307	\$1,275	\$1,582	1,919	\$387	1,003	\$347	3,442	3,238	693	\$1,847	\$2,540	5.86	5.86	\$520	\$3,047.61	\$5,587.75
53	2068	0.2026	0.5760	1,523	2,235	\$309	\$1,287	\$1,596	1,919	\$389	1,003	\$347	3,442	3,238	697	\$1,865	\$2,562	5.86				

3. Guelph (South) – Annual Operating Costs

Vertical Ground Source Heat Pump (V.GSHP)

Base Case Scenario												Feed in Tariff (FIT)		
#	Year	Electricity Rates		V.GSHP		Cooling		Hot Water		Total		FIT		
		\$/KWh	KWh	Heating Operating Cost \$	Cooling Operating Cost \$	Hot Water Operating Cost \$	Total Operating Cost \$	Incentives (S/KWh)	S/KWh	Operating Cost				
1	2016	0.1501	5,630	\$845	224	\$34	4,300	\$645	10,154	\$1,524	0.05	0.1001	\$1,016.24	
2	2017	0.1542	5,630	\$868	224	\$35	4,300	\$663	10,154	\$1,566	0.05	0.1042	\$1,057.91	
3	2018	0.1583	5,630	\$891	224	\$35	4,300	\$681	10,154	\$1,607	0.05	0.1083	\$1,099.58	
4	2019	0.1625	5,630	\$915	224	\$36	4,300	\$699	10,154	\$1,650	0.05	0.1125	\$1,142.72	
5	2020	0.1668	5,630	\$939	224	\$37	4,300	\$717	10,154	\$1,694	0.05	0.1168	\$1,185.85	
6	2021	0.1621	5,630	\$913	224	\$36	4,300	\$697	10,154	\$1,646	0.05	0.1121	\$1,138.70	
7	2022	0.1629	5,630	\$917	224	\$36	4,300	\$701	10,154	\$1,654	0.05	0.1129	\$1,146.74	
8	2023	0.1639	5,630	\$923	224	\$37	4,300	\$705	10,154	\$1,664	0.05	0.1139	\$1,156.24	
9	2024	0.1648	5,630	\$928	224	\$37	4,300	\$709	10,154	\$1,673	0.05	0.1148	\$1,165.75	
10	2025	0.1656	5,630	\$932	224	\$37	4,300	\$712	10,154	\$1,681	0.05	0.1156	\$1,173.79	
11	2026	0.1665	5,630	\$938	224	\$37	4,300	\$716	10,154	\$1,691	0.05	0.1165	\$1,183.29	
12	2027	0.1674	5,630	\$943	224	\$38	4,300	\$720	10,154	\$1,700	0.05	0.1174	\$1,192.43	
13	2028	0.1683	5,630	\$947	224	\$38	4,300	\$724	10,154	\$1,709	0.05	0.1183	\$1,200.84	
14	2029	0.1692	5,630	\$952	224	\$38	4,300	\$727	10,154	\$1,718	0.05	0.1192	\$1,209.98	
15	2030	0.1701	5,630	\$958	224	\$38	4,300	\$731	10,154	\$1,727	0.05	0.1201	\$1,219.48	
16	2031	0.1704	5,630	\$959	224	\$38	4,300	\$733	10,154	\$1,730	0.05	0.1204	\$1,222.04	
17	2032	0.1705	5,630	\$960	224	\$38	4,300	\$733	10,154	\$1,731	0.05	0.1205	\$1,223.50	
18	2033	0.1707	5,630	\$961	224	\$38	4,300	\$734	10,154	\$1,734	0.05	0.1207	\$1,226.06	
19	2034	0.1710	5,630	\$963	224	\$38	4,300	\$735	10,154	\$1,737	0.05	0.1210	\$1,228.99	
20	2035	0.1713	5,630	\$964	224	\$38	4,300	\$737	10,154	\$1,739	0.05	0.1213	\$1,231.54	
21	2036	0.1714	5,630	\$965	224	\$38	4,300	\$737	10,154	\$1,741	0.05	0.1214	\$1,233.01	
22	2037	0.1717	5,630	\$967	224	\$38	4,300	\$738	10,154	\$1,743	0.05	0.1217	\$1,235.57	
23	2038	0.1720	5,630	\$968	224	\$39	4,300	\$739	10,154	\$1,746	0.05	0.1220	\$1,238.49	
24	2039	0.1722	5,630	\$970	224	\$39	4,300	\$741	10,154	\$1,749	0.05	0.1222	\$1,241.05	
25	2040	0.1724	5,630	\$970	224	\$39	4,300	\$741	10,154	\$1,750	0.05	0.1224	\$1,242.51	
26	2041	0.1734	5,630	\$976	224	\$39	4,300	\$745	10,154	\$1,760	0.05	0.1234	\$1,252.64	
27	2042	0.1744	5,630	\$982	224	\$39	4,300	\$750	10,154	\$1,771	0.05	0.1244	\$1,262.82	
28	2043	0.1754	5,630	\$987	224	\$39	4,300	\$754	10,154	\$1,781	0.05	0.1254	\$1,273.06	
29	2044	0.1764	5,630	\$993	224	\$40	4,300	\$758	10,154	\$1,791	0.05	0.1264	\$1,283.36	
30	2045	0.1774	5,630	\$999	224	\$40	4,300	\$763	10,154	\$1,801	0.05	0.1274	\$1,293.72	
31	2046	0.1784	5,630	\$1,005	224	\$40	4,300	\$767	10,154	\$1,812	0.05	0.1284	\$1,304.14	
32	2047	0.1795	5,630	\$1,010	224	\$40	4,300	\$772	10,154	\$1,822	0.05	0.1295	\$1,314.63	
33	2048	0.1805	5,630	\$1,016	224	\$40	4,300	\$776	10,154	\$1,833	0.05	0.1305	\$1,325.17	
34	2049	0.1816	5,630	\$1,022	224	\$41	4,300	\$781	10,154	\$1,843	0.05	0.1316	\$1,335.77	
35	2050	0.1826	5,630	\$1,028	224	\$41	4,300	\$785	10,154	\$1,854	0.05	0.1326	\$1,346.43	
36	2051	0.1837	5,630	\$1,034	224	\$41	4,300	\$790	10,154	\$1,865	0.05	0.1337	\$1,357.16	
37	2052	0.1847	5,630	\$1,040	224	\$41	4,300	\$794	10,154	\$1,876	0.05	0.1347	\$1,367.95	
38	2053	0.1858	5,630	\$1,046	224	\$42	4,300	\$799	10,154	\$1,886	0.05	0.1358	\$1,378.80	
39	2054	0.1869	5,630	\$1,052	224	\$42	4,300	\$804	10,154	\$1,897	0.05	0.1369	\$1,389.71	
40	2055	0.1879	5,630	\$1,058	224	\$42	4,300	\$808	10,154	\$1,908	0.05	0.1379	\$1,400.69	
41	2056	0.1890	5,630	\$1,064	224	\$42	4,300	\$813	10,154	\$1,919	0.05	0.1390	\$1,411.73	
42	2057	0.1901	5,630	\$1,070	224	\$43	4,300	\$818	10,154	\$1,931	0.05	0.1401	\$1,422.83	
43	2058	0.1912	5,630	\$1,077	224	\$43	4,300	\$822	10,154	\$1,942	0.05	0.1412	\$1,434.00	
44	2059	0.1923	5,630	\$1,083	224	\$43	4,300	\$827	10,154	\$1,953	0.05	0.1423	\$1,445.23	
45	2060	0.1934	5,630	\$1,089	224	\$43	4,300	\$832	10,154	\$1,964	0.05	0.1434	\$1,456.53	
46	2061	0.1946	5,630	\$1,095	224	\$44	4,300	\$837	10,154	\$1,976	0.05	0.1446	\$1,467.89	
47	2062	0.1957	5,630	\$1,102	224	\$44	4,300	\$841	10,154	\$1,987	0.05	0.1457	\$1,479.32	
48	2063	0.1968	5,630	\$1,108	224	\$44	4,300	\$846	10,154	\$1,999	0.05	0.1468	\$1,490.82	
49	2064	0.1980	5,630	\$1,115	224	\$44	4,300	\$851	10,154	\$2,010	0.05	0.1480	\$1,502.38	
50	2065	0.1991	5,630	\$1,121	224	\$45	4,300	\$856	10,154	\$2,022	0.05	0.1491	\$1,514.00	
51	2066	0.2003	5,630	\$1,127	224	\$45	4,300	\$861	10,154	\$2,033	0.05	0.1503	\$1,525.70	
52	2067	0.2014	5,630	\$1,134	224	\$45	4,300	\$866	10,154	\$2,045	0.05	0.1514	\$1,537.46	
53	2068	0.2026	5,630	\$1,141	224	\$45	4,300	\$871	10,154	\$2,057	0.05	0.1526	\$1,549.29	
54	2069	0.2038	5,630	\$1,147	224	\$46	4,300	\$876	10,154	\$2,069	0.05	0.1538	\$1,561.19	
55	2070	0.2049	5,630	\$1,154	224	\$46	4,300	\$881	10,154	\$2,081	0.05	0.1549	\$1,573.16	
56	2071	0.2061	5,630	\$1,160	224	\$46	4,300	\$886	10,154	\$2,093	0.05	0.1561	\$1,585.20	
57	2072	0.2073	5,630	\$1,167	224	\$46	4,300	\$891	10,154	\$2,105	0.05	0.1573	\$1,597.31	
58	2073	0.2085	5,630	\$1,174	224	\$47	4,300	\$897	10,154	\$2,117	0.05	0.1585	\$1,609.48	
59	2074	0.2097	5,630	\$1,181	224	\$47	4,300	\$902	10,154	\$2,129	0.05	0.1597	\$1,621.73	
60	2075	0.2109	5,630	\$1,188	224	\$47	4,300	\$907	10,154	\$2,142	0.05	0.1609	\$1,634.05	

Table D1-1.7: Annual Operating Costs (V.GSHP) of a 2,000 square feet detached house above grade (average construction type) in the city of Guelph (two life cycles and three life cycles for a 60 year project lifespan); base case scenario in comparison with feed in-tariff (FIT) scenario. In the FIT scenario, an incentive of \$0.05/KWh is provided on electricity bills throughout the project lifespan

Horizontal Ground Source Heat Pump (H.GSHP)

Base Case Scenario												Feed in Tariff (FIT)		
H.GSHP												FIT		
#	Year	Electricity Rates \$/KWh	Heating KWh	Heating Operating Cost \$	Cooling KWh	Cooling Operating Cost \$	Hot Water KWh	Hot Water Operating Cost \$	Total KWh	Total Operating Cost \$	Incentives (\$/KWh)	FIT \$/KWh	Operating Cost	
1	2016	0.1501	5,713	\$857	230	\$35	4,285	\$643	10,228	\$1,535	0.05	0.1001	\$1,023.65	
2	2017	0.1542	5,713	\$881	230	\$35	4,285	\$661	10,228	\$1,577	0.05	0.1042	\$1,065.62	
3	2018	0.1583	5,713	\$904	230	\$36	4,285	\$678	10,228	\$1,619	0.05	0.1083	\$1,107.60	
4	2019	0.1625	5,713	\$929	230	\$37	4,285	\$696	10,228	\$1,662	0.05	0.1125	\$1,151.05	
5	2020	0.1668	5,713	\$953	230	\$38	4,285	\$715	10,228	\$1,706	0.05	0.1168	\$1,194.49	
6	2021	0.1621	5,713	\$926	230	\$37	4,285	\$695	10,228	\$1,658	0.05	0.1121	\$1,147.00	
7	2022	0.1629	5,713	\$931	230	\$37	4,285	\$698	10,228	\$1,666	0.05	0.1129	\$1,155.10	
8	2023	0.1639	5,713	\$936	230	\$38	4,285	\$702	10,228	\$1,676	0.05	0.1139	\$1,164.67	
9	2024	0.1648	5,713	\$942	230	\$38	4,285	\$706	10,228	\$1,686	0.05	0.1148	\$1,174.24	
10	2025	0.1656	5,713	\$946	230	\$38	4,285	\$710	10,228	\$1,694	0.05	0.1156	\$1,182.34	
11	2026	0.1665	5,713	\$951	230	\$38	4,285	\$714	10,228	\$1,703	0.05	0.1165	\$1,191.92	
12	2027	0.1674	5,713	\$957	230	\$39	4,285	\$717	10,228	\$1,713	0.05	0.1174	\$1,201.12	
13	2028	0.1683	5,713	\$961	230	\$39	4,285	\$721	10,228	\$1,721	0.05	0.1183	\$1,209.59	
14	2029	0.1692	5,713	\$966	230	\$39	4,285	\$725	10,228	\$1,730	0.05	0.1192	\$1,218.80	
15	2030	0.1701	5,713	\$972	230	\$39	4,285	\$729	10,228	\$1,740	0.05	0.1201	\$1,228.37	
16	2031	0.1704	5,713	\$973	230	\$39	4,285	\$730	10,228	\$1,742	0.05	0.1204	\$1,230.95	
17	2032	0.1705	5,713	\$974	230	\$39	4,285	\$731	10,228	\$1,744	0.05	0.1205	\$1,232.42	
18	2033	0.1707	5,713	\$975	230	\$39	4,285	\$732	10,228	\$1,746	0.05	0.1207	\$1,235.00	
19	2034	0.1710	5,713	\$977	230	\$39	4,285	\$733	10,228	\$1,749	0.05	0.1210	\$1,237.94	
20	2035	0.1713	5,713	\$979	230	\$39	4,285	\$734	10,228	\$1,752	0.05	0.1213	\$1,240.52	
21	2036	0.1714	5,713	\$979	230	\$39	4,285	\$735	10,228	\$1,753	0.05	0.1214	\$1,241.99	
22	2037	0.1717	5,713	\$981	230	\$39	4,285	\$736	10,228	\$1,756	0.05	0.1217	\$1,244.57	
23	2038	0.1720	5,713	\$982	230	\$40	4,285	\$737	10,228	\$1,759	0.05	0.1220	\$1,247.52	
24	2039	0.1722	5,713	\$984	230	\$40	4,285	\$738	10,228	\$1,761	0.05	0.1222	\$1,250.09	
25	2040	0.1724	5,713	\$985	230	\$40	4,285	\$739	10,228	\$1,763	0.05	0.1224	\$1,251.57	
26	2041	0.1734	5,713	\$990	230	\$40	4,285	\$743	10,228	\$1,773	0.05	0.1234	\$1,261.76	
27	2042	0.1744	5,713	\$996	230	\$40	4,285	\$747	10,228	\$1,783	0.05	0.1244	\$1,272.02	
28	2043	0.1754	5,713	\$1,002	230	\$40	4,285	\$751	10,228	\$1,794	0.05	0.1254	\$1,282.34	
29	2044	0.1764	5,713	\$1,008	230	\$41	4,285	\$756	10,228	\$1,804	0.05	0.1264	\$1,292.72	
30	2045	0.1774	5,713	\$1,014	230	\$41	4,285	\$760	10,228	\$1,815	0.05	0.1274	\$1,303.15	
31	2046	0.1784	5,713	\$1,019	230	\$41	4,285	\$765	10,228	\$1,825	0.05	0.1284	\$1,313.65	
32	2047	0.1795	5,713	\$1,025	230	\$41	4,285	\$769	10,228	\$1,836	0.05	0.1295	\$1,324.21	
33	2048	0.1805	5,713	\$1,031	230	\$42	4,285	\$773	10,228	\$1,846	0.05	0.1305	\$1,334.83	
34	2049	0.1816	5,713	\$1,037	230	\$42	4,285	\$778	10,228	\$1,857	0.05	0.1316	\$1,345.51	
35	2050	0.1826	5,713	\$1,043	230	\$42	4,285	\$782	10,228	\$1,868	0.05	0.1326	\$1,356.25	
36	2051	0.1837	5,713	\$1,049	230	\$42	4,285	\$787	10,228	\$1,878	0.05	0.1337	\$1,367.05	
37	2052	0.1847	5,713	\$1,055	230	\$42	4,285	\$792	10,228	\$1,889	0.05	0.1347	\$1,377.92	
38	2053	0.1858	5,713	\$1,061	230	\$43	4,285	\$796	10,228	\$1,900	0.05	0.1358	\$1,388.85	
39	2054	0.1869	5,713	\$1,068	230	\$43	4,285	\$801	10,228	\$1,911	0.05	0.1369	\$1,399.84	
40	2055	0.1879	5,713	\$1,074	230	\$43	4,285	\$805	10,228	\$1,922	0.05	0.1379	\$1,410.90	
41	2056	0.1890	5,713	\$1,080	230	\$43	4,285	\$810	10,228	\$1,933	0.05	0.1390	\$1,422.02	
42	2057	0.1901	5,713	\$1,086	230	\$44	4,285	\$815	10,228	\$1,945	0.05	0.1401	\$1,433.20	
43	2058	0.1912	5,713	\$1,092	230	\$44	4,285	\$819	10,228	\$1,956	0.05	0.1412	\$1,444.45	
44	2059	0.1923	5,713	\$1,099	230	\$44	4,285	\$824	10,228	\$1,967	0.05	0.1423	\$1,455.76	
45	2060	0.1934	5,713	\$1,105	230	\$44	4,285	\$829	10,228	\$1,979	0.05	0.1434	\$1,467.14	
46	2061	0.1946	5,713	\$1,112	230	\$45	4,285	\$834	10,228	\$1,990	0.05	0.1446	\$1,478.59	
47	2062	0.1957	5,713	\$1,118	230	\$45	4,285	\$839	10,228	\$2,002	0.05	0.1457	\$1,490.10	
48	2063	0.1968	5,713	\$1,124	230	\$45	4,285	\$843	10,228	\$2,013	0.05	0.1468	\$1,501.68	
49	2064	0.1980	5,713	\$1,131	230	\$46	4,285	\$848	10,228	\$2,025	0.05	0.1480	\$1,513.33	
50	2065	0.1991	5,713	\$1,137	230	\$46	4,285	\$853	10,228	\$2,036	0.05	0.1491	\$1,525.04	
51	2066	0.2003	5,713	\$1,144	230	\$46	4,285	\$858	10,228	\$2,048	0.05	0.1503	\$1,536.82	
52	2067	0.2014	5,713	\$1,151	230	\$46	4,285	\$863	10,228	\$2,060	0.05	0.1514	\$1,548.67	
53	2068	0.2026	5,713	\$1,157	230	\$47	4,285	\$868	10,228	\$2,072	0.05	0.1526	\$1,560.58	
54	2069	0.2038	5,713	\$1,164	230	\$47	4,285	\$873	10,228	\$2,084	0.05	0.1538	\$1,572.57	
55	2070	0.2049	5,713	\$1,171	230	\$47	4,285	\$878	10,228	\$2,096	0.05	0.1549	\$1,584.63	
56	2071	0.2061	5,713	\$1,178	230	\$47	4,285	\$883	10,228	\$2,108	0.05	0.1561	\$1,596.75	
57	2072	0.2073	5,713	\$1,184	230	\$48	4,285	\$888	10,228	\$2,120	0.05	0.1573	\$1,608.95	
58	2073	0.2085	5,713	\$1,191	230	\$48	4,285	\$893	10,228	\$2,133	0.05	0.1585	\$1,621.21	
59	2074	0.2097	5,713	\$1,198	230	\$48	4,285	\$899	10,228	\$2,145	0.05	0.1597	\$1,633.55	
60	2075	0.2109	5,713	\$1,205	230	\$49	4,285	\$904	10,228	\$2,157	0.05	0.1609	\$1,645.96	

Table D1-1.8: Annual Operating Costs (H.GSHP) of a 2,000 square feet detached house above grade (average construction type) in the city of Guelph (two life cycles and three life cycles for a 60 year project lifespan); base case scenario in comparison with feed in-tariff (FIT) scenario. In the FIT scenario, an incentive of \$0.05/KWh is provided on electricity bills throughout the project lifespan

Traditional HVAC Applications

Base Case Scenario																	Carbon Taxes						
#	Year	Traditional														Total	Carbon Taxes						
		Electricity Rates \$/KWh	Natural Gas Rates \$/m ³	Heating		Heating Operating Cost		Total Heating Operating Cost \$	Cooling		Hot Water m ³	Hot Water Operating Cost		Total KWh	Total m ³		Total Electricity Operating Cost \$ (KWh)	Total Natural Gas Operating Cost \$ (m ³)	Total	Conversion of m ³ into Tons	Total Tons	Carbon Tax	Operating Costs
				KWh (Electricity)	m ³ (Gas)	\$ (Electricity)	\$ (Gas)		KWh	\$		\$	\$										
1	2016	0.1501	0.3458	1,410	2,726	\$212	\$943	\$1,154	871	\$131	1,029	\$356	2,281	3,755	342	\$1,299	\$1,641	6.80	6.80	\$10	\$67.97	\$1,708.90	
2	2017	0.1542	0.3588	1,410	2,726	\$217	\$978	\$1,196	871	\$134	1,029	\$359	2,281	3,755	352	\$1,347	\$1,699	6.80	6.80	\$20	\$135.93	\$1,835.06	
3	2018	0.1583	0.3718	1,410	2,726	\$223	\$1,014	\$1,237	871	\$138	1,029	\$363	2,281	3,755	361	\$1,396	\$1,757	6.80	6.80	\$30	\$203.90	\$1,961.23	
4	2019	0.1625	0.3776	1,410	2,726	\$229	\$1,029	\$1,258	871	\$142	1,029	\$367	2,281	3,755	371	\$1,418	\$1,789	6.80	6.80	\$40	\$271.86	\$2,060.43	
5	2020	0.1668	0.3841	1,410	2,726	\$235	\$1,047	\$1,282	871	\$145	1,029	\$372	2,281	3,755	380	\$1,442	\$1,823	6.80	6.80	\$50	\$339.83	\$2,162.51	
6	2021	0.1621	0.3883	1,410	2,726	\$229	\$1,058	\$1,287	871	\$141	1,029	\$367	2,281	3,755	370	\$1,458	\$1,828	6.80	6.80	\$60	\$407.79	\$2,235.68	
7	2022	0.1629	0.3929	1,410	2,726	\$230	\$1,071	\$1,301	871	\$142	1,029	\$368	2,281	3,755	372	\$1,475	\$1,847	6.80	6.80	\$70	\$475.76	\$2,322.69	
8	2023	0.1639	0.3967	1,410	2,726	\$231	\$1,081	\$1,312	871	\$143	1,029	\$369	2,281	3,755	374	\$1,490	\$1,863	6.80	6.80	\$80	\$543.72	\$2,407.16	
9	2024	0.1648	0.4005	1,410	2,726	\$232	\$1,092	\$1,324	871	\$144	1,029	\$370	2,281	3,755	376	\$1,504	\$1,880	6.80	6.80	\$90	\$611.69	\$2,491.62	
10	2025	0.1656	0.4040	1,410	2,726	\$233	\$1,101	\$1,335	871	\$144	1,029	\$370	2,281	3,755	378	\$1,517	\$1,895	6.80	6.80	\$100	\$679.66	\$2,574.33	
11	2026	0.1665	0.4070	1,410	2,726	\$235	\$1,110	\$1,344	871	\$145	1,029	\$371	2,281	3,755	380	\$1,528	\$1,908	6.80	6.80	\$110	\$747.62	\$2,655.92	
12	2027	0.1674	0.4097	1,410	2,726	\$236	\$1,117	\$1,353	871	\$146	1,029	\$372	2,281	3,755	382	\$1,538	\$1,920	6.80	6.80	\$120	\$815.59	\$2,735.99	
13	2028	0.1683	0.4124	1,410	2,726	\$237	\$1,124	\$1,361	871	\$147	1,029	\$373	2,281	3,755	384	\$1,549	\$1,932	6.80	6.80	\$130	\$883.55	\$2,815.90	
14	2029	0.1692	0.4151	1,410	2,726	\$239	\$1,131	\$1,370	871	\$147	1,029	\$374	2,281	3,755	386	\$1,559	\$1,944	6.80	6.80	\$140	\$951.52	\$2,895.97	
15	2030	0.1701	0.4170	1,410	2,726	\$240	\$1,137	\$1,377	871	\$148	1,029	\$375	2,281	3,755	388	\$1,566	\$1,954	6.80	6.80	\$150	\$1,019.48	\$2,973.26	
16	2031	0.1704	0.4189	1,410	2,726	\$240	\$1,142	\$1,382	871	\$148	1,029	\$375	2,281	3,755	389	\$1,573	\$1,962	6.80	6.80	\$160	\$1,087.45	\$3,048.98	
17	2032	0.1705	0.4204	1,410	2,726	\$240	\$1,146	\$1,386	871	\$149	1,029	\$375	2,281	3,755	389	\$1,579	\$1,968	6.80	6.80	\$170	\$1,155.41	\$3,123.02	
18	2033	0.1707	0.4223	1,410	2,726	\$241	\$1,151	\$1,392	871	\$149	1,029	\$376	2,281	3,755	389	\$1,586	\$1,975	6.80	6.80	\$180	\$1,223.38	\$3,198.74	
19	2034	0.1710	0.4246	1,410	2,726	\$241	\$1,158	\$1,399	871	\$149	1,029	\$376	2,281	3,755	390	\$1,595	\$1,985	6.80	6.80	\$190	\$1,291.34	\$3,275.98	
20	2035	0.1713	0.4265	1,410	2,726	\$242	\$1,163	\$1,404	871	\$149	1,029	\$376	2,281	3,755	391	\$1,602	\$1,992	6.80	6.80	\$200	\$1,359.31	\$3,351.71	
21	2036	0.1714	0.4288	1,410	2,726	\$242	\$1,169	\$1,411	871	\$149	1,029	\$376	2,281	3,755	391	\$1,610	\$2,001	6.80	6.80	\$210	\$1,427.28	\$3,428.62	
22	2037	0.1717	0.4311	1,410	2,726	\$242	\$1,175	\$1,417	871	\$150	1,029	\$377	2,281	3,755	392	\$1,619	\$2,011	6.80	6.80	\$220	\$1,495.24	\$3,505.78	
23	2038	0.1720	0.4331	1,410	2,726	\$242	\$1,181	\$1,423	871	\$150	1,029	\$377	2,281	3,755	392	\$1,626	\$2,018	6.80	6.80	\$230	\$1,563.21	\$3,581.58	
24	2039	0.1722	0.4353	1,410	2,726	\$243	\$1,187	\$1,430	871	\$150	1,029	\$377	2,281	3,755	393	\$1,635	\$2,028	6.80	6.80	\$240	\$1,631.17	\$3,658.74	
25	2040	0.1724	0.4376	1,410	2,726	\$243	\$1,193	\$1,436	871	\$150	1,029	\$377	2,281	3,755	393	\$1,643	\$2,037	6.80	6.80	\$250	\$1,699.14	\$3,735.96	
26	2041	0.1734	0.4420	1,410	2,726	\$244	\$1,205	\$1,449	871	\$151	1,029	\$378	2,281	3,755	395	\$1,660	\$2,055	6.80	6.80	\$260	\$1,767.10	\$3,822.10	
27	2042	0.1744	0.4463	1,410	2,726	\$246	\$1,217	\$1,463	871	\$152	1,029	\$379	2,281	3,755	398	\$1,676	\$2,074	6.80	6.80	\$270	\$1,835.07	\$3,908.71	
28	2043	0.1754	0.4507	1,410	2,726	\$247	\$1,229	\$1,476	871	\$153	1,029	\$380	2,281	3,755	400	\$1,692	\$2,092	6.80	6.80	\$280	\$1,903.03	\$3,995.50	
29	2044	0.1764	0.4552	1,410	2,726	\$249	\$1,241	\$1,489	871	\$154	1,029	\$382	2,281	3,755	402	\$1,709	\$2,111	6.80	6.80	\$290	\$1,971.00	\$4,082.47	
30	2045	0.1774	0.4596	1,410	2,726	\$250	\$1,253	\$1,503	871	\$155	1,029	\$383	2,281	3,755	405	\$1,726	\$2,131	6.80	6.80	\$300	\$2,038.97	\$4,169.61	
31	2046	0.1784	0.4642	1,410	2,726	\$252	\$1,265	\$1,517	871	\$155	1,029	\$384	2,281	3,755	407	\$1,743	\$2,150	6.80	6.80	\$310	\$2,106.93	\$4,256.93	
32	2047	0.1795	0.4688	1,410	2,726	\$253	\$1,278	\$1,531	871	\$156	1,029	\$385	2,281	3,755	409	\$1,760	\$2,170	6.80	6.80	\$320	\$2,174.90	\$4,344.44	
33	2048	0.1805	0.4734	1,410	2,726	\$255	\$1,290	\$1,545	871	\$157	1,029	\$386	2,281	3,755	412	\$1,778	\$2,189	6.80	6.80	\$330	\$2,242.86	\$4,432.13	
34	2049	0.1816	0.4780	1,410	2,726	\$256	\$1,303	\$1,559	871	\$158	1,029	\$387	2,281	3,755	414	\$1,795	\$2,209	6.80	6.80	\$340	\$2,310.83	\$4,520.00	
35	2050	0.1826	0.4828	1,410	2,726	\$257	\$1,316	\$1,573	871	\$159	1,029	\$388	2,281	3,755	417	\$1,813	\$2,229	6.80	6.80	\$350	\$2,378.79	\$4,608.06	
36	2051	0.1837	0.4875	1,410	2,726	\$259	\$1,329	\$1,588	871	\$160	1,029	\$389	2,281	3,755	419	\$1,831	\$2,250	6.80	6.80	\$360	\$2,446.76	\$4,696.30	
37	2052	0.1847	0.4923	1,410	2,726	\$260	\$1,342	\$1,603	871	\$161	1,029	\$390	2,281	3,755	421	\$1,849	\$2,270	6.80	6.80	\$370	\$2,514.72	\$4,784.74	
38	2053	0.1858	0.4972	1,410	2,726	\$262	\$1,355	\$1,617	871	\$162	1,029	\$391	2,281	3,755	424	\$1,867	\$2,291	6.80	6.80	\$380	\$2,582.69	\$4,873.37	
39	2054	0.1869	0.5021	1,410	2,726	\$263	\$1,369	\$1,632	871	\$163	1,029	\$392	2,281	3,755	426	\$1,885	\$2,312	6.80	6.80	\$390	\$2,650.65	\$4,962.19	
40	2055	0.1879	0.5070	1,410	2,726	\$265	\$1,382	\$1,647	871	\$164	1,029	\$393	2,281	3,755	429	\$1,904	\$2,333	6.80	6.80	\$400	\$2,718.62	\$5,051.21	
41	2056	0.1890	0.5120	1,410	2,726	\$267	\$1,396	\$1,662	871	\$165	1,029	\$395	2,281	3,755	431	\$1,923	\$2,354	6.80	6.80	\$410	\$2,786.59	\$5,140.43	
42	2057	0.1901	0.5171	1,410	2,726	\$268	\$1,410	\$1,678	871	\$166	1,029	\$396	2,281	3,755	434	\$1,942	\$2,375	6.80	6.80	\$420	\$2,854.55	\$5,229.84	
43	2058	0.1912	0.5222	1,410	2,726	\$270	\$1,423	\$1,693	871	\$167	1,029	\$397	2,281	3,755	436	\$1,961	\$2,397	6.80	6.80	\$430	\$2,922.52	\$5,319.46	
44	2059	0.1923	0.5273	1,410	2,726	\$271	\$1,437	\$1,709	871	\$168	1,029	\$398	2,281	3,755	439	\$1,980	\$2,419	6.80	6.80	\$440	\$2,990.48	\$5,409.28	
45	2060	0.1934	0.5325	1,410	2,726	\$273	\$1,452	\$1,724	871	\$168	1,029	\$399	2,281	3,755	441	\$2,000	\$2,441	6.80	6.80	\$450	\$3,058.45	\$5,499.30	
46	2061	0.1946	0.5378	1,410	2,726	\$274	\$1,466	\$1,740	871	\$169	1,029	\$400	2,281	3,755	444	\$2,019	\$2,463	6.80	6.80	\$460	\$3,126.41	\$5,589.53	
47	2062	0.1957	0.5431	1,410	2,726	\$276	\$1,480	\$1,756	871	\$170	1,029	\$401	2,281	3,755	446	\$2,039	\$2,486	6.80	6.80	\$470	\$3,194.38	\$5,679.98	
48	2063	0.1968	0.5484	1,410	2,726	\$278	\$1,495	\$1,773	871	\$171	1,029	\$403	2,281	3,755	449	\$2,059	\$2,508	6.80	6.80	\$480	\$3,262.34	\$5,770.63	
49	2064	0.1980	0.5538	1,410	2,726	\$279	\$1,510	\$1,789	871	\$172	1,029	\$404	2,281	3,755	452	\$2,080	\$2,531	6.80	6.80	\$490	\$3,330.31	\$5,861.49	
50	2065	0.1991	0.5593	1,410	2,726	\$281	\$1,525	\$1,805	871	\$173	1,029	\$405	2,281	3,755	454	\$2,100	\$2,554	6.80	6.80	\$500	\$3,398.28	\$5,952.57	
51	2066	0.2003	0.5648	1,410	2,726	\$282	\$1,540	\$1,822	871	\$174	1,029	\$406	2,281	3,755	457	\$2,121	\$2,578	6.80	6.80	\$510	\$3,466.24	\$6,043.87	
52	2067	0.2014	0.5704	1,410	2,726	\$284	\$1,555	\$1,839	871	\$175	1,029	\$407	2,281	3,755	459	\$2,142	\$2,601	6.80	6.80	\$520	\$3,534.21	\$6,135.39	
53	2068	0.2026	0.5760	1,410	2,726	\$286	\$1,570	\$1,856	871	\$176	1,029	\$408	2,281	3,755	462	\$2,163	\$2,625	6.80	6.80	\$530	\$3,602.17		

4. Hamilton (South) – Annual Operating Costs

Vertical Ground Source Heat Pump (V.GSHP)

Base Case Scenario											Feed in Tariff (FIT)		
V.GSHP											FIT		
#	Year	Electricity Rates \$/kWh	Heating kWh	Heating Operating Cost \$	Cooling kWh	Cooling Operating Cost \$	Hot Water kWh	Hot Water Operating Cost \$	Total kWh	Total Operating Cost \$	Incentives (S/kWh)	FIT S/kWh	Operating Cost
1	2016	0.1501	5,046	\$757	475	\$71	4,314	\$647	9,835	\$1,476	0.05	0.1001	\$984.31
2	2017	0.1542	5,046	\$778	475	\$73	4,314	\$665	9,835	\$1,516	0.05	0.1042	\$1,024.68
3	2018	0.1583	5,046	\$799	475	\$75	4,314	\$683	9,835	\$1,557	0.05	0.1083	\$1,065.04
4	2019	0.1625	5,046	\$820	475	\$77	4,314	\$701	9,835	\$1,599	0.05	0.1125	\$1,106.82
5	2020	0.1668	5,046	\$842	475	\$79	4,314	\$720	9,835	\$1,640	0.05	0.1168	\$1,148.60
6	2021	0.1621	5,046	\$818	475	\$77	4,314	\$699	9,835	\$1,595	0.05	0.1121	\$1,102.92
7	2022	0.1629	5,046	\$822	475	\$77	4,314	\$703	9,835	\$1,602	0.05	0.1129	\$1,110.71
8	2023	0.1639	5,046	\$827	475	\$78	4,314	\$707	9,835	\$1,612	0.05	0.1139	\$1,119.92
9	2024	0.1648	5,046	\$832	475	\$78	4,314	\$711	9,835	\$1,621	0.05	0.1148	\$1,129.12
10	2025	0.1656	5,046	\$836	475	\$79	4,314	\$714	9,835	\$1,629	0.05	0.1156	\$1,136.91
11	2026	0.1665	5,046	\$840	475	\$79	4,314	\$718	9,835	\$1,638	0.05	0.1165	\$1,146.12
12	2027	0.1674	5,046	\$845	475	\$80	4,314	\$722	9,835	\$1,647	0.05	0.1174	\$1,154.97
13	2028	0.1683	5,046	\$849	475	\$80	4,314	\$726	9,835	\$1,655	0.05	0.1183	\$1,163.11
14	2029	0.1692	5,046	\$854	475	\$80	4,314	\$730	9,835	\$1,664	0.05	0.1192	\$1,171.96
15	2030	0.1701	5,046	\$858	475	\$81	4,314	\$734	9,835	\$1,673	0.05	0.1201	\$1,181.17
16	2031	0.1704	5,046	\$860	475	\$81	4,314	\$735	9,835	\$1,675	0.05	0.1204	\$1,183.65
17	2032	0.1705	5,046	\$860	475	\$81	4,314	\$736	9,835	\$1,677	0.05	0.1205	\$1,185.06
18	2033	0.1707	5,046	\$862	475	\$81	4,314	\$737	9,835	\$1,679	0.05	0.1207	\$1,187.54
19	2034	0.1710	5,046	\$863	475	\$81	4,314	\$738	9,835	\$1,682	0.05	0.1210	\$1,190.38
20	2035	0.1713	5,046	\$864	475	\$81	4,314	\$739	9,835	\$1,685	0.05	0.1213	\$1,192.85
21	2036	0.1714	5,046	\$865	475	\$81	4,314	\$740	9,835	\$1,686	0.05	0.1214	\$1,194.27
22	2037	0.1717	5,046	\$866	475	\$82	4,314	\$741	9,835	\$1,688	0.05	0.1217	\$1,196.75
23	2038	0.1720	5,046	\$868	475	\$82	4,314	\$742	9,835	\$1,691	0.05	0.1220	\$1,199.58
24	2039	0.1722	5,046	\$869	475	\$82	4,314	\$743	9,835	\$1,694	0.05	0.1222	\$1,202.06
25	2040	0.1724	5,046	\$870	475	\$82	4,314	\$744	9,835	\$1,695	0.05	0.1224	\$1,203.48
26	2041	0.1734	5,046	\$875	475	\$82	4,314	\$748	9,835	\$1,705	0.05	0.1234	\$1,213.28
27	2042	0.1744	5,046	\$880	475	\$83	4,314	\$752	9,835	\$1,715	0.05	0.1244	\$1,223.15
28	2043	0.1754	5,046	\$885	475	\$83	4,314	\$757	9,835	\$1,725	0.05	0.1254	\$1,233.07
29	2044	0.1764	5,046	\$890	475	\$84	4,314	\$761	9,835	\$1,735	0.05	0.1264	\$1,243.04
30	2045	0.1774	5,046	\$895	475	\$84	4,314	\$765	9,835	\$1,745	0.05	0.1274	\$1,253.08
31	2046	0.1784	5,046	\$900	475	\$85	4,314	\$770	9,835	\$1,755	0.05	0.1284	\$1,263.17
32	2047	0.1795	5,046	\$906	475	\$85	4,314	\$774	9,835	\$1,765	0.05	0.1295	\$1,273.33
33	2048	0.1805	5,046	\$911	475	\$86	4,314	\$779	9,835	\$1,775	0.05	0.1305	\$1,283.54
34	2049	0.1816	5,046	\$916	475	\$86	4,314	\$783	9,835	\$1,786	0.05	0.1316	\$1,293.81
35	2050	0.1826	5,046	\$921	475	\$87	4,314	\$788	9,835	\$1,796	0.05	0.1326	\$1,304.13
36	2051	0.1837	5,046	\$927	475	\$87	4,314	\$792	9,835	\$1,806	0.05	0.1337	\$1,314.52
37	2052	0.1847	5,046	\$932	475	\$88	4,314	\$797	9,835	\$1,817	0.05	0.1347	\$1,324.97
38	2053	0.1858	5,046	\$937	475	\$88	4,314	\$801	9,835	\$1,827	0.05	0.1358	\$1,335.48
39	2054	0.1869	5,046	\$943	475	\$89	4,314	\$806	9,835	\$1,838	0.05	0.1369	\$1,346.05
40	2055	0.1879	5,046	\$948	475	\$89	4,314	\$811	9,835	\$1,848	0.05	0.1379	\$1,356.68
41	2056	0.1890	5,046	\$954	475	\$90	4,314	\$815	9,835	\$1,859	0.05	0.1390	\$1,367.38
42	2057	0.1901	5,046	\$959	475	\$90	4,314	\$820	9,835	\$1,870	0.05	0.1401	\$1,378.13
43	2058	0.1912	5,046	\$965	475	\$91	4,314	\$825	9,835	\$1,881	0.05	0.1412	\$1,388.95
44	2059	0.1923	5,046	\$971	475	\$91	4,314	\$830	9,835	\$1,892	0.05	0.1423	\$1,399.83
45	2060	0.1934	5,046	\$976	475	\$92	4,314	\$835	9,835	\$1,903	0.05	0.1434	\$1,410.77
46	2061	0.1946	5,046	\$982	475	\$92	4,314	\$839	9,835	\$1,914	0.05	0.1446	\$1,421.78
47	2062	0.1957	5,046	\$987	475	\$93	4,314	\$844	9,835	\$1,925	0.05	0.1457	\$1,432.85
48	2063	0.1968	5,046	\$993	475	\$93	4,314	\$849	9,835	\$1,936	0.05	0.1468	\$1,443.98
49	2064	0.1980	5,046	\$999	475	\$94	4,314	\$854	9,835	\$1,947	0.05	0.1480	\$1,455.18
50	2065	0.1991	5,046	\$1,005	475	\$95	4,314	\$859	9,835	\$1,958	0.05	0.1491	\$1,466.44
51	2066	0.2003	5,046	\$1,010	475	\$95	4,314	\$864	9,835	\$1,970	0.05	0.1503	\$1,477.77
52	2067	0.2014	5,046	\$1,016	475	\$96	4,314	\$869	9,835	\$1,981	0.05	0.1514	\$1,489.16
53	2068	0.2026	5,046	\$1,022	475	\$96	4,314	\$874	9,835	\$1,992	0.05	0.1526	\$1,500.62
54	2069	0.2038	5,046	\$1,028	475	\$97	4,314	\$879	9,835	\$2,004	0.05	0.1538	\$1,512.15
55	2070	0.2049	5,046	\$1,034	475	\$97	4,314	\$884	9,835	\$2,015	0.05	0.1549	\$1,523.74
56	2071	0.2061	5,046	\$1,040	475	\$98	4,314	\$889	9,835	\$2,027	0.05	0.1561	\$1,535.40
57	2072	0.2073	5,046	\$1,046	475	\$98	4,314	\$894	9,835	\$2,039	0.05	0.1573	\$1,547.12
58	2073	0.2085	5,046	\$1,052	475	\$99	4,314	\$900	9,835	\$2,051	0.05	0.1585	\$1,558.92
59	2074	0.2097	5,046	\$1,058	475	\$100	4,314	\$905	9,835	\$2,063	0.05	0.1597	\$1,570.78
60	2075	0.2109	5,046	\$1,064	475	\$100	4,314	\$910	9,835	\$2,074	0.05	0.1609	\$1,582.71

Table D1-1.10: Annual Operating Costs (V.GSHP) of a 2,000 square feet detached house above grade (average construction type) in the city of Hamilton (two life cycles and three life cycles for a 60 year project lifespan); base case scenario in comparison with feed-in-tariff (FIT) scenario. In the FIT scenario, an incentive of \$0.05/KWh is provided on electricity bills throughout the project lifespan

Horizontal Ground Source Heat Pump (H.GSHP)

Base Case Scenario											Feed in Tariff (FIT)		
H.GSHP											FIT		
#	Year	Electricity Rates \$/KWh	Heating KWh	Heating Operating Cost \$	Cooling KWh	Cooling Operating Cost \$	Hot Water KWh	Hot Water Operating Cost \$	Total KWh	Total Operating Cost \$	Incentives (\$/KWh)	\$/KWh	Operating Cost
1	2016	0.1501	5,129	\$70	488	\$73	4,285	\$643	9,902	\$1,486	0.05	0.1001	\$991.02
2	2017	0.1542	5,129	\$71	488	\$75	4,285	\$661	9,902	\$1,527	0.05	0.1042	\$1,031.66
3	2018	0.1583	5,129	\$812	488	\$77	4,285	\$678	9,902	\$1,567	0.05	0.1083	\$1,072.29
4	2019	0.1625	5,129	\$834	488	\$79	4,285	\$696	9,902	\$1,609	0.05	0.1125	\$1,114.36
5	2020	0.1668	5,129	\$855	488	\$81	4,285	\$715	9,902	\$1,652	0.05	0.1168	\$1,156.42
6	2021	0.1621	5,129	\$832	488	\$79	4,285	\$695	9,902	\$1,606	0.05	0.1121	\$1,110.44
7	2022	0.1629	5,129	\$836	488	\$80	4,285	\$698	9,902	\$1,613	0.05	0.1129	\$1,118.28
8	2023	0.1639	5,129	\$840	488	\$80	4,285	\$702	9,902	\$1,623	0.05	0.1139	\$1,127.55
9	2024	0.1648	5,129	\$845	488	\$80	4,285	\$706	9,902	\$1,632	0.05	0.1148	\$1,136.82
10	2025	0.1656	5,129	\$849	488	\$81	4,285	\$710	9,902	\$1,640	0.05	0.1156	\$1,144.66
11	2026	0.1665	5,129	\$854	488	\$81	4,285	\$714	9,902	\$1,649	0.05	0.1165	\$1,153.93
12	2027	0.1674	5,129	\$859	488	\$82	4,285	\$717	9,902	\$1,658	0.05	0.1174	\$1,162.84
13	2028	0.1683	5,129	\$863	488	\$82	4,285	\$721	9,902	\$1,666	0.05	0.1183	\$1,171.04
14	2029	0.1692	5,129	\$868	488	\$83	4,285	\$725	9,902	\$1,675	0.05	0.1192	\$1,179.95
15	2030	0.1701	5,129	\$872	488	\$83	4,285	\$729	9,902	\$1,684	0.05	0.1201	\$1,189.22
16	2031	0.1704	5,129	\$874	488	\$83	4,285	\$730	9,902	\$1,687	0.05	0.1204	\$1,191.71
17	2032	0.1705	5,129	\$874	488	\$83	4,285	\$731	9,902	\$1,688	0.05	0.1205	\$1,193.14
18	2033	0.1707	5,129	\$876	488	\$83	4,285	\$732	9,902	\$1,691	0.05	0.1207	\$1,195.63
19	2034	0.1710	5,129	\$877	488	\$83	4,285	\$733	9,902	\$1,694	0.05	0.1210	\$1,198.48
20	2035	0.1713	5,129	\$879	488	\$84	4,285	\$734	9,902	\$1,696	0.05	0.1213	\$1,200.98
21	2036	0.1714	5,129	\$879	488	\$84	4,285	\$735	9,902	\$1,698	0.05	0.1214	\$1,202.41
22	2037	0.1717	5,129	\$881	488	\$84	4,285	\$736	9,902	\$1,700	0.05	0.1217	\$1,204.90
23	2038	0.1720	5,129	\$882	488	\$84	4,285	\$737	9,902	\$1,703	0.05	0.1220	\$1,207.75
24	2039	0.1722	5,129	\$883	488	\$84	4,285	\$738	9,902	\$1,705	0.05	0.1222	\$1,210.25
25	2040	0.1724	5,129	\$884	488	\$84	4,285	\$739	9,902	\$1,707	0.05	0.1224	\$1,211.67
26	2041	0.1734	5,129	\$889	488	\$85	4,285	\$743	9,902	\$1,717	0.05	0.1234	\$1,221.55
27	2042	0.1744	5,129	\$894	488	\$85	4,285	\$747	9,902	\$1,727	0.05	0.1244	\$1,231.48
28	2043	0.1754	5,129	\$899	488	\$86	4,285	\$751	9,902	\$1,737	0.05	0.1254	\$1,241.47
29	2044	0.1764	5,129	\$905	488	\$86	4,285	\$756	9,902	\$1,747	0.05	0.1264	\$1,251.51
30	2045	0.1774	5,129	\$910	488	\$87	4,285	\$760	9,902	\$1,757	0.05	0.1274	\$1,261.62
31	2046	0.1784	5,129	\$915	488	\$87	4,285	\$765	9,902	\$1,767	0.05	0.1284	\$1,271.78
32	2047	0.1795	5,129	\$920	488	\$88	4,285	\$769	9,902	\$1,777	0.05	0.1295	\$1,282.00
33	2048	0.1805	5,129	\$926	488	\$88	4,285	\$773	9,902	\$1,787	0.05	0.1305	\$1,292.28
34	2049	0.1816	5,129	\$931	488	\$89	4,285	\$778	9,902	\$1,798	0.05	0.1316	\$1,302.62
35	2050	0.1826	5,129	\$937	488	\$89	4,285	\$782	9,902	\$1,808	0.05	0.1326	\$1,313.02
36	2051	0.1837	5,129	\$942	488	\$90	4,285	\$787	9,902	\$1,819	0.05	0.1337	\$1,323.48
37	2052	0.1847	5,129	\$947	488	\$90	4,285	\$792	9,902	\$1,829	0.05	0.1347	\$1,334.00
38	2053	0.1858	5,129	\$953	488	\$91	4,285	\$796	9,902	\$1,840	0.05	0.1358	\$1,344.58
39	2054	0.1869	5,129	\$958	488	\$91	4,285	\$801	9,902	\$1,850	0.05	0.1369	\$1,355.22
40	2055	0.1879	5,129	\$964	488	\$92	4,285	\$805	9,902	\$1,861	0.05	0.1379	\$1,365.93
41	2056	0.1890	5,129	\$970	488	\$92	4,285	\$810	9,902	\$1,872	0.05	0.1390	\$1,376.69
42	2057	0.1901	5,129	\$975	488	\$93	4,285	\$815	9,902	\$1,883	0.05	0.1401	\$1,387.52
43	2058	0.1912	5,129	\$981	488	\$93	4,285	\$819	9,902	\$1,894	0.05	0.1412	\$1,398.41
44	2059	0.1923	5,129	\$986	488	\$94	4,285	\$824	9,902	\$1,904	0.05	0.1423	\$1,409.36
45	2060	0.1934	5,129	\$992	488	\$94	4,285	\$829	9,902	\$1,915	0.05	0.1434	\$1,420.38
46	2061	0.1946	5,129	\$998	488	\$95	4,285	\$834	9,902	\$1,927	0.05	0.1446	\$1,431.46
47	2062	0.1957	5,129	\$1,004	488	\$95	4,285	\$839	9,902	\$1,938	0.05	0.1457	\$1,442.61
48	2063	0.1968	5,129	\$1,009	488	\$96	4,285	\$843	9,902	\$1,949	0.05	0.1468	\$1,453.82
49	2064	0.1980	5,129	\$1,015	488	\$97	4,285	\$848	9,902	\$1,960	0.05	0.1480	\$1,465.09
50	2065	0.1991	5,129	\$1,021	488	\$97	4,285	\$853	9,902	\$1,972	0.05	0.1491	\$1,476.43
51	2066	0.2003	5,129	\$1,027	488	\$98	4,285	\$858	9,902	\$1,983	0.05	0.1503	\$1,487.84
52	2067	0.2014	5,129	\$1,033	488	\$98	4,285	\$863	9,902	\$1,994	0.05	0.1514	\$1,499.31
53	2068	0.2026	5,129	\$1,039	488	\$99	4,285	\$868	9,902	\$2,006	0.05	0.1526	\$1,510.84
54	2069	0.2038	5,129	\$1,045	488	\$99	4,285	\$873	9,902	\$2,018	0.05	0.1538	\$1,522.45
55	2070	0.2049	5,129	\$1,051	488	\$100	4,285	\$878	9,902	\$2,029	0.05	0.1549	\$1,534.12
56	2071	0.2061	5,129	\$1,057	488	\$101	4,285	\$883	9,902	\$2,041	0.05	0.1561	\$1,545.86
57	2072	0.2073	5,129	\$1,063	488	\$101	4,285	\$888	9,902	\$2,053	0.05	0.1573	\$1,557.66
58	2073	0.2085	5,129	\$1,069	488	\$102	4,285	\$893	9,902	\$2,065	0.05	0.1585	\$1,569.54
59	2074	0.2097	5,129	\$1,076	488	\$102	4,285	\$899	9,902	\$2,077	0.05	0.1597	\$1,581.48
60	2075	0.2109	5,129	\$1,082	488	\$103	4,285	\$904	9,902	\$2,089	0.05	0.1609	\$1,593.50

Table D1-1.11: Annual Operating Costs (H.GSHP) of a 2,000 square feet detached house above grade (average construction type) in the city of Hamilton (two life cycles and three life cycles for a 60 year project lifespan); base case scenario in comparison with feed in-tariff (FIT) scenario. In the FIT scenario, an incentive of \$0.05/KWh is provided on electricity bills throughout the project lifespan

Traditional HVAC Applications

Base Case Scenario															Carbon Taxes								
#	Year	Electricity Rates	Natural Gas Rates	Traditional											Carbon Taxes								
				Heating		Heating Operating Cost	Heating Operating Cost	Total Heating Operating Cost	Cooling		Cooling Operating Cost	Hot Water	Hot Water Operating Cost	Total	Total	Total Electricity Operating Cost	Total Natural Gas Operating Cost	Total	Conversion of m ³ into Tons	Total Tons	Carbon Tax	Operating Costs	
				KWh (Electricity)	m ³ (Gas)				\$	\$													m ³
\$/KWh	\$/m ³	\$/KWh	\$/m ³	\$/KWh	\$/KWh	\$/KWh	\$/KWh	\$/KWh	\$/KWh	\$/KWh	\$/KWh	\$/KWh	\$/KWh	\$/KWh	\$/KWh	\$/KWh	\$/KWh	\$/KWh	\$/KWh	\$/KWh			
1	2016	0.1501	0.3458	1,492	2,509	\$224	\$668	\$1,092	2,073	\$311	1,030	\$356	3,565	3,539	535	\$1,224	\$1,224	\$1,759	6.41	6.41	\$10	\$64.06	\$1,822.99
2	2017	0.1542	0.3588	1,492	2,509	\$230	\$900	\$1,130	2,073	\$320	1,030	\$159	3,565	3,539	550	\$1,270	\$1,270	\$1,820	6.41	6.41	\$20	\$128.11	\$1,947.71
3	2018	0.1583	0.3718	1,492	2,509	\$236	\$933	\$1,169	2,073	\$328	1,030	\$163	3,565	3,539	564	\$1,316	\$1,316	\$1,880	6.41	6.41	\$30	\$192.17	\$2,072.43
4	2019	0.1625	0.3776	1,492	2,509	\$243	\$947	\$1,190	2,073	\$337	1,030	\$167	3,565	3,539	579	\$1,336	\$1,336	\$1,916	6.41	6.41	\$40	\$256.22	\$2,171.94
5	2020	0.1668	0.3841	1,492	2,509	\$249	\$964	\$1,213	2,073	\$346	1,030	\$172	3,565	3,539	595	\$1,359	\$1,359	\$1,954	6.41	6.41	\$50	\$320.28	\$2,274.15
6	2021	0.1621	0.3883	1,492	2,509	\$242	\$974	\$1,216	2,073	\$336	1,030	\$167	3,565	3,539	578	\$1,374	\$1,374	\$1,952	6.41	6.41	\$60	\$384.34	\$2,336.55
7	2022	0.1629	0.3929	1,492	2,509	\$243	\$986	\$1,229	2,073	\$338	1,030	\$168	3,565	3,539	581	\$1,390	\$1,390	\$1,971	6.41	6.41	\$70	\$448.39	\$2,419.67
8	2023	0.1639	0.3967	1,492	2,509	\$244	\$995	\$1,240	2,073	\$340	1,030	\$169	3,565	3,539	584	\$1,404	\$1,404	\$1,988	6.41	6.41	\$80	\$512.45	\$2,500.60
9	2024	0.1648	0.4005	1,492	2,509	\$246	\$1,005	\$1,251	2,073	\$342	1,030	\$170	3,565	3,539	588	\$1,417	\$1,417	\$2,005	6.41	6.41	\$90	\$576.50	\$2,581.53
10	2025	0.1656	0.4040	1,492	2,509	\$247	\$1,014	\$1,261	2,073	\$343	1,030	\$171	3,565	3,539	590	\$1,430	\$1,430	\$2,020	6.41	6.41	\$100	\$640.56	\$2,660.60
11	2026	0.1665	0.4070	1,492	2,509	\$248	\$1,021	\$1,270	2,073	\$345	1,030	\$172	3,565	3,539	594	\$1,441	\$1,441	\$2,034	6.41	6.41	\$110	\$704.61	\$2,738.82
12	2027	0.1674	0.4097	1,492	2,509	\$250	\$1,028	\$1,278	2,073	\$347	1,030	\$172	3,565	3,539	597	\$1,450	\$1,450	\$2,047	6.41	6.41	\$120	\$768.67	\$2,815.56
13	2028	0.1683	0.4124	1,492	2,509	\$251	\$1,035	\$1,286	2,073	\$349	1,030	\$173	3,565	3,539	600	\$1,459	\$1,459	\$2,059	6.41	6.41	\$130	\$832.73	\$2,892.05
14	2029	0.1692	0.4151	1,492	2,509	\$252	\$1,041	\$1,294	2,073	\$351	1,030	\$174	3,565	3,539	603	\$1,469	\$1,469	\$2,072	6.41	6.41	\$140	\$896.78	\$2,968.79
15	2030	0.1701	0.4170	1,492	2,509	\$254	\$1,046	\$1,300	2,073	\$353	1,030	\$175	3,565	3,539	606	\$1,476	\$1,476	\$2,082	6.41	6.41	\$150	\$960.84	\$3,044.95
16	2031	0.1704	0.4189	1,492	2,509	\$254	\$1,051	\$1,305	2,073	\$353	1,030	\$175	3,565	3,539	607	\$1,482	\$1,482	\$2,090	6.41	6.41	\$160	\$1,024.89	\$3,114.68
17	2032	0.1705	0.4204	1,492	2,509	\$254	\$1,055	\$1,309	2,073	\$353	1,030	\$176	3,565	3,539	608	\$1,488	\$1,488	\$2,096	6.41	6.41	\$170	\$1,088.95	\$3,184.66
18	2033	0.1707	0.4223	1,492	2,509	\$255	\$1,060	\$1,314	2,073	\$354	1,030	\$176	3,565	3,539	609	\$1,495	\$1,495	\$2,103	6.41	6.41	\$180	\$1,153.01	\$3,256.38
19	2034	0.1710	0.4246	1,492	2,509	\$255	\$1,065	\$1,321	2,073	\$355	1,030	\$176	3,565	3,539	610	\$1,503	\$1,503	\$2,113	6.41	6.41	\$190	\$1,217.06	\$3,329.59
20	2035	0.1713	0.4265	1,492	2,509	\$256	\$1,070	\$1,326	2,073	\$355	1,030	\$176	3,565	3,539	611	\$1,510	\$1,510	\$2,120	6.41	6.41	\$200	\$1,281.12	\$3,401.31
21	2036	0.1714	0.4288	1,492	2,509	\$256	\$1,076	\$1,332	2,073	\$355	1,030	\$177	3,565	3,539	611	\$1,518	\$1,518	\$2,129	6.41	6.41	\$210	\$1,345.17	\$3,474.01
22	2037	0.1717	0.4311	1,492	2,509	\$256	\$1,082	\$1,338	2,073	\$356	1,030	\$177	3,565	3,539	612	\$1,526	\$1,526	\$2,138	6.41	6.41	\$220	\$1,409.23	\$3,547.08
23	2038	0.1720	0.4331	1,492	2,509	\$257	\$1,087	\$1,343	2,073	\$356	1,030	\$177	3,565	3,539	613	\$1,533	\$1,533	\$2,146	6.41	6.41	\$230	\$1,473.29	\$3,618.93
24	2039	0.1722	0.4353	1,492	2,509	\$257	\$1,092	\$1,349	2,073	\$357	1,030	\$177	3,565	3,539	614	\$1,541	\$1,541	\$2,155	6.41	6.41	\$240	\$1,537.34	\$3,692.01
25	2040	0.1724	0.4376	1,492	2,509	\$257	\$1,098	\$1,355	2,073	\$357	1,030	\$178	3,565	3,539	614	\$1,549	\$1,549	\$2,163	6.41	6.41	\$250	\$1,601.40	\$3,764.70
26	2041	0.1734	0.4420	1,492	2,509	\$259	\$1,109	\$1,368	2,073	\$359	1,030	\$179	3,565	3,539	618	\$1,564	\$1,564	\$2,182	6.41	6.41	\$260	\$1,665.45	\$3,847.59
27	2042	0.1744	0.4463	1,492	2,509	\$260	\$1,120	\$1,380	2,073	\$361	1,030	\$180	3,565	3,539	622	\$1,580	\$1,580	\$2,201	6.41	6.41	\$270	\$1,729.51	\$3,930.64
28	2043	0.1754	0.4507	1,492	2,509	\$262	\$1,131	\$1,393	2,073	\$364	1,030	\$181	3,565	3,539	625	\$1,595	\$1,595	\$2,220	6.41	6.41	\$280	\$1,793.57	\$4,013.86
29	2044	0.1764	0.4552	1,492	2,509	\$263	\$1,142	\$1,405	2,073	\$366	1,030	\$182	3,565	3,539	629	\$1,611	\$1,611	\$2,240	6.41	6.41	\$290	\$1,857.62	\$4,097.26
30	2045	0.1774	0.4596	1,492	2,509	\$265	\$1,153	\$1,418	2,073	\$368	1,030	\$183	3,565	3,539	632	\$1,627	\$1,627	\$2,259	6.41	6.41	\$300	\$1,921.68	\$4,180.83
31	2046	0.1784	0.4642	1,492	2,509	\$266	\$1,165	\$1,431	2,073	\$370	1,030	\$184	3,565	3,539	636	\$1,643	\$1,643	\$2,279	6.41	6.41	\$310	\$1,985.73	\$4,264.59
32	2047	0.1795	0.4688	1,492	2,509	\$268	\$1,176	\$1,444	2,073	\$372	1,030	\$185	3,565	3,539	640	\$1,659	\$1,659	\$2,299	6.41	6.41	\$320	\$2,049.79	\$4,348.52
33	2048	0.1805	0.4734	1,492	2,509	\$269	\$1,188	\$1,457	2,073	\$374	1,030	\$186	3,565	3,539	644	\$1,675	\$1,675	\$2,319	6.41	6.41	\$330	\$2,113.84	\$4,432.63
34	2049	0.1816	0.4780	1,492	2,509	\$271	\$1,199	\$1,470	2,073	\$376	1,030	\$187	3,565	3,539	647	\$1,692	\$1,692	\$2,339	6.41	6.41	\$340	\$2,177.90	\$4,516.92
35	2050	0.1826	0.4828	1,492	2,509	\$272	\$1,211	\$1,484	2,073	\$379	1,030	\$188	3,565	3,539	651	\$1,708	\$1,708	\$2,359	6.41	6.41	\$350	\$2,241.96	\$4,601.40
36	2051	0.1837	0.4875	1,492	2,509	\$274	\$1,223	\$1,497	2,073	\$381	1,030	\$189	3,565	3,539	655	\$1,725	\$1,725	\$2,380	6.41	6.41	\$360	\$2,306.01	\$4,686.07
37	2052	0.1847	0.4923	1,492	2,509	\$276	\$1,235	\$1,511	2,073	\$383	1,030	\$190	3,565	3,539	659	\$1,742	\$1,742	\$2,401	6.41	6.41	\$370	\$2,370.07	\$4,770.92
38	2053	0.1858	0.4972	1,492	2,509	\$277	\$1,247	\$1,525	2,073	\$385	1,030	\$191	3,565	3,539	662	\$1,760	\$1,760	\$2,422	6.41	6.41	\$380	\$2,434.12	\$4,855.97
39	2054	0.1869	0.5021	1,492	2,509	\$279	\$1,260	\$1,539	2,073	\$387	1,030	\$192	3,565	3,539	666	\$1,777	\$1,777	\$2,443	6.41	6.41	\$390	\$2,498.18	\$4,941.20
40	2055	0.1879	0.5070	1,492	2,509	\$280	\$1,272	\$1,553	2,073	\$390	1,030	\$194	3,565	3,539	670	\$1,794	\$1,794	\$2,464	6.41	6.41	\$400	\$2,562.24	\$5,026.63
41	2056	0.1890	0.5120	1,492	2,509	\$282	\$1,285	\$1,567	2,073	\$392	1,030	\$195	3,565	3,539	674	\$1,812	\$1,812	\$2,486	6.41	6.41	\$410	\$2,626.29	\$5,112.25
42	2057	0.1901	0.5171	1,492	2,509	\$284	\$1,297	\$1,581	2,073	\$394	1,030	\$196	3,565	3,539	678	\$1,830	\$1,830	\$2,508	6.41	6.41	\$420	\$2,690.35	\$5,198.07
43	2058	0.1912	0.5222	1,492	2,509	\$285	\$1,310	\$1,595	2,073	\$396	1,030	\$197	3,565	3,539	682	\$1,848	\$1,848	\$2,530	6.41	6.41	\$430	\$2,754.40	\$5,284.09
44	2059	0.1923	0.5273	1,492	2,509	\$287	\$1,323	\$1,610	2,073	\$399	1,030	\$198	3,565	3,539	686	\$1,866	\$1,866	\$2,552	6.41	6.41	\$440	\$2,818.46	\$5,370.31
45	2060	0.1934	0.5325	1,492	2,509	\$289	\$1,336	\$1,625	2,073	\$401	1,030	\$199	3,565	3,539	690	\$1,885	\$1,885	\$2,574	6.41	6.41	\$450	\$2,882.52	\$5,456.73
46	2061	0.1946	0.5378	1,492	2,509	\$290	\$1,349	\$1,640	2,073	\$403	1,030	\$200	3,565	3,539	694	\$1,903	\$1,903	\$2,597	6.41	6.41	\$460	\$2,946.57	\$5,543.35
47	2062	0.1957	0.5431	1,492	2,509	\$292	\$1,363	\$1,655	2,073	\$406	1,030	\$202	3,565	3,539	698	\$1,922	\$1,922	\$2,620	6.41	6.41	\$470	\$3,010.63	\$5,630.18
48	2063	0.1968	0.5484	1,492	2,509	\$294	\$1,376	\$1,670	2,073	\$408	1,030	\$203	3,565	3,539	702	\$1,941	\$1,941	\$2,643	6.41	6.41	\$480	\$3,074.68	\$5,717.22
49	2064	0.1980	0.5538	1,492	2,509	\$295	\$1,390	\$1,685	2,073	\$410	1,030	\$204	3,565	3,539	706	\$1,960	\$1,960	\$2,666	6.41	6.41	\$490	\$3,138.74	\$5,804.47
50	2065	0.1991	0.5593	1,492	2,509	\$297	\$1,403	\$1,700	2,073	\$413	1,030												

5. Kingston (South) – Annual Operating Costs

Vertical Ground Source Heat Pump (V.GSHP)

Base Case Scenario												Feed in Tariff (FIT)		
#	Year	Electricity Rates		Heating		Cooling		Hot Water		Total	Total Operating Cost	FIT		
		\$/KWh	KWh	\$	KWh	\$	KWh	\$	Incentives (S/KWh)			S/KWh	Operating Cost	
1	2016	0.1501	5,720	\$858	303	\$45	4,228	\$635	10,251	\$1,538	0.05	0.1001	\$1,025.95	
2	2017	0.1542	5,720	\$882	303	\$47	4,228	\$652	10,251	\$1,581	0.05	0.1042	\$1,068.02	
3	2018	0.1583	5,720	\$905	303	\$48	4,228	\$669	10,251	\$1,623	0.05	0.1083	\$1,110.09	
4	2019	0.1625	5,720	\$930	303	\$49	4,228	\$687	10,251	\$1,666	0.05	0.1125	\$1,153.63	
5	2020	0.1668	5,720	\$954	303	\$51	4,228	\$705	10,251	\$1,710	0.05	0.1168	\$1,197.18	
6	2021	0.1621	5,720	\$927	303	\$49	4,228	\$686	10,251	\$1,662	0.05	0.1121	\$1,149.57	
7	2022	0.1629	5,720	\$932	303	\$49	4,228	\$689	10,251	\$1,670	0.05	0.1129	\$1,157.69	
8	2023	0.1639	5,720	\$937	303	\$50	4,228	\$693	10,251	\$1,680	0.05	0.1139	\$1,167.29	
9	2024	0.1648	5,720	\$943	303	\$50	4,228	\$697	10,251	\$1,689	0.05	0.1148	\$1,176.88	
10	2025	0.1656	5,720	\$947	303	\$50	4,228	\$700	10,251	\$1,698	0.05	0.1156	\$1,185.00	
11	2026	0.1665	5,720	\$953	303	\$50	4,228	\$704	10,251	\$1,707	0.05	0.1165	\$1,194.60	
12	2027	0.1674	5,720	\$958	303	\$51	4,228	\$708	10,251	\$1,716	0.05	0.1174	\$1,203.82	
13	2028	0.1683	5,720	\$962	303	\$51	4,228	\$711	10,251	\$1,725	0.05	0.1183	\$1,212.31	
14	2029	0.1692	5,720	\$968	303	\$51	4,228	\$715	10,251	\$1,734	0.05	0.1192	\$1,221.54	
15	2030	0.1701	5,720	\$973	303	\$52	4,228	\$719	10,251	\$1,744	0.05	0.1201	\$1,231.13	
16	2031	0.1704	5,720	\$974	303	\$52	4,228	\$720	10,251	\$1,746	0.05	0.1204	\$1,233.71	
17	2032	0.1705	5,720	\$975	303	\$52	4,228	\$721	10,251	\$1,748	0.05	0.1205	\$1,235.19	
18	2033	0.1707	5,720	\$977	303	\$52	4,228	\$722	10,251	\$1,750	0.05	0.1207	\$1,237.77	
19	2034	0.1710	5,720	\$978	303	\$52	4,228	\$723	10,251	\$1,753	0.05	0.1210	\$1,240.73	
20	2035	0.1713	5,720	\$980	303	\$52	4,228	\$724	10,251	\$1,756	0.05	0.1213	\$1,243.31	
21	2036	0.1714	5,720	\$981	303	\$52	4,228	\$725	10,251	\$1,757	0.05	0.1214	\$1,244.79	
22	2037	0.1717	5,720	\$982	303	\$52	4,228	\$726	10,251	\$1,760	0.05	0.1217	\$1,247.37	
23	2038	0.1720	5,720	\$984	303	\$52	4,228	\$727	10,251	\$1,763	0.05	0.1220	\$1,250.32	
24	2039	0.1722	5,720	\$985	303	\$52	4,228	\$728	10,251	\$1,765	0.05	0.1222	\$1,252.90	
25	2040	0.1724	5,720	\$986	303	\$52	4,228	\$729	10,251	\$1,767	0.05	0.1224	\$1,254.38	
26	2041	0.1734	5,720	\$992	303	\$53	4,228	\$733	10,251	\$1,777	0.05	0.1234	\$1,264.60	
27	2042	0.1744	5,720	\$997	303	\$53	4,228	\$737	10,251	\$1,787	0.05	0.1244	\$1,274.88	
28	2043	0.1754	5,720	\$1,003	303	\$53	4,228	\$741	10,251	\$1,798	0.05	0.1254	\$1,285.22	
29	2044	0.1764	5,720	\$1,009	303	\$53	4,228	\$746	10,251	\$1,808	0.05	0.1264	\$1,295.62	
30	2045	0.1774	5,720	\$1,015	303	\$54	4,228	\$750	10,251	\$1,819	0.05	0.1274	\$1,306.08	
31	2046	0.1784	5,720	\$1,021	303	\$54	4,228	\$754	10,251	\$1,829	0.05	0.1284	\$1,316.60	
32	2047	0.1795	5,720	\$1,027	303	\$54	4,228	\$759	10,251	\$1,840	0.05	0.1295	\$1,327.18	
33	2048	0.1805	5,720	\$1,032	303	\$55	4,228	\$763	10,251	\$1,850	0.05	0.1305	\$1,337.83	
34	2049	0.1816	5,720	\$1,038	303	\$55	4,228	\$768	10,251	\$1,861	0.05	0.1316	\$1,348.53	
35	2050	0.1826	5,720	\$1,044	303	\$55	4,228	\$772	10,251	\$1,872	0.05	0.1326	\$1,359.30	
36	2051	0.1837	5,720	\$1,051	303	\$56	4,228	\$777	10,251	\$1,883	0.05	0.1337	\$1,370.13	
37	2052	0.1847	5,720	\$1,057	303	\$56	4,228	\$781	10,251	\$1,894	0.05	0.1347	\$1,381.02	
38	2053	0.1858	5,720	\$1,063	303	\$56	4,228	\$786	10,251	\$1,905	0.05	0.1358	\$1,391.97	
39	2054	0.1869	5,720	\$1,069	303	\$57	4,228	\$790	10,251	\$1,916	0.05	0.1369	\$1,402.99	
40	2055	0.1879	5,720	\$1,075	303	\$57	4,228	\$795	10,251	\$1,927	0.05	0.1379	\$1,414.07	
41	2056	0.1890	5,720	\$1,081	303	\$57	4,228	\$799	10,251	\$1,938	0.05	0.1390	\$1,425.21	
42	2057	0.1901	5,720	\$1,088	303	\$58	4,228	\$804	10,251	\$1,949	0.05	0.1401	\$1,436.42	
43	2058	0.1912	5,720	\$1,094	303	\$58	4,228	\$808	10,251	\$1,960	0.05	0.1412	\$1,447.70	
44	2059	0.1923	5,720	\$1,100	303	\$58	4,228	\$813	10,251	\$1,972	0.05	0.1423	\$1,459.04	
45	2060	0.1934	5,720	\$1,106	303	\$59	4,228	\$818	10,251	\$1,983	0.05	0.1434	\$1,470.44	
46	2061	0.1946	5,720	\$1,113	303	\$59	4,228	\$823	10,251	\$1,994	0.05	0.1446	\$1,481.91	
47	2062	0.1957	5,720	\$1,119	303	\$59	4,228	\$827	10,251	\$2,006	0.05	0.1457	\$1,493.45	
48	2063	0.1968	5,720	\$1,126	303	\$60	4,228	\$832	10,251	\$2,018	0.05	0.1468	\$1,505.06	
49	2064	0.1980	5,720	\$1,132	303	\$60	4,228	\$837	10,251	\$2,029	0.05	0.1480	\$1,516.73	
50	2065	0.1991	5,720	\$1,139	303	\$60	4,228	\$842	10,251	\$2,041	0.05	0.1491	\$1,528.47	
51	2066	0.2003	5,720	\$1,145	303	\$61	4,228	\$847	10,251	\$2,053	0.05	0.1503	\$1,540.27	
52	2067	0.2014	5,720	\$1,152	303	\$61	4,228	\$852	10,251	\$2,065	0.05	0.1514	\$1,552.15	
53	2068	0.2026	5,720	\$1,159	303	\$61	4,228	\$857	10,251	\$2,077	0.05	0.1526	\$1,564.09	
54	2069	0.2038	5,720	\$1,165	303	\$62	4,228	\$861	10,251	\$2,089	0.05	0.1538	\$1,576.11	
55	2070	0.2049	5,720	\$1,172	303	\$62	4,228	\$866	10,251	\$2,101	0.05	0.1549	\$1,588.19	
56	2071	0.2061	5,720	\$1,179	303	\$62	4,228	\$871	10,251	\$2,113	0.05	0.1561	\$1,600.34	
57	2072	0.2073	5,720	\$1,186	303	\$63	4,228	\$876	10,251	\$2,125	0.05	0.1573	\$1,612.56	
58	2073	0.2085	5,720	\$1,193	303	\$63	4,228	\$882	10,251	\$2,137	0.05	0.1585	\$1,624.86	
59	2074	0.2097	5,720	\$1,200	303	\$64	4,228	\$887	10,251	\$2,150	0.05	0.1597	\$1,637.22	
60	2075	0.2109	5,720	\$1,207	303	\$64	4,228	\$892	10,251	\$2,162	0.05	0.1609	\$1,649.66	

Table D1-1.13: Annual Operating Costs (V.GSHP) of a 2,000 square feet detached house above grade (average construction type) in the city of Kingston (two life cycles and three life cycles for a 60 year project lifespan); base case scenario in comparison with feed in-tariff (FIT) scenario. In the FIT scenario, an incentive of \$0.05/KWh is provided on electricity bills throughout the project lifespan

Horizontal Ground Source Heat Pump (H.GSHP)

Base Case Scenario											Feed in Tariff (FIT)		
H.GSHP											FIT		
#	Year	Electricity Rates \$/KWh	Heating KWh	Heating Operating Cost \$	Cooling KWh	Cooling Operating Cost \$	Hot Water KWh	Hot Water Operating Cost \$	Total KWh	Total Operating Cost \$	Incentives (\$/KWh)	\$/KWh	Operating Cost
1	2016	0.1501	5,792	\$869	288	\$43	4,460	\$669	10,540	\$1,582	0.05	0.1001	\$1,054.87
2	2017	0.1542	5,792	\$893	288	\$44	4,460	\$688	10,540	\$1,625	0.05	0.1042	\$1,098.13
3	2018	0.1583	5,792	\$917	288	\$46	4,460	\$706	10,540	\$1,668	0.05	0.1083	\$1,141.38
4	2019	0.1625	5,792	\$941	288	\$47	4,460	\$725	10,540	\$1,713	0.05	0.1125	\$1,186.16
5	2020	0.1668	5,792	\$966	288	\$48	4,460	\$744	10,540	\$1,758	0.05	0.1168	\$1,230.93
6	2021	0.1621	5,792	\$939	288	\$47	4,460	\$723	10,540	\$1,709	0.05	0.1121	\$1,181.98
7	2022	0.1629	5,792	\$944	288	\$47	4,460	\$727	10,540	\$1,717	0.05	0.1129	\$1,190.33
8	2023	0.1639	5,792	\$949	288	\$47	4,460	\$731	10,540	\$1,727	0.05	0.1139	\$1,200.20
9	2024	0.1648	5,792	\$955	288	\$47	4,460	\$735	10,540	\$1,737	0.05	0.1148	\$1,210.06
10	2025	0.1656	5,792	\$959	288	\$48	4,460	\$739	10,540	\$1,745	0.05	0.1156	\$1,218.41
11	2026	0.1665	5,792	\$965	288	\$48	4,460	\$743	10,540	\$1,755	0.05	0.1165	\$1,228.28
12	2027	0.1674	5,792	\$970	288	\$48	4,460	\$747	10,540	\$1,765	0.05	0.1174	\$1,237.76
13	2028	0.1683	5,792	\$975	288	\$48	4,460	\$750	10,540	\$1,773	0.05	0.1183	\$1,246.49
14	2029	0.1692	5,792	\$980	288	\$49	4,460	\$754	10,540	\$1,783	0.05	0.1192	\$1,255.97
15	2030	0.1701	5,792	\$985	288	\$49	4,460	\$759	10,540	\$1,793	0.05	0.1201	\$1,265.84
16	2031	0.1704	5,792	\$987	288	\$49	4,460	\$760	10,540	\$1,795	0.05	0.1204	\$1,268.50
17	2032	0.1705	5,792	\$988	288	\$49	4,460	\$760	10,540	\$1,797	0.05	0.1205	\$1,270.01
18	2033	0.1707	5,792	\$989	288	\$49	4,460	\$762	10,540	\$1,800	0.05	0.1207	\$1,272.67
19	2034	0.1710	5,792	\$991	288	\$49	4,460	\$763	10,540	\$1,803	0.05	0.1210	\$1,275.71
20	2035	0.1713	5,792	\$992	288	\$49	4,460	\$764	10,540	\$1,805	0.05	0.1213	\$1,278.36
21	2036	0.1714	5,792	\$993	288	\$49	4,460	\$765	10,540	\$1,807	0.05	0.1214	\$1,279.88
22	2037	0.1717	5,792	\$994	288	\$49	4,460	\$766	10,540	\$1,810	0.05	0.1217	\$1,282.53
23	2038	0.1720	5,792	\$996	288	\$50	4,460	\$767	10,540	\$1,813	0.05	0.1220	\$1,285.57
24	2039	0.1722	5,792	\$998	288	\$50	4,460	\$768	10,540	\$1,815	0.05	0.1222	\$1,288.23
25	2040	0.1724	5,792	\$998	288	\$50	4,460	\$769	10,540	\$1,817	0.05	0.1224	\$1,289.74
26	2041	0.1734	5,792	\$1,004	288	\$50	4,460	\$773	10,540	\$1,827	0.05	0.1234	\$1,300.25
27	2042	0.1744	5,792	\$1,010	288	\$50	4,460	\$778	10,540	\$1,838	0.05	0.1244	\$1,310.82
28	2043	0.1754	5,792	\$1,016	288	\$51	4,460	\$782	10,540	\$1,848	0.05	0.1254	\$1,321.46
29	2044	0.1764	5,792	\$1,022	288	\$51	4,460	\$787	10,540	\$1,859	0.05	0.1264	\$1,332.15
30	2045	0.1774	5,792	\$1,028	288	\$51	4,460	\$791	10,540	\$1,870	0.05	0.1274	\$1,342.90
31	2046	0.1784	5,792	\$1,034	288	\$51	4,460	\$796	10,540	\$1,881	0.05	0.1284	\$1,353.72
32	2047	0.1795	5,792	\$1,039	288	\$52	4,460	\$800	10,540	\$1,892	0.05	0.1295	\$1,364.60
33	2048	0.1805	5,792	\$1,045	288	\$52	4,460	\$805	10,540	\$1,903	0.05	0.1305	\$1,375.54
34	2049	0.1816	5,792	\$1,052	288	\$52	4,460	\$810	10,540	\$1,914	0.05	0.1316	\$1,386.55
35	2050	0.1826	5,792	\$1,058	288	\$53	4,460	\$814	10,540	\$1,925	0.05	0.1326	\$1,397.62
36	2051	0.1837	5,792	\$1,064	288	\$53	4,460	\$819	10,540	\$1,936	0.05	0.1337	\$1,408.75
37	2052	0.1847	5,792	\$1,070	288	\$53	4,460	\$824	10,540	\$1,947	0.05	0.1347	\$1,419.95
38	2053	0.1858	5,792	\$1,076	288	\$54	4,460	\$829	10,540	\$1,958	0.05	0.1358	\$1,431.21
39	2054	0.1869	5,792	\$1,082	288	\$54	4,460	\$833	10,540	\$1,970	0.05	0.1369	\$1,442.54
40	2055	0.1879	5,792	\$1,089	288	\$54	4,460	\$838	10,540	\$1,981	0.05	0.1379	\$1,453.93
41	2056	0.1890	5,792	\$1,095	288	\$54	4,460	\$843	10,540	\$1,992	0.05	0.1390	\$1,465.39
42	2057	0.1901	5,792	\$1,101	288	\$55	4,460	\$848	10,540	\$2,004	0.05	0.1401	\$1,476.92
43	2058	0.1912	5,792	\$1,108	288	\$55	4,460	\$853	10,540	\$2,016	0.05	0.1412	\$1,488.51
44	2059	0.1923	5,792	\$1,114	288	\$55	4,460	\$858	10,540	\$2,027	0.05	0.1423	\$1,500.17
45	2060	0.1934	5,792	\$1,120	288	\$56	4,460	\$863	10,540	\$2,039	0.05	0.1434	\$1,511.90
46	2061	0.1946	5,792	\$1,127	288	\$56	4,460	\$868	10,540	\$2,051	0.05	0.1446	\$1,523.69
47	2062	0.1957	5,792	\$1,133	288	\$56	4,460	\$873	10,540	\$2,063	0.05	0.1457	\$1,535.56
48	2063	0.1968	5,792	\$1,140	288	\$57	4,460	\$878	10,540	\$2,074	0.05	0.1468	\$1,547.49
49	2064	0.1980	5,792	\$1,147	288	\$57	4,460	\$883	10,540	\$2,086	0.05	0.1480	\$1,559.49
50	2065	0.1991	5,792	\$1,153	288	\$57	4,460	\$888	10,540	\$2,099	0.05	0.1491	\$1,571.56
51	2066	0.2003	5,792	\$1,160	288	\$58	4,460	\$893	10,540	\$2,111	0.05	0.1503	\$1,583.70
52	2067	0.2014	5,792	\$1,167	288	\$58	4,460	\$898	10,540	\$2,123	0.05	0.1514	\$1,595.91
53	2068	0.2026	5,792	\$1,173	288	\$58	4,460	\$904	10,540	\$2,135	0.05	0.1526	\$1,608.19
54	2069	0.2038	5,792	\$1,180	288	\$59	4,460	\$909	10,540	\$2,148	0.05	0.1538	\$1,620.54
55	2070	0.2049	5,792	\$1,187	288	\$59	4,460	\$914	10,540	\$2,160	0.05	0.1549	\$1,632.96
56	2071	0.2061	5,792	\$1,194	288	\$59	4,460	\$919	10,540	\$2,172	0.05	0.1561	\$1,645.46
57	2072	0.2073	5,792	\$1,201	288	\$60	4,460	\$925	10,540	\$2,185	0.05	0.1573	\$1,658.03
58	2073	0.2085	5,792	\$1,208	288	\$60	4,460	\$930	10,540	\$2,198	0.05	0.1585	\$1,670.67
59	2074	0.2097	5,792	\$1,215	288	\$60	4,460	\$935	10,540	\$2,210	0.05	0.1597	\$1,683.38
60	2075	0.2109	5,792	\$1,222	288	\$61	4,460	\$941	10,540	\$2,223	0.05	0.1609	\$1,696.17

Table D1-1.14: Annual Operating Costs (H.GSHP) of a 2,000 square feet detached house above grade (average construction type) in the city of Kingston (two life cycles and three life cycles for a 60 year project lifespan); base case scenario in comparison with feed in-tariff (FIT) scenario. In the FIT scenario, an incentive of \$0.05/KWh is provided on electricity bills throughout the project lifespan

Traditional HVAC Applications

Base Case Scenario																Carbon Taxes						
#	Year	Traditional													Total	Conversion of m ³ into Tons	Total Tons	Carbon Tax	Operating Costs			
		Electricity Rates \$/KWh	Natural Gas Rates \$/m ³	Heating		Heating Operating Cost \$ (Electricity)	Heating Operating Cost \$ (Gas)	Total Heating Operating Cost \$	Cooling KWh	Cooling Operating Cost \$	Hot Water m ³	Hot Water Operating Cost \$	Total KWh	Total m ³						Total Electricity Operating Cost \$ (KWh)	Total Natural Gas Operating Cost \$ (m ³)	
				KWh (Electricity)	m ³ (Gas)																	
1	2016	0.1501	0.3458	1,840	2,726	\$276	\$943	\$1,219	1,413	\$212	1,054	\$365	3,253	3,780	488	\$1,307	\$1,795	6.84	6.84	\$10	\$68.42	\$1,863.88
2	2017	0.1542	0.3588	1,840	2,726	\$284	\$978	\$1,262	1,413	\$218	1,054	\$163	3,253	3,780	502	\$1,356	\$1,858	6.84	6.84	\$20	\$136.84	\$1,994.81
3	2018	0.1583	0.3718	1,840	2,726	\$291	\$1,014	\$1,305	1,413	\$224	1,054	\$167	3,253	3,780	515	\$1,406	\$1,920	6.84	6.84	\$30	\$205.25	\$2,125.74
4	2019	0.1625	0.3776	1,840	2,726	\$299	\$1,029	\$1,328	1,413	\$230	1,054	\$171	3,253	3,780	529	\$1,427	\$1,956	6.84	6.84	\$40	\$273.67	\$2,229.67
5	2020	0.1668	0.3841	1,840	2,726	\$307	\$1,047	\$1,354	1,413	\$236	1,054	\$176	3,253	3,780	543	\$1,452	\$1,994	6.84	6.84	\$50	\$342.09	\$2,336.49
6	2021	0.1621	0.3883	1,840	2,726	\$298	\$1,058	\$1,357	1,413	\$229	1,054	\$171	3,253	3,780	527	\$1,468	\$1,995	6.84	6.84	\$60	\$410.51	\$2,405.71
7	2022	0.1629	0.3929	1,840	2,726	\$300	\$1,071	\$1,371	1,413	\$230	1,054	\$172	3,253	3,780	530	\$1,485	\$2,015	6.84	6.84	\$70	\$478.93	\$2,494.06
8	2023	0.1639	0.3967	1,840	2,726	\$302	\$1,081	\$1,383	1,413	\$232	1,054	\$173	3,253	3,780	533	\$1,500	\$2,033	6.84	6.84	\$80	\$547.34	\$2,579.98
9	2024	0.1648	0.4005	1,840	2,726	\$303	\$1,092	\$1,395	1,413	\$233	1,054	\$174	3,253	3,780	536	\$1,514	\$2,050	6.84	6.84	\$90	\$615.76	\$2,665.90
10	2025	0.1656	0.4040	1,840	2,726	\$305	\$1,101	\$1,406	1,413	\$234	1,054	\$175	3,253	3,780	539	\$1,527	\$2,066	6.84	6.84	\$100	\$684.18	\$2,749.91
11	2026	0.1665	0.4070	1,840	2,726	\$306	\$1,110	\$1,416	1,413	\$235	1,054	\$176	3,253	3,780	542	\$1,539	\$2,080	6.84	6.84	\$110	\$752.60	\$2,832.94
12	2027	0.1674	0.4097	1,840	2,726	\$308	\$1,117	\$1,425	1,413	\$237	1,054	\$176	3,253	3,780	545	\$1,549	\$2,093	6.84	6.84	\$120	\$821.02	\$2,914.41
13	2028	0.1683	0.4124	1,840	2,726	\$310	\$1,124	\$1,434	1,413	\$238	1,054	\$177	3,253	3,780	547	\$1,559	\$2,106	6.84	6.84	\$130	\$889.43	\$2,995.64
14	2029	0.1692	0.4151	1,840	2,726	\$311	\$1,131	\$1,443	1,413	\$239	1,054	\$178	3,253	3,780	550	\$1,569	\$2,119	6.84	6.84	\$140	\$957.85	\$3,077.11
15	2030	0.1701	0.4170	1,840	2,726	\$313	\$1,137	\$1,450	1,413	\$240	1,054	\$179	3,253	3,780	553	\$1,576	\$2,130	6.84	6.84	\$150	\$1,026.27	\$3,155.81
16	2031	0.1704	0.4189	1,840	2,726	\$313	\$1,142	\$1,455	1,413	\$241	1,054	\$180	3,253	3,780	554	\$1,583	\$2,138	6.84	6.84	\$160	\$1,094.69	\$3,232.27
17	2032	0.1705	0.4204	1,840	2,726	\$314	\$1,146	\$1,460	1,413	\$241	1,054	\$180	3,253	3,780	555	\$1,589	\$2,144	6.84	6.84	\$170	\$1,163.11	\$3,306.94
18	2033	0.1707	0.4223	1,840	2,726	\$314	\$1,151	\$1,465	1,413	\$241	1,054	\$180	3,253	3,780	555	\$1,596	\$2,152	6.84	6.84	\$180	\$1,231.52	\$3,383.41
19	2034	0.1710	0.4246	1,840	2,726	\$315	\$1,158	\$1,472	1,413	\$242	1,054	\$180	3,253	3,780	556	\$1,605	\$2,162	6.84	6.84	\$190	\$1,299.94	\$3,461.44
20	2035	0.1713	0.4265	1,840	2,726	\$315	\$1,163	\$1,478	1,413	\$242	1,054	\$181	3,253	3,780	557	\$1,612	\$2,170	6.84	6.84	\$200	\$1,368.36	\$3,537.91
21	2036	0.1714	0.4288	1,840	2,726	\$315	\$1,169	\$1,484	1,413	\$242	1,054	\$181	3,253	3,780	558	\$1,621	\$2,179	6.84	6.84	\$210	\$1,436.78	\$3,615.47
22	2037	0.1717	0.4311	1,840	2,726	\$316	\$1,175	\$1,491	1,413	\$243	1,054	\$181	3,253	3,780	558	\$1,630	\$2,188	6.84	6.84	\$220	\$1,505.20	\$3,693.39
23	2038	0.1720	0.4331	1,840	2,726	\$316	\$1,181	\$1,497	1,413	\$243	1,054	\$181	3,253	3,780	559	\$1,637	\$2,196	6.84	6.84	\$230	\$1,573.61	\$3,769.97
24	2039	0.1722	0.4353	1,840	2,726	\$317	\$1,187	\$1,504	1,413	\$243	1,054	\$182	3,253	3,780	560	\$1,646	\$2,206	6.84	6.84	\$240	\$1,642.03	\$3,847.89
25	2040	0.1724	0.4376	1,840	2,726	\$317	\$1,193	\$1,510	1,413	\$244	1,054	\$182	3,253	3,780	561	\$1,654	\$2,215	6.84	6.84	\$250	\$1,710.45	\$3,925.45
26	2041	0.1734	0.4420	1,840	2,726	\$319	\$1,205	\$1,524	1,413	\$245	1,054	\$183	3,253	3,780	564	\$1,671	\$2,235	6.84	6.84	\$260	\$1,778.87	\$4,003.42
27	2042	0.1744	0.4463	1,840	2,726	\$321	\$1,217	\$1,537	1,413	\$246	1,054	\$184	3,253	3,780	567	\$1,687	\$2,254	6.84	6.84	\$270	\$1,847.29	\$4,101.57
28	2043	0.1754	0.4507	1,840	2,726	\$323	\$1,229	\$1,551	1,413	\$248	1,054	\$185	3,253	3,780	570	\$1,704	\$2,274	6.84	6.84	\$280	\$1,915.70	\$4,189.91
29	2044	0.1764	0.4552	1,840	2,726	\$325	\$1,241	\$1,565	1,413	\$249	1,054	\$186	3,253	3,780	574	\$1,721	\$2,294	6.84	6.84	\$290	\$1,984.12	\$4,278.42
30	2045	0.1774	0.4596	1,840	2,726	\$326	\$1,253	\$1,579	1,413	\$251	1,054	\$187	3,253	3,780	577	\$1,737	\$2,315	6.84	6.84	\$300	\$2,052.54	\$4,367.12
31	2046	0.1784	0.4642	1,840	2,726	\$328	\$1,265	\$1,594	1,413	\$252	1,054	\$188	3,253	3,780	580	\$1,755	\$2,335	6.84	6.84	\$310	\$2,120.96	\$4,456.01
32	2047	0.1795	0.4688	1,840	2,726	\$330	\$1,278	\$1,608	1,413	\$254	1,054	\$189	3,253	3,780	584	\$1,772	\$2,356	6.84	6.84	\$320	\$2,189.38	\$4,545.08
33	2048	0.1805	0.4734	1,840	2,726	\$332	\$1,290	\$1,623	1,413	\$255	1,054	\$189	3,253	3,780	587	\$1,789	\$2,377	6.84	6.84	\$330	\$2,257.79	\$4,634.34
34	2049	0.1816	0.4780	1,840	2,726	\$334	\$1,303	\$1,637	1,413	\$257	1,054	\$191	3,253	3,780	591	\$1,807	\$2,398	6.84	6.84	\$340	\$2,326.21	\$4,723.80
35	2050	0.1826	0.4828	1,840	2,726	\$336	\$1,316	\$1,652	1,413	\$258	1,054	\$192	3,253	3,780	594	\$1,825	\$2,419	6.84	6.84	\$350	\$2,394.63	\$4,813.45
36	2051	0.1837	0.4875	1,840	2,726	\$338	\$1,329	\$1,667	1,413	\$260	1,054	\$194	3,253	3,780	597	\$1,843	\$2,440	6.84	6.84	\$360	\$2,463.05	\$4,903.30
37	2052	0.1847	0.4923	1,840	2,726	\$340	\$1,342	\$1,682	1,413	\$261	1,054	\$195	3,253	3,780	601	\$1,861	\$2,462	6.84	6.84	\$370	\$2,531.47	\$4,993.34
38	2053	0.1858	0.4972	1,840	2,726	\$342	\$1,355	\$1,697	1,413	\$263	1,054	\$196	3,253	3,780	604	\$1,879	\$2,484	6.84	6.84	\$380	\$2,599.88	\$5,083.58
39	2054	0.1869	0.5021	1,840	2,726	\$344	\$1,369	\$1,712	1,413	\$264	1,054	\$197	3,253	3,780	608	\$1,898	\$2,506	6.84	6.84	\$390	\$2,668.30	\$5,174.02
40	2055	0.1879	0.5070	1,840	2,726	\$346	\$1,382	\$1,728	1,413	\$266	1,054	\$198	3,253	3,780	611	\$1,917	\$2,528	6.84	6.84	\$400	\$2,736.72	\$5,264.67
41	2056	0.1890	0.5120	1,840	2,726	\$348	\$1,396	\$1,744	1,413	\$267	1,054	\$199	3,253	3,780	615	\$1,935	\$2,550	6.84	6.84	\$410	\$2,805.14	\$5,355.52
42	2057	0.1901	0.5171	1,840	2,726	\$350	\$1,410	\$1,759	1,413	\$269	1,054	\$200	3,253	3,780	618	\$1,955	\$2,573	6.84	6.84	\$420	\$2,873.56	\$5,446.57
43	2058	0.1912	0.5222	1,840	2,726	\$352	\$1,423	\$1,775	1,413	\$270	1,054	\$202	3,253	3,780	622	\$1,974	\$2,596	6.84	6.84	\$430	\$2,941.97	\$5,537.84
44	2059	0.1923	0.5273	1,840	2,726	\$354	\$1,437	\$1,791	1,413	\$272	1,054	\$203	3,253	3,780	626	\$1,993	\$2,619	6.84	6.84	\$440	\$3,010.39	\$5,629.32
45	2060	0.1934	0.5325	1,840	2,726	\$356	\$1,452	\$1,808	1,413	\$273	1,054	\$204	3,253	3,780	629	\$2,013	\$2,642	6.84	6.84	\$450	\$3,078.81	\$5,721.00
46	2061	0.1946	0.5378	1,840	2,726	\$358	\$1,466	\$1,824	1,413	\$275	1,054	\$205	3,253	3,780	633	\$2,033	\$2,666	6.84	6.84	\$460	\$3,147.23	\$5,812.91
47	2062	0.1957	0.5431	1,840	2,726	\$360	\$1,480	\$1,840	1,413	\$277	1,054	\$206	3,253	3,780	637	\$2,053	\$2,689	6.84	6.84	\$470	\$3,215.65	\$5,905.03
48	2063	0.1968	0.5484	1,840	2,726	\$362	\$1,495	\$1,857	1,413	\$278	1,054	\$207	3,253	3,780	640	\$2,073	\$2,713	6.84	6.84	\$480	\$3,284.06	\$5,997.37
49	2064	0.1980	0.5538	1,840	2,726	\$364	\$1,510	\$1,874	1,413	\$280	1,054	\$209	3,253	3,780	644	\$2,093	\$2,737	6.84	6.84	\$490	\$3,352.48	\$6,089.93
50	2065	0.1991	0.5593	1,840	2,726	\$366	\$1,525	\$1,891	1,413	\$281	1,054	\$210	3,253	3,780	648	\$2,114	\$2,762	6.84	6.84	\$500	\$3,420.90	\$6,182.71
51	2066	0.2003	0.5648	1,840	2,726	\$368	\$1,540	\$1,908	1,413	\$283	1,054	\$211	3,253	3,780	651	\$2,135	\$2,786	6.84	6.84	\$510	\$3,489.32	\$6,275.72
52	2067	0.2014	0.5704	1,840	2,726	\$371	\$1,555	\$1,925	1,413	\$285	1,054	\$212	3,253	3,780	655	\$2,156	\$2,811	6.84	6.84	\$520	\$3,557.74	\$6,368.95
53	2068	0.2026	0.5760	1,840	2,726	\$373	\$1,570	\$1,943	1,413	\$286	1,054	\$214</										

6. Kitchener-Waterloo (South) – Annual Operating Costs

Vertical Ground Source Heat Pump (V.GSHP)

Base Case Scenario											Feed in Tariff (FIT)		
V.GSHP													
#	Year	Electricity Rates \$/KWh	Heating KWh	Heating Operating Cost \$	Cooling KWh	Cooling Operating Cost \$	Hot Water KWh	Hot Water Operating Cost \$	Total KWh	Total Operating Cost \$	FIT \$/KWh	Operating Cost \$	
1	2016	0.1501	5,632	\$845	458	\$69	3,982	\$598	10,072	\$1,512	0.05	\$1,008.03	
2	2017	0.1542	5,632	\$868	458	\$71	3,982	\$614	10,072	\$1,553	0.05	\$1,049.37	
3	2018	0.1583	5,632	\$891	458	\$72	3,982	\$630	10,072	\$1,594	0.05	\$1,090.70	
4	2019	0.1625	5,632	\$915	458	\$74	3,982	\$647	10,072	\$1,637	0.05	\$1,133.49	
5	2020	0.1668	5,632	\$939	458	\$76	3,982	\$664	10,072	\$1,680	0.05	\$1,176.28	
6	2021	0.1621	5,632	\$913	458	\$74	3,982	\$646	10,072	\$1,633	0.05	\$1,129.50	
7	2022	0.1629	5,632	\$918	458	\$75	3,982	\$649	10,072	\$1,641	0.05	\$1,137.48	
8	2023	0.1639	5,632	\$923	458	\$75	3,982	\$653	10,072	\$1,651	0.05	\$1,146.91	
9	2024	0.1648	5,632	\$928	458	\$75	3,982	\$656	10,072	\$1,660	0.05	\$1,156.33	
10	2025	0.1656	5,632	\$933	458	\$76	3,982	\$659	10,072	\$1,668	0.05	\$1,164.31	
11	2026	0.1665	5,632	\$938	458	\$76	3,982	\$663	10,072	\$1,677	0.05	\$1,173.74	
12	2027	0.1674	5,632	\$943	458	\$77	3,982	\$667	10,072	\$1,686	0.05	\$1,182.80	
13	2028	0.1683	5,632	\$948	458	\$77	3,982	\$670	10,072	\$1,695	0.05	\$1,191.14	
14	2029	0.1692	5,632	\$953	458	\$77	3,982	\$674	10,072	\$1,704	0.05	\$1,199.21	
15	2030	0.1701	5,632	\$958	458	\$78	3,982	\$677	10,072	\$1,713	0.05	\$1,209.63	
16	2031	0.1704	5,632	\$959	458	\$78	3,982	\$678	10,072	\$1,716	0.05	\$1,212.17	
17	2032	0.1705	5,632	\$960	458	\$78	3,982	\$679	10,072	\$1,717	0.05	\$1,213.62	
18	2033	0.1707	5,632	\$962	458	\$78	3,982	\$680	10,072	\$1,720	0.05	\$1,216.16	
19	2034	0.1710	5,632	\$963	458	\$78	3,982	\$681	10,072	\$1,723	0.05	\$1,219.06	
20	2035	0.1713	5,632	\$965	458	\$78	3,982	\$682	10,072	\$1,725	0.05	\$1,221.60	
21	2036	0.1714	5,632	\$965	458	\$79	3,982	\$683	10,072	\$1,727	0.05	\$1,223.05	
22	2037	0.1717	5,632	\$967	458	\$79	3,982	\$684	10,072	\$1,729	0.05	\$1,225.59	
23	2038	0.1720	5,632	\$969	458	\$79	3,982	\$685	10,072	\$1,732	0.05	\$1,228.49	
24	2039	0.1722	5,632	\$970	458	\$79	3,982	\$686	10,072	\$1,735	0.05	\$1,231.03	
25	2040	0.1724	5,632	\$971	458	\$79	3,982	\$686	10,072	\$1,736	0.05	\$1,232.48	
26	2041	0.1734	5,632	\$976	458	\$79	3,982	\$690	10,072	\$1,746	0.05	\$1,242.52	
27	2042	0.1744	5,632	\$982	458	\$80	3,982	\$694	10,072	\$1,756	0.05	\$1,252.62	
28	2043	0.1754	5,632	\$988	458	\$80	3,982	\$698	10,072	\$1,766	0.05	\$1,262.78	
29	2044	0.1764	5,632	\$993	458	\$81	3,982	\$702	10,072	\$1,777	0.05	\$1,273.00	
30	2045	0.1774	5,632	\$999	458	\$81	3,982	\$706	10,072	\$1,787	0.05	\$1,283.28	
31	2046	0.1805	5,632	\$1,005	458	\$82	3,982	\$711	10,072	\$1,797	0.05	\$1,284.61	
32	2047	0.1795	5,632	\$1,011	458	\$82	3,982	\$715	10,072	\$1,808	0.05	\$1,304.01	
33	2048	0.1805	5,632	\$1,017	458	\$83	3,982	\$719	10,072	\$1,818	0.05	\$1,314.47	
34	2049	0.1816	5,632	\$1,022	458	\$83	3,982	\$723	10,072	\$1,829	0.05	\$1,324.98	
35	2050	0.1826	5,632	\$1,028	458	\$84	3,982	\$727	10,072	\$1,839	0.05	\$1,335.56	
36	2051	0.1837	5,632	\$1,034	458	\$84	3,982	\$731	10,072	\$1,850	0.05	\$1,346.20	
37	2052	0.1847	5,632	\$1,040	458	\$85	3,982	\$736	10,072	\$1,861	0.05	\$1,356.90	
38	2053	0.1858	5,632	\$1,046	458	\$85	3,982	\$740	10,072	\$1,871	0.05	\$1,367.66	
39	2054	0.1869	5,632	\$1,052	458	\$86	3,982	\$744	10,072	\$1,882	0.05	\$1,378.49	
40	2055	0.1879	5,632	\$1,059	458	\$86	3,982	\$748	10,072	\$1,893	0.05	\$1,389.38	
41	2056	0.1890	5,632	\$1,065	458	\$87	3,982	\$753	10,072	\$1,904	0.05	\$1,400.33	
42	2057	0.1901	5,632	\$1,071	458	\$87	3,982	\$757	10,072	\$1,915	0.05	\$1,411.34	
43	2058	0.1912	5,632	\$1,077	458	\$88	3,982	\$761	10,072	\$1,926	0.05	\$1,422.42	
44	2059	0.1923	5,632	\$1,083	458	\$88	3,982	\$766	10,072	\$1,937	0.05	\$1,433.56	
45	2060	0.1934	5,632	\$1,089	458	\$89	3,982	\$770	10,072	\$1,948	0.05	\$1,444.77	
46	2061	0.1946	5,632	\$1,096	458	\$89	3,982	\$775	10,072	\$1,960	0.05	\$1,456.04	
47	2062	0.1957	5,632	\$1,102	458	\$90	3,982	\$779	10,072	\$1,971	0.05	\$1,467.37	
48	2063	0.1968	5,632	\$1,108	458	\$90	3,982	\$784	10,072	\$1,982	0.05	\$1,478.78	
49	2064	0.1980	5,632	\$1,115	458	\$91	3,982	\$788	10,072	\$1,994	0.05	\$1,490.24	
50	2065	0.1991	5,632	\$1,121	458	\$91	3,982	\$793	10,072	\$2,005	0.05	\$1,501.78	
51	2066	0.2003	5,632	\$1,128	458	\$92	3,982	\$797	10,072	\$2,017	0.05	\$1,513.38	
52	2067	0.2014	5,632	\$1,134	458	\$92	3,982	\$802	10,072	\$2,029	0.05	\$1,525.05	
53	2068	0.2026	5,632	\$1,141	458	\$93	3,982	\$807	10,072	\$2,040	0.05	\$1,536.78	
54	2069	0.2038	5,632	\$1,148	458	\$93	3,982	\$811	10,072	\$2,052	0.05	\$1,548.59	
55	2070	0.2049	5,632	\$1,154	458	\$94	3,982	\$816	10,072	\$2,064	0.05	\$1,560.46	
56	2071	0.2061	5,632	\$1,161	458	\$94	3,982	\$821	10,072	\$2,076	0.05	\$1,572.40	
57	2072	0.2073	5,632	\$1,168	458	\$95	3,982	\$826	10,072	\$2,088	0.05	\$1,584.41	
58	2073	0.2085	5,632	\$1,174	458	\$95	3,982	\$830	10,072	\$2,100	0.05	\$1,596.49	
59	2074	0.2097	5,632	\$1,181	458	\$96	3,982	\$835	10,072	\$2,112	0.05	\$1,608.63	
60	2075	0.2109	5,632	\$1,188	458	\$97	3,982	\$840	10,072	\$2,124	0.05	\$1,620.85	

Table D1-1.16: Annual Operating Costs (V.GSHP) of a 2,000 square feet detached house above grade (average construction type) in the city of Kitchener-Waterloo (two life cycles and three life cycles for a 60 year project lifespan); base case scenario in comparison with feed in-tariff (FIT) scenario. In the FIT scenario, an incentive of \$0.05/KWh is provided on electricity bills throughout the project lifespan

Horizontal Ground Source Heat Pump (H.GSHP)

Base Case Scenario												Feed in Tariff (FIT)		
H.GSHP												FIT		
#	Year	Electricity Rates \$/KWh	Heating KWh	Heating Operating Cost \$	Cooling KWh	Cooling Operating Cost \$	Hot Water KWh	Hot Water Operating Cost \$	Total KWh	Total Operating Cost \$	Incentives (\$/KWh)	Operating Cost		
1	2016	0.1501	5,712	\$857	421	\$63	4,199	\$630	10,332	\$1,551	0.05	\$1,034.06		
2	2017	0.1542	5,712	\$881	421	\$65	4,199	\$647	10,332	\$1,593	0.05	\$1,076.46		
3	2018	0.1583	5,712	\$904	421	\$67	4,199	\$665	10,332	\$1,635	0.05	\$1,118.86		
4	2019	0.1625	5,712	\$928	421	\$68	4,199	\$683	10,332	\$1,679	0.05	\$1,162.75		
5	2020	0.1668	5,712	\$953	421	\$70	4,199	\$700	10,332	\$1,723	0.05	\$1,206.64		
6	2021	0.1621	5,712	\$926	421	\$68	4,199	\$681	10,332	\$1,675	0.05	\$1,158.66		
7	2022	0.1629	5,712	\$931	421	\$69	4,199	\$684	10,332	\$1,683	0.05	\$1,166.84		
8	2023	0.1639	5,712	\$936	421	\$69	4,199	\$688	10,332	\$1,693	0.05	\$1,176.51		
9	2024	0.1648	5,712	\$941	421	\$69	4,199	\$692	10,332	\$1,703	0.05	\$1,186.18		
10	2025	0.1656	5,712	\$946	421	\$70	4,199	\$695	10,332	\$1,711	0.05	\$1,194.37		
11	2026	0.1665	5,712	\$951	421	\$70	4,199	\$699	10,332	\$1,721	0.05	\$1,204.04		
12	2027	0.1674	5,712	\$956	421	\$70	4,199	\$703	10,332	\$1,730	0.05	\$1,213.33		
13	2028	0.1683	5,712	\$961	421	\$71	4,199	\$707	10,332	\$1,738	0.05	\$1,221.89		
14	2029	0.1692	5,712	\$966	421	\$71	4,199	\$710	10,332	\$1,748	0.05	\$1,231.19		
15	2030	0.1701	5,712	\$972	421	\$72	4,199	\$714	10,332	\$1,757	0.05	\$1,240.86		
16	2031	0.1704	5,712	\$973	421	\$72	4,199	\$715	10,332	\$1,760	0.05	\$1,243.46		
17	2032	0.1705	5,712	\$974	421	\$72	4,199	\$716	10,332	\$1,762	0.05	\$1,244.95		
18	2033	0.1707	5,712	\$975	421	\$72	4,199	\$717	10,332	\$1,764	0.05	\$1,247.55		
19	2034	0.1710	5,712	\$977	421	\$72	4,199	\$718	10,332	\$1,767	0.05	\$1,250.53		
20	2035	0.1713	5,712	\$978	421	\$72	4,199	\$719	10,332	\$1,770	0.05	\$1,253.13		
21	2036	0.1714	5,712	\$979	421	\$72	4,199	\$720	10,332	\$1,771	0.05	\$1,254.62		
22	2037	0.1717	5,712	\$981	421	\$72	4,199	\$721	10,332	\$1,774	0.05	\$1,257.22		
23	2038	0.1720	5,712	\$982	421	\$72	4,199	\$722	10,332	\$1,777	0.05	\$1,260.20		
24	2039	0.1722	5,712	\$984	421	\$73	4,199	\$723	10,332	\$1,779	0.05	\$1,262.80		
25	2040	0.1724	5,712	\$985	421	\$73	4,199	\$724	10,332	\$1,781	0.05	\$1,264.29		
26	2041	0.1734	5,712	\$990	421	\$73	4,199	\$728	10,332	\$1,791	0.05	\$1,274.59		
27	2042	0.1744	5,712	\$996	421	\$73	4,199	\$732	10,332	\$1,802	0.05	\$1,284.96		
28	2043	0.1754	5,712	\$1,002	421	\$74	4,199	\$736	10,332	\$1,812	0.05	\$1,295.38		
29	2044	0.1764	5,712	\$1,008	421	\$74	4,199	\$741	10,332	\$1,822	0.05	\$1,305.86		
30	2045	0.1774	5,712	\$1,013	421	\$75	4,199	\$745	10,332	\$1,833	0.05	\$1,316.40		
31	2046	0.1784	5,712	\$1,019	421	\$75	4,199	\$749	10,332	\$1,844	0.05	\$1,327.01		
32	2047	0.1795	5,712	\$1,025	421	\$76	4,199	\$754	10,332	\$1,854	0.05	\$1,337.67		
33	2048	0.1805	5,712	\$1,031	421	\$76	4,199	\$758	10,332	\$1,865	0.05	\$1,348.40		
34	2049	0.1816	5,712	\$1,037	421	\$76	4,199	\$762	10,332	\$1,876	0.05	\$1,359.19		
35	2050	0.1826	5,712	\$1,043	421	\$77	4,199	\$767	10,332	\$1,887	0.05	\$1,370.04		
36	2051	0.1837	5,712	\$1,049	421	\$77	4,199	\$771	10,332	\$1,898	0.05	\$1,380.95		
37	2052	0.1847	5,712	\$1,055	421	\$78	4,199	\$776	10,332	\$1,909	0.05	\$1,391.93		
38	2053	0.1858	5,712	\$1,061	421	\$78	4,199	\$780	10,332	\$1,920	0.05	\$1,402.97		
39	2054	0.1869	5,712	\$1,067	421	\$79	4,199	\$785	10,332	\$1,931	0.05	\$1,414.07		
40	2055	0.1879	5,712	\$1,074	421	\$79	4,199	\$789	10,332	\$1,942	0.05	\$1,425.24		
41	2056	0.1890	5,712	\$1,080	421	\$80	4,199	\$794	10,332	\$1,953	0.05	\$1,436.48		
42	2057	0.1901	5,712	\$1,086	421	\$80	4,199	\$798	10,332	\$1,964	0.05	\$1,447.77		
43	2058	0.1912	5,712	\$1,092	421	\$81	4,199	\$803	10,332	\$1,976	0.05	\$1,459.14		
44	2059	0.1923	5,712	\$1,099	421	\$81	4,199	\$808	10,332	\$1,987	0.05	\$1,470.57		
45	2060	0.1934	5,712	\$1,105	421	\$81	4,199	\$812	10,332	\$1,999	0.05	\$1,482.06		
46	2061	0.1946	5,712	\$1,111	421	\$82	4,199	\$817	10,332	\$2,010	0.05	\$1,493.62		
47	2062	0.1957	5,712	\$1,118	421	\$82	4,199	\$822	10,332	\$2,022	0.05	\$1,505.25		
48	2063	0.1968	5,712	\$1,124	421	\$83	4,199	\$826	10,332	\$2,034	0.05	\$1,516.95		
49	2064	0.1980	5,712	\$1,131	421	\$83	4,199	\$831	10,332	\$2,045	0.05	\$1,528.71		
50	2065	0.1991	5,712	\$1,137	421	\$84	4,199	\$836	10,332	\$2,057	0.05	\$1,540.55		
51	2066	0.2003	5,712	\$1,144	421	\$84	4,199	\$841	10,332	\$2,069	0.05	\$1,552.45		
52	2067	0.2014	5,712	\$1,150	421	\$85	4,199	\$846	10,332	\$2,081	0.05	\$1,564.41		
53	2068	0.2026	5,712	\$1,157	421	\$85	4,199	\$851	10,332	\$2,093	0.05	\$1,576.45		
54	2069	0.2038	5,712	\$1,164	421	\$86	4,199	\$856	10,332	\$2,105	0.05	\$1,588.56		
55	2070	0.2049	5,712	\$1,171	421	\$86	4,199	\$861	10,332	\$2,117	0.05	\$1,600.74		
56	2071	0.2061	5,712	\$1,177	421	\$87	4,199	\$865	10,332	\$2,130	0.05	\$1,612.99		
57	2072	0.2073	5,712	\$1,184	421	\$87	4,199	\$870	10,332	\$2,142	0.05	\$1,625.31		
58	2073	0.2085	5,712	\$1,191	421	\$88	4,199	\$876	10,332	\$2,154	0.05	\$1,637.70		
59	2074	0.2097	5,712	\$1,198	421	\$88	4,199	\$881	10,332	\$2,167	0.05	\$1,650.16		
60	2075	0.2109	5,712	\$1,205	421	\$89	4,199	\$886	10,332	\$2,179	0.05	\$1,662.69		

Table D1-1.17: Annual Operating Costs (H.GSHP) of a 2,000 square feet detached house above grade (average construction type) in the city of Kitchener-Waterloo (two life cycles and three life cycles for a 60 year project lifespan); base case scenario in comparison with feed in-tariff (FIT) scenario. In the FIT scenario, an incentive of \$0.05/KWh is provided on electricity bills throughout the project lifespan

Traditional HVAC Applications

Base Case Scenario																Carbon Taxes						
#	Year	Electricity Rates \$/KWh	Natural Gas Rates \$/m ³	Heating		Heating Operating Cost \$ (Electricity)	Heating Operating Cost \$ (Gas)	Total Heating Operating Cost \$	Cooling		Hot Water m ³	Hot Water Operating Cost \$	Total KWh	Total m ³	Total Electricity Operating Cost \$ (KWh)	Total Natural Gas Operating Cost \$ (m ³)	Total	Conversion of m ³ into Tons	Total Tons	Carbon Tax	Operating Costs	
				KWh (Electricity)	m ³ (Gas)				KWh	\$												
1	2016	0.1501	0.3458	1,625	2,726	\$244	\$943	\$1,187	1,834	\$275	1,036	\$358	3,459	3,762	519	\$1,301	\$1,820	6.81	6.81	\$10	\$68.09	\$1,888.24
2	2017	0.1542	0.3588	1,625	2,726	\$251	\$978	\$1,229	1,834	\$283	1,036	\$160	3,459	3,762	533	\$1,350	\$1,883	6.81	6.81	\$20	\$136.18	\$2,019.46
3	2018	0.1583	0.3718	1,625	2,726	\$257	\$1,014	\$1,271	1,834	\$290	1,036	\$164	3,459	3,762	548	\$1,399	\$1,946	6.81	6.81	\$30	\$204.28	\$2,150.68
4	2019	0.1625	0.3776	1,625	2,726	\$264	\$1,029	\$1,293	1,834	\$298	1,036	\$168	3,459	3,762	562	\$1,420	\$1,983	6.81	6.81	\$40	\$272.37	\$2,255.05
5	2020	0.1668	0.3841	1,625	2,726	\$271	\$1,047	\$1,318	1,834	\$306	1,036	\$173	3,459	3,762	577	\$1,445	\$2,022	6.81	6.81	\$50	\$340.46	\$2,362.31
6	2021	0.1621	0.3883	1,625	2,726	\$263	\$1,058	\$1,322	1,834	\$297	1,036	\$168	3,459	3,762	561	\$1,461	\$2,022	6.81	6.81	\$60	\$408.55	\$2,430.17
7	2022	0.1629	0.3929	1,625	2,726	\$265	\$1,071	\$1,336	1,834	\$299	1,036	\$169	3,459	3,762	564	\$1,478	\$2,042	6.81	6.81	\$70	\$476.65	\$2,518.27
8	2023	0.1639	0.3967	1,625	2,726	\$266	\$1,081	\$1,348	1,834	\$301	1,036	\$170	3,459	3,762	567	\$1,492	\$2,059	6.81	6.81	\$80	\$544.74	\$2,603.99
9	2024	0.1648	0.4005	1,625	2,726	\$268	\$1,092	\$1,360	1,834	\$302	1,036	\$171	3,459	3,762	570	\$1,507	\$2,077	6.81	6.81	\$90	\$612.83	\$2,689.71
10	2025	0.1656	0.4040	1,625	2,726	\$269	\$1,101	\$1,370	1,834	\$304	1,036	\$172	3,459	3,762	573	\$1,520	\$2,099	6.81	6.81	\$100	\$680.92	\$2,773.50
11	2026	0.1665	0.4070	1,625	2,726	\$271	\$1,110	\$1,380	1,834	\$305	1,036	\$173	3,459	3,762	576	\$1,531	\$2,107	6.81	6.81	\$110	\$749.01	\$2,856.34
12	2027	0.1674	0.4097	1,625	2,726	\$272	\$1,117	\$1,389	1,834	\$307	1,036	\$173	3,459	3,762	579	\$1,541	\$2,121	6.81	6.81	\$120	\$817.11	\$2,937.62
13	2028	0.1683	0.4124	1,625	2,726	\$273	\$1,124	\$1,398	1,834	\$309	1,036	\$174	3,459	3,762	582	\$1,551	\$2,133	6.81	6.81	\$130	\$885.20	\$3,018.65
14	2029	0.1692	0.4151	1,625	2,726	\$275	\$1,131	\$1,406	1,834	\$310	1,036	\$175	3,459	3,762	585	\$1,562	\$2,147	6.81	6.81	\$140	\$953.29	\$3,099.93
15	2030	0.1701	0.4170	1,625	2,726	\$276	\$1,137	\$1,413	1,834	\$312	1,036	\$176	3,459	3,762	588	\$1,569	\$2,157	6.81	6.81	\$150	\$1,021.38	\$3,178.45
16	2031	0.1704	0.4189	1,625	2,726	\$277	\$1,142	\$1,419	1,834	\$312	1,036	\$176	3,459	3,762	589	\$1,576	\$2,165	6.81	6.81	\$160	\$1,089.48	\$3,254.61
17	2032	0.1705	0.4204	1,625	2,726	\$277	\$1,146	\$1,423	1,834	\$313	1,036	\$177	3,459	3,762	590	\$1,582	\$2,171	6.81	6.81	\$170	\$1,157.57	\$3,328.96
18	2033	0.1707	0.4223	1,625	2,726	\$277	\$1,151	\$1,429	1,834	\$313	1,036	\$177	3,459	3,762	591	\$1,589	\$2,179	6.81	6.81	\$180	\$1,225.66	\$3,405.12
19	2034	0.1710	0.4246	1,625	2,726	\$278	\$1,158	\$1,435	1,834	\$314	1,036	\$177	3,459	3,762	592	\$1,597	\$2,189	6.81	6.81	\$190	\$1,293.75	\$3,481.84
20	2035	0.1713	0.4265	1,625	2,726	\$278	\$1,163	\$1,441	1,834	\$314	1,036	\$177	3,459	3,762	592	\$1,605	\$2,197	6.81	6.81	\$200	\$1,361.84	\$3,559.00
21	2036	0.1714	0.4288	1,625	2,726	\$279	\$1,169	\$1,448	1,834	\$314	1,036	\$178	3,459	3,762	593	\$1,613	\$2,206	6.81	6.81	\$210	\$1,429.94	\$3,636.23
22	2037	0.1717	0.4311	1,625	2,726	\$279	\$1,175	\$1,454	1,834	\$315	1,036	\$178	3,459	3,762	594	\$1,622	\$2,216	6.81	6.81	\$220	\$1,498.03	\$3,713.83
23	2038	0.1720	0.4331	1,625	2,726	\$279	\$1,181	\$1,460	1,834	\$315	1,036	\$178	3,459	3,762	595	\$1,629	\$2,224	6.81	6.81	\$230	\$1,566.12	\$3,790.11
24	2039	0.1722	0.4353	1,625	2,726	\$280	\$1,187	\$1,467	1,834	\$316	1,036	\$178	3,459	3,762	596	\$1,638	\$2,233	6.81	6.81	\$240	\$1,634.21	\$3,867.71
25	2040	0.1724	0.4376	1,625	2,726	\$280	\$1,193	\$1,473	1,834	\$316	1,036	\$179	3,459	3,762	596	\$1,646	\$2,243	6.81	6.81	\$250	\$1,702.31	\$3,944.94
26	2041	0.1734	0.4420	1,625	2,726	\$282	\$1,205	\$1,486	1,834	\$318	1,036	\$180	3,459	3,762	600	\$1,663	\$2,262	6.81	6.81	\$260	\$1,770.40	\$4,032.71
27	2042	0.1744	0.4463	1,625	2,726	\$283	\$1,217	\$1,500	1,834	\$320	1,036	\$181	3,459	3,762	603	\$1,679	\$2,282	6.81	6.81	\$270	\$1,838.49	\$4,120.66
28	2043	0.1754	0.4507	1,625	2,726	\$285	\$1,229	\$1,514	1,834	\$322	1,036	\$182	3,459	3,762	607	\$1,696	\$2,302	6.81	6.81	\$280	\$1,906.58	\$4,208.80
29	2044	0.1764	0.4552	1,625	2,726	\$287	\$1,241	\$1,527	1,834	\$323	1,036	\$183	3,459	3,762	610	\$1,712	\$2,322	6.81	6.81	\$290	\$1,974.67	\$4,297.12
30	2045	0.1774	0.4596	1,625	2,726	\$288	\$1,253	\$1,541	1,834	\$325	1,036	\$184	3,459	3,762	614	\$1,729	\$2,349	6.81	6.81	\$300	\$2,042.77	\$4,385.62
31	2046	0.1784	0.4642	1,625	2,726	\$290	\$1,265	\$1,555	1,834	\$327	1,036	\$185	3,459	3,762	617	\$1,746	\$2,363	6.81	6.81	\$310	\$2,110.86	\$4,474.31
32	2047	0.1795	0.4688	1,625	2,726	\$292	\$1,278	\$1,569	1,834	\$329	1,036	\$186	3,459	3,762	621	\$1,763	\$2,384	6.81	6.81	\$320	\$2,178.95	\$4,563.19
33	2048	0.1805	0.4734	1,625	2,726	\$293	\$1,290	\$1,584	1,834	\$331	1,036	\$187	3,459	3,762	624	\$1,781	\$2,405	6.81	6.81	\$330	\$2,247.04	\$4,652.26
34	2049	0.1816	0.4780	1,625	2,726	\$295	\$1,303	\$1,598	1,834	\$333	1,036	\$188	3,459	3,762	628	\$1,798	\$2,426	6.81	6.81	\$340	\$2,315.13	\$4,741.52
35	2050	0.1826	0.4828	1,625	2,726	\$297	\$1,316	\$1,613	1,834	\$335	1,036	\$189	3,459	3,762	632	\$1,816	\$2,448	6.81	6.81	\$350	\$2,383.23	\$4,830.97
36	2051	0.1837	0.4875	1,625	2,726	\$298	\$1,329	\$1,627	1,834	\$337	1,036	\$190	3,459	3,762	635	\$1,834	\$2,469	6.81	6.81	\$360	\$2,451.32	\$4,920.62
37	2052	0.1847	0.4923	1,625	2,726	\$300	\$1,342	\$1,642	1,834	\$339	1,036	\$191	3,459	3,762	639	\$1,852	\$2,491	6.81	6.81	\$370	\$2,519.41	\$5,010.47
38	2053	0.1858	0.4972	1,625	2,726	\$302	\$1,355	\$1,657	1,834	\$341	1,036	\$192	3,459	3,762	643	\$1,870	\$2,513	6.81	6.81	\$380	\$2,587.50	\$5,100.52
39	2054	0.1869	0.5021	1,625	2,726	\$304	\$1,369	\$1,672	1,834	\$343	1,036	\$194	3,459	3,762	646	\$1,889	\$2,535	6.81	6.81	\$390	\$2,655.60	\$5,190.77
40	2055	0.1879	0.5070	1,625	2,726	\$305	\$1,382	\$1,688	1,834	\$345	1,036	\$195	3,459	3,762	650	\$1,907	\$2,558	6.81	6.81	\$400	\$2,723.69	\$5,281.24
41	2056	0.1890	0.5120	1,625	2,726	\$307	\$1,396	\$1,703	1,834	\$347	1,036	\$196	3,459	3,762	654	\$1,926	\$2,580	6.81	6.81	\$410	\$2,791.78	\$5,371.88
42	2057	0.1901	0.5171	1,625	2,726	\$309	\$1,410	\$1,718	1,834	\$349	1,036	\$197	3,459	3,762	658	\$1,945	\$2,603	6.81	6.81	\$420	\$2,859.87	\$5,462.75
43	2058	0.1912	0.5222	1,625	2,726	\$311	\$1,423	\$1,734	1,834	\$351	1,036	\$198	3,459	3,762	661	\$1,964	\$2,626	6.81	6.81	\$430	\$2,927.96	\$5,553.82
44	2059	0.1923	0.5273	1,625	2,726	\$313	\$1,437	\$1,750	1,834	\$353	1,036	\$199	3,459	3,762	665	\$1,984	\$2,649	6.81	6.81	\$440	\$2,996.06	\$5,645.11
45	2060	0.1934	0.5325	1,625	2,726	\$314	\$1,452	\$1,766	1,834	\$355	1,036	\$200	3,459	3,762	669	\$2,003	\$2,672	6.81	6.81	\$450	\$3,064.15	\$5,736.61
46	2061	0.1946	0.5378	1,625	2,726	\$316	\$1,466	\$1,782	1,834	\$357	1,036	\$202	3,459	3,762	673	\$2,023	\$2,696	6.81	6.81	\$460	\$3,132.24	\$5,828.32
47	2062	0.1957	0.5431	1,625	2,726	\$318	\$1,480	\$1,798	1,834	\$359	1,036	\$203	3,459	3,762	677	\$2,043	\$2,720	6.81	6.81	\$470	\$3,200.33	\$5,920.25
48	2063	0.1968	0.5484	1,625	2,726	\$320	\$1,495	\$1,815	1,834	\$361	1,036	\$204	3,459	3,762	681	\$2,063	\$2,744	6.81	6.81	\$480	\$3,268.43	\$6,012.40
49	2064	0.1980	0.5538	1,625	2,726	\$322	\$1,510	\$1,831	1,834	\$363	1,036	\$205	3,459	3,762	685	\$2,084	\$2,768	6.81	6.81	\$490	\$3,336.52	\$6,104.77
50	2065	0.1991	0.5593	1,625	2,726	\$324	\$1,525	\$1,848	1,834	\$365	1,036	\$206	3,459	3,762	689	\$2,104	\$2,793	6.81	6.81	\$500	\$3,404.61	\$6,197.37
51	2066	0.2003	0.5648	1,625	2,726	\$325	\$1,540	\$1,865	1,834	\$367	1,036	\$207	3,459	3,762	693	\$2,125	\$2,817	6.81	6.81	\$510	\$3,472.70	\$6,290.19
52	2067	0.2014	0.5704	1,625	2,726	\$327	\$1,555	\$1,882	1,834	\$369	1,036	\$209	3,459	3,762	697	\$2,146	\$2,842	6.81	6.81	\$520	\$3,540.79	\$6,383.24
53	2068	0.2026	0.5760	1,625	2,726	\$329	\$1,570	\$1,899	1,834	\$372	1,036	\$210	3,459	3,762	7							

7. London (South) – Annual Operating Costs

Vertical Ground Source Heat Pump (V.GSHP)

Base Case Scenario												Feed in Tariff (FIT)		
#	Year	Electricity Rates		Heating		Cooling		Hot Water		Total	Total Operating Cost	FIT		
		\$/KWh	KWh	\$/KWh	KWh	\$/KWh	KWh	\$/KWh	KWh			Incentives (\$/KWh)	\$/KWh	Operating Cost
1	2016	0.1501	5,366	\$805	330	\$50	4,302	\$646	9,998	\$1,501	0.05	0.1001	\$1,000.63	
2	2017	0.1542	5,366	\$827	330	\$51	4,302	\$663	9,998	\$1,542	0.05	0.1042	\$1,041.66	
3	2018	0.1583	5,366	\$849	330	\$52	4,302	\$681	9,998	\$1,583	0.05	0.1083	\$1,082.69	
4	2019	0.1625	5,366	\$872	330	\$54	4,302	\$699	9,998	\$1,625	0.05	0.1125	\$1,125.16	
5	2020	0.1668	5,366	\$895	330	\$55	4,302	\$718	9,998	\$1,668	0.05	0.1168	\$1,167.63	
6	2021	0.1621	5,366	\$870	330	\$54	4,302	\$698	9,998	\$1,621	0.05	0.1121	\$1,121.20	
7	2022	0.1629	5,366	\$874	330	\$54	4,302	\$701	9,998	\$1,629	0.05	0.1129	\$1,129.12	
8	2023	0.1639	5,366	\$879	330	\$54	4,302	\$705	9,998	\$1,638	0.05	0.1139	\$1,138.48	
9	2024	0.1648	5,366	\$884	330	\$54	4,302	\$709	9,998	\$1,648	0.05	0.1148	\$1,147.84	
10	2025	0.1656	5,366	\$889	330	\$55	4,302	\$712	9,998	\$1,656	0.05	0.1156	\$1,155.76	
11	2026	0.1665	5,366	\$894	330	\$55	4,302	\$716	9,998	\$1,665	0.05	0.1165	\$1,165.11	
12	2027	0.1674	5,366	\$898	330	\$55	4,302	\$720	9,998	\$1,674	0.05	0.1174	\$1,174.11	
13	2028	0.1683	5,366	\$903	330	\$56	4,302	\$724	9,998	\$1,682	0.05	0.1183	\$1,182.39	
14	2029	0.1692	5,366	\$908	330	\$56	4,302	\$728	9,998	\$1,691	0.05	0.1192	\$1,191.39	
15	2030	0.1701	5,366	\$913	330	\$56	4,302	\$732	9,998	\$1,701	0.05	0.1201	\$1,200.75	
16	2031	0.1704	5,366	\$914	330	\$56	4,302	\$733	9,998	\$1,703	0.05	0.1204	\$1,203.27	
17	2032	0.1705	5,366	\$915	330	\$56	4,302	\$733	9,998	\$1,705	0.05	0.1205	\$1,204.71	
18	2033	0.1707	5,366	\$916	330	\$56	4,302	\$735	9,998	\$1,707	0.05	0.1207	\$1,207.22	
19	2034	0.1710	5,366	\$918	330	\$56	4,302	\$736	9,998	\$1,710	0.05	0.1210	\$1,210.10	
20	2035	0.1713	5,366	\$919	330	\$57	4,302	\$737	9,998	\$1,713	0.05	0.1213	\$1,212.62	
21	2036	0.1714	5,366	\$920	330	\$57	4,302	\$737	9,998	\$1,714	0.05	0.1214	\$1,214.06	
22	2037	0.1717	5,366	\$921	330	\$57	4,302	\$739	9,998	\$1,716	0.05	0.1217	\$1,216.58	
23	2038	0.1720	5,366	\$923	330	\$57	4,302	\$740	9,998	\$1,719	0.05	0.1220	\$1,219.46	
24	2039	0.1722	5,366	\$924	330	\$57	4,302	\$741	9,998	\$1,722	0.05	0.1222	\$1,221.98	
25	2040	0.1724	5,366	\$925	330	\$57	4,302	\$742	9,998	\$1,723	0.05	0.1224	\$1,223.42	
26	2041	0.1734	5,366	\$930	330	\$57	4,302	\$746	9,998	\$1,733	0.05	0.1234	\$1,233.39	
27	2042	0.1744	5,366	\$936	330	\$58	4,302	\$750	9,998	\$1,743	0.05	0.1244	\$1,243.42	
28	2043	0.1754	5,366	\$941	330	\$58	4,302	\$754	9,998	\$1,753	0.05	0.1254	\$1,253.50	
29	2044	0.1764	5,366	\$947	330	\$58	4,302	\$759	9,998	\$1,764	0.05	0.1264	\$1,263.65	
30	2045	0.1774	5,366	\$952	330	\$59	4,302	\$763	9,998	\$1,774	0.05	0.1274	\$1,273.85	
31	2046	0.1784	5,366	\$957	330	\$59	4,302	\$768	9,998	\$1,784	0.05	0.1284	\$1,284.11	
32	2047	0.1795	5,366	\$963	330	\$59	4,302	\$772	9,998	\$1,794	0.05	0.1295	\$1,294.43	
33	2048	0.1805	5,366	\$969	330	\$60	4,302	\$777	9,998	\$1,805	0.05	0.1305	\$1,304.81	
34	2049	0.1816	5,366	\$974	330	\$60	4,302	\$781	9,998	\$1,815	0.05	0.1316	\$1,315.25	
35	2050	0.1826	5,366	\$980	330	\$60	4,302	\$786	9,998	\$1,826	0.05	0.1326	\$1,325.75	
36	2051	0.1837	5,366	\$986	330	\$61	4,302	\$790	9,998	\$1,836	0.05	0.1337	\$1,336.31	
37	2052	0.1847	5,366	\$991	330	\$61	4,302	\$795	9,998	\$1,847	0.05	0.1347	\$1,346.93	
38	2053	0.1858	5,366	\$997	330	\$61	4,302	\$799	9,998	\$1,858	0.05	0.1358	\$1,357.62	
39	2054	0.1869	5,366	\$1,003	330	\$62	4,302	\$804	9,998	\$1,868	0.05	0.1369	\$1,368.36	
40	2055	0.1879	5,366	\$1,009	330	\$62	4,302	\$809	9,998	\$1,879	0.05	0.1379	\$1,379.17	
41	2056	0.1890	5,366	\$1,014	330	\$62	4,302	\$813	9,998	\$1,890	0.05	0.1390	\$1,390.04	
42	2057	0.1901	5,366	\$1,020	330	\$63	4,302	\$818	9,998	\$1,901	0.05	0.1401	\$1,400.97	
43	2058	0.1912	5,366	\$1,026	330	\$63	4,302	\$823	9,998	\$1,912	0.05	0.1412	\$1,411.97	
44	2059	0.1923	5,366	\$1,032	330	\$63	4,302	\$827	9,998	\$1,923	0.05	0.1423	\$1,423.03	
45	2060	0.1934	5,366	\$1,038	330	\$64	4,302	\$832	9,998	\$1,934	0.05	0.1434	\$1,434.15	
46	2061	0.1946	5,366	\$1,044	330	\$64	4,302	\$837	9,998	\$1,945	0.05	0.1446	\$1,445.34	
47	2062	0.1957	5,366	\$1,050	330	\$65	4,302	\$842	9,998	\$1,956	0.05	0.1457	\$1,456.59	
48	2063	0.1968	5,366	\$1,056	330	\$65	4,302	\$847	9,998	\$1,968	0.05	0.1468	\$1,467.91	
49	2064	0.1980	5,366	\$1,062	330	\$65	4,302	\$852	9,998	\$1,979	0.05	0.1480	\$1,479.29	
50	2065	0.1991	5,366	\$1,068	330	\$66	4,302	\$857	9,998	\$1,991	0.05	0.1491	\$1,490.74	
51	2066	0.2003	5,366	\$1,075	330	\$66	4,302	\$862	9,998	\$2,002	0.05	0.1503	\$1,502.26	
52	2067	0.2014	5,366	\$1,081	330	\$66	4,302	\$866	9,998	\$2,014	0.05	0.1514	\$1,513.84	
53	2068	0.2026	5,366	\$1,087	330	\$67	4,302	\$871	9,998	\$2,025	0.05	0.1526	\$1,525.49	
54	2069	0.2038	5,366	\$1,093	330	\$67	4,302	\$877	9,998	\$2,037	0.05	0.1538	\$1,537.21	
55	2070	0.2049	5,366	\$1,100	330	\$68	4,302	\$882	9,998	\$2,049	0.05	0.1549	\$1,548.99	
56	2071	0.2061	5,366	\$1,106	330	\$68	4,302	\$887	9,998	\$2,061	0.05	0.1561	\$1,560.84	
57	2072	0.2073	5,366	\$1,112	330	\$68	4,302	\$892	9,998	\$2,073	0.05	0.1573	\$1,572.77	
58	2073	0.2085	5,366	\$1,119	330	\$69	4,302	\$897	9,998	\$2,085	0.05	0.1585	\$1,584.76	
59	2074	0.2097	5,366	\$1,125	330	\$69	4,302	\$902	9,998	\$2,097	0.05	0.1597	\$1,596.82	
60	2075	0.2109	5,366	\$1,132	330	\$70	4,302	\$907	9,998	\$2,109	0.05	0.1609	\$1,608.94	

Table D1-1.19: Annual Operating Costs (V.GSHP) of a 2,000 square feet detached house above grade (average construction type) in the city of London (two life cycles and three life cycles for a 60 year project lifespan); base case scenario in comparison with feed in-tariff (FIT) scenario. In the FIT scenario, an incentive of \$0.05/KWh is provided on electricity bills throughout the project lifespan

Horizontal Ground Source Heat Pump (H.GSHP)

Base Case Scenario											Feed in Tariff (FIT)		
H.GSHP											FIT		
#	Year	Electricity Rates \$/KWh	Heating KWh	Heating Operating Cost \$	Cooling KWh	Cooling Operating Cost \$	Hot Water KWh	Hot Water Operating Cost \$	Total KWh	Total Operating Cost \$	Incentives (\$/KWh)	\$/KWh	Operating Cost
1	2016	0.1501	5,440	\$816	338	\$51	4,281	\$643	10,059	\$1,510	0.05	0.1001	\$1,006.73
2	2017	0.1543	5,440	\$839	338	\$52	4,281	\$660	10,059	\$1,551	0.05	0.1042	\$1,048.01
3	2018	0.1583	5,440	\$861	338	\$54	4,281	\$678	10,059	\$1,592	0.05	0.1083	\$1,089.30
4	2019	0.1625	5,440	\$884	338	\$55	4,281	\$696	10,059	\$1,635	0.05	0.1125	\$1,132.03
5	2020	0.1668	5,440	\$907	338	\$56	4,281	\$714	10,059	\$1,678	0.05	0.1168	\$1,174.76
6	2021	0.1621	5,440	\$882	338	\$55	4,281	\$694	10,059	\$1,631	0.05	0.1121	\$1,128.04
7	2022	0.1629	5,440	\$886	338	\$55	4,281	\$698	10,059	\$1,639	0.05	0.1129	\$1,136.01
8	2023	0.1639	5,440	\$891	338	\$55	4,281	\$702	10,059	\$1,648	0.05	0.1139	\$1,145.43
9	2024	0.1648	5,440	\$897	338	\$56	4,281	\$706	10,059	\$1,658	0.05	0.1148	\$1,154.84
10	2025	0.1656	5,440	\$901	338	\$56	4,281	\$709	10,059	\$1,666	0.05	0.1156	\$1,162.81
11	2026	0.1665	5,440	\$906	338	\$56	4,281	\$713	10,059	\$1,675	0.05	0.1165	\$1,172.22
12	2027	0.1674	5,440	\$911	338	\$57	4,281	\$717	10,059	\$1,684	0.05	0.1174	\$1,181.28
13	2028	0.1683	5,440	\$915	338	\$57	4,281	\$720	10,059	\$1,693	0.05	0.1183	\$1,189.60
14	2029	0.1692	5,440	\$920	338	\$57	4,281	\$724	10,059	\$1,702	0.05	0.1192	\$1,198.66
15	2030	0.1701	5,440	\$925	338	\$57	4,281	\$728	10,059	\$1,711	0.05	0.1201	\$1,208.07
16	2031	0.1704	5,440	\$927	338	\$58	4,281	\$729	10,059	\$1,714	0.05	0.1204	\$1,210.61
17	2032	0.1705	5,440	\$927	338	\$58	4,281	\$730	10,059	\$1,715	0.05	0.1205	\$1,212.06
18	2033	0.1707	5,440	\$929	338	\$58	4,281	\$731	10,059	\$1,718	0.05	0.1207	\$1,214.59
19	2034	0.1710	5,440	\$930	338	\$58	4,281	\$732	10,059	\$1,720	0.05	0.1210	\$1,217.49
20	2035	0.1713	5,440	\$932	338	\$58	4,281	\$733	10,059	\$1,723	0.05	0.1213	\$1,220.02
21	2036	0.1714	5,440	\$933	338	\$58	4,281	\$734	10,059	\$1,724	0.05	0.1214	\$1,221.47
22	2037	0.1717	5,440	\$934	338	\$58	4,281	\$735	10,059	\$1,727	0.05	0.1217	\$1,224.01
23	2038	0.1720	5,440	\$936	338	\$58	4,281	\$736	10,059	\$1,730	0.05	0.1220	\$1,226.90
24	2039	0.1722	5,440	\$937	338	\$58	4,281	\$737	10,059	\$1,732	0.05	0.1222	\$1,229.44
25	2040	0.1724	5,440	\$938	338	\$58	4,281	\$738	10,059	\$1,734	0.05	0.1224	\$1,230.89
26	2041	0.1734	5,440	\$943	338	\$59	4,281	\$742	10,059	\$1,744	0.05	0.1234	\$1,240.92
27	2042	0.1744	5,440	\$949	338	\$59	4,281	\$746	10,059	\$1,754	0.05	0.1244	\$1,251.00
28	2043	0.1754	5,440	\$954	338	\$59	4,281	\$751	10,059	\$1,764	0.05	0.1254	\$1,261.15
29	2044	0.1764	5,440	\$960	338	\$60	4,281	\$755	10,059	\$1,774	0.05	0.1264	\$1,271.36
30	2045	0.1774	5,440	\$965	338	\$60	4,281	\$759	10,059	\$1,785	0.05	0.1274	\$1,281.62
31	2046	0.1784	5,440	\$971	338	\$60	4,281	\$764	10,059	\$1,795	0.05	0.1284	\$1,291.94
32	2047	0.1795	5,440	\$976	338	\$61	4,281	\$768	10,059	\$1,805	0.05	0.1295	\$1,302.33
33	2048	0.1805	5,440	\$982	338	\$61	4,281	\$773	10,059	\$1,816	0.05	0.1305	\$1,312.77
34	2049	0.1816	5,440	\$988	338	\$61	4,281	\$777	10,059	\$1,826	0.05	0.1316	\$1,323.27
35	2050	0.1826	5,440	\$993	338	\$62	4,281	\$782	10,059	\$1,837	0.05	0.1326	\$1,333.84
36	2051	0.1837	5,440	\$999	338	\$62	4,281	\$786	10,059	\$1,847	0.05	0.1337	\$1,344.46
37	2052	0.1847	5,440	\$1,005	338	\$62	4,281	\$791	10,059	\$1,858	0.05	0.1347	\$1,355.15
38	2053	0.1858	5,440	\$1,011	338	\$63	4,281	\$795	10,059	\$1,869	0.05	0.1358	\$1,365.90
39	2054	0.1869	5,440	\$1,017	338	\$63	4,281	\$800	10,059	\$1,880	0.05	0.1369	\$1,376.71
40	2055	0.1879	5,440	\$1,022	338	\$64	4,281	\$805	10,059	\$1,891	0.05	0.1379	\$1,387.58
41	2056	0.1890	5,440	\$1,028	338	\$64	4,281	\$809	10,059	\$1,901	0.05	0.1390	\$1,398.52
42	2057	0.1901	5,440	\$1,034	338	\$64	4,281	\$814	10,059	\$1,912	0.05	0.1401	\$1,409.52
43	2058	0.1912	5,440	\$1,040	338	\$65	4,281	\$819	10,059	\$1,924	0.05	0.1412	\$1,420.58
44	2059	0.1923	5,440	\$1,046	338	\$65	4,281	\$823	10,059	\$1,935	0.05	0.1423	\$1,431.71
45	2060	0.1934	5,440	\$1,052	338	\$65	4,281	\$828	10,059	\$1,946	0.05	0.1434	\$1,442.90
46	2061	0.1946	5,440	\$1,058	338	\$66	4,281	\$833	10,059	\$1,957	0.05	0.1446	\$1,454.16
47	2062	0.1957	5,440	\$1,065	338	\$66	4,281	\$838	10,059	\$1,968	0.05	0.1457	\$1,465.48
48	2063	0.1968	5,440	\$1,071	338	\$67	4,281	\$843	10,059	\$1,980	0.05	0.1468	\$1,476.87
49	2064	0.1980	5,440	\$1,077	338	\$67	4,281	\$847	10,059	\$1,991	0.05	0.1480	\$1,488.32
50	2065	0.1991	5,440	\$1,083	338	\$67	4,281	\$852	10,059	\$2,003	0.05	0.1491	\$1,499.84
51	2066	0.2003	5,440	\$1,089	338	\$68	4,281	\$857	10,059	\$2,014	0.05	0.1503	\$1,511.43
52	2067	0.2014	5,440	\$1,096	338	\$68	4,281	\$862	10,059	\$2,026	0.05	0.1514	\$1,523.08
53	2068	0.2026	5,440	\$1,102	338	\$68	4,281	\$867	10,059	\$2,038	0.05	0.1526	\$1,534.80
54	2069	0.2038	5,440	\$1,108	338	\$69	4,281	\$872	10,059	\$2,050	0.05	0.1538	\$1,546.59
55	2070	0.2049	5,440	\$1,115	338	\$69	4,281	\$877	10,059	\$2,061	0.05	0.1549	\$1,558.44
56	2071	0.2061	5,440	\$1,121	338	\$70	4,281	\$882	10,059	\$2,073	0.05	0.1561	\$1,570.37
57	2072	0.2073	5,440	\$1,128	338	\$70	4,281	\$887	10,059	\$2,085	0.05	0.1573	\$1,582.36
58	2073	0.2085	5,440	\$1,134	338	\$70	4,281	\$893	10,059	\$2,097	0.05	0.1585	\$1,594.42
59	2074	0.2097	5,440	\$1,141	338	\$71	4,281	\$898	10,059	\$2,110	0.05	0.1597	\$1,606.56
60	2075	0.2109	5,440	\$1,147	338	\$71	4,281	\$903	10,059	\$2,122	0.05	0.1609	\$1,618.76

Table D1-1.20: Annual Operating Costs (H.GSHP) of a 2,000 square feet detached house above grade (average construction type) in the city of London (two life cycles and three life cycles for a 60 year project lifespan); base case scenario in comparison with feed in-tariff (FIT) scenario. In the FIT scenario, an incentive of \$0.05/KWh is provided on electricity bills throughout the project lifespan

Traditional HVAC Applications

Base Case Scenario															Carbon Taxes							
#	Year	Electricity Rates	Natural Gas Rates	Heating		Heating Operating Cost	Heating Operating Cost	Total Heating Operating Cost	Cooling	Cooling Operating Cost	Hot Water	Hot Water Operating Cost	Total	Total	Total Electricity Operating Cost	Total Natural Gas Operating Cost	Total	Conversion of m ³ into Tons	Total Tons	Carbon Tax	Operating Costs	
				KWh (Electricity)	m ³ (Gas)																	\$ (KWh)
1	2016	0.1501	0.3458	1,776	2,598	\$267	\$267	\$898	1,474	\$221	1,028	\$356	3,250	3,626	488	\$1,254	\$1,742	6.56	6.56	\$10	\$65.63	\$1,807.38
2	2017	0.1542	0.3588	1,776	2,598	\$274	\$274	\$932	1,474	\$227	1,028	\$159	3,250	3,626	501	\$1,301	\$1,802	6.56	6.56	\$20	\$111.26	\$1,933.51
3	2018	0.1583	0.3718	1,776	2,598	\$281	\$281	\$966	1,474	\$233	1,028	\$163	3,250	3,626	514	\$1,348	\$1,863	6.56	6.56	\$30	\$196.89	\$2,059.64
4	2019	0.1625	0.3776	1,776	2,598	\$289	\$289	\$981	1,474	\$240	1,028	\$167	3,250	3,626	528	\$1,369	\$1,897	6.56	6.56	\$40	\$262.52	\$2,159.89
5	2020	0.1668	0.3841	1,776	2,598	\$296	\$296	\$998	1,474	\$246	1,028	\$171	3,250	3,626	542	\$1,393	\$1,935	6.56	6.56	\$50	\$328.15	\$2,262.90
6	2021	0.1621	0.3883	1,776	2,598	\$288	\$1,009	\$1,297	1,474	\$239	1,028	\$167	3,250	3,626	527	\$1,408	\$1,935	6.56	6.56	\$60	\$393.78	\$2,328.70
7	2022	0.1629	0.3929	1,776	2,598	\$289	\$1,021	\$1,310	1,474	\$240	1,028	\$167	3,250	3,626	530	\$1,425	\$1,954	6.56	6.56	\$70	\$459.41	\$2,413.55
8	2023	0.1639	0.3967	1,776	2,598	\$291	\$1,031	\$1,322	1,474	\$242	1,028	\$168	3,250	3,626	533	\$1,438	\$1,971	6.56	6.56	\$80	\$525.04	\$2,496.10
9	2024	0.1648	0.4005	1,776	2,598	\$293	\$1,041	\$1,333	1,474	\$243	1,028	\$169	3,250	3,626	536	\$1,452	\$1,988	6.56	6.56	\$90	\$590.68	\$2,578.64
10	2025	0.1656	0.4040	1,776	2,598	\$294	\$1,050	\$1,344	1,474	\$244	1,028	\$170	3,250	3,626	538	\$1,465	\$2,003	6.56	6.56	\$100	\$656.31	\$2,659.33
11	2026	0.1665	0.4070	1,776	2,598	\$296	\$1,057	\$1,353	1,474	\$245	1,028	\$171	3,250	3,626	541	\$1,476	\$2,017	6.56	6.56	\$110	\$721.94	\$2,739.10
12	2027	0.1674	0.4097	1,776	2,598	\$297	\$1,064	\$1,362	1,474	\$247	1,028	\$172	3,250	3,626	544	\$1,486	\$2,030	6.56	6.56	\$120	\$787.57	\$2,817.36
13	2028	0.1683	0.4124	1,776	2,598	\$299	\$1,071	\$1,370	1,474	\$248	1,028	\$173	3,250	3,626	547	\$1,495	\$2,042	6.56	6.56	\$130	\$853.20	\$2,895.39
14	2029	0.1692	0.4151	1,776	2,598	\$300	\$1,078	\$1,379	1,474	\$249	1,028	\$174	3,250	3,626	550	\$1,505	\$2,055	6.56	6.56	\$140	\$918.83	\$2,973.66
15	2030	0.1701	0.4170	1,776	2,598	\$302	\$1,083	\$1,385	1,474	\$251	1,028	\$175	3,250	3,626	553	\$1,512	\$2,065	6.56	6.56	\$150	\$984.46	\$3,049.27
16	2031	0.1704	0.4189	1,776	2,598	\$303	\$1,088	\$1,391	1,474	\$251	1,028	\$175	3,250	3,626	554	\$1,519	\$2,073	6.56	6.56	\$160	\$1,050.09	\$3,122.65
17	2032	0.1705	0.4204	1,776	2,598	\$303	\$1,092	\$1,395	1,474	\$251	1,028	\$175	3,250	3,626	554	\$1,524	\$2,079	6.56	6.56	\$170	\$1,115.72	\$3,194.30
18	2033	0.1707	0.4223	1,776	2,598	\$303	\$1,097	\$1,400	1,474	\$252	1,028	\$176	3,250	3,626	555	\$1,531	\$2,086	6.56	6.56	\$180	\$1,181.35	\$3,267.69
19	2034	0.1710	0.4246	1,776	2,598	\$304	\$1,103	\$1,407	1,474	\$252	1,028	\$176	3,250	3,626	556	\$1,540	\$2,096	6.56	6.56	\$190	\$1,246.98	\$3,342.58
20	2035	0.1713	0.4265	1,776	2,598	\$304	\$1,108	\$1,412	1,474	\$252	1,028	\$176	3,250	3,626	557	\$1,547	\$2,103	6.56	6.56	\$200	\$1,312.61	\$3,415.96
21	2036	0.1714	0.4288	1,776	2,598	\$304	\$1,114	\$1,419	1,474	\$253	1,028	\$176	3,250	3,626	557	\$1,555	\$2,112	6.56	6.56	\$210	\$1,378.24	\$3,490.38
22	2037	0.1717	0.4311	1,776	2,598	\$305	\$1,120	\$1,425	1,474	\$253	1,028	\$176	3,250	3,626	558	\$1,563	\$2,121	6.56	6.56	\$220	\$1,443.87	\$3,565.16
23	2038	0.1720	0.4331	1,776	2,598	\$305	\$1,125	\$1,430	1,474	\$253	1,028	\$177	3,250	3,626	559	\$1,570	\$2,129	6.56	6.56	\$230	\$1,509.50	\$3,638.66
24	2039	0.1722	0.4353	1,776	2,598	\$306	\$1,131	\$1,437	1,474	\$254	1,028	\$177	3,250	3,626	560	\$1,579	\$2,138	6.56	6.56	\$240	\$1,575.13	\$3,713.43
25	2040	0.1724	0.4376	1,776	2,598	\$306	\$1,137	\$1,443	1,474	\$254	1,028	\$177	3,250	3,626	560	\$1,587	\$2,147	6.56	6.56	\$250	\$1,640.77	\$3,787.85
26	2041	0.1734	0.4420	1,776	2,598	\$308	\$1,148	\$1,456	1,474	\$256	1,028	\$178	3,250	3,626	563	\$1,603	\$2,166	6.56	6.56	\$260	\$1,706.40	\$3,872.37
27	2042	0.1744	0.4463	1,776	2,598	\$310	\$1,160	\$1,469	1,474	\$257	1,028	\$179	3,250	3,626	567	\$1,618	\$2,185	6.56	6.56	\$270	\$1,772.03	\$3,957.06
28	2043	0.1754	0.4507	1,776	2,598	\$311	\$1,171	\$1,482	1,474	\$259	1,028	\$180	3,250	3,626	570	\$1,634	\$2,204	6.56	6.56	\$280	\$1,837.66	\$4,041.92
29	2044	0.1764	0.4552	1,776	2,598	\$313	\$1,183	\$1,496	1,474	\$260	1,028	\$181	3,250	3,626	573	\$1,650	\$2,224	6.56	6.56	\$290	\$1,903.29	\$4,126.96
30	2045	0.1774	0.4596	1,776	2,598	\$315	\$1,194	\$1,509	1,474	\$262	1,028	\$182	3,250	3,626	577	\$1,667	\$2,243	6.56	6.56	\$300	\$1,968.92	\$4,212.18
31	2046	0.1784	0.4642	1,776	2,598	\$317	\$1,205	\$1,523	1,474	\$263	1,028	\$183	3,250	3,626	580	\$1,683	\$2,263	6.56	6.56	\$310	\$2,034.55	\$4,297.58
32	2047	0.1795	0.4688	1,776	2,598	\$319	\$1,218	\$1,537	1,474	\$265	1,028	\$184	3,250	3,626	583	\$1,700	\$2,283	6.56	6.56	\$320	\$2,100.18	\$4,383.16
33	2048	0.1805	0.4734	1,776	2,598	\$321	\$1,230	\$1,550	1,474	\$266	1,028	\$186	3,250	3,626	587	\$1,716	\$2,303	6.56	6.56	\$330	\$2,165.81	\$4,468.92
34	2049	0.1816	0.4780	1,776	2,598	\$322	\$1,242	\$1,564	1,474	\$268	1,028	\$187	3,250	3,626	590	\$1,733	\$2,323	6.56	6.56	\$340	\$2,231.44	\$4,554.87
35	2050	0.1826	0.4828	1,776	2,598	\$324	\$1,254	\$1,579	1,474	\$269	1,028	\$188	3,250	3,626	593	\$1,750	\$2,344	6.56	6.56	\$350	\$2,297.07	\$4,641.00
36	2051	0.1837	0.4875	1,776	2,598	\$326	\$1,267	\$1,593	1,474	\$271	1,028	\$189	3,250	3,626	597	\$1,768	\$2,365	6.56	6.56	\$360	\$2,362.70	\$4,727.32
37	2052	0.1847	0.4923	1,776	2,598	\$328	\$1,279	\$1,607	1,474	\$272	1,028	\$190	3,250	3,626	600	\$1,785	\$2,386	6.56	6.56	\$370	\$2,428.33	\$4,813.83
38	2053	0.1858	0.4972	1,776	2,598	\$330	\$1,292	\$1,622	1,474	\$274	1,028	\$191	3,250	3,626	604	\$1,803	\$2,407	6.56	6.56	\$380	\$2,493.96	\$4,900.54
39	2054	0.1869	0.5021	1,776	2,598	\$332	\$1,304	\$1,636	1,474	\$275	1,028	\$192	3,250	3,626	607	\$1,821	\$2,428	6.56	6.56	\$390	\$2,559.59	\$4,987.43
40	2055	0.1879	0.5070	1,776	2,598	\$334	\$1,317	\$1,651	1,474	\$277	1,028	\$193	3,250	3,626	611	\$1,838	\$2,449	6.56	6.56	\$400	\$2,625.22	\$5,074.52
41	2056	0.1890	0.5120	1,776	2,598	\$336	\$1,330	\$1,666	1,474	\$279	1,028	\$194	3,250	3,626	614	\$1,857	\$2,471	6.56	6.56	\$410	\$2,690.85	\$5,161.81
42	2057	0.1901	0.5171	1,776	2,598	\$338	\$1,343	\$1,681	1,474	\$280	1,028	\$195	3,250	3,626	618	\$1,875	\$2,493	6.56	6.56	\$420	\$2,756.49	\$5,249.30
43	2058	0.1912	0.5222	1,776	2,598	\$340	\$1,357	\$1,696	1,474	\$282	1,028	\$197	3,250	3,626	621	\$1,893	\$2,515	6.56	6.56	\$430	\$2,822.12	\$5,336.99
44	2059	0.1923	0.5273	1,776	2,598	\$342	\$1,370	\$1,712	1,474	\$283	1,028	\$198	3,250	3,626	625	\$1,912	\$2,537	6.56	6.56	\$440	\$2,887.75	\$5,424.89
45	2060	0.1934	0.5325	1,776	2,598	\$344	\$1,383	\$1,727	1,474	\$285	1,028	\$199	3,250	3,626	629	\$1,931	\$2,560	6.56	6.56	\$450	\$2,953.38	\$5,512.98
46	2061	0.1946	0.5378	1,776	2,598	\$346	\$1,397	\$1,743	1,474	\$287	1,028	\$200	3,250	3,626	632	\$1,950	\$2,582	6.56	6.56	\$460	\$3,019.01	\$5,601.29
47	2062	0.1957	0.5431	1,776	2,598	\$348	\$1,411	\$1,758	1,474	\$288	1,028	\$201	3,250	3,626	636	\$1,969	\$2,605	6.56	6.56	\$470	\$3,084.64	\$5,689.80
48	2063	0.1968	0.5484	1,776	2,598	\$350	\$1,425	\$1,774	1,474	\$290	1,028	\$202	3,250	3,626	640	\$1,						

8. Mount Forest (South) – Annual Operating Costs

Vertical Ground Source Heat Pump (V.GSHP)

Base Case Scenario												Feed In Tariff (FIT)		
V.GSHP												FIT		
#	Year	Electricity Rates \$/KWh	Heating KWh	Heating Operating Cost \$	Cooling KWh	Cooling Operating Cost \$	Hot Water KWh	Hot Water Operating Cost \$	Total KWh	Total Operating Cost \$	Incentives (\$/KWh)	FIT \$/KWh	Operating Cost	
1	2016	0.1501	6,230	\$935	226	\$34	4,010	\$602	10,466	\$1,571	0.05	0.1001	\$1,047.47	
2	2017	0.1542	6,230	\$961	226	\$35	4,010	\$618	10,466	\$1,614	0.05	0.1042	\$1,090.42	
3	2018	0.1583	6,230	\$986	226	\$36	4,010	\$635	10,466	\$1,657	0.05	0.1083	\$1,133.37	
4	2019	0.1625	6,230	\$1,013	226	\$37	4,010	\$652	10,466	\$1,701	0.05	0.1125	\$1,177.83	
5	2020	0.1668	6,230	\$1,039	226	\$38	4,010	\$669	10,466	\$1,746	0.05	0.1168	\$1,222.29	
6	2021	0.1621	6,230	\$1,010	226	\$37	4,010	\$650	10,466	\$1,697	0.05	0.1121	\$1,173.69	
7	2022	0.1629	6,230	\$1,015	226	\$37	4,010	\$653	10,466	\$1,705	0.05	0.1129	\$1,181.97	
8	2023	0.1639	6,230	\$1,021	226	\$37	4,010	\$657	10,466	\$1,715	0.05	0.1139	\$1,191.77	
9	2024	0.1648	6,230	\$1,027	226	\$37	4,010	\$661	10,466	\$1,725	0.05	0.1148	\$1,201.57	
10	2025	0.1656	6,230	\$1,032	226	\$37	4,010	\$664	10,466	\$1,733	0.05	0.1156	\$1,209.86	
11	2026	0.1665	6,230	\$1,038	226	\$38	4,010	\$668	10,466	\$1,743	0.05	0.1165	\$1,219.65	
12	2027	0.1674	6,230	\$1,043	226	\$38	4,010	\$671	10,466	\$1,752	0.05	0.1174	\$1,229.07	
13	2028	0.1683	6,230	\$1,048	226	\$38	4,010	\$675	10,466	\$1,761	0.05	0.1183	\$1,237.74	
14	2029	0.1692	6,230	\$1,054	226	\$38	4,010	\$678	10,466	\$1,770	0.05	0.1192	\$1,247.16	
15	2030	0.1701	6,230	\$1,060	226	\$38	4,010	\$682	10,466	\$1,780	0.05	0.1201	\$1,256.95	
16	2031	0.1704	6,230	\$1,061	226	\$38	4,010	\$683	10,466	\$1,783	0.05	0.1204	\$1,259.99	
17	2032	0.1705	6,230	\$1,062	226	\$39	4,010	\$684	10,466	\$1,784	0.05	0.1205	\$1,261.10	
18	2033	0.1707	6,230	\$1,064	226	\$39	4,010	\$685	10,466	\$1,787	0.05	0.1207	\$1,263.73	
19	2034	0.1710	6,230	\$1,066	226	\$39	4,010	\$686	10,466	\$1,790	0.05	0.1210	\$1,266.75	
20	2035	0.1713	6,230	\$1,067	226	\$39	4,010	\$687	10,466	\$1,793	0.05	0.1213	\$1,269.39	
21	2036	0.1714	6,230	\$1,068	226	\$39	4,010	\$687	10,466	\$1,794	0.05	0.1214	\$1,270.89	
22	2037	0.1717	6,230	\$1,070	226	\$39	4,010	\$688	10,466	\$1,797	0.05	0.1217	\$1,273.53	
23	2038	0.1720	6,230	\$1,071	226	\$39	4,010	\$690	10,466	\$1,800	0.05	0.1220	\$1,276.54	
24	2039	0.1722	6,230	\$1,073	226	\$39	4,010	\$691	10,466	\$1,802	0.05	0.1222	\$1,279.18	
25	2040	0.1724	6,230	\$1,074	226	\$39	4,010	\$691	10,466	\$1,804	0.05	0.1224	\$1,280.69	
26	2041	0.1734	6,230	\$1,080	226	\$39	4,010	\$695	10,466	\$1,814	0.05	0.1234	\$1,291.12	
27	2042	0.1744	6,230	\$1,086	226	\$39	4,010	\$699	10,466	\$1,825	0.05	0.1244	\$1,301.62	
28	2043	0.1754	6,230	\$1,093	226	\$40	4,010	\$703	10,466	\$1,835	0.05	0.1254	\$1,312.18	
29	2044	0.1764	6,230	\$1,099	226	\$40	4,010	\$707	10,466	\$1,846	0.05	0.1264	\$1,322.80	
30	2045	0.1774	6,230	\$1,105	226	\$40	4,010	\$711	10,466	\$1,857	0.05	0.1274	\$1,333.48	
31	2046	0.1784	6,230	\$1,112	226	\$40	4,010	\$716	10,466	\$1,868	0.05	0.1284	\$1,344.22	
32	2047	0.1795	6,230	\$1,118	226	\$41	4,010	\$720	10,466	\$1,878	0.05	0.1295	\$1,355.02	
33	2048	0.1805	6,230	\$1,125	226	\$41	4,010	\$724	10,466	\$1,889	0.05	0.1305	\$1,365.89	
34	2049	0.1816	6,230	\$1,131	226	\$41	4,010	\$728	10,466	\$1,900	0.05	0.1316	\$1,376.81	
35	2050	0.1826	6,230	\$1,138	226	\$41	4,010	\$732	10,466	\$1,911	0.05	0.1326	\$1,387.81	
36	2051	0.1837	6,230	\$1,144	226	\$42	4,010	\$736	10,466	\$1,922	0.05	0.1337	\$1,398.86	
37	2052	0.1847	6,230	\$1,151	226	\$42	4,010	\$741	10,466	\$1,933	0.05	0.1347	\$1,409.98	
38	2053	0.1858	6,230	\$1,157	226	\$42	4,010	\$745	10,466	\$1,944	0.05	0.1358	\$1,421.16	
39	2054	0.1869	6,230	\$1,164	226	\$42	4,010	\$749	10,466	\$1,956	0.05	0.1369	\$1,432.41	
40	2055	0.1879	6,230	\$1,171	226	\$42	4,010	\$754	10,466	\$1,967	0.05	0.1379	\$1,443.73	
41	2056	0.1890	6,230	\$1,178	226	\$43	4,010	\$758	10,466	\$1,978	0.05	0.1390	\$1,455.11	
42	2057	0.1901	6,230	\$1,184	226	\$43	4,010	\$762	10,466	\$1,990	0.05	0.1401	\$1,466.55	
43	2058	0.1912	6,230	\$1,191	226	\$43	4,010	\$767	10,466	\$2,001	0.05	0.1412	\$1,478.06	
44	2059	0.1923	6,230	\$1,198	226	\$43	4,010	\$771	10,466	\$2,013	0.05	0.1423	\$1,489.64	
45	2060	0.1934	6,230	\$1,205	226	\$44	4,010	\$776	10,466	\$2,025	0.05	0.1434	\$1,501.28	
46	2061	0.1946	6,230	\$1,212	226	\$44	4,010	\$780	10,466	\$2,036	0.05	0.1446	\$1,513.00	
47	2062	0.1957	6,230	\$1,219	226	\$44	4,010	\$785	10,466	\$2,048	0.05	0.1457	\$1,524.78	
48	2063	0.1968	6,230	\$1,226	226	\$44	4,010	\$789	10,466	\$2,060	0.05	0.1468	\$1,536.62	
49	2064	0.1980	6,230	\$1,233	226	\$45	4,010	\$794	10,466	\$2,072	0.05	0.1480	\$1,548.54	
50	2065	0.1991	6,230	\$1,240	226	\$45	4,010	\$798	10,466	\$2,084	0.05	0.1491	\$1,560.52	
51	2066	0.2003	6,230	\$1,248	226	\$45	4,010	\$803	10,466	\$2,096	0.05	0.1503	\$1,572.58	
52	2067	0.2014	6,230	\$1,255	226	\$46	4,010	\$808	10,466	\$2,108	0.05	0.1514	\$1,584.70	
53	2068	0.2026	6,230	\$1,262	226	\$46	4,010	\$812	10,466	\$2,120	0.05	0.1526	\$1,596.90	
54	2069	0.2038	6,230	\$1,269	226	\$46	4,010	\$817	10,466	\$2,132	0.05	0.1538	\$1,609.16	
55	2070	0.2049	6,230	\$1,277	226	\$46	4,010	\$822	10,466	\$2,145	0.05	0.1549	\$1,621.50	
56	2071	0.2061	6,230	\$1,284	226	\$47	4,010	\$827	10,466	\$2,157	0.05	0.1561	\$1,633.91	
57	2072	0.2073	6,230	\$1,292	226	\$47	4,010	\$831	10,466	\$2,170	0.05	0.1573	\$1,646.39	
58	2073	0.2085	6,230	\$1,299	226	\$47	4,010	\$836	10,466	\$2,182	0.05	0.1585	\$1,658.94	
59	2074	0.2097	6,230	\$1,307	226	\$47	4,010	\$841	10,466	\$2,195	0.05	0.1597	\$1,671.56	
60	2075	0.2109	6,230	\$1,314	226	\$48	4,010	\$846	10,466	\$2,208	0.05	0.1609	\$1,684.26	

Table D1-1.22: Annual Operating Costs (V.GSHP) of a 2,000 square feet detached house above grade (average construction type) in the city of Mount Forest (two life cycles and three life cycles for a 60 year project lifespan); base case scenario in comparison with feed in-tariff (FIT) scenario. In the FIT scenario, an incentive of \$0.05/KWh is provided on electricity bills throughout the project lifespan

Horizontal Ground Source Heat Pump (H.GSHP)

Base Case Scenario											Feed in Tariff (FIT)		
H.GSHP											FIT		
#	Year	Electricity Rates \$/KWh	Heating KWh	Heating Operating Cost \$	Cooling KWh	Cooling Operating Cost \$	Hot Water KWh	Hot Water Operating Cost \$	Total KWh	Total Operating Cost \$	Incentives (\$/KWh)	\$/KWh	Operating Cost
1	2016	0.1501	6,312	\$947	232	\$35	3,992	\$599	10,536	\$1,581	0.05	0.1001	\$1,054.47
2	2017	0.1542	6,312	\$973	232	\$36	3,992	\$616	10,536	\$1,625	0.05	0.1042	\$1,097.71
3	2018	0.1583	6,312	\$999	232	\$37	3,992	\$632	10,536	\$1,668	0.05	0.1083	\$1,140.95
4	2019	0.1625	6,312	\$1,026	232	\$38	3,992	\$649	10,536	\$1,713	0.05	0.1125	\$1,185.71
5	2020	0.1668	6,312	\$1,053	232	\$39	3,992	\$666	10,536	\$1,757	0.05	0.1168	\$1,230.46
6	2021	0.1621	6,312	\$1,023	232	\$38	3,992	\$647	10,536	\$1,708	0.05	0.1121	\$1,181.54
7	2022	0.1629	6,312	\$1,028	232	\$38	3,992	\$650	10,536	\$1,717	0.05	0.1129	\$1,189.88
8	2023	0.1639	6,312	\$1,034	232	\$38	3,992	\$654	10,536	\$1,727	0.05	0.1139	\$1,199.74
9	2024	0.1648	6,312	\$1,040	232	\$38	3,992	\$658	10,536	\$1,736	0.05	0.1148	\$1,209.60
10	2025	0.1656	6,312	\$1,045	232	\$38	3,992	\$661	10,536	\$1,745	0.05	0.1156	\$1,217.95
11	2026	0.1665	6,312	\$1,051	232	\$39	3,992	\$665	10,536	\$1,755	0.05	0.1165	\$1,227.81
12	2027	0.1674	6,312	\$1,057	232	\$39	3,992	\$668	10,536	\$1,764	0.05	0.1174	\$1,237.29
13	2028	0.1683	6,312	\$1,062	232	\$39	3,992	\$672	10,536	\$1,773	0.05	0.1183	\$1,246.02
14	2029	0.1692	6,312	\$1,068	232	\$39	3,992	\$675	10,536	\$1,782	0.05	0.1192	\$1,255.50
15	2030	0.1701	6,312	\$1,074	232	\$39	3,992	\$679	10,536	\$1,792	0.05	0.1201	\$1,265.36
16	2031	0.1704	6,312	\$1,075	232	\$40	3,992	\$680	10,536	\$1,795	0.05	0.1204	\$1,268.01
17	2032	0.1705	6,312	\$1,076	232	\$40	3,992	\$681	10,536	\$1,796	0.05	0.1205	\$1,269.53
18	2033	0.1707	6,312	\$1,078	232	\$40	3,992	\$682	10,536	\$1,799	0.05	0.1207	\$1,272.19
19	2034	0.1710	6,312	\$1,080	232	\$40	3,992	\$683	10,536	\$1,802	0.05	0.1210	\$1,275.22
20	2035	0.1713	6,312	\$1,081	232	\$40	3,992	\$684	10,536	\$1,805	0.05	0.1213	\$1,277.88
21	2036	0.1714	6,312	\$1,082	232	\$40	3,992	\$684	10,536	\$1,806	0.05	0.1214	\$1,279.39
22	2037	0.1717	6,312	\$1,084	232	\$40	3,992	\$685	10,536	\$1,809	0.05	0.1217	\$1,282.05
23	2038	0.1720	6,312	\$1,085	232	\$40	3,992	\$687	10,536	\$1,812	0.05	0.1220	\$1,285.08
24	2039	0.1722	6,312	\$1,087	232	\$40	3,992	\$688	10,536	\$1,815	0.05	0.1222	\$1,287.74
25	2040	0.1724	6,312	\$1,088	232	\$40	3,992	\$688	10,536	\$1,816	0.05	0.1224	\$1,289.25
26	2041	0.1734	6,312	\$1,094	232	\$40	3,992	\$692	10,536	\$1,827	0.05	0.1234	\$1,299.76
27	2042	0.1744	6,312	\$1,101	232	\$40	3,992	\$696	10,536	\$1,837	0.05	0.1244	\$1,310.33
28	2043	0.1754	6,312	\$1,107	232	\$41	3,992	\$700	10,536	\$1,848	0.05	0.1254	\$1,320.95
29	2044	0.1764	6,312	\$1,113	232	\$41	3,992	\$704	10,536	\$1,858	0.05	0.1264	\$1,331.64
30	2045	0.1774	6,312	\$1,120	232	\$41	3,992	\$708	10,536	\$1,869	0.05	0.1274	\$1,342.39
31	2046	0.1784	6,312	\$1,126	232	\$41	3,992	\$712	10,536	\$1,880	0.05	0.1284	\$1,353.21
32	2047	0.1795	6,312	\$1,133	232	\$42	3,992	\$716	10,536	\$1,891	0.05	0.1295	\$1,364.08
33	2048	0.1805	6,312	\$1,139	232	\$42	3,992	\$721	10,536	\$1,902	0.05	0.1305	\$1,375.02
34	2049	0.1816	6,312	\$1,146	232	\$42	3,992	\$725	10,536	\$1,913	0.05	0.1316	\$1,386.02
35	2050	0.1826	6,312	\$1,153	232	\$42	3,992	\$729	10,536	\$1,924	0.05	0.1326	\$1,397.09
36	2051	0.1837	6,312	\$1,159	232	\$43	3,992	\$733	10,536	\$1,935	0.05	0.1337	\$1,408.22
37	2052	0.1847	6,312	\$1,166	232	\$43	3,992	\$737	10,536	\$1,946	0.05	0.1347	\$1,419.41
38	2053	0.1858	6,312	\$1,173	232	\$43	3,992	\$742	10,536	\$1,957	0.05	0.1358	\$1,430.67
39	2054	0.1869	6,312	\$1,179	232	\$43	3,992	\$746	10,536	\$1,969	0.05	0.1369	\$1,441.99
40	2055	0.1879	6,312	\$1,186	232	\$44	3,992	\$750	10,536	\$1,980	0.05	0.1379	\$1,453.38
41	2056	0.1890	6,312	\$1,193	232	\$44	3,992	\$755	10,536	\$1,992	0.05	0.1390	\$1,464.84
42	2057	0.1901	6,312	\$1,200	232	\$44	3,992	\$759	10,536	\$2,003	0.05	0.1401	\$1,476.36
43	2058	0.1912	6,312	\$1,207	232	\$44	3,992	\$763	10,536	\$2,015	0.05	0.1412	\$1,487.95
44	2059	0.1923	6,312	\$1,214	232	\$45	3,992	\$768	10,536	\$2,026	0.05	0.1423	\$1,499.60
45	2060	0.1934	6,312	\$1,221	232	\$45	3,992	\$772	10,536	\$2,038	0.05	0.1434	\$1,511.32
46	2061	0.1946	6,312	\$1,228	232	\$45	3,992	\$777	10,536	\$2,050	0.05	0.1446	\$1,523.12
47	2062	0.1957	6,312	\$1,235	232	\$45	3,992	\$781	10,536	\$2,062	0.05	0.1457	\$1,534.97
48	2063	0.1968	6,312	\$1,242	232	\$46	3,992	\$786	10,536	\$2,074	0.05	0.1468	\$1,546.90
49	2064	0.1980	6,312	\$1,250	232	\$46	3,992	\$790	10,536	\$2,086	0.05	0.1480	\$1,558.90
50	2065	0.1991	6,312	\$1,257	232	\$46	3,992	\$795	10,536	\$2,098	0.05	0.1491	\$1,570.96
51	2066	0.2003	6,312	\$1,264	232	\$46	3,992	\$799	10,536	\$2,110	0.05	0.1503	\$1,583.10
52	2067	0.2014	6,312	\$1,271	232	\$47	3,992	\$804	10,536	\$2,122	0.05	0.1514	\$1,595.30
53	2068	0.2026	6,312	\$1,279	232	\$47	3,992	\$809	10,536	\$2,134	0.05	0.1526	\$1,607.58
54	2069	0.2038	6,312	\$1,286	232	\$47	3,992	\$813	10,536	\$2,147	0.05	0.1538	\$1,619.93
55	2070	0.2049	6,312	\$1,294	232	\$48	3,992	\$818	10,536	\$2,159	0.05	0.1549	\$1,632.34
56	2071	0.2061	6,312	\$1,301	232	\$48	3,992	\$823	10,536	\$2,172	0.05	0.1561	\$1,644.83
57	2072	0.2073	6,312	\$1,309	232	\$48	3,992	\$828	10,536	\$2,184	0.05	0.1573	\$1,657.40
58	2073	0.2085	6,312	\$1,316	232	\$48	3,992	\$832	10,536	\$2,197	0.05	0.1585	\$1,670.03
59	2074	0.2097	6,312	\$1,324	232	\$49	3,992	\$837	10,536	\$2,210	0.05	0.1597	\$1,682.74
60	2075	0.2109	6,312	\$1,331	232	\$49	3,992	\$842	10,536	\$2,222	0.05	0.1609	\$1,695.52

Table D1-1.23: Annual Operating Costs (H.GSHP) of a 2,000 square feet detached house above grade (average construction type) in the city of Mount Forest (two life cycles and three life cycles for a 60 year project lifespan); base case scenario in comparison with feed in-tariff (FIT) scenario. In the FIT scenario, an incentive of \$0.05/KWh is provided on electricity bills throughout the project lifespan

Traditional HVAC Applications

Base Case Scenario															Carbon Taxes							
#	Year	Electricity Rates	Natural Gas Rates	Traditional								Total	Total	Total Electricity Operating Cost	Total Natural Gas Operating Cost	Total	Conversion of m ³ into Tons	Total Tons	Carbon Tax	Operating Costs		
				Heating		Heating Operating Cost	Heating Operating Cost	Total Heating Operating Cost	Cooling	Cooling Operating Cost	Hot Water										Hot Water Operating Cost	
				KWh (Electricity)	m ³ (Gas)	\$ (Electricity)	\$ (Gas)	\$	KWh	\$	m ³										\$	
\$/KWh	\$/m ³									KWh	m ³	\$(KWh)	\$(m ³)									
1	2016	0.1501	0.3458	1.794	3,006	\$269	\$1,040	\$1,309	1,016	\$152	1,015	\$351	2,810	4,021	422	\$1,391	\$1,812	7.28	7.28	\$10	\$72.78	\$1,885.10
2	2017	0.1542	0.3588	1.794	3,006	\$277	\$1,079	\$1,355	1,016	\$157	1,015	\$156	2,810	4,021	433	\$1,443	\$1,876	7.28	7.28	\$20	\$145.56	\$2,021.71
3	2018	0.1583	0.3718	1.794	3,006	\$284	\$1,118	\$1,402	1,016	\$161	1,015	\$161	2,810	4,021	445	\$1,495	\$1,940	7.28	7.28	\$30	\$218.34	\$2,158.32
4	2019	0.1625	0.3776	1.794	3,006	\$292	\$1,135	\$1,427	1,016	\$165	1,015	\$165	2,810	4,021	457	\$1,518	\$1,975	7.28	7.28	\$40	\$291.12	\$2,266.11
5	2020	0.1668	0.3841	1.794	3,006	\$299	\$1,155	\$1,454	1,016	\$169	1,015	\$169	2,810	4,021	469	\$1,544	\$2,013	7.28	7.28	\$50	\$363.90	\$2,376.98
6	2021	0.1621	0.3883	1.794	3,006	\$291	\$1,167	\$1,458	1,016	\$165	1,015	\$165	2,810	4,021	456	\$1,561	\$2,017	7.28	7.28	\$60	\$436.68	\$2,453.63
7	2022	0.1629	0.3929	1.794	3,006	\$292	\$1,181	\$1,473	1,016	\$166	1,015	\$165	2,810	4,021	458	\$1,580	\$2,038	7.28	7.28	\$70	\$509.46	\$2,547.10
8	2023	0.1639	0.3967	1.794	3,006	\$294	\$1,193	\$1,486	1,016	\$166	1,015	\$166	2,810	4,021	460	\$1,595	\$2,056	7.28	7.28	\$80	\$582.24	\$2,637.89
9	2024	0.1648	0.4005	1.794	3,006	\$296	\$1,204	\$1,500	1,016	\$167	1,015	\$167	2,810	4,021	463	\$1,611	\$2,074	7.28	7.28	\$90	\$655.02	\$2,728.68
10	2025	0.1656	0.4040	1.794	3,006	\$297	\$1,214	\$1,511	1,016	\$168	1,015	\$168	2,810	4,021	465	\$1,624	\$2,090	7.28	7.28	\$100	\$727.80	\$2,817.53
11	2026	0.1665	0.4070	1.794	3,006	\$299	\$1,224	\$1,522	1,016	\$169	1,015	\$169	2,810	4,021	468	\$1,637	\$2,105	7.28	7.28	\$110	\$800.58	\$2,905.25
12	2027	0.1674	0.4097	1.794	3,006	\$300	\$1,232	\$1,532	1,016	\$170	1,015	\$170	2,810	4,021	470	\$1,647	\$2,118	7.28	7.28	\$120	\$873.36	\$2,991.32
13	2028	0.1683	0.4124	1.794	3,006	\$302	\$1,240	\$1,542	1,016	\$171	1,015	\$171	2,810	4,021	473	\$1,658	\$2,131	7.28	7.28	\$130	\$946.14	\$3,077.20
14	2029	0.1692	0.4151	1.794	3,006	\$303	\$1,248	\$1,551	1,016	\$172	1,015	\$172	2,810	4,021	475	\$1,669	\$2,144	7.28	7.28	\$140	\$1,018.92	\$3,163.28
15	2030	0.1701	0.4170	1.794	3,006	\$305	\$1,253	\$1,559	1,016	\$173	1,015	\$173	2,810	4,021	478	\$1,677	\$2,155	7.28	7.28	\$150	\$1,091.70	\$3,246.38
16	2031	0.1704	0.4189	1.794	3,006	\$306	\$1,259	\$1,565	1,016	\$173	1,015	\$173	2,810	4,021	479	\$1,684	\$2,163	7.28	7.28	\$160	\$1,164.48	\$3,327.56
17	2032	0.1705	0.4204	1.794	3,006	\$306	\$1,264	\$1,570	1,016	\$173	1,015	\$173	2,810	4,021	479	\$1,691	\$2,170	7.28	7.28	\$170	\$1,237.26	\$3,406.89
18	2033	0.1707	0.4223	1.794	3,006	\$306	\$1,270	\$1,576	1,016	\$173	1,015	\$173	2,810	4,021	480	\$1,698	\$2,178	7.28	7.28	\$180	\$1,310.04	\$3,488.07
19	2034	0.1710	0.4246	1.794	3,006	\$307	\$1,276	\$1,583	1,016	\$174	1,015	\$174	2,810	4,021	481	\$1,707	\$2,188	7.28	7.28	\$190	\$1,382.82	\$3,570.89
20	2035	0.1713	0.4265	1.794	3,006	\$307	\$1,282	\$1,589	1,016	\$174	1,015	\$174	2,810	4,021	481	\$1,715	\$2,196	7.28	7.28	\$200	\$1,455.60	\$3,652.07
21	2036	0.1714	0.4288	1.794	3,006	\$308	\$1,289	\$1,597	1,016	\$174	1,015	\$174	2,810	4,021	482	\$1,724	\$2,206	7.28	7.28	\$210	\$1,528.38	\$3,734.49
22	2037	0.1717	0.4311	1.794	3,006	\$308	\$1,296	\$1,604	1,016	\$174	1,015	\$174	2,810	4,021	482	\$1,734	\$2,216	7.28	7.28	\$220	\$1,601.16	\$3,817.30
23	2038	0.1720	0.4331	1.794	3,006	\$309	\$1,302	\$1,610	1,016	\$175	1,015	\$175	2,810	4,021	483	\$1,741	\$2,225	7.28	7.28	\$230	\$1,673.94	\$3,898.49
24	2039	0.1722	0.4353	1.794	3,006	\$309	\$1,309	\$1,618	1,016	\$175	1,015	\$175	2,810	4,021	484	\$1,751	\$2,234	7.28	7.28	\$240	\$1,746.72	\$3,981.20
25	2040	0.1724	0.4376	1.794	3,006	\$309	\$1,316	\$1,625	1,016	\$175	1,015	\$175	2,810	4,021	484	\$1,760	\$2,244	7.28	7.28	\$250	\$1,819.50	\$4,063.62
26	2041	0.1734	0.4420	1.794	3,006	\$311	\$1,329	\$1,640	1,016	\$176	1,015	\$176	2,810	4,021	487	\$1,777	\$2,264	7.28	7.28	\$260	\$1,892.28	\$4,156.55
27	2042	0.1744	0.4463	1.794	3,006	\$313	\$1,342	\$1,654	1,016	\$177	1,015	\$177	2,810	4,021	490	\$1,795	\$2,285	7.28	7.28	\$270	\$1,965.06	\$4,249.67
28	2043	0.1754	0.4507	1.794	3,006	\$315	\$1,355	\$1,669	1,016	\$178	1,015	\$178	2,810	4,021	493	\$1,812	\$2,305	7.28	7.28	\$280	\$2,037.84	\$4,342.98
29	2044	0.1764	0.4552	1.794	3,006	\$316	\$1,368	\$1,685	1,016	\$179	1,015	\$179	2,810	4,021	496	\$1,830	\$2,326	7.28	7.28	\$290	\$2,110.62	\$4,436.47
30	2045	0.1774	0.4596	1.794	3,006	\$318	\$1,382	\$1,700	1,016	\$180	1,015	\$180	2,810	4,021	499	\$1,848	\$2,347	7.28	7.28	\$300	\$2,183.40	\$4,530.16
31	2046	0.1784	0.4642	1.794	3,006	\$320	\$1,395	\$1,715	1,016	\$181	1,015	\$181	2,810	4,021	501	\$1,866	\$2,368	7.28	7.28	\$310	\$2,256.18	\$4,624.05
32	2047	0.1795	0.4688	1.794	3,006	\$322	\$1,409	\$1,731	1,016	\$182	1,015	\$182	2,810	4,021	504	\$1,885	\$2,389	7.28	7.28	\$320	\$2,328.96	\$4,718.13
33	2048	0.1805	0.4734	1.794	3,006	\$324	\$1,423	\$1,747	1,016	\$183	1,015	\$183	2,810	4,021	507	\$1,903	\$2,411	7.28	7.28	\$330	\$2,401.74	\$4,812.41
34	2049	0.1816	0.4780	1.794	3,006	\$326	\$1,437	\$1,763	1,016	\$184	1,015	\$184	2,810	4,021	510	\$1,922	\$2,432	7.28	7.28	\$340	\$2,474.52	\$4,906.89
35	2050	0.1826	0.4828	1.794	3,006	\$328	\$1,451	\$1,779	1,016	\$186	1,015	\$185	2,810	4,021	513	\$1,941	\$2,454	7.28	7.28	\$350	\$2,547.30	\$5,001.58
36	2051	0.1837	0.4875	1.794	3,006	\$329	\$1,465	\$1,795	1,016	\$187	1,015	\$186	2,810	4,021	516	\$1,960	\$2,476	7.28	7.28	\$360	\$2,620.08	\$5,096.46
37	2052	0.1847	0.4923	1.794	3,006	\$331	\$1,480	\$1,811	1,016	\$188	1,015	\$187	2,810	4,021	519	\$1,980	\$2,499	7.28	7.28	\$370	\$2,692.86	\$5,191.55
38	2053	0.1858	0.4972	1.794	3,006	\$333	\$1,495	\$1,828	1,016	\$189	1,015	\$189	2,810	4,021	522	\$1,999	\$2,521	7.28	7.28	\$380	\$2,765.64	\$5,286.85
39	2054	0.1869	0.5021	1.794	3,006	\$335	\$1,509	\$1,844	1,016	\$190	1,015	\$190	2,810	4,021	525	\$2,019	\$2,544	7.28	7.28	\$390	\$2,838.42	\$5,382.36
40	2055	0.1879	0.5070	1.794	3,006	\$337	\$1,524	\$1,861	1,016	\$191	1,015	\$191	2,810	4,021	528	\$2,039	\$2,567	7.28	7.28	\$400	\$2,911.20	\$5,478.09
41	2056	0.1890	0.5120	1.794	3,006	\$339	\$1,539	\$1,878	1,016	\$192	1,015	\$192	2,810	4,021	531	\$2,059	\$2,590	7.28	7.28	\$410	\$2,983.98	\$5,574.02
42	2057	0.1901	0.5171	1.794	3,006	\$341	\$1,554	\$1,895	1,016	\$193	1,015	\$193	2,810	4,021	534	\$2,079	\$2,613	7.28	7.28	\$420	\$3,056.76	\$5,670.17
43	2058	0.1912	0.5222	1.794	3,006	\$343	\$1,570	\$1,913	1,016	\$194	1,015	\$194	2,810	4,021	537	\$2,100	\$2,637	7.28	7.28	\$430	\$3,129.54	\$5,766.54
44	2059	0.1923	0.5273	1.794	3,006	\$345	\$1,585	\$1,930	1,016	\$195	1,015	\$195	2,810	4,021	540	\$2,120	\$2,661	7.28	7.28	\$440	\$3,202.32	\$5,863.13
45	2060	0.1934	0.5325	1.794	3,006	\$347	\$1,601	\$1,948	1,016	\$197	1,015	\$196	2,810	4,021	544	\$2,141	\$2,685	7.28	7.28	\$450	\$3,275.10	\$5,959.94
46	2061	0.1946	0.5378	1.794	3,006	\$349	\$1,617	\$1,966	1,016	\$198	1,015	\$197	2,810	4,021	547	\$2,162	\$2,709	7.28	7.28	\$460	\$3,347.88	\$6,056.98
47	2062	0.1957	0.5431	1.794	3,006	\$351	\$1,632	\$1,984	1,016	\$199	1,015	\$199	2,810	4,021	550	\$2,184	\$2,734	7.28	7.28	\$470	\$3,420.66	\$6,154.24
48	2063	0.1968	0.5484	1.794	3,006	\$353	\$1,649	\$2,002	1,016	\$200	1,015	\$200	2,810	4,021	553	\$2,205	\$2,758	7.28	7.28	\$480	\$3,493.44	\$6,251.73
49	2064	0.1980	0.5538	1.794	3,006	\$355	\$1,665	\$2,020	1,016	\$201	1,015	\$201	2,810	4,021	556	\$2,227	\$2,783	7.28	7.28	\$490	\$3,566.22	\$6,349.45
50	2065	0.1991	0.5593	1.794	3,006	\$357	\$1,681	\$2,038	1,016	\$202	1,015	\$202	2,810	4,021	559	\$2,249	\$2,808	7.28	7.28	\$500	\$3,639.01	\$6,447.40
51	2066	0.2003	0.5648	1.794	3,006	\$359	\$1,698	\$2,057	1,016	\$203	1,015	\$203	2,810	4,021	563	\$2,271	\$2,834	7.28	7.28	\$510	\$3,711.79	\$6,545.59
52	2067	0.2014	0.5704	1.794	3,006	\$361	\$1,715	\$2,076	1,016	\$205	1,015	\$204	2,810	4,021	566	\$2,293	\$2,859	7.28	7.28	\$520	\$3,784.57	\$6,644.02
53	2068	0.2026																				

9. Niagara Falls (South) – Annual Operating Costs

Vertical Ground Source Heat Pump (V.GSHP)

Base Case Scenario												Feed in Tariff (FIT)		
V.GSHP												FIT		
#	Year	Electricity Rates	Heating	Heating Operating Cost	Cooling	Cooling Operating Cost	Hot Water	Hot Water Operating Cost	Total	Total Operating Cost	Incentives (S/KWh)	S/KWh	Operating Cost	
		\$/KWh	KWh	\$	KWh	\$	KWh	\$	KWh	\$				
1	2016	0.1501	4,621	\$694	403	\$60	4,385	\$658	9,409	\$1,412	0.05	0.1001	\$941.68	
2	2017	0.1542	4,621	\$712	403	\$62	4,385	\$676	9,409	\$1,451	0.05	0.1042	\$980.29	
3	2018	0.1583	4,621	\$731	403	\$64	4,385	\$694	9,409	\$1,489	0.05	0.1083	\$1,018.91	
4	2019	0.1625	4,621	\$751	403	\$66	4,385	\$713	9,409	\$1,529	0.05	0.1125	\$1,058.88	
5	2020	0.1668	4,621	\$771	403	\$67	4,385	\$731	9,409	\$1,569	0.05	0.1168	\$1,098.85	
6	2021	0.1621	4,621	\$749	403	\$65	4,385	\$711	9,409	\$1,526	0.05	0.1121	\$1,055.15	
7	2022	0.1629	4,621	\$753	403	\$66	4,385	\$714	9,409	\$1,533	0.05	0.1129	\$1,062.60	
8	2023	0.1639	4,621	\$757	403	\$66	4,385	\$719	9,409	\$1,542	0.05	0.1139	\$1,071.41	
9	2024	0.1648	4,621	\$762	403	\$66	4,385	\$723	9,409	\$1,551	0.05	0.1148	\$1,080.22	
10	2025	0.1656	4,621	\$765	403	\$67	4,385	\$726	9,409	\$1,558	0.05	0.1156	\$1,087.67	
11	2026	0.1665	4,621	\$770	403	\$67	4,385	\$730	9,409	\$1,567	0.05	0.1165	\$1,096.47	
12	2027	0.1674	4,621	\$774	403	\$67	4,385	\$734	9,409	\$1,575	0.05	0.1174	\$1,104.94	
13	2028	0.1683	4,621	\$778	403	\$68	4,385	\$738	9,409	\$1,583	0.05	0.1183	\$1,112.73	
14	2029	0.1692	4,621	\$782	403	\$68	4,385	\$742	9,409	\$1,592	0.05	0.1192	\$1,121.20	
15	2030	0.1701	4,621	\$786	403	\$69	4,385	\$746	9,409	\$1,600	0.05	0.1201	\$1,130.01	
16	2031	0.1704	4,621	\$787	403	\$69	4,385	\$747	9,409	\$1,603	0.05	0.1204	\$1,132.38	
17	2032	0.1705	4,621	\$788	403	\$69	4,385	\$748	9,409	\$1,604	0.05	0.1205	\$1,133.73	
18	2033	0.1707	4,621	\$789	403	\$69	4,385	\$749	9,409	\$1,607	0.05	0.1207	\$1,136.11	
19	2034	0.1710	4,621	\$790	403	\$69	4,385	\$750	9,409	\$1,609	0.05	0.1210	\$1,138.81	
20	2035	0.1713	4,621	\$792	403	\$69	4,385	\$751	9,409	\$1,612	0.05	0.1213	\$1,141.19	
21	2036	0.1714	4,621	\$792	403	\$69	4,385	\$752	9,409	\$1,613	0.05	0.1214	\$1,142.54	
22	2037	0.1717	4,621	\$793	403	\$69	4,385	\$753	9,409	\$1,615	0.05	0.1217	\$1,144.91	
23	2038	0.1720	4,621	\$795	403	\$69	4,385	\$754	9,409	\$1,618	0.05	0.1220	\$1,147.62	
24	2039	0.1722	4,621	\$796	403	\$69	4,385	\$755	9,409	\$1,620	0.05	0.1222	\$1,149.99	
25	2040	0.1724	4,621	\$797	403	\$69	4,385	\$756	9,409	\$1,622	0.05	0.1224	\$1,151.35	
26	2041	0.1734	4,621	\$801	403	\$70	4,385	\$760	9,409	\$1,631	0.05	0.1234	\$1,160.73	
27	2042	0.1744	4,621	\$806	403	\$70	4,385	\$765	9,409	\$1,641	0.05	0.1244	\$1,170.17	
28	2043	0.1754	4,621	\$810	403	\$71	4,385	\$769	9,409	\$1,650	0.05	0.1254	\$1,179.66	
29	2044	0.1764	4,621	\$815	403	\$71	4,385	\$773	9,409	\$1,660	0.05	0.1264	\$1,189.20	
30	2045	0.1774	4,621	\$820	403	\$71	4,385	\$778	9,409	\$1,669	0.05	0.1274	\$1,198.80	
31	2046	0.1784	4,621	\$825	403	\$72	4,385	\$782	9,409	\$1,679	0.05	0.1284	\$1,208.46	
32	2047	0.1795	4,621	\$829	403	\$72	4,385	\$787	9,409	\$1,689	0.05	0.1295	\$1,218.17	
33	2048	0.1805	4,621	\$834	403	\$73	4,385	\$792	9,409	\$1,698	0.05	0.1305	\$1,227.94	
34	2049	0.1816	4,621	\$839	403	\$73	4,385	\$796	9,409	\$1,708	0.05	0.1316	\$1,237.76	
35	2050	0.1826	4,621	\$844	403	\$74	4,385	\$801	9,409	\$1,718	0.05	0.1326	\$1,247.65	
36	2051	0.1837	4,621	\$849	403	\$74	4,385	\$805	9,409	\$1,728	0.05	0.1337	\$1,257.59	
37	2052	0.1847	4,621	\$854	403	\$74	4,385	\$810	9,409	\$1,738	0.05	0.1347	\$1,267.58	
38	2053	0.1858	4,621	\$859	403	\$75	4,385	\$815	9,409	\$1,748	0.05	0.1358	\$1,277.64	
39	2054	0.1869	4,621	\$863	403	\$75	4,385	\$819	9,409	\$1,758	0.05	0.1369	\$1,287.75	
40	2055	0.1879	4,621	\$868	403	\$76	4,385	\$824	9,409	\$1,768	0.05	0.1379	\$1,297.92	
41	2056	0.1890	4,621	\$874	403	\$76	4,385	\$829	9,409	\$1,779	0.05	0.1390	\$1,308.15	
42	2057	0.1901	4,621	\$879	403	\$77	4,385	\$834	9,409	\$1,789	0.05	0.1401	\$1,318.44	
43	2058	0.1912	4,621	\$884	403	\$77	4,385	\$839	9,409	\$1,799	0.05	0.1412	\$1,328.79	
44	2059	0.1923	4,621	\$889	403	\$78	4,385	\$843	9,409	\$1,810	0.05	0.1423	\$1,339.20	
45	2060	0.1934	4,621	\$894	403	\$78	4,385	\$848	9,409	\$1,820	0.05	0.1434	\$1,349.66	
46	2061	0.1946	4,621	\$899	403	\$78	4,385	\$853	9,409	\$1,831	0.05	0.1446	\$1,360.19	
47	2062	0.1957	4,621	\$904	403	\$79	4,385	\$858	9,409	\$1,841	0.05	0.1457	\$1,370.78	
48	2063	0.1968	4,621	\$910	403	\$79	4,385	\$863	9,409	\$1,852	0.05	0.1468	\$1,381.43	
49	2064	0.1980	4,621	\$915	403	\$80	4,385	\$868	9,409	\$1,863	0.05	0.1480	\$1,392.15	
50	2065	0.1991	4,621	\$920	403	\$80	4,385	\$873	9,409	\$1,873	0.05	0.1491	\$1,402.92	
51	2066	0.2003	4,621	\$925	403	\$81	4,385	\$878	9,409	\$1,884	0.05	0.1503	\$1,413.76	
52	2067	0.2014	4,621	\$931	403	\$81	4,385	\$883	9,409	\$1,895	0.05	0.1514	\$1,424.66	
53	2068	0.2026	4,621	\$936	403	\$82	4,385	\$888	9,409	\$1,906	0.05	0.1526	\$1,435.62	
54	2069	0.2038	4,621	\$942	403	\$82	4,385	\$893	9,409	\$1,917	0.05	0.1538	\$1,446.65	
55	2070	0.2049	4,621	\$947	403	\$83	4,385	\$899	9,409	\$1,928	0.05	0.1549	\$1,457.74	
56	2071	0.2061	4,621	\$952	403	\$83	4,385	\$904	9,409	\$1,939	0.05	0.1561	\$1,468.89	
57	2072	0.2073	4,621	\$958	403	\$84	4,385	\$909	9,409	\$1,951	0.05	0.1573	\$1,480.11	
58	2073	0.2085	4,621	\$964	403	\$84	4,385	\$914	9,409	\$1,962	0.05	0.1585	\$1,491.40	
59	2074	0.2097	4,621	\$969	403	\$85	4,385	\$920	9,409	\$1,973	0.05	0.1597	\$1,502.74	
60	2075	0.2109	4,621	\$975	403	\$85	4,385	\$925	9,409	\$1,985	0.05	0.1609	\$1,514.16	

Table D1-1.25: Annual Operating Costs (V.GSHP) of a 2,000 square feet detached house above grade (average construction type) in the city of Niagara Falls (two life cycles and three life cycles for a 60 year project lifespan); base case scenario in comparison with feed in-tariff (FIT) scenario. In the FIT scenario, an incentive of \$0.05/KWh is provided on electricity bills throughout the project lifespan

Horizontal Ground Source Heat Pump (H.GSHP)

Base Case Scenario											Feed in Tariff (FIT)		
H.GSHP											FIT		
#	Year	Electricity Rates \$/KWh	Heating KWh	Heating Operating Cost \$	Cooling KWh	Cooling Operating Cost \$	Hot Water KWh	Hot Water Operating Cost \$	Total KWh	Total Operating Cost \$	Incentives (\$/KWh)	\$/KWh	Operating Cost
1	2016	0.1501	4,700	\$705	411	\$62	4,360	\$654	9,471	\$1,421	0.05	0.1001	\$947.88
2	2017	0.1542	4,700	\$725	411	\$63	4,360	\$672	9,471	\$1,460	0.05	0.1042	\$986.75
3	2018	0.1583	4,700	\$744	411	\$65	4,360	\$690	9,471	\$1,499	0.05	0.1083	\$1,025.62
4	2019	0.1625	4,700	\$764	411	\$67	4,360	\$709	9,471	\$1,539	0.05	0.1125	\$1,065.85
5	2020	0.1668	4,700	\$784	411	\$69	4,360	\$727	9,471	\$1,580	0.05	0.1168	\$1,106.09
6	2021	0.1621	4,700	\$762	411	\$67	4,360	\$707	9,471	\$1,536	0.05	0.1121	\$1,062.10
7	2022	0.1629	4,700	\$766	411	\$67	4,360	\$710	9,471	\$1,543	0.05	0.1129	\$1,069.60
8	2023	0.1639	4,700	\$770	411	\$67	4,360	\$714	9,471	\$1,552	0.05	0.1139	\$1,078.47
9	2024	0.1648	4,700	\$775	411	\$68	4,360	\$719	9,471	\$1,561	0.05	0.1148	\$1,087.33
10	2025	0.1656	4,700	\$778	411	\$68	4,360	\$722	9,471	\$1,568	0.05	0.1156	\$1,094.84
11	2026	0.1665	4,700	\$783	411	\$68	4,360	\$726	9,471	\$1,577	0.05	0.1165	\$1,103.70
12	2027	0.1674	4,700	\$787	411	\$69	4,360	\$730	9,471	\$1,586	0.05	0.1174	\$1,112.22
13	2028	0.1683	4,700	\$791	411	\$69	4,360	\$734	9,471	\$1,594	0.05	0.1183	\$1,120.07
14	2029	0.1692	4,700	\$795	411	\$70	4,360	\$738	9,471	\$1,602	0.05	0.1192	\$1,128.59
15	2030	0.1701	4,700	\$799	411	\$70	4,360	\$742	9,471	\$1,611	0.05	0.1201	\$1,137.45
16	2031	0.1704	4,700	\$801	411	\$70	4,360	\$743	9,471	\$1,613	0.05	0.1204	\$1,139.84
17	2032	0.1705	4,700	\$801	411	\$70	4,360	\$743	9,471	\$1,615	0.05	0.1205	\$1,141.20
18	2033	0.1707	4,700	\$803	411	\$70	4,360	\$744	9,471	\$1,617	0.05	0.1207	\$1,143.59
19	2034	0.1710	4,700	\$804	411	\$70	4,360	\$746	9,471	\$1,620	0.05	0.1210	\$1,146.32
20	2035	0.1713	4,700	\$805	411	\$70	4,360	\$747	9,471	\$1,622	0.05	0.1213	\$1,148.71
21	2036	0.1714	4,700	\$806	411	\$70	4,360	\$747	9,471	\$1,624	0.05	0.1214	\$1,150.07
22	2037	0.1717	4,700	\$807	411	\$71	4,360	\$749	9,471	\$1,626	0.05	0.1217	\$1,152.46
23	2038	0.1720	4,700	\$808	411	\$71	4,360	\$750	9,471	\$1,629	0.05	0.1220	\$1,155.18
24	2039	0.1722	4,700	\$809	411	\$71	4,360	\$751	9,471	\$1,631	0.05	0.1222	\$1,157.57
25	2040	0.1724	4,700	\$810	411	\$71	4,360	\$752	9,471	\$1,632	0.05	0.1224	\$1,158.93
26	2041	0.1734	4,700	\$815	411	\$71	4,360	\$756	9,471	\$1,642	0.05	0.1234	\$1,168.38
27	2042	0.1744	4,700	\$820	411	\$72	4,360	\$760	9,471	\$1,651	0.05	0.1244	\$1,177.88
28	2043	0.1754	4,700	\$824	411	\$72	4,360	\$765	9,471	\$1,661	0.05	0.1254	\$1,187.43
29	2044	0.1764	4,700	\$829	411	\$72	4,360	\$769	9,471	\$1,671	0.05	0.1264	\$1,197.04
30	2045	0.1774	4,700	\$834	411	\$73	4,360	\$774	9,471	\$1,680	0.05	0.1274	\$1,206.70
31	2046	0.1784	4,700	\$839	411	\$73	4,360	\$778	9,471	\$1,690	0.05	0.1284	\$1,216.42
32	2047	0.1795	4,700	\$844	411	\$74	4,360	\$782	9,471	\$1,700	0.05	0.1295	\$1,226.20
33	2048	0.1805	4,700	\$848	411	\$74	4,360	\$787	9,471	\$1,710	0.05	0.1305	\$1,236.03
34	2049	0.1816	4,700	\$853	411	\$75	4,360	\$792	9,471	\$1,719	0.05	0.1316	\$1,245.92
35	2050	0.1826	4,700	\$858	411	\$75	4,360	\$796	9,471	\$1,729	0.05	0.1326	\$1,255.87
36	2051	0.1837	4,700	\$863	411	\$75	4,360	\$801	9,471	\$1,739	0.05	0.1337	\$1,265.87
37	2052	0.1847	4,700	\$868	411	\$76	4,360	\$805	9,471	\$1,749	0.05	0.1347	\$1,275.93
38	2053	0.1858	4,700	\$873	411	\$76	4,360	\$810	9,471	\$1,760	0.05	0.1358	\$1,286.06
39	2054	0.1869	4,700	\$878	411	\$77	4,360	\$815	9,471	\$1,770	0.05	0.1369	\$1,296.23
40	2055	0.1879	4,700	\$883	411	\$77	4,360	\$819	9,471	\$1,780	0.05	0.1379	\$1,306.47
41	2056	0.1890	4,700	\$888	411	\$78	4,360	\$824	9,471	\$1,790	0.05	0.1390	\$1,316.77
42	2057	0.1901	4,700	\$894	411	\$78	4,360	\$829	9,471	\$1,801	0.05	0.1401	\$1,327.13
43	2058	0.1912	4,700	\$899	411	\$79	4,360	\$834	9,471	\$1,811	0.05	0.1412	\$1,337.54
44	2059	0.1923	4,700	\$904	411	\$79	4,360	\$839	9,471	\$1,822	0.05	0.1423	\$1,348.02
45	2060	0.1934	4,700	\$909	411	\$80	4,360	\$843	9,471	\$1,832	0.05	0.1434	\$1,358.56
46	2061	0.1946	4,700	\$914	411	\$80	4,360	\$848	9,471	\$1,843	0.05	0.1446	\$1,369.16
47	2062	0.1957	4,700	\$920	411	\$80	4,360	\$853	9,471	\$1,853	0.05	0.1457	\$1,379.82
48	2063	0.1968	4,700	\$925	411	\$81	4,360	\$858	9,471	\$1,864	0.05	0.1468	\$1,390.54
49	2064	0.1980	4,700	\$930	411	\$81	4,360	\$863	9,471	\$1,875	0.05	0.1480	\$1,401.32
50	2065	0.1991	4,700	\$936	411	\$82	4,360	\$868	9,471	\$1,886	0.05	0.1491	\$1,412.17
51	2066	0.2003	4,700	\$941	411	\$82	4,360	\$873	9,471	\$1,897	0.05	0.1503	\$1,423.07
52	2067	0.2014	4,700	\$947	411	\$83	4,360	\$878	9,471	\$1,908	0.05	0.1514	\$1,434.05
53	2068	0.2026	4,700	\$952	411	\$83	4,360	\$883	9,471	\$1,919	0.05	0.1526	\$1,445.08
54	2069	0.2038	4,700	\$958	411	\$84	4,360	\$888	9,471	\$1,930	0.05	0.1538	\$1,456.18
55	2070	0.2049	4,700	\$963	411	\$84	4,360	\$893	9,471	\$1,941	0.05	0.1549	\$1,467.34
56	2071	0.2061	4,700	\$969	411	\$85	4,360	\$899	9,471	\$1,952	0.05	0.1561	\$1,478.57
57	2072	0.2073	4,700	\$974	411	\$85	4,360	\$904	9,471	\$1,963	0.05	0.1573	\$1,489.86
58	2073	0.2085	4,700	\$980	411	\$86	4,360	\$909	9,471	\$1,975	0.05	0.1585	\$1,501.22
59	2074	0.2097	4,700	\$986	411	\$86	4,360	\$914	9,471	\$1,986	0.05	0.1597	\$1,512.65
60	2075	0.2109	4,700	\$991	411	\$87	4,360	\$920	9,471	\$1,998	0.05	0.1609	\$1,524.14

Table D1-1.26: Annual Operating Costs (H.GSHP) of a 2,000 square feet detached house above grade (average construction type) in the city of Niagara Falls (two life cycles and three life cycles for a 60 year project lifespan); base case scenario in comparison with feed in-tariff (FIT) scenario. In the FIT scenario, an incentive of \$0.05/KWh is provided on electricity bills throughout the project lifespan

Traditional HVAC Applications

Base Case Scenario															Carbon Taxes						
#	Year	Electricity Rates \$/KWh	Natural Gas Rates \$/m ³	Heating		Heating Operating Cost \$ (Electricity)	Heating Operating Cost \$ (Gas)	Total Heating Operating Cost \$	Cooling		Hot Water m ³	Hot Water Operating Cost \$	Total KWh	Total m ³	Total Electricity Operating Cost \$ (KWh)	Total Natural Gas Operating Cost \$ (m ³)	Total	Conversion of m ³ into Tons	Total Tons	Carbon Tax	Operating Costs
				KWh (Electricity)	m ³ (Gas)				KWh	\$											
1	2016	0.1501	0.3458	1,928	2,264	\$289	\$783	\$1,072	1,015	\$351	3,796	3,279	570	\$1,134	\$1,704	5.93	5.93	\$10	\$59.35	\$1,763.04	
2	2017	0.1542	0.3588	1,928	2,264	\$297	\$812	\$1,110	1,015	\$156	3,796	3,279	585	\$1,177	\$1,762	5.93	5.93	\$20	\$118.70	\$1,880.62	
3	2018	0.1583	0.3718	1,928	2,264	\$305	\$842	\$1,147	1,015	\$161	3,796	3,279	601	\$1,219	\$1,820	5.93	5.93	\$30	\$178.05	\$1,998.20	
4	2019	0.1625	0.3776	1,928	2,264	\$313	\$855	\$1,168	1,015	\$165	3,796	3,279	617	\$1,238	\$1,855	5.93	5.93	\$40	\$237.40	\$2,092.49	
5	2020	0.1668	0.3841	1,928	2,264	\$322	\$870	\$1,191	1,015	\$169	3,796	3,279	633	\$1,259	\$1,893	5.93	5.93	\$50	\$296.75	\$2,189.29	
6	2021	0.1621	0.3883	1,928	2,264	\$313	\$879	\$1,192	1,015	\$165	3,796	3,279	615	\$1,273	\$1,889	5.93	5.93	\$60	\$356.10	\$2,244.81	
7	2022	0.1629	0.3929	1,928	2,264	\$314	\$889	\$1,204	1,015	\$165	3,796	3,279	619	\$1,288	\$1,907	5.93	5.93	\$70	\$415.45	\$2,322.22	
8	2023	0.1639	0.3967	1,928	2,264	\$316	\$898	\$1,214	1,015	\$166	3,796	3,279	622	\$1,301	\$1,923	5.93	5.93	\$80	\$474.80	\$2,397.66	
9	2024	0.1648	0.4005	1,928	2,264	\$318	\$907	\$1,225	1,015	\$167	3,796	3,279	626	\$1,313	\$1,939	5.93	5.93	\$90	\$534.15	\$2,473.11	
10	2025	0.1656	0.4040	1,928	2,264	\$319	\$915	\$1,234	1,015	\$168	3,796	3,279	629	\$1,325	\$1,953	5.93	5.93	\$100	\$593.50	\$2,546.76	
11	2026	0.1665	0.4070	1,928	2,264	\$321	\$922	\$1,243	1,015	\$169	3,796	3,279	632	\$1,335	\$1,967	5.93	5.93	\$110	\$652.85	\$2,619.70	
12	2027	0.1674	0.4097	1,928	2,264	\$323	\$928	\$1,250	1,015	\$170	3,796	3,279	636	\$1,343	\$1,979	5.93	5.93	\$120	\$712.20	\$2,691.24	
13	2028	0.1683	0.4124	1,928	2,264	\$324	\$934	\$1,258	1,015	\$171	3,796	3,279	639	\$1,352	\$1,991	5.93	5.93	\$130	\$771.55	\$2,762.52	
14	2029	0.1692	0.4151	1,928	2,264	\$326	\$940	\$1,266	1,015	\$172	3,796	3,279	642	\$1,361	\$2,003	5.93	5.93	\$140	\$830.90	\$2,834.06	
15	2030	0.1701	0.4170	1,928	2,264	\$328	\$944	\$1,272	1,015	\$173	3,796	3,279	646	\$1,367	\$2,013	5.93	5.93	\$150	\$890.25	\$2,903.24	
16	2031	0.1704	0.4189	1,928	2,264	\$328	\$948	\$1,277	1,015	\$173	3,796	3,279	647	\$1,374	\$2,020	5.93	5.93	\$160	\$949.60	\$2,969.82	
17	2032	0.1705	0.4204	1,928	2,264	\$329	\$952	\$1,281	1,015	\$173	3,796	3,279	647	\$1,379	\$2,026	5.93	5.93	\$170	\$1,008.95	\$3,034.73	
18	2033	0.1707	0.4223	1,928	2,264	\$329	\$956	\$1,285	1,015	\$173	3,796	3,279	648	\$1,385	\$2,033	5.93	5.93	\$180	\$1,068.30	\$3,101.31	
19	2034	0.1710	0.4246	1,928	2,264	\$330	\$961	\$1,291	1,015	\$174	3,796	3,279	649	\$1,392	\$2,042	5.93	5.93	\$190	\$1,127.65	\$3,169.28	
20	2035	0.1713	0.4265	1,928	2,264	\$330	\$965	\$1,296	1,015	\$174	3,796	3,279	650	\$1,399	\$2,049	5.93	5.93	\$200	\$1,187.00	\$3,235.86	
21	2036	0.1714	0.4288	1,928	2,264	\$331	\$971	\$1,301	1,015	\$174	3,796	3,279	651	\$1,406	\$2,057	5.93	5.93	\$210	\$1,246.35	\$3,303.28	
22	2037	0.1717	0.4311	1,928	2,264	\$331	\$976	\$1,307	1,015	\$174	3,796	3,279	652	\$1,414	\$2,065	5.93	5.93	\$220	\$1,305.70	\$3,371.11	
23	2038	0.1720	0.4331	1,928	2,264	\$332	\$980	\$1,312	1,015	\$175	3,796	3,279	653	\$1,420	\$2,073	5.93	5.93	\$230	\$1,365.05	\$3,437.83	
24	2039	0.1722	0.4353	1,928	2,264	\$332	\$986	\$1,318	1,015	\$175	3,796	3,279	654	\$1,428	\$2,081	5.93	5.93	\$240	\$1,424.40	\$3,505.66	
25	2040	0.1724	0.4376	1,928	2,264	\$332	\$991	\$1,323	1,015	\$175	3,796	3,279	654	\$1,435	\$2,089	5.93	5.93	\$250	\$1,483.75	\$3,573.08	
26	2041	0.1734	0.4420	1,928	2,264	\$334	\$1,001	\$1,335	1,015	\$176	3,796	3,279	658	\$1,449	\$2,107	5.93	5.93	\$260	\$1,543.10	\$3,650.37	
27	2042	0.1744	0.4463	1,928	2,264	\$336	\$1,010	\$1,347	1,015	\$177	3,796	3,279	662	\$1,463	\$2,125	5.93	5.93	\$270	\$1,602.45	\$3,727.81	
28	2043	0.1754	0.4507	1,928	2,264	\$338	\$1,020	\$1,359	1,015	\$178	3,796	3,279	666	\$1,478	\$2,144	5.93	5.93	\$280	\$1,661.80	\$3,805.42	
29	2044	0.1764	0.4552	1,928	2,264	\$340	\$1,030	\$1,371	1,015	\$179	3,796	3,279	670	\$1,492	\$2,162	5.93	5.93	\$290	\$1,721.15	\$3,883.19	
30	2045	0.1774	0.4596	1,928	2,264	\$342	\$1,041	\$1,383	1,015	\$180	3,796	3,279	673	\$1,507	\$2,181	5.93	5.93	\$300	\$1,780.50	\$3,961.13	
31	2046	0.1784	0.4642	1,928	2,264	\$344	\$1,051	\$1,395	1,015	\$181	3,796	3,279	677	\$1,522	\$2,199	5.93	5.93	\$310	\$1,839.85	\$4,039.23	
32	2047	0.1795	0.4688	1,928	2,264	\$346	\$1,061	\$1,407	1,015	\$182	3,796	3,279	681	\$1,537	\$2,218	5.93	5.93	\$320	\$1,899.20	\$4,117.51	
33	2048	0.1805	0.4734	1,928	2,264	\$348	\$1,072	\$1,420	1,015	\$183	3,796	3,279	685	\$1,552	\$2,237	5.93	5.93	\$330	\$1,958.55	\$4,195.95	
34	2049	0.1816	0.4780	1,928	2,264	\$350	\$1,082	\$1,432	1,015	\$184	3,796	3,279	689	\$1,568	\$2,257	5.93	5.93	\$340	\$2,017.90	\$4,274.57	
35	2050	0.1826	0.4828	1,928	2,264	\$352	\$1,093	\$1,445	1,015	\$185	3,796	3,279	693	\$1,583	\$2,276	5.93	5.93	\$350	\$2,077.25	\$4,353.36	
36	2051	0.1837	0.4875	1,928	2,264	\$354	\$1,104	\$1,458	1,015	\$186	3,796	3,279	697	\$1,599	\$2,296	5.93	5.93	\$360	\$2,136.60	\$4,432.32	
37	2052	0.1847	0.4923	1,928	2,264	\$356	\$1,115	\$1,471	1,015	\$187	3,796	3,279	701	\$1,614	\$2,316	5.93	5.93	\$370	\$2,195.95	\$4,511.47	
38	2053	0.1858	0.4972	1,928	2,264	\$358	\$1,126	\$1,484	1,015	\$189	3,796	3,279	705	\$1,630	\$2,335	5.93	5.93	\$380	\$2,255.30	\$4,590.79	
39	2054	0.1869	0.5021	1,928	2,264	\$360	\$1,137	\$1,497	1,015	\$190	3,796	3,279	709	\$1,646	\$2,356	5.93	5.93	\$390	\$2,314.65	\$4,670.29	
40	2055	0.1879	0.5070	1,928	2,264	\$362	\$1,148	\$1,510	1,015	\$191	3,796	3,279	713	\$1,663	\$2,376	5.93	5.93	\$400	\$2,374.00	\$4,749.98	
41	2056	0.1890	0.5120	1,928	2,264	\$364	\$1,159	\$1,524	1,015	\$192	3,796	3,279	718	\$1,679	\$2,396	5.93	5.93	\$410	\$2,433.35	\$4,829.84	
42	2057	0.1901	0.5171	1,928	2,264	\$367	\$1,171	\$1,537	1,015	\$193	3,796	3,279	722	\$1,695	\$2,417	5.93	5.93	\$420	\$2,492.70	\$4,909.90	
43	2058	0.1912	0.5222	1,928	2,264	\$369	\$1,182	\$1,551	1,015	\$194	3,796	3,279	726	\$1,712	\$2,438	5.93	5.93	\$430	\$2,552.05	\$4,990.14	
44	2059	0.1923	0.5273	1,928	2,264	\$371	\$1,194	\$1,565	1,015	\$195	3,796	3,279	730	\$1,729	\$2,459	5.93	5.93	\$440	\$2,611.40	\$5,070.57	
45	2060	0.1934	0.5325	1,928	2,264	\$373	\$1,206	\$1,579	1,015	\$196	3,796	3,279	734	\$1,746	\$2,480	5.93	5.93	\$450	\$2,670.75	\$5,151.19	
46	2061	0.1946	0.5378	1,928	2,264	\$375	\$1,218	\$1,593	1,015	\$197	3,796	3,279	739	\$1,763	\$2,502	5.93	5.93	\$460	\$2,730.10	\$5,232.00	
47	2062	0.1957	0.5431	1,928	2,264	\$377	\$1,230	\$1,607	1,015	\$199	3,796	3,279	743	\$1,781	\$2,524	5.93	5.93	\$470	\$2,789.45	\$5,313.01	
48	2063	0.1968	0.5484	1,928	2,264	\$379	\$1,242	\$1,621	1,015	\$200	3,796	3,279	747	\$1,798	\$2,545	5.93	5.93	\$480	\$2,848.80	\$5,394.21	
49	2064	0.1980	0.5538	1,928	2,264	\$382	\$1,254	\$1,636	1,015	\$201	3,796	3,279	751	\$1,816	\$2,567	5.93	5.93	\$490	\$2,908.15	\$5,475.61	
50	2065	0.1991	0.5593	1,928	2,264	\$384	\$1,266	\$1,650	1,015	\$202	3,796	3,279	756	\$1,834	\$2,590	5.93	5.93	\$500	\$2,967.50	\$5,557.21	
51	2066	0.2003	0.5648	1,928	2,264	\$386	\$1,279	\$1,665	1,015	\$203	3,796	3,279	760	\$1,852	\$2,612	5.93	5.93	\$510	\$3,026.85	\$5,639.02	
52	2067	0.2014	0.5704	1,928	2,264	\$388	\$1,291	\$1,680	1,015	\$204	3,796	3,279	765	\$1,870	\$2,635	5.93	5.93	\$520	\$3,086.19	\$5,721.02	
53	2068	0.2026	0.5760	1,928	2,264	\$391	\$1,304	\$1,695	1,015	\$206	3,796	3,279	769	\$1,889	\$2,658	5.93	5.93	\$530	\$3,145.54	\$5,803.23	
54	2069	0.2038	0.5817	1,928	2,264	\$393	\$1,317	\$1,710	1,015	\$207	3,796	3,279	773	\$1,907	\$2,681	5.93	5.93	\$540	\$3,204.89	\$5,885.65	
55	2070	0.2049	0.5874	1,928	2,264	\$395	\$1,330	\$1,725	1,015	\$208	3,796	3,279	778	\$1,926	\$2,704	5.93	5.93	\$550	\$3,264.24	\$5,968.28	
56	2071	0.2061	0.5932	1,928	2,264	\$397	\$1,343	\$1,740	1,015	\$209	3,796	3,279	782	\$1,945	\$2,728	5.93	5.93	\$560	\$3,323.59	\$6,051.12	
57	2072	0.2073	0.5991	1,928	2,264	\$400	\$1,356	\$1,756	1,015	\$210	3,796	3,279	787	\$1,964	\$2,751	5.93	5.93	\$570	\$3,382.94	\$6,134.17	
58	2073	0.2085	0.6050	1,928	2,264	\$402	\$1,370	\$1,772													

10. Sarnia (South) – Annual Operating Costs

Vertical Ground Source Heat Pump (V.GSHP)

Base Case Scenario												Feed in Tariff (FIT)		
#	Year	Electricity Rates		V.GSHP		V.GSHP		V.GSHP		Total KWh	Total Operating Cost \$	FIT		
		\$/KWh	KWh	Heating Operating Cost \$	Cooling KWh	Cooling Operating Cost \$	Hot Water KWh	Hot Water Operating Cost \$	Incentives (\$/KWh)			S/KWh	Operating Cost	
1	2016	0.1501	4,914	\$738	400	\$60	3,928	\$590	9,242	\$1,387	0.05	0.1001	\$924.97	
2	2017	0.1542	4,914	\$758	400	\$62	3,928	\$606	9,242	\$1,425	0.05	0.1042	\$962.89	
3	2018	0.1583	4,914	\$778	400	\$63	3,928	\$622	9,242	\$1,463	0.05	0.1083	\$1,000.82	
4	2019	0.1625	4,914	\$799	400	\$65	3,928	\$638	9,242	\$1,502	0.05	0.1125	\$1,040.08	
5	2020	0.1668	4,914	\$820	400	\$67	3,928	\$655	9,242	\$1,541	0.05	0.1168	\$1,079.34	
6	2021	0.1621	4,914	\$797	400	\$65	3,928	\$637	9,242	\$1,499	0.05	0.1121	\$1,036.42	
7	2022	0.1629	4,914	\$801	400	\$65	3,928	\$640	9,242	\$1,506	0.05	0.1129	\$1,043.74	
8	2023	0.1639	4,914	\$805	400	\$66	3,928	\$644	9,242	\$1,514	0.05	0.1139	\$1,052.39	
9	2024	0.1648	4,914	\$810	400	\$66	3,928	\$647	9,242	\$1,523	0.05	0.1148	\$1,061.04	
10	2025	0.1656	4,914	\$814	400	\$66	3,928	\$650	9,242	\$1,530	0.05	0.1156	\$1,068.36	
11	2026	0.1665	4,914	\$818	400	\$67	3,928	\$654	9,242	\$1,539	0.05	0.1165	\$1,077.01	
12	2027	0.1674	4,914	\$823	400	\$67	3,928	\$658	9,242	\$1,547	0.05	0.1174	\$1,085.33	
13	2028	0.1683	4,914	\$827	400	\$67	3,928	\$661	9,242	\$1,555	0.05	0.1183	\$1,092.98	
14	2029	0.1692	4,914	\$831	400	\$68	3,928	\$664	9,242	\$1,563	0.05	0.1192	\$1,101.30	
15	2030	0.1701	4,914	\$836	400	\$68	3,928	\$668	9,242	\$1,572	0.05	0.1201	\$1,109.95	
16	2031	0.1704	4,914	\$837	400	\$68	3,928	\$669	9,242	\$1,574	0.05	0.1204	\$1,112.28	
17	2032	0.1705	4,914	\$838	400	\$68	3,928	\$670	9,242	\$1,576	0.05	0.1205	\$1,113.61	
18	2033	0.1707	4,914	\$839	400	\$68	3,928	\$671	9,242	\$1,578	0.05	0.1207	\$1,115.94	
19	2034	0.1710	4,914	\$840	400	\$68	3,928	\$672	9,242	\$1,581	0.05	0.1210	\$1,118.60	
20	2035	0.1713	4,914	\$842	400	\$69	3,928	\$673	9,242	\$1,583	0.05	0.1213	\$1,120.93	
21	2036	0.1714	4,914	\$842	400	\$69	3,928	\$673	9,242	\$1,584	0.05	0.1214	\$1,122.26	
22	2037	0.1717	4,914	\$844	400	\$69	3,928	\$674	9,242	\$1,587	0.05	0.1217	\$1,124.59	
23	2038	0.1720	4,914	\$845	400	\$69	3,928	\$676	9,242	\$1,589	0.05	0.1220	\$1,127.25	
24	2039	0.1722	4,914	\$846	400	\$69	3,928	\$676	9,242	\$1,592	0.05	0.1222	\$1,129.58	
25	2040	0.1724	4,914	\$847	400	\$69	3,928	\$677	9,242	\$1,593	0.05	0.1224	\$1,130.91	
26	2041	0.1734	4,914	\$852	400	\$69	3,928	\$681	9,242	\$1,602	0.05	0.1234	\$1,140.13	
27	2042	0.1744	4,914	\$857	400	\$70	3,928	\$685	9,242	\$1,611	0.05	0.1244	\$1,149.40	
28	2043	0.1754	4,914	\$862	400	\$70	3,928	\$689	9,242	\$1,621	0.05	0.1254	\$1,158.72	
29	2044	0.1764	4,914	\$867	400	\$71	3,928	\$693	9,242	\$1,630	0.05	0.1264	\$1,168.09	
30	2045	0.1774	4,914	\$872	400	\$71	3,928	\$697	9,242	\$1,640	0.05	0.1274	\$1,177.53	
31	2046	0.1784	4,914	\$877	400	\$71	3,928	\$701	9,242	\$1,649	0.05	0.1284	\$1,187.01	
32	2047	0.1795	4,914	\$882	400	\$72	3,928	\$705	9,242	\$1,659	0.05	0.1295	\$1,196.55	
33	2048	0.1805	4,914	\$887	400	\$72	3,928	\$709	9,242	\$1,668	0.05	0.1305	\$1,206.15	
34	2049	0.1816	4,914	\$892	400	\$73	3,928	\$713	9,242	\$1,678	0.05	0.1316	\$1,215.80	
35	2050	0.1826	4,914	\$897	400	\$73	3,928	\$717	9,242	\$1,688	0.05	0.1326	\$1,225.50	
36	2051	0.1837	4,914	\$902	400	\$73	3,928	\$721	9,242	\$1,697	0.05	0.1337	\$1,235.26	
37	2052	0.1847	4,914	\$908	400	\$74	3,928	\$726	9,242	\$1,707	0.05	0.1347	\$1,245.08	
38	2053	0.1858	4,914	\$913	400	\$74	3,928	\$730	9,242	\$1,717	0.05	0.1358	\$1,254.96	
39	2054	0.1869	4,914	\$918	400	\$75	3,928	\$734	9,242	\$1,727	0.05	0.1369	\$1,264.89	
40	2055	0.1879	4,914	\$924	400	\$75	3,928	\$738	9,242	\$1,737	0.05	0.1379	\$1,274.88	
41	2056	0.1890	4,914	\$929	400	\$76	3,928	\$743	9,242	\$1,747	0.05	0.1390	\$1,284.93	
42	2057	0.1901	4,914	\$934	400	\$76	3,928	\$747	9,242	\$1,757	0.05	0.1401	\$1,295.04	
43	2058	0.1912	4,914	\$940	400	\$76	3,928	\$751	9,242	\$1,767	0.05	0.1412	\$1,305.20	
44	2059	0.1923	4,914	\$945	400	\$77	3,928	\$755	9,242	\$1,778	0.05	0.1423	\$1,315.43	
45	2060	0.1934	4,914	\$951	400	\$77	3,928	\$760	9,242	\$1,788	0.05	0.1434	\$1,325.71	
46	2061	0.1946	4,914	\$956	400	\$78	3,928	\$764	9,242	\$1,798	0.05	0.1446	\$1,336.05	
47	2062	0.1957	4,914	\$962	400	\$78	3,928	\$769	9,242	\$1,809	0.05	0.1457	\$1,346.45	
48	2063	0.1968	4,914	\$967	400	\$79	3,928	\$773	9,242	\$1,819	0.05	0.1468	\$1,356.92	
49	2064	0.1980	4,914	\$973	400	\$79	3,928	\$778	9,242	\$1,830	0.05	0.1480	\$1,367.44	
50	2065	0.1991	4,914	\$978	400	\$80	3,928	\$782	9,242	\$1,840	0.05	0.1491	\$1,378.02	
51	2066	0.2003	4,914	\$984	400	\$80	3,928	\$787	9,242	\$1,851	0.05	0.1503	\$1,388.67	
52	2067	0.2014	4,914	\$990	400	\$81	3,928	\$791	9,242	\$1,861	0.05	0.1514	\$1,399.37	
53	2068	0.2026	4,914	\$995	400	\$81	3,928	\$796	9,242	\$1,872	0.05	0.1526	\$1,410.14	
54	2069	0.2038	4,914	\$1,001	400	\$82	3,928	\$800	9,242	\$1,883	0.05	0.1538	\$1,420.97	
55	2070	0.2049	4,914	\$1,007	400	\$82	3,928	\$805	9,242	\$1,894	0.05	0.1549	\$1,431.86	
56	2071	0.2061	4,914	\$1,013	400	\$82	3,928	\$810	9,242	\$1,905	0.05	0.1561	\$1,442.82	
57	2072	0.2073	4,914	\$1,019	400	\$83	3,928	\$814	9,242	\$1,916	0.05	0.1573	\$1,453.84	
58	2073	0.2085	4,914	\$1,025	400	\$83	3,928	\$819	9,242	\$1,927	0.05	0.1585	\$1,464.92	
59	2074	0.2097	4,914	\$1,031	400	\$84	3,928	\$824	9,242	\$1,938	0.05	0.1597	\$1,476.07	
60	2075	0.2109	4,914	\$1,036	400	\$84	3,928	\$829	9,242	\$1,949	0.05	0.1609	\$1,487.28	

Table D1-1.28: Annual Operating Costs (V.GSHP) of a 2,000 square feet detached house above grade (average construction type) in the city of Sarnia (two life cycles and three life cycles for a 60 year project lifespan); base case scenario in comparison with feed in-tariff (FIT) scenario. In the FIT scenario, an incentive of \$0.05/KWh is provided on electricity bills throughout the project lifespan

Horizontal Ground Source Heat Pump (H.GSHP)

Base Case Scenario											Feed in Tariff (FIT)		
H.GSHP											FIT		
#	Year	Electricity Rates \$/KWh	Heating KWh	Heating Operating Cost \$	Cooling KWh	Cooling Operating Cost \$	Hot Water KWh	Hot Water Operating Cost \$	Total KWh	Total Operating Cost \$	Incentives (\$/KWh)	\$/KWh	Operating Cost
1	2016	0.1501	4,981	\$748	409	\$61	3,908	\$587	9,298	\$1,395	0.05	0.1001	\$930.57
2	2017	0.1542	4,981	\$768	409	\$63	3,908	\$603	9,298	\$1,434	0.05	0.1042	\$968.73
3	2018	0.1583	4,981	\$788	409	\$65	3,908	\$619	9,298	\$1,472	0.05	0.1083	\$1,006.89
4	2019	0.1625	4,981	\$810	409	\$66	3,908	\$635	9,298	\$1,511	0.05	0.1125	\$1,046.38
5	2020	0.1668	4,981	\$831	409	\$68	3,908	\$652	9,298	\$1,551	0.05	0.1168	\$1,085.88
6	2021	0.1621	4,981	\$808	409	\$66	3,908	\$634	9,298	\$1,508	0.05	0.1121	\$1,042.70
7	2022	0.1629	4,981	\$812	409	\$67	3,908	\$637	9,298	\$1,515	0.05	0.1129	\$1,050.07
8	2023	0.1639	4,981	\$816	409	\$67	3,908	\$640	9,298	\$1,524	0.05	0.1139	\$1,058.77
9	2024	0.1648	4,981	\$821	409	\$67	3,908	\$644	9,298	\$1,532	0.05	0.1148	\$1,067.47
10	2025	0.1656	4,981	\$825	409	\$68	3,908	\$647	9,298	\$1,540	0.05	0.1156	\$1,074.84
11	2026	0.1665	4,981	\$830	409	\$68	3,908	\$651	9,298	\$1,548	0.05	0.1165	\$1,083.54
12	2027	0.1674	4,981	\$834	409	\$68	3,908	\$654	9,298	\$1,557	0.05	0.1174	\$1,091.91
13	2028	0.1683	4,981	\$838	409	\$69	3,908	\$658	9,298	\$1,565	0.05	0.1183	\$1,099.61
14	2029	0.1692	4,981	\$843	409	\$69	3,908	\$661	9,298	\$1,573	0.05	0.1192	\$1,107.97
15	2030	0.1701	4,981	\$847	409	\$70	3,908	\$665	9,298	\$1,582	0.05	0.1201	\$1,116.68
16	2031	0.1704	4,981	\$849	409	\$70	3,908	\$666	9,298	\$1,584	0.05	0.1204	\$1,119.02
17	2032	0.1705	4,981	\$849	409	\$70	3,908	\$666	9,298	\$1,585	0.05	0.1205	\$1,120.36
18	2033	0.1707	4,981	\$850	409	\$70	3,908	\$667	9,298	\$1,588	0.05	0.1207	\$1,122.70
19	2034	0.1710	4,981	\$852	409	\$70	3,908	\$668	9,298	\$1,590	0.05	0.1210	\$1,125.38
20	2035	0.1713	4,981	\$853	409	\$70	3,908	\$669	9,298	\$1,593	0.05	0.1213	\$1,127.72
21	2036	0.1714	4,981	\$854	409	\$70	3,908	\$670	9,298	\$1,594	0.05	0.1214	\$1,129.06
22	2037	0.1717	4,981	\$855	409	\$70	3,908	\$671	9,298	\$1,596	0.05	0.1217	\$1,131.41
23	2038	0.1720	4,981	\$857	409	\$70	3,908	\$672	9,298	\$1,599	0.05	0.1220	\$1,134.08
24	2039	0.1722	4,981	\$858	409	\$70	3,908	\$673	9,298	\$1,601	0.05	0.1222	\$1,136.43
25	2040	0.1724	4,981	\$859	409	\$70	3,908	\$674	9,298	\$1,603	0.05	0.1224	\$1,137.76
26	2041	0.1734	4,981	\$864	409	\$71	3,908	\$678	9,298	\$1,612	0.05	0.1234	\$1,147.04
27	2042	0.1744	4,981	\$869	409	\$71	3,908	\$681	9,298	\$1,621	0.05	0.1244	\$1,156.36
28	2043	0.1754	4,981	\$874	409	\$72	3,908	\$685	9,298	\$1,631	0.05	0.1254	\$1,165.74
29	2044	0.1764	4,981	\$879	409	\$72	3,908	\$689	9,298	\$1,640	0.05	0.1264	\$1,175.17
30	2045	0.1774	4,981	\$884	409	\$73	3,908	\$693	9,298	\$1,650	0.05	0.1274	\$1,184.66
31	2046	0.1784	4,981	\$889	409	\$73	3,908	\$697	9,298	\$1,659	0.05	0.1284	\$1,194.20
32	2047	0.1795	4,981	\$894	409	\$73	3,908	\$701	9,298	\$1,669	0.05	0.1295	\$1,203.80
33	2048	0.1805	4,981	\$899	409	\$74	3,908	\$705	9,298	\$1,678	0.05	0.1305	\$1,213.45
34	2049	0.1816	4,981	\$904	409	\$74	3,908	\$710	9,298	\$1,688	0.05	0.1316	\$1,223.16
35	2050	0.1826	4,981	\$910	409	\$75	3,908	\$714	9,298	\$1,698	0.05	0.1326	\$1,232.93
36	2051	0.1837	4,981	\$915	409	\$75	3,908	\$718	9,298	\$1,708	0.05	0.1337	\$1,242.75
37	2052	0.1847	4,981	\$920	409	\$76	3,908	\$722	9,298	\$1,718	0.05	0.1347	\$1,252.63
38	2053	0.1858	4,981	\$925	409	\$76	3,908	\$726	9,298	\$1,727	0.05	0.1358	\$1,262.56
39	2054	0.1869	4,981	\$931	409	\$76	3,908	\$730	9,298	\$1,737	0.05	0.1369	\$1,272.56
40	2055	0.1879	4,981	\$936	409	\$77	3,908	\$734	9,298	\$1,748	0.05	0.1379	\$1,282.61
41	2056	0.1890	4,981	\$942	409	\$77	3,908	\$739	9,298	\$1,758	0.05	0.1390	\$1,292.72
42	2057	0.1901	4,981	\$947	409	\$78	3,908	\$743	9,298	\$1,768	0.05	0.1401	\$1,302.88
43	2058	0.1912	4,981	\$952	409	\$78	3,908	\$747	9,298	\$1,778	0.05	0.1412	\$1,313.11
44	2059	0.1923	4,981	\$958	409	\$79	3,908	\$752	9,298	\$1,788	0.05	0.1423	\$1,323.40
45	2060	0.1934	4,981	\$964	409	\$79	3,908	\$756	9,298	\$1,799	0.05	0.1434	\$1,333.74
46	2061	0.1946	4,981	\$969	409	\$80	3,908	\$760	9,298	\$1,809	0.05	0.1446	\$1,344.15
47	2062	0.1957	4,981	\$975	409	\$80	3,908	\$765	9,298	\$1,820	0.05	0.1457	\$1,354.61
48	2063	0.1968	4,981	\$980	409	\$80	3,908	\$769	9,298	\$1,830	0.05	0.1468	\$1,365.14
49	2064	0.1980	4,981	\$986	409	\$81	3,908	\$774	9,298	\$1,841	0.05	0.1480	\$1,375.72
50	2065	0.1991	4,981	\$992	409	\$81	3,908	\$778	9,298	\$1,851	0.05	0.1491	\$1,386.37
51	2066	0.2003	4,981	\$997	409	\$82	3,908	\$783	9,298	\$1,862	0.05	0.1503	\$1,397.08
52	2067	0.2014	4,981	\$1,003	409	\$82	3,908	\$787	9,298	\$1,873	0.05	0.1514	\$1,407.85
53	2068	0.2026	4,981	\$1,009	409	\$83	3,908	\$792	9,298	\$1,884	0.05	0.1526	\$1,418.69
54	2069	0.2038	4,981	\$1,015	409	\$83	3,908	\$796	9,298	\$1,894	0.05	0.1538	\$1,429.58
55	2070	0.2049	4,981	\$1,021	409	\$84	3,908	\$801	9,298	\$1,905	0.05	0.1549	\$1,440.54
56	2071	0.2061	4,981	\$1,027	409	\$84	3,908	\$806	9,298	\$1,916	0.05	0.1561	\$1,451.56
57	2072	0.2073	4,981	\$1,033	409	\$85	3,908	\$810	9,298	\$1,928	0.05	0.1573	\$1,462.65
58	2073	0.2085	4,981	\$1,039	409	\$85	3,908	\$815	9,298	\$1,939	0.05	0.1585	\$1,473.80
59	2074	0.2097	4,981	\$1,045	409	\$86	3,908	\$820	9,298	\$1,950	0.05	0.1597	\$1,485.02
60	2075	0.2109	4,981	\$1,051	409	\$86	3,908	\$824	9,298	\$1,961	0.05	0.1609	\$1,496.30

Table D1-1.29: Annual Operating Costs (H.GSHP) of a 2,000 square feet detached house above grade (average construction type) in the city of Sarnia (two life cycles and three life cycles for a 60 year project lifespan); base case scenario in comparison with feed in-tariff (FIT) scenario. In the FIT scenario, an incentive of \$0.05/KWh is provided on electricity bills throughout the project lifespan

Traditional HVAC Applications

Base Case Scenario															Carbon Taxes							
#	Year	Electricity Rates \$/KWh	Natural Gas Rates \$/m ³	Heating		Heating Operating Cost \$ (Electricity)	Heating Operating Cost \$ (Gas)	Total Heating Operating Cost \$	Cooling		Hot Water m ³	Hot Water Operating Cost \$	Total KWh	Total m ³	Total Electricity Operating Cost \$ (KWh)	Total Natural Gas Operating Cost \$ (m ³)	Total	Conversion of m ³ into Tons	Total Tons	Carbon Tax \$	Operating Costs	
				KWh (Electricity)	m ³ (Gas)				Operating Cost \$	Operating Cost \$												
1	2016	0.1501	0.3458	1,734	2,378	\$260	\$822	\$1,083	1,930	\$290	950	\$329	3,664	3,328	550	\$1,151	\$1,701	6.02	6.02	10	\$60.24	\$1,761.06
2	2017	0.1542	0.3588	1,734	2,378	\$267	\$853	\$1,121	1,930	\$298	950	\$329	3,664	3,328	565	\$1,194	\$1,759	6.02	6.02	\$20	\$120.47	\$1,879.62
3	2018	0.1583	0.3718	1,734	2,378	\$274	\$884	\$1,159	1,930	\$306	950	\$329	3,664	3,328	580	\$1,237	\$1,817	6.02	6.02	\$30	\$180.71	\$1,998.18
4	2019	0.1625	0.3776	1,734	2,378	\$282	\$898	\$1,180	1,930	\$314	950	\$329	3,664	3,328	596	\$1,257	\$1,852	6.02	6.02	\$40	\$240.95	\$2,093.08
5	2020	0.1668	0.3841	1,734	2,378	\$289	\$913	\$1,203	1,930	\$322	950	\$329	3,664	3,328	611	\$1,278	\$1,889	6.02	6.02	\$50	\$301.18	\$2,190.53
6	2021	0.1621	0.3883	1,734	2,378	\$281	\$923	\$1,205	1,930	\$313	950	\$329	3,664	3,328	594	\$1,292	\$1,886	6.02	6.02	\$60	\$361.42	\$2,247.75
7	2022	0.1629	0.3929	1,734	2,378	\$283	\$934	\$1,217	1,930	\$314	950	\$329	3,664	3,328	597	\$1,308	\$1,905	6.02	6.02	\$70	\$421.66	\$2,326.17
8	2023	0.1639	0.3967	1,734	2,378	\$284	\$943	\$1,228	1,930	\$316	950	\$329	3,664	3,328	600	\$1,320	\$1,921	6.02	6.02	\$80	\$481.89	\$2,402.57
9	2024	0.1648	0.4005	1,734	2,378	\$286	\$952	\$1,238	1,930	\$318	950	\$329	3,664	3,328	604	\$1,333	\$1,937	6.02	6.02	\$90	\$542.13	\$2,478.97
10	2025	0.1656	0.4040	1,734	2,378	\$287	\$961	\$1,248	1,930	\$320	950	\$329	3,664	3,328	607	\$1,344	\$1,951	6.02	6.02	\$100	\$602.37	\$2,553.56
11	2026	0.1665	0.4070	1,734	2,378	\$289	\$968	\$1,257	1,930	\$321	950	\$329	3,664	3,328	610	\$1,355	\$1,965	6.02	6.02	\$110	\$662.60	\$2,627.41
12	2027	0.1674	0.4097	1,734	2,378	\$290	\$974	\$1,265	1,930	\$323	950	\$329	3,664	3,328	613	\$1,364	\$1,977	6.02	6.02	\$120	\$722.84	\$2,699.86
13	2028	0.1683	0.4124	1,734	2,378	\$292	\$981	\$1,272	1,930	\$325	950	\$329	3,664	3,328	617	\$1,372	\$1,989	6.02	6.02	\$130	\$783.08	\$2,772.04
14	2029	0.1692	0.4151	1,734	2,378	\$293	\$987	\$1,280	1,930	\$326	950	\$329	3,664	3,328	620	\$1,381	\$2,001	6.02	6.02	\$140	\$843.32	\$2,844.49
15	2030	0.1701	0.4170	1,734	2,378	\$295	\$992	\$1,287	1,930	\$328	950	\$329	3,664	3,328	623	\$1,388	\$2,011	6.02	6.02	\$150	\$903.55	\$2,914.52
16	2031	0.1704	0.4189	1,734	2,378	\$295	\$996	\$1,292	1,930	\$329	950	\$329	3,664	3,328	624	\$1,394	\$2,018	6.02	6.02	\$160	\$963.79	\$2,982.05
17	2032	0.1705	0.4204	1,734	2,378	\$296	\$1,000	\$1,295	1,930	\$329	950	\$329	3,664	3,328	625	\$1,399	\$2,024	6.02	6.02	\$170	\$1,024.03	\$3,047.90
18	2033	0.1707	0.4223	1,734	2,378	\$296	\$1,004	\$1,300	1,930	\$330	950	\$329	3,664	3,328	626	\$1,406	\$2,031	6.02	6.02	\$180	\$1,084.26	\$3,115.43
19	2034	0.1710	0.4246	1,734	2,378	\$297	\$1,010	\$1,306	1,930	\$330	950	\$329	3,664	3,328	627	\$1,413	\$2,040	6.02	6.02	\$190	\$1,144.50	\$3,184.36
20	2035	0.1713	0.4265	1,734	2,378	\$297	\$1,014	\$1,311	1,930	\$331	950	\$329	3,664	3,328	628	\$1,420	\$2,047	6.02	6.02	\$200	\$1,204.74	\$3,251.89
21	2036	0.1714	0.4288	1,734	2,378	\$297	\$1,020	\$1,317	1,930	\$331	950	\$329	3,664	3,328	628	\$1,427	\$2,055	6.02	6.02	\$210	\$1,264.97	\$3,320.29
22	2037	0.1717	0.4311	1,734	2,378	\$298	\$1,025	\$1,323	1,930	\$331	950	\$329	3,664	3,328	629	\$1,435	\$2,064	6.02	6.02	\$220	\$1,325.21	\$3,389.09
23	2038	0.1720	0.4331	1,734	2,378	\$298	\$1,030	\$1,328	1,930	\$332	950	\$329	3,664	3,328	630	\$1,441	\$2,071	6.02	6.02	\$230	\$1,385.45	\$3,456.75
24	2039	0.1722	0.4353	1,734	2,378	\$299	\$1,035	\$1,334	1,930	\$332	950	\$329	3,664	3,328	631	\$1,449	\$2,080	6.02	6.02	\$240	\$1,445.68	\$3,525.55
25	2040	0.1724	0.4376	1,734	2,378	\$299	\$1,041	\$1,340	1,930	\$333	950	\$329	3,664	3,328	632	\$1,456	\$2,088	6.02	6.02	\$250	\$1,505.92	\$3,593.95
26	2041	0.1734	0.4420	1,734	2,378	\$301	\$1,051	\$1,352	1,930	\$335	950	\$329	3,664	3,328	635	\$1,471	\$2,106	6.02	6.02	\$260	\$1,566.16	\$3,672.20
27	2042	0.1744	0.4463	1,734	2,378	\$302	\$1,061	\$1,364	1,930	\$337	950	\$329	3,664	3,328	639	\$1,485	\$2,124	6.02	6.02	\$270	\$1,626.39	\$3,750.61
28	2043	0.1754	0.4507	1,734	2,378	\$304	\$1,072	\$1,376	1,930	\$338	950	\$329	3,664	3,328	643	\$1,500	\$2,143	6.02	6.02	\$280	\$1,686.63	\$3,829.19
29	2044	0.1764	0.4552	1,734	2,378	\$306	\$1,082	\$1,388	1,930	\$340	950	\$329	3,664	3,328	646	\$1,516	\$2,161	6.02	6.02	\$290	\$1,746.87	\$3,907.93
30	2045	0.1774	0.4596	1,734	2,378	\$308	\$1,093	\$1,401	1,930	\$342	950	\$329	3,664	3,328	650	\$1,530	\$2,180	6.02	6.02	\$300	\$1,807.10	\$3,986.84
31	2046	0.1784	0.4642	1,734	2,378	\$309	\$1,104	\$1,413	1,930	\$344	950	\$329	3,664	3,328	654	\$1,545	\$2,199	6.02	6.02	\$310	\$1,867.34	\$4,065.92
32	2047	0.1795	0.4688	1,734	2,378	\$311	\$1,115	\$1,426	1,930	\$346	950	\$329	3,664	3,328	658	\$1,560	\$2,218	6.02	6.02	\$320	\$1,927.58	\$4,145.17
33	2048	0.1805	0.4734	1,734	2,378	\$313	\$1,126	\$1,439	1,930	\$348	950	\$329	3,664	3,328	661	\$1,575	\$2,237	6.02	6.02	\$330	\$1,987.81	\$4,224.59
34	2049	0.1816	0.4780	1,734	2,378	\$315	\$1,137	\$1,452	1,930	\$350	950	\$329	3,664	3,328	665	\$1,591	\$2,256	6.02	6.02	\$340	\$2,048.05	\$4,304.18
35	2050	0.1826	0.4828	1,734	2,378	\$317	\$1,148	\$1,465	1,930	\$352	950	\$329	3,664	3,328	669	\$1,607	\$2,276	6.02	6.02	\$350	\$2,108.29	\$4,383.95
36	2051	0.1837	0.4875	1,734	2,378	\$318	\$1,159	\$1,478	1,930	\$354	950	\$329	3,664	3,328	673	\$1,622	\$2,295	6.02	6.02	\$360	\$2,168.52	\$4,463.90
37	2052	0.1847	0.4923	1,734	2,378	\$320	\$1,171	\$1,491	1,930	\$357	950	\$329	3,664	3,328	677	\$1,638	\$2,315	6.02	6.02	\$370	\$2,228.76	\$4,544.02
38	2053	0.1858	0.4972	1,734	2,378	\$322	\$1,182	\$1,504	1,930	\$359	950	\$329	3,664	3,328	681	\$1,655	\$2,335	6.02	6.02	\$380	\$2,289.00	\$4,624.33
39	2054	0.1869	0.5021	1,734	2,378	\$324	\$1,194	\$1,518	1,930	\$361	950	\$329	3,664	3,328	685	\$1,671	\$2,356	6.02	6.02	\$390	\$2,349.24	\$4,704.82
40	2055	0.1879	0.5070	1,734	2,378	\$326	\$1,206	\$1,532	1,930	\$363	950	\$329	3,664	3,328	689	\$1,687	\$2,376	6.02	6.02	\$400	\$2,409.47	\$4,785.49
41	2056	0.1890	0.5120	1,734	2,378	\$328	\$1,218	\$1,545	1,930	\$365	950	\$329	3,664	3,328	693	\$1,704	\$2,397	6.02	6.02	\$410	\$2,469.71	\$4,866.34
42	2057	0.1901	0.5171	1,734	2,378	\$330	\$1,230	\$1,559	1,930	\$367	950	\$329	3,664	3,328	697	\$1,721	\$2,417	6.02	6.02	\$420	\$2,529.95	\$4,947.39
43	2058	0.1912	0.5222	1,734	2,378	\$332	\$1,242	\$1,573	1,930	\$369	950	\$329	3,664	3,328	701	\$1,738	\$2,438	6.02	6.02	\$430	\$2,590.18	\$5,028.62
44	2059	0.1923	0.5273	1,734	2,378	\$334	\$1,254	\$1,587	1,930	\$371	950	\$329	3,664	3,328	705	\$1,755	\$2,460	6.02	6.02	\$440	\$2,650.42	\$5,110.04
45	2060	0.1934	0.5325	1,734	2,378	\$335	\$1,266	\$1,602	1,930	\$373	950	\$329	3,664	3,328	709	\$1,772	\$2,481	6.02	6.02	\$450	\$2,710.66	\$5,191.66
46	2061	0.1946	0.5378	1,734	2,378	\$337	\$1,279	\$1,616	1,930	\$376	950	\$329	3,664	3,328	713	\$1,790	\$2,503	6.02	6.02	\$460	\$2,770.89	\$5,273.47
47	2062	0.1957	0.5431	1,734	2,378	\$339	\$1,291	\$1,631	1,930	\$378	950	\$329	3,664	3,328	717	\$1,807	\$2,524	6.02	6.02	\$470	\$2,831.13	\$5,355.47
48	2063	0.1968	0.5484	1,734	2,378	\$341	\$1,304	\$1,645	1,930	\$380	950	\$329	3,664	3,328	721	\$1,825	\$2,546	6.02	6.02	\$480	\$2,891.37	\$5,437.68
49	2064	0.1980	0.5538	1,734	2,378	\$343	\$1,317	\$1,660	1,930	\$382	950	\$329	3,664	3,328	725	\$1,843	\$2,568	6.02	6.02	\$490	\$2,951.60	\$5,520.08
50	2065	0.1991	0.5593	1,734	2,378	\$345	\$1,330	\$1,675	1,930	\$384	950	\$329	3,664	3,328	730	\$1,861	\$2,591	6.02	6.02	\$500	\$3,011.84	\$5,602.68
51	2066	0.2003	0.5648	1,734	2,378	\$347	\$1,343	\$1,690	1,930	\$386	950	\$329	3,664	3,328	734	\$1,880	\$2,613	6.02	6.02	\$510	\$3,072.08	\$5,685.49
52	2067	0.2014	0.5704	1,734	2,378	\$349	\$1,356	\$1,706	1,930	\$389	950	\$329	3,664	3,328	738	\$1,898	\$2,636	6.02	6.02	\$520	\$3,132.31	\$5,768.50
53	2068	0.2026	0.5760	1,734	2,378	\$351	\$1,370	\$1,721	1,930	\$391	950	\$329	3,664	3,328	742	\$1,917	\$2,659	6.02	6.02	\$530	\$3,192.55	\$5,851.72
54	2069	0.2038	0.5817	1,73																		

11. Simcoe (South) – Annual Operating Costs

Vertical Ground Source Heat Pump (V.GSHP)

Base Case Scenario												Feed in Tariff (FIT)		
V.GSHP												FIT		
#	Year	Electricity Rates	Heating	Heating Operating Cost	Cooling	Cooling Operating Cost	Hot Water	Hot Water Operating Cost	Total	Total Operating Cost	Incentives (\$/KWh)	S/KWh	Operating Cost	
		\$/KWh	KWh	\$	KWh	\$	KWh	\$	KWh	\$				
1	2016	0.1501	5,016	\$753	361	\$54	4,284	\$643	9,661	\$1,450	0.05	0.1001	\$966.90	
2	2017	0.1542	5,016	\$773	361	\$56	4,284	\$661	9,661	\$1,490	0.05	0.1042	\$1,006.55	
3	2018	0.1583	5,016	\$794	361	\$57	4,284	\$678	9,661	\$1,529	0.05	0.1083	\$1,046.20	
4	2019	0.1625	5,016	\$815	361	\$59	4,284	\$696	9,661	\$1,570	0.05	0.1125	\$1,087.24	
5	2020	0.1668	5,016	\$837	361	\$60	4,284	\$715	9,661	\$1,611	0.05	0.1168	\$1,128.28	
6	2021	0.1621	5,016	\$813	361	\$59	4,284	\$695	9,661	\$1,566	0.05	0.1121	\$1,083.41	
7	2022	0.1629	5,016	\$817	361	\$59	4,284	\$698	9,661	\$1,574	0.05	0.1129	\$1,091.06	
8	2023	0.1639	5,016	\$822	361	\$59	4,284	\$702	9,661	\$1,583	0.05	0.1139	\$1,100.10	
9	2024	0.1648	5,016	\$827	361	\$59	4,284	\$706	9,661	\$1,592	0.05	0.1148	\$1,109.15	
10	2025	0.1656	5,016	\$831	361	\$60	4,284	\$709	9,661	\$1,600	0.05	0.1156	\$1,116.80	
11	2026	0.1665	5,016	\$835	361	\$60	4,284	\$713	9,661	\$1,609	0.05	0.1165	\$1,125.84	
12	2027	0.1674	5,016	\$840	361	\$60	4,284	\$717	9,661	\$1,618	0.05	0.1174	\$1,134.54	
13	2028	0.1683	5,016	\$844	361	\$61	4,284	\$721	9,661	\$1,626	0.05	0.1183	\$1,142.54	
14	2029	0.1692	5,016	\$849	361	\$61	4,284	\$725	9,661	\$1,634	0.05	0.1192	\$1,151.23	
15	2030	0.1701	5,016	\$853	361	\$61	4,284	\$729	9,661	\$1,643	0.05	0.1201	\$1,160.27	
16	2031	0.1704	5,016	\$854	361	\$61	4,284	\$730	9,661	\$1,646	0.05	0.1204	\$1,162.71	
17	2032	0.1705	5,016	\$855	361	\$62	4,284	\$730	9,661	\$1,647	0.05	0.1205	\$1,164.10	
18	2033	0.1707	5,016	\$856	361	\$62	4,284	\$731	9,661	\$1,650	0.05	0.1207	\$1,166.53	
19	2034	0.1710	5,016	\$858	361	\$62	4,284	\$733	9,661	\$1,652	0.05	0.1210	\$1,169.32	
20	2035	0.1713	5,016	\$859	361	\$62	4,284	\$734	9,661	\$1,655	0.05	0.1213	\$1,171.75	
21	2036	0.1714	5,016	\$860	361	\$62	4,284	\$734	9,661	\$1,656	0.05	0.1214	\$1,173.14	
22	2037	0.1717	5,016	\$861	361	\$62	4,284	\$735	9,661	\$1,659	0.05	0.1217	\$1,175.58	
23	2038	0.1720	5,016	\$863	361	\$62	4,284	\$737	9,661	\$1,661	0.05	0.1220	\$1,178.36	
24	2039	0.1722	5,016	\$864	361	\$62	4,284	\$738	9,661	\$1,664	0.05	0.1222	\$1,180.79	
25	2040	0.1724	5,016	\$865	361	\$62	4,284	\$738	9,661	\$1,665	0.05	0.1224	\$1,182.18	
26	2041	0.1734	5,016	\$870	361	\$63	4,284	\$743	9,661	\$1,675	0.05	0.1234	\$1,191.82	
27	2042	0.1744	5,016	\$875	361	\$63	4,284	\$747	9,661	\$1,685	0.05	0.1244	\$1,201.51	
28	2043	0.1754	5,016	\$880	361	\$63	4,284	\$751	9,661	\$1,694	0.05	0.1254	\$1,211.25	
29	2044	0.1764	5,016	\$885	361	\$64	4,284	\$756	9,661	\$1,704	0.05	0.1264	\$1,221.05	
30	2045	0.1774	5,016	\$890	361	\$64	4,284	\$760	9,661	\$1,714	0.05	0.1274	\$1,230.91	
31	2046	0.1784	5,016	\$895	361	\$64	4,284	\$764	9,661	\$1,724	0.05	0.1284	\$1,240.83	
32	2047	0.1795	5,016	\$900	361	\$65	4,284	\$769	9,661	\$1,734	0.05	0.1295	\$1,250.80	
33	2048	0.1805	5,016	\$905	361	\$65	4,284	\$773	9,661	\$1,744	0.05	0.1305	\$1,260.83	
34	2049	0.1816	5,016	\$911	361	\$66	4,284	\$778	9,661	\$1,754	0.05	0.1316	\$1,270.92	
35	2050	0.1826	5,016	\$916	361	\$66	4,284	\$782	9,661	\$1,764	0.05	0.1326	\$1,281.06	
36	2051	0.1837	5,016	\$921	361	\$66	4,284	\$787	9,661	\$1,774	0.05	0.1337	\$1,291.27	
37	2052	0.1847	5,016	\$927	361	\$67	4,284	\$791	9,661	\$1,785	0.05	0.1347	\$1,301.53	
38	2053	0.1858	5,016	\$932	361	\$67	4,284	\$796	9,661	\$1,795	0.05	0.1358	\$1,311.85	
39	2054	0.1869	5,016	\$937	361	\$67	4,284	\$801	9,661	\$1,805	0.05	0.1369	\$1,322.24	
40	2055	0.1879	5,016	\$943	361	\$68	4,284	\$805	9,661	\$1,816	0.05	0.1379	\$1,332.68	
41	2056	0.1890	5,016	\$948	361	\$68	4,284	\$810	9,661	\$1,826	0.05	0.1390	\$1,343.19	
42	2057	0.1901	5,016	\$954	361	\$69	4,284	\$814	9,661	\$1,837	0.05	0.1401	\$1,353.75	
43	2058	0.1912	5,016	\$959	361	\$69	4,284	\$819	9,661	\$1,847	0.05	0.1412	\$1,364.38	
44	2059	0.1923	5,016	\$965	361	\$69	4,284	\$824	9,661	\$1,858	0.05	0.1423	\$1,375.06	
45	2060	0.1934	5,016	\$970	361	\$70	4,284	\$829	9,661	\$1,869	0.05	0.1434	\$1,385.81	
46	2061	0.1946	5,016	\$976	361	\$70	4,284	\$834	9,661	\$1,880	0.05	0.1446	\$1,396.62	
47	2062	0.1957	5,016	\$982	361	\$71	4,284	\$838	9,661	\$1,891	0.05	0.1457	\$1,407.50	
48	2063	0.1968	5,016	\$987	361	\$71	4,284	\$843	9,661	\$1,901	0.05	0.1468	\$1,418.43	
49	2064	0.1980	5,016	\$993	361	\$71	4,284	\$848	9,661	\$1,912	0.05	0.1480	\$1,429.43	
50	2065	0.1991	5,016	\$999	361	\$72	4,284	\$853	9,661	\$1,924	0.05	0.1491	\$1,440.50	
51	2066	0.2003	5,016	\$1,004	361	\$72	4,284	\$858	9,661	\$1,935	0.05	0.1503	\$1,451.62	
52	2067	0.2014	5,016	\$1,010	361	\$73	4,284	\$863	9,661	\$1,946	0.05	0.1514	\$1,462.82	
53	2068	0.2026	5,016	\$1,016	361	\$73	4,284	\$868	9,661	\$1,957	0.05	0.1526	\$1,474.07	
54	2069	0.2038	5,016	\$1,022	361	\$74	4,284	\$873	9,661	\$1,968	0.05	0.1538	\$1,485.39	
55	2070	0.2049	5,016	\$1,028	361	\$74	4,284	\$878	9,661	\$1,980	0.05	0.1549	\$1,496.78	
56	2071	0.2061	5,016	\$1,034	361	\$74	4,284	\$883	9,661	\$1,991	0.05	0.1561	\$1,508.23	
57	2072	0.2073	5,016	\$1,040	361	\$75	4,284	\$888	9,661	\$2,003	0.05	0.1573	\$1,519.75	
58	2073	0.2085	5,016	\$1,046	361	\$75	4,284	\$893	9,661	\$2,014	0.05	0.1585	\$1,531.34	
59	2074	0.2097	5,016	\$1,052	361	\$76	4,284	\$898	9,661	\$2,026	0.05	0.1597	\$1,542.99	
60	2075	0.2109	5,016	\$1,058	361	\$76	4,284	\$904	9,661	\$2,038	0.05	0.1609	\$1,554.71	

Table D1-1.31: Annual Operating Costs (V.GSHP) of a 2,000 square feet detached house above grade (average construction type) in the city of Simcoe (two life cycles and three life cycles for a 60 year project lifespan); base case scenario in comparison with feed in-tariff (FIT) scenario. In the FIT scenario, an incentive of \$0.05/KWh is provided on electricity bills throughout the project lifespan

Horizontal Ground Source Heat Pump (H.GSHP)

Base Case Scenario											Feed in Tariff (FIT)		
#	Year	Electricity Rates \$/KWh	H.GSHP								FIT		
			Heating KWh	Heating Operating Cost \$	Cooling KWh	Cooling Operating Cost \$	Hot Water KWh	Hot Water Operating Cost \$	Total KWh	Total Operating Cost \$	Incentives (\$/KWh)	Operating Cost	
1	2016	0.1501	5,099	\$765	370	\$56	4,260	\$639	9,729	\$1,460	0.05	\$973.71	
2	2017	0.1542	5,099	\$786	370	\$57	4,260	\$657	9,729	\$1,500	0.05	\$1,013.63	
3	2018	0.1583	5,099	\$807	370	\$59	4,260	\$674	9,729	\$1,540	0.05	\$1,053.56	
4	2019	0.1625	5,099	\$829	370	\$60	4,260	\$692	9,729	\$1,581	0.05	\$1,094.89	
5	2020	0.1668	5,099	\$850	370	\$62	4,260	\$711	9,729	\$1,623	0.05	\$1,136.22	
6	2021	0.1621	5,099	\$827	370	\$60	4,260	\$691	9,729	\$1,577	0.05	\$1,091.04	
7	2022	0.1629	5,099	\$831	370	\$60	4,260	\$694	9,729	\$1,585	0.05	\$1,098.74	
8	2023	0.1639	5,099	\$836	370	\$61	4,260	\$698	9,729	\$1,594	0.05	\$1,107.85	
9	2024	0.1648	5,099	\$840	370	\$61	4,260	\$702	9,729	\$1,603	0.05	\$1,116.95	
10	2025	0.1656	5,099	\$844	370	\$61	4,260	\$705	9,729	\$1,611	0.05	\$1,124.66	
11	2026	0.1665	5,099	\$849	370	\$62	4,260	\$709	9,729	\$1,620	0.05	\$1,133.77	
12	2027	0.1674	5,099	\$854	370	\$62	4,260	\$713	9,729	\$1,629	0.05	\$1,142.52	
13	2028	0.1683	5,099	\$858	370	\$62	4,260	\$717	9,729	\$1,637	0.05	\$1,150.58	
14	2029	0.1692	5,099	\$863	370	\$63	4,260	\$721	9,729	\$1,646	0.05	\$1,159.33	
15	2030	0.1701	5,099	\$867	370	\$63	4,260	\$725	9,729	\$1,655	0.05	\$1,168.44	
16	2031	0.1704	5,099	\$869	370	\$63	4,260	\$726	9,729	\$1,657	0.05	\$1,170.89	
17	2032	0.1705	5,099	\$869	370	\$63	4,260	\$726	9,729	\$1,659	0.05	\$1,172.29	
18	2033	0.1707	5,099	\$871	370	\$63	4,260	\$727	9,729	\$1,661	0.05	\$1,174.74	
19	2034	0.1710	5,099	\$872	370	\$63	4,260	\$729	9,729	\$1,664	0.05	\$1,177.55	
20	2035	0.1713	5,099	\$873	370	\$63	4,260	\$730	9,729	\$1,666	0.05	\$1,180.00	
21	2036	0.1714	5,099	\$874	370	\$63	4,260	\$730	9,729	\$1,668	0.05	\$1,181.40	
22	2037	0.1717	5,099	\$875	370	\$64	4,260	\$731	9,729	\$1,670	0.05	\$1,183.85	
23	2038	0.1720	5,099	\$877	370	\$64	4,260	\$733	9,729	\$1,673	0.05	\$1,186.65	
24	2039	0.1722	5,099	\$878	370	\$64	4,260	\$734	9,729	\$1,676	0.05	\$1,189.10	
25	2040	0.1724	5,099	\$879	370	\$64	4,260	\$734	9,729	\$1,677	0.05	\$1,190.50	
26	2041	0.1734	5,099	\$884	370	\$64	4,260	\$739	9,729	\$1,687	0.05	\$1,200.21	
27	2042	0.1744	5,099	\$889	370	\$65	4,260	\$743	9,729	\$1,696	0.05	\$1,209.96	
28	2043	0.1754	5,099	\$894	370	\$65	4,260	\$747	9,729	\$1,706	0.05	\$1,219.78	
29	2044	0.1764	5,099	\$899	370	\$65	4,260	\$751	9,729	\$1,716	0.05	\$1,229.65	
30	2045	0.1774	5,099	\$905	370	\$66	4,260	\$756	9,729	\$1,726	0.05	\$1,239.57	
31	2046	0.1784	5,099	\$910	370	\$66	4,260	\$760	9,729	\$1,736	0.05	\$1,249.56	
32	2047	0.1795	5,099	\$915	370	\$66	4,260	\$765	9,729	\$1,746	0.05	\$1,259.60	
33	2048	0.1805	5,099	\$920	370	\$67	4,260	\$769	9,729	\$1,756	0.05	\$1,269.70	
34	2049	0.1816	5,099	\$926	370	\$67	4,260	\$773	9,729	\$1,766	0.05	\$1,279.86	
35	2050	0.1826	5,099	\$931	370	\$68	4,260	\$778	9,729	\$1,777	0.05	\$1,290.08	
36	2051	0.1837	5,099	\$936	370	\$68	4,260	\$782	9,729	\$1,787	0.05	\$1,300.36	
37	2052	0.1847	5,099	\$942	370	\$68	4,260	\$787	9,729	\$1,797	0.05	\$1,310.69	
38	2053	0.1858	5,099	\$947	370	\$69	4,260	\$791	9,729	\$1,808	0.05	\$1,321.09	
39	2054	0.1869	5,099	\$953	370	\$69	4,260	\$796	9,729	\$1,818	0.05	\$1,331.54	
40	2055	0.1879	5,099	\$958	370	\$70	4,260	\$801	9,729	\$1,829	0.05	\$1,342.06	
41	2056	0.1890	5,099	\$964	370	\$70	4,260	\$805	9,729	\$1,839	0.05	\$1,352.64	
42	2057	0.1901	5,099	\$969	370	\$70	4,260	\$810	9,729	\$1,850	0.05	\$1,363.28	
43	2058	0.1912	5,099	\$975	370	\$71	4,260	\$815	9,729	\$1,860	0.05	\$1,373.98	
44	2059	0.1923	5,099	\$981	370	\$71	4,260	\$819	9,729	\$1,871	0.05	\$1,384.74	
45	2060	0.1934	5,099	\$986	370	\$72	4,260	\$824	9,729	\$1,882	0.05	\$1,395.57	
46	2061	0.1946	5,099	\$992	370	\$72	4,260	\$829	9,729	\$1,893	0.05	\$1,406.45	
47	2062	0.1957	5,099	\$998	370	\$72	4,260	\$834	9,729	\$1,904	0.05	\$1,417.40	
48	2063	0.1968	5,099	\$1,004	370	\$73	4,260	\$838	9,729	\$1,915	0.05	\$1,428.42	
49	2064	0.1980	5,099	\$1,009	370	\$73	4,260	\$843	9,729	\$1,926	0.05	\$1,439.49	
50	2065	0.1991	5,099	\$1,015	370	\$74	4,260	\$848	9,729	\$1,937	0.05	\$1,450.64	
51	2066	0.2003	5,099	\$1,021	370	\$74	4,260	\$853	9,729	\$1,948	0.05	\$1,461.84	
52	2067	0.2014	5,099	\$1,027	370	\$75	4,260	\$858	9,729	\$1,960	0.05	\$1,473.11	
53	2068	0.2026	5,099	\$1,033	370	\$75	4,260	\$863	9,729	\$1,971	0.05	\$1,484.45	
54	2069	0.2038	5,099	\$1,039	370	\$75	4,260	\$868	9,729	\$1,982	0.05	\$1,495.85	
55	2070	0.2049	5,099	\$1,045	370	\$76	4,260	\$873	9,729	\$1,994	0.05	\$1,507.32	
56	2071	0.2061	5,099	\$1,051	370	\$76	4,260	\$878	9,729	\$2,005	0.05	\$1,518.85	
57	2072	0.2073	5,099	\$1,057	370	\$77	4,260	\$883	9,729	\$2,017	0.05	\$1,530.45	
58	2073	0.2085	5,099	\$1,063	370	\$77	4,260	\$888	9,729	\$2,029	0.05	\$1,542.12	
59	2074	0.2097	5,099	\$1,069	370	\$78	4,260	\$893	9,729	\$2,040	0.05	\$1,553.85	
60	2075	0.2109	5,099	\$1,076	370	\$78	4,260	\$899	9,729	\$2,052	0.05	\$1,565.66	

Table D1-1.32: Annual Operating Costs (H.GSHP) of a 2,000 square feet detached house above grade (average construction type) in the city of Simcoe (two life cycles and three life cycles for a 60 year project lifespan); base case scenario in comparison with feed in-tariff (FIT) scenario. In the FIT scenario, an incentive of \$0.05/KWh is provided on electricity bills throughout the project lifespan

Traditional HVAC Applications

Base Case Scenario															Carbon Taxes							
#	Year	Electricity Rates	Natural Gas Rates	Heating		Heating Operating Cost	Heating Operating Cost	Total Heating Operating Cost	Cooling	Cooling Operating Cost	Hot Water	Hot Water Operating Cost	Total	Total	Total Electricity Operating Cost	Total Natural Gas Operating Cost	Total	Conversion of m ³ into Tons	Total Tons	Carbon Tax	Carbon Operating Costs	
				KWh (Electricity)	m ³ (Gas)																	\$ (KWh)
1	2016	0.1501	0.3458	1,778	2,442	\$267	\$845	\$1,111	1,677	\$252	1,007	\$348	3,455	3,449	519	\$1,193	\$1,711	6.24	6.24	\$10	\$62.43	\$1,773.73
2	2017	0.1542	0.3588	1,778	2,442	\$274	\$876	\$1,150	1,677	\$259	1,007	\$155	3,455	3,449	533	\$1,238	\$1,770	6.24	6.24	\$20	\$124.85	\$1,895.20
3	2018	0.1583	0.3718	1,778	2,442	\$281	\$908	\$1,189	1,677	\$265	1,007	\$159	3,455	3,449	547	\$1,282	\$1,829	6.24	6.24	\$30	\$187.28	\$2,016.66
4	2019	0.1625	0.3776	1,778	2,442	\$289	\$922	\$1,211	1,677	\$273	1,007	\$164	3,455	3,449	562	\$1,302	\$1,864	6.24	6.24	\$40	\$249.71	\$2,113.56
5	2020	0.1668	0.3841	1,778	2,442	\$297	\$938	\$1,234	1,677	\$280	1,007	\$168	3,455	3,449	576	\$1,325	\$1,901	6.24	6.24	\$50	\$312.13	\$2,223.09
6	2021	0.1621	0.3883	1,778	2,442	\$288	\$948	\$1,237	1,677	\$272	1,007	\$163	3,455	3,449	560	\$1,339	\$1,899	6.24	6.24	\$60	\$374.56	\$2,323.99
7	2022	0.1629	0.3929	1,778	2,442	\$290	\$959	\$1,249	1,677	\$273	1,007	\$164	3,455	3,449	563	\$1,355	\$1,918	6.24	6.24	\$70	\$436.99	\$2,434.99
8	2023	0.1639	0.3967	1,778	2,442	\$291	\$969	\$1,260	1,677	\$275	1,007	\$165	3,455	3,449	566	\$1,368	\$1,934	6.24	6.24	\$80	\$499.42	\$2,543.84
9	2024	0.1648	0.4005	1,778	2,442	\$293	\$978	\$1,271	1,677	\$276	1,007	\$166	3,455	3,449	569	\$1,381	\$1,951	6.24	6.24	\$90	\$561.84	\$2,652.70
10	2025	0.1656	0.4040	1,778	2,442	\$294	\$987	\$1,281	1,677	\$278	1,007	\$167	3,455	3,449	572	\$1,393	\$1,965	6.24	6.24	\$100	\$624.27	\$2,763.97
11	2026	0.1665	0.4070	1,778	2,442	\$296	\$994	\$1,290	1,677	\$279	1,007	\$168	3,455	3,449	575	\$1,404	\$1,979	6.24	6.24	\$110	\$686.70	\$2,865.95
12	2027	0.1674	0.4097	1,778	2,442	\$298	\$1,001	\$1,298	1,677	\$281	1,007	\$169	3,455	3,449	578	\$1,413	\$1,992	6.24	6.24	\$120	\$749.12	\$2,940.72
13	2028	0.1683	0.4124	1,778	2,442	\$299	\$1,007	\$1,306	1,677	\$282	1,007	\$169	3,455	3,449	581	\$1,422	\$2,004	6.24	6.24	\$130	\$811.55	\$2,815.25
14	2029	0.1692	0.4151	1,778	2,442	\$301	\$1,014	\$1,314	1,677	\$284	1,007	\$170	3,455	3,449	584	\$1,432	\$2,016	6.24	6.24	\$140	\$873.98	\$2,890.02
15	2030	0.1701	0.4170	1,778	2,442	\$302	\$1,018	\$1,321	1,677	\$285	1,007	\$171	3,455	3,449	588	\$1,438	\$2,026	6.24	6.24	\$150	\$936.40	\$2,962.28
16	2031	0.1704	0.4189	1,778	2,442	\$303	\$1,023	\$1,326	1,677	\$286	1,007	\$172	3,455	3,449	589	\$1,445	\$2,033	6.24	6.24	\$160	\$998.83	\$3,032.17
17	2032	0.1705	0.4204	1,778	2,442	\$303	\$1,027	\$1,330	1,677	\$286	1,007	\$172	3,455	3,449	589	\$1,450	\$2,039	6.24	6.24	\$170	\$1,061.26	\$3,100.37
18	2033	0.1707	0.4223	1,778	2,442	\$304	\$1,031	\$1,335	1,677	\$286	1,007	\$172	3,455	3,449	590	\$1,457	\$2,047	6.24	6.24	\$180	\$1,123.68	\$3,170.27
19	2034	0.1710	0.4246	1,778	2,442	\$304	\$1,037	\$1,341	1,677	\$287	1,007	\$172	3,455	3,449	591	\$1,465	\$2,055	6.24	6.24	\$190	\$1,186.11	\$3,241.61
20	2035	0.1713	0.4265	1,778	2,442	\$305	\$1,042	\$1,346	1,677	\$287	1,007	\$172	3,455	3,449	592	\$1,471	\$2,063	6.24	6.24	\$200	\$1,248.54	\$3,311.50
21	2036	0.1714	0.4288	1,778	2,442	\$305	\$1,047	\$1,352	1,677	\$287	1,007	\$173	3,455	3,449	592	\$1,479	\$2,071	6.24	6.24	\$210	\$1,310.96	\$3,382.34
22	2037	0.1717	0.4311	1,778	2,442	\$305	\$1,053	\$1,358	1,677	\$288	1,007	\$173	3,455	3,449	593	\$1,487	\$2,080	6.24	6.24	\$220	\$1,373.39	\$3,453.56
23	2038	0.1720	0.4331	1,778	2,442	\$306	\$1,058	\$1,363	1,677	\$288	1,007	\$173	3,455	3,449	594	\$1,494	\$2,088	6.24	6.24	\$230	\$1,435.82	\$3,523.58
24	2039	0.1722	0.4353	1,778	2,442	\$306	\$1,063	\$1,369	1,677	\$289	1,007	\$173	3,455	3,449	595	\$1,502	\$2,097	6.24	6.24	\$240	\$1,498.25	\$3,594.79
25	2040	0.1724	0.4376	1,778	2,442	\$306	\$1,069	\$1,375	1,677	\$289	1,007	\$174	3,455	3,449	596	\$1,509	\$2,105	6.24	6.24	\$250	\$1,560.67	\$3,665.63
26	2041	0.1734	0.4420	1,778	2,442	\$308	\$1,079	\$1,388	1,677	\$291	1,007	\$175	3,455	3,449	599	\$1,524	\$2,123	6.24	6.24	\$260	\$1,623.10	\$3,746.38
27	2042	0.1744	0.4463	1,778	2,442	\$310	\$1,090	\$1,400	1,677	\$292	1,007	\$176	3,455	3,449	602	\$1,539	\$2,142	6.24	6.24	\$270	\$1,685.53	\$3,827.30
28	2043	0.1754	0.4507	1,778	2,442	\$312	\$1,101	\$1,412	1,677	\$294	1,007	\$177	3,455	3,449	606	\$1,555	\$2,160	6.24	6.24	\$280	\$1,747.95	\$3,908.39
29	2044	0.1764	0.4552	1,778	2,442	\$314	\$1,111	\$1,425	1,677	\$296	1,007	\$178	3,455	3,449	609	\$1,570	\$2,179	6.24	6.24	\$290	\$1,810.38	\$3,989.65
30	2045	0.1774	0.4596	1,778	2,442	\$315	\$1,122	\$1,438	1,677	\$298	1,007	\$179	3,455	3,449	613	\$1,585	\$2,198	6.24	6.24	\$300	\$1,872.81	\$4,071.08
31	2046	0.1784	0.4642	1,778	2,442	\$317	\$1,134	\$1,451	1,677	\$299	1,007	\$180	3,455	3,449	616	\$1,601	\$2,217	6.24	6.24	\$310	\$1,935.23	\$4,152.68
32	2047	0.1795	0.4688	1,778	2,442	\$319	\$1,145	\$1,464	1,677	\$301	1,007	\$181	3,455	3,449	620	\$1,617	\$2,237	6.24	6.24	\$320	\$1,997.66	\$4,234.46
33	2048	0.1805	0.4734	1,778	2,442	\$321	\$1,156	\$1,477	1,677	\$303	1,007	\$182	3,455	3,449	624	\$1,633	\$2,256	6.24	6.24	\$330	\$2,060.09	\$4,316.41
34	2049	0.1816	0.4780	1,778	2,442	\$323	\$1,167	\$1,490	1,677	\$304	1,007	\$183	3,455	3,449	627	\$1,649	\$2,276	6.24	6.24	\$340	\$2,122.51	\$4,398.54
35	2050	0.1826	0.4828	1,778	2,442	\$325	\$1,179	\$1,504	1,677	\$306	1,007	\$184	3,455	3,449	631	\$1,665	\$2,296	6.24	6.24	\$350	\$2,184.94	\$4,480.86
36	2051	0.1837	0.4875	1,778	2,442	\$327	\$1,191	\$1,517	1,677	\$308	1,007	\$185	3,455	3,449	635	\$1,681	\$2,316	6.24	6.24	\$360	\$2,247.37	\$4,563.35
37	2052	0.1847	0.4923	1,778	2,442	\$328	\$1,202	\$1,531	1,677	\$310	1,007	\$186	3,455	3,449	638	\$1,698	\$2,336	6.24	6.24	\$370	\$2,309.80	\$4,646.02
38	2053	0.1858	0.4972	1,778	2,442	\$330	\$1,214	\$1,544	1,677	\$312	1,007	\$187	3,455	3,449	642	\$1,715	\$2,357	6.24	6.24	\$380	\$2,372.22	\$4,728.88
39	2054	0.1869	0.5021	1,778	2,442	\$332	\$1,226	\$1,558	1,677	\$313	1,007	\$188	3,455	3,449	646	\$1,732	\$2,377	6.24	6.24	\$390	\$2,434.65	\$4,811.93
40	2055	0.1879	0.5070	1,778	2,442	\$334	\$1,238	\$1,572	1,677	\$315	1,007	\$189	3,455	3,449	649	\$1,749	\$2,398	6.24	6.24	\$400	\$2,497.08	\$4,895.16
41	2056	0.1890	0.5120	1,778	2,442	\$336	\$1,250	\$1,586	1,677	\$317	1,007	\$190	3,455	3,449	653	\$1,766	\$2,419	6.24	6.24	\$410	\$2,559.50	\$4,978.59
42	2057	0.1901	0.5171	1,778	2,442	\$338	\$1,263	\$1,601	1,677	\$319	1,007	\$191	3,455	3,449	657	\$1,783	\$2,440	6.24	6.24	\$420	\$2,621.93	\$5,062.20
43	2058	0.1912	0.5222	1,778	2,442	\$340	\$1,275	\$1,615	1,677	\$321	1,007	\$193	3,455	3,449	661	\$1,801	\$2,462	6.24	6.24	\$430	\$2,684.36	\$5,146.01
44	2059	0.1923	0.5273	1,778	2,442	\$342	\$1,288	\$1,630	1,677	\$323	1,007	\$194	3,455	3,449	665	\$1,819	\$2,483	6.24	6.24	\$440	\$2,746.78	\$5,230.02
45	2060	0.1934	0.5325	1,778	2,442	\$344	\$1,300	\$1,644	1,677	\$324	1,007	\$195	3,455	3,449	668	\$1,837	\$2,505	6.24	6.24	\$450	\$2,809.21	\$5,314.22
46	2061	0.1946	0.5378	1,778	2,442	\$346	\$1,313	\$1,659	1,677	\$326	1,007	\$196	3,455	3,449	672	\$1,855	\$2,527	6.24	6.24	\$460	\$2,871.64	\$5,398.62
47	2062	0.1957	0.5431	1,778	2,442	\$348	\$1,326	\$1,674	1,677	\$328	1,007	\$197	3,455	3,449	676	\$1,873	\$2,549	6.24	6.24	\$470	\$2,934.06	\$5,483.22
48	2063	0.1968	0.5484	1,778	2,442	\$350	\$1,339	\$1,689	1,677	\$330	1,007	\$198	3,455	3,449	680	\$1,892						

12. Saint Catharines (South) – Annual Operating Costs

Vertical Ground Source Heat Pump (V.GSHP)

Base Case Scenario											Feed in Tariff (FIT)			
#	Year	Electricity Rates		V.GSHP		V.GSHP		V.GSHP		Total	Total Operating Cost	FIT		
		\$/KWh	KWh	Heating Operating Cost	Cooling Operating Cost	Hot Water	Hot Water Operating Cost	\$/KWh	Operating Cost			Operating Cost		
1	2016	0.1501	4,511	\$677	485	\$73	4,014	\$602	9,010	\$1,352	0.05	0.1001	\$901.75	
2	2017	0.1542	4,511	\$696	485	\$75	4,014	\$619	9,010	\$1,389	0.05	0.1042	\$938.72	
3	2018	0.1583	4,511	\$714	485	\$77	4,014	\$635	9,010	\$1,426	0.05	0.1083	\$975.70	
4	2019	0.1625	4,511	\$733	485	\$79	4,014	\$652	9,010	\$1,464	0.05	0.1125	\$1,013.97	
5	2020	0.1668	4,511	\$752	485	\$81	4,014	\$669	9,010	\$1,503	0.05	0.1168	\$1,052.25	
6	2021	0.1621	4,511	\$731	485	\$79	4,014	\$651	9,010	\$1,461	0.05	0.1121	\$1,010.41	
7	2022	0.1629	4,511	\$735	485	\$79	4,014	\$654	9,010	\$1,468	0.05	0.1129	\$1,017.54	
8	2023	0.1639	4,511	\$739	485	\$79	4,014	\$658	9,010	\$1,476	0.05	0.1139	\$1,025.97	
9	2024	0.1648	4,511	\$743	485	\$80	4,014	\$662	9,010	\$1,485	0.05	0.1148	\$1,034.41	
10	2025	0.1656	4,511	\$747	485	\$80	4,014	\$665	9,010	\$1,492	0.05	0.1156	\$1,041.54	
11	2026	0.1665	4,511	\$751	485	\$81	4,014	\$668	9,010	\$1,500	0.05	0.1165	\$1,049.98	
12	2027	0.1674	4,511	\$755	485	\$81	4,014	\$672	9,010	\$1,509	0.05	0.1174	\$1,058.09	
13	2028	0.1683	4,511	\$759	485	\$82	4,014	\$675	9,010	\$1,516	0.05	0.1183	\$1,065.55	
14	2029	0.1692	4,511	\$763	485	\$82	4,014	\$679	9,010	\$1,524	0.05	0.1192	\$1,073.66	
15	2030	0.1701	4,511	\$767	485	\$82	4,014	\$683	9,010	\$1,533	0.05	0.1201	\$1,082.09	
16	2031	0.1704	4,511	\$768	485	\$83	4,014	\$684	9,010	\$1,535	0.05	0.1204	\$1,084.36	
17	2032	0.1705	4,511	\$769	485	\$83	4,014	\$684	9,010	\$1,536	0.05	0.1205	\$1,085.66	
18	2033	0.1707	4,511	\$770	485	\$83	4,014	\$685	9,010	\$1,538	0.05	0.1207	\$1,087.93	
19	2034	0.1710	4,511	\$772	485	\$83	4,014	\$687	9,010	\$1,541	0.05	0.1210	\$1,090.52	
20	2035	0.1713	4,511	\$773	485	\$83	4,014	\$688	9,010	\$1,543	0.05	0.1213	\$1,092.79	
21	2036	0.1714	4,511	\$773	485	\$83	4,014	\$688	9,010	\$1,545	0.05	0.1214	\$1,094.09	
22	2037	0.1717	4,511	\$774	485	\$83	4,014	\$689	9,010	\$1,547	0.05	0.1217	\$1,096.36	
23	2038	0.1720	4,511	\$776	485	\$83	4,014	\$690	9,010	\$1,549	0.05	0.1220	\$1,098.96	
24	2039	0.1722	4,511	\$777	485	\$84	4,014	\$691	9,010	\$1,552	0.05	0.1222	\$1,101.23	
25	2040	0.1724	4,511	\$778	485	\$84	4,014	\$692	9,010	\$1,553	0.05	0.1224	\$1,102.52	
26	2041	0.1734	4,511	\$782	485	\$84	4,014	\$696	9,010	\$1,562	0.05	0.1234	\$1,111.51	
27	2042	0.1744	4,511	\$787	485	\$85	4,014	\$700	9,010	\$1,571	0.05	0.1244	\$1,120.54	
28	2043	0.1754	4,511	\$791	485	\$85	4,014	\$704	9,010	\$1,580	0.05	0.1254	\$1,129.63	
29	2044	0.1764	4,511	\$796	485	\$86	4,014	\$708	9,010	\$1,589	0.05	0.1264	\$1,138.77	
30	2045	0.1774	4,511	\$800	485	\$86	4,014	\$712	9,010	\$1,598	0.05	0.1274	\$1,147.97	
31	2046	0.1784	4,511	\$805	485	\$87	4,014	\$716	9,010	\$1,608	0.05	0.1284	\$1,157.21	
32	2047	0.1795	4,511	\$810	485	\$87	4,014	\$720	9,010	\$1,617	0.05	0.1295	\$1,166.51	
33	2048	0.1805	4,511	\$814	485	\$88	4,014	\$725	9,010	\$1,626	0.05	0.1305	\$1,175.87	
34	2049	0.1816	4,511	\$819	485	\$88	4,014	\$729	9,010	\$1,636	0.05	0.1316	\$1,185.28	
35	2050	0.1826	4,511	\$824	485	\$89	4,014	\$733	9,010	\$1,645	0.05	0.1326	\$1,194.74	
36	2051	0.1837	4,511	\$828	485	\$89	4,014	\$737	9,010	\$1,655	0.05	0.1337	\$1,204.26	
37	2052	0.1847	4,511	\$833	485	\$90	4,014	\$741	9,010	\$1,664	0.05	0.1347	\$1,213.83	
38	2053	0.1858	4,511	\$838	485	\$90	4,014	\$746	9,010	\$1,674	0.05	0.1358	\$1,223.46	
39	2054	0.1869	4,511	\$843	485	\$91	4,014	\$750	9,010	\$1,684	0.05	0.1369	\$1,233.14	
40	2055	0.1879	4,511	\$848	485	\$91	4,014	\$754	9,010	\$1,693	0.05	0.1379	\$1,242.88	
41	2056	0.1890	4,511	\$853	485	\$92	4,014	\$759	9,010	\$1,703	0.05	0.1390	\$1,252.68	
42	2057	0.1901	4,511	\$858	485	\$92	4,014	\$763	9,010	\$1,713	0.05	0.1401	\$1,262.53	
43	2058	0.1912	4,511	\$863	485	\$93	4,014	\$768	9,010	\$1,723	0.05	0.1412	\$1,272.44	
44	2059	0.1923	4,511	\$868	485	\$93	4,014	\$772	9,010	\$1,733	0.05	0.1423	\$1,282.40	
45	2060	0.1934	4,511	\$873	485	\$94	4,014	\$776	9,010	\$1,743	0.05	0.1434	\$1,292.43	
46	2061	0.1946	4,511	\$878	485	\$94	4,014	\$781	9,010	\$1,753	0.05	0.1446	\$1,302.51	
47	2062	0.1957	4,511	\$883	485	\$95	4,014	\$785	9,010	\$1,763	0.05	0.1457	\$1,312.65	
48	2063	0.1968	4,511	\$888	485	\$95	4,014	\$790	9,010	\$1,773	0.05	0.1468	\$1,322.85	
49	2064	0.1980	4,511	\$893	485	\$96	4,014	\$795	9,010	\$1,784	0.05	0.1480	\$1,333.11	
50	2065	0.1991	4,511	\$898	485	\$97	4,014	\$799	9,010	\$1,794	0.05	0.1491	\$1,343.43	
51	2066	0.2003	4,511	\$903	485	\$97	4,014	\$804	9,010	\$1,804	0.05	0.1503	\$1,353.81	
52	2067	0.2014	4,511	\$909	485	\$98	4,014	\$808	9,010	\$1,815	0.05	0.1514	\$1,364.24	
53	2068	0.2026	4,511	\$914	485	\$98	4,014	\$813	9,010	\$1,825	0.05	0.1526	\$1,374.74	
54	2069	0.2038	4,511	\$919	485	\$99	4,014	\$818	9,010	\$1,836	0.05	0.1538	\$1,385.30	
55	2070	0.2049	4,511	\$924	485	\$99	4,014	\$823	9,010	\$1,846	0.05	0.1549	\$1,395.92	
56	2071	0.2061	4,511	\$930	485	\$100	4,014	\$827	9,010	\$1,857	0.05	0.1561	\$1,406.60	
57	2072	0.2073	4,511	\$935	485	\$101	4,014	\$832	9,010	\$1,868	0.05	0.1573	\$1,417.35	
58	2073	0.2085	4,511	\$941	485	\$101	4,014	\$837	9,010	\$1,879	0.05	0.1585	\$1,428.15	
59	2074	0.2097	4,511	\$946	485	\$102	4,014	\$842	9,010	\$1,890	0.05	0.1597	\$1,439.02	
60	2075	0.2109	4,511	\$951	485	\$102	4,014	\$847	9,010	\$1,900	0.05	0.1609	\$1,449.95	

Table D1-1.34: Annual Operating Costs (V.GSHP) of a 2,000 square feet detached house above grade (average construction type) in the city of Saint Catharines (two life cycles and three life cycles for a 60 year project lifespan); base case scenario in comparison with feed in-tariff (FIT) scenario. In the FIT scenario, an incentive of \$0.05/KWh is provided on electricity bills throughout the project lifespan

Horizontal Ground Source Heat Pump (H.GSHP)

Base Case Scenario												Feed in Tariff (FIT)		
#	Year	Electricity Rates		Heating		Cooling		Hot Water		Total	Total	FIT		
		\$/kWh	kWh	Operating Cost	Operating Cost	Operating Cost	Operating Cost	Operating Cost	Operating Cost	Incentives (\$/kWh)	\$/kWh	Operating Cost		
1	2016	0.1501	4,588	\$689	\$497	\$75	3,988	\$599	9,073	\$1,362	0.05	0.1001	\$908.05	
2	2017	0.1542	4,588	\$707	\$497	\$77	3,988	\$615	9,073	\$1,399	0.05	0.1042	\$945.29	
3	2018	0.1583	4,588	\$726	\$497	\$79	3,988	\$631	9,073	\$1,436	0.05	0.1083	\$982.52	
4	2019	0.1625	4,588	\$746	\$497	\$81	3,988	\$648	9,073	\$1,475	0.05	0.1125	\$1,021.06	
5	2020	0.1668	4,588	\$765	\$497	\$83	3,988	\$665	9,073	\$1,513	0.05	0.1168	\$1,059.61	
6	2021	0.1621	4,588	\$744	\$497	\$81	3,988	\$647	9,073	\$1,471	0.05	0.1121	\$1,017.47	
7	2022	0.1629	4,588	\$748	\$497	\$81	3,988	\$650	9,073	\$1,478	0.05	0.1129	\$1,024.66	
8	2023	0.1639	4,588	\$752	\$497	\$81	3,988	\$654	9,073	\$1,487	0.05	0.1139	\$1,033.15	
9	2024	0.1648	4,588	\$756	\$497	\$82	3,988	\$657	9,073	\$1,495	0.05	0.1148	\$1,041.64	
10	2025	0.1656	4,588	\$760	\$497	\$82	3,988	\$660	9,073	\$1,502	0.05	0.1156	\$1,048.83	
11	2026	0.1665	4,588	\$764	\$497	\$83	3,988	\$664	9,073	\$1,511	0.05	0.1165	\$1,057.32	
12	2027	0.1674	4,588	\$768	\$497	\$83	3,988	\$668	9,073	\$1,519	0.05	0.1174	\$1,065.48	
13	2028	0.1683	4,588	\$772	\$497	\$84	3,988	\$671	9,073	\$1,527	0.05	0.1183	\$1,073.00	
14	2029	0.1692	4,588	\$776	\$497	\$84	3,988	\$675	9,073	\$1,535	0.05	0.1192	\$1,081.16	
15	2030	0.1701	4,588	\$780	\$497	\$85	3,988	\$678	9,073	\$1,543	0.05	0.1201	\$1,089.65	
16	2031	0.1704	4,588	\$782	\$497	\$85	3,988	\$679	9,073	\$1,546	0.05	0.1204	\$1,091.94	
17	2032	0.1705	4,588	\$782	\$497	\$85	3,988	\$680	9,073	\$1,547	0.05	0.1205	\$1,093.25	
18	2033	0.1707	4,588	\$783	\$497	\$85	3,988	\$681	9,073	\$1,549	0.05	0.1207	\$1,095.53	
19	2034	0.1710	4,588	\$785	\$497	\$85	3,988	\$682	9,073	\$1,552	0.05	0.1210	\$1,098.15	
20	2035	0.1713	4,588	\$786	\$497	\$85	3,988	\$683	9,073	\$1,554	0.05	0.1213	\$1,100.43	
21	2036	0.1714	4,588	\$787	\$497	\$85	3,988	\$684	9,073	\$1,555	0.05	0.1214	\$1,101.74	
22	2037	0.1717	4,588	\$788	\$497	\$85	3,988	\$685	9,073	\$1,558	0.05	0.1217	\$1,104.03	
23	2038	0.1720	4,588	\$789	\$497	\$85	3,988	\$686	9,073	\$1,560	0.05	0.1220	\$1,106.64	
24	2039	0.1722	4,588	\$790	\$497	\$86	3,988	\$687	9,073	\$1,563	0.05	0.1222	\$1,108.93	
25	2040	0.1724	4,588	\$791	\$497	\$86	3,988	\$687	9,073	\$1,564	0.05	0.1224	\$1,110.23	
26	2041	0.1734	4,588	\$795	\$497	\$86	3,988	\$691	9,073	\$1,573	0.05	0.1234	\$1,119.28	
27	2042	0.1744	4,588	\$800	\$497	\$87	3,988	\$695	9,073	\$1,582	0.05	0.1244	\$1,128.38	
28	2043	0.1754	4,588	\$805	\$497	\$87	3,988	\$699	9,073	\$1,591	0.05	0.1254	\$1,137.53	
29	2044	0.1764	4,588	\$809	\$497	\$88	3,988	\$703	9,073	\$1,600	0.05	0.1264	\$1,146.73	
30	2045	0.1774	4,588	\$814	\$497	\$88	3,988	\$708	9,073	\$1,610	0.05	0.1274	\$1,155.99	
31	2046	0.1784	4,588	\$819	\$497	\$89	3,988	\$712	9,073	\$1,619	0.05	0.1284	\$1,165.30	
32	2047	0.1795	4,588	\$823	\$497	\$89	3,988	\$716	9,073	\$1,628	0.05	0.1295	\$1,174.67	
33	2048	0.1805	4,588	\$828	\$497	\$90	3,988	\$720	9,073	\$1,638	0.05	0.1305	\$1,184.09	
34	2049	0.1816	4,588	\$833	\$497	\$90	3,988	\$724	9,073	\$1,647	0.05	0.1316	\$1,193.56	
35	2050	0.1826	4,588	\$838	\$497	\$91	3,988	\$728	9,073	\$1,657	0.05	0.1326	\$1,203.09	
36	2051	0.1837	4,588	\$843	\$497	\$91	3,988	\$732	9,073	\$1,666	0.05	0.1337	\$1,212.68	
37	2052	0.1847	4,588	\$847	\$497	\$92	3,988	\$737	9,073	\$1,676	0.05	0.1347	\$1,222.32	
38	2053	0.1858	4,588	\$852	\$497	\$92	3,988	\$741	9,073	\$1,686	0.05	0.1358	\$1,232.01	
39	2054	0.1869	4,588	\$857	\$497	\$93	3,988	\$745	9,073	\$1,695	0.05	0.1369	\$1,241.76	
40	2055	0.1879	4,588	\$862	\$497	\$93	3,988	\$750	9,073	\$1,705	0.05	0.1379	\$1,251.57	
41	2056	0.1890	4,588	\$867	\$497	\$94	3,988	\$754	9,073	\$1,715	0.05	0.1390	\$1,261.43	
42	2057	0.1901	4,588	\$872	\$497	\$94	3,988	\$758	9,073	\$1,725	0.05	0.1401	\$1,271.36	
43	2058	0.1912	4,588	\$877	\$497	\$95	3,988	\$763	9,073	\$1,735	0.05	0.1412	\$1,281.34	
44	2059	0.1923	4,588	\$882	\$497	\$96	3,988	\$767	9,073	\$1,745	0.05	0.1423	\$1,291.37	
45	2060	0.1934	4,588	\$888	\$497	\$96	3,988	\$771	9,073	\$1,755	0.05	0.1434	\$1,301.47	
46	2061	0.1946	4,588	\$893	\$497	\$97	3,988	\$776	9,073	\$1,765	0.05	0.1446	\$1,311.62	
47	2062	0.1957	4,588	\$898	\$497	\$97	3,988	\$780	9,073	\$1,775	0.05	0.1457	\$1,321.83	
48	2063	0.1968	4,588	\$903	\$497	\$98	3,988	\$785	9,073	\$1,786	0.05	0.1468	\$1,332.10	
49	2064	0.1980	4,588	\$908	\$497	\$98	3,988	\$789	9,073	\$1,796	0.05	0.1480	\$1,342.43	
50	2065	0.1991	4,588	\$913	\$497	\$99	3,988	\$794	9,073	\$1,806	0.05	0.1491	\$1,352.82	
51	2066	0.2003	4,588	\$919	\$497	\$100	3,988	\$799	9,073	\$1,817	0.05	0.1503	\$1,363.27	
52	2067	0.2014	4,588	\$924	\$497	\$100	3,988	\$803	9,073	\$1,827	0.05	0.1514	\$1,373.78	
53	2068	0.2026	4,588	\$929	\$497	\$101	3,988	\$808	9,073	\$1,838	0.05	0.1526	\$1,384.36	
54	2069	0.2038	4,588	\$935	\$497	\$101	3,988	\$813	9,073	\$1,849	0.05	0.1538	\$1,394.99	
55	2070	0.2049	4,588	\$940	\$497	\$102	3,988	\$817	9,073	\$1,859	0.05	0.1549	\$1,405.68	
56	2071	0.2061	4,588	\$946	\$497	\$102	3,988	\$822	9,073	\$1,870	0.05	0.1561	\$1,416.44	
57	2072	0.2073	4,588	\$951	\$497	\$103	3,988	\$827	9,073	\$1,881	0.05	0.1573	\$1,427.26	
58	2073	0.2085	4,588	\$957	\$497	\$104	3,988	\$832	9,073	\$1,892	0.05	0.1585	\$1,438.14	
59	2074	0.2097	4,588	\$962	\$497	\$104	3,988	\$836	9,073	\$1,903	0.05	0.1597	\$1,449.08	
60	2075	0.2109	4,588	\$968	\$497	\$105	3,988	\$841	9,073	\$1,914	0.05	0.1609	\$1,460.09	

Table D1-1.35: Annual Operating Costs (H.GSHP) of a 2,000 square feet detached house above grade (average construction type) in the city of Saint Catharines (two life cycles and three life cycles for a 60 year project lifespan); base case scenario in comparison with feed in-tariff (FIT) scenario. In the FIT scenario, an incentive of \$0.05/KWh is provided on electricity bills throughout the project lifespan

Traditional HVAC Applications

Base Case Scenario															Carbon Taxes							
#	Year	Traditional													Carbon Taxes							
		Electricity Rates	Natural Gas Rates	Heating		Heating Operating Cost	Heating Operating Cost	Total Heating Operating Cost	Cooling	Cooling Operating Cost	Hot Water	Hot Water Operating Cost	Total	Total	Total Electricity Operating Cost	Total Natural Gas Operating Cost	Total	Conversion of m ³ into Tons	Total Tons	Carbon Tax	Operating Costs	
		\$/KWh	\$/m ³	KWh (Electricity)	m ³ (Gas)	\$(Electricity)	\$(Gas)	\$	KWh	\$	m ³	\$	KWh	m ³	\$(KWh)	\$(m ³)	\$1681			\$10		
1	2016	0.1501	0.3458	1,628	2,237	\$244	\$774	\$1,018	2,218	\$333	955	\$330	3,846	3,192	577	\$1,104	\$1,681	5.78	5.78	\$10	\$57.78	\$1,738.88
2	2017	0.1542	0.3588	1,628	2,237	\$251	\$803	\$1,054	2,218	\$342	955	\$347	3,846	3,192	593	\$1,145	\$1,738	5.78	5.78	\$20	\$115.55	\$1,853.96
3	2018	0.1583	0.3718	1,628	2,237	\$258	\$832	\$1,090	2,218	\$351	955	\$351	3,846	3,192	609	\$1,187	\$1,796	5.78	5.78	\$30	\$173.33	\$1,969.04
4	2019	0.1625	0.3776	1,628	2,237	\$265	\$845	\$1,109	2,218	\$361	955	\$355	3,846	3,192	625	\$1,205	\$1,830	5.78	5.78	\$40	\$231.10	\$2,061.47
5	2020	0.1668	0.3841	1,628	2,237	\$272	\$859	\$1,131	2,218	\$370	955	\$359	3,846	3,192	641	\$1,226	\$1,867	5.78	5.78	\$50	\$288.88	\$2,156.34
6	2021	0.1621	0.3883	1,628	2,237	\$264	\$869	\$1,133	2,218	\$360	955	\$355	3,846	3,192	624	\$1,239	\$1,863	5.78	5.78	\$60	\$346.65	\$2,209.69
7	2022	0.1629	0.3929	1,628	2,237	\$265	\$879	\$1,144	2,218	\$361	955	\$356	3,846	3,192	627	\$1,254	\$1,881	5.78	5.78	\$70	\$404.43	\$2,285.16
8	2023	0.1639	0.3967	1,628	2,237	\$267	\$887	\$1,154	2,218	\$363	955	\$356	3,846	3,192	630	\$1,266	\$1,897	5.78	5.78	\$80	\$462.20	\$2,358.75
9	2024	0.1648	0.4005	1,628	2,237	\$268	\$896	\$1,164	2,218	\$366	955	\$357	3,846	3,192	634	\$1,279	\$1,912	5.78	5.78	\$90	\$519.98	\$2,432.33
10	2025	0.1656	0.4040	1,628	2,237	\$270	\$904	\$1,173	2,218	\$367	955	\$358	3,846	3,192	637	\$1,289	\$1,926	5.78	5.78	\$100	\$577.75	\$2,504.14
11	2026	0.1665	0.4070	1,628	2,237	\$271	\$911	\$1,182	2,218	\$369	955	\$359	3,846	3,192	640	\$1,299	\$1,940	5.78	5.78	\$110	\$635.53	\$2,575.29
12	2027	0.1674	0.4097	1,628	2,237	\$273	\$917	\$1,189	2,218	\$371	955	\$360	3,846	3,192	644	\$1,308	\$1,952	5.78	5.78	\$120	\$693.30	\$2,645.07
13	2028	0.1683	0.4124	1,628	2,237	\$274	\$923	\$1,196	2,218	\$373	955	\$361	3,846	3,192	647	\$1,316	\$1,964	5.78	5.78	\$130	\$751.08	\$2,714.58
14	2029	0.1692	0.4151	1,628	2,237	\$275	\$929	\$1,204	2,218	\$375	955	\$362	3,846	3,192	651	\$1,325	\$1,976	5.78	5.78	\$140	\$808.85	\$2,784.36
15	2030	0.1701	0.4170	1,628	2,237	\$277	\$933	\$1,210	2,218	\$377	955	\$362	3,846	3,192	654	\$1,331	\$1,985	5.78	5.78	\$150	\$866.63	\$2,851.84
16	2031	0.1704	0.4189	1,628	2,237	\$277	\$937	\$1,214	2,218	\$378	955	\$363	3,846	3,192	655	\$1,337	\$1,992	5.78	5.78	\$160	\$924.40	\$2,916.69
17	2032	0.1705	0.4204	1,628	2,237	\$278	\$940	\$1,218	2,218	\$378	955	\$363	3,846	3,192	656	\$1,342	\$1,998	5.78	5.78	\$170	\$982.18	\$2,979.91
18	2033	0.1707	0.4223	1,628	2,237	\$278	\$945	\$1,223	2,218	\$379	955	\$363	3,846	3,192	657	\$1,348	\$2,005	5.78	5.78	\$180	\$1,039.95	\$3,044.76
19	2034	0.1710	0.4246	1,628	2,237	\$278	\$950	\$1,228	2,218	\$379	955	\$363	3,846	3,192	658	\$1,355	\$2,013	5.78	5.78	\$190	\$1,097.73	\$3,110.97
20	2035	0.1713	0.4265	1,628	2,237	\$279	\$954	\$1,233	2,218	\$380	955	\$364	3,846	3,192	659	\$1,362	\$2,020	5.78	5.78	\$200	\$1,155.50	\$3,175.82
21	2036	0.1714	0.4288	1,628	2,237	\$279	\$959	\$1,238	2,218	\$380	955	\$364	3,846	3,192	659	\$1,369	\$2,028	5.78	5.78	\$210	\$1,213.28	\$3,241.47
22	2037	0.1717	0.4311	1,628	2,237	\$279	\$964	\$1,244	2,218	\$381	955	\$364	3,846	3,192	660	\$1,376	\$2,036	5.78	5.78	\$220	\$1,271.05	\$3,307.54
23	2038	0.1720	0.4331	1,628	2,237	\$280	\$969	\$1,249	2,218	\$381	955	\$364	3,846	3,192	661	\$1,382	\$2,044	5.78	5.78	\$230	\$1,328.83	\$3,372.53
24	2039	0.1722	0.4353	1,628	2,237	\$280	\$974	\$1,254	2,218	\$382	955	\$364	3,846	3,192	662	\$1,390	\$2,052	5.78	5.78	\$240	\$1,386.60	\$3,438.60
25	2040	0.1724	0.4376	1,628	2,237	\$281	\$979	\$1,260	2,218	\$382	955	\$365	3,846	3,192	663	\$1,397	\$2,060	5.78	5.78	\$250	\$1,444.38	\$3,504.26
26	2041	0.1734	0.4420	1,628	2,237	\$282	\$989	\$1,271	2,218	\$385	955	\$366	3,846	3,192	667	\$1,411	\$2,077	5.78	5.78	\$260	\$1,502.16	\$3,570.67
27	2042	0.1744	0.4463	1,628	2,237	\$284	\$998	\$1,282	2,218	\$387	955	\$367	3,846	3,192	671	\$1,425	\$2,095	5.78	5.78	\$270	\$1,559.93	\$3,635.18
28	2043	0.1754	0.4507	1,628	2,237	\$286	\$1,008	\$1,294	2,218	\$389	955	\$367	3,846	3,192	674	\$1,439	\$2,113	5.78	5.78	\$280	\$1,617.71	\$3,703.88
29	2044	0.1764	0.4552	1,628	2,237	\$287	\$1,018	\$1,305	2,218	\$391	955	\$368	3,846	3,192	678	\$1,453	\$2,131	5.78	5.78	\$290	\$1,675.48	\$3,806.74
30	2045	0.1774	0.4596	1,628	2,237	\$289	\$1,028	\$1,317	2,218	\$393	955	\$369	3,846	3,192	682	\$1,467	\$2,150	5.78	5.78	\$300	\$1,733.25	\$3,888.77
31	2046	0.1784	0.4642	1,628	2,237	\$290	\$1,038	\$1,329	2,218	\$396	955	\$370	3,846	3,192	686	\$1,482	\$2,168	5.78	5.78	\$310	\$1,791.03	\$3,958.96
32	2047	0.1795	0.4688	1,628	2,237	\$292	\$1,049	\$1,341	2,218	\$398	955	\$371	3,846	3,192	690	\$1,496	\$2,187	5.78	5.78	\$320	\$1,848.81	\$4,035.31
33	2048	0.1805	0.4734	1,628	2,237	\$294	\$1,059	\$1,353	2,218	\$400	955	\$372	3,846	3,192	694	\$1,511	\$2,205	5.78	5.78	\$330	\$1,906.58	\$4,111.83
34	2049	0.1816	0.4780	1,628	2,237	\$296	\$1,069	\$1,365	2,218	\$403	955	\$373	3,846	3,192	698	\$1,526	\$2,224	5.78	5.78	\$340	\$1,964.36	\$4,188.52
35	2050	0.1826	0.4828	1,628	2,237	\$297	\$1,080	\$1,377	2,218	\$405	955	\$374	3,846	3,192	702	\$1,541	\$2,243	5.78	5.78	\$350	\$2,022.13	\$4,265.37
36	2051	0.1837	0.4875	1,628	2,237	\$299	\$1,091	\$1,390	2,218	\$407	955	\$375	3,846	3,192	706	\$1,556	\$2,262	5.78	5.78	\$360	\$2,079.91	\$4,342.40
37	2052	0.1847	0.4923	1,628	2,237	\$301	\$1,101	\$1,402	2,218	\$410	955	\$376	3,846	3,192	710	\$1,571	\$2,282	5.78	5.78	\$370	\$2,137.68	\$4,419.61
38	2053	0.1858	0.4972	1,628	2,237	\$302	\$1,112	\$1,415	2,218	\$412	955	\$377	3,846	3,192	715	\$1,587	\$2,302	5.78	5.78	\$380	\$2,195.46	\$4,496.99
39	2054	0.1869	0.5021	1,628	2,237	\$304	\$1,123	\$1,427	2,218	\$414	955	\$378	3,846	3,192	719	\$1,603	\$2,321	5.78	5.78	\$390	\$2,253.23	\$4,574.54
40	2055	0.1879	0.5070	1,628	2,237	\$306	\$1,134	\$1,440	2,218	\$417	955	\$379	3,846	3,192	723	\$1,618	\$2,341	5.78	5.78	\$400	\$2,311.01	\$4,652.27
41	2056	0.1890	0.5120	1,628	2,237	\$308	\$1,145	\$1,453	2,218	\$419	955	\$381	3,846	3,192	727	\$1,634	\$2,361	5.78	5.78	\$410	\$2,368.78	\$4,730.19
42	2057	0.1901	0.5171	1,628	2,237	\$310	\$1,157	\$1,466	2,218	\$422	955	\$382	3,846	3,192	731	\$1,651	\$2,382	5.78	5.78	\$420	\$2,426.56	\$4,808.28
43	2058	0.1912	0.5222	1,628	2,237	\$311	\$1,168	\$1,479	2,218	\$424	955	\$383	3,846	3,192	735	\$1,667	\$2,402	5.78	5.78	\$430	\$2,484.33	\$4,886.56
44	2059	0.1923	0.5273	1,628	2,237	\$313	\$1,180	\$1,493	2,218	\$427	955	\$384	3,846	3,192	740	\$1,683	\$2,423	5.78	5.78	\$440	\$2,542.11	\$4,965.02
45	2060	0.1934	0.5325	1,628	2,237	\$315	\$1,191	\$1,506	2,218	\$429	955	\$385	3,846	3,192	744	\$1,700	\$2,444	5.78	5.78	\$450	\$2,599.88	\$5,043.67
46	2061	0.1946	0.5378	1,628	2,237	\$317	\$1,203	\$1,520	2,218	\$432	955	\$386	3,846	3,192	748	\$1,717	\$2,465	5.78	5.78	\$460	\$2,657.66	\$5,122.51
47	2062	0.1957	0.5431	1,628	2,237	\$319	\$1,215	\$1,533	2,218	\$434	955	\$387	3,846	3,192	753	\$1,733	\$2,486	5.78	5.78	\$470	\$2,715.43	\$5,201.53
48	2063	0.1968	0.5484	1,628	2,237	\$320	\$1,227	\$1,547	2,218	\$437	955	\$388	3,846	3,192	757	\$1,751	\$2,508	5.78	5.78	\$480	\$2,773.21	\$5,280.75
49	2064	0.1980	0.5538	1,628	2,237	\$322	\$1,239	\$1,561	2,218	\$439	955	\$389	3,846	3,192	761	\$1,768	\$2,529	5.78	5.78	\$490	\$2,830.98	\$5,360.17
50	2065	0.1991	0.5593	1,628	2,237	\$324	\$1,251	\$1,575	2,218	\$442	955	\$390	3,846	3,192	766	\$1,785	\$2,551	5.78	5.78	\$500	\$2,888.76	\$5,439.78
51	2066	0.2003	0.5648	1,628	2,237	\$326	\$1,263	\$1,589	2,218	\$444	955	\$391	3,846	3,192	770	\$1,803	\$2,573	5.78	5.78	\$510	\$2,946.54	\$5,519.58
52	2067	0.2014	0.5704	1,628	2,237	\$328	\$1,276	\$1,604	2,218	\$447	955	\$392	3,846	3,192	775	\$1,821	\$2,595	5.78	5.78	\$520	\$3,004.31	\$5,599.59
53	2068	0.2026	0.5760	1,628	2,237	\$330	\$1,289	\$1,618	2,218	\$449	955	\$393	3,846	3,192	779	\$1,839	\$2,618	5.78	5.78	\$530	\$3,062.09	\$5,679.79
54	2069	0.2038	0.																			

13. Toronto (South) – Annual Operating Costs

Vertical Ground Source Heat Pump (V.GSHP)

Base Case Scenario											Feed in Tariff (FIT)		
#	Year	Electricity Rates		V.GSHP		Hot Water		Total	Total Operating Cost	FIT	Incentives (\$/KWh)	FIT	
		\$/KWh	KWh	Heating Operating Cost	Cooling Operating Cost	Hot Water Operating Cost	\$/KWh						Operating Cost
1	2016	0.1501	5,380	\$807	\$327	\$49	\$645	10,005	\$1,502	0.05	0.1001	\$1,001.33	
2	2017	0.1542	5,380	\$830	\$327	\$50	\$663	10,005	\$1,543	0.05	0.1042	\$1,042.39	
3	2018	0.1583	5,380	\$852	\$327	\$52	\$680	10,005	\$1,584	0.05	0.1083	\$1,083.45	
4	2019	0.1625	5,380	\$874	\$327	\$53	\$699	10,005	\$1,626	0.05	0.1125	\$1,125.95	
5	2020	0.1668	5,380	\$897	\$327	\$55	\$717	10,005	\$1,669	0.05	0.1168	\$1,168.45	
6	2021	0.1621	5,380	\$872	\$327	\$53	\$697	10,005	\$1,622	0.05	0.1121	\$1,121.99	
7	2022	0.1629	5,380	\$877	\$327	\$53	\$700	10,005	\$1,630	0.05	0.1129	\$1,129.91	
8	2023	0.1639	5,380	\$882	\$327	\$54	\$704	10,005	\$1,640	0.05	0.1139	\$1,139.28	
9	2024	0.1648	5,380	\$887	\$327	\$54	\$708	10,005	\$1,649	0.05	0.1148	\$1,148.64	
10	2025	0.1656	5,380	\$891	\$327	\$54	\$712	10,005	\$1,657	0.05	0.1156	\$1,156.56	
11	2026	0.1665	5,380	\$896	\$327	\$54	\$716	10,005	\$1,666	0.05	0.1165	\$1,165.93	
12	2027	0.1674	5,380	\$901	\$327	\$55	\$720	10,005	\$1,675	0.05	0.1174	\$1,174.93	
13	2028	0.1683	5,380	\$905	\$327	\$55	\$723	10,005	\$1,683	0.05	0.1183	\$1,183.22	
14	2029	0.1692	5,380	\$910	\$327	\$55	\$727	10,005	\$1,692	0.05	0.1192	\$1,192.22	
15	2030	0.1701	5,380	\$915	\$327	\$56	\$731	10,005	\$1,702	0.05	0.1201	\$1,201.59	
16	2031	0.1704	5,380	\$916	\$327	\$56	\$732	10,005	\$1,704	0.05	0.1204	\$1,204.11	
17	2032	0.1705	5,380	\$917	\$327	\$56	\$733	10,005	\$1,706	0.05	0.1205	\$1,205.55	
18	2033	0.1707	5,380	\$919	\$327	\$56	\$734	10,005	\$1,708	0.05	0.1207	\$1,208.07	
19	2034	0.1710	5,380	\$920	\$327	\$56	\$735	10,005	\$1,711	0.05	0.1210	\$1,210.95	
20	2035	0.1713	5,380	\$922	\$327	\$56	\$736	10,005	\$1,714	0.05	0.1213	\$1,213.47	
21	2036	0.1714	5,380	\$922	\$327	\$56	\$737	10,005	\$1,715	0.05	0.1214	\$1,214.91	
22	2037	0.1717	5,380	\$924	\$327	\$56	\$738	10,005	\$1,718	0.05	0.1217	\$1,217.43	
23	2038	0.1720	5,380	\$925	\$327	\$56	\$739	10,005	\$1,721	0.05	0.1220	\$1,220.32	
24	2039	0.1722	5,380	\$927	\$327	\$56	\$740	10,005	\$1,723	0.05	0.1222	\$1,222.84	
25	2040	0.1724	5,380	\$927	\$327	\$56	\$741	10,005	\$1,725	0.05	0.1224	\$1,224.28	
26	2041	0.1734	5,380	\$933	\$327	\$57	\$745	10,005	\$1,735	0.05	0.1234	\$1,234.25	
27	2042	0.1744	5,380	\$938	\$327	\$57	\$749	10,005	\$1,745	0.05	0.1244	\$1,244.29	
28	2043	0.1754	5,380	\$944	\$327	\$57	\$754	10,005	\$1,755	0.05	0.1254	\$1,254.38	
29	2044	0.1764	5,380	\$949	\$327	\$58	\$758	10,005	\$1,765	0.05	0.1264	\$1,264.53	
30	2045	0.1774	5,380	\$954	\$327	\$58	\$763	10,005	\$1,775	0.05	0.1274	\$1,274.74	
31	2046	0.1784	5,380	\$960	\$327	\$58	\$767	10,005	\$1,785	0.05	0.1284	\$1,285.01	
32	2047	0.1795	5,380	\$966	\$327	\$59	\$771	10,005	\$1,796	0.05	0.1295	\$1,295.33	
33	2048	0.1805	5,380	\$971	\$327	\$59	\$776	10,005	\$1,806	0.05	0.1305	\$1,305.72	
34	2049	0.1816	5,380	\$977	\$327	\$59	\$780	10,005	\$1,816	0.05	0.1316	\$1,316.17	
35	2050	0.1826	5,380	\$982	\$327	\$60	\$785	10,005	\$1,827	0.05	0.1326	\$1,326.68	
36	2051	0.1837	5,380	\$988	\$327	\$60	\$789	10,005	\$1,837	0.05	0.1337	\$1,337.25	
37	2052	0.1847	5,380	\$994	\$327	\$60	\$794	10,005	\$1,848	0.05	0.1347	\$1,347.88	
38	2053	0.1858	5,380	\$1,000	\$327	\$61	\$799	10,005	\$1,859	0.05	0.1358	\$1,358.57	
39	2054	0.1869	5,380	\$1,005	\$327	\$61	\$803	10,005	\$1,870	0.05	0.1369	\$1,369.32	
40	2055	0.1879	5,380	\$1,011	\$327	\$61	\$808	10,005	\$1,880	0.05	0.1379	\$1,380.13	
41	2056	0.1890	5,380	\$1,017	\$327	\$62	\$812	10,005	\$1,891	0.05	0.1390	\$1,391.01	
42	2057	0.1901	5,380	\$1,023	\$327	\$62	\$817	10,005	\$1,902	0.05	0.1401	\$1,401.95	
43	2058	0.1912	5,380	\$1,029	\$327	\$63	\$822	10,005	\$1,913	0.05	0.1412	\$1,412.96	
44	2059	0.1923	5,380	\$1,035	\$327	\$63	\$827	10,005	\$1,924	0.05	0.1423	\$1,424.02	
45	2060	0.1934	5,380	\$1,041	\$327	\$63	\$831	10,005	\$1,935	0.05	0.1434	\$1,435.16	
46	2061	0.1946	5,380	\$1,047	\$327	\$64	\$836	10,005	\$1,947	0.05	0.1446	\$1,446.35	
47	2062	0.1957	5,380	\$1,053	\$327	\$64	\$841	10,005	\$1,958	0.05	0.1457	\$1,457.61	
48	2063	0.1968	5,380	\$1,059	\$327	\$64	\$846	10,005	\$1,969	0.05	0.1468	\$1,468.94	
49	2064	0.1980	5,380	\$1,065	\$327	\$65	\$851	10,005	\$1,981	0.05	0.1480	\$1,480.33	
50	2065	0.1991	5,380	\$1,071	\$327	\$65	\$856	10,005	\$1,992	0.05	0.1491	\$1,491.79	
51	2066	0.2003	5,380	\$1,077	\$327	\$65	\$861	10,005	\$2,004	0.05	0.1503	\$1,503.31	
52	2067	0.2014	5,380	\$1,084	\$327	\$66	\$866	10,005	\$2,015	0.05	0.1514	\$1,514.90	
53	2068	0.2026	5,380	\$1,090	\$327	\$66	\$871	10,005	\$2,027	0.05	0.1526	\$1,526.56	
54	2069	0.2038	5,380	\$1,096	\$327	\$67	\$876	10,005	\$2,039	0.05	0.1538	\$1,538.28	
55	2070	0.2049	5,380	\$1,103	\$327	\$67	\$881	10,005	\$2,050	0.05	0.1549	\$1,550.08	
56	2071	0.2061	5,380	\$1,109	\$327	\$67	\$886	10,005	\$2,062	0.05	0.1561	\$1,561.94	
57	2072	0.2073	5,380	\$1,115	\$327	\$68	\$891	10,005	\$2,074	0.05	0.1573	\$1,573.87	
58	2073	0.2085	5,380	\$1,122	\$327	\$68	\$896	10,005	\$2,086	0.05	0.1585	\$1,585.87	
59	2074	0.2097	5,380	\$1,128	\$327	\$69	\$901	10,005	\$2,098	0.05	0.1597	\$1,597.93	
60	2075	0.2109	5,380	\$1,135	\$327	\$69	\$907	10,005	\$2,110	0.05	0.1609	\$1,610.07	

Table D1-1.37: Annual Operating Costs (V.GSHP) of a 2,000 square feet detached house above grade (average construction type) in the city of Toronto (two life cycles and three life cycles for a 60 year project lifespan); base case scenario in comparison with feed-in-tariff (FIT) scenario. In the FIT scenario, an incentive of \$0.05/KWh is provided on electricity bills throughout the project lifespan

Horizontal Ground Source Heat Pump (H.GSHP)

Base Case Scenario											Feed in Tariff (FIT)		
#	Year	H.GSHP									FIT		
		Electricity Rates \$/KWh	Heating KWh	Heating Operating Cost \$	Cooling KWh	Cooling Operating Cost \$	Hot Water KWh	Hot Water Operating Cost \$	Total KWh	Total Operating Cost \$	Incentives (\$/KWh)	\$/KWh	Operating Cost
1	2016	0.1501	5,469	\$821	335	\$50	4,275	\$642	10,079	\$1,513	0.05	0.1001	\$1,008.73
2	2017	0.1542	5,469	\$843	335	\$52	4,275	\$659	10,079	\$1,554	0.05	0.1042	\$1,050.10
3	2018	0.1583	5,469	\$866	335	\$53	4,275	\$677	10,079	\$1,595	0.05	0.1083	\$1,091.46
4	2019	0.1625	5,469	\$889	335	\$54	4,275	\$695	10,079	\$1,638	0.05	0.1125	\$1,134.28
5	2020	0.1668	5,469	\$912	335	\$56	4,275	\$713	10,079	\$1,681	0.05	0.1168	\$1,177.09
6	2021	0.1621	5,469	\$887	335	\$54	4,275	\$693	10,079	\$1,634	0.05	0.1121	\$1,130.29
7	2022	0.1629	5,469	\$891	335	\$55	4,275	\$697	10,079	\$1,642	0.05	0.1129	\$1,138.27
8	2023	0.1639	5,469	\$896	335	\$55	4,275	\$701	10,079	\$1,652	0.05	0.1139	\$1,147.70
9	2024	0.1648	5,469	\$901	335	\$55	4,275	\$705	10,079	\$1,661	0.05	0.1148	\$1,157.14
10	2025	0.1656	5,469	\$906	335	\$55	4,275	\$708	10,079	\$1,669	0.05	0.1156	\$1,165.12
11	2026	0.1665	5,469	\$911	335	\$56	4,275	\$712	10,079	\$1,679	0.05	0.1165	\$1,174.55
12	2027	0.1674	5,469	\$916	335	\$56	4,275	\$716	10,079	\$1,688	0.05	0.1174	\$1,183.62
13	2028	0.1683	5,469	\$920	335	\$56	4,275	\$719	10,079	\$1,696	0.05	0.1183	\$1,191.97
14	2029	0.1692	5,469	\$925	335	\$57	4,275	\$723	10,079	\$1,705	0.05	0.1192	\$1,201.04
15	2030	0.1701	5,469	\$930	335	\$57	4,275	\$727	10,079	\$1,714	0.05	0.1201	\$1,210.47
16	2031	0.1704	5,469	\$932	335	\$57	4,275	\$728	10,079	\$1,717	0.05	0.1204	\$1,213.01
17	2032	0.1705	5,469	\$932	335	\$57	4,275	\$729	10,079	\$1,718	0.05	0.1205	\$1,214.47
18	2033	0.1707	5,469	\$934	335	\$57	4,275	\$730	10,079	\$1,721	0.05	0.1207	\$1,217.01
19	2034	0.1710	5,469	\$935	335	\$57	4,275	\$731	10,079	\$1,724	0.05	0.1210	\$1,219.91
20	2035	0.1713	5,469	\$937	335	\$57	4,275	\$732	10,079	\$1,726	0.05	0.1213	\$1,222.45
21	2036	0.1714	5,469	\$938	335	\$57	4,275	\$733	10,079	\$1,728	0.05	0.1214	\$1,223.90
22	2037	0.1717	5,469	\$939	335	\$58	4,275	\$734	10,079	\$1,730	0.05	0.1217	\$1,226.44
23	2038	0.1720	5,469	\$941	335	\$58	4,275	\$735	10,079	\$1,733	0.05	0.1220	\$1,229.34
24	2039	0.1722	5,469	\$942	335	\$58	4,275	\$736	10,079	\$1,736	0.05	0.1222	\$1,231.88
25	2040	0.1724	5,469	\$943	335	\$58	4,275	\$737	10,079	\$1,737	0.05	0.1224	\$1,233.33
26	2041	0.1734	5,469	\$948	335	\$58	4,275	\$741	10,079	\$1,747	0.05	0.1234	\$1,243.38
27	2042	0.1744	5,469	\$954	335	\$58	4,275	\$745	10,079	\$1,757	0.05	0.1244	\$1,253.49
28	2043	0.1754	5,469	\$959	335	\$59	4,275	\$750	10,079	\$1,768	0.05	0.1254	\$1,263.66
29	2044	0.1764	5,469	\$965	335	\$59	4,275	\$754	10,079	\$1,778	0.05	0.1264	\$1,273.88
30	2045	0.1774	5,469	\$970	335	\$59	4,275	\$758	10,079	\$1,788	0.05	0.1274	\$1,284.17
31	2046	0.1784	5,469	\$976	335	\$60	4,275	\$763	10,079	\$1,798	0.05	0.1284	\$1,294.51
32	2047	0.1795	5,469	\$982	335	\$60	4,275	\$767	10,079	\$1,809	0.05	0.1295	\$1,304.92
33	2048	0.1805	5,469	\$987	335	\$60	4,275	\$772	10,079	\$1,819	0.05	0.1305	\$1,315.38
34	2049	0.1816	5,469	\$993	335	\$61	4,275	\$776	10,079	\$1,830	0.05	0.1316	\$1,325.90
35	2050	0.1826	5,469	\$999	335	\$61	4,275	\$781	10,079	\$1,840	0.05	0.1326	\$1,336.49
36	2051	0.1837	5,469	\$1,004	335	\$62	4,275	\$785	10,079	\$1,851	0.05	0.1337	\$1,347.14
37	2052	0.1847	5,469	\$1,010	335	\$62	4,275	\$790	10,079	\$1,862	0.05	0.1347	\$1,357.84
38	2053	0.1858	5,469	\$1,016	335	\$62	4,275	\$794	10,079	\$1,873	0.05	0.1358	\$1,368.61
39	2054	0.1869	5,469	\$1,022	335	\$63	4,275	\$799	10,079	\$1,883	0.05	0.1369	\$1,379.45
40	2055	0.1879	5,469	\$1,028	335	\$63	4,275	\$803	10,079	\$1,894	0.05	0.1379	\$1,390.34
41	2056	0.1890	5,469	\$1,034	335	\$63	4,275	\$808	10,079	\$1,905	0.05	0.1390	\$1,401.30
42	2057	0.1901	5,469	\$1,040	335	\$64	4,275	\$813	10,079	\$1,916	0.05	0.1401	\$1,412.32
43	2058	0.1912	5,469	\$1,046	335	\$64	4,275	\$817	10,079	\$1,927	0.05	0.1412	\$1,423.41
44	2059	0.1923	5,469	\$1,052	335	\$64	4,275	\$822	10,079	\$1,939	0.05	0.1423	\$1,434.56
45	2060	0.1934	5,469	\$1,058	335	\$65	4,275	\$827	10,079	\$1,950	0.05	0.1434	\$1,445.77
46	2061	0.1946	5,469	\$1,064	335	\$65	4,275	\$832	10,079	\$1,961	0.05	0.1446	\$1,457.05
47	2062	0.1957	5,469	\$1,070	335	\$66	4,275	\$837	10,079	\$1,972	0.05	0.1457	\$1,468.39
48	2063	0.1968	5,469	\$1,076	335	\$66	4,275	\$841	10,079	\$1,984	0.05	0.1468	\$1,479.80
49	2064	0.1980	5,469	\$1,083	335	\$66	4,275	\$846	10,079	\$1,995	0.05	0.1480	\$1,491.28
50	2065	0.1991	5,469	\$1,089	335	\$67	4,275	\$851	10,079	\$2,007	0.05	0.1491	\$1,502.82
51	2066	0.2003	5,469	\$1,095	335	\$67	4,275	\$856	10,079	\$2,018	0.05	0.1503	\$1,514.43
52	2067	0.2014	5,469	\$1,102	335	\$67	4,275	\$861	10,079	\$2,030	0.05	0.1514	\$1,526.11
53	2068	0.2026	5,469	\$1,108	335	\$68	4,275	\$866	10,079	\$2,042	0.05	0.1526	\$1,537.85
54	2069	0.2038	5,469	\$1,114	335	\$68	4,275	\$871	10,079	\$2,054	0.05	0.1538	\$1,549.66
55	2070	0.2049	5,469	\$1,121	335	\$69	4,275	\$876	10,079	\$2,065	0.05	0.1549	\$1,561.54
56	2071	0.2061	5,469	\$1,127	335	\$69	4,275	\$881	10,079	\$2,077	0.05	0.1561	\$1,573.49
57	2072	0.2073	5,469	\$1,134	335	\$69	4,275	\$886	10,079	\$2,089	0.05	0.1573	\$1,585.51
58	2073	0.2085	5,469	\$1,140	335	\$70	4,275	\$891	10,079	\$2,102	0.05	0.1585	\$1,597.60
59	2074	0.2097	5,469	\$1,147	335	\$70	4,275	\$897	10,079	\$2,114	0.05	0.1597	\$1,609.75
60	2075	0.2109	5,469	\$1,154	335	\$71	4,275	\$902	10,079	\$2,126	0.05	0.1609	\$1,621.98

Table D1-1.38: Annual Operating Costs (H.GSHP) of a 2,000 square feet detached house above grade (average construction type) in the city of Toronto (two life cycles and three life cycles for a 60 year project lifespan); base case scenario in comparison with feed in-tariff (FIT) scenario. In the FIT scenario, an incentive of \$0.05/KWh is provided on electricity bills throughout the project lifespan

Traditional HVAC Applications

Base Case Scenario															Carbon Taxes							
#	Year	Traditional												Carbon Taxes								
		Electricity Rates \$/KWh	Natural Gas Rates \$/m ³	Heating		Heating Operating Cost \$ (Electricity)	Heating Operating Cost \$ (Gas)	Total Heating Operating Cost \$	Cooling		Hot Water m ³	Hot Water Operating Cost \$	Total KWh	Total m ³	Total Electricity Operating Cost \$ (KWh)	Total Natural Gas Operating Cost \$ (m ³)	Total	Conversion of m ³ into Tons	Total Tons	Carbon Tax	Operating Costs	
				KWh (Electricity)	m ³ (Gas)				KWh	\$												
1	2016	0.1501	0.3458	1,558	2,618	\$234	\$905	\$1,139	1,470	\$221	1,028	\$356	3,028	3,646	454	\$1,261	\$1,715	6.60	6.60	\$10	\$65.99	\$1,781.34
2	2017	0.1542	0.3588	1,558	2,618	\$240	\$939	\$1,180	1,470	\$227	1,028	\$359	3,028	3,646	467	\$1,308	\$1,775	6.60	6.60	\$20	\$131.99	\$1,907.18
3	2018	0.1583	0.3718	1,558	2,618	\$247	\$973	\$1,220	1,470	\$233	1,028	\$363	3,028	3,646	479	\$1,356	\$1,835	6.60	6.60	\$30	\$197.98	\$2,033.03
4	2019	0.1625	0.3776	1,558	2,618	\$253	\$989	\$1,242	1,470	\$239	1,028	\$367	3,028	3,646	492	\$1,377	\$1,869	6.60	6.60	\$40	\$263.97	\$2,132.80
5	2020	0.1668	0.3841	1,558	2,618	\$260	\$1,006	\$1,265	1,470	\$245	1,028	\$371	3,028	3,646	505	\$1,400	\$1,905	6.60	6.60	\$50	\$329.96	\$2,235.37
6	2021	0.1621	0.3883	1,558	2,618	\$253	\$1,017	\$1,269	1,470	\$238	1,028	\$367	3,028	3,646	491	\$1,416	\$1,907	6.60	6.60	\$60	\$395.96	\$2,302.64
7	2022	0.1629	0.3929	1,558	2,618	\$254	\$1,029	\$1,282	1,470	\$240	1,028	\$367	3,028	3,646	493	\$1,432	\$1,926	6.60	6.60	\$70	\$461.95	\$2,387.77
8	2023	0.1639	0.3967	1,558	2,618	\$255	\$1,039	\$1,294	1,470	\$241	1,028	\$368	3,028	3,646	496	\$1,446	\$1,943	6.60	6.60	\$80	\$527.94	\$2,470.55
9	2024	0.1648	0.4005	1,558	2,618	\$257	\$1,049	\$1,305	1,470	\$242	1,028	\$369	3,028	3,646	499	\$1,460	\$1,959	6.60	6.60	\$90	\$593.93	\$2,553.32
10	2025	0.1656	0.4040	1,558	2,618	\$258	\$1,058	\$1,316	1,470	\$243	1,028	\$370	3,028	3,646	501	\$1,473	\$1,974	6.60	6.60	\$100	\$659.93	\$2,634.26
11	2026	0.1665	0.4070	1,558	2,618	\$259	\$1,066	\$1,325	1,470	\$245	1,028	\$371	3,028	3,646	504	\$1,484	\$1,988	6.60	6.60	\$110	\$725.92	\$2,714.25
12	2027	0.1674	0.4097	1,558	2,618	\$261	\$1,073	\$1,334	1,470	\$246	1,028	\$372	3,028	3,646	507	\$1,494	\$2,001	6.60	6.60	\$120	\$791.91	\$2,793.23
13	2028	0.1683	0.4124	1,558	2,618	\$262	\$1,080	\$1,342	1,470	\$247	1,028	\$373	3,028	3,646	509	\$1,504	\$2,013	6.60	6.60	\$130	\$857.90	\$2,870.99
14	2029	0.1692	0.4151	1,558	2,618	\$264	\$1,087	\$1,350	1,470	\$249	1,028	\$374	3,028	3,646	512	\$1,513	\$2,026	6.60	6.60	\$140	\$923.90	\$2,949.48
15	2030	0.1701	0.4170	1,558	2,618	\$265	\$1,092	\$1,357	1,470	\$250	1,028	\$375	3,028	3,646	515	\$1,520	\$2,035	6.60	6.60	\$150	\$989.89	\$3,025.28
16	2031	0.1704	0.4189	1,558	2,618	\$265	\$1,097	\$1,362	1,470	\$250	1,028	\$375	3,028	3,646	516	\$1,527	\$2,043	6.60	6.60	\$160	\$1,055.88	\$3,099.01
17	2032	0.1705	0.4204	1,558	2,618	\$266	\$1,101	\$1,366	1,470	\$251	1,028	\$375	3,028	3,646	516	\$1,533	\$2,049	6.60	6.60	\$170	\$1,121.87	\$3,171.01
18	2033	0.1707	0.4223	1,558	2,618	\$266	\$1,106	\$1,372	1,470	\$251	1,028	\$376	3,028	3,646	517	\$1,540	\$2,057	6.60	6.60	\$180	\$1,187.87	\$3,244.74
19	2034	0.1710	0.4246	1,558	2,618	\$266	\$1,112	\$1,378	1,470	\$251	1,028	\$376	3,028	3,646	518	\$1,548	\$2,066	6.60	6.60	\$190	\$1,253.86	\$3,319.98
20	2035	0.1713	0.4265	1,558	2,618	\$267	\$1,117	\$1,384	1,470	\$252	1,028	\$376	3,028	3,646	519	\$1,555	\$2,074	6.60	6.60	\$200	\$1,319.85	\$3,393.71
21	2036	0.1714	0.4288	1,558	2,618	\$267	\$1,123	\$1,390	1,470	\$252	1,028	\$376	3,028	3,646	519	\$1,564	\$2,083	6.60	6.60	\$210	\$1,385.84	\$3,468.50
22	2037	0.1717	0.4311	1,558	2,618	\$267	\$1,129	\$1,396	1,470	\$252	1,028	\$376	3,028	3,646	520	\$1,572	\$2,092	6.60	6.60	\$220	\$1,451.84	\$3,543.63
23	2038	0.1720	0.4331	1,558	2,618	\$268	\$1,134	\$1,402	1,470	\$253	1,028	\$377	3,028	3,646	521	\$1,579	\$2,100	6.60	6.60	\$230	\$1,517.83	\$3,617.47
24	2039	0.1722	0.4353	1,558	2,618	\$268	\$1,140	\$1,408	1,470	\$253	1,028	\$377	3,028	3,646	521	\$1,587	\$2,109	6.60	6.60	\$240	\$1,583.82	\$3,692.59
25	2040	0.1724	0.4376	1,558	2,618	\$269	\$1,146	\$1,414	1,470	\$253	1,028	\$377	3,028	3,646	522	\$1,596	\$2,118	6.60	6.60	\$250	\$1,649.82	\$3,767.39
26	2041	0.1734	0.4420	1,558	2,618	\$270	\$1,157	\$1,427	1,470	\$255	1,028	\$378	3,028	3,646	525	\$1,611	\$2,136	6.60	6.60	\$260	\$1,715.81	\$3,852.13
27	2042	0.1744	0.4463	1,558	2,618	\$272	\$1,168	\$1,440	1,470	\$256	1,028	\$379	3,028	3,646	528	\$1,627	\$2,155	6.60	6.60	\$270	\$1,781.80	\$3,937.05
28	2043	0.1754	0.4507	1,558	2,618	\$273	\$1,180	\$1,453	1,470	\$258	1,028	\$380	3,028	3,646	531	\$1,643	\$2,174	6.60	6.60	\$280	\$1,847.79	\$4,022.14
29	2044	0.1764	0.4552	1,558	2,618	\$275	\$1,192	\$1,466	1,470	\$259	1,028	\$381	3,028	3,646	534	\$1,660	\$2,194	6.60	6.60	\$290	\$1,913.79	\$4,107.40
30	2045	0.1774	0.4596	1,558	2,618	\$276	\$1,203	\$1,480	1,470	\$261	1,028	\$382	3,028	3,646	537	\$1,676	\$2,213	6.60	6.60	\$300	\$1,979.78	\$4,192.85
31	2046	0.1784	0.4642	1,558	2,618	\$278	\$1,215	\$1,493	1,470	\$262	1,028	\$383	3,028	3,646	540	\$1,692	\$2,233	6.60	6.60	\$310	\$2,045.77	\$4,278.47
32	2047	0.1795	0.4688	1,558	2,618	\$280	\$1,227	\$1,507	1,470	\$264	1,028	\$384	3,028	3,646	543	\$1,709	\$2,253	6.60	6.60	\$320	\$2,111.76	\$4,364.27
33	2048	0.1805	0.4734	1,558	2,618	\$281	\$1,239	\$1,521	1,470	\$265	1,028	\$386	3,028	3,646	547	\$1,726	\$2,273	6.60	6.60	\$330	\$2,177.76	\$4,450.26
34	2049	0.1816	0.4780	1,558	2,618	\$283	\$1,252	\$1,534	1,470	\$267	1,028	\$387	3,028	3,646	550	\$1,743	\$2,293	6.60	6.60	\$340	\$2,243.75	\$4,536.43
35	2050	0.1826	0.4828	1,558	2,618	\$284	\$1,264	\$1,548	1,470	\$268	1,028	\$388	3,028	3,646	553	\$1,760	\$2,313	6.60	6.60	\$350	\$2,309.74	\$4,622.79
36	2051	0.1837	0.4875	1,558	2,618	\$286	\$1,276	\$1,562	1,470	\$270	1,028	\$389	3,028	3,646	556	\$1,777	\$2,334	6.60	6.60	\$360	\$2,375.73	\$4,709.33
37	2052	0.1847	0.4923	1,558	2,618	\$288	\$1,289	\$1,577	1,470	\$272	1,028	\$390	3,028	3,646	559	\$1,795	\$2,354	6.60	6.60	\$370	\$2,441.73	\$4,796.06
38	2053	0.1858	0.4972	1,558	2,618	\$289	\$1,302	\$1,591	1,470	\$273	1,028	\$391	3,028	3,646	563	\$1,813	\$2,375	6.60	6.60	\$380	\$2,507.72	\$4,882.99
39	2054	0.1869	0.5021	1,558	2,618	\$291	\$1,314	\$1,606	1,470	\$275	1,028	\$392	3,028	3,646	566	\$1,831	\$2,396	6.60	6.60	\$390	\$2,573.71	\$4,970.11
40	2055	0.1879	0.5070	1,558	2,618	\$293	\$1,327	\$1,620	1,470	\$276	1,028	\$393	3,028	3,646	569	\$1,849	\$2,418	6.60	6.60	\$400	\$2,639.70	\$5,057.42
41	2056	0.1890	0.5120	1,558	2,618	\$295	\$1,340	\$1,635	1,470	\$278	1,028	\$394	3,028	3,646	572	\$1,867	\$2,439	6.60	6.60	\$410	\$2,705.70	\$5,144.93
42	2057	0.1901	0.5171	1,558	2,618	\$296	\$1,354	\$1,650	1,470	\$279	1,028	\$395	3,028	3,646	576	\$1,885	\$2,461	6.60	6.60	\$420	\$2,771.69	\$5,232.64
43	2058	0.1912	0.5222	1,558	2,618	\$298	\$1,367	\$1,665	1,470	\$281	1,028	\$397	3,028	3,646	579	\$1,904	\$2,483	6.60	6.60	\$430	\$2,837.68	\$5,320.55
44	2059	0.1923	0.5273	1,558	2,618	\$300	\$1,381	\$1,680	1,470	\$283	1,028	\$398	3,028	3,646	582	\$1,923	\$2,505	6.60	6.60	\$440	\$2,903.67	\$5,408.66
45	2060	0.1934	0.5325	1,558	2,618	\$301	\$1,394	\$1,696	1,470	\$284	1,028	\$399	3,028	3,646	586	\$1,942	\$2,527	6.60	6.60	\$450	\$2,969.67	\$5,496.98
46	2061	0.1946	0.5378	1,558	2,618	\$303	\$1,408	\$1,711	1,470	\$286	1,028	\$400	3,028	3,646	589	\$1,961	\$2,550	6.60	6.60	\$460	\$3,035.66	\$5,585.50
47	2062	0.1957	0.5431	1,558	2,618	\$305	\$1,422	\$1,727	1,470	\$288	1,028	\$401	3,028	3,646	593	\$1,980	\$2,573	6.60	6.60	\$470	\$3,101.65	\$5,674.23
48	2063	0.1968	0.5484	1,558	2,618	\$307	\$1,436	\$1,742	1,470	\$289	1,028	\$402	3,028	3,646	596	\$2,000	\$2,596	6.60	6.60	\$480	\$3,167.64	\$5,763.18
49	2064	0.1980	0.5538	1,558	2,618	\$308	\$1,450	\$1,758	1,470	\$291	1,028	\$404	3,028	3,646	599	\$2,019	\$2,619	6.60	6.60	\$490	\$3,233.64	\$5,852.33
50	2065	0.1991	0.5593	1,558	2,618	\$310	\$1,464	\$1,774	1,470	\$293	1,028	\$405	3,028	3,646	603	\$2,039	\$2,642	6.60	6.60	\$500	\$3,299.63	\$5,941.70
51	2066	0.2003	0.5648	1,558	2,618	\$312	\$1,479	\$1,791	1,470	\$294	1,028	\$406	3,028	3,646	606	\$2,059	\$2,666	6.60	6.60	\$510	\$3,365.62	\$6,031.28
52	2067	0.2014	0.5704	1,558	2,618	\$314	\$1,493	\$1,807	1,470	\$296	1,028	\$407	3,028	3,646	610	\$2,080	\$2,689	6.60	6.60	\$520	\$3,431.62	\$6,121.08
53	2068	0.2026	0.5760	1,558	2,618	\$316	\$1,508	\$1,824	1,470	\$298	1,028	\$408										

14. Trenton (South) – Annual Operating Costs

Vertical Ground Source Heat Pump (V.GSHP)

Base Case Scenario											Feed in Tariff (FIT)		
#	Year	Electricity Rates		V.GSHP		Hot Water		Total		Total Operating Cost	Incentives (\$/KWh)	FIT	
		\$/KWh	KWh	Heating Operating Cost	Cooling Operating Cost	Hot Water Operating Cost	Total Operating Cost	\$/KWh	Operating Cost				
1	2016	0.1501	5,462	\$820	\$46	4,380	\$657	10,146	\$1,523	0.05	0.1001	\$1,015.44	
2	2017	0.1542	5,462	\$842	\$47	4,380	\$675	10,146	\$1,564	0.05	0.1042	\$1,057.08	
3	2018	0.1583	5,462	\$865	\$48	4,380	\$693	10,146	\$1,606	0.05	0.1083	\$1,098.72	
4	2019	0.1625	5,462	\$888	\$49	4,380	\$712	10,146	\$1,649	0.05	0.1125	\$1,141.82	
5	2020	0.1668	5,462	\$911	\$51	4,380	\$731	10,146	\$1,692	0.05	0.1168	\$1,184.92	
6	2021	0.1621	5,462	\$886	\$51	4,380	\$710	10,146	\$1,645	0.05	0.1121	\$1,137.80	
7	2022	0.1629	5,462	\$890	\$50	4,380	\$714	10,146	\$1,653	0.05	0.1129	\$1,145.84	
8	2023	0.1639	5,462	\$895	\$50	4,380	\$718	10,146	\$1,663	0.05	0.1139	\$1,155.33	
9	2024	0.1648	5,462	\$900	\$50	4,380	\$722	10,146	\$1,672	0.05	0.1148	\$1,164.83	
10	2025	0.1656	5,462	\$904	\$50	4,380	\$725	10,146	\$1,680	0.05	0.1156	\$1,172.86	
11	2026	0.1665	5,462	\$910	\$51	4,380	\$729	10,146	\$1,690	0.05	0.1165	\$1,182.36	
12	2027	0.1674	5,462	\$915	\$51	4,380	\$733	10,146	\$1,699	0.05	0.1174	\$1,191.49	
13	2028	0.1683	5,462	\$919	\$51	4,380	\$737	10,146	\$1,707	0.05	0.1183	\$1,199.89	
14	2029	0.1692	5,462	\$924	\$51	4,380	\$741	10,146	\$1,716	0.05	0.1192	\$1,209.02	
15	2030	0.1701	5,462	\$929	\$52	4,380	\$745	10,146	\$1,726	0.05	0.1201	\$1,218.52	
16	2031	0.1704	5,462	\$930	\$52	4,380	\$746	10,146	\$1,728	0.05	0.1204	\$1,221.08	
17	2032	0.1705	5,462	\$931	\$52	4,380	\$747	10,146	\$1,730	0.05	0.1205	\$1,222.54	
18	2033	0.1707	5,462	\$933	\$52	4,380	\$748	10,146	\$1,732	0.05	0.1207	\$1,225.10	
19	2034	0.1710	5,462	\$934	\$52	4,380	\$749	10,146	\$1,735	0.05	0.1210	\$1,228.02	
20	2035	0.1713	5,462	\$936	\$52	4,380	\$750	10,146	\$1,738	0.05	0.1213	\$1,230.57	
21	2036	0.1714	5,462	\$936	\$52	4,380	\$751	10,146	\$1,739	0.05	0.1214	\$1,232.04	
22	2037	0.1717	5,462	\$938	\$52	4,380	\$752	10,146	\$1,742	0.05	0.1217	\$1,234.59	
23	2038	0.1720	5,462	\$939	\$52	4,380	\$753	10,146	\$1,745	0.05	0.1220	\$1,237.51	
24	2039	0.1722	5,462	\$941	\$52	4,380	\$754	10,146	\$1,747	0.05	0.1222	\$1,240.07	
25	2040	0.1724	5,462	\$941	\$52	4,380	\$755	10,146	\$1,749	0.05	0.1224	\$1,241.53	
26	2041	0.1734	5,462	\$947	\$53	4,380	\$759	10,146	\$1,759	0.05	0.1234	\$1,251.65	
27	2042	0.1744	5,462	\$952	\$53	4,380	\$764	10,146	\$1,769	0.05	0.1244	\$1,261.82	
28	2043	0.1754	5,462	\$958	\$53	4,380	\$768	10,146	\$1,779	0.05	0.1254	\$1,272.06	
29	2044	0.1764	5,462	\$963	\$54	4,380	\$773	10,146	\$1,790	0.05	0.1264	\$1,282.35	
30	2045	0.1774	5,462	\$969	\$54	4,380	\$777	10,146	\$1,800	0.05	0.1274	\$1,292.70	
31	2046	0.1784	5,462	\$975	\$54	4,380	\$782	10,146	\$1,810	0.05	0.1284	\$1,303.12	
32	2047	0.1795	5,462	\$980	\$55	4,380	\$786	10,146	\$1,821	0.05	0.1295	\$1,313.59	
33	2048	0.1805	5,462	\$986	\$55	4,380	\$791	10,146	\$1,831	0.05	0.1305	\$1,324.12	
34	2049	0.1816	5,462	\$992	\$55	4,380	\$795	10,146	\$1,842	0.05	0.1316	\$1,334.72	
35	2050	0.1826	5,462	\$997	\$56	4,380	\$800	10,146	\$1,853	0.05	0.1326	\$1,345.37	
36	2051	0.1837	5,462	\$1,003	\$56	4,380	\$804	10,146	\$1,863	0.05	0.1337	\$1,356.09	
37	2052	0.1847	5,462	\$1,009	\$56	4,380	\$809	10,146	\$1,874	0.05	0.1347	\$1,366.87	
38	2053	0.1858	5,462	\$1,015	\$56	4,380	\$814	10,146	\$1,885	0.05	0.1358	\$1,377.71	
39	2054	0.1869	5,462	\$1,021	\$57	4,380	\$818	10,146	\$1,896	0.05	0.1369	\$1,388.62	
40	2055	0.1879	5,462	\$1,027	\$57	4,380	\$823	10,146	\$1,907	0.05	0.1379	\$1,399.58	
41	2056	0.1890	5,462	\$1,032	\$57	4,380	\$828	10,146	\$1,918	0.05	0.1390	\$1,410.62	
42	2057	0.1901	5,462	\$1,038	\$58	4,380	\$833	10,146	\$1,929	0.05	0.1401	\$1,421.71	
43	2058	0.1912	5,462	\$1,044	\$58	4,380	\$838	10,146	\$1,940	0.05	0.1412	\$1,432.87	
44	2059	0.1923	5,462	\$1,051	\$58	4,380	\$842	10,146	\$1,951	0.05	0.1423	\$1,444.09	
45	2060	0.1934	5,462	\$1,057	\$59	4,380	\$847	10,146	\$1,963	0.05	0.1434	\$1,455.38	
46	2061	0.1946	5,462	\$1,063	\$59	4,380	\$852	10,146	\$1,974	0.05	0.1446	\$1,466.74	
47	2062	0.1957	5,462	\$1,069	\$59	4,380	\$857	10,146	\$1,985	0.05	0.1457	\$1,478.16	
48	2063	0.1968	5,462	\$1,075	\$60	4,380	\$862	10,146	\$1,997	0.05	0.1468	\$1,489.64	
49	2064	0.1980	5,462	\$1,081	\$60	4,380	\$867	10,146	\$2,008	0.05	0.1480	\$1,501.19	
50	2065	0.1991	5,462	\$1,088	\$61	4,380	\$872	10,146	\$2,020	0.05	0.1491	\$1,512.81	
51	2066	0.2003	5,462	\$1,094	\$61	4,380	\$877	10,146	\$2,032	0.05	0.1503	\$1,524.50	
52	2067	0.2014	5,462	\$1,100	\$61	4,380	\$882	10,146	\$2,044	0.05	0.1514	\$1,536.25	
53	2068	0.2026	5,462	\$1,106	\$62	4,380	\$887	10,146	\$2,055	0.05	0.1526	\$1,548.07	
54	2069	0.2038	5,462	\$1,113	\$62	4,380	\$892	10,146	\$2,067	0.05	0.1538	\$1,559.96	
55	2070	0.2049	5,462	\$1,119	\$62	4,380	\$898	10,146	\$2,079	0.05	0.1549	\$1,571.92	
56	2071	0.2061	5,462	\$1,126	\$63	4,380	\$903	10,146	\$2,091	0.05	0.1561	\$1,583.95	
57	2072	0.2073	5,462	\$1,132	\$63	4,380	\$908	10,146	\$2,103	0.05	0.1573	\$1,596.05	
58	2073	0.2085	5,462	\$1,139	\$63	4,380	\$913	10,146	\$2,116	0.05	0.1585	\$1,608.22	
59	2074	0.2097	5,462	\$1,145	\$64	4,380	\$919	10,146	\$2,128	0.05	0.1597	\$1,620.45	
60	2075	0.2109	5,462	\$1,152	\$64	4,380	\$924	10,146	\$2,140	0.05	0.1609	\$1,632.76	

Table D1-1.40: Annual Operating Costs (V.GSHP) of a 2,000 square feet detached house above grade (average construction type) in the city of Trenton (two life cycles and three life cycles for a 60 year project lifespan); base case scenario in comparison with feed in-tariff (FIT) scenario. In the FIT scenario, an incentive of \$0.05/KWh is provided on electricity bills throughout the project lifespan

Horizontal Ground Source Heat Pump (H.GSHP)

Base Case Scenario											Feed in Tariff (FIT)		
#	Year	H.GSHP									FIT		
		Electricity Rates \$/KWh	Heating KWh	Heating Operating Cost \$	Cooling KWh	Cooling Operating Cost \$	Hot Water KWh	Hot Water Operating Cost \$	Total KWh	Total Operating Cost \$	Incentives (\$/KWh)	S/KWh	Operating Cost
1	2016	0.1501	5,533	\$830	311	\$47	4,360	\$654	10,204	\$1,531	0.05	0.1001	\$1,021.24
2	2017	0.1542	5,533	\$853	311	\$48	4,360	\$672	10,204	\$1,573	0.05	0.1042	\$1,063.12
3	2018	0.1583	5,533	\$876	311	\$49	4,360	\$690	10,204	\$1,615	0.05	0.1083	\$1,105.00
4	2019	0.1625	5,533	\$899	311	\$51	4,360	\$707	10,204	\$1,659	0.05	0.1125	\$1,148.34
5	2020	0.1668	5,533	\$923	311	\$52	4,360	\$727	10,204	\$1,702	0.05	0.1168	\$1,191.69
6	2021	0.1621	5,533	\$897	311	\$50	4,360	\$707	10,204	\$1,655	0.05	0.1121	\$1,144.30
7	2022	0.1629	5,533	\$907	311	\$51	4,360	\$710	10,204	\$1,663	0.05	0.1129	\$1,152.39
8	2023	0.1639	5,533	\$912	311	\$51	4,360	\$714	10,204	\$1,672	0.05	0.1139	\$1,161.94
9	2024	0.1648	5,533	\$916	311	\$51	4,360	\$719	10,204	\$1,682	0.05	0.1148	\$1,171.49
10	2025	0.1656	5,533	\$916	311	\$52	4,360	\$722	10,204	\$1,690	0.05	0.1156	\$1,179.57
11	2026	0.1665	5,533	\$921	311	\$52	4,360	\$726	10,204	\$1,699	0.05	0.1165	\$1,189.12
12	2027	0.1674	5,533	\$926	311	\$52	4,360	\$730	10,204	\$1,709	0.05	0.1174	\$1,198.30
13	2028	0.1683	5,533	\$931	311	\$52	4,360	\$734	10,204	\$1,717	0.05	0.1183	\$1,206.75
14	2029	0.1692	5,533	\$936	311	\$53	4,360	\$738	10,204	\$1,726	0.05	0.1192	\$1,215.94
15	2030	0.1701	5,533	\$941	311	\$53	4,360	\$742	10,204	\$1,736	0.05	0.1201	\$1,225.49
16	2031	0.1704	5,533	\$943	311	\$53	4,360	\$743	10,204	\$1,738	0.05	0.1204	\$1,228.06
17	2032	0.1705	5,533	\$943	311	\$53	4,360	\$743	10,204	\$1,740	0.05	0.1205	\$1,229.53
18	2033	0.1707	5,533	\$945	311	\$53	4,360	\$744	10,204	\$1,742	0.05	0.1207	\$1,232.10
19	2034	0.1710	5,533	\$946	311	\$53	4,360	\$746	10,204	\$1,745	0.05	0.1210	\$1,235.04
20	2035	0.1713	5,533	\$948	311	\$53	4,360	\$747	10,204	\$1,748	0.05	0.1213	\$1,237.61
21	2036	0.1714	5,533	\$949	311	\$53	4,360	\$747	10,204	\$1,749	0.05	0.1214	\$1,239.08
22	2037	0.1717	5,533	\$950	311	\$53	4,360	\$749	10,204	\$1,752	0.05	0.1217	\$1,241.65
23	2038	0.1720	5,533	\$952	311	\$53	4,360	\$750	10,204	\$1,755	0.05	0.1220	\$1,244.59
24	2039	0.1722	5,533	\$953	311	\$54	4,360	\$751	10,204	\$1,757	0.05	0.1222	\$1,247.16
25	2040	0.1724	5,533	\$954	311	\$54	4,360	\$752	10,204	\$1,759	0.05	0.1224	\$1,248.63
26	2041	0.1734	5,533	\$959	311	\$54	4,360	\$756	10,204	\$1,769	0.05	0.1234	\$1,258.80
27	2042	0.1744	5,533	\$965	311	\$54	4,360	\$760	10,204	\$1,779	0.05	0.1244	\$1,269.04
28	2043	0.1754	5,533	\$970	311	\$55	4,360	\$765	10,204	\$1,790	0.05	0.1254	\$1,279.33
29	2044	0.1764	5,533	\$976	311	\$55	4,360	\$769	10,204	\$1,800	0.05	0.1264	\$1,289.68
30	2045	0.1774	5,533	\$982	311	\$55	4,360	\$774	10,204	\$1,810	0.05	0.1274	\$1,300.09
31	2046	0.1784	5,533	\$987	311	\$55	4,360	\$778	10,204	\$1,821	0.05	0.1284	\$1,310.57
32	2047	0.1795	5,533	\$993	311	\$56	4,360	\$782	10,204	\$1,831	0.05	0.1295	\$1,321.10
33	2048	0.1805	5,533	\$999	311	\$56	4,360	\$787	10,204	\$1,842	0.05	0.1305	\$1,331.69
34	2049	0.1816	5,533	\$1,005	311	\$56	4,360	\$792	10,204	\$1,853	0.05	0.1316	\$1,342.35
35	2050	0.1826	5,533	\$1,010	311	\$57	4,360	\$796	10,204	\$1,863	0.05	0.1326	\$1,353.06
36	2051	0.1837	5,533	\$1,016	311	\$57	4,360	\$801	10,204	\$1,874	0.05	0.1337	\$1,363.84
37	2052	0.1847	5,533	\$1,022	311	\$57	4,360	\$805	10,204	\$1,885	0.05	0.1347	\$1,374.68
38	2053	0.1858	5,533	\$1,028	311	\$58	4,360	\$810	10,204	\$1,896	0.05	0.1358	\$1,385.59
39	2054	0.1869	5,533	\$1,034	311	\$58	4,360	\$815	10,204	\$1,907	0.05	0.1369	\$1,396.56
40	2055	0.1879	5,533	\$1,040	311	\$58	4,360	\$819	10,204	\$1,918	0.05	0.1379	\$1,407.59
41	2056	0.1890	5,533	\$1,046	311	\$59	4,360	\$824	10,204	\$1,929	0.05	0.1390	\$1,418.68
42	2057	0.1901	5,533	\$1,052	311	\$59	4,360	\$829	10,204	\$1,940	0.05	0.1401	\$1,429.84
43	2058	0.1912	5,533	\$1,058	311	\$59	4,360	\$834	10,204	\$1,951	0.05	0.1412	\$1,441.06
44	2059	0.1923	5,533	\$1,064	311	\$60	4,360	\$839	10,204	\$1,963	0.05	0.1423	\$1,452.35
45	2060	0.1934	5,533	\$1,070	311	\$60	4,360	\$843	10,204	\$1,974	0.05	0.1434	\$1,463.70
46	2061	0.1946	5,533	\$1,077	311	\$61	4,360	\$848	10,204	\$1,985	0.05	0.1446	\$1,475.12
47	2062	0.1957	5,533	\$1,083	311	\$61	4,360	\$853	10,204	\$1,997	0.05	0.1457	\$1,486.61
48	2063	0.1968	5,533	\$1,089	311	\$61	4,360	\$858	10,204	\$2,008	0.05	0.1468	\$1,498.16
49	2064	0.1980	5,533	\$1,095	311	\$62	4,360	\$863	10,204	\$2,020	0.05	0.1480	\$1,509.77
50	2065	0.1991	5,533	\$1,102	311	\$62	4,360	\$868	10,204	\$2,032	0.05	0.1491	\$1,521.46
51	2066	0.2003	5,533	\$1,108	311	\$62	4,360	\$873	10,204	\$2,043	0.05	0.1503	\$1,533.21
52	2067	0.2014	5,533	\$1,114	311	\$63	4,360	\$878	10,204	\$2,055	0.05	0.1514	\$1,545.03
53	2068	0.2026	5,533	\$1,121	311	\$63	4,360	\$883	10,204	\$2,067	0.05	0.1526	\$1,556.92
54	2069	0.2038	5,533	\$1,127	311	\$63	4,360	\$888	10,204	\$2,079	0.05	0.1538	\$1,568.88
55	2070	0.2049	5,533	\$1,134	311	\$64	4,360	\$893	10,204	\$2,091	0.05	0.1549	\$1,580.91
56	2071	0.2061	5,533	\$1,140	311	\$64	4,360	\$899	10,204	\$2,103	0.05	0.1561	\$1,593.00
57	2072	0.2073	5,533	\$1,147	311	\$64	4,360	\$904	10,204	\$2,115	0.05	0.1573	\$1,605.17
58	2073	0.2085	5,533	\$1,154	311	\$65	4,360	\$909	10,204	\$2,128	0.05	0.1585	\$1,617.41
59	2074	0.2097	5,533	\$1,160	311	\$65	4,360	\$914	10,204	\$2,140	0.05	0.1597	\$1,629.72
60	2075	0.2109	5,533	\$1,167	311	\$66	4,360	\$920	10,204	\$2,152	0.05	0.1609	\$1,642.10

Table D1-1.41: Annual Operating Costs (H.GSHP) of a 2,000 square feet detached house above grade (average construction type) in the city of Trenton (two life cycles and three life cycles for a 60 year project lifespan); base case scenario in comparison with feed in-tariff (FIT) scenario. In the FIT scenario, an incentive of \$0.05/KWh is provided on electricity bills throughout the project lifespan

Traditional HVAC Applications

Base Case Scenario															Carbon Taxes							
#	Year	Electricity Rates \$/KWh	Natural Gas Rates \$/m ³	Traditional											Total	Conversion of m ³ into Tons	Total Tons	Carbon Tax	Operating Costs			
				Heating		Heating Operating Cost \$ (Electricity)	Heating Operating Cost \$ (Gas)	Total Heating Operating Cost \$	Cooling		Hot Water m ³	Hot Water Operating Cost \$	Total KWh	Total m ³						Total Electricity Operating Cost \$ (KWh)	Total Natural Gas Operating Cost \$ (m ³)	
				Electricity KWh (Electricity)	Natural Gas m ³ (Gas)				Electricity KWh	Natural Gas \$												
1	2016	0.1501	0.3458	1,779	2,638	\$267	\$912	\$1,179	1,511	\$227	1,033	\$357	3,290	3,671	494	\$1,270	\$1,763	6.64	6.64	\$10	\$66.45	\$1,829.76
2	2017	0.1542	0.3588	1,779	2,638	\$274	\$947	\$1,221	1,511	\$233	1,033	\$159	3,290	3,671	507	\$1,317	\$1,825	6.64	6.64	\$20	\$132.89	\$1,957.46
3	2018	0.1583	0.3718	1,779	2,638	\$282	\$981	\$1,263	1,511	\$239	1,033	\$164	3,290	3,671	521	\$1,365	\$1,886	6.64	6.64	\$30	\$199.34	\$2,085.15
4	2019	0.1625	0.3776	1,779	2,638	\$289	\$996	\$1,285	1,511	\$246	1,033	\$168	3,290	3,671	535	\$1,386	\$1,921	6.64	6.64	\$40	\$265.78	\$2,186.64
5	2020	0.1668	0.3841	1,779	2,638	\$297	\$1,013	\$1,310	1,511	\$252	1,033	\$172	3,290	3,671	549	\$1,410	\$1,959	6.64	6.64	\$50	\$332.23	\$2,290.93
6	2021	0.1621	0.3883	1,779	2,638	\$288	\$1,024	\$1,313	1,511	\$245	1,033	\$167	3,290	3,671	533	\$1,425	\$1,959	6.64	6.64	\$60	\$398.67	\$2,357.55
7	2022	0.1629	0.3929	1,779	2,638	\$290	\$1,036	\$1,326	1,511	\$246	1,033	\$168	3,290	3,671	536	\$1,442	\$1,978	6.64	6.64	\$70	\$465.12	\$2,443.45
8	2023	0.1639	0.3967	1,779	2,638	\$292	\$1,047	\$1,338	1,511	\$248	1,033	\$169	3,290	3,671	539	\$1,456	\$1,995	6.64	6.64	\$80	\$531.56	\$2,527.02
9	2024	0.1648	0.4005	1,779	2,638	\$293	\$1,057	\$1,350	1,511	\$249	1,033	\$170	3,290	3,671	542	\$1,470	\$2,013	6.64	6.64	\$90	\$598.01	\$2,610.59
10	2025	0.1656	0.4040	1,779	2,638	\$295	\$1,066	\$1,360	1,511	\$250	1,033	\$171	3,290	3,671	545	\$1,483	\$2,028	6.64	6.64	\$100	\$664.45	\$2,692.28
11	2026	0.1665	0.4070	1,779	2,638	\$296	\$1,074	\$1,370	1,511	\$252	1,033	\$172	3,290	3,671	548	\$1,494	\$2,042	6.64	6.64	\$110	\$730.90	\$2,773.04
12	2027	0.1674	0.4097	1,779	2,638	\$298	\$1,081	\$1,379	1,511	\$253	1,033	\$173	3,290	3,671	551	\$1,504	\$2,055	6.64	6.64	\$120	\$797.34	\$2,852.27
13	2028	0.1683	0.4124	1,779	2,638	\$299	\$1,088	\$1,387	1,511	\$254	1,033	\$174	3,290	3,671	554	\$1,514	\$2,067	6.64	6.64	\$130	\$863.79	\$2,931.27
14	2029	0.1692	0.4151	1,779	2,638	\$301	\$1,095	\$1,396	1,511	\$256	1,033	\$175	3,290	3,671	557	\$1,524	\$2,080	6.64	6.64	\$140	\$930.23	\$3,010.51
15	2030	0.1701	0.4170	1,779	2,638	\$303	\$1,100	\$1,403	1,511	\$257	1,033	\$176	3,290	3,671	560	\$1,531	\$2,090	6.64	6.64	\$150	\$996.68	\$3,087.05
16	2031	0.1704	0.4189	1,779	2,638	\$303	\$1,105	\$1,408	1,511	\$257	1,033	\$176	3,290	3,671	560	\$1,538	\$2,098	6.64	6.64	\$160	\$1,063.12	\$3,161.35
17	2032	0.1705	0.4204	1,779	2,638	\$303	\$1,109	\$1,412	1,511	\$258	1,033	\$176	3,290	3,671	561	\$1,543	\$2,104	6.64	6.64	\$170	\$1,129.57	\$3,233.89
18	2033	0.1707	0.4223	1,779	2,638	\$304	\$1,114	\$1,418	1,511	\$258	1,033	\$176	3,290	3,671	562	\$1,550	\$2,112	6.64	6.64	\$180	\$1,196.01	\$3,308.18
19	2034	0.1710	0.4246	1,779	2,638	\$304	\$1,120	\$1,424	1,511	\$258	1,033	\$177	3,290	3,671	563	\$1,559	\$2,122	6.64	6.64	\$190	\$1,262.46	\$3,384.00
20	2035	0.1713	0.4265	1,779	2,638	\$305	\$1,125	\$1,430	1,511	\$259	1,033	\$177	3,290	3,671	564	\$1,566	\$2,129	6.64	6.64	\$200	\$1,328.90	\$3,458.30
21	2036	0.1714	0.4288	1,779	2,638	\$305	\$1,131	\$1,436	1,511	\$259	1,033	\$177	3,290	3,671	564	\$1,574	\$2,138	6.64	6.64	\$210	\$1,395.35	\$3,533.64
22	2037	0.1717	0.4311	1,779	2,638	\$305	\$1,137	\$1,443	1,511	\$259	1,033	\$177	3,290	3,671	565	\$1,583	\$2,148	6.64	6.64	\$220	\$1,461.79	\$3,609.34
23	2038	0.1720	0.4331	1,779	2,638	\$306	\$1,142	\$1,448	1,511	\$260	1,033	\$178	3,290	3,671	566	\$1,590	\$2,156	6.64	6.64	\$230	\$1,528.24	\$3,683.76
24	2039	0.1722	0.4353	1,779	2,638	\$306	\$1,148	\$1,455	1,511	\$260	1,033	\$178	3,290	3,671	567	\$1,598	\$2,165	6.64	6.64	\$240	\$1,594.68	\$3,759.46
25	2040	0.1724	0.4376	1,779	2,638	\$307	\$1,155	\$1,461	1,511	\$260	1,033	\$178	3,290	3,671	567	\$1,607	\$2,174	6.64	6.64	\$250	\$1,661.13	\$3,834.80
26	2041	0.1734	0.4420	1,779	2,638	\$308	\$1,166	\$1,474	1,511	\$262	1,033	\$179	3,290	3,671	570	\$1,622	\$2,193	6.64	6.64	\$260	\$1,727.57	\$3,920.37
27	2042	0.1744	0.4463	1,779	2,638	\$310	\$1,177	\$1,488	1,511	\$263	1,033	\$180	3,290	3,671	574	\$1,638	\$2,212	6.64	6.64	\$270	\$1,794.02	\$4,006.11
28	2043	0.1754	0.4507	1,779	2,638	\$312	\$1,189	\$1,501	1,511	\$265	1,033	\$181	3,290	3,671	577	\$1,655	\$2,232	6.64	6.64	\$280	\$1,860.46	\$4,092.02
29	2044	0.1764	0.4552	1,779	2,638	\$314	\$1,201	\$1,515	1,511	\$267	1,033	\$182	3,290	3,671	580	\$1,671	\$2,251	6.64	6.64	\$290	\$1,926.91	\$4,178.12
30	2045	0.1774	0.4596	1,779	2,638	\$316	\$1,213	\$1,528	1,511	\$268	1,033	\$183	3,290	3,671	584	\$1,687	\$2,271	6.64	6.64	\$300	\$1,993.35	\$4,264.40
31	2046	0.1784	0.4642	1,779	2,638	\$317	\$1,225	\$1,542	1,511	\$270	1,033	\$184	3,290	3,671	587	\$1,704	\$2,291	6.64	6.64	\$310	\$2,059.80	\$4,350.85
32	2047	0.1795	0.4688	1,779	2,638	\$319	\$1,237	\$1,556	1,511	\$271	1,033	\$185	3,290	3,671	590	\$1,721	\$2,311	6.64	6.64	\$320	\$2,126.24	\$4,437.49
33	2048	0.1805	0.4734	1,779	2,638	\$321	\$1,249	\$1,570	1,511	\$273	1,033	\$186	3,290	3,671	594	\$1,738	\$2,332	6.64	6.64	\$330	\$2,192.69	\$4,524.32
34	2049	0.1816	0.4780	1,779	2,638	\$323	\$1,261	\$1,584	1,511	\$274	1,033	\$188	3,290	3,671	597	\$1,755	\$2,352	6.64	6.64	\$340	\$2,259.13	\$4,611.33
35	2050	0.1826	0.4828	1,779	2,638	\$325	\$1,274	\$1,598	1,511	\$276	1,033	\$189	3,290	3,671	601	\$1,772	\$2,373	6.64	6.64	\$350	\$2,325.58	\$4,698.53
36	2051	0.1837	0.4875	1,779	2,638	\$327	\$1,286	\$1,613	1,511	\$278	1,033	\$190	3,290	3,671	604	\$1,790	\$2,394	6.64	6.64	\$360	\$2,392.02	\$4,785.93
37	2052	0.1847	0.4923	1,779	2,638	\$329	\$1,299	\$1,627	1,511	\$279	1,033	\$191	3,290	3,671	608	\$1,807	\$2,415	6.64	6.64	\$370	\$2,458.47	\$4,873.51
38	2053	0.1858	0.4972	1,779	2,638	\$331	\$1,312	\$1,642	1,511	\$281	1,033	\$192	3,290	3,671	611	\$1,825	\$2,436	6.64	6.64	\$380	\$2,524.91	\$4,961.29
39	2054	0.1869	0.5021	1,779	2,638	\$332	\$1,324	\$1,657	1,511	\$282	1,033	\$193	3,290	3,671	615	\$1,843	\$2,458	6.64	6.64	\$390	\$2,591.36	\$5,049.27
40	2055	0.1879	0.5070	1,779	2,638	\$334	\$1,338	\$1,672	1,511	\$284	1,033	\$194	3,290	3,671	618	\$1,861	\$2,480	6.64	6.64	\$400	\$2,657.80	\$5,137.44
41	2056	0.1890	0.5120	1,779	2,638	\$336	\$1,351	\$1,687	1,511	\$286	1,033	\$195	3,290	3,671	622	\$1,880	\$2,502	6.64	6.64	\$410	\$2,724.25	\$5,225.81
42	2057	0.1901	0.5171	1,779	2,638	\$338	\$1,364	\$1,702	1,511	\$287	1,033	\$196	3,290	3,671	626	\$1,898	\$2,524	6.64	6.64	\$420	\$2,790.69	\$5,314.39
43	2058	0.1912	0.5222	1,779	2,638	\$340	\$1,377	\$1,718	1,511	\$289	1,033	\$198	3,290	3,671	629	\$1,917	\$2,546	6.64	6.64	\$430	\$2,857.14	\$5,403.16
44	2059	0.1923	0.5273	1,779	2,638	\$342	\$1,391	\$1,733	1,511	\$291	1,033	\$199	3,290	3,671	633	\$1,936	\$2,569	6.64	6.64	\$440	\$2,923.58	\$5,492.15
45	2060	0.1934	0.5325	1,779	2,638	\$344	\$1,405	\$1,749	1,511	\$292	1,033	\$200	3,290	3,671	636	\$1,955	\$2,591	6.64	6.64	\$450	\$2,990.03	\$5,581.34
46	2061	0.1946	0.5378	1,779	2,638	\$346	\$1,419	\$1,765	1,511	\$294	1,033	\$201	3,290	3,671	640	\$1,974	\$2,614	6.64	6.64	\$460	\$3,056.47	\$5,670.74
47	2062	0.1957	0.5431	1,779	2,638	\$348	\$1,433	\$1,781	1,511	\$296	1,033	\$202	3,290	3,671	644	\$1,994	\$2,637	6.64	6.64	\$470	\$3,122.92	\$5,760.35
48	2063	0.1968	0.5484	1,779	2,638	\$350	\$1,447	\$1,797	1,511	\$297	1,033	\$203	3,290	3,671	648	\$2,013	\$2,661	6.64	6.64	\$480	\$3,189.36	\$5,850.17
49	2064	0.1980	0.5538	1,779	2,638	\$352	\$1,461	\$1,813	1,511	\$299	1,033	\$204	3,290	3,671	651	\$2,033	\$2,684	6.64	6.64	\$490	\$3,255.81	\$5,940.21
50	2065	0.1991	0.5593	1,779	2,638	\$354	\$1,475	\$1,830	1,511	\$301	1,033	\$206	3,290	3,671	655	\$2,053	\$2,708	6.64	6.64	\$500	\$3,322.26	\$6,030.47
51	2066	0.2003	0.5648	1,779	2,638	\$356	\$1,490	\$1,846	1,511	\$303	1,033	\$207	3,290	3,671	659	\$2,073	\$2,732	6.64	6.64	\$510	\$3,388.70	\$6,120.95
52	2067	0.2014	0.5704	1,779	2,638	\$358	\$1,505	\$1,863	1,511	\$304	1,033	\$208	3,290	3,671	663	\$2,094	\$2,756	6.64	6.64	\$520	\$3,455.15	\$6,211.64
53	2068	0.2026	0.5760	1,779	2,638	\$360	\$1,519	\$1,880	1,511	\$306	1,033											

15. Wiarton (South) – Annual Operating Costs

Vertical Ground Source Heat Pump (V.GSHP)

Base Case Scenario											Feed in Tariff (FIT)		
#	Year	V.GSHP		V.GSHP		Hot Water	Hot Water Operating Cost	Total	Total Operating Cost	FIT			
		Electricity Rates \$/KWh	Heating KWh	Heating Operating Cost \$	Cooling KWh					Cooling Operating Cost \$	Incentives (\$/KWh)	\$/KWh	Operating Cost
1	2016	0.1501	6,040	\$907	236	4,063	\$610	10,339	\$1,552	0.05	0.1001	\$1,034.76	
2	2017	0.1542	6,040	\$931	236	4,063	\$626	10,339	\$1,594	0.05	0.1042	\$1,077.19	
3	2018	0.1583	6,040	\$956	236	4,063	\$643	10,339	\$1,637	0.05	0.1083	\$1,119.62	
4	2019	0.1625	6,040	\$982	236	4,063	\$660	10,339	\$1,680	0.05	0.1125	\$1,163.54	
5	2020	0.1668	6,040	\$1,007	236	4,063	\$678	10,339	\$1,724	0.05	0.1168	\$1,207.46	
6	2021	0.1621	6,040	\$979	236	4,063	\$659	10,339	\$1,676	0.05	0.1121	\$1,159.44	
7	2022	0.1629	6,040	\$984	236	4,063	\$662	10,339	\$1,685	0.05	0.1129	\$1,167.63	
8	2023	0.1639	6,040	\$990	236	4,063	\$666	10,339	\$1,694	0.05	0.1139	\$1,177.31	
9	2024	0.1648	6,040	\$995	236	4,063	\$670	10,339	\$1,704	0.05	0.1148	\$1,186.99	
10	2025	0.1656	6,040	\$1,000	236	4,063	\$673	10,339	\$1,712	0.05	0.1156	\$1,195.17	
11	2026	0.1665	6,040	\$1,006	236	4,063	\$677	10,339	\$1,722	0.05	0.1165	\$1,204.85	
12	2027	0.1674	6,040	\$1,011	236	4,063	\$680	10,339	\$1,731	0.05	0.1174	\$1,214.16	
13	2028	0.1683	6,040	\$1,016	236	4,063	\$684	10,339	\$1,740	0.05	0.1183	\$1,223.72	
14	2029	0.1692	6,040	\$1,022	236	4,063	\$687	10,339	\$1,749	0.05	0.1192	\$1,232.02	
15	2030	0.1701	6,040	\$1,027	236	4,063	\$691	10,339	\$1,759	0.05	0.1201	\$1,241.70	
16	2031	0.1704	6,040	\$1,029	236	4,063	\$692	10,339	\$1,761	0.05	0.1204	\$1,244.31	
17	2032	0.1705	6,040	\$1,030	236	4,063	\$693	10,339	\$1,763	0.05	0.1205	\$1,245.79	
18	2033	0.1707	6,040	\$1,031	236	4,063	\$694	10,339	\$1,765	0.05	0.1207	\$1,248.40	
19	2034	0.1710	6,040	\$1,033	236	4,063	\$695	10,339	\$1,768	0.05	0.1210	\$1,251.38	
20	2035	0.1713	6,040	\$1,035	236	4,063	\$696	10,339	\$1,771	0.05	0.1213	\$1,253.98	
21	2036	0.1714	6,040	\$1,035	236	4,063	\$697	10,339	\$1,772	0.05	0.1214	\$1,255.47	
22	2037	0.1717	6,040	\$1,037	236	4,063	\$698	10,339	\$1,775	0.05	0.1217	\$1,258.08	
23	2038	0.1720	6,040	\$1,039	236	4,063	\$699	10,339	\$1,778	0.05	0.1220	\$1,261.05	
24	2039	0.1722	6,040	\$1,040	236	4,063	\$700	10,339	\$1,781	0.05	0.1222	\$1,263.66	
25	2040	0.1724	6,040	\$1,041	236	4,063	\$701	10,339	\$1,782	0.05	0.1224	\$1,265.15	
26	2041	0.1734	6,040	\$1,047	236	4,063	\$704	10,339	\$1,792	0.05	0.1234	\$1,275.46	
27	2042	0.1744	6,040	\$1,053	236	4,063	\$708	10,339	\$1,803	0.05	0.1244	\$1,285.83	
28	2043	0.1754	6,040	\$1,059	236	4,063	\$713	10,339	\$1,813	0.05	0.1254	\$1,296.26	
29	2044	0.1764	6,040	\$1,065	236	4,063	\$717	10,339	\$1,824	0.05	0.1264	\$1,306.74	
30	2045	0.1774	6,040	\$1,072	236	4,063	\$721	10,339	\$1,834	0.05	0.1274	\$1,317.29	
31	2046	0.1784	6,040	\$1,078	236	4,063	\$725	10,339	\$1,845	0.05	0.1284	\$1,327.91	
32	2047	0.1795	6,040	\$1,084	236	4,063	\$729	10,339	\$1,856	0.05	0.1295	\$1,338.58	
33	2048	0.1805	6,040	\$1,090	236	4,063	\$733	10,339	\$1,866	0.05	0.1305	\$1,349.31	
34	2049	0.1816	6,040	\$1,097	236	4,063	\$738	10,339	\$1,877	0.05	0.1316	\$1,360.11	
35	2050	0.1826	6,040	\$1,103	236	4,063	\$742	10,339	\$1,888	0.05	0.1326	\$1,370.97	
36	2051	0.1837	6,040	\$1,109	236	4,063	\$746	10,339	\$1,899	0.05	0.1337	\$1,381.89	
37	2052	0.1847	6,040	\$1,116	236	4,063	\$751	10,339	\$1,910	0.05	0.1347	\$1,392.87	
38	2053	0.1858	6,040	\$1,122	236	4,063	\$755	10,339	\$1,921	0.05	0.1358	\$1,403.92	
39	2054	0.1869	6,040	\$1,129	236	4,063	\$759	10,339	\$1,932	0.05	0.1369	\$1,415.03	
40	2055	0.1879	6,040	\$1,135	236	4,063	\$764	10,339	\$1,943	0.05	0.1379	\$1,426.21	
41	2056	0.1890	6,040	\$1,142	236	4,063	\$768	10,339	\$1,954	0.05	0.1390	\$1,437.45	
42	2057	0.1901	6,040	\$1,148	236	4,063	\$772	10,339	\$1,966	0.05	0.1401	\$1,448.75	
43	2058	0.1912	6,040	\$1,155	236	4,063	\$777	10,339	\$1,977	0.05	0.1412	\$1,460.13	
44	2059	0.1923	6,040	\$1,162	236	4,063	\$781	10,339	\$1,989	0.05	0.1423	\$1,471.56	
45	2060	0.1934	6,040	\$1,168	236	4,063	\$786	10,339	\$2,000	0.05	0.1434	\$1,483.07	
46	2061	0.1946	6,040	\$1,175	236	4,063	\$791	10,339	\$2,012	0.05	0.1446	\$1,494.64	
47	2062	0.1957	6,040	\$1,182	236	4,063	\$795	10,339	\$2,023	0.05	0.1457	\$1,506.27	
48	2063	0.1968	6,040	\$1,189	236	4,063	\$800	10,339	\$2,035	0.05	0.1468	\$1,517.98	
49	2064	0.1980	6,040	\$1,196	236	4,063	\$804	10,339	\$2,047	0.05	0.1480	\$1,529.75	
50	2065	0.1991	6,040	\$1,203	236	4,063	\$809	10,339	\$2,059	0.05	0.1491	\$1,541.59	
51	2066	0.2003	6,040	\$1,210	236	4,063	\$814	10,339	\$2,070	0.05	0.1503	\$1,553.50	
52	2067	0.2014	6,040	\$1,217	236	4,063	\$818	10,339	\$2,082	0.05	0.1514	\$1,565.47	
53	2068	0.2026	6,040	\$1,224	236	4,063	\$823	10,339	\$2,094	0.05	0.1526	\$1,577.52	
54	2069	0.2038	6,040	\$1,231	236	4,063	\$828	10,339	\$2,107	0.05	0.1538	\$1,589.64	
55	2070	0.2049	6,040	\$1,238	236	4,063	\$833	10,339	\$2,119	0.05	0.1549	\$1,601.82	
56	2071	0.2061	6,040	\$1,245	236	4,063	\$837	10,339	\$2,131	0.05	0.1561	\$1,614.08	
57	2072	0.2073	6,040	\$1,252	236	4,063	\$842	10,339	\$2,143	0.05	0.1573	\$1,626.41	
58	2073	0.2085	6,040	\$1,259	236	4,063	\$847	10,339	\$2,156	0.05	0.1585	\$1,638.81	
59	2074	0.2097	6,040	\$1,267	236	4,063	\$852	10,339	\$2,168	0.05	0.1597	\$1,651.28	
60	2075	0.2109	6,040	\$1,274	236	4,063	\$857	10,339	\$2,181	0.05	0.1609	\$1,663.82	

Table D1-1.43: Annual Operating Costs (V.GSHP) of a 2,000 square feet detached house above grade (average construction type) in the city of Wiarton (two life cycles and three life cycles for a 60 year project lifespan); base case scenario in comparison with feed in-tariff (FIT) scenario. In the FIT scenario, an incentive of \$0.05/KWh is provided on electricity bills throughout the project lifespan

Horizontal Ground Source Heat Pump (H.GSHP)

Base Case Scenario											Feed in Tariff (FIT)		
H.GSHP											FIT		
#	Year	Electricity Rates \$/KWh	Heating KWh	Heating Operating Cost \$	Cooling KWh	Cooling Operating Cost \$	Hot Water KWh	Hot Water Operating Cost \$	Total KWh	Total Operating Cost \$	Incentives (\$/KWh)	\$/KWh	Operating Cost
1	2016	0.1501	6,086	\$913	218	\$33	4,307	\$646	10,611	\$1,593	0.05	0.1001	\$1,061.98
2	2017	0.1542	6,086	\$938	218	\$34	4,307	\$664	10,611	\$1,636	0.05	0.1042	\$1,105.53
3	2018	0.1583	6,086	\$963	218	\$35	4,307	\$682	10,611	\$1,680	0.05	0.1083	\$1,149.07
4	2019	0.1625	6,086	\$989	218	\$35	4,307	\$700	10,611	\$1,725	0.05	0.1125	\$1,194.15
5	2020	0.1668	6,086	\$1,015	218	\$36	4,307	\$718	10,611	\$1,770	0.05	0.1168	\$1,239.22
6	2021	0.1621	6,086	\$987	218	\$35	4,307	\$698	10,611	\$1,720	0.05	0.1121	\$1,189.95
7	2022	0.1629	6,086	\$992	218	\$36	4,307	\$702	10,611	\$1,729	0.05	0.1129	\$1,198.35
8	2023	0.1639	6,086	\$997	218	\$36	4,307	\$706	10,611	\$1,739	0.05	0.1139	\$1,208.28
9	2024	0.1648	6,086	\$1,003	218	\$36	4,307	\$710	10,611	\$1,749	0.05	0.1148	\$1,218.21
10	2025	0.1656	6,086	\$1,008	218	\$36	4,307	\$713	10,611	\$1,757	0.05	0.1156	\$1,226.62
11	2026	0.1665	6,086	\$1,014	218	\$36	4,307	\$717	10,611	\$1,767	0.05	0.1165	\$1,236.55
12	2027	0.1674	6,086	\$1,019	218	\$37	4,307	\$721	10,611	\$1,777	0.05	0.1174	\$1,246.10
13	2028	0.1683	6,086	\$1,024	218	\$37	4,307	\$725	10,611	\$1,785	0.05	0.1183	\$1,254.89
14	2029	0.1692	6,086	\$1,030	218	\$37	4,307	\$729	10,611	\$1,795	0.05	0.1192	\$1,264.43
15	2030	0.1701	6,086	\$1,035	218	\$37	4,307	\$733	10,611	\$1,805	0.05	0.1201	\$1,274.37
16	2031	0.1704	6,086	\$1,037	218	\$37	4,307	\$734	10,611	\$1,808	0.05	0.1204	\$1,277.04
17	2032	0.1705	6,086	\$1,038	218	\$37	4,307	\$734	10,611	\$1,809	0.05	0.1205	\$1,288.57
18	2033	0.1707	6,086	\$1,039	218	\$37	4,307	\$735	10,611	\$1,812	0.05	0.1207	\$1,281.24
19	2034	0.1710	6,086	\$1,041	218	\$37	4,307	\$737	10,611	\$1,815	0.05	0.1210	\$1,284.30
20	2035	0.1713	6,086	\$1,042	218	\$37	4,307	\$738	10,611	\$1,818	0.05	0.1213	\$1,286.97
21	2036	0.1714	6,086	\$1,043	218	\$37	4,307	\$738	10,611	\$1,819	0.05	0.1214	\$1,288.50
22	2037	0.1717	6,086	\$1,045	218	\$37	4,307	\$739	10,611	\$1,822	0.05	0.1217	\$1,291.17
23	2038	0.1720	6,086	\$1,047	218	\$37	4,307	\$741	10,611	\$1,825	0.05	0.1220	\$1,294.23
24	2039	0.1722	6,086	\$1,048	218	\$38	4,307	\$742	10,611	\$1,827	0.05	0.1222	\$1,296.90
25	2040	0.1724	6,086	\$1,049	218	\$38	4,307	\$742	10,611	\$1,829	0.05	0.1224	\$1,298.43
26	2041	0.1734	6,086	\$1,055	218	\$38	4,307	\$747	10,611	\$1,840	0.05	0.1234	\$1,309.01
27	2042	0.1744	6,086	\$1,061	218	\$38	4,307	\$751	10,611	\$1,850	0.05	0.1244	\$1,319.65
28	2043	0.1754	6,086	\$1,067	218	\$38	4,307	\$755	10,611	\$1,861	0.05	0.1254	\$1,330.36
29	2044	0.1764	6,086	\$1,074	218	\$38	4,307	\$760	10,611	\$1,872	0.05	0.1264	\$1,341.12
30	2045	0.1774	6,086	\$1,080	218	\$39	4,307	\$764	10,611	\$1,882	0.05	0.1274	\$1,351.95
31	2046	0.1784	6,086	\$1,086	218	\$39	4,307	\$769	10,611	\$1,893	0.05	0.1284	\$1,362.84
32	2047	0.1795	6,086	\$1,092	218	\$39	4,307	\$773	10,611	\$1,904	0.05	0.1295	\$1,373.79
33	2048	0.1805	6,086	\$1,099	218	\$39	4,307	\$777	10,611	\$1,915	0.05	0.1305	\$1,384.81
34	2049	0.1816	6,086	\$1,105	218	\$40	4,307	\$782	10,611	\$1,926	0.05	0.1316	\$1,395.89
35	2050	0.1826	6,086	\$1,111	218	\$40	4,307	\$786	10,611	\$1,938	0.05	0.1326	\$1,407.03
36	2051	0.1837	6,086	\$1,118	218	\$40	4,307	\$791	10,611	\$1,949	0.05	0.1337	\$1,418.24
37	2052	0.1847	6,086	\$1,124	218	\$40	4,307	\$796	10,611	\$1,960	0.05	0.1347	\$1,429.52
38	2053	0.1858	6,086	\$1,131	218	\$41	4,307	\$800	10,611	\$1,971	0.05	0.1358	\$1,440.85
39	2054	0.1869	6,086	\$1,137	218	\$41	4,307	\$805	10,611	\$1,983	0.05	0.1369	\$1,452.26
40	2055	0.1879	6,086	\$1,144	218	\$41	4,307	\$809	10,611	\$1,994	0.05	0.1379	\$1,463.73
41	2056	0.1890	6,086	\$1,150	218	\$41	4,307	\$814	10,611	\$2,006	0.05	0.1390	\$1,475.27
42	2057	0.1901	6,086	\$1,157	218	\$41	4,307	\$819	10,611	\$2,017	0.05	0.1401	\$1,486.87
43	2058	0.1912	6,086	\$1,164	218	\$42	4,307	\$824	10,611	\$2,029	0.05	0.1412	\$1,498.54
44	2059	0.1923	6,086	\$1,171	218	\$42	4,307	\$828	10,611	\$2,041	0.05	0.1423	\$1,510.28
45	2060	0.1934	6,086	\$1,177	218	\$42	4,307	\$833	10,611	\$2,053	0.05	0.1434	\$1,522.08
46	2061	0.1946	6,086	\$1,184	218	\$42	4,307	\$838	10,611	\$2,065	0.05	0.1446	\$1,533.96
47	2062	0.1957	6,086	\$1,191	218	\$43	4,307	\$843	10,611	\$2,076	0.05	0.1457	\$1,545.90
48	2063	0.1968	6,086	\$1,198	218	\$43	4,307	\$848	10,611	\$2,088	0.05	0.1468	\$1,557.91
49	2064	0.1980	6,086	\$1,205	218	\$43	4,307	\$853	10,611	\$2,101	0.05	0.1480	\$1,569.99
50	2065	0.1991	6,086	\$1,212	218	\$43	4,307	\$858	10,611	\$2,113	0.05	0.1491	\$1,582.15
51	2066	0.2003	6,086	\$1,219	218	\$44	4,307	\$863	10,611	\$2,125	0.05	0.1503	\$1,594.37
52	2067	0.2014	6,086	\$1,226	218	\$44	4,307	\$867	10,611	\$2,137	0.05	0.1514	\$1,606.66
53	2068	0.2026	6,086	\$1,233	218	\$44	4,307	\$873	10,611	\$2,150	0.05	0.1526	\$1,619.02
54	2069	0.2038	6,086	\$1,240	218	\$44	4,307	\$878	10,611	\$2,162	0.05	0.1538	\$1,631.46
55	2070	0.2049	6,086	\$1,247	218	\$45	4,307	\$883	10,611	\$2,175	0.05	0.1549	\$1,643.96
56	2071	0.2061	6,086	\$1,254	218	\$45	4,307	\$888	10,611	\$2,187	0.05	0.1561	\$1,656.54
57	2072	0.2073	6,086	\$1,262	218	\$45	4,307	\$893	10,611	\$2,200	0.05	0.1573	\$1,669.20
58	2073	0.2085	6,086	\$1,269	218	\$45	4,307	\$898	10,611	\$2,212	0.05	0.1585	\$1,681.92
59	2074	0.2097	6,086	\$1,276	218	\$46	4,307	\$903	10,611	\$2,225	0.05	0.1597	\$1,694.72
60	2075	0.2109	6,086	\$1,284	218	\$46	4,307	\$908	10,611	\$2,238	0.05	0.1609	\$1,707.59

Table D1-1.44: Annual Operating Costs (H.GSHP) of a 2,000 square feet detached house above grade (average construction type) in the city of Warton (two life cycles and three life cycles for a 60 year project lifespan); base case scenario in comparison with feed in-tariff (FIT) scenario. In the FIT scenario, an incentive of \$0.05/KWh is provided on electricity bills throughout the project lifespan

Traditional HVAC Applications

Base Case Scenario																Carbon Taxes						
#	Year	Traditional														Total	Conversion of m ³ into Tons	Total Tons	Carbon Tax	Operating Costs		
		Electricity Rates \$/KWh	Natural Gas Rates \$/m ³	Heating		Heating Operating Cost \$ (Electricity)	Heating Operating Cost \$ (Gas)	Total Heating Operating Cost \$	Cooling		Hot Water m ³	Hot Water Operating Cost \$	Total KWh	Total m ³	Total Electricity Operating Cost \$ (KWh)						Total Natural Gas Operating Cost \$ (m ³)	
				KWh (Electricity)	m ³ (Gas)				KWh	\$												
1	2016	0.1501	0.3458	1,813	2,855	\$272	\$987	\$1,259	1,037	\$156	1,052	\$364	2,850	3,907	428	\$1,351	\$764	7.07	7.07	\$10	\$70.72	\$1,849.61
2	2017	0.1542	0.3588	1,813	2,855	\$280	\$1,024	\$1,304	1,037	\$160	1,052	\$162	2,850	3,907	439	\$1,402	\$1,841	7.07	7.07	\$20	\$141.43	\$1,992.84
3	2018	0.1583	0.3718	1,813	2,855	\$287	\$1,062	\$1,349	1,037	\$164	1,052	\$167	2,850	3,907	451	\$1,453	\$1,904	7.07	7.07	\$30	\$212.15	\$2,116.07
4	2019	0.1625	0.3776	1,813	2,855	\$295	\$1,078	\$1,373	1,037	\$169	1,052	\$171	2,850	3,907	463	\$1,475	\$1,938	7.07	7.07	\$40	\$282.87	\$2,221.32
5	2020	0.1668	0.3841	1,813	2,855	\$302	\$1,097	\$1,399	1,037	\$173	1,052	\$173	2,850	3,907	475	\$1,501	\$1,976	7.07	7.07	\$50	\$353.58	\$2,329.55
6	2021	0.1621	0.3883	1,813	2,855	\$294	\$1,109	\$1,403	1,037	\$169	1,052	\$171	2,850	3,907	462	\$1,517	\$1,979	7.07	7.07	\$60	\$424.30	\$2,403.47
7	2022	0.1629	0.3929	1,813	2,855	\$295	\$1,122	\$1,417	1,037	\$169	1,052	\$171	2,850	3,907	464	\$1,535	\$1,999	7.07	7.07	\$70	\$495.02	\$2,494.38
8	2023	0.1639	0.3967	1,813	2,855	\$297	\$1,133	\$1,430	1,037	\$170	1,052	\$172	2,850	3,907	467	\$1,550	\$2,017	7.07	7.07	\$80	\$565.73	\$2,582.71
9	2024	0.1648	0.4005	1,813	2,855	\$299	\$1,144	\$1,442	1,037	\$171	1,052	\$173	2,850	3,907	470	\$1,565	\$2,035	7.07	7.07	\$90	\$636.45	\$2,671.04
10	2025	0.1656	0.4040	1,813	2,855	\$300	\$1,153	\$1,454	1,037	\$172	1,052	\$174	2,850	3,907	472	\$1,578	\$2,050	7.07	7.07	\$100	\$707.17	\$2,757.47
11	2026	0.1665	0.4070	1,813	2,855	\$302	\$1,162	\$1,464	1,037	\$173	1,052	\$175	2,850	3,907	475	\$1,590	\$2,065	7.07	7.07	\$110	\$777.88	\$2,842.81
12	2027	0.1674	0.4097	1,813	2,855	\$304	\$1,170	\$1,473	1,037	\$174	1,052	\$176	2,850	3,907	477	\$1,601	\$2,078	7.07	7.07	\$120	\$848.60	\$2,926.55
13	2028	0.1683	0.4124	1,813	2,855	\$305	\$1,177	\$1,482	1,037	\$174	1,052	\$177	2,850	3,907	480	\$1,611	\$2,091	7.07	7.07	\$130	\$919.32	\$3,010.09
14	2029	0.1692	0.4151	1,813	2,855	\$307	\$1,185	\$1,492	1,037	\$175	1,052	\$178	2,850	3,907	482	\$1,622	\$2,104	7.07	7.07	\$140	\$990.03	\$3,093.84
15	2030	0.1701	0.4170	1,813	2,855	\$308	\$1,190	\$1,499	1,037	\$176	1,052	\$179	2,850	3,907	485	\$1,629	\$2,114	7.07	7.07	\$150	\$1,060.75	\$3,174.69
16	2031	0.1704	0.4189	1,813	2,855	\$309	\$1,196	\$1,505	1,037	\$177	1,052	\$179	2,850	3,907	485	\$1,637	\$2,122	7.07	7.07	\$160	\$1,131.47	\$3,253.60
17	2032	0.1705	0.4204	1,813	2,855	\$309	\$1,200	\$1,509	1,037	\$177	1,052	\$179	2,850	3,907	486	\$1,643	\$2,129	7.07	7.07	\$170	\$1,202.18	\$3,330.71
18	2033	0.1707	0.4223	1,813	2,855	\$310	\$1,206	\$1,515	1,037	\$177	1,052	\$180	2,850	3,907	487	\$1,650	\$2,137	7.07	7.07	\$180	\$1,272.90	\$3,409.62
19	2034	0.1710	0.4246	1,813	2,855	\$310	\$1,212	\$1,522	1,037	\$177	1,052	\$180	2,850	3,907	487	\$1,659	\$2,147	7.07	7.07	\$190	\$1,343.62	\$3,490.12
20	2035	0.1713	0.4265	1,813	2,855	\$311	\$1,218	\$1,528	1,037	\$178	1,052	\$180	2,850	3,907	488	\$1,667	\$2,155	7.07	7.07	\$200	\$1,414.33	\$3,569.03
21	2036	0.1714	0.4288	1,813	2,855	\$311	\$1,224	\$1,535	1,037	\$178	1,052	\$180	2,850	3,907	489	\$1,675	\$2,164	7.07	7.07	\$210	\$1,485.05	\$3,649.12
22	2037	0.1717	0.4311	1,813	2,855	\$311	\$1,231	\$1,542	1,037	\$178	1,052	\$181	2,850	3,907	489	\$1,684	\$2,174	7.07	7.07	\$220	\$1,555.77	\$3,729.53
23	2038	0.1720	0.4331	1,813	2,855	\$312	\$1,236	\$1,548	1,037	\$178	1,052	\$181	2,850	3,907	490	\$1,692	\$2,182	7.07	7.07	\$230	\$1,626.48	\$3,808.54
24	2039	0.1722	0.4353	1,813	2,855	\$312	\$1,243	\$1,555	1,037	\$179	1,052	\$181	2,850	3,907	491	\$1,701	\$2,192	7.07	7.07	\$240	\$1,697.20	\$3,888.94
25	2040	0.1724	0.4376	1,813	2,855	\$313	\$1,249	\$1,562	1,037	\$179	1,052	\$181	2,850	3,907	491	\$1,710	\$2,201	7.07	7.07	\$250	\$1,767.92	\$3,969.04
26	2041	0.1734	0.4420	1,813	2,855	\$314	\$1,262	\$1,576	1,037	\$180	1,052	\$182	2,850	3,907	494	\$1,727	\$2,221	7.07	7.07	\$260	\$1,838.63	\$4,059.45
27	2042	0.1744	0.4463	1,813	2,855	\$316	\$1,274	\$1,590	1,037	\$181	1,052	\$183	2,850	3,907	497	\$1,744	\$2,241	7.07	7.07	\$270	\$1,909.35	\$4,150.05
28	2043	0.1754	0.4507	1,813	2,855	\$318	\$1,287	\$1,605	1,037	\$182	1,052	\$184	2,850	3,907	500	\$1,761	\$2,261	7.07	7.07	\$280	\$1,980.07	\$4,240.83
29	2044	0.1764	0.4552	1,813	2,855	\$320	\$1,299	\$1,619	1,037	\$183	1,052	\$186	2,850	3,907	503	\$1,778	\$2,281	7.07	7.07	\$290	\$2,050.78	\$4,331.80
30	2045	0.1774	0.4596	1,813	2,855	\$322	\$1,312	\$1,634	1,037	\$184	1,052	\$187	2,850	3,907	506	\$1,796	\$2,301	7.07	7.07	\$300	\$2,121.50	\$4,422.96
31	2046	0.1784	0.4642	1,813	2,855	\$324	\$1,325	\$1,649	1,037	\$185	1,052	\$188	2,850	3,907	509	\$1,814	\$2,322	7.07	7.07	\$310	\$2,192.22	\$4,514.31
32	2047	0.1795	0.4688	1,813	2,855	\$325	\$1,338	\$1,664	1,037	\$186	1,052	\$189	2,850	3,907	511	\$1,831	\$2,343	7.07	7.07	\$320	\$2,262.93	\$4,605.84
33	2048	0.1805	0.4734	1,813	2,855	\$327	\$1,351	\$1,679	1,037	\$187	1,052	\$190	2,850	3,907	514	\$1,849	\$2,364	7.07	7.07	\$330	\$2,333.65	\$4,697.58
34	2049	0.1816	0.4780	1,813	2,855	\$329	\$1,365	\$1,694	1,037	\$188	1,052	\$191	2,850	3,907	517	\$1,868	\$2,385	7.07	7.07	\$340	\$2,404.37	\$4,789.50
35	2050	0.1826	0.4828	1,813	2,855	\$331	\$1,378	\$1,709	1,037	\$189	1,052	\$192	2,850	3,907	520	\$1,886	\$2,407	7.07	7.07	\$350	\$2,475.08	\$4,881.63
36	2051	0.1837	0.4875	1,813	2,855	\$333	\$1,392	\$1,725	1,037	\$190	1,052	\$193	2,850	3,907	523	\$1,905	\$2,428	7.07	7.07	\$360	\$2,545.80	\$4,973.95
37	2052	0.1847	0.4923	1,813	2,855	\$335	\$1,406	\$1,740	1,037	\$192	1,052	\$194	2,850	3,907	526	\$1,924	\$2,450	7.07	7.07	\$370	\$2,616.52	\$5,066.47
38	2053	0.1858	0.4972	1,813	2,855	\$337	\$1,419	\$1,756	1,037	\$193	1,052	\$195	2,850	3,907	529	\$1,942	\$2,472	7.07	7.07	\$380	\$2,687.23	\$5,159.20
39	2054	0.1869	0.5021	1,813	2,855	\$339	\$1,433	\$1,772	1,037	\$194	1,052	\$197	2,850	3,907	533	\$1,962	\$2,494	7.07	7.07	\$390	\$2,757.95	\$5,252.13
40	2055	0.1879	0.5070	1,813	2,855	\$341	\$1,448	\$1,788	1,037	\$195	1,052	\$198	2,850	3,907	536	\$1,981	\$2,517	7.07	7.07	\$400	\$2,828.67	\$5,345.27
41	2056	0.1890	0.5120	1,813	2,855	\$343	\$1,462	\$1,805	1,037	\$196	1,052	\$199	2,850	3,907	539	\$2,000	\$2,539	7.07	7.07	\$410	\$2,899.38	\$5,438.61
42	2057	0.1901	0.5171	1,813	2,855	\$345	\$1,476	\$1,821	1,037	\$197	1,052	\$200	2,850	3,907	542	\$2,020	\$2,562	7.07	7.07	\$420	\$2,970.10	\$5,532.17
43	2058	0.1912	0.5222	1,813	2,855	\$347	\$1,491	\$1,837	1,037	\$198	1,052	\$201	2,850	3,907	545	\$2,040	\$2,585	7.07	7.07	\$430	\$3,040.82	\$5,625.94
44	2059	0.1923	0.5273	1,813	2,855	\$349	\$1,505	\$1,854	1,037	\$199	1,052	\$202	2,850	3,907	548	\$2,060	\$2,608	7.07	7.07	\$440	\$3,111.53	\$5,719.92
45	2060	0.1934	0.5325	1,813	2,855	\$351	\$1,520	\$1,871	1,037	\$201	1,052	\$204	2,850	3,907	551	\$2,081	\$2,632	7.07	7.07	\$450	\$3,182.25	\$5,814.12
46	2061	0.1946	0.5378	1,813	2,855	\$353	\$1,535	\$1,888	1,037	\$202	1,052	\$205	2,850	3,907	555	\$2,101	\$2,656	7.07	7.07	\$460	\$3,252.97	\$5,908.54
47	2062	0.1957	0.5431	1,813	2,855	\$355	\$1,550	\$1,905	1,037	\$203	1,052	\$206	2,850	3,907	558	\$2,122	\$2,679	7.07	7.07	\$470	\$3,323.68	\$6,003.18
48	2063	0.1968	0.5484	1,813	2,855	\$357	\$1,566	\$1,923	1,037	\$204	1,052	\$207	2,850	3,907	561	\$2,143	\$2,704	7.07	7.07	\$480	\$3,394.40	\$6,098.04
49	2064	0.1980	0.5538	1,813	2,855	\$359	\$1,581	\$1,940	1,037	\$205	1,052	\$208	2,850	3,907	564	\$2,164	\$2,728	7.07	7.07	\$490	\$3,465.12	\$6,193.12
50	2065	0.1991	0.5593	1,813	2,855	\$361	\$1,597	\$1,958	1,037	\$206	1,052	\$209	2,850	3,907	567	\$2,185	\$2,753	7.07	7.07	\$500	\$3,535.84	\$6,288.44
51	2066	0.2003	0.5648	1,813	2,855	\$363	\$1,613	\$1,976	1,037	\$208	1,052	\$211	2,850	3,907	571	\$2,207	\$2,777	7.07	7.07	\$510	\$3,606.55	\$6,383.98
52	2067	0.2014	0.5704	1,813	2,855	\$365	\$1,628	\$1,994	1,037	\$209	1,052	\$212	2,850	3,907	574	\$2,228	\$2,802	7.07	7.07	\$520	\$3,677.27	\$6,479.75
53	2068	0.2026	0.5760	1,813	2,855	\$367	\$1,644	\$2,012	1,037	\$210	1,052	\$213	2,8									

16. Windsor (South) – Annual Operating Costs

Vertical Ground Source Heat Pump (V.GSHP)

Base Case Scenario											Feed in Tariff (FIT)			
#	Year	Electricity Rates		V.GSHP		V.GSHP		V.GSHP		Total	Total Operating Cost	FIT		
		\$/KWh	KWh	Heating Operating Cost	Cooling	Cooling Operating Cost	Hot Water	Hot Water Operating Cost	KWh			\$	Incentives (\$/KWh)	\$/KWh
1	2016	0.1501	4,523	\$679	444	\$67	4,344	\$652	9,311	\$1,397	0.05	0.1001	\$931.87	
2	2017	0.1542	4,523	\$697	444	\$68	4,344	\$670	9,311	\$1,436	0.05	0.1042	\$970.08	
3	2018	0.1583	4,523	\$716	444	\$70	4,344	\$688	9,311	\$1,474	0.05	0.1083	\$1,008.30	
4	2019	0.1625	4,523	\$735	444	\$72	4,344	\$706	9,311	\$1,513	0.05	0.1125	\$1,047.85	
5	2020	0.1668	4,523	\$754	444	\$74	4,344	\$725	9,311	\$1,553	0.05	0.1168	\$1,087.40	
6	2021	0.1621	4,523	\$733	444	\$72	4,344	\$704	9,311	\$1,510	0.05	0.1121	\$1,044.16	
7	2022	0.1629	4,523	\$737	444	\$72	4,344	\$708	9,311	\$1,517	0.05	0.1129	\$1,051.53	
8	2023	0.1639	4,523	\$741	444	\$73	4,344	\$712	9,311	\$1,526	0.05	0.1139	\$1,060.25	
9	2024	0.1648	4,523	\$745	444	\$73	4,344	\$716	9,311	\$1,535	0.05	0.1148	\$1,068.97	
10	2025	0.1656	4,523	\$749	444	\$74	4,344	\$719	9,311	\$1,542	0.05	0.1156	\$1,076.34	
11	2026	0.1665	4,523	\$753	444	\$74	4,344	\$723	9,311	\$1,551	0.05	0.1165	\$1,085.05	
12	2027	0.1674	4,523	\$757	444	\$74	4,344	\$727	9,311	\$1,559	0.05	0.1174	\$1,093.43	
13	2028	0.1683	4,523	\$761	444	\$75	4,344	\$731	9,311	\$1,567	0.05	0.1183	\$1,101.14	
14	2029	0.1692	4,523	\$765	444	\$75	4,344	\$735	9,311	\$1,575	0.05	0.1192	\$1,109.52	
15	2030	0.1701	4,523	\$769	444	\$76	4,344	\$739	9,311	\$1,584	0.05	0.1201	\$1,118.24	
16	2031	0.1704	4,523	\$770	444	\$76	4,344	\$740	9,311	\$1,586	0.05	0.1204	\$1,120.58	
17	2032	0.1705	4,523	\$771	444	\$76	4,344	\$741	9,311	\$1,587	0.05	0.1205	\$1,121.93	
18	2033	0.1707	4,523	\$772	444	\$76	4,344	\$742	9,311	\$1,590	0.05	0.1207	\$1,124.27	
19	2034	0.1710	4,523	\$774	444	\$76	4,344	\$743	9,311	\$1,593	0.05	0.1210	\$1,126.95	
20	2035	0.1713	4,523	\$775	444	\$76	4,344	\$744	9,311	\$1,595	0.05	0.1213	\$1,129.30	
21	2036	0.1714	4,523	\$775	444	\$76	4,344	\$745	9,311	\$1,596	0.05	0.1214	\$1,130.64	
22	2037	0.1717	4,523	\$777	444	\$76	4,344	\$746	9,311	\$1,599	0.05	0.1217	\$1,132.99	
23	2038	0.1720	4,523	\$778	444	\$76	4,344	\$747	9,311	\$1,601	0.05	0.1220	\$1,135.67	
24	2039	0.1722	4,523	\$779	444	\$76	4,344	\$748	9,311	\$1,604	0.05	0.1222	\$1,138.01	
25	2040	0.1724	4,523	\$780	444	\$77	4,344	\$749	9,311	\$1,605	0.05	0.1224	\$1,139.36	
26	2041	0.1734	4,523	\$784	444	\$77	4,344	\$753	9,311	\$1,614	0.05	0.1234	\$1,148.64	
27	2042	0.1744	4,523	\$789	444	\$77	4,344	\$757	9,311	\$1,624	0.05	0.1244	\$1,157.98	
28	2043	0.1754	4,523	\$793	444	\$78	4,344	\$762	9,311	\$1,633	0.05	0.1254	\$1,167.37	
29	2044	0.1764	4,523	\$798	444	\$78	4,344	\$766	9,311	\$1,642	0.05	0.1264	\$1,176.82	
30	2045	0.1774	4,523	\$802	444	\$79	4,344	\$771	9,311	\$1,652	0.05	0.1274	\$1,186.32	
31	2046	0.1784	4,523	\$807	444	\$79	4,344	\$775	9,311	\$1,661	0.05	0.1284	\$1,195.87	
32	2047	0.1795	4,523	\$812	444	\$80	4,344	\$780	9,311	\$1,671	0.05	0.1295	\$1,205.48	
33	2048	0.1805	4,523	\$816	444	\$80	4,344	\$784	9,311	\$1,681	0.05	0.1305	\$1,215.15	
34	2049	0.1816	4,523	\$821	444	\$81	4,344	\$789	9,311	\$1,690	0.05	0.1316	\$1,224.87	
35	2050	0.1826	4,523	\$826	444	\$81	4,344	\$793	9,311	\$1,700	0.05	0.1326	\$1,234.65	
36	2051	0.1837	4,523	\$831	444	\$82	4,344	\$798	9,311	\$1,710	0.05	0.1337	\$1,244.49	
37	2052	0.1847	4,523	\$835	444	\$82	4,344	\$802	9,311	\$1,720	0.05	0.1347	\$1,254.38	
38	2053	0.1858	4,523	\$840	444	\$82	4,344	\$807	9,311	\$1,730	0.05	0.1358	\$1,264.33	
39	2054	0.1869	4,523	\$845	444	\$83	4,344	\$812	9,311	\$1,740	0.05	0.1369	\$1,274.34	
40	2055	0.1879	4,523	\$850	444	\$83	4,344	\$816	9,311	\$1,750	0.05	0.1379	\$1,284.40	
41	2056	0.1890	4,523	\$855	444	\$84	4,344	\$821	9,311	\$1,760	0.05	0.1390	\$1,294.52	
42	2057	0.1901	4,523	\$860	444	\$84	4,344	\$826	9,311	\$1,770	0.05	0.1401	\$1,304.71	
43	2058	0.1912	4,523	\$865	444	\$85	4,344	\$831	9,311	\$1,780	0.05	0.1412	\$1,314.95	
44	2059	0.1923	4,523	\$870	444	\$85	4,344	\$835	9,311	\$1,791	0.05	0.1423	\$1,325.25	
45	2060	0.1934	4,523	\$875	444	\$86	4,344	\$840	9,311	\$1,801	0.05	0.1434	\$1,335.61	
46	2061	0.1946	4,523	\$880	444	\$86	4,344	\$845	9,311	\$1,812	0.05	0.1446	\$1,346.03	
47	2062	0.1957	4,523	\$885	444	\$87	4,344	\$850	9,311	\$1,822	0.05	0.1457	\$1,356.51	
48	2063	0.1968	4,523	\$890	444	\$87	4,344	\$855	9,311	\$1,833	0.05	0.1468	\$1,367.05	
49	2064	0.1980	4,523	\$895	444	\$88	4,344	\$860	9,311	\$1,843	0.05	0.1480	\$1,377.65	
50	2065	0.1991	4,523	\$901	444	\$88	4,344	\$865	9,311	\$1,854	0.05	0.1491	\$1,388.31	
51	2066	0.2003	4,523	\$906	444	\$89	4,344	\$870	9,311	\$1,865	0.05	0.1503	\$1,399.03	
52	2067	0.2014	4,523	\$911	444	\$89	4,344	\$875	9,311	\$1,875	0.05	0.1514	\$1,409.82	
53	2068	0.2026	4,523	\$916	444	\$90	4,344	\$880	9,311	\$1,886	0.05	0.1526	\$1,420.67	
54	2069	0.2038	4,523	\$922	444	\$90	4,344	\$885	9,311	\$1,897	0.05	0.1538	\$1,431.58	
55	2070	0.2049	4,523	\$927	444	\$91	4,344	\$890	9,311	\$1,908	0.05	0.1549	\$1,442.56	
56	2071	0.2061	4,523	\$932	444	\$92	4,344	\$895	9,311	\$1,919	0.05	0.1561	\$1,453.59	
57	2072	0.2073	4,523	\$938	444	\$92	4,344	\$901	9,311	\$1,930	0.05	0.1573	\$1,464.70	
58	2073	0.2085	4,523	\$943	444	\$93	4,344	\$906	9,311	\$1,941	0.05	0.1585	\$1,475.86	
59	2074	0.2097	4,523	\$949	444	\$93	4,344	\$911	9,311	\$1,953	0.05	0.1597	\$1,487.09	
60	2075	0.2109	4,523	\$954	444	\$94	4,344	\$916	9,311	\$1,964	0.05	0.1609	\$1,498.39	

Table D1-1.46: Annual Operating Costs (V.GSHP) of a 2,000 square feet detached house above grade (average construction type) in the city of Windsor (two life cycles and three life cycles for a 60 year project lifespan); base case scenario in comparison with feed in-tariff (FIT) scenario. In the FIT scenario, an incentive of \$0.05/KWh is provided on electricity bills throughout the project lifespan

Horizontal Ground Source Heat Pump (H.GSHP)

Base Case Scenario											Feed in Tariff (FIT)		
#	Year	H.GSHP									FIT		
		Electricity Rates \$/KWh	Heating KWh	Heating Operating Cost \$	Cooling KWh	Cooling Operating Cost \$	Hot Water KWh	Hot Water Operating Cost \$	Total KWh	Total Operating Cost \$	Incentives (\$/KWh)	S/KWh	Operating Cost
1	2016	0.1501	4,605	\$691	455	\$68	4,317	\$648	9,377	\$1,407	0.05	0.1001	\$938.48
2	2017	0.1542	4,605	\$710	455	\$70	4,317	\$666	9,377	\$1,446	0.05	0.1042	\$976.96
3	2018	0.1583	4,605	\$729	455	\$72	4,317	\$683	9,377	\$1,484	0.05	0.1083	\$1,015.44
4	2019	0.1625	4,605	\$748	455	\$74	4,317	\$702	9,377	\$1,524	0.05	0.1125	\$1,055.28
5	2020	0.1668	4,605	\$768	455	\$76	4,317	\$720	9,377	\$1,564	0.05	0.1168	\$1,095.11
6	2021	0.1621	4,605	\$747	455	\$74	4,317	\$700	9,377	\$1,520	0.05	0.1121	\$1,051.56
7	2022	0.1629	4,605	\$750	455	\$74	4,317	\$703	9,377	\$1,528	0.05	0.1129	\$1,058.99
8	2023	0.1639	4,605	\$755	455	\$75	4,317	\$707	9,377	\$1,537	0.05	0.1139	\$1,067.77
9	2024	0.1648	4,605	\$759	455	\$75	4,317	\$711	9,377	\$1,545	0.05	0.1148	\$1,076.54
10	2025	0.1656	4,605	\$763	455	\$75	4,317	\$715	9,377	\$1,553	0.05	0.1156	\$1,083.97
11	2026	0.1665	4,605	\$767	455	\$76	4,317	\$719	9,377	\$1,562	0.05	0.1165	\$1,092.75
12	2027	0.1674	4,605	\$771	455	\$76	4,317	\$723	9,377	\$1,570	0.05	0.1174	\$1,101.18
13	2028	0.1683	4,605	\$775	455	\$77	4,317	\$726	9,377	\$1,578	0.05	0.1183	\$1,108.95
14	2029	0.1692	4,605	\$779	455	\$77	4,317	\$730	9,377	\$1,586	0.05	0.1192	\$1,117.39
15	2030	0.1701	4,605	\$783	455	\$77	4,317	\$734	9,377	\$1,595	0.05	0.1201	\$1,126.16
16	2031	0.1704	4,605	\$784	455	\$78	4,317	\$735	9,377	\$1,597	0.05	0.1204	\$1,128.53
17	2032	0.1705	4,605	\$785	455	\$78	4,317	\$736	9,377	\$1,599	0.05	0.1205	\$1,129.88
18	2033	0.1707	4,605	\$786	455	\$78	4,317	\$737	9,377	\$1,601	0.05	0.1207	\$1,132.24
19	2034	0.1710	4,605	\$788	455	\$78	4,317	\$738	9,377	\$1,604	0.05	0.1210	\$1,134.94
20	2035	0.1713	4,605	\$789	455	\$78	4,317	\$739	9,377	\$1,606	0.05	0.1213	\$1,137.30
21	2036	0.1714	4,605	\$789	455	\$78	4,317	\$740	9,377	\$1,608	0.05	0.1214	\$1,138.66
22	2037	0.1717	4,605	\$791	455	\$78	4,317	\$741	9,377	\$1,610	0.05	0.1217	\$1,141.02
23	2038	0.1720	4,605	\$792	455	\$78	4,317	\$742	9,377	\$1,613	0.05	0.1220	\$1,143.72
24	2039	0.1722	4,605	\$793	455	\$78	4,317	\$743	9,377	\$1,615	0.05	0.1222	\$1,146.08
25	2040	0.1724	4,605	\$794	455	\$78	4,317	\$744	9,377	\$1,616	0.05	0.1224	\$1,147.43
26	2041	0.1734	4,605	\$798	455	\$79	4,317	\$748	9,377	\$1,626	0.05	0.1234	\$1,156.78
27	2042	0.1744	4,605	\$803	455	\$79	4,317	\$753	9,377	\$1,635	0.05	0.1244	\$1,166.19
28	2043	0.1754	4,605	\$808	455	\$80	4,317	\$757	9,377	\$1,644	0.05	0.1254	\$1,175.64
29	2044	0.1764	4,605	\$812	455	\$80	4,317	\$761	9,377	\$1,654	0.05	0.1264	\$1,185.16
30	2045	0.1774	4,605	\$817	455	\$81	4,317	\$766	9,377	\$1,664	0.05	0.1274	\$1,194.73
31	2046	0.1784	4,605	\$822	455	\$81	4,317	\$770	9,377	\$1,673	0.05	0.1284	\$1,204.35
32	2047	0.1795	4,605	\$826	455	\$82	4,317	\$775	9,377	\$1,683	0.05	0.1295	\$1,214.03
33	2048	0.1805	4,605	\$831	455	\$82	4,317	\$779	9,377	\$1,693	0.05	0.1305	\$1,223.76
34	2049	0.1816	4,605	\$836	455	\$83	4,317	\$784	9,377	\$1,702	0.05	0.1316	\$1,233.56
35	2050	0.1826	4,605	\$841	455	\$83	4,317	\$788	9,377	\$1,712	0.05	0.1326	\$1,243.40
36	2051	0.1837	4,605	\$846	455	\$84	4,317	\$793	9,377	\$1,722	0.05	0.1337	\$1,253.31
37	2052	0.1847	4,605	\$851	455	\$84	4,317	\$797	9,377	\$1,732	0.05	0.1347	\$1,263.27
38	2053	0.1858	4,605	\$856	455	\$85	4,317	\$802	9,377	\$1,742	0.05	0.1358	\$1,273.29
39	2054	0.1869	4,605	\$861	455	\$85	4,317	\$807	9,377	\$1,752	0.05	0.1369	\$1,283.37
40	2055	0.1879	4,605	\$865	455	\$86	4,317	\$811	9,377	\$1,762	0.05	0.1379	\$1,293.51
41	2056	0.1890	4,605	\$870	455	\$86	4,317	\$816	9,377	\$1,773	0.05	0.1390	\$1,303.70
42	2057	0.1901	4,605	\$876	455	\$87	4,317	\$821	9,377	\$1,783	0.05	0.1401	\$1,313.95
43	2058	0.1912	4,605	\$881	455	\$87	4,317	\$826	9,377	\$1,793	0.05	0.1412	\$1,324.27
44	2059	0.1923	4,605	\$886	455	\$88	4,317	\$830	9,377	\$1,803	0.05	0.1423	\$1,334.64
45	2060	0.1934	4,605	\$891	455	\$88	4,317	\$835	9,377	\$1,814	0.05	0.1434	\$1,345.07
46	2061	0.1946	4,605	\$896	455	\$89	4,317	\$840	9,377	\$1,824	0.05	0.1446	\$1,355.57
47	2062	0.1957	4,605	\$901	455	\$89	4,317	\$845	9,377	\$1,835	0.05	0.1457	\$1,366.12
48	2063	0.1968	4,605	\$906	455	\$90	4,317	\$850	9,377	\$1,846	0.05	0.1468	\$1,376.74
49	2064	0.1980	4,605	\$912	455	\$90	4,317	\$855	9,377	\$1,856	0.05	0.1480	\$1,387.41
50	2065	0.1991	4,605	\$917	455	\$91	4,317	\$860	9,377	\$1,867	0.05	0.1491	\$1,398.15
51	2066	0.2003	4,605	\$922	455	\$91	4,317	\$865	9,377	\$1,878	0.05	0.1503	\$1,408.95
52	2067	0.2014	4,605	\$928	455	\$92	4,317	\$870	9,377	\$1,889	0.05	0.1514	\$1,419.81
53	2068	0.2026	4,605	\$933	455	\$92	4,317	\$875	9,377	\$1,900	0.05	0.1526	\$1,430.74
54	2069	0.2038	4,605	\$938	455	\$93	4,317	\$880	9,377	\$1,911	0.05	0.1538	\$1,441.73
55	2070	0.2049	4,605	\$944	455	\$93	4,317	\$885	9,377	\$1,922	0.05	0.1549	\$1,452.78
56	2071	0.2061	4,605	\$949	455	\$94	4,317	\$890	9,377	\$1,933	0.05	0.1561	\$1,463.90
57	2072	0.2073	4,605	\$955	455	\$94	4,317	\$895	9,377	\$1,944	0.05	0.1573	\$1,475.08
58	2073	0.2085	4,605	\$960	455	\$95	4,317	\$900	9,377	\$1,955	0.05	0.1585	\$1,486.32
59	2074	0.2097	4,605	\$966	455	\$95	4,317	\$905	9,377	\$1,966	0.05	0.1597	\$1,497.63
60	2075	0.2109	4,605	\$971	455	\$96	4,317	\$911	9,377	\$1,978	0.05	0.1609	\$1,509.01

Table D1-1.47: Annual Operating Costs (H.GSHP) of a 2,000 square feet detached house above grade (average construction type) in the city of Windsor (two life cycles and three life cycles for a 60 year project lifespan); base case scenario in comparison with feed in-tariff (FIT) scenario. In the FIT scenario, an incentive of \$0.05/KWh is provided on electricity bills throughout the project lifespan

Traditional HVAC Applications

Base Case Scenario															Carbon Taxes								
#	Year	Electricity Rates	Natural Gas Rates	Traditional										Total	Total Electricity Operating Cost	Total Natural Gas Operating Cost	Total	Conversion of m ³ into Tons	Total Tons	Carbon Tax	Operating Costs		
				Heating		Heating Operating Cost	Heating Operating Cost	Total Heating Operating Cost	Cooling	Cooling Operating Cost		Hot Water	Hot Water Operating Cost									Total	Total
				KWh (Electricity)	m ³ (Gas)					\$ (Electricity)	\$ (Gas)												
1	2016	0.1501	0.3458	1,530	2,244	\$230	\$776	\$1,006	1,911	\$287	1,003	\$347	3,441	3,247	516	\$1,123	\$1,639	5.88	5.88	\$10	\$58.77	\$1,698.12	
2	2017	0.1542	0.3588	1,530	2,244	\$236	\$805	\$1,041	1,911	\$295	1,003	\$355	3,441	3,247	531	\$1,165	\$1,696	5.88	5.88	\$20	\$117.54	\$1,813.24	
3	2018	0.1583	0.3718	1,530	2,244	\$242	\$834	\$1,077	1,911	\$302	1,003	\$363	3,441	3,247	545	\$1,207	\$1,752	5.88	5.88	\$30	\$176.31	\$1,928.37	
4	2019	0.1625	0.3776	1,530	2,244	\$249	\$847	\$1,096	1,911	\$311	1,003	\$363	3,441	3,247	559	\$1,226	\$1,785	5.88	5.88	\$40	\$235.08	\$2,020.39	
5	2020	0.1668	0.3841	1,530	2,244	\$255	\$862	\$1,117	1,911	\$319	1,003	\$367	3,441	3,247	574	\$1,247	\$1,821	5.88	5.88	\$50	\$293.85	\$2,114.89	
6	2021	0.1621	0.3883	1,530	2,244	\$248	\$871	\$1,119	1,911	\$310	1,003	\$363	3,441	3,247	558	\$1,261	\$1,819	5.88	5.88	\$60	\$352.62	\$2,171.35	
7	2022	0.1629	0.3929	1,530	2,244	\$249	\$882	\$1,131	1,911	\$311	1,003	\$363	3,441	3,247	561	\$1,276	\$1,836	5.88	5.88	\$70	\$411.39	\$2,247.75	
8	2023	0.1639	0.3967	1,530	2,244	\$251	\$890	\$1,141	1,911	\$313	1,003	\$364	3,441	3,247	564	\$1,288	\$1,852	5.88	5.88	\$80	\$470.17	\$2,322.16	
9	2024	0.1648	0.4005	1,530	2,244	\$252	\$899	\$1,151	1,911	\$315	1,003	\$365	3,441	3,247	567	\$1,301	\$1,868	5.88	5.88	\$90	\$528.94	\$2,396.58	
10	2025	0.1656	0.4040	1,530	2,244	\$253	\$907	\$1,160	1,911	\$316	1,003	\$366	3,441	3,247	570	\$1,312	\$1,882	5.88	5.88	\$100	\$587.71	\$2,469.25	
11	2026	0.1665	0.4070	1,530	2,244	\$255	\$913	\$1,168	1,911	\$318	1,003	\$367	3,441	3,247	573	\$1,322	\$1,895	5.88	5.88	\$110	\$646.48	\$2,541.18	
12	2027	0.1674	0.4097	1,530	2,244	\$256	\$919	\$1,176	1,911	\$320	1,003	\$368	3,441	3,247	576	\$1,330	\$1,906	5.88	5.88	\$120	\$705.25	\$2,611.74	
13	2028	0.1683	0.4124	1,530	2,244	\$257	\$925	\$1,183	1,911	\$322	1,003	\$369	3,441	3,247	579	\$1,339	\$1,918	5.88	5.88	\$130	\$764.02	\$2,682.06	
14	2029	0.1692	0.4151	1,530	2,244	\$259	\$931	\$1,190	1,911	\$323	1,003	\$370	3,441	3,247	582	\$1,348	\$1,930	5.88	5.88	\$140	\$822.79	\$2,752.62	
15	2030	0.1701	0.4170	1,530	2,244	\$260	\$936	\$1,196	1,911	\$325	1,003	\$371	3,441	3,247	585	\$1,354	\$1,939	5.88	5.88	\$150	\$881.56	\$2,820.82	
16	2031	0.1704	0.4189	1,530	2,244	\$261	\$940	\$1,201	1,911	\$326	1,003	\$371	3,441	3,247	586	\$1,360	\$1,946	5.88	5.88	\$160	\$940.33	\$2,886.67	
17	2032	0.1705	0.4204	1,530	2,244	\$261	\$943	\$1,204	1,911	\$326	1,003	\$371	3,441	3,247	587	\$1,365	\$1,952	5.88	5.88	\$170	\$999.10	\$2,950.91	
18	2033	0.1707	0.4223	1,530	2,244	\$261	\$948	\$1,209	1,911	\$326	1,003	\$371	3,441	3,247	588	\$1,371	\$1,959	5.88	5.88	\$180	\$1,057.87	\$3,016.75	
19	2034	0.1710	0.4246	1,530	2,244	\$262	\$953	\$1,215	1,911	\$327	1,003	\$372	3,441	3,247	589	\$1,379	\$1,967	5.88	5.88	\$190	\$1,116.64	\$3,083.97	
20	2035	0.1713	0.4265	1,530	2,244	\$262	\$957	\$1,219	1,911	\$327	1,003	\$372	3,441	3,247	589	\$1,385	\$1,974	5.88	5.88	\$200	\$1,175.41	\$3,149.82	
21	2036	0.1714	0.4288	1,530	2,244	\$262	\$962	\$1,225	1,911	\$328	1,003	\$372	3,441	3,247	590	\$1,392	\$1,982	5.88	5.88	\$210	\$1,234.18	\$3,216.54	
22	2037	0.1717	0.4311	1,530	2,244	\$263	\$967	\$1,230	1,911	\$328	1,003	\$372	3,441	3,247	591	\$1,400	\$1,991	5.88	5.88	\$220	\$1,292.96	\$3,283.63	
23	2038	0.1720	0.4331	1,530	2,244	\$263	\$972	\$1,235	1,911	\$329	1,003	\$372	3,441	3,247	592	\$1,406	\$1,998	5.88	5.88	\$230	\$1,351.73	\$3,349.60	
24	2039	0.1722	0.4353	1,530	2,244	\$264	\$977	\$1,240	1,911	\$329	1,003	\$373	3,441	3,247	593	\$1,414	\$2,006	5.88	5.88	\$240	\$1,410.50	\$3,416.69	
25	2040	0.1724	0.4376	1,530	2,244	\$264	\$982	\$1,246	1,911	\$329	1,003	\$373	3,441	3,247	593	\$1,421	\$2,014	5.88	5.88	\$250	\$1,469.27	\$3,483.41	
26	2041	0.1734	0.4420	1,530	2,244	\$265	\$992	\$1,257	1,911	\$331	1,003	\$374	3,441	3,247	597	\$1,435	\$2,032	5.88	5.88	\$260	\$1,528.04	\$3,559.62	
27	2042	0.1744	0.4463	1,530	2,244	\$267	\$1,002	\$1,268	1,911	\$333	1,003	\$375	3,441	3,247	600	\$1,449	\$2,049	5.88	5.88	\$270	\$1,586.81	\$3,635.99	
28	2043	0.1754	0.4507	1,530	2,244	\$268	\$1,011	\$1,280	1,911	\$335	1,003	\$376	3,441	3,247	603	\$1,463	\$2,067	5.88	5.88	\$280	\$1,645.58	\$3,712.52	
29	2044	0.1764	0.4552	1,530	2,244	\$270	\$1,021	\$1,291	1,911	\$337	1,003	\$377	3,441	3,247	607	\$1,478	\$2,085	5.88	5.88	\$290	\$1,704.35	\$3,789.21	
30	2045	0.1774	0.4596	1,530	2,244	\$271	\$1,031	\$1,303	1,911	\$339	1,003	\$378	3,441	3,247	610	\$1,492	\$2,103	5.88	5.88	\$300	\$1,763.12	\$3,866.06	
31	2046	0.1784	0.4642	1,530	2,244	\$273	\$1,042	\$1,315	1,911	\$341	1,003	\$379	3,441	3,247	614	\$1,507	\$2,121	5.88	5.88	\$310	\$1,821.89	\$3,942.81	
32	2047	0.1795	0.4688	1,530	2,244	\$275	\$1,052	\$1,326	1,911	\$343	1,003	\$380	3,441	3,247	618	\$1,522	\$2,140	5.88	5.88	\$320	\$1,880.66	\$4,020.26	
33	2048	0.1805	0.4734	1,530	2,244	\$276	\$1,062	\$1,338	1,911	\$345	1,003	\$381	3,441	3,247	621	\$1,537	\$2,158	5.88	5.88	\$330	\$1,939.43	\$4,097.61	
34	2049	0.1816	0.4780	1,530	2,244	\$278	\$1,073	\$1,351	1,911	\$347	1,003	\$382	3,441	3,247	625	\$1,552	\$2,177	5.88	5.88	\$340	\$1,998.20	\$4,175.13	
35	2050	0.1826	0.4828	1,530	2,244	\$279	\$1,083	\$1,363	1,911	\$349	1,003	\$383	3,441	3,247	628	\$1,568	\$2,196	5.88	5.88	\$350	\$2,056.97	\$4,252.81	
36	2051	0.1837	0.4875	1,530	2,244	\$281	\$1,094	\$1,375	1,911	\$351	1,003	\$384	3,441	3,247	632	\$1,583	\$2,215	5.88	5.88	\$360	\$2,115.75	\$4,330.67	
37	2052	0.1847	0.4923	1,530	2,244	\$283	\$1,105	\$1,387	1,911	\$353	1,003	\$385	3,441	3,247	636	\$1,599	\$2,234	5.88	5.88	\$370	\$2,174.52	\$4,408.71	
38	2053	0.1858	0.4972	1,530	2,244	\$284	\$1,116	\$1,400	1,911	\$355	1,003	\$386	3,441	3,247	639	\$1,614	\$2,254	5.88	5.88	\$380	\$2,233.29	\$4,486.92	
39	2054	0.1869	0.5021	1,530	2,244	\$286	\$1,127	\$1,413	1,911	\$357	1,003	\$387	3,441	3,247	643	\$1,630	\$2,273	5.88	5.88	\$390	\$2,292.06	\$4,565.30	
40	2055	0.1879	0.5070	1,530	2,244	\$288	\$1,138	\$1,425	1,911	\$359	1,003	\$389	3,441	3,247	647	\$1,646	\$2,293	5.88	5.88	\$400	\$2,350.83	\$4,643.86	
41	2056	0.1890	0.5120	1,530	2,244	\$289	\$1,149	\$1,438	1,911	\$361	1,003	\$390	3,441	3,247	650	\$1,663	\$2,313	5.88	5.88	\$410	\$2,409.60	\$4,722.61	
42	2057	0.1901	0.5171	1,530	2,244	\$291	\$1,160	\$1,451	1,911	\$363	1,003	\$391	3,441	3,247	654	\$1,679	\$2,333	5.88	5.88	\$420	\$2,468.37	\$4,801.53	
43	2058	0.1912	0.5222	1,530	2,244	\$293	\$1,172	\$1,464	1,911	\$365	1,003	\$392	3,441	3,247	658	\$1,695	\$2,353	5.88	5.88	\$430	\$2,527.14	\$4,880.64	
44	2059	0.1923	0.5273	1,530	2,244	\$294	\$1,183	\$1,478	1,911	\$368	1,003	\$393	3,441	3,247	662	\$1,712	\$2,374	5.88	5.88	\$440	\$2,585.91	\$4,959.93	
45	2060	0.1934	0.5325	1,530	2,244	\$296	\$1,195	\$1,491	1,911	\$370	1,003	\$394	3,441	3,247	666	\$1,729	\$2,395	5.88	5.88	\$450	\$2,644.68	\$5,039.41	
46	2061	0.1946	0.5378	1,530	2,244	\$298	\$1,207	\$1,504	1,911	\$372	1,003	\$395	3,441	3,247	669	\$1,746	\$2,416	5.88	5.88	\$460	\$2,703.45	\$5,119.08	
47	2062	0.1957	0.5431	1,530	2,244	\$299	\$1,219	\$1,518	1,911	\$374	1,003	\$396	3,441	3,247	673	\$1,763	\$2,437	5.88	5.88	\$470	\$2,762.22	\$5,198.94	
48	2063	0.1968	0.5484	1,530	2,244	\$301	\$1,231	\$1,532	1,911	\$376	1,003	\$397	3,441	3,247	677	\$1,781	\$2,458	5.88	5.88	\$480	\$2,820.99	\$5,278.99	
49	2064	0.1980	0.5538	1,530	2,244	\$303	\$1,243	\$1,546	1,911	\$378	1,003	\$399	3,441	3,247	681	\$1,798	\$2,479	5.88	5.88	\$490	\$2,879.76	\$5,359.23	
50	2065	0.1991	0.5593	1,530	2,244	\$305	\$1,255	\$1,560	1,911	\$380	1,003	\$200	3,441	3,247	685	\$1,816	\$2,501	5.88	5.88	\$500	\$2,938.54	\$5,439.67	
51	2066	0.2003	0.5648	1,530	2,244	\$306	\$1,267	\$1,574	1,911	\$383	1,003	\$201	3,441	3,247	689	\$1,834	\$2,523	5.88	5.88	\$510	\$2,997.31	\$5,520.31	
52	2067	0.2014	0.5704	1,530	2,244	\$308	\$1,280	\$1,588	1,911	\$385	1,003	\$202	3,441	3,247	693	\$1,857	\$2,545	5.88	5.88	\$520	\$3,056.08	\$5,603.05	
53	2068	0.2026	0.5760	1,530	2,244	\$310	\$1,293	\$1,602	1,911	\$387	1,003	\$203	3,441	3,247	69								

17. Barrie (Distinct) – Annual Operating Costs

Vertical Ground Source Heat Pump (V.GSHP)

Base Case Scenario											Feed in Tariff (FIT)		
#	Year	Electricity Rates		V.GSHP		Hot Water		Total	Total Operating Cost	FIT	Incentives (\$/KWh)	Operating Cost	
		\$/KWh	KWh	Heating Operating Cost	Cooling Operating Cost	Hot Water Operating Cost	KWh						\$/KWh
1	2016	0.1501	5,665	\$850	234	\$35	4,293	\$644	10,192	\$1,530	0.05	\$1,020.04	
2	2017	0.1542	5,665	\$873	234	\$36	4,293	\$662	10,192	\$1,571	0.05	\$1,061.87	
3	2018	0.1583	5,665	\$897	234	\$37	4,293	\$680	10,192	\$1,613	0.05	\$1,103.70	
4	2019	0.1625	5,665	\$921	234	\$38	4,293	\$698	10,192	\$1,657	0.05	\$1,146.99	
5	2020	0.1668	5,665	\$945	234	\$39	4,293	\$716	10,192	\$1,700	0.05	\$1,190.29	
6	2021	0.1621	5,665	\$919	234	\$38	4,293	\$696	10,192	\$1,653	0.05	\$1,142.96	
7	2022	0.1629	5,665	\$923	234	\$38	4,293	\$699	10,192	\$1,661	0.05	\$1,151.03	
8	2023	0.1639	5,665	\$928	234	\$38	4,293	\$703	10,192	\$1,670	0.05	\$1,160.57	
9	2024	0.1648	5,665	\$934	234	\$39	4,293	\$708	10,192	\$1,680	0.05	\$1,170.11	
10	2025	0.1656	5,665	\$938	234	\$39	4,293	\$711	10,192	\$1,688	0.05	\$1,178.18	
11	2026	0.1665	5,665	\$943	234	\$39	4,293	\$715	10,192	\$1,697	0.05	\$1,187.72	
12	2027	0.1674	5,665	\$949	234	\$39	4,293	\$719	10,192	\$1,706	0.05	\$1,196.89	
13	2028	0.1683	5,665	\$953	234	\$39	4,293	\$722	10,192	\$1,715	0.05	\$1,205.33	
14	2029	0.1692	5,665	\$958	234	\$40	4,293	\$726	10,192	\$1,724	0.05	\$1,214.51	
15	2030	0.1701	5,665	\$964	234	\$40	4,293	\$730	10,192	\$1,734	0.05	\$1,224.05	
16	2031	0.1704	5,665	\$965	234	\$40	4,293	\$731	10,192	\$1,736	0.05	\$1,226.61	
17	2032	0.1705	5,665	\$966	234	\$40	4,293	\$732	10,192	\$1,738	0.05	\$1,228.08	
18	2033	0.1707	5,665	\$967	234	\$40	4,293	\$733	10,192	\$1,740	0.05	\$1,230.65	
19	2034	0.1710	5,665	\$969	234	\$40	4,293	\$734	10,192	\$1,743	0.05	\$1,233.58	
20	2035	0.1713	5,665	\$970	234	\$40	4,293	\$735	10,192	\$1,746	0.05	\$1,236.15	
21	2036	0.1714	5,665	\$971	234	\$40	4,293	\$736	10,192	\$1,747	0.05	\$1,237.62	
22	2037	0.1717	5,665	\$973	234	\$40	4,293	\$737	10,192	\$1,750	0.05	\$1,240.19	
23	2038	0.1720	5,665	\$974	234	\$40	4,293	\$738	10,192	\$1,753	0.05	\$1,243.12	
24	2039	0.1722	5,665	\$976	234	\$40	4,293	\$739	10,192	\$1,755	0.05	\$1,245.69	
25	2040	0.1724	5,665	\$976	234	\$40	4,293	\$740	10,192	\$1,757	0.05	\$1,247.16	
26	2041	0.1734	5,665	\$982	234	\$41	4,293	\$744	10,192	\$1,767	0.05	\$1,257.32	
27	2042	0.1744	5,665	\$988	234	\$41	4,293	\$749	10,192	\$1,777	0.05	\$1,267.54	
28	2043	0.1754	5,665	\$994	234	\$41	4,293	\$753	10,192	\$1,787	0.05	\$1,277.83	
29	2044	0.1764	5,665	\$999	234	\$41	4,293	\$757	10,192	\$1,798	0.05	\$1,288.17	
30	2045	0.1774	5,665	\$1,005	234	\$42	4,293	\$762	10,192	\$1,808	0.05	\$1,298.56	
31	2046	0.1784	5,665	\$1,011	234	\$42	4,293	\$766	10,192	\$1,819	0.05	\$1,309.02	
32	2047	0.1795	5,665	\$1,017	234	\$42	4,293	\$770	10,192	\$1,829	0.05	\$1,319.55	
33	2048	0.1805	5,665	\$1,023	234	\$42	4,293	\$775	10,192	\$1,840	0.05	\$1,330.13	
34	2049	0.1816	5,665	\$1,028	234	\$42	4,293	\$779	10,192	\$1,850	0.05	\$1,340.77	
35	2050	0.1826	5,665	\$1,034	234	\$43	4,293	\$784	10,192	\$1,861	0.05	\$1,351.47	
36	2051	0.1837	5,665	\$1,040	234	\$43	4,293	\$788	10,192	\$1,872	0.05	\$1,362.24	
37	2052	0.1847	5,665	\$1,046	234	\$43	4,293	\$793	10,192	\$1,883	0.05	\$1,373.07	
38	2053	0.1858	5,665	\$1,052	234	\$43	4,293	\$798	10,192	\$1,894	0.05	\$1,383.96	
39	2054	0.1869	5,665	\$1,059	234	\$44	4,293	\$802	10,192	\$1,905	0.05	\$1,394.91	
40	2055	0.1879	5,665	\$1,065	234	\$44	4,293	\$807	10,192	\$1,916	0.05	\$1,405.93	
41	2056	0.1890	5,665	\$1,071	234	\$44	4,293	\$812	10,192	\$1,927	0.05	\$1,417.01	
42	2057	0.1901	5,665	\$1,077	234	\$44	4,293	\$816	10,192	\$1,938	0.05	\$1,428.16	
43	2058	0.1912	5,665	\$1,083	234	\$45	4,293	\$821	10,192	\$1,949	0.05	\$1,439.37	
44	2059	0.1923	5,665	\$1,090	234	\$45	4,293	\$826	10,192	\$1,960	0.05	\$1,450.64	
45	2060	0.1934	5,665	\$1,096	234	\$45	4,293	\$830	10,192	\$1,972	0.05	\$1,461.98	
46	2061	0.1946	5,665	\$1,102	234	\$46	4,293	\$835	10,192	\$1,983	0.05	\$1,473.39	
47	2062	0.1957	5,665	\$1,109	234	\$46	4,293	\$840	10,192	\$1,994	0.05	\$1,484.86	
48	2063	0.1968	5,665	\$1,115	234	\$46	4,293	\$845	10,192	\$2,006	0.05	\$1,496.39	
49	2064	0.1980	5,665	\$1,121	234	\$46	4,293	\$850	10,192	\$2,018	0.05	\$1,508.00	
50	2065	0.1991	5,665	\$1,128	234	\$47	4,293	\$855	10,192	\$2,029	0.05	\$1,519.67	
51	2066	0.2003	5,665	\$1,134	234	\$47	4,293	\$860	10,192	\$2,041	0.05	\$1,531.41	
52	2067	0.2014	5,665	\$1,141	234	\$47	4,293	\$865	10,192	\$2,053	0.05	\$1,543.22	
53	2068	0.2026	5,665	\$1,148	234	\$47	4,293	\$870	10,192	\$2,065	0.05	\$1,555.09	
54	2069	0.2038	5,665	\$1,154	234	\$48	4,293	\$875	10,192	\$2,077	0.05	\$1,567.04	
55	2070	0.2049	5,665	\$1,161	234	\$48	4,293	\$880	10,192	\$2,089	0.05	\$1,579.05	
56	2071	0.2061	5,665	\$1,168	234	\$48	4,293	\$885	10,192	\$2,101	0.05	\$1,591.13	
57	2072	0.2073	5,665	\$1,174	234	\$49	4,293	\$890	10,192	\$2,113	0.05	\$1,603.28	
58	2073	0.2085	5,665	\$1,181	234	\$49	4,293	\$895	10,192	\$2,125	0.05	\$1,615.51	
59	2074	0.2097	5,665	\$1,188	234	\$49	4,293	\$900	10,192	\$2,137	0.05	\$1,627.80	
60	2075	0.2109	5,665	\$1,195	234	\$49	4,293	\$906	10,192	\$2,150	0.05	\$1,640.16	

Table D1-1.49: Annual Operating Costs (V.GSHP) of a 2,000 square feet detached house above grade (average construction type) in the city of Barrie (two life cycles and three life cycles for a 60 year project lifespan); base case scenario in comparison with feed in-tariff (FIT) scenario. In the FIT scenario, an incentive of \$0.05/KWh is provided on electricity bills throughout the project lifespan

Horizontal Ground Source Heat Pump (H.GSHP)

Base Case Scenario											Feed in Tariff (FIT)		
#	Year	H.GSHP									FIT		
		Electricity Rates \$/KWh	Heating KWh	Heating Operating Cost \$	Cooling KWh	Cooling Operating Cost \$	Hot Water KWh	Hot Water Operating Cost \$	Total KWh	Total Operating Cost \$	Incentives (\$/KWh)	\$/KWh	Operating Cost
1	2016	0.1501	5,766	\$865	241	\$36	4,288	\$644	10,295	\$1,545	0.05	0.1001	\$1,030.35
2	2017	0.1542	5,766	\$889	241	\$37	4,288	\$661	10,295	\$1,587	0.05	0.1042	\$1,072.60
3	2018	0.1583	5,766	\$913	241	\$38	4,288	\$679	10,295	\$1,630	0.05	0.1083	\$1,114.85
4	2019	0.1625	5,766	\$937	241	\$39	4,288	\$697	10,295	\$1,673	0.05	0.1125	\$1,158.59
5	2020	0.1668	5,766	\$962	241	\$40	4,288	\$715	10,295	\$1,717	0.05	0.1168	\$1,202.32
6	2021	0.1621	5,766	\$935	241	\$39	4,288	\$695	10,295	\$1,669	0.05	0.1121	\$1,154.51
7	2022	0.1629	5,766	\$939	241	\$39	4,288	\$699	10,295	\$1,677	0.05	0.1129	\$1,162.66
8	2023	0.1639	5,766	\$945	241	\$39	4,288	\$703	10,295	\$1,687	0.05	0.1139	\$1,172.30
9	2024	0.1648	5,766	\$950	241	\$40	4,288	\$707	10,295	\$1,697	0.05	0.1148	\$1,181.93
10	2025	0.1656	5,766	\$955	241	\$40	4,288	\$710	10,295	\$1,705	0.05	0.1156	\$1,190.09
11	2026	0.1665	5,766	\$960	241	\$40	4,288	\$714	10,295	\$1,714	0.05	0.1165	\$1,199.72
12	2027	0.1674	5,766	\$965	241	\$40	4,288	\$718	10,295	\$1,724	0.05	0.1174	\$1,208.99
13	2028	0.1683	5,766	\$970	241	\$41	4,288	\$722	10,295	\$1,732	0.05	0.1183	\$1,217.51
14	2029	0.1692	5,766	\$975	241	\$41	4,288	\$725	10,295	\$1,742	0.05	0.1192	\$1,226.78
15	2030	0.1701	5,766	\$981	241	\$41	4,288	\$729	10,295	\$1,751	0.05	0.1201	\$1,236.42
16	2031	0.1704	5,766	\$982	241	\$41	4,288	\$730	10,295	\$1,754	0.05	0.1204	\$1,239.01
17	2032	0.1705	5,766	\$983	241	\$41	4,288	\$731	10,295	\$1,755	0.05	0.1205	\$1,240.49
18	2033	0.1707	5,766	\$985	241	\$41	4,288	\$732	10,295	\$1,758	0.05	0.1207	\$1,243.09
19	2034	0.1710	5,766	\$986	241	\$41	4,288	\$733	10,295	\$1,761	0.05	0.1210	\$1,246.05
20	2035	0.1713	5,766	\$988	241	\$41	4,288	\$734	10,295	\$1,763	0.05	0.1213	\$1,248.65
21	2036	0.1714	5,766	\$988	241	\$41	4,288	\$735	10,295	\$1,765	0.05	0.1214	\$1,250.13
22	2037	0.1717	5,766	\$990	241	\$41	4,288	\$736	10,295	\$1,767	0.05	0.1217	\$1,252.72
23	2038	0.1720	5,766	\$992	241	\$41	4,288	\$737	10,295	\$1,770	0.05	0.1220	\$1,255.69
24	2039	0.1722	5,766	\$993	241	\$42	4,288	\$738	10,295	\$1,773	0.05	0.1222	\$1,258.28
25	2040	0.1724	5,766	\$994	241	\$42	4,288	\$739	10,295	\$1,775	0.05	0.1224	\$1,259.76
26	2041	0.1734	5,766	\$1,000	241	\$42	4,288	\$743	10,295	\$1,785	0.05	0.1234	\$1,270.03
27	2042	0.1744	5,766	\$1,005	241	\$42	4,288	\$748	10,295	\$1,795	0.05	0.1244	\$1,280.35
28	2043	0.1754	5,766	\$1,011	241	\$42	4,288	\$752	10,295	\$1,805	0.05	0.1254	\$1,290.74
29	2044	0.1764	5,766	\$1,017	241	\$43	4,288	\$756	10,295	\$1,816	0.05	0.1264	\$1,301.18
30	2045	0.1774	5,766	\$1,023	241	\$43	4,288	\$761	10,295	\$1,826	0.05	0.1274	\$1,311.69
31	2046	0.1784	5,766	\$1,029	241	\$43	4,288	\$765	10,295	\$1,837	0.05	0.1284	\$1,322.25
32	2047	0.1795	5,766	\$1,035	241	\$43	4,288	\$770	10,295	\$1,848	0.05	0.1295	\$1,332.88
33	2048	0.1805	5,766	\$1,041	241	\$44	4,288	\$774	10,295	\$1,858	0.05	0.1305	\$1,343.57
34	2049	0.1816	5,766	\$1,047	241	\$44	4,288	\$778	10,295	\$1,869	0.05	0.1316	\$1,354.32
35	2050	0.1826	5,766	\$1,053	241	\$44	4,288	\$783	10,295	\$1,880	0.05	0.1326	\$1,365.13
36	2051	0.1837	5,766	\$1,059	241	\$44	4,288	\$788	10,295	\$1,891	0.05	0.1337	\$1,376.01
37	2052	0.1847	5,766	\$1,065	241	\$45	4,288	\$792	10,295	\$1,902	0.05	0.1347	\$1,386.94
38	2053	0.1858	5,766	\$1,071	241	\$45	4,288	\$797	10,295	\$1,913	0.05	0.1358	\$1,397.95
39	2054	0.1869	5,766	\$1,077	241	\$45	4,288	\$801	10,295	\$1,924	0.05	0.1369	\$1,409.01
40	2055	0.1879	5,766	\$1,084	241	\$45	4,288	\$806	10,295	\$1,935	0.05	0.1379	\$1,420.14
41	2056	0.1890	5,766	\$1,090	241	\$46	4,288	\$811	10,295	\$1,946	0.05	0.1390	\$1,431.33
42	2057	0.1901	5,766	\$1,096	241	\$46	4,288	\$815	10,295	\$1,957	0.05	0.1401	\$1,442.59
43	2058	0.1912	5,766	\$1,103	241	\$46	4,288	\$820	10,295	\$1,969	0.05	0.1412	\$1,453.91
44	2059	0.1923	5,766	\$1,109	241	\$46	4,288	\$825	10,295	\$1,980	0.05	0.1423	\$1,465.30
45	2060	0.1934	5,766	\$1,115	241	\$47	4,288	\$829	10,295	\$1,992	0.05	0.1434	\$1,476.75
46	2061	0.1946	5,766	\$1,122	241	\$47	4,288	\$834	10,295	\$2,003	0.05	0.1446	\$1,488.28
47	2062	0.1957	5,766	\$1,128	241	\$47	4,288	\$839	10,295	\$2,015	0.05	0.1457	\$1,499.86
48	2063	0.1968	5,766	\$1,135	241	\$47	4,288	\$844	10,295	\$2,026	0.05	0.1468	\$1,511.52
49	2064	0.1980	5,766	\$1,141	241	\$48	4,288	\$849	10,295	\$2,038	0.05	0.1480	\$1,523.24
50	2065	0.1991	5,766	\$1,148	241	\$48	4,288	\$854	10,295	\$2,050	0.05	0.1491	\$1,535.03
51	2066	0.2003	5,766	\$1,155	241	\$48	4,288	\$859	10,295	\$2,062	0.05	0.1503	\$1,546.89
52	2067	0.2014	5,766	\$1,161	241	\$49	4,288	\$864	10,295	\$2,074	0.05	0.1514	\$1,558.81
53	2068	0.2026	5,766	\$1,168	241	\$49	4,288	\$869	10,295	\$2,086	0.05	0.1526	\$1,570.81
54	2069	0.2038	5,766	\$1,175	241	\$49	4,288	\$874	10,295	\$2,098	0.05	0.1538	\$1,582.87
55	2070	0.2049	5,766	\$1,182	241	\$49	4,288	\$879	10,295	\$2,110	0.05	0.1549	\$1,595.01
56	2071	0.2061	5,766	\$1,188	241	\$50	4,288	\$884	10,295	\$2,122	0.05	0.1561	\$1,607.21
57	2072	0.2073	5,766	\$1,195	241	\$50	4,288	\$889	10,295	\$2,134	0.05	0.1573	\$1,619.49
58	2073	0.2085	5,766	\$1,202	241	\$50	4,288	\$894	10,295	\$2,147	0.05	0.1585	\$1,631.83
59	2074	0.2097	5,766	\$1,209	241	\$51	4,288	\$899	10,295	\$2,159	0.05	0.1597	\$1,644.25
60	2075	0.2109	5,766	\$1,216	241	\$51	4,288	\$904	10,295	\$2,171	0.05	0.1609	\$1,656.74

Table D1-1.50: Annual Operating Costs (H.GSHP) of a 2,000 square feet detached house above grade (average construction type) in the city of Barrie (two life cycles and three life cycles for a 60 year project lifespan); base case scenario in comparison with feed in-tariff (FIT) scenario. In the FIT scenario, an incentive of \$0.05/KWh is provided on electricity bills throughout the project lifespan

Traditional HVAC Applications

Base Case Scenario															Carbon Taxes							
#	Year	Electricity Rates \$/KWh	Natural Gas Rates \$/m ³	Heating		Heating Operating Cost \$ (Electricity)	Heating Operating Cost \$ (Gas)	Total Heating Operating Cost \$	Cooling		Hot Water m ³	Hot Water Operating Cost \$	Total KWh	Total m ³	Total Electricity Operating Cost \$ (KWh)	Total Natural Gas Operating Cost \$ (m ³)	Total	Conversion of m ³ into Tons	Total Tons	Carbon Tax	Operating Costs	
				KWh (Electricity)	m ³ (Gas)				KWh	\$												
1	2016	0.1501	0.3458	1.593	2,679	\$239	\$926	\$1,166	996	\$149	1.058	\$366	2,589	3,737	389	\$1,292	\$1,681	6.76	6.76	\$10	\$67.64	\$1,748.57
2	2017	0.1542	0.3588	1.593	2,679	\$246	\$961	\$1,207	996	\$154	1.058	\$363	2,589	3,737	399	\$1,341	\$1,740	6.76	6.76	\$20	\$135.28	\$1,875.44
3	2018	0.1583	0.3718	1.593	2,679	\$252	\$996	\$1,248	996	\$158	1.058	\$367	2,589	3,737	410	\$1,390	\$1,799	6.76	6.76	\$30	\$202.92	\$2,002.31
4	2019	0.1625	0.3776	1.593	2,679	\$259	\$1,012	\$1,270	996	\$162	1.058	\$372	2,589	3,737	421	\$1,411	\$1,832	6.76	6.76	\$40	\$270.56	\$2,102.40
5	2020	0.1668	0.3841	1.593	2,679	\$266	\$1,029	\$1,295	996	\$166	1.058	\$376	2,589	3,737	432	\$1,435	\$1,867	6.76	6.76	\$50	\$338.20	\$2,205.34
6	2021	0.1621	0.3883	1.593	2,679	\$258	\$1,040	\$1,299	996	\$161	1.058	\$372	2,589	3,737	420	\$1,451	\$1,871	6.76	6.76	\$60	\$405.84	\$2,276.68
7	2022	0.1629	0.3929	1.593	2,679	\$260	\$1,053	\$1,312	996	\$162	1.058	\$372	2,589	3,737	422	\$1,468	\$1,890	6.76	6.76	\$70	\$473.48	\$2,363.53
8	2023	0.1639	0.3967	1.593	2,679	\$261	\$1,063	\$1,324	996	\$163	1.058	\$373	2,589	3,737	424	\$1,483	\$1,907	6.76	6.76	\$80	\$541.12	\$2,447.88
9	2024	0.1648	0.4005	1.593	2,679	\$263	\$1,073	\$1,336	996	\$164	1.058	\$374	2,589	3,737	427	\$1,497	\$1,923	6.76	6.76	\$90	\$608.76	\$2,532.24
10	2025	0.1656	0.4040	1.593	2,679	\$264	\$1,082	\$1,346	996	\$165	1.058	\$375	2,589	3,737	429	\$1,510	\$1,938	6.76	6.76	\$100	\$676.40	\$2,614.80
11	2026	0.1665	0.4070	1.593	2,679	\$265	\$1,090	\$1,356	996	\$166	1.058	\$376	2,589	3,737	431	\$1,521	\$1,952	6.76	6.76	\$110	\$744.04	\$2,696.30
12	2027	0.1674	0.4097	1.593	2,679	\$267	\$1,098	\$1,364	996	\$167	1.058	\$377	2,589	3,737	433	\$1,531	\$1,965	6.76	6.76	\$120	\$811.68	\$2,776.28
13	2028	0.1683	0.4124	1.593	2,679	\$268	\$1,105	\$1,373	996	\$168	1.058	\$378	2,589	3,737	436	\$1,541	\$1,977	6.76	6.76	\$130	\$879.32	\$2,856.07
14	2029	0.1692	0.4151	1.593	2,679	\$269	\$1,112	\$1,381	996	\$168	1.058	\$379	2,589	3,737	438	\$1,551	\$1,989	6.76	6.76	\$140	\$946.96	\$2,936.04
15	2030	0.1701	0.4170	1.593	2,679	\$271	\$1,117	\$1,388	996	\$169	1.058	\$380	2,589	3,737	440	\$1,558	\$1,999	6.76	6.76	\$150	\$1,014.60	\$3,013.26
16	2031	0.1704	0.4189	1.593	2,679	\$271	\$1,122	\$1,394	996	\$170	1.058	\$380	2,589	3,737	441	\$1,565	\$2,006	6.76	6.76	\$160	\$1,082.24	\$3,088.70
17	2032	0.1705	0.4204	1.593	2,679	\$272	\$1,126	\$1,398	996	\$170	1.058	\$380	2,589	3,737	441	\$1,571	\$2,013	6.76	6.76	\$170	\$1,149.87	\$3,162.43
18	2033	0.1707	0.4223	1.593	2,679	\$272	\$1,131	\$1,403	996	\$170	1.058	\$381	2,589	3,737	442	\$1,578	\$2,020	6.76	6.76	\$180	\$1,217.51	\$3,237.87
19	2034	0.1710	0.4246	1.593	2,679	\$272	\$1,138	\$1,410	996	\$170	1.058	\$381	2,589	3,737	443	\$1,587	\$2,030	6.76	6.76	\$190	\$1,285.15	\$3,314.83
20	2035	0.1713	0.4265	1.593	2,679	\$273	\$1,143	\$1,416	996	\$171	1.058	\$381	2,589	3,737	443	\$1,594	\$2,037	6.76	6.76	\$200	\$1,352.79	\$3,390.27
21	2036	0.1714	0.4288	1.593	2,679	\$273	\$1,149	\$1,422	996	\$171	1.058	\$381	2,589	3,737	444	\$1,603	\$2,046	6.76	6.76	\$210	\$1,420.43	\$3,466.86
22	2037	0.1717	0.4311	1.593	2,679	\$273	\$1,155	\$1,429	996	\$171	1.058	\$382	2,589	3,737	444	\$1,611	\$2,056	6.76	6.76	\$220	\$1,488.07	\$3,543.73
23	2038	0.1720	0.4331	1.593	2,679	\$274	\$1,160	\$1,434	996	\$171	1.058	\$382	2,589	3,737	445	\$1,618	\$2,064	6.76	6.76	\$230	\$1,555.71	\$3,619.26
24	2039	0.1722	0.4353	1.593	2,679	\$274	\$1,166	\$1,441	996	\$172	1.058	\$382	2,589	3,737	446	\$1,627	\$2,073	6.76	6.76	\$240	\$1,623.35	\$3,696.13
25	2040	0.1724	0.4376	1.593	2,679	\$275	\$1,172	\$1,447	996	\$172	1.058	\$382	2,589	3,737	446	\$1,635	\$2,082	6.76	6.76	\$250	\$1,690.99	\$3,772.72
26	2041	0.1734	0.4420	1.593	2,679	\$276	\$1,184	\$1,460	996	\$173	1.058	\$383	2,589	3,737	449	\$1,652	\$2,100	6.76	6.76	\$260	\$1,758.63	\$3,850.07
27	2042	0.1744	0.4463	1.593	2,679	\$278	\$1,196	\$1,473	996	\$174	1.058	\$384	2,589	3,737	451	\$1,668	\$2,119	6.76	6.76	\$270	\$1,826.27	\$3,945.59
28	2043	0.1754	0.4507	1.593	2,679	\$279	\$1,207	\$1,487	996	\$175	1.058	\$386	2,589	3,737	454	\$1,684	\$2,138	6.76	6.76	\$280	\$1,893.91	\$4,032.28
29	2044	0.1764	0.4552	1.593	2,679	\$281	\$1,219	\$1,500	996	\$176	1.058	\$387	2,589	3,737	457	\$1,701	\$2,158	6.76	6.76	\$290	\$1,961.55	\$4,119.15
30	2045	0.1774	0.4596	1.593	2,679	\$283	\$1,231	\$1,514	996	\$177	1.058	\$388	2,589	3,737	459	\$1,718	\$2,177	6.76	6.76	\$300	\$2,029.19	\$4,206.21
31	2046	0.1784	0.4642	1.593	2,679	\$284	\$1,244	\$1,528	996	\$178	1.058	\$389	2,589	3,737	462	\$1,735	\$2,197	6.76	6.76	\$310	\$2,096.83	\$4,293.44
32	2047	0.1795	0.4688	1.593	2,679	\$286	\$1,256	\$1,542	996	\$179	1.058	\$390	2,589	3,737	465	\$1,752	\$2,216	6.76	6.76	\$320	\$2,164.47	\$4,380.85
33	2048	0.1805	0.4734	1.593	2,679	\$288	\$1,268	\$1,556	996	\$180	1.058	\$391	2,589	3,737	467	\$1,769	\$2,236	6.76	6.76	\$330	\$2,232.11	\$4,468.45
34	2049	0.1816	0.4780	1.593	2,679	\$289	\$1,281	\$1,570	996	\$181	1.058	\$392	2,589	3,737	470	\$1,786	\$2,256	6.76	6.76	\$340	\$2,299.75	\$4,556.23
35	2050	0.1826	0.4828	1.593	2,679	\$291	\$1,293	\$1,584	996	\$182	1.058	\$393	2,589	3,737	473	\$1,804	\$2,277	6.76	6.76	\$350	\$2,367.39	\$4,644.20
36	2051	0.1837	0.4875	1.593	2,679	\$293	\$1,306	\$1,599	996	\$183	1.058	\$394	2,589	3,737	475	\$1,822	\$2,297	6.76	6.76	\$360	\$2,435.03	\$4,732.36
37	2052	0.1847	0.4923	1.593	2,679	\$294	\$1,319	\$1,613	996	\$184	1.058	\$395	2,589	3,737	478	\$1,840	\$2,318	6.76	6.76	\$370	\$2,502.67	\$4,820.72
38	2053	0.1858	0.4972	1.593	2,679	\$296	\$1,332	\$1,628	996	\$185	1.058	\$397	2,589	3,737	481	\$1,858	\$2,339	6.76	6.76	\$380	\$2,570.31	\$4,909.26
39	2054	0.1869	0.5021	1.593	2,679	\$298	\$1,345	\$1,643	996	\$186	1.058	\$398	2,589	3,737	484	\$1,876	\$2,360	6.76	6.76	\$390	\$2,637.95	\$4,998.00
40	2055	0.1879	0.5070	1.593	2,679	\$299	\$1,358	\$1,658	996	\$187	1.058	\$399	2,589	3,737	487	\$1,895	\$2,381	6.76	6.76	\$400	\$2,705.59	\$5,086.94
41	2056	0.1890	0.5120	1.593	2,679	\$301	\$1,372	\$1,673	996	\$188	1.058	\$400	2,589	3,737	489	\$1,913	\$2,403	6.76	6.76	\$410	\$2,773.23	\$5,176.07
42	2057	0.1901	0.5171	1.593	2,679	\$303	\$1,385	\$1,688	996	\$189	1.058	\$401	2,589	3,737	492	\$1,932	\$2,425	6.76	6.76	\$420	\$2,840.87	\$5,265.41
43	2058	0.1912	0.5222	1.593	2,679	\$305	\$1,399	\$1,704	996	\$190	1.058	\$402	2,589	3,737	495	\$1,951	\$2,446	6.76	6.76	\$430	\$2,908.51	\$5,354.95
44	2059	0.1923	0.5273	1.593	2,679	\$306	\$1,413	\$1,719	996	\$192	1.058	\$403	2,589	3,737	498	\$1,971	\$2,469	6.76	6.76	\$440	\$2,976.15	\$5,444.69
45	2060	0.1934	0.5325	1.593	2,679	\$308	\$1,427	\$1,735	996	\$193	1.058	\$405	2,589	3,737	501	\$1,990	\$2,491	6.76	6.76	\$450	\$3,043.79	\$5,534.64
46	2061	0.1946	0.5378	1.593	2,679	\$310	\$1,441	\$1,751	996	\$194	1.058	\$406	2,589	3,737	504	\$2,010	\$2,513	6.76	6.76	\$460	\$3,111.43	\$5,624.79
47	2062	0.1957	0.5431	1.593	2,679	\$312	\$1,455	\$1,767	996	\$195	1.058	\$407	2,589	3,737	507	\$2,029	\$2,536	6.76	6.76	\$470	\$3,179.07	\$5,715.16
48	2063	0.1968	0.5484	1.593	2,679	\$314	\$1,469	\$1,783	996	\$196	1.058	\$408	2,589	3,737	510	\$2,049	\$2,559	6.76	6.76	\$480	\$3,246.71	\$5,805.74
49	2064	0.1980	0.5538	1.593	2,679	\$315	\$1,484	\$1,799	996	\$197	1.058	\$409	2,589	3,737	513	\$2,070	\$2,582	6.76	6.76	\$490	\$3,314.35	\$5,896.53
50	2065	0.1991	0.5593	1.593	2,679	\$317	\$1,498	\$1,816	996	\$198	1.058	\$411	2,589	3,737	515	\$2,090	\$2,606	6.76	6.76	\$500	\$3,381.99	\$5,987.54
51	2066	0.2003	0.5648	1.593	2,679	\$319	\$1,513	\$1,832	996	\$199	1.058	\$412	2,589	3,737	518	\$2,111	\$2,629	6.76	6.76	\$510	\$3,449.62	\$6,078.77
52	2067	0.2014	0.5704	1.593	2,679	\$321	\$1,528	\$1,849	996	\$201	1.058	\$413	2,589	3,737	521	\$2,131	\$2,653	6.76	6.76	\$520	\$3,517.26	\$6,170.22
53	2068	0.2026	0.5760	1.593	2,679	\$323	\$1,543	\$1,866	996	\$202	1.058	\$414	2,589	3,737	524	\$2,153	\$2,677	6.76	6.76	\$530	\$3,584.90	\$6,261.89
54	2069	0.2038																				

18. Muskoka (Distinct) – Annual Operating Costs

Vertical Ground Source Heat Pump (V.GSHP)

Base Case Scenario											Feed in Tariff (FIT)			
#	Year	Electricity Rates		Heating Operating Cost		Cooling Operating Cost		Hot Water Operating Cost		Total	Total Operating Cost	Incentives (\$/KWh)	FIT	
		\$/KWh	KWh	\$	KWh	\$	KWh	\$	KWh				\$	Operating Cost
1	2016	0.1501	6,272	\$941	239	\$36	4,132	\$620	10,643	\$1,597	0.05	0.1001	\$1,065.18	
2	2017	0.1542	6,272	\$967	239	\$37	4,132	\$637	10,643	\$1,641	0.05	0.1042	\$1,108.86	
3	2018	0.1583	6,272	\$993	239	\$38	4,132	\$654	10,643	\$1,685	0.05	0.1083	\$1,152.54	
4	2019	0.1625	6,272	\$1,019	239	\$39	4,132	\$672	10,643	\$1,730	0.05	0.1125	\$1,197.75	
5	2020	0.1668	6,272	\$1,046	239	\$40	4,132	\$689	10,643	\$1,775	0.05	0.1168	\$1,242.96	
6	2021	0.1621	6,272	\$1,017	239	\$39	4,132	\$670	10,643	\$1,726	0.05	0.1121	\$1,193.53	
7	2022	0.1629	6,272	\$1,022	239	\$39	4,132	\$673	10,643	\$1,734	0.05	0.1129	\$1,201.96	
8	2023	0.1639	6,272	\$1,028	239	\$39	4,132	\$677	10,643	\$1,744	0.05	0.1139	\$1,211.93	
9	2024	0.1648	6,272	\$1,034	239	\$39	4,132	\$681	10,643	\$1,754	0.05	0.1148	\$1,221.89	
10	2025	0.1656	6,272	\$1,039	239	\$40	4,132	\$684	10,643	\$1,762	0.05	0.1156	\$1,230.32	
11	2026	0.1665	6,272	\$1,045	239	\$40	4,132	\$688	10,643	\$1,772	0.05	0.1165	\$1,240.28	
12	2027	0.1674	6,272	\$1,050	239	\$40	4,132	\$692	10,643	\$1,782	0.05	0.1174	\$1,249.86	
13	2028	0.1683	6,272	\$1,055	239	\$40	4,132	\$695	10,643	\$1,791	0.05	0.1183	\$1,258.67	
14	2029	0.1692	6,272	\$1,061	239	\$40	4,132	\$699	10,643	\$1,800	0.05	0.1192	\$1,268.25	
15	2030	0.1701	6,272	\$1,067	239	\$41	4,132	\$703	10,643	\$1,810	0.05	0.1201	\$1,278.21	
16	2031	0.1704	6,272	\$1,068	239	\$41	4,132	\$704	10,643	\$1,813	0.05	0.1204	\$1,280.89	
17	2032	0.1705	6,272	\$1,069	239	\$41	4,132	\$704	10,643	\$1,815	0.05	0.1205	\$1,282.42	
18	2033	0.1707	6,272	\$1,071	239	\$41	4,132	\$706	10,643	\$1,817	0.05	0.1207	\$1,285.11	
19	2034	0.1710	6,272	\$1,073	239	\$41	4,132	\$707	10,643	\$1,820	0.05	0.1210	\$1,288.17	
20	2035	0.1713	6,272	\$1,074	239	\$41	4,132	\$708	10,643	\$1,823	0.05	0.1213	\$1,290.85	
21	2036	0.1714	6,272	\$1,075	239	\$41	4,132	\$708	10,643	\$1,825	0.05	0.1214	\$1,292.39	
22	2037	0.1717	6,272	\$1,077	239	\$41	4,132	\$709	10,643	\$1,827	0.05	0.1217	\$1,295.07	
23	2038	0.1720	6,272	\$1,079	239	\$41	4,132	\$711	10,643	\$1,830	0.05	0.1220	\$1,298.13	
24	2039	0.1722	6,272	\$1,080	239	\$41	4,132	\$712	10,643	\$1,833	0.05	0.1222	\$1,300.82	
25	2040	0.1724	6,272	\$1,081	239	\$41	4,132	\$712	10,643	\$1,834	0.05	0.1224	\$1,302.35	
26	2041	0.1734	6,272	\$1,087	239	\$41	4,132	\$716	10,643	\$1,845	0.05	0.1234	\$1,312.96	
27	2042	0.1744	6,272	\$1,094	239	\$42	4,132	\$720	10,643	\$1,856	0.05	0.1244	\$1,323.63	
28	2043	0.1754	6,272	\$1,100	239	\$42	4,132	\$725	10,643	\$1,867	0.05	0.1254	\$1,334.37	
29	2044	0.1764	6,272	\$1,106	239	\$42	4,132	\$729	10,643	\$1,877	0.05	0.1264	\$1,345.17	
30	2045	0.1774	6,272	\$1,113	239	\$42	4,132	\$733	10,643	\$1,888	0.05	0.1274	\$1,356.03	
31	2046	0.1784	6,272	\$1,119	239	\$43	4,132	\$737	10,643	\$1,899	0.05	0.1284	\$1,366.95	
32	2047	0.1795	6,272	\$1,126	239	\$43	4,132	\$742	10,643	\$1,910	0.05	0.1295	\$1,377.94	
33	2048	0.1805	6,272	\$1,132	239	\$43	4,132	\$746	10,643	\$1,921	0.05	0.1305	\$1,388.99	
34	2049	0.1816	6,272	\$1,139	239	\$43	4,132	\$750	10,643	\$1,932	0.05	0.1316	\$1,400.10	
35	2050	0.1826	6,272	\$1,145	239	\$44	4,132	\$755	10,643	\$1,943	0.05	0.1326	\$1,411.28	
36	2051	0.1837	6,272	\$1,152	239	\$44	4,132	\$759	10,643	\$1,955	0.05	0.1337	\$1,422.52	
37	2052	0.1847	6,272	\$1,159	239	\$44	4,132	\$763	10,643	\$1,966	0.05	0.1347	\$1,433.83	
38	2053	0.1858	6,272	\$1,165	239	\$44	4,132	\$768	10,643	\$1,977	0.05	0.1358	\$1,445.20	
39	2054	0.1869	6,272	\$1,172	239	\$45	4,132	\$772	10,643	\$1,989	0.05	0.1369	\$1,456.64	
40	2055	0.1879	6,272	\$1,179	239	\$45	4,132	\$777	10,643	\$2,000	0.05	0.1379	\$1,468.14	
41	2056	0.1890	6,272	\$1,186	239	\$45	4,132	\$781	10,643	\$2,012	0.05	0.1390	\$1,479.71	
42	2057	0.1901	6,272	\$1,192	239	\$45	4,132	\$786	10,643	\$2,024	0.05	0.1401	\$1,491.35	
43	2058	0.1912	6,272	\$1,199	239	\$46	4,132	\$790	10,643	\$2,035	0.05	0.1412	\$1,503.06	
44	2059	0.1923	6,272	\$1,206	239	\$46	4,132	\$795	10,643	\$2,047	0.05	0.1423	\$1,514.83	
45	2060	0.1934	6,272	\$1,213	239	\$46	4,132	\$799	10,643	\$2,059	0.05	0.1434	\$1,526.67	
46	2061	0.1946	6,272	\$1,220	239	\$47	4,132	\$804	10,643	\$2,071	0.05	0.1446	\$1,538.58	
47	2062	0.1957	6,272	\$1,227	239	\$47	4,132	\$809	10,643	\$2,083	0.05	0.1457	\$1,550.56	
48	2063	0.1968	6,272	\$1,234	239	\$47	4,132	\$813	10,643	\$2,095	0.05	0.1468	\$1,562.61	
49	2064	0.1980	6,272	\$1,242	239	\$47	4,132	\$818	10,643	\$2,107	0.05	0.1480	\$1,574.73	
50	2065	0.1991	6,272	\$1,249	239	\$48	4,132	\$823	10,643	\$2,119	0.05	0.1491	\$1,586.92	
51	2066	0.2003	6,272	\$1,256	239	\$48	4,132	\$827	10,643	\$2,131	0.05	0.1503	\$1,599.17	
52	2067	0.2014	6,272	\$1,263	239	\$48	4,132	\$832	10,643	\$2,144	0.05	0.1514	\$1,611.50	
53	2068	0.2026	6,272	\$1,271	239	\$48	4,132	\$837	10,643	\$2,156	0.05	0.1526	\$1,623.91	
54	2069	0.2038	6,272	\$1,278	239	\$49	4,132	\$842	10,643	\$2,169	0.05	0.1538	\$1,636.38	
55	2070	0.2049	6,272	\$1,285	239	\$49	4,132	\$847	10,643	\$2,181	0.05	0.1549	\$1,648.92	
56	2071	0.2061	6,272	\$1,293	239	\$49	4,132	\$852	10,643	\$2,194	0.05	0.1561	\$1,661.54	
57	2072	0.2073	6,272	\$1,300	239	\$50	4,132	\$857	10,643	\$2,206	0.05	0.1573	\$1,674.23	
58	2073	0.2085	6,272	\$1,308	239	\$50	4,132	\$862	10,643	\$2,219	0.05	0.1585	\$1,686.99	
59	2074	0.2097	6,272	\$1,315	239	\$50	4,132	\$867	10,643	\$2,232	0.05	0.1597	\$1,699.83	
60	2075	0.2109	6,272	\$1,323	239	\$50	4,132	\$872	10,643	\$2,245	0.05	0.1609	\$1,712.74	

Table D1-1.52: Annual Operating Costs (V.GSHP) of a 2,000 square feet detached house above grade (average construction type) in the city of Muskoka (two life cycles and three life cycles for a 60 year project lifespan); base case scenario in comparison with feed-in-tariff (FIT) scenario. In the FIT scenario, an incentive of \$0.05/KWh is provided on electricity bills throughout the project lifespan

Horizontal Ground Source Heat Pump (H.GSHP)

Base Case Scenario											Feed in Tariff (FIT)		
H.GSHP											FIT		
#	Year	Electricity Rates \$/KWh	Heating KWh	Heating Operating Cost \$	Cooling KWh	Cooling Operating Cost \$	Hot Water KWh	Hot Water Operating Cost \$	Total KWh	Total Operating Cost \$	Incentives (\$/KWh)	S/KWh	Operating Cost
1	2016	0.1501	6,376	\$957	246	\$37	4,126	\$619	10,748	\$1,613	0.05	0.1001	\$1,075.69
2	2017	0.1542	6,376	\$983	246	\$38	4,126	\$636	10,748	\$1,657	0.05	0.1042	\$1,119.80
3	2018	0.1583	6,376	\$1,009	246	\$39	4,126	\$653	10,748	\$1,701	0.05	0.1083	\$1,163.91
4	2019	0.1625	6,376	\$1,036	246	\$40	4,126	\$671	10,748	\$1,747	0.05	0.1125	\$1,209.57
5	2020	0.1668	6,376	\$1,063	246	\$41	4,126	\$688	10,748	\$1,793	0.05	0.1168	\$1,255.22
6	2021	0.1621	6,376	\$1,034	246	\$40	4,126	\$669	10,748	\$1,743	0.05	0.1121	\$1,205.31
7	2022	0.1629	6,376	\$1,039	246	\$40	4,126	\$672	10,748	\$1,751	0.05	0.1129	\$1,213.82
8	2023	0.1639	6,376	\$1,045	246	\$40	4,126	\$676	10,748	\$1,761	0.05	0.1139	\$1,223.88
9	2024	0.1648	6,376	\$1,051	246	\$41	4,126	\$680	10,748	\$1,771	0.05	0.1148	\$1,233.94
10	2025	0.1656	6,376	\$1,056	246	\$41	4,126	\$683	10,748	\$1,780	0.05	0.1156	\$1,242.45
11	2026	0.1665	6,376	\$1,062	246	\$41	4,126	\$687	10,748	\$1,790	0.05	0.1165	\$1,252.51
12	2027	0.1674	6,376	\$1,068	246	\$41	4,126	\$691	10,748	\$1,800	0.05	0.1174	\$1,262.19
13	2028	0.1683	6,376	\$1,073	246	\$41	4,126	\$694	10,748	\$1,808	0.05	0.1183	\$1,271.09
14	2029	0.1692	6,376	\$1,079	246	\$42	4,126	\$698	10,748	\$1,818	0.05	0.1192	\$1,280.76
15	2030	0.1701	6,376	\$1,085	246	\$42	4,126	\$702	10,748	\$1,828	0.05	0.1201	\$1,290.82
16	2031	0.1704	6,376	\$1,086	246	\$42	4,126	\$703	10,748	\$1,831	0.05	0.1204	\$1,293.53
17	2032	0.1705	6,376	\$1,087	246	\$42	4,126	\$703	10,748	\$1,832	0.05	0.1205	\$1,295.08
18	2033	0.1707	6,376	\$1,089	246	\$42	4,126	\$705	10,748	\$1,835	0.05	0.1207	\$1,297.78
19	2034	0.1710	6,376	\$1,091	246	\$42	4,126	\$706	10,748	\$1,838	0.05	0.1210	\$1,300.88
20	2035	0.1713	6,376	\$1,092	246	\$42	4,126	\$707	10,748	\$1,841	0.05	0.1213	\$1,303.59
21	2036	0.1714	6,376	\$1,093	246	\$42	4,126	\$707	10,748	\$1,843	0.05	0.1214	\$1,305.14
22	2037	0.1717	6,376	\$1,095	246	\$42	4,126	\$708	10,748	\$1,845	0.05	0.1217	\$1,307.84
23	2038	0.1720	6,376	\$1,096	246	\$42	4,126	\$710	10,748	\$1,848	0.05	0.1220	\$1,310.94
24	2039	0.1722	6,376	\$1,098	246	\$42	4,126	\$711	10,748	\$1,851	0.05	0.1222	\$1,313.65
25	2040	0.1724	6,376	\$1,099	246	\$42	4,126	\$711	10,748	\$1,853	0.05	0.1224	\$1,315.20
26	2041	0.1734	6,376	\$1,105	246	\$43	4,126	\$715	10,748	\$1,863	0.05	0.1234	\$1,325.91
27	2042	0.1744	6,376	\$1,112	246	\$43	4,126	\$719	10,748	\$1,874	0.05	0.1244	\$1,336.69
28	2043	0.1754	6,376	\$1,118	246	\$43	4,126	\$724	10,748	\$1,885	0.05	0.1254	\$1,347.53
29	2044	0.1764	6,376	\$1,125	246	\$43	4,126	\$728	10,748	\$1,896	0.05	0.1264	\$1,358.44
30	2045	0.1774	6,376	\$1,131	246	\$44	4,126	\$732	10,748	\$1,907	0.05	0.1274	\$1,369.41
31	2046	0.1784	6,376	\$1,138	246	\$44	4,126	\$736	10,748	\$1,918	0.05	0.1284	\$1,380.44
32	2047	0.1795	6,376	\$1,144	246	\$44	4,126	\$740	10,748	\$1,929	0.05	0.1295	\$1,391.53
33	2048	0.1805	6,376	\$1,151	246	\$44	4,126	\$745	10,748	\$1,940	0.05	0.1305	\$1,402.69
34	2049	0.1816	6,376	\$1,158	246	\$45	4,126	\$749	10,748	\$1,951	0.05	0.1316	\$1,413.91
35	2050	0.1826	6,376	\$1,164	246	\$45	4,126	\$753	10,748	\$1,963	0.05	0.1326	\$1,425.20
36	2051	0.1837	6,376	\$1,171	246	\$45	4,126	\$758	10,748	\$1,974	0.05	0.1337	\$1,436.55
37	2052	0.1847	6,376	\$1,178	246	\$45	4,126	\$762	10,748	\$1,985	0.05	0.1347	\$1,447.97
38	2053	0.1858	6,376	\$1,185	246	\$46	4,126	\$767	10,748	\$1,997	0.05	0.1358	\$1,459.46
39	2054	0.1869	6,376	\$1,191	246	\$46	4,126	\$771	10,748	\$2,008	0.05	0.1369	\$1,471.01
40	2055	0.1879	6,376	\$1,198	246	\$46	4,126	\$775	10,748	\$2,020	0.05	0.1379	\$1,482.63
41	2056	0.1890	6,376	\$1,205	246	\$47	4,126	\$780	10,748	\$2,032	0.05	0.1390	\$1,494.31
42	2057	0.1901	6,376	\$1,212	246	\$47	4,126	\$784	10,748	\$2,043	0.05	0.1401	\$1,506.07
43	2058	0.1912	6,376	\$1,219	246	\$47	4,126	\$789	10,748	\$2,055	0.05	0.1412	\$1,517.89
44	2059	0.1923	6,376	\$1,226	246	\$47	4,126	\$794	10,748	\$2,067	0.05	0.1423	\$1,529.78
45	2060	0.1934	6,376	\$1,233	246	\$48	4,126	\$798	10,748	\$2,079	0.05	0.1434	\$1,541.74
46	2061	0.1946	6,376	\$1,241	246	\$48	4,126	\$803	10,748	\$2,091	0.05	0.1446	\$1,553.76
47	2062	0.1957	6,376	\$1,248	246	\$48	4,126	\$807	10,748	\$2,103	0.05	0.1457	\$1,565.86
48	2063	0.1968	6,376	\$1,255	246	\$48	4,126	\$812	10,748	\$2,115	0.05	0.1468	\$1,578.03
49	2064	0.1980	6,376	\$1,262	246	\$49	4,126	\$817	10,748	\$2,128	0.05	0.1480	\$1,590.26
50	2065	0.1991	6,376	\$1,269	246	\$49	4,126	\$822	10,748	\$2,140	0.05	0.1491	\$1,602.57
51	2066	0.2003	6,376	\$1,277	246	\$49	4,126	\$826	10,748	\$2,152	0.05	0.1503	\$1,614.95
52	2067	0.2014	6,376	\$1,284	246	\$50	4,126	\$831	10,748	\$2,165	0.05	0.1514	\$1,627.40
53	2068	0.2026	6,376	\$1,292	246	\$50	4,126	\$836	10,748	\$2,177	0.05	0.1526	\$1,639.93
54	2069	0.2038	6,376	\$1,299	246	\$50	4,126	\$841	10,748	\$2,190	0.05	0.1538	\$1,652.52
55	2070	0.2049	6,376	\$1,307	246	\$50	4,126	\$846	10,748	\$2,203	0.05	0.1549	\$1,665.19
56	2071	0.2061	6,376	\$1,314	246	\$51	4,126	\$850	10,748	\$2,215	0.05	0.1561	\$1,677.93
57	2072	0.2073	6,376	\$1,322	246	\$51	4,126	\$855	10,748	\$2,228	0.05	0.1573	\$1,690.75
58	2073	0.2085	6,376	\$1,329	246	\$51	4,126	\$860	10,748	\$2,241	0.05	0.1585	\$1,703.64
59	2074	0.2097	6,376	\$1,337	246	\$52	4,126	\$865	10,748	\$2,254	0.05	0.1597	\$1,716.60
60	2075	0.2109	6,376	\$1,345	246	\$52	4,126	\$870	10,748	\$2,267	0.05	0.1609	\$1,729.64

Table D1-1.53: Annual Operating Costs (H.GSHP) of a 2,000 square feet detached house above grade (average construction type) in the city of Muskoka (two life cycles and three life cycles for a 60 year project lifespan); base case scenario in comparison with feed-in-tariff (FIT) scenario. In the FIT scenario, an incentive of \$0.05/KWh is provided on electricity bills throughout the project lifespan

Traditional HVAC Applications

Base Case Scenario															Carbon Taxes							
#	Year	Electricity Rates \$/KWh	Natural Gas Rates \$/m ³	Traditional										Total	Conversion of m ³ into Tons	Total Tons	Carbon Tax	Operating Costs				
				Heating		Heating Operating Cost \$ (Electricity)	Heating Operating Cost \$ (Gas)	Total Heating Operating Cost \$	Cooling		Hot Water m ³	Hot Water Operating Cost \$	Total KWh						Total m ³	Total Electricity Operating Cost \$ (KWh)	Total Natural Gas Operating Cost \$ (m ³)	
				KWh (Electricity)	m ³ (Gas)				KWh	\$												
1	2016	0.1501	0.3458	1,760	2,951	\$264	\$1,021	\$1,285	1,052	\$158	1,067	\$369	2,812	4,018	422	\$1,390	\$1,812	7.27	7.27	\$10	\$72.73	\$1,884.30
2	2017	0.1542	0.3588	1,760	2,951	\$271	\$1,059	\$1,330	1,052	\$162	1,067	\$165	2,812	4,018	434	\$1,442	\$1,875	7.27	7.27	\$20	\$145.45	\$2,020.83
3	2018	0.1583	0.3718	1,760	2,951	\$279	\$1,097	\$1,376	1,052	\$167	1,067	\$169	2,812	4,018	445	\$1,494	\$1,939	7.27	7.27	\$30	\$218.18	\$2,157.36
4	2019	0.1625	0.3776	1,760	2,951	\$286	\$1,114	\$1,400	1,052	\$171	1,067	\$173	2,812	4,018	457	\$1,517	\$1,974	7.27	7.27	\$40	\$290.90	\$2,265.09
5	2020	0.1668	0.3841	1,760	2,951	\$294	\$1,133	\$1,427	1,052	\$175	1,067	\$178	2,812	4,018	469	\$1,543	\$2,012	7.27	7.27	\$50	\$363.63	\$2,375.89
6	2021	0.1621	0.3883	1,760	2,951	\$285	\$1,146	\$1,431	1,052	\$171	1,067	\$173	2,812	4,018	456	\$1,560	\$2,016	7.27	7.27	\$60	\$436.35	\$2,452.46
7	2022	0.1629	0.3929	1,760	2,951	\$287	\$1,159	\$1,446	1,052	\$171	1,067	\$174	2,812	4,018	458	\$1,579	\$2,037	7.27	7.27	\$70	\$509.08	\$2,545.86
8	2023	0.1639	0.3967	1,760	2,951	\$288	\$1,171	\$1,459	1,052	\$172	1,067	\$175	2,812	4,018	461	\$1,594	\$2,055	7.27	7.27	\$80	\$581.81	\$2,636.59
9	2024	0.1648	0.4005	1,760	2,951	\$290	\$1,182	\$1,472	1,052	\$173	1,067	\$176	2,812	4,018	463	\$1,609	\$2,073	7.27	7.27	\$90	\$654.53	\$2,727.32
10	2025	0.1656	0.4040	1,760	2,951	\$291	\$1,192	\$1,484	1,052	\$174	1,067	\$177	2,812	4,018	466	\$1,623	\$2,089	7.27	7.27	\$100	\$727.26	\$2,816.11
11	2026	0.1665	0.4070	1,760	2,951	\$293	\$1,201	\$1,494	1,052	\$175	1,067	\$178	2,812	4,018	468	\$1,635	\$2,104	7.27	7.27	\$110	\$799.98	\$2,903.76
12	2027	0.1674	0.4097	1,760	2,951	\$295	\$1,209	\$1,504	1,052	\$176	1,067	\$179	2,812	4,018	471	\$1,646	\$2,117	7.27	7.27	\$120	\$872.71	\$2,989.78
13	2028	0.1683	0.4124	1,760	2,951	\$296	\$1,217	\$1,513	1,052	\$177	1,067	\$180	2,812	4,018	473	\$1,657	\$2,130	7.27	7.27	\$130	\$945.44	\$3,075.59
14	2029	0.1692	0.4151	1,760	2,951	\$298	\$1,225	\$1,523	1,052	\$178	1,067	\$180	2,812	4,018	476	\$1,668	\$2,143	7.27	7.27	\$140	\$1,018.16	\$3,161.61
15	2030	0.1701	0.4170	1,760	2,951	\$299	\$1,231	\$1,530	1,052	\$179	1,067	\$181	2,812	4,018	478	\$1,675	\$2,154	7.27	7.27	\$150	\$1,090.89	\$3,244.66
16	2031	0.1704	0.4189	1,760	2,951	\$300	\$1,236	\$1,536	1,052	\$179	1,067	\$182	2,812	4,018	479	\$1,683	\$2,162	7.27	7.27	\$160	\$1,163.61	\$3,325.77
17	2032	0.1705	0.4204	1,760	2,951	\$300	\$1,241	\$1,541	1,052	\$179	1,067	\$182	2,812	4,018	479	\$1,689	\$2,169	7.27	7.27	\$170	\$1,236.34	\$3,405.05
18	2033	0.1707	0.4223	1,760	2,951	\$301	\$1,246	\$1,547	1,052	\$180	1,067	\$182	2,812	4,018	480	\$1,697	\$2,177	7.27	7.27	\$180	\$1,309.06	\$3,486.17
19	2034	0.1710	0.4246	1,760	2,951	\$301	\$1,253	\$1,554	1,052	\$180	1,067	\$182	2,812	4,018	481	\$1,706	\$2,187	7.27	7.27	\$190	\$1,381.79	\$3,568.93
20	2035	0.1713	0.4265	1,760	2,951	\$301	\$1,259	\$1,560	1,052	\$180	1,067	\$183	2,812	4,018	482	\$1,714	\$2,196	7.27	7.27	\$200	\$1,454.52	\$3,650.05
21	2036	0.1714	0.4288	1,760	2,951	\$302	\$1,266	\$1,567	1,052	\$180	1,067	\$183	2,812	4,018	482	\$1,723	\$2,205	7.27	7.27	\$210	\$1,527.24	\$3,732.40
22	2037	0.1717	0.4311	1,760	2,951	\$302	\$1,272	\$1,574	1,052	\$181	1,067	\$183	2,812	4,018	483	\$1,732	\$2,215	7.27	7.27	\$220	\$1,599.97	\$3,815.06
23	2038	0.1720	0.4331	1,760	2,951	\$303	\$1,278	\$1,581	1,052	\$181	1,067	\$183	2,812	4,018	484	\$1,740	\$2,224	7.27	7.27	\$230	\$1,672.69	\$3,896.28
24	2039	0.1722	0.4353	1,760	2,951	\$303	\$1,285	\$1,588	1,052	\$181	1,067	\$184	2,812	4,018	484	\$1,749	\$2,234	7.27	7.27	\$240	\$1,745.42	\$3,978.94
25	2040	0.1724	0.4376	1,760	2,951	\$303	\$1,291	\$1,595	1,052	\$181	1,067	\$184	2,812	4,018	485	\$1,758	\$2,243	7.27	7.27	\$250	\$1,818.15	\$4,061.29
26	2041	0.1734	0.4420	1,760	2,951	\$305	\$1,304	\$1,609	1,052	\$182	1,067	\$185	2,812	4,018	487	\$1,776	\$2,263	7.27	7.27	\$260	\$1,890.87	\$4,144.16
27	2042	0.1744	0.4463	1,760	2,951	\$307	\$1,317	\$1,624	1,052	\$183	1,067	\$186	2,812	4,018	490	\$1,793	\$2,284	7.27	7.27	\$270	\$1,963.60	\$4,227.21
28	2043	0.1754	0.4507	1,760	2,951	\$309	\$1,330	\$1,639	1,052	\$184	1,067	\$187	2,812	4,018	493	\$1,811	\$2,304	7.27	7.27	\$280	\$2,036.32	\$4,340.45
29	2044	0.1764	0.4552	1,760	2,951	\$310	\$1,343	\$1,654	1,052	\$186	1,067	\$188	2,812	4,018	496	\$1,829	\$2,325	7.27	7.27	\$290	\$2,109.05	\$4,433.89
30	2045	0.1774	0.4596	1,760	2,951	\$312	\$1,356	\$1,669	1,052	\$187	1,067	\$189	2,812	4,018	499	\$1,847	\$2,346	7.27	7.27	\$300	\$2,181.77	\$4,527.51
31	2046	0.1784	0.4642	1,760	2,951	\$314	\$1,370	\$1,684	1,052	\$188	1,067	\$190	2,812	4,018	502	\$1,865	\$2,367	7.27	7.27	\$310	\$2,254.50	\$4,621.33
32	2047	0.1795	0.4688	1,760	2,951	\$316	\$1,383	\$1,699	1,052	\$189	1,067	\$191	2,812	4,018	505	\$1,883	\$2,388	7.27	7.27	\$320	\$2,327.23	\$4,715.35
33	2048	0.1805	0.4734	1,760	2,951	\$318	\$1,397	\$1,715	1,052	\$190	1,067	\$193	2,812	4,018	508	\$1,902	\$2,410	7.27	7.27	\$330	\$2,399.95	\$4,809.56
34	2049	0.1816	0.4780	1,760	2,951	\$320	\$1,411	\$1,730	1,052	\$191	1,067	\$194	2,812	4,018	511	\$1,921	\$2,431	7.27	7.27	\$340	\$2,472.68	\$4,903.98
35	2050	0.1826	0.4828	1,760	2,951	\$321	\$1,425	\$1,746	1,052	\$192	1,067	\$195	2,812	4,018	513	\$1,940	\$2,453	7.27	7.27	\$350	\$2,545.40	\$4,998.59
36	2051	0.1837	0.4875	1,760	2,951	\$323	\$1,439	\$1,762	1,052	\$193	1,067	\$196	2,812	4,018	516	\$1,959	\$2,475	7.27	7.27	\$360	\$2,618.13	\$5,093.41
37	2052	0.1847	0.4923	1,760	2,951	\$325	\$1,453	\$1,778	1,052	\$194	1,067	\$197	2,812	4,018	519	\$1,978	\$2,498	7.27	7.27	\$370	\$2,690.85	\$5,188.44
38	2053	0.1858	0.4972	1,760	2,951	\$327	\$1,467	\$1,794	1,052	\$195	1,067	\$198	2,812	4,018	522	\$1,998	\$2,520	7.27	7.27	\$380	\$2,763.58	\$5,283.67
39	2054	0.1869	0.5021	1,760	2,951	\$329	\$1,482	\$1,811	1,052	\$197	1,067	\$199	2,812	4,018	525	\$2,017	\$2,543	7.27	7.27	\$390	\$2,836.31	\$5,379.11
40	2055	0.1879	0.5070	1,760	2,951	\$331	\$1,496	\$1,827	1,052	\$198	1,067	\$201	2,812	4,018	528	\$2,037	\$2,566	7.27	7.27	\$400	\$2,909.03	\$5,474.77
41	2056	0.1890	0.5120	1,760	2,951	\$333	\$1,511	\$1,844	1,052	\$199	1,067	\$202	2,812	4,018	532	\$2,057	\$2,589	7.27	7.27	\$410	\$2,981.76	\$5,570.64
42	2057	0.1901	0.5171	1,760	2,951	\$335	\$1,526	\$1,861	1,052	\$200	1,067	\$203	2,812	4,018	535	\$2,078	\$2,612	7.27	7.27	\$420	\$3,054.48	\$5,666.72
43	2058	0.1912	0.5222	1,760	2,951	\$337	\$1,541	\$1,877	1,052	\$201	1,067	\$204	2,812	4,018	538	\$2,098	\$2,636	7.27	7.27	\$430	\$3,127.21	\$5,763.02
44	2059	0.1923	0.5273	1,760	2,951	\$339	\$1,556	\$1,895	1,052	\$202	1,067	\$205	2,812	4,018	541	\$2,119	\$2,660	7.27	7.27	\$440	\$3,199.94	\$5,859.54
45	2060	0.1934	0.5325	1,760	2,951	\$340	\$1,571	\$1,912	1,052	\$204	1,067	\$206	2,812	4,018	544	\$2,140	\$2,684	7.27	7.27	\$450	\$3,272.66	\$5,956.29
46	2061	0.1946	0.5378	1,760	2,951	\$342	\$1,587	\$1,929	1,052	\$205	1,067	\$208	2,812	4,018	547	\$2,161	\$2,708	7.27	7.27	\$460	\$3,345.39	\$6,053.25
47	2062	0.1957	0.5431	1,760	2,951	\$344	\$1,603	\$1,947	1,052	\$206	1,067	\$209	2,812	4,018	550	\$2,182	\$2,732	7.27	7.27	\$470	\$3,418.11	\$6,150.45
48	2063	0.1968	0.5484	1,760	2,951	\$346	\$1,618	\$1,965	1,052	\$207	1,067	\$210	2,812	4,018	553	\$2,204	\$2,757	7.27	7.27	\$480	\$3,490.84	\$6,247.87
49	2064	0.1980	0.5538	1,760	2,951	\$348	\$1,634	\$1,983	1,052	\$208	1,067	\$211	2,812	4,018	557	\$2,225	\$2,782	7.27	7.27	\$490	\$3,563.56	\$6,345.52
50	2065	0.1991	0.5593	1,760	2,951	\$350	\$1,650	\$2,001	1,052	\$209	1,067	\$212	2,812	4,018	560	\$2,247	\$2,807	7.27	7.27	\$500	\$3,636.29	\$6,443.41
51	2066	0.2003	0.5648	1,760	2,951	\$352	\$1,667	\$2,019	1,052	\$211	1,067	\$214	2,812	4,018	563	\$2,269	\$2,833	7.27	7.27	\$510	\$3,709.02	\$6,541.53
52	2067	0.2014	0.5704	1,760	2,951	\$354	\$1,683	\$2,038	1,052	\$212	1,067	\$215	2,812	4,018	566	\$2,292	\$2,858	7.27	7.27	\$520	\$3,781.74	\$6,639.88
53	2068	0.2026	0.5760	1,760	2,951	\$357	\$1,700	\$2,056	1,052	\$213	1,067	\$216										

19. Peterborough (Distinct) – Annual Operating Costs

Vertical Ground Source Heat Pump (V.GSHP)

Base Case Scenario											Feed in Tariff (FIT)		
#	Year	Electricity Rates		V.GSHP		Hot Water		Total	Total Operating Cost	FIT	Incentives (\$/KWh)	FIT	Operating Cost
		\$/KWh	KWh	Heating Operating Cost	Cooling Operating Cost	Hot Water Operating Cost	Hot Water Operating Cost						
1	2016	0.1501	6,060	\$910	404	\$61	4,084	\$613	10,548	\$1,583	0.05	0.1001	\$1,055.67
2	2017	0.1542	6,060	\$934	404	\$62	4,084	\$630	10,548	\$1,626	0.05	0.1042	\$1,098.96
3	2018	0.1583	6,060	\$959	404	\$64	4,084	\$646	10,548	\$1,670	0.05	0.1083	\$1,142.25
4	2019	0.1625	6,060	\$985	404	\$66	4,084	\$664	10,548	\$1,714	0.05	0.1125	\$1,187.06
5	2020	0.1668	6,060	\$1,011	404	\$67	4,084	\$681	10,548	\$1,759	0.05	0.1168	\$1,231.87
6	2021	0.1621	6,060	\$983	404	\$66	4,084	\$662	10,548	\$1,710	0.05	0.1121	\$1,182.88
7	2022	0.1629	6,060	\$987	404	\$66	4,084	\$665	10,548	\$1,719	0.05	0.1129	\$1,191.24
8	2023	0.1639	6,060	\$993	404	\$66	4,084	\$669	10,548	\$1,729	0.05	0.1139	\$1,201.11
9	2024	0.1648	6,060	\$999	404	\$67	4,084	\$673	10,548	\$1,738	0.05	0.1148	\$1,210.98
10	2025	0.1656	6,060	\$1,004	404	\$67	4,084	\$676	10,548	\$1,747	0.05	0.1156	\$1,219.33
11	2026	0.1665	6,060	\$1,009	404	\$67	4,084	\$680	10,548	\$1,757	0.05	0.1165	\$1,229.21
12	2027	0.1674	6,060	\$1,015	404	\$68	4,084	\$684	10,548	\$1,766	0.05	0.1174	\$1,238.70
13	2028	0.1683	6,060	\$1,020	404	\$68	4,084	\$687	10,548	\$1,775	0.05	0.1183	\$1,247.43
14	2029	0.1692	6,060	\$1,025	404	\$68	4,084	\$691	10,548	\$1,784	0.05	0.1192	\$1,256.93
15	2030	0.1701	6,060	\$1,031	404	\$69	4,084	\$695	10,548	\$1,794	0.05	0.1201	\$1,266.80
16	2031	0.1704	6,060	\$1,032	404	\$69	4,084	\$696	10,548	\$1,797	0.05	0.1204	\$1,269.46
17	2032	0.1705	6,060	\$1,033	404	\$69	4,084	\$696	10,548	\$1,798	0.05	0.1205	\$1,270.98
18	2033	0.1707	6,060	\$1,035	404	\$69	4,084	\$697	10,548	\$1,801	0.05	0.1207	\$1,273.64
19	2034	0.1710	6,060	\$1,036	404	\$69	4,084	\$699	10,548	\$1,804	0.05	0.1210	\$1,276.67
20	2035	0.1713	6,060	\$1,038	404	\$69	4,084	\$700	10,548	\$1,807	0.05	0.1213	\$1,279.33
21	2036	0.1714	6,060	\$1,039	404	\$69	4,084	\$700	10,548	\$1,808	0.05	0.1214	\$1,280.85
22	2037	0.1717	6,060	\$1,040	404	\$69	4,084	\$701	10,548	\$1,811	0.05	0.1217	\$1,283.51
23	2038	0.1720	6,060	\$1,042	404	\$69	4,084	\$702	10,548	\$1,814	0.05	0.1220	\$1,286.55
24	2039	0.1722	6,060	\$1,044	404	\$70	4,084	\$703	10,548	\$1,817	0.05	0.1222	\$1,289.20
25	2040	0.1724	6,060	\$1,045	404	\$70	4,084	\$704	10,548	\$1,818	0.05	0.1224	\$1,290.72
26	2041	0.1734	6,060	\$1,051	404	\$70	4,084	\$708	10,548	\$1,829	0.05	0.1234	\$1,301.24
27	2042	0.1744	6,060	\$1,057	404	\$70	4,084	\$712	10,548	\$1,839	0.05	0.1244	\$1,311.82
28	2043	0.1754	6,060	\$1,063	404	\$71	4,084	\$716	10,548	\$1,850	0.05	0.1254	\$1,322.46
29	2044	0.1764	6,060	\$1,069	404	\$71	4,084	\$720	10,548	\$1,861	0.05	0.1264	\$1,333.16
30	2045	0.1774	6,060	\$1,075	404	\$72	4,084	\$725	10,548	\$1,871	0.05	0.1274	\$1,343.92
31	2046	0.1784	6,060	\$1,081	404	\$72	4,084	\$729	10,548	\$1,882	0.05	0.1284	\$1,354.75
32	2047	0.1795	6,060	\$1,088	404	\$73	4,084	\$733	10,548	\$1,893	0.05	0.1295	\$1,365.64
33	2048	0.1805	6,060	\$1,094	404	\$73	4,084	\$737	10,548	\$1,904	0.05	0.1305	\$1,376.59
34	2049	0.1816	6,060	\$1,100	404	\$73	4,084	\$741	10,548	\$1,915	0.05	0.1316	\$1,387.60
35	2050	0.1826	6,060	\$1,107	404	\$74	4,084	\$746	10,548	\$1,926	0.05	0.1326	\$1,398.68
36	2051	0.1837	6,060	\$1,113	404	\$74	4,084	\$750	10,548	\$1,937	0.05	0.1337	\$1,409.82
37	2052	0.1847	6,060	\$1,119	404	\$75	4,084	\$754	10,548	\$1,948	0.05	0.1347	\$1,421.03
38	2053	0.1858	6,060	\$1,126	404	\$75	4,084	\$759	10,548	\$1,960	0.05	0.1358	\$1,432.30
39	2054	0.1869	6,060	\$1,132	404	\$75	4,084	\$763	10,548	\$1,971	0.05	0.1369	\$1,443.64
40	2055	0.1879	6,060	\$1,139	404	\$76	4,084	\$768	10,548	\$1,982	0.05	0.1379	\$1,455.04
41	2056	0.1890	6,060	\$1,146	404	\$76	4,084	\$772	10,548	\$1,994	0.05	0.1390	\$1,466.51
42	2057	0.1901	6,060	\$1,152	404	\$77	4,084	\$776	10,548	\$2,005	0.05	0.1401	\$1,478.04
43	2058	0.1912	6,060	\$1,159	404	\$77	4,084	\$781	10,548	\$2,017	0.05	0.1412	\$1,489.64
44	2059	0.1923	6,060	\$1,166	404	\$78	4,084	\$785	10,548	\$2,029	0.05	0.1423	\$1,501.31
45	2060	0.1934	6,060	\$1,172	404	\$78	4,084	\$790	10,548	\$2,040	0.05	0.1434	\$1,513.05
46	2061	0.1946	6,060	\$1,179	404	\$79	4,084	\$795	10,548	\$2,052	0.05	0.1446	\$1,524.85
47	2062	0.1957	6,060	\$1,186	404	\$79	4,084	\$799	10,548	\$2,064	0.05	0.1457	\$1,536.72
48	2063	0.1968	6,060	\$1,193	404	\$80	4,084	\$804	10,548	\$2,076	0.05	0.1468	\$1,548.66
49	2064	0.1980	6,060	\$1,200	404	\$80	4,084	\$808	10,548	\$2,088	0.05	0.1480	\$1,560.67
50	2065	0.1991	6,060	\$1,207	404	\$80	4,084	\$813	10,548	\$2,100	0.05	0.1491	\$1,572.75
51	2066	0.2003	6,060	\$1,214	404	\$81	4,084	\$818	10,548	\$2,112	0.05	0.1503	\$1,584.90
52	2067	0.2014	6,060	\$1,221	404	\$81	4,084	\$823	10,548	\$2,125	0.05	0.1514	\$1,597.12
53	2068	0.2026	6,060	\$1,228	404	\$82	4,084	\$827	10,548	\$2,137	0.05	0.1526	\$1,609.41
54	2069	0.2038	6,060	\$1,235	404	\$82	4,084	\$832	10,548	\$2,149	0.05	0.1538	\$1,621.77
55	2070	0.2049	6,060	\$1,242	404	\$83	4,084	\$837	10,548	\$2,162	0.05	0.1549	\$1,634.20
56	2071	0.2061	6,060	\$1,249	404	\$83	4,084	\$842	10,548	\$2,174	0.05	0.1561	\$1,646.71
57	2072	0.2073	6,060	\$1,256	404	\$84	4,084	\$847	10,548	\$2,187	0.05	0.1573	\$1,659.29
58	2073	0.2085	6,060	\$1,264	404	\$84	4,084	\$852	10,548	\$2,199	0.05	0.1585	\$1,671.93
59	2074	0.2097	6,060	\$1,271	404	\$85	4,084	\$856	10,548	\$2,212	0.05	0.1597	\$1,684.66
60	2075	0.2109	6,060	\$1,278	404	\$85	4,084	\$861	10,548	\$2,225	0.05	0.1609	\$1,697.45

Table D1-1.55: Annual Operating Costs (V.GSHP) of a 2,000 square feet detached house above grade (average construction type) in the city of Peterborough (two life cycles and three life cycles for a 60 year project lifespan); base case scenario in comparison with feed in-tariff (FIT) scenario. In the FIT scenario, an incentive of \$0.05/KWh is provided on electricity bills throughout the project lifespan

Horizontal Ground Source Heat Pump (H.GSHP)

Base Case Scenario											Feed in Tariff (FIT)		
H.GSHP											FIT		
#	Year	Electricity Rates \$/KWh	Heating KWh	Heating Operating Cost \$	Cooling KWh	Cooling Operating Cost \$	Hot Water KWh	Hot Water Operating Cost \$	Total KWh	Total Operating Cost \$	Incentives (\$/KWh)	\$/KWh	Operating Cost
1	2016	0.1501	6,187	\$929	419	\$63	4,070	\$611	10,676	\$1,602	0.05	0.1001	\$1,068.48
2	2017	0.1542	6,187	\$954	419	\$65	4,070	\$628	10,676	\$1,646	0.05	0.1042	\$1,112.30
3	2018	0.1583	6,187	\$979	419	\$66	4,070	\$644	10,676	\$1,690	0.05	0.1083	\$1,156.11
4	2019	0.1625	6,187	\$1,006	419	\$68	4,070	\$662	10,676	\$1,735	0.05	0.1125	\$1,201.46
5	2020	0.1668	6,187	\$1,032	419	\$70	4,070	\$679	10,676	\$1,781	0.05	0.1168	\$1,246.81
6	2021	0.1621	6,187	\$1,003	419	\$68	4,070	\$660	10,676	\$1,731	0.05	0.1121	\$1,197.24
7	2022	0.1629	6,187	\$1,008	419	\$68	4,070	\$663	10,676	\$1,739	0.05	0.1129	\$1,205.69
8	2023	0.1639	6,187	\$1,014	419	\$69	4,070	\$667	10,676	\$1,749	0.05	0.1139	\$1,215.68
9	2024	0.1648	6,187	\$1,020	419	\$69	4,070	\$671	10,676	\$1,759	0.05	0.1148	\$1,225.68
10	2025	0.1656	6,187	\$1,025	419	\$69	4,070	\$674	10,676	\$1,768	0.05	0.1156	\$1,234.13
11	2026	0.1665	6,187	\$1,030	419	\$70	4,070	\$678	10,676	\$1,778	0.05	0.1165	\$1,244.12
12	2027	0.1674	6,187	\$1,036	419	\$70	4,070	\$681	10,676	\$1,788	0.05	0.1174	\$1,253.73
13	2028	0.1683	6,187	\$1,041	419	\$71	4,070	\$685	10,676	\$1,796	0.05	0.1183	\$1,262.57
14	2029	0.1692	6,187	\$1,047	419	\$71	4,070	\$688	10,676	\$1,806	0.05	0.1192	\$1,272.18
15	2030	0.1701	6,187	\$1,052	419	\$71	4,070	\$692	10,676	\$1,816	0.05	0.1201	\$1,282.17
16	2031	0.1704	6,187	\$1,054	419	\$71	4,070	\$693	10,676	\$1,819	0.05	0.1204	\$1,284.86
17	2032	0.1705	6,187	\$1,055	419	\$71	4,070	\$694	10,676	\$1,820	0.05	0.1205	\$1,286.40
18	2033	0.1707	6,187	\$1,056	419	\$72	4,070	\$695	10,676	\$1,823	0.05	0.1207	\$1,289.09
19	2034	0.1710	6,187	\$1,058	419	\$72	4,070	\$696	10,676	\$1,826	0.05	0.1210	\$1,292.17
20	2035	0.1713	6,187	\$1,060	419	\$72	4,070	\$697	10,676	\$1,829	0.05	0.1213	\$1,294.86
21	2036	0.1714	6,187	\$1,061	419	\$72	4,070	\$698	10,676	\$1,830	0.05	0.1214	\$1,296.39
22	2037	0.1717	6,187	\$1,062	419	\$72	4,070	\$699	10,676	\$1,833	0.05	0.1217	\$1,299.08
23	2038	0.1720	6,187	\$1,064	419	\$72	4,070	\$700	10,676	\$1,836	0.05	0.1220	\$1,302.16
24	2039	0.1722	6,187	\$1,066	419	\$72	4,070	\$701	10,676	\$1,839	0.05	0.1222	\$1,304.85
25	2040	0.1724	6,187	\$1,066	419	\$72	4,070	\$702	10,676	\$1,840	0.05	0.1224	\$1,306.39
26	2041	0.1734	6,187	\$1,073	419	\$73	4,070	\$706	10,676	\$1,851	0.05	0.1234	\$1,317.03
27	2042	0.1744	6,187	\$1,079	419	\$73	4,070	\$710	10,676	\$1,862	0.05	0.1244	\$1,327.74
28	2043	0.1754	6,187	\$1,085	419	\$73	4,070	\$714	10,676	\$1,872	0.05	0.1254	\$1,338.51
29	2044	0.1764	6,187	\$1,091	419	\$74	4,070	\$718	10,676	\$1,883	0.05	0.1264	\$1,349.34
30	2045	0.1774	6,187	\$1,098	419	\$74	4,070	\$722	10,676	\$1,894	0.05	0.1274	\$1,360.23
31	2046	0.1784	6,187	\$1,104	419	\$75	4,070	\$726	10,676	\$1,905	0.05	0.1284	\$1,371.19
32	2047	0.1795	6,187	\$1,110	419	\$75	4,070	\$730	10,676	\$1,916	0.05	0.1295	\$1,382.21
33	2048	0.1805	6,187	\$1,117	419	\$76	4,070	\$735	10,676	\$1,927	0.05	0.1305	\$1,393.29
34	2049	0.1816	6,187	\$1,123	419	\$76	4,070	\$739	10,676	\$1,938	0.05	0.1316	\$1,404.44
35	2050	0.1826	6,187	\$1,130	419	\$77	4,070	\$743	10,676	\$1,949	0.05	0.1326	\$1,415.65
36	2051	0.1837	6,187	\$1,136	419	\$77	4,070	\$747	10,676	\$1,961	0.05	0.1337	\$1,426.93
37	2052	0.1847	6,187	\$1,143	419	\$77	4,070	\$752	10,676	\$1,972	0.05	0.1347	\$1,438.27
38	2053	0.1858	6,187	\$1,149	419	\$78	4,070	\$756	10,676	\$1,983	0.05	0.1358	\$1,449.68
39	2054	0.1869	6,187	\$1,156	419	\$78	4,070	\$761	10,676	\$1,995	0.05	0.1369	\$1,461.15
40	2055	0.1879	6,187	\$1,163	419	\$79	4,070	\$765	10,676	\$2,006	0.05	0.1379	\$1,472.70
41	2056	0.1890	6,187	\$1,170	419	\$79	4,070	\$769	10,676	\$2,018	0.05	0.1390	\$1,484.30
42	2057	0.1901	6,187	\$1,176	419	\$80	4,070	\$774	10,676	\$2,030	0.05	0.1401	\$1,495.98
43	2058	0.1912	6,187	\$1,183	419	\$80	4,070	\$778	10,676	\$2,042	0.05	0.1412	\$1,507.72
44	2059	0.1923	6,187	\$1,190	419	\$81	4,070	\$783	10,676	\$2,053	0.05	0.1423	\$1,519.53
45	2060	0.1934	6,187	\$1,197	419	\$81	4,070	\$787	10,676	\$2,065	0.05	0.1434	\$1,531.41
46	2061	0.1946	6,187	\$1,204	419	\$82	4,070	\$792	10,676	\$2,077	0.05	0.1446	\$1,543.35
47	2062	0.1957	6,187	\$1,211	419	\$82	4,070	\$796	10,676	\$2,089	0.05	0.1457	\$1,555.37
48	2063	0.1968	6,187	\$1,218	419	\$82	4,070	\$801	10,676	\$2,101	0.05	0.1468	\$1,567.46
49	2064	0.1980	6,187	\$1,225	419	\$83	4,070	\$806	10,676	\$2,113	0.05	0.1480	\$1,579.61
50	2065	0.1991	6,187	\$1,232	419	\$83	4,070	\$810	10,676	\$2,126	0.05	0.1491	\$1,591.84
51	2066	0.2003	6,187	\$1,239	419	\$84	4,070	\$815	10,676	\$2,138	0.05	0.1503	\$1,604.13
52	2067	0.2014	6,187	\$1,246	419	\$84	4,070	\$820	10,676	\$2,150	0.05	0.1514	\$1,616.50
53	2068	0.2026	6,187	\$1,253	419	\$85	4,070	\$824	10,676	\$2,163	0.05	0.1526	\$1,628.94
54	2069	0.2038	6,187	\$1,261	419	\$85	4,070	\$829	10,676	\$2,175	0.05	0.1538	\$1,641.45
55	2070	0.2049	6,187	\$1,268	419	\$86	4,070	\$834	10,676	\$2,188	0.05	0.1549	\$1,654.03
56	2071	0.2061	6,187	\$1,275	419	\$86	4,070	\$839	10,676	\$2,200	0.05	0.1561	\$1,666.69
57	2072	0.2073	6,187	\$1,283	419	\$87	4,070	\$844	10,676	\$2,213	0.05	0.1573	\$1,679.42
58	2073	0.2085	6,187	\$1,290	419	\$87	4,070	\$849	10,676	\$2,226	0.05	0.1585	\$1,692.22
59	2074	0.2097	6,187	\$1,297	419	\$88	4,070	\$854	10,676	\$2,239	0.05	0.1597	\$1,705.10
60	2075	0.2109	6,187	\$1,305	419	\$88	4,070	\$858	10,676	\$2,252	0.05	0.1609	\$1,718.05

Table D1-1.56: Annual Operating Costs (H.GSHP) of a 2,000 square feet detached house above grade (average construction type) in the city of Peterborough (two life cycles and three life cycles for a 60 year project lifespan); base case scenario in comparison with feed in-tariff (FIT) scenario. In the FIT scenario, an incentive of \$0.05/KWh is provided on electricity bills throughout the project lifespan

Traditional HVAC Applications

Base Case Scenario																Carbon Taxes						
#	Year	Electricity Rates	Natural Gas Rates	Heating		Heating Operating Cost	Heating Operating Cost	Total Heating Operating Cost	Cooling	Cooling Operating Cost	Hot Water	Hot Water Operating Cost	Total	Total	Total Electricity Operating Cost	Total Natural Gas Operating Cost	Total	Conversion of m ³ into Tons	Total Tons	Carbon Tax	Operating Costs	
				KWh (Electricity)	m ³ (Gas)																	\$ (Electricity)
1	2016	0.1501	0.3458	1,425	2,887	\$214	\$998	\$1,212	1,623	\$244	1,055	\$365	3,048	3,942	457	\$1,363	\$1,821	7.14	7.14	\$10	\$71.35	\$1,892.07
2	2017	0.1542	0.3588	1,425	2,887	\$220	\$1,036	\$1,256	1,623	\$250	1,055	\$163	3,048	3,942	470	\$1,415	\$1,884	7.14	7.14	\$20	\$142.70	\$2,027.20
3	2018	0.1583	0.3718	1,425	2,887	\$226	\$1,074	\$1,299	1,623	\$257	1,055	\$167	3,048	3,942	482	\$1,466	\$1,948	7.14	7.14	\$30	\$214.05	\$2,162.33
4	2019	0.1625	0.3776	1,425	2,887	\$232	\$1,090	\$1,322	1,623	\$264	1,055	\$171	3,048	3,942	495	\$1,488	\$1,984	7.14	7.14	\$40	\$285.40	\$2,269.25
5	2020	0.1668	0.3841	1,425	2,887	\$238	\$1,109	\$1,347	1,623	\$271	1,055	\$176	3,048	3,942	508	\$1,514	\$2,022	7.14	7.14	\$50	\$356.75	\$2,379.18
6	2021	0.1621	0.3883	1,425	2,887	\$231	\$1,121	\$1,352	1,623	\$263	1,055	\$171	3,048	3,942	494	\$1,531	\$2,025	7.14	7.14	\$60	\$428.10	\$2,452.97
7	2022	0.1629	0.3929	1,425	2,887	\$232	\$1,134	\$1,366	1,623	\$264	1,055	\$172	3,048	3,942	497	\$1,549	\$2,045	7.14	7.14	\$70	\$499.45	\$2,544.83
8	2023	0.1639	0.3967	1,425	2,887	\$234	\$1,145	\$1,379	1,623	\$266	1,055	\$173	3,048	3,942	499	\$1,564	\$2,063	7.14	7.14	\$80	\$570.80	\$2,634.11
9	2024	0.1648	0.4005	1,425	2,887	\$235	\$1,156	\$1,391	1,623	\$267	1,055	\$174	3,048	3,942	502	\$1,579	\$2,081	7.14	7.14	\$90	\$642.15	\$2,725.39
10	2025	0.1656	0.4040	1,425	2,887	\$236	\$1,166	\$1,402	1,623	\$269	1,055	\$175	3,048	3,942	505	\$1,592	\$2,097	7.14	7.14	\$100	\$713.50	\$2,810.73
11	2026	0.1665	0.4070	1,425	2,887	\$237	\$1,175	\$1,412	1,623	\$270	1,055	\$176	3,048	3,942	508	\$1,605	\$2,112	7.14	7.14	\$110	\$784.85	\$2,897.00
12	2027	0.1674	0.4097	1,425	2,887	\$239	\$1,183	\$1,421	1,623	\$272	1,055	\$177	3,048	3,942	510	\$1,615	\$2,125	7.14	7.14	\$120	\$856.20	\$2,981.65
13	2028	0.1683	0.4124	1,425	2,887	\$240	\$1,191	\$1,430	1,623	\$273	1,055	\$178	3,048	3,942	513	\$1,626	\$2,139	7.14	7.14	\$130	\$927.55	\$3,066.08
14	2029	0.1692	0.4151	1,425	2,887	\$241	\$1,198	\$1,439	1,623	\$275	1,055	\$178	3,048	3,942	516	\$1,636	\$2,152	7.14	7.14	\$140	\$998.90	\$3,150.73
15	2030	0.1701	0.4170	1,425	2,887	\$242	\$1,204	\$1,446	1,623	\$276	1,055	\$179	3,048	3,942	518	\$1,644	\$2,162	7.14	7.14	\$150	\$1,070.25	\$3,232.47
16	2031	0.1704	0.4189	1,425	2,887	\$243	\$1,209	\$1,452	1,623	\$276	1,055	\$180	3,048	3,942	519	\$1,651	\$2,171	7.14	7.14	\$160	\$1,141.60	\$3,312.13
17	2032	0.1705	0.4204	1,425	2,887	\$243	\$1,214	\$1,457	1,623	\$277	1,055	\$180	3,048	3,942	520	\$1,657	\$2,177	7.14	7.14	\$170	\$1,212.95	\$3,389.95
18	2033	0.1707	0.4223	1,425	2,887	\$243	\$1,219	\$1,463	1,623	\$277	1,055	\$180	3,048	3,942	520	\$1,665	\$2,185	7.14	7.14	\$180	\$1,284.30	\$3,469.61
19	2034	0.1710	0.4246	1,425	2,887	\$244	\$1,226	\$1,470	1,623	\$278	1,055	\$180	3,048	3,942	521	\$1,674	\$2,195	7.14	7.14	\$190	\$1,355.65	\$3,550.88
20	2035	0.1713	0.4265	1,425	2,887	\$244	\$1,231	\$1,476	1,623	\$278	1,055	\$181	3,048	3,942	522	\$1,681	\$2,204	7.14	7.14	\$200	\$1,427.00	\$3,630.54
21	2036	0.1714	0.4288	1,425	2,887	\$244	\$1,238	\$1,482	1,623	\$278	1,055	\$181	3,048	3,942	523	\$1,691	\$2,213	7.14	7.14	\$210	\$1,498.35	\$3,711.38
22	2037	0.1717	0.4311	1,425	2,887	\$245	\$1,245	\$1,489	1,623	\$279	1,055	\$181	3,048	3,942	523	\$1,700	\$2,223	7.14	7.14	\$220	\$1,569.70	\$3,792.55
23	2038	0.1720	0.4331	1,425	2,887	\$245	\$1,250	\$1,495	1,623	\$279	1,055	\$181	3,048	3,942	524	\$1,707	\$2,231	7.14	7.14	\$230	\$1,641.05	\$3,872.32
24	2039	0.1722	0.4353	1,425	2,887	\$245	\$1,257	\$1,502	1,623	\$280	1,055	\$182	3,048	3,942	525	\$1,716	\$2,241	7.14	7.14	\$240	\$1,712.40	\$3,953.48
25	2040	0.1724	0.4376	1,425	2,887	\$246	\$1,263	\$1,509	1,623	\$280	1,055	\$182	3,048	3,942	525	\$1,725	\$2,251	7.14	7.14	\$250	\$1,783.76	\$4,034.32
26	2041	0.1734	0.4420	1,425	2,887	\$247	\$1,276	\$1,523	1,623	\$281	1,055	\$183	3,048	3,942	528	\$1,742	\$2,271	7.14	7.14	\$260	\$1,855.11	\$4,125.72
27	2042	0.1744	0.4463	1,425	2,887	\$248	\$1,289	\$1,537	1,623	\$283	1,055	\$184	3,048	3,942	531	\$1,759	\$2,291	7.14	7.14	\$270	\$1,926.46	\$4,217.30
28	2043	0.1754	0.4507	1,425	2,887	\$250	\$1,301	\$1,551	1,623	\$285	1,055	\$185	3,048	3,942	535	\$1,777	\$2,311	7.14	7.14	\$280	\$1,997.81	\$4,309.07
29	2044	0.1764	0.4552	1,425	2,887	\$251	\$1,314	\$1,565	1,623	\$286	1,055	\$186	3,048	3,942	538	\$1,794	\$2,332	7.14	7.14	\$290	\$2,069.16	\$4,401.03
30	2045	0.1774	0.4596	1,425	2,887	\$253	\$1,327	\$1,580	1,623	\$288	1,055	\$187	3,048	3,942	541	\$1,812	\$2,353	7.14	7.14	\$300	\$2,140.51	\$4,493.18
31	2046	0.1784	0.4642	1,425	2,887	\$254	\$1,340	\$1,594	1,623	\$290	1,055	\$188	3,048	3,942	544	\$1,830	\$2,374	7.14	7.14	\$310	\$2,211.86	\$4,585.52
32	2047	0.1795	0.4688	1,425	2,887	\$256	\$1,353	\$1,609	1,623	\$291	1,055	\$189	3,048	3,942	547	\$1,848	\$2,395	7.14	7.14	\$320	\$2,283.21	\$4,678.06
33	2048	0.1805	0.4734	1,425	2,887	\$257	\$1,367	\$1,624	1,623	\$293	1,055	\$190	3,048	3,942	550	\$1,866	\$2,416	7.14	7.14	\$330	\$2,354.56	\$4,770.79
34	2049	0.1816	0.4780	1,425	2,887	\$259	\$1,380	\$1,639	1,623	\$295	1,055	\$192	3,048	3,942	553	\$1,884	\$2,438	7.14	7.14	\$340	\$2,425.91	\$4,863.72
35	2050	0.1826	0.4828	1,425	2,887	\$260	\$1,394	\$1,654	1,623	\$296	1,055	\$193	3,048	3,942	557	\$1,903	\$2,460	7.14	7.14	\$350	\$2,497.26	\$4,956.85
36	2051	0.1837	0.4875	1,425	2,887	\$262	\$1,407	\$1,669	1,623	\$298	1,055	\$194	3,048	3,942	560	\$1,922	\$2,482	7.14	7.14	\$360	\$2,568.61	\$5,050.18
37	2052	0.1847	0.4923	1,425	2,887	\$263	\$1,421	\$1,685	1,623	\$300	1,055	\$195	3,048	3,942	563	\$1,941	\$2,504	7.14	7.14	\$370	\$2,639.96	\$5,143.72
38	2053	0.1858	0.4972	1,425	2,887	\$265	\$1,435	\$1,700	1,623	\$302	1,055	\$196	3,048	3,942	566	\$1,960	\$2,526	7.14	7.14	\$380	\$2,711.31	\$5,237.46
39	2054	0.1869	0.5021	1,425	2,887	\$266	\$1,449	\$1,716	1,623	\$303	1,055	\$197	3,048	3,942	570	\$1,979	\$2,549	7.14	7.14	\$390	\$2,782.66	\$5,331.41
40	2055	0.1879	0.5070	1,425	2,887	\$268	\$1,464	\$1,732	1,623	\$305	1,055	\$198	3,048	3,942	573	\$1,999	\$2,572	7.14	7.14	\$400	\$2,854.01	\$5,425.56
41	2056	0.1890	0.5120	1,425	2,887	\$269	\$1,478	\$1,748	1,623	\$307	1,055	\$199	3,048	3,942	576	\$2,018	\$2,595	7.14	7.14	\$410	\$2,925.36	\$5,519.93
42	2057	0.1901	0.5171	1,425	2,887	\$271	\$1,493	\$1,764	1,623	\$309	1,055	\$201	3,048	3,942	580	\$2,038	\$2,618	7.14	7.14	\$420	\$2,996.71	\$5,614.52
43	2058	0.1912	0.5222	1,425	2,887	\$272	\$1,508	\$1,780	1,623	\$310	1,055	\$202	3,048	3,942	583	\$2,058	\$2,641	7.14	7.14	\$430	\$3,068.06	\$5,709.31
44	2059	0.1923	0.5273	1,425	2,887	\$274	\$1,522	\$1,796	1,623	\$312	1,055	\$203	3,048	3,942	586	\$2,079	\$2,665	7.14	7.14	\$440	\$3,139.41	\$5,804.33
45	2060	0.1934	0.5325	1,425	2,887	\$276	\$1,537	\$1,813	1,623	\$314	1,055	\$204	3,048	3,942	590	\$2,099	\$2,689	7.14	7.14	\$450	\$3,210.76	\$5,899.57
46	2061	0.1946	0.5378	1,425	2,887	\$277	\$1,553	\$1,830	1,623	\$316	1,055	\$205	3,048	3,942	593	\$2,120	\$2,713	7.14	7.14	\$460	\$3,282.11	\$5,995.02
47	2062	0.1957	0.5431	1,425	2,887	\$279	\$1,568	\$1,847	1,623	\$318	1,055	\$206	3,048	3,942	596	\$2,141	\$2,737	7.14	7.14	\$470	\$3,353.46	\$6,090.70
48	2063	0.1968	0.5484	1,425	2,887	\$280	\$1,583	\$1,864	1,623	\$319	1,055	\$208	3,048	3,942	600	\$2,162	\$2,762	7.14	7.14	\$480	\$3,424.81	\$6,186.61
49	2064	0.1980	0.5538	1,425	2,887	\$282	\$1,599	\$1,881	1,623	\$321	1,055	\$209	3,048	3,942	603	\$2,183	\$2,787	7.14	7.14	\$490	\$3,496.16	\$6,282.74
50	2065	0.1991	0.5593	1,425	2,887	\$284	\$1,615	\$1,898	1,623	\$323	1,055	\$210	3,048	3,942	607	\$2,205	\$2,812	7.14	7.14	\$500	\$3,567.51	\$6,379.11
51	2066	0.2003	0.5648	1,425	2,887	\$285	\$1,631	\$1,916	1,623	\$325	1,055	\$211	3,048	3,942	610	\$2,226	\$2,837	7.14	7.14	\$510	\$3,638.86	\$6,475.71
52	2067	0.2014	0.5704	1,425	2,887	\$287	\$1,647	\$1,934	1,623	\$327	1,055	\$212	3,048	3,942	614	\$2,248	\$2,862	7.14	7.14	\$520	\$3,710.21	\$6,572.54
53	2068	0.2026	0.5760	1,425	2,887	\$289	\$1,663	\$1,952	1,623	\$329	1,055	\$21										

20. Ottawa (Distinct) – Annual Operating Costs

Vertical Ground Source Heat Pump (V.GSHP)

Base Case Scenario											Feed in Tariff (FIT)		
#	Year	Electricity Rates		V.GSHP		Hot Water		Total	Total Operating Cost	Incentives (S/KWh)	FIT		
		\$/KWh	KWh	Heating Operating Cost \$	Cooling KWh	Cooling Operating Cost \$	Hot Water KWh				Hot Water Operating Cost \$	S/KWh	Operating Cost
1	2016	0.1501	5,868	\$881	307	\$46	4,152	\$623	10,327	\$1,550	0.05	0.1001	\$1,033.56
2	2017	0.1542	5,868	\$905	307	\$47	4,152	\$640	10,327	\$1,592	0.05	0.1042	\$1,075.94
3	2018	0.1583	5,868	\$929	307	\$49	4,152	\$657	10,327	\$1,635	0.05	0.1083	\$1,118.32
4	2019	0.1625	5,868	\$954	307	\$50	4,152	\$675	10,327	\$1,679	0.05	0.1125	\$1,162.19
5	2020	0.1668	5,868	\$979	307	\$51	4,152	\$692	10,327	\$1,722	0.05	0.1168	\$1,206.06
6	2021	0.1621	5,868	\$951	307	\$50	4,152	\$673	10,327	\$1,674	0.05	0.1121	\$1,158.10
7	2022	0.1629	5,868	\$956	307	\$50	4,152	\$677	10,327	\$1,683	0.05	0.1129	\$1,166.28
8	2023	0.1639	5,868	\$962	307	\$50	4,152	\$680	10,327	\$1,692	0.05	0.1139	\$1,175.94
9	2024	0.1648	5,868	\$967	307	\$51	4,152	\$684	10,327	\$1,702	0.05	0.1148	\$1,185.61
10	2025	0.1656	5,868	\$972	307	\$51	4,152	\$688	10,327	\$1,710	0.05	0.1156	\$1,193.79
11	2026	0.1665	5,868	\$977	307	\$51	4,152	\$691	10,327	\$1,720	0.05	0.1165	\$1,203.45
12	2027	0.1674	5,868	\$983	307	\$51	4,152	\$695	10,327	\$1,729	0.05	0.1174	\$1,212.75
13	2028	0.1683	5,868	\$987	307	\$52	4,152	\$699	10,327	\$1,738	0.05	0.1183	\$1,221.30
14	2029	0.1692	5,868	\$993	307	\$52	4,152	\$702	10,327	\$1,747	0.05	0.1192	\$1,230.59
15	2030	0.1701	5,868	\$998	307	\$52	4,152	\$706	10,327	\$1,757	0.05	0.1201	\$1,240.26
16	2031	0.1704	5,868	\$1,000	307	\$52	4,152	\$707	10,327	\$1,759	0.05	0.1204	\$1,242.86
17	2032	0.1705	5,868	\$1,000	307	\$52	4,152	\$708	10,327	\$1,761	0.05	0.1205	\$1,244.35
18	2033	0.1707	5,868	\$1,002	307	\$52	4,152	\$709	10,327	\$1,763	0.05	0.1207	\$1,246.95
19	2034	0.1710	5,868	\$1,004	307	\$53	4,152	\$710	10,327	\$1,766	0.05	0.1210	\$1,249.92
20	2035	0.1713	5,868	\$1,005	307	\$53	4,152	\$711	10,327	\$1,769	0.05	0.1213	\$1,252.53
21	2036	0.1714	5,868	\$1,006	307	\$53	4,152	\$712	10,327	\$1,770	0.05	0.1214	\$1,254.01
22	2037	0.1717	5,868	\$1,007	307	\$53	4,152	\$713	10,327	\$1,773	0.05	0.1217	\$1,256.62
23	2038	0.1720	5,868	\$1,009	307	\$53	4,152	\$714	10,327	\$1,776	0.05	0.1220	\$1,259.59
24	2039	0.1722	5,868	\$1,011	307	\$53	4,152	\$715	10,327	\$1,779	0.05	0.1222	\$1,262.19
25	2040	0.1724	5,868	\$1,011	307	\$53	4,152	\$716	10,327	\$1,780	0.05	0.1224	\$1,263.68
26	2041	0.1734	5,868	\$1,017	307	\$53	4,152	\$720	10,327	\$1,790	0.05	0.1234	\$1,273.98
27	2042	0.1744	5,868	\$1,023	307	\$54	4,152	\$724	10,327	\$1,801	0.05	0.1244	\$1,284.33
28	2043	0.1754	5,868	\$1,029	307	\$54	4,152	\$728	10,327	\$1,811	0.05	0.1254	\$1,294.75
29	2044	0.1764	5,868	\$1,035	307	\$54	4,152	\$732	10,327	\$1,822	0.05	0.1264	\$1,305.23
30	2045	0.1774	5,868	\$1,041	307	\$54	4,152	\$737	10,327	\$1,832	0.05	0.1274	\$1,315.77
31	2046	0.1784	5,868	\$1,047	307	\$55	4,152	\$741	10,327	\$1,843	0.05	0.1284	\$1,326.36
32	2047	0.1795	5,868	\$1,053	307	\$55	4,152	\$745	10,327	\$1,853	0.05	0.1295	\$1,337.02
33	2048	0.1805	5,868	\$1,059	307	\$55	4,152	\$749	10,327	\$1,864	0.05	0.1305	\$1,347.75
34	2049	0.1816	5,868	\$1,065	307	\$56	4,152	\$754	10,327	\$1,875	0.05	0.1316	\$1,358.53
35	2050	0.1826	5,868	\$1,072	307	\$56	4,152	\$758	10,327	\$1,886	0.05	0.1326	\$1,369.37
36	2051	0.1837	5,868	\$1,078	307	\$56	4,152	\$763	10,327	\$1,897	0.05	0.1337	\$1,380.28
37	2052	0.1847	5,868	\$1,084	307	\$57	4,152	\$767	10,327	\$1,908	0.05	0.1347	\$1,391.26
38	2053	0.1858	5,868	\$1,090	307	\$57	4,152	\$771	10,327	\$1,919	0.05	0.1358	\$1,402.29
39	2054	0.1869	5,868	\$1,097	307	\$57	4,152	\$776	10,327	\$1,930	0.05	0.1369	\$1,413.39
40	2055	0.1879	5,868	\$1,103	307	\$58	4,152	\$780	10,327	\$1,941	0.05	0.1379	\$1,424.55
41	2056	0.1890	5,868	\$1,109	307	\$58	4,152	\$785	10,327	\$1,952	0.05	0.1390	\$1,435.78
42	2057	0.1901	5,868	\$1,116	307	\$58	4,152	\$789	10,327	\$1,963	0.05	0.1401	\$1,447.07
43	2058	0.1912	5,868	\$1,122	307	\$59	4,152	\$794	10,327	\$1,975	0.05	0.1412	\$1,458.43
44	2059	0.1923	5,868	\$1,129	307	\$59	4,152	\$799	10,327	\$1,986	0.05	0.1423	\$1,469.86
45	2060	0.1934	5,868	\$1,135	307	\$59	4,152	\$803	10,327	\$1,998	0.05	0.1434	\$1,481.35
46	2061	0.1946	5,868	\$1,142	307	\$60	4,152	\$808	10,327	\$2,009	0.05	0.1446	\$1,492.90
47	2062	0.1957	5,868	\$1,148	307	\$60	4,152	\$812	10,327	\$2,021	0.05	0.1457	\$1,504.52
48	2063	0.1968	5,868	\$1,155	307	\$60	4,152	\$817	10,327	\$2,033	0.05	0.1468	\$1,516.22
49	2064	0.1980	5,868	\$1,162	307	\$61	4,152	\$822	10,327	\$2,044	0.05	0.1480	\$1,527.97
50	2065	0.1991	5,868	\$1,168	307	\$61	4,152	\$827	10,327	\$2,056	0.05	0.1491	\$1,539.80
51	2066	0.2003	5,868	\$1,175	307	\$61	4,152	\$831	10,327	\$2,068	0.05	0.1503	\$1,551.69
52	2067	0.2014	5,868	\$1,182	307	\$62	4,152	\$836	10,327	\$2,080	0.05	0.1514	\$1,563.66
53	2068	0.2026	5,868	\$1,189	307	\$62	4,152	\$841	10,327	\$2,092	0.05	0.1526	\$1,575.69
54	2069	0.2038	5,868	\$1,196	307	\$63	4,152	\$846	10,327	\$2,104	0.05	0.1538	\$1,587.79
55	2070	0.2049	5,868	\$1,203	307	\$63	4,152	\$851	10,327	\$2,116	0.05	0.1549	\$1,599.96
56	2071	0.2061	5,868	\$1,209	307	\$63	4,152	\$856	10,327	\$2,129	0.05	0.1561	\$1,612.21
57	2072	0.2073	5,868	\$1,216	307	\$64	4,152	\$861	10,327	\$2,141	0.05	0.1573	\$1,624.52
58	2073	0.2085	5,868	\$1,224	307	\$64	4,152	\$866	10,327	\$2,153	0.05	0.1585	\$1,636.90
59	2074	0.2097	5,868	\$1,231	307	\$64	4,152	\$871	10,327	\$2,166	0.05	0.1597	\$1,649.36
60	2075	0.2109	5,868	\$1,238	307	\$65	4,152	\$876	10,327	\$2,178	0.05	0.1609	\$1,661.89

Table D1-1.58: Annual Operating Costs (V.GSHP) of a 2,000 square feet detached house above grade (average construction type) in the city of Ottawa (two life cycles and three life cycles for a 60 year project lifespan); base case scenario in comparison with feed in-tariff (FIT) scenario. In the FIT scenario, an incentive of \$0.05/KWh is provided on electricity bills throughout the project lifespan

Horizontal Ground Source Heat Pump (H.GSHP)

Base Case Scenario											Feed in Tariff (FIT)		
H.GSHP											FIT		
#	Year	Electricity Rates \$/KWh	Heating KWh	Heating Operating Cost \$	Cooling KWh	Cooling Operating Cost \$	Hot Water KWh	Hot Water Operating Cost \$	Total KWh	Total Operating Cost \$	Incentives (\$/KWh)	Operating Cost \$	
1	2016	0.1501	5,998	\$900	319	\$48	4,141	\$621	10,458	\$1,570	0.05	\$1,046.67	
2	2017	0.1542	5,998	\$925	319	\$49	4,141	\$638	10,458	\$1,612	0.05	\$1,089.59	
3	2018	0.1583	5,998	\$949	319	\$50	4,141	\$655	10,458	\$1,655	0.05	\$1,132.50	
4	2019	0.1625	5,998	\$975	319	\$52	4,141	\$673	10,458	\$1,700	0.05	\$1,176.93	
5	2020	0.1668	5,998	\$1,000	319	\$53	4,141	\$691	10,458	\$1,744	0.05	\$1,221.35	
6	2021	0.1621	5,998	\$973	319	\$52	4,141	\$671	10,458	\$1,696	0.05	\$1,172.79	
7	2022	0.1629	5,998	\$977	319	\$52	4,141	\$675	10,458	\$1,704	0.05	\$1,181.07	
8	2023	0.1639	5,998	\$983	319	\$52	4,141	\$679	10,458	\$1,714	0.05	\$1,190.86	
9	2024	0.1648	5,998	\$989	319	\$53	4,141	\$682	10,458	\$1,724	0.05	\$1,200.65	
10	2025	0.1656	5,998	\$993	319	\$53	4,141	\$686	10,458	\$1,732	0.05	\$1,208.93	
11	2026	0.1665	5,998	\$999	319	\$53	4,141	\$690	10,458	\$1,742	0.05	\$1,218.72	
12	2027	0.1674	5,998	\$1,004	319	\$53	4,141	\$693	10,458	\$1,751	0.05	\$1,228.13	
13	2028	0.1683	5,998	\$1,009	319	\$54	4,141	\$697	10,458	\$1,760	0.05	\$1,236.79	
14	2029	0.1692	5,998	\$1,015	319	\$54	4,141	\$701	10,458	\$1,769	0.05	\$1,246.20	
15	2030	0.1701	5,998	\$1,020	319	\$54	4,141	\$704	10,458	\$1,779	0.05	\$1,255.99	
16	2031	0.1704	5,998	\$1,022	319	\$54	4,141	\$705	10,458	\$1,782	0.05	\$1,258.63	
17	2032	0.1705	5,998	\$1,023	319	\$54	4,141	\$706	10,458	\$1,783	0.05	\$1,260.13	
18	2033	0.1707	5,998	\$1,024	319	\$54	4,141	\$707	10,458	\$1,786	0.05	\$1,262.77	
19	2034	0.1710	5,998	\$1,026	319	\$55	4,141	\$708	10,458	\$1,789	0.05	\$1,265.78	
20	2035	0.1713	5,998	\$1,027	319	\$55	4,141	\$709	10,458	\$1,791	0.05	\$1,268.42	
21	2036	0.1714	5,998	\$1,028	319	\$55	4,141	\$710	10,458	\$1,793	0.05	\$1,269.92	
22	2037	0.1717	5,998	\$1,030	319	\$55	4,141	\$711	10,458	\$1,795	0.05	\$1,272.56	
23	2038	0.1720	5,998	\$1,031	319	\$55	4,141	\$712	10,458	\$1,798	0.05	\$1,275.57	
24	2039	0.1722	5,998	\$1,033	319	\$55	4,141	\$713	10,458	\$1,801	0.05	\$1,278.20	
25	2040	0.1724	5,998	\$1,034	319	\$55	4,141	\$714	10,458	\$1,803	0.05	\$1,279.71	
26	2041	0.1734	5,998	\$1,040	319	\$55	4,141	\$718	10,458	\$1,813	0.05	\$1,290.14	
27	2042	0.1744	5,998	\$1,046	319	\$56	4,141	\$722	10,458	\$1,824	0.05	\$1,300.63	
28	2043	0.1754	5,998	\$1,052	319	\$56	4,141	\$726	10,458	\$1,834	0.05	\$1,311.17	
29	2044	0.1764	5,998	\$1,058	319	\$56	4,141	\$730	10,458	\$1,845	0.05	\$1,321.78	
30	2045	0.1774	5,998	\$1,064	319	\$57	4,141	\$735	10,458	\$1,855	0.05	\$1,332.46	
31	2046	0.1784	5,998	\$1,070	319	\$57	4,141	\$739	10,458	\$1,866	0.05	\$1,343.19	
32	2047	0.1795	5,998	\$1,076	319	\$57	4,141	\$743	10,458	\$1,877	0.05	\$1,353.98	
33	2048	0.1805	5,998	\$1,083	319	\$58	4,141	\$747	10,458	\$1,888	0.05	\$1,364.84	
34	2049	0.1816	5,998	\$1,089	319	\$58	4,141	\$752	10,458	\$1,899	0.05	\$1,375.76	
35	2050	0.1826	5,998	\$1,095	319	\$58	4,141	\$756	10,458	\$1,910	0.05	\$1,386.75	
36	2051	0.1837	5,998	\$1,102	319	\$59	4,141	\$761	10,458	\$1,921	0.05	\$1,397.79	
37	2052	0.1847	5,998	\$1,108	319	\$59	4,141	\$765	10,458	\$1,932	0.05	\$1,408.90	
38	2053	0.1858	5,998	\$1,114	319	\$59	4,141	\$769	10,458	\$1,943	0.05	\$1,420.08	
39	2054	0.1869	5,998	\$1,121	319	\$60	4,141	\$774	10,458	\$1,954	0.05	\$1,431.32	
40	2055	0.1879	5,998	\$1,127	319	\$60	4,141	\$778	10,458	\$1,966	0.05	\$1,442.62	
41	2056	0.1890	5,998	\$1,134	319	\$60	4,141	\$783	10,458	\$1,977	0.05	\$1,453.99	
42	2057	0.1901	5,998	\$1,140	319	\$61	4,141	\$787	10,458	\$1,988	0.05	\$1,465.43	
43	2058	0.1912	5,998	\$1,147	319	\$61	4,141	\$792	10,458	\$2,000	0.05	\$1,476.93	
44	2059	0.1923	5,998	\$1,154	319	\$61	4,141	\$796	10,458	\$2,011	0.05	\$1,488.50	
45	2060	0.1934	5,998	\$1,160	319	\$62	4,141	\$801	10,458	\$2,023	0.05	\$1,500.14	
46	2061	0.1946	5,998	\$1,167	319	\$62	4,141	\$806	10,458	\$2,035	0.05	\$1,511.84	
47	2062	0.1957	5,998	\$1,174	319	\$62	4,141	\$810	10,458	\$2,047	0.05	\$1,523.61	
48	2063	0.1968	5,998	\$1,181	319	\$63	4,141	\$815	10,458	\$2,058	0.05	\$1,535.45	
49	2064	0.1980	5,998	\$1,187	319	\$63	4,141	\$820	10,458	\$2,070	0.05	\$1,547.36	
50	2065	0.1991	5,998	\$1,194	319	\$64	4,141	\$824	10,458	\$2,082	0.05	\$1,559.33	
51	2066	0.2003	5,998	\$1,201	319	\$64	4,141	\$829	10,458	\$2,094	0.05	\$1,571.38	
52	2067	0.2014	5,998	\$1,208	319	\$64	4,141	\$834	10,458	\$2,106	0.05	\$1,583.49	
53	2068	0.2026	5,998	\$1,215	319	\$65	4,141	\$839	10,458	\$2,119	0.05	\$1,595.68	
54	2069	0.2038	5,998	\$1,222	319	\$65	4,141	\$844	10,458	\$2,131	0.05	\$1,607.93	
55	2070	0.2049	5,998	\$1,229	319	\$65	4,141	\$849	10,458	\$2,143	0.05	\$1,620.26	
56	2071	0.2061	5,998	\$1,236	319	\$66	4,141	\$854	10,458	\$2,156	0.05	\$1,632.66	
57	2072	0.2073	5,998	\$1,243	319	\$66	4,141	\$858	10,458	\$2,168	0.05	\$1,645.13	
58	2073	0.2085	5,998	\$1,251	319	\$67	4,141	\$863	10,458	\$2,181	0.05	\$1,657.67	
59	2074	0.2097	5,998	\$1,258	319	\$67	4,141	\$868	10,458	\$2,193	0.05	\$1,670.28	
60	2075	0.2109	5,998	\$1,265	319	\$67	4,141	\$873	10,458	\$2,206	0.05	\$1,682.97	

Table D1-1.59: Annual Operating Costs (H.GSHP) of a 2,000 square feet detached house above grade (average construction type) in the city of Ottawa (two life cycles and three life cycles for a 60 year project lifespan); base case scenario in comparison with feed in-tariff (FIT) scenario. In the FIT scenario, an incentive of \$0.05/KWh is provided on electricity bills throughout the project lifespan

Traditional HVAC Applications

Base Case Scenario															Carbon Taxes							
#	Year	Electricity Rates	Natural Gas Rates	Heating		Heating Operating Cost	Heating Operating Cost	Total Heating Operating Cost	Cooling	Cooling Operating Cost	Hot Water	Hot Water Operating Cost	Total	Total	Total Electricity Operating Cost	Total Natural Gas Operating Cost	Total	Conversion of m ³ into Tons	Total Tons	Carbon Tax	Operating Costs	
				KWh (Electricity)	m ³ (Gas)																	\$ (Electricity)
1	2016	0.1501	0.3458	1.662	2.786	\$249	\$963	\$1,213	1,327	\$199	1,047	\$362	2,989	3,833	449	\$1,326	\$1,774	6.94	6.94	\$10	\$69.38	\$1,843.54
2	2017	0.1542	0.3588	1.662	2.786	\$256	\$1,000	\$1,256	1,327	\$205	1,047	\$161	2,989	3,833	461	\$1,375	\$1,836	6.94	6.94	\$20	\$138.75	\$1,975.04
3	2018	0.1583	0.3718	1.662	2.786	\$263	\$1,036	\$1,299	1,327	\$210	1,047	\$166	2,989	3,833	473	\$1,425	\$1,898	6.94	6.94	\$30	\$208.13	\$2,106.54
4	2019	0.1625	0.3776	1.662	2.786	\$270	\$1,052	\$1,322	1,327	\$216	1,047	\$170	2,989	3,833	486	\$1,447	\$1,933	6.94	6.94	\$40	\$277.51	\$2,210.61
5	2020	0.1668	0.3841	1.662	2.786	\$277	\$1,070	\$1,347	1,327	\$221	1,047	\$175	2,989	3,833	499	\$1,472	\$1,971	6.94	6.94	\$50	\$346.89	\$2,317.61
6	2021	0.1621	0.3883	1.662	2.786	\$269	\$1,082	\$1,351	1,327	\$215	1,047	\$170	2,989	3,833	485	\$1,488	\$1,973	6.94	6.94	\$60	\$416.26	\$2,389.24
7	2022	0.1629	0.3929	1.662	2.786	\$271	\$1,095	\$1,365	1,327	\$216	1,047	\$171	2,989	3,833	487	\$1,506	\$1,993	6.94	6.94	\$70	\$485.64	\$2,478.58
8	2023	0.1639	0.3967	1.662	2.786	\$272	\$1,105	\$1,378	1,327	\$217	1,047	\$172	2,989	3,833	490	\$1,521	\$2,010	6.94	6.94	\$80	\$555.02	\$2,565.42
9	2024	0.1648	0.4005	1.662	2.786	\$274	\$1,116	\$1,390	1,327	\$219	1,047	\$173	2,989	3,833	493	\$1,535	\$2,028	6.94	6.94	\$90	\$624.40	\$2,652.26
10	2025	0.1656	0.4040	1.662	2.786	\$275	\$1,125	\$1,401	1,327	\$220	1,047	\$173	2,989	3,833	495	\$1,548	\$2,043	6.94	6.94	\$100	\$693.77	\$2,737.20
11	2026	0.1665	0.4070	1.662	2.786	\$277	\$1,134	\$1,411	1,327	\$221	1,047	\$174	2,989	3,833	498	\$1,560	\$2,058	6.94	6.94	\$110	\$763.15	\$2,821.10
12	2027	0.1674	0.4097	1.662	2.786	\$278	\$1,141	\$1,420	1,327	\$222	1,047	\$175	2,989	3,833	500	\$1,570	\$2,071	6.94	6.94	\$120	\$832.53	\$2,903.43
13	2028	0.1683	0.4124	1.662	2.786	\$280	\$1,149	\$1,429	1,327	\$223	1,047	\$176	2,989	3,833	503	\$1,581	\$2,084	6.94	6.94	\$130	\$901.90	\$2,985.55
14	2029	0.1692	0.4151	1.662	2.786	\$281	\$1,156	\$1,438	1,327	\$224	1,047	\$177	2,989	3,833	506	\$1,591	\$2,097	6.94	6.94	\$140	\$971.28	\$3,067.88
15	2030	0.1701	0.4170	1.662	2.786	\$283	\$1,162	\$1,444	1,327	\$226	1,047	\$178	2,989	3,833	508	\$1,598	\$2,107	6.94	6.94	\$150	\$1,040.66	\$3,147.39
16	2031	0.1704	0.4189	1.662	2.786	\$283	\$1,167	\$1,450	1,327	\$226	1,047	\$178	2,989	3,833	509	\$1,606	\$2,115	6.94	6.94	\$160	\$1,110.04	\$3,224.85
17	2032	0.1705	0.4204	1.662	2.786	\$283	\$1,171	\$1,455	1,327	\$226	1,047	\$179	2,989	3,833	510	\$1,612	\$2,121	6.94	6.94	\$170	\$1,179.41	\$3,300.52
18	2033	0.1707	0.4223	1.662	2.786	\$284	\$1,177	\$1,460	1,327	\$227	1,047	\$179	2,989	3,833	510	\$1,619	\$2,129	6.94	6.94	\$180	\$1,248.79	\$3,377.99
19	2034	0.1710	0.4246	1.662	2.786	\$284	\$1,183	\$1,467	1,327	\$227	1,047	\$179	2,989	3,833	511	\$1,628	\$2,139	6.94	6.94	\$190	\$1,318.17	\$3,457.02
20	2035	0.1713	0.4265	1.662	2.786	\$285	\$1,188	\$1,473	1,327	\$227	1,047	\$179	2,989	3,833	512	\$1,635	\$2,147	6.94	6.94	\$200	\$1,387.55	\$3,534.49
21	2036	0.1714	0.4288	1.662	2.786	\$285	\$1,195	\$1,480	1,327	\$227	1,047	\$179	2,989	3,833	512	\$1,644	\$2,156	6.94	6.94	\$210	\$1,456.92	\$3,613.09
22	2037	0.1717	0.4311	1.662	2.786	\$285	\$1,201	\$1,486	1,327	\$228	1,047	\$180	2,989	3,833	513	\$1,653	\$2,166	6.94	6.94	\$220	\$1,526.30	\$3,692.02
23	2038	0.1720	0.4331	1.662	2.786	\$286	\$1,206	\$1,492	1,327	\$228	1,047	\$180	2,989	3,833	514	\$1,660	\$2,174	6.94	6.94	\$230	\$1,595.68	\$3,769.59
24	2039	0.1722	0.4353	1.662	2.786	\$286	\$1,213	\$1,499	1,327	\$229	1,047	\$180	2,989	3,833	515	\$1,669	\$2,183	6.94	6.94	\$240	\$1,665.06	\$3,848.52
25	2040	0.1724	0.4376	1.662	2.786	\$286	\$1,219	\$1,506	1,327	\$229	1,047	\$180	2,989	3,833	515	\$1,677	\$2,193	6.94	6.94	\$250	\$1,734.43	\$3,927.12
26	2041	0.1734	0.4420	1.662	2.786	\$288	\$1,231	\$1,519	1,327	\$230	1,047	\$182	2,989	3,833	518	\$1,694	\$2,212	6.94	6.94	\$260	\$1,803.81	\$4,016.02
27	2042	0.1744	0.4463	1.662	2.786	\$290	\$1,243	\$1,533	1,327	\$231	1,047	\$183	2,989	3,833	521	\$1,711	\$2,232	6.94	6.94	\$270	\$1,873.19	\$4,105.10
28	2043	0.1754	0.4507	1.662	2.786	\$291	\$1,256	\$1,547	1,327	\$233	1,047	\$184	2,989	3,833	524	\$1,728	\$2,252	6.94	6.94	\$280	\$1,942.56	\$4,194.35
29	2044	0.1764	0.4552	1.662	2.786	\$293	\$1,268	\$1,561	1,327	\$234	1,047	\$185	2,989	3,833	527	\$1,745	\$2,272	6.94	6.94	\$290	\$2,011.94	\$4,283.80
30	2045	0.1774	0.4596	1.662	2.786	\$295	\$1,281	\$1,575	1,327	\$235	1,047	\$186	2,989	3,833	530	\$1,762	\$2,292	6.94	6.94	\$300	\$2,081.32	\$4,373.42
31	2046	0.1784	0.4642	1.662	2.786	\$297	\$1,293	\$1,590	1,327	\$237	1,047	\$187	2,989	3,833	533	\$1,779	\$2,313	6.94	6.94	\$310	\$2,150.70	\$4,463.24
32	2047	0.1795	0.4688	1.662	2.786	\$298	\$1,306	\$1,604	1,327	\$238	1,047	\$188	2,989	3,833	536	\$1,797	\$2,333	6.94	6.94	\$320	\$2,220.07	\$4,553.24
33	2048	0.1805	0.4734	1.662	2.786	\$300	\$1,319	\$1,619	1,327	\$240	1,047	\$189	2,989	3,833	540	\$1,814	\$2,354	6.94	6.94	\$330	\$2,289.45	\$4,643.44
34	2049	0.1816	0.4780	1.662	2.786	\$302	\$1,332	\$1,634	1,327	\$241	1,047	\$190	2,989	3,833	543	\$1,832	\$2,375	6.94	6.94	\$340	\$2,358.83	\$4,733.82
35	2050	0.1826	0.4828	1.662	2.786	\$303	\$1,345	\$1,648	1,327	\$242	1,047	\$191	2,989	3,833	546	\$1,850	\$2,396	6.94	6.94	\$350	\$2,428.21	\$4,824.41
36	2051	0.1837	0.4875	1.662	2.786	\$305	\$1,358	\$1,663	1,327	\$244	1,047	\$192	2,989	3,833	549	\$1,869	\$2,418	6.94	6.94	\$360	\$2,497.58	\$4,915.18
37	2052	0.1847	0.4923	1.662	2.786	\$307	\$1,372	\$1,679	1,327	\$245	1,047	\$193	2,989	3,833	552	\$1,887	\$2,439	6.94	6.94	\$370	\$2,566.96	\$5,006.16
38	2053	0.1858	0.4972	1.662	2.786	\$309	\$1,385	\$1,694	1,327	\$247	1,047	\$195	2,989	3,833	555	\$1,906	\$2,461	6.94	6.94	\$380	\$2,636.34	\$5,097.33
39	2054	0.1869	0.5021	1.662	2.786	\$311	\$1,399	\$1,709	1,327	\$248	1,047	\$196	2,989	3,833	559	\$1,924	\$2,483	6.94	6.94	\$390	\$2,705.71	\$5,188.71
40	2055	0.1879	0.5070	1.662	2.786	\$312	\$1,413	\$1,725	1,327	\$249	1,047	\$197	2,989	3,833	562	\$1,943	\$2,505	6.94	6.94	\$400	\$2,775.09	\$5,280.29
41	2056	0.1890	0.5120	1.662	2.786	\$314	\$1,427	\$1,741	1,327	\$251	1,047	\$198	2,989	3,833	565	\$1,963	\$2,528	6.94	6.94	\$410	\$2,844.47	\$5,372.08
42	2057	0.1901	0.5171	1.662	2.786	\$316	\$1,441	\$1,757	1,327	\$252	1,047	\$199	2,989	3,833	568	\$1,982	\$2,550	6.94	6.94	\$420	\$2,913.85	\$5,464.08
43	2058	0.1912	0.5222	1.662	2.786	\$318	\$1,455	\$1,773	1,327	\$254	1,047	\$200	2,989	3,833	572	\$2,001	\$2,573	6.94	6.94	\$430	\$2,983.22	\$5,556.28
44	2059	0.1923	0.5273	1.662	2.786	\$320	\$1,469	\$1,789	1,327	\$255	1,047	\$201	2,989	3,833	575	\$2,021	\$2,596	6.94	6.94	\$440	\$3,052.60	\$5,648.70
45	2060	0.1934	0.5325	1.662	2.786	\$322	\$1,484	\$1,805	1,327	\$257	1,047	\$203	2,989	3,833	578	\$2,041	\$2,619	6.94	6.94	\$450	\$3,121.98	\$5,741.33
46	2061	0.1946	0.5378	1.662	2.786	\$323	\$1,498	\$1,822	1,327	\$258	1,047	\$204	2,989	3,833	582	\$2,061	\$2,643	6.94	6.94	\$460	\$3,191.36	\$5,834.17
47	2062	0.1957	0.5431	1.662	2.786	\$325	\$1,513	\$1,838	1,327	\$260	1,047	\$205	2,989	3,833	585	\$2,082	\$2,667	6.94	6.94	\$470	\$3,260.73	\$5,927.24
48	2063	0.1968	0.5484	1.662	2.786	\$327	\$1,528	\$1,855	1,327	\$261	1,047	\$206	2,989	3,833	588	\$2,102	\$2,690	6.94	6.94	\$480	\$3,330.11	\$6,020.52
49	2064	0.1980	0.5538	1.662	2.786	\$329	\$1,543	\$1,872	1,327	\$263	1,047	\$207	2,989	3,833	592	\$2,123	\$2,715	6.94	6.94	\$490	\$3,399.49	\$6,114.03
50	2065	0.1991	0.5593	1.662	2.786	\$331	\$1,558	\$1,889	1,327	\$264	1,047	\$208	2,989	3,833	595	\$2,144	\$2,739	6.94	6.94	\$500	\$3,468.87	\$6,207.75
51	2066	0.2003	0.5648	1.662	2.786	\$333	\$1,574	\$1,906	1,327	\$266	1,047	\$210	2,989	3,833	599	\$2,165	\$2,763	6.94	6.94	\$510	\$3,538.24	\$6,301.71
52	2067	0.2014	0.5704	1.662	2.786	\$335	\$1,589	\$1,924	1,327	\$267	1,047	\$211	2,989	3,833	602	\$2,186	\$2,788	6.94	6.94	\$520	\$3,607.62	\$6,395.89
53	2068	0.2026	0.5760	1.662	2.786	\$337	\$1,605	\$1,941	1,327	\$269	1,047	\$212	2,989	3,								

21. Kapuskasing (North) – Annual Operating Costs

Vertical Ground Source Heat Pump (V.GSHP)

Base Case Scenario											Feed in Tariff (FIT)		
#	Year	Electricity Rates		V.GSHP		Hot Water		Total	Total Operating Cost	Incentives (\$/KWh)	FIT		
		\$/KWh	KWh	Heating Operating Cost	Cooling	Cooling Operating Cost	Hot Water Operating Cost				\$/KWh	Operating Cost	
1	2016	0.1501	8,933	\$1,341	179	\$27	3,918	\$588	13,030	\$1,956	0.05	0.1001	\$1,304.08
2	2017	0.1542	8,933	\$1,377	179	\$28	3,918	\$604	13,030	\$2,009	0.05	0.1042	\$1,357.55
3	2018	0.1583	8,933	\$1,414	179	\$28	3,918	\$620	13,030	\$2,063	0.05	0.1083	\$1,411.03
4	2019	0.1625	8,933	\$1,452	179	\$29	3,918	\$637	13,030	\$2,118	0.05	0.1125	\$1,466.38
5	2020	0.1668	8,933	\$1,490	179	\$30	3,918	\$653	13,030	\$2,173	0.05	0.1168	\$1,521.73
6	2021	0.1621	8,933	\$1,448	179	\$29	3,918	\$635	13,030	\$2,113	0.05	0.1121	\$1,461.22
7	2022	0.1629	8,933	\$1,455	179	\$29	3,918	\$638	13,030	\$2,123	0.05	0.1129	\$1,471.54
8	2023	0.1639	8,933	\$1,464	179	\$29	3,918	\$642	13,030	\$2,135	0.05	0.1139	\$1,483.74
9	2024	0.1648	8,933	\$1,472	179	\$30	3,918	\$646	13,030	\$2,147	0.05	0.1148	\$1,495.93
10	2025	0.1656	8,933	\$1,479	179	\$30	3,918	\$649	13,030	\$2,158	0.05	0.1156	\$1,506.25
11	2026	0.1665	8,933	\$1,488	179	\$30	3,918	\$652	13,030	\$2,170	0.05	0.1165	\$1,518.45
12	2027	0.1674	8,933	\$1,496	179	\$30	3,918	\$656	13,030	\$2,182	0.05	0.1174	\$1,530.17
13	2028	0.1683	8,933	\$1,503	179	\$30	3,918	\$659	13,030	\$2,192	0.05	0.1183	\$1,540.96
14	2029	0.1692	8,933	\$1,511	179	\$30	3,918	\$663	13,030	\$2,204	0.05	0.1192	\$1,552.69
15	2030	0.1701	8,933	\$1,519	179	\$30	3,918	\$666	13,030	\$2,216	0.05	0.1201	\$1,564.89
16	2031	0.1704	8,933	\$1,522	179	\$30	3,918	\$667	13,030	\$2,220	0.05	0.1204	\$1,568.17
17	2032	0.1705	8,933	\$1,523	179	\$31	3,918	\$668	13,030	\$2,222	0.05	0.1205	\$1,570.05
18	2033	0.1707	8,933	\$1,525	179	\$31	3,918	\$669	13,030	\$2,225	0.05	0.1207	\$1,573.33
19	2034	0.1710	8,933	\$1,528	179	\$31	3,918	\$670	13,030	\$2,229	0.05	0.1210	\$1,577.08
20	2035	0.1713	8,933	\$1,530	179	\$31	3,918	\$671	13,030	\$2,232	0.05	0.1213	\$1,580.36
21	2036	0.1714	8,933	\$1,531	179	\$31	3,918	\$672	13,030	\$2,234	0.05	0.1214	\$1,582.74
22	2037	0.1717	8,933	\$1,534	179	\$31	3,918	\$673	13,030	\$2,237	0.05	0.1217	\$1,585.52
23	2038	0.1720	8,933	\$1,536	179	\$31	3,918	\$674	13,030	\$2,241	0.05	0.1220	\$1,589.28
24	2039	0.1722	8,933	\$1,538	179	\$31	3,918	\$675	13,030	\$2,244	0.05	0.1222	\$1,592.56
25	2040	0.1724	8,933	\$1,540	179	\$31	3,918	\$675	13,030	\$2,246	0.05	0.1224	\$1,594.44
26	2041	0.1734	8,933	\$1,549	179	\$31	3,918	\$679	13,030	\$2,259	0.05	0.1234	\$1,607.43
27	2042	0.1744	8,933	\$1,558	179	\$31	3,918	\$683	13,030	\$2,272	0.05	0.1244	\$1,620.50
28	2043	0.1754	8,933	\$1,567	179	\$31	3,918	\$687	13,030	\$2,285	0.05	0.1254	\$1,633.64
29	2044	0.1764	8,933	\$1,576	179	\$32	3,918	\$691	13,030	\$2,298	0.05	0.1264	\$1,646.86
30	2045	0.1774	8,933	\$1,585	179	\$32	3,918	\$695	13,030	\$2,312	0.05	0.1274	\$1,660.16
31	2046	0.1784	8,933	\$1,594	179	\$32	3,918	\$699	13,030	\$2,325	0.05	0.1284	\$1,673.53
32	2047	0.1795	8,933	\$1,603	179	\$32	3,918	\$703	13,030	\$2,338	0.05	0.1295	\$1,686.98
33	2048	0.1805	8,933	\$1,612	179	\$32	3,918	\$707	13,030	\$2,352	0.05	0.1305	\$1,700.51
34	2049	0.1816	8,933	\$1,622	179	\$32	3,918	\$711	13,030	\$2,366	0.05	0.1316	\$1,714.11
35	2050	0.1826	8,933	\$1,631	179	\$33	3,918	\$715	13,030	\$2,379	0.05	0.1326	\$1,727.80
36	2051	0.1837	8,933	\$1,641	179	\$33	3,918	\$720	13,030	\$2,393	0.05	0.1337	\$1,741.56
37	2052	0.1847	8,933	\$1,650	179	\$33	3,918	\$724	13,030	\$2,407	0.05	0.1347	\$1,755.40
38	2053	0.1858	8,933	\$1,660	179	\$33	3,918	\$728	13,030	\$2,421	0.05	0.1358	\$1,769.33
39	2054	0.1869	8,933	\$1,669	179	\$33	3,918	\$732	13,030	\$2,435	0.05	0.1369	\$1,783.33
40	2055	0.1879	8,933	\$1,679	179	\$34	3,918	\$736	13,030	\$2,449	0.05	0.1379	\$1,797.42
41	2056	0.1890	8,933	\$1,689	179	\$34	3,918	\$741	13,030	\$2,463	0.05	0.1390	\$1,811.58
42	2057	0.1901	8,933	\$1,698	179	\$34	3,918	\$745	13,030	\$2,477	0.05	0.1401	\$1,825.83
43	2058	0.1912	8,933	\$1,708	179	\$34	3,918	\$749	13,030	\$2,492	0.05	0.1412	\$1,840.16
44	2059	0.1923	8,933	\$1,718	179	\$34	3,918	\$754	13,030	\$2,506	0.05	0.1423	\$1,854.58
45	2060	0.1934	8,933	\$1,728	179	\$35	3,918	\$758	13,030	\$2,521	0.05	0.1434	\$1,869.07
46	2061	0.1946	8,933	\$1,738	179	\$35	3,918	\$762	13,030	\$2,535	0.05	0.1446	\$1,883.66
47	2062	0.1957	8,933	\$1,748	179	\$35	3,918	\$767	13,030	\$2,550	0.05	0.1457	\$1,898.32
48	2063	0.1968	8,933	\$1,758	179	\$35	3,918	\$771	13,030	\$2,565	0.05	0.1468	\$1,913.07
49	2064	0.1980	8,933	\$1,768	179	\$35	3,918	\$776	13,030	\$2,579	0.05	0.1480	\$1,927.91
50	2065	0.1991	8,933	\$1,779	179	\$36	3,918	\$780	13,030	\$2,594	0.05	0.1491	\$1,942.83
51	2066	0.2003	8,933	\$1,789	179	\$36	3,918	\$785	13,030	\$2,609	0.05	0.1503	\$1,957.84
52	2067	0.2014	8,933	\$1,799	179	\$36	3,918	\$789	13,030	\$2,624	0.05	0.1514	\$1,972.93
53	2068	0.2026	8,933	\$1,810	179	\$36	3,918	\$794	13,030	\$2,640	0.05	0.1526	\$1,988.11
54	2069	0.2038	8,933	\$1,820	179	\$36	3,918	\$798	13,030	\$2,655	0.05	0.1538	\$2,003.38
55	2070	0.2049	8,933	\$1,831	179	\$37	3,918	\$803	13,030	\$2,670	0.05	0.1549	\$2,018.74
56	2071	0.2061	8,933	\$1,841	179	\$37	3,918	\$808	13,030	\$2,686	0.05	0.1561	\$2,034.19
57	2072	0.2073	8,933	\$1,852	179	\$37	3,918	\$812	13,030	\$2,701	0.05	0.1573	\$2,049.72
58	2073	0.2085	8,933	\$1,863	179	\$37	3,918	\$817	13,030	\$2,717	0.05	0.1585	\$2,065.35
59	2074	0.2097	8,933	\$1,873	179	\$38	3,918	\$822	13,030	\$2,733	0.05	0.1597	\$2,081.07
60	2075	0.2109	8,933	\$1,884	179	\$38	3,918	\$826	13,030	\$2,748	0.05	0.1609	\$2,096.87

Table D1-1.61: Annual Operating Costs (V.GSHP) of a 2,000 square feet detached house above grade (average construction type) in the city of Kapuskasing (two life cycles and three life cycles for a 60 year project lifespan); base case scenario in comparison with feed in-tariff (FIT) scenario. In the FIT scenario, an incentive of \$0.05/KWh is provided on electricity bills throughout the project lifespan

Horizontal Ground Source Heat Pump (H.GSHP)

Base Case Scenario											Feed in Tariff (FIT)		
#	Year	H.GSHP									FIT		
		Electricity Rates \$/KWh	Heating KWh	Heating Operating Cost \$	Cooling KWh	Cooling Operating Cost \$	Hot Water KWh	Hot Water Operating Cost \$	Total KWh	Total Operating Cost \$	Incentives (\$/KWh)	S/KWh	Operating Cost
1	2016	0.1501	9,050	\$1,358	184	\$28	3,916	\$588	13,150	\$1,974	0.05	0.1001	\$1,316.09
2	2017	0.1542	9,050	\$1,395	184	\$28	3,916	\$604	13,150	\$2,028	0.05	0.1042	\$1,370.06
3	2018	0.1583	9,050	\$1,433	184	\$29	3,916	\$620	13,150	\$2,082	0.05	0.1083	\$1,424.02
4	2019	0.1625	9,050	\$1,471	184	\$30	3,916	\$637	13,150	\$2,137	0.05	0.1125	\$1,479.88
5	2020	0.1668	9,050	\$1,509	184	\$31	3,916	\$653	13,150	\$2,193	0.05	0.1168	\$1,535.74
6	2021	0.1621	9,050	\$1,467	184	\$30	3,916	\$635	13,150	\$2,132	0.05	0.1121	\$1,474.68
7	2022	0.1629	9,050	\$1,475	184	\$30	3,916	\$638	13,150	\$2,143	0.05	0.1129	\$1,485.09
8	2023	0.1639	9,050	\$1,483	184	\$30	3,916	\$642	13,150	\$2,155	0.05	0.1139	\$1,497.40
9	2024	0.1648	9,050	\$1,492	184	\$30	3,916	\$645	13,150	\$2,167	0.05	0.1148	\$1,509.71
10	2025	0.1656	9,050	\$1,499	184	\$30	3,916	\$648	13,150	\$2,178	0.05	0.1156	\$1,520.12
11	2026	0.1665	9,050	\$1,507	184	\$31	3,916	\$652	13,150	\$2,190	0.05	0.1165	\$1,532.43
12	2027	0.1674	9,050	\$1,515	184	\$31	3,916	\$656	13,150	\$2,202	0.05	0.1174	\$1,544.27
13	2028	0.1683	9,050	\$1,523	184	\$31	3,916	\$659	13,150	\$2,213	0.05	0.1183	\$1,555.15
14	2029	0.1692	9,050	\$1,531	184	\$31	3,916	\$662	13,150	\$2,224	0.05	0.1192	\$1,566.99
15	2030	0.1701	9,050	\$1,539	184	\$31	3,916	\$666	13,150	\$2,237	0.05	0.1201	\$1,579.30
16	2031	0.1704	9,050	\$1,542	184	\$31	3,916	\$667	13,150	\$2,240	0.05	0.1204	\$1,582.61
17	2032	0.1705	9,050	\$1,543	184	\$31	3,916	\$668	13,150	\$2,242	0.05	0.1205	\$1,584.50
18	2033	0.1707	9,050	\$1,545	184	\$31	3,916	\$669	13,150	\$2,245	0.05	0.1207	\$1,587.82
19	2034	0.1710	9,050	\$1,548	184	\$31	3,916	\$670	13,150	\$2,249	0.05	0.1210	\$1,591.61
20	2035	0.1713	9,050	\$1,550	184	\$32	3,916	\$671	13,150	\$2,252	0.05	0.1213	\$1,594.92
21	2036	0.1714	9,050	\$1,551	184	\$32	3,916	\$671	13,150	\$2,254	0.05	0.1214	\$1,596.81
22	2037	0.1717	9,050	\$1,554	184	\$32	3,916	\$672	13,150	\$2,258	0.05	0.1217	\$1,600.13
23	2038	0.1720	9,050	\$1,556	184	\$32	3,916	\$673	13,150	\$2,261	0.05	0.1220	\$1,603.91
24	2039	0.1722	9,050	\$1,559	184	\$32	3,916	\$674	13,150	\$2,265	0.05	0.1222	\$1,607.23
25	2040	0.1724	9,050	\$1,560	184	\$32	3,916	\$675	13,150	\$2,267	0.05	0.1224	\$1,609.12
26	2041	0.1734	9,050	\$1,569	184	\$32	3,916	\$679	13,150	\$2,280	0.05	0.1234	\$1,622.23
27	2042	0.1744	9,050	\$1,578	184	\$32	3,916	\$683	13,150	\$2,293	0.05	0.1244	\$1,635.42
28	2043	0.1754	9,050	\$1,587	184	\$32	3,916	\$687	13,150	\$2,306	0.05	0.1254	\$1,648.69
29	2044	0.1764	9,050	\$1,596	184	\$32	3,916	\$691	13,150	\$2,320	0.05	0.1264	\$1,662.03
30	2045	0.1774	9,050	\$1,606	184	\$33	3,916	\$695	13,150	\$2,333	0.05	0.1274	\$1,675.44
31	2046	0.1784	9,050	\$1,615	184	\$33	3,916	\$699	13,150	\$2,346	0.05	0.1284	\$1,688.94
32	2047	0.1795	9,050	\$1,624	184	\$33	3,916	\$703	13,150	\$2,360	0.05	0.1295	\$1,702.51
33	2048	0.1805	9,050	\$1,634	184	\$33	3,916	\$707	13,150	\$2,374	0.05	0.1305	\$1,716.17
34	2049	0.1816	9,050	\$1,643	184	\$33	3,916	\$711	13,150	\$2,387	0.05	0.1316	\$1,729.90
35	2050	0.1826	9,050	\$1,653	184	\$34	3,916	\$715	13,150	\$2,401	0.05	0.1326	\$1,743.71
36	2051	0.1837	9,050	\$1,662	184	\$34	3,916	\$719	13,150	\$2,415	0.05	0.1337	\$1,757.60
37	2052	0.1847	9,050	\$1,672	184	\$34	3,916	\$723	13,150	\$2,429	0.05	0.1347	\$1,771.57
38	2053	0.1858	9,050	\$1,681	184	\$34	3,916	\$728	13,150	\$2,443	0.05	0.1358	\$1,785.62
39	2054	0.1869	9,050	\$1,691	184	\$34	3,916	\$732	13,150	\$2,457	0.05	0.1369	\$1,799.76
40	2055	0.1879	9,050	\$1,701	184	\$35	3,916	\$736	13,150	\$2,471	0.05	0.1379	\$1,813.97
41	2056	0.1890	9,050	\$1,711	184	\$35	3,916	\$740	13,150	\$2,486	0.05	0.1390	\$1,828.27
42	2057	0.1901	9,050	\$1,721	184	\$35	3,916	\$745	13,150	\$2,500	0.05	0.1401	\$1,842.65
43	2058	0.1912	9,050	\$1,731	184	\$35	3,916	\$749	13,150	\$2,515	0.05	0.1412	\$1,857.11
44	2059	0.1923	9,050	\$1,741	184	\$35	3,916	\$753	13,150	\$2,529	0.05	0.1423	\$1,871.66
45	2060	0.1934	9,050	\$1,751	184	\$36	3,916	\$758	13,150	\$2,544	0.05	0.1434	\$1,886.29
46	2061	0.1946	9,050	\$1,761	184	\$36	3,916	\$762	13,150	\$2,559	0.05	0.1446	\$1,901.00
47	2062	0.1957	9,050	\$1,771	184	\$36	3,916	\$766	13,150	\$2,573	0.05	0.1457	\$1,915.80
48	2063	0.1968	9,050	\$1,781	184	\$36	3,916	\$771	13,150	\$2,588	0.05	0.1468	\$1,930.69
49	2064	0.1980	9,050	\$1,792	184	\$36	3,916	\$775	13,150	\$2,603	0.05	0.1480	\$1,945.66
50	2065	0.1991	9,050	\$1,802	184	\$37	3,916	\$780	13,150	\$2,618	0.05	0.1491	\$1,960.72
51	2066	0.2003	9,050	\$1,812	184	\$37	3,916	\$784	13,150	\$2,633	0.05	0.1503	\$1,975.87
52	2067	0.2014	9,050	\$1,823	184	\$37	3,916	\$789	13,150	\$2,649	0.05	0.1514	\$1,991.10
53	2068	0.2026	9,050	\$1,833	184	\$37	3,916	\$793	13,150	\$2,664	0.05	0.1526	\$2,006.42
54	2069	0.2038	9,050	\$1,844	184	\$37	3,916	\$798	13,150	\$2,679	0.05	0.1538	\$2,021.83
55	2070	0.2049	9,050	\$1,855	184	\$38	3,916	\$803	13,150	\$2,695	0.05	0.1549	\$2,037.33
56	2071	0.2061	9,050	\$1,865	184	\$38	3,916	\$807	13,150	\$2,710	0.05	0.1561	\$2,052.92
57	2072	0.2073	9,050	\$1,876	184	\$38	3,916	\$812	13,150	\$2,726	0.05	0.1573	\$2,068.60
58	2073	0.2085	9,050	\$1,887	184	\$38	3,916	\$817	13,150	\$2,742	0.05	0.1585	\$2,084.37
59	2074	0.2097	9,050	\$1,898	184	\$39	3,916	\$821	13,150	\$2,758	0.05	0.1597	\$2,100.23
60	2075	0.2109	9,050	\$1,909	184	\$39	3,916	\$826	13,150	\$2,774	0.05	0.1609	\$2,116.19

Table D1-1.62: Annual Operating Costs (H.GSHP) of a 2,000 square feet detached house above grade (average construction type) in the city of Kapuskasing (two life cycles and three life cycles for a 60 year project lifespan); base case scenario in comparison with feed in-tariff (FIT) scenario. In the FIT scenario, an incentive of \$0.05/KWh is provided on electricity bills throughout the project lifespan

Traditional HVAC Applications

Base Case Scenario															Carbon Taxes							
#	Year	Electricity Rates	Natural Gas Rates	Heating		Heating Operating Cost	Heating Operating Cost	Total Heating Operating Cost	Cooling		Hot Water	Hot Water Operating Cost	Total	Total	Total Electricity Operating Cost	Total Natural Gas Operating Cost	Total	Conversion of m ³ into Tons	Total Tons	Carbon Tax	Operating Costs	
				KWh (Electricity)	m ³ (Gas)				KWh	Operating Cost												m ³
		\$/KWh	\$/m ³			\$(Electricity)	\$(Gas)	\$					KWh	m ³	\$(KWh)	\$(m ³)			10			
1	2016	0.1501	0.3458	2,659	3,907	\$399	\$1,351	\$1,750	859	\$129	1,103	\$381	3,518	5,010	528	\$1,733	\$2,261	9.07	9.07	\$10	\$90.68	\$2,351.28
2	2017	0.1542	0.3588	2,659	3,907	\$410	\$1,402	\$1,812	859	\$132	1,103	\$170	3,518	5,010	542	\$1,798	\$2,340	9.07	9.07	\$20	\$181.36	\$2,521.56
3	2018	0.1583	0.3718	2,659	3,907	\$421	\$1,453	\$1,874	859	\$136	1,103	\$175	3,518	5,010	557	\$1,863	\$2,420	9.07	9.07	\$30	\$272.04	\$2,691.85
4	2019	0.1625	0.3776	2,659	3,907	\$432	\$1,475	\$1,907	859	\$140	1,103	\$179	3,518	5,010	572	\$1,892	\$2,463	9.07	9.07	\$40	\$362.72	\$2,826.22
5	2020	0.1668	0.3841	2,659	3,907	\$443	\$1,501	\$1,944	859	\$143	1,103	\$184	3,518	5,010	587	\$1,924	\$2,511	9.07	9.07	\$50	\$453.41	\$2,964.43
6	2021	0.1621	0.3883	2,659	3,907	\$431	\$1,517	\$1,948	859	\$139	1,103	\$179	3,518	5,010	570	\$1,945	\$2,516	9.07	9.07	\$60	\$544.09	\$3,059.86
7	2022	0.1629	0.3929	2,659	3,907	\$433	\$1,535	\$1,968	859	\$140	1,103	\$180	3,518	5,010	573	\$1,968	\$2,542	9.07	9.07	\$70	\$634.77	\$3,176.32
8	2023	0.1639	0.3967	2,659	3,907	\$436	\$1,550	\$1,986	859	\$141	1,103	\$181	3,518	5,010	576	\$1,988	\$2,564	9.07	9.07	\$80	\$725.45	\$3,289.46
9	2024	0.1648	0.4005	2,659	3,907	\$438	\$1,565	\$2,003	859	\$142	1,103	\$182	3,518	5,010	580	\$2,007	\$2,586	9.07	9.07	\$90	\$816.13	\$3,402.60
10	2025	0.1656	0.4040	2,659	3,907	\$440	\$1,578	\$2,019	859	\$142	1,103	\$183	3,518	5,010	583	\$2,024	\$2,607	9.07	9.07	\$100	\$906.81	\$3,513.32
11	2026	0.1665	0.4070	2,659	3,907	\$443	\$1,590	\$2,033	859	\$143	1,103	\$184	3,518	5,010	586	\$2,039	\$2,625	9.07	9.07	\$110	\$997.49	\$3,622.63
12	2027	0.1674	0.4097	2,659	3,907	\$445	\$1,601	\$2,046	859	\$144	1,103	\$185	3,518	5,010	589	\$2,053	\$2,642	9.07	9.07	\$120	\$1,088.17	\$3,729.89
13	2028	0.1683	0.4124	2,659	3,907	\$447	\$1,611	\$2,059	859	\$145	1,103	\$186	3,518	5,010	592	\$2,066	\$2,658	9.07	9.07	\$130	\$1,178.85	\$3,836.90
14	2029	0.1692	0.4151	2,659	3,907	\$450	\$1,622	\$2,071	859	\$145	1,103	\$187	3,518	5,010	595	\$2,080	\$2,675	9.07	9.07	\$140	\$1,269.53	\$3,944.16
15	2030	0.1701	0.4170	2,659	3,907	\$452	\$1,629	\$2,081	859	\$146	1,103	\$188	3,518	5,010	598	\$2,089	\$2,688	9.07	9.07	\$150	\$1,360.22	\$4,047.72
16	2031	0.1704	0.4189	2,659	3,907	\$453	\$1,637	\$2,090	859	\$146	1,103	\$188	3,518	5,010	599	\$2,099	\$2,698	9.07	9.07	\$160	\$1,450.90	\$4,148.87
17	2032	0.1705	0.4204	2,659	3,907	\$453	\$1,643	\$2,096	859	\$146	1,103	\$188	3,518	5,010	600	\$2,106	\$2,706	9.07	9.07	\$170	\$1,541.58	\$4,247.72
18	2033	0.1707	0.4223	2,659	3,907	\$454	\$1,650	\$2,104	859	\$147	1,103	\$188	3,518	5,010	601	\$2,116	\$2,717	9.07	9.07	\$180	\$1,632.26	\$4,348.87
19	2034	0.1710	0.4246	2,659	3,907	\$455	\$1,659	\$2,114	859	\$147	1,103	\$189	3,518	5,010	602	\$2,127	\$2,729	9.07	9.07	\$190	\$1,722.94	\$4,452.07
20	2035	0.1713	0.4265	2,659	3,907	\$455	\$1,667	\$2,122	859	\$147	1,103	\$189	3,518	5,010	603	\$2,137	\$2,740	9.07	9.07	\$200	\$1,813.62	\$4,553.22
21	2036	0.1714	0.4288	2,659	3,907	\$456	\$1,675	\$2,131	859	\$147	1,103	\$189	3,518	5,010	603	\$2,149	\$2,752	9.07	9.07	\$210	\$1,904.30	\$4,655.31
22	2037	0.1717	0.4311	2,659	3,907	\$457	\$1,684	\$2,141	859	\$147	1,103	\$189	3,518	5,010	604	\$2,160	\$2,764	9.07	9.07	\$220	\$1,994.98	\$4,758.97
23	2038	0.1720	0.4331	2,659	3,907	\$457	\$1,692	\$2,149	859	\$148	1,103	\$190	3,518	5,010	605	\$2,170	\$2,775	9.07	9.07	\$230	\$2,085.66	\$4,860.25
24	2039	0.1722	0.4353	2,659	3,907	\$458	\$1,701	\$2,159	859	\$148	1,103	\$190	3,518	5,010	606	\$2,181	\$2,787	9.07	9.07	\$240	\$2,176.34	\$4,963.32
25	2040	0.1724	0.4376	2,659	3,907	\$458	\$1,710	\$2,168	859	\$148	1,103	\$190	3,518	5,010	606	\$2,193	\$2,799	9.07	9.07	\$250	\$2,267.03	\$5,066.00
26	2041	0.1734	0.4420	2,659	3,907	\$461	\$1,727	\$2,188	859	\$149	1,103	\$191	3,518	5,010	610	\$2,214	\$2,824	9.07	9.07	\$260	\$2,357.71	\$5,181.81
27	2042	0.1744	0.4463	2,659	3,907	\$464	\$1,744	\$2,207	859	\$150	1,103	\$192	3,518	5,010	613	\$2,236	\$2,849	9.07	9.07	\$270	\$2,448.39	\$5,297.85
28	2043	0.1754	0.4507	2,659	3,907	\$466	\$1,761	\$2,227	859	\$151	1,103	\$193	3,518	5,010	617	\$2,258	\$2,875	9.07	9.07	\$280	\$2,539.07	\$5,414.12
29	2044	0.1764	0.4552	2,659	3,907	\$469	\$1,778	\$2,247	859	\$152	1,103	\$195	3,518	5,010	621	\$2,280	\$2,901	9.07	9.07	\$290	\$2,629.75	\$5,530.64
30	2045	0.1774	0.4596	2,659	3,907	\$472	\$1,796	\$2,268	859	\$152	1,103	\$196	3,518	5,010	624	\$2,303	\$2,927	9.07	9.07	\$300	\$2,720.43	\$5,647.39
31	2046	0.1784	0.4642	2,659	3,907	\$474	\$1,814	\$2,288	859	\$153	1,103	\$197	3,518	5,010	628	\$2,326	\$2,953	9.07	9.07	\$310	\$2,811.11	\$5,764.38
32	2047	0.1795	0.4688	2,659	3,907	\$477	\$1,831	\$2,309	859	\$154	1,103	\$198	3,518	5,010	631	\$2,348	\$2,980	9.07	9.07	\$320	\$2,901.79	\$5,881.62
33	2048	0.1805	0.4734	2,659	3,907	\$480	\$1,849	\$2,329	859	\$155	1,103	\$199	3,518	5,010	635	\$2,372	\$3,007	9.07	9.07	\$330	\$2,992.47	\$5,999.11
34	2049	0.1816	0.4780	2,659	3,907	\$483	\$1,868	\$2,350	859	\$156	1,103	\$200	3,518	5,010	639	\$2,395	\$3,034	9.07	9.07	\$340	\$3,083.15	\$6,116.85
35	2050	0.1826	0.4828	2,659	3,907	\$486	\$1,886	\$2,372	859	\$157	1,103	\$201	3,518	5,010	642	\$2,419	\$3,061	9.07	9.07	\$350	\$3,173.84	\$6,234.83
36	2051	0.1837	0.4875	2,659	3,907	\$488	\$1,905	\$2,393	859	\$158	1,103	\$203	3,518	5,010	646	\$2,442	\$3,089	9.07	9.07	\$360	\$3,264.52	\$6,353.08
37	2052	0.1847	0.4923	2,659	3,907	\$491	\$1,924	\$2,415	859	\$159	1,103	\$204	3,518	5,010	650	\$2,467	\$3,116	9.07	9.07	\$370	\$3,355.20	\$6,471.58
38	2053	0.1858	0.4972	2,659	3,907	\$494	\$1,942	\$2,436	859	\$160	1,103	\$205	3,518	5,010	654	\$2,491	\$3,144	9.07	9.07	\$380	\$3,445.88	\$6,590.33
39	2054	0.1869	0.5021	2,659	3,907	\$497	\$1,962	\$2,458	859	\$161	1,103	\$206	3,518	5,010	657	\$2,515	\$3,173	9.07	9.07	\$390	\$3,536.56	\$6,709.35
40	2055	0.1879	0.5070	2,659	3,907	\$500	\$1,981	\$2,481	859	\$161	1,103	\$207	3,518	5,010	661	\$2,540	\$3,201	9.07	9.07	\$400	\$3,627.24	\$6,828.64
41	2056	0.1890	0.5120	2,659	3,907	\$503	\$2,000	\$2,503	859	\$162	1,103	\$209	3,518	5,010	665	\$2,565	\$3,230	9.07	9.07	\$410	\$3,717.92	\$6,948.19
42	2057	0.1901	0.5171	2,659	3,907	\$506	\$2,020	\$2,526	859	\$163	1,103	\$210	3,518	5,010	669	\$2,591	\$3,259	9.07	9.07	\$420	\$3,808.60	\$7,068.00
43	2058	0.1912	0.5222	2,659	3,907	\$508	\$2,040	\$2,549	859	\$164	1,103	\$211	3,518	5,010	673	\$2,616	\$3,289	9.07	9.07	\$430	\$3,899.28	\$7,188.09
44	2059	0.1923	0.5273	2,659	3,907	\$511	\$2,060	\$2,572	859	\$165	1,103	\$212	3,518	5,010	677	\$2,642	\$3,318	9.07	9.07	\$440	\$3,989.96	\$7,308.46
45	2060	0.1934	0.5325	2,659	3,907	\$514	\$2,081	\$2,595	859	\$166	1,103	\$213	3,518	5,010	681	\$2,668	\$3,348	9.07	9.07	\$450	\$4,080.65	\$7,429.10
46	2061	0.1946	0.5378	2,659	3,907	\$517	\$2,101	\$2,618	859	\$167	1,103	\$215	3,518	5,010	684	\$2,694	\$3,379	9.07	9.07	\$460	\$4,171.33	\$7,550.02
47	2062	0.1957	0.5431	2,659	3,907	\$520	\$2,122	\$2,642	859	\$168	1,103	\$216	3,518	5,010	688	\$2,721	\$3,409	9.07	9.07	\$470	\$4,262.01	\$7,671.22
48	2063	0.1968	0.5484	2,659	3,907	\$523	\$2,143	\$2,666	859	\$169	1,103	\$217	3,518	5,010	692	\$2,748	\$3,440	9.07	9.07	\$480	\$4,352.69	\$7,792.71
49	2064	0.1980	0.5538	2,659	3,907	\$526	\$2,164	\$2,690	859	\$170	1,103	\$218	3,518	5,010	696	\$2,775	\$3,471	9.07	9.07	\$490	\$4,443.37	\$7,914.49
50	2065	0.1991	0.5593	2,659	3,907	\$529	\$2,185	\$2,715	859	\$171	1,103	\$220	3,518	5,010	700	\$2,802	\$3,503	9.07	9.07	\$500	\$4,534.05	\$8,036.55
51	2066	0.2003	0.5648	2,659	3,907	\$532	\$2,207	\$2,739	859	\$172	1,103	\$221	3,518	5,010	705	\$2,830	\$3,534	9.07	9.07	\$510	\$4,624.73	\$8,158.91
52	2067	0.2014	0.5704	2,659	3,907	\$536	\$2,228	\$2,764	859	\$173	1,103	\$222	3,518	5,010	709	\$2,858	\$3,566	9.07	9.07	\$520	\$4,715.41	\$8,281.57
53	2068	0.2026	0.5760	2,659	3,907	\$539	\$2,250	\$2,789	859	\$174	1,103	\$223	3,518									

22. Kenora (North) – Annual Operating Costs

Vertical Ground Source Heat Pump (V.GSHP)

Base Case Scenario											Feed in Tariff (FIT)			
#	Year	Electricity Rates		Heating Operating Cost		Cooling Operating Cost		Hot Water Operating Cost		Total	Total Operating Cost	Incentives (S/KWh)	FIT	
		\$/KWh	KWh	\$	KWh	\$	KWh	\$	KWh				\$	S/KWh
1	2016	0.1501	8,144	\$1,222	206	\$31	4,173	\$626	12,523	\$1,879	0.05	0.1001	\$1,253.34	
2	2017	0.1542	8,144	\$1,256	206	\$32	4,173	\$643	12,523	\$1,931	0.05	0.1042	\$1,304.73	
3	2018	0.1583	8,144	\$1,289	206	\$33	4,173	\$661	12,523	\$1,982	0.05	0.1083	\$1,356.12	
4	2019	0.1625	8,144	\$1,324	206	\$33	4,173	\$678	12,523	\$2,035	0.05	0.1125	\$1,409.32	
5	2020	0.1668	8,144	\$1,358	206	\$34	4,173	\$696	12,523	\$2,089	0.05	0.1168	\$1,462.52	
6	2021	0.1621	8,144	\$1,320	206	\$33	4,173	\$677	12,523	\$2,031	0.05	0.1121	\$1,404.36	
7	2022	0.1629	8,144	\$1,327	206	\$34	4,173	\$680	12,523	\$2,040	0.05	0.1129	\$1,414.28	
8	2023	0.1639	8,144	\$1,335	206	\$34	4,173	\$684	12,523	\$2,052	0.05	0.1139	\$1,426.00	
9	2024	0.1648	8,144	\$1,342	206	\$34	4,173	\$688	12,523	\$2,064	0.05	0.1148	\$1,437.72	
10	2025	0.1656	8,144	\$1,349	206	\$34	4,173	\$691	12,523	\$2,074	0.05	0.1156	\$1,447.64	
11	2026	0.1665	8,144	\$1,356	206	\$34	4,173	\$695	12,523	\$2,086	0.05	0.1165	\$1,459.36	
12	2027	0.1674	8,144	\$1,364	206	\$34	4,173	\$699	12,523	\$2,097	0.05	0.1174	\$1,470.63	
13	2028	0.1683	8,144	\$1,370	206	\$35	4,173	\$702	12,523	\$2,107	0.05	0.1183	\$1,481.00	
14	2029	0.1692	8,144	\$1,378	206	\$35	4,173	\$706	12,523	\$2,118	0.05	0.1192	\$1,492.27	
15	2030	0.1701	8,144	\$1,385	206	\$35	4,173	\$710	12,523	\$2,130	0.05	0.1201	\$1,504.00	
16	2031	0.1704	8,144	\$1,387	206	\$35	4,173	\$711	12,523	\$2,133	0.05	0.1204	\$1,507.15	
17	2032	0.1705	8,144	\$1,389	206	\$35	4,173	\$711	12,523	\$2,135	0.05	0.1205	\$1,508.95	
18	2033	0.1707	8,144	\$1,391	206	\$35	4,173	\$713	12,523	\$2,138	0.05	0.1207	\$1,512.11	
19	2034	0.1710	8,144	\$1,393	206	\$35	4,173	\$714	12,523	\$2,142	0.05	0.1210	\$1,515.72	
20	2035	0.1713	8,144	\$1,395	206	\$35	4,173	\$715	12,523	\$2,145	0.05	0.1213	\$1,518.87	
21	2036	0.1714	8,144	\$1,396	206	\$35	4,173	\$715	12,523	\$2,147	0.05	0.1214	\$1,520.68	
22	2037	0.1717	8,144	\$1,398	206	\$35	4,173	\$716	12,523	\$2,150	0.05	0.1217	\$1,523.83	
23	2038	0.1720	8,144	\$1,401	206	\$35	4,173	\$718	12,523	\$2,154	0.05	0.1220	\$1,527.44	
24	2039	0.1722	8,144	\$1,403	206	\$35	4,173	\$719	12,523	\$2,157	0.05	0.1222	\$1,530.59	
25	2040	0.1724	8,144	\$1,404	206	\$36	4,173	\$719	12,523	\$2,159	0.05	0.1224	\$1,532.40	
26	2041	0.1734	8,144	\$1,412	206	\$36	4,173	\$723	12,523	\$2,171	0.05	0.1234	\$1,544.88	
27	2042	0.1744	8,144	\$1,420	206	\$36	4,173	\$728	12,523	\$2,184	0.05	0.1244	\$1,557.44	
28	2043	0.1754	8,144	\$1,428	206	\$36	4,173	\$732	12,523	\$2,196	0.05	0.1254	\$1,570.07	
29	2044	0.1764	8,144	\$1,437	206	\$36	4,173	\$736	12,523	\$2,209	0.05	0.1264	\$1,582.78	
30	2045	0.1774	8,144	\$1,445	206	\$37	4,173	\$740	12,523	\$2,222	0.05	0.1274	\$1,595.56	
31	2046	0.1784	8,144	\$1,453	206	\$37	4,173	\$745	12,523	\$2,235	0.05	0.1284	\$1,608.41	
32	2047	0.1795	8,144	\$1,462	206	\$37	4,173	\$749	12,523	\$2,247	0.05	0.1295	\$1,621.34	
33	2048	0.1805	8,144	\$1,470	206	\$37	4,173	\$753	12,523	\$2,260	0.05	0.1305	\$1,634.34	
34	2049	0.1816	8,144	\$1,479	206	\$37	4,173	\$758	12,523	\$2,274	0.05	0.1316	\$1,647.42	
35	2050	0.1826	8,144	\$1,487	206	\$38	4,173	\$762	12,523	\$2,287	0.05	0.1326	\$1,660.57	
36	2051	0.1837	8,144	\$1,496	206	\$38	4,173	\$766	12,523	\$2,300	0.05	0.1337	\$1,673.80	
37	2052	0.1847	8,144	\$1,504	206	\$38	4,173	\$771	12,523	\$2,313	0.05	0.1347	\$1,687.10	
38	2053	0.1858	8,144	\$1,513	206	\$38	4,173	\$775	12,523	\$2,327	0.05	0.1358	\$1,700.48	
39	2054	0.1869	8,144	\$1,522	206	\$38	4,173	\$780	12,523	\$2,340	0.05	0.1369	\$1,713.94	
40	2055	0.1879	8,144	\$1,531	206	\$39	4,173	\$784	12,523	\$2,354	0.05	0.1379	\$1,727.48	
41	2056	0.1890	8,144	\$1,539	206	\$39	4,173	\$789	12,523	\$2,367	0.05	0.1390	\$1,741.09	
42	2057	0.1901	8,144	\$1,548	206	\$39	4,173	\$793	12,523	\$2,381	0.05	0.1401	\$1,754.79	
43	2058	0.1912	8,144	\$1,557	206	\$39	4,173	\$798	12,523	\$2,395	0.05	0.1412	\$1,768.56	
44	2059	0.1923	8,144	\$1,566	206	\$40	4,173	\$803	12,523	\$2,409	0.05	0.1423	\$1,782.41	
45	2060	0.1934	8,144	\$1,575	206	\$40	4,173	\$807	12,523	\$2,422	0.05	0.1434	\$1,796.35	
46	2061	0.1946	8,144	\$1,585	206	\$40	4,173	\$812	12,523	\$2,437	0.05	0.1446	\$1,810.36	
47	2062	0.1957	8,144	\$1,594	206	\$40	4,173	\$817	12,523	\$2,451	0.05	0.1457	\$1,824.46	
48	2063	0.1968	8,144	\$1,603	206	\$41	4,173	\$821	12,523	\$2,465	0.05	0.1468	\$1,838.63	
49	2064	0.1980	8,144	\$1,612	206	\$41	4,173	\$826	12,523	\$2,479	0.05	0.1480	\$1,852.89	
50	2065	0.1991	8,144	\$1,622	206	\$41	4,173	\$831	12,523	\$2,493	0.05	0.1491	\$1,867.23	
51	2066	0.2003	8,144	\$1,631	206	\$41	4,173	\$836	12,523	\$2,508	0.05	0.1503	\$1,881.66	
52	2067	0.2014	8,144	\$1,640	206	\$41	4,173	\$841	12,523	\$2,522	0.05	0.1514	\$1,896.16	
53	2068	0.2026	8,144	\$1,650	206	\$42	4,173	\$845	12,523	\$2,537	0.05	0.1526	\$1,910.75	
54	2069	0.2038	8,144	\$1,659	206	\$42	4,173	\$850	12,523	\$2,552	0.05	0.1538	\$1,925.43	
55	2070	0.2049	8,144	\$1,669	206	\$42	4,173	\$855	12,523	\$2,566	0.05	0.1549	\$1,940.19	
56	2071	0.2061	8,144	\$1,679	206	\$42	4,173	\$860	12,523	\$2,581	0.05	0.1561	\$1,955.04	
57	2072	0.2073	8,144	\$1,688	206	\$43	4,173	\$865	12,523	\$2,596	0.05	0.1573	\$1,969.97	
58	2073	0.2085	8,144	\$1,698	206	\$43	4,173	\$870	12,523	\$2,611	0.05	0.1585	\$1,984.99	
59	2074	0.2097	8,144	\$1,708	206	\$43	4,173	\$875	12,523	\$2,626	0.05	0.1597	\$2,000.09	
60	2075	0.2109	8,144	\$1,718	206	\$43	4,173	\$880	12,523	\$2,641	0.05	0.1609	\$2,015.28	

Table D1-1.64: Annual Operating Costs (V.GSHP) of a 2,000 square feet detached house above grade (average construction type) in the city of Kenora (two life cycles and three life cycles for a 60 year project lifespan); base case scenario in comparison with feed in-tariff (FIT) scenario. In the FIT scenario, an incentive of \$0.05/KWh is provided on electricity bills throughout the project lifespan

Horizontal Ground Source Heat Pump (H.GSHP)

Base Case Scenario											Feed in Tariff (FIT)		
H.GSHP											FIT		
#	Year	Electricity Rates \$/KWh	Heating KWh	Heating Operating Cost \$	Cooling KWh	Cooling Operating Cost \$	Hot Water KWh	Hot Water Operating Cost \$	Total KWh	Total Operating Cost \$	Incentives (\$/KWh)	\$/KWh	Operating Cost
1	2016	0.1501	8,255	\$1,239	211	\$32	4,170	\$626	12,636	\$1,896	0.05	0.1001	\$1,264.65
2	2017	0.1542	8,255	\$1,273	211	\$33	4,170	\$643	12,636	\$1,948	0.05	0.1042	\$1,316.50
3	2018	0.1583	8,255	\$1,307	211	\$33	4,170	\$660	12,636	\$2,000	0.05	0.1083	\$1,368.36
4	2019	0.1625	8,255	\$1,342	211	\$34	4,170	\$678	12,636	\$2,054	0.05	0.1125	\$1,422.04
5	2020	0.1668	8,255	\$1,377	211	\$35	4,170	\$696	12,636	\$2,108	0.05	0.1168	\$1,475.72
6	2021	0.1621	8,255	\$1,338	211	\$34	4,170	\$676	12,636	\$2,049	0.05	0.1121	\$1,417.04
7	2022	0.1629	8,255	\$1,345	211	\$34	4,170	\$679	12,636	\$2,059	0.05	0.1129	\$1,427.04
8	2023	0.1639	8,255	\$1,353	211	\$35	4,170	\$683	12,636	\$2,071	0.05	0.1139	\$1,438.87
9	2024	0.1648	8,255	\$1,360	211	\$35	4,170	\$687	12,636	\$2,082	0.05	0.1148	\$1,450.70
10	2025	0.1656	8,255	\$1,367	211	\$35	4,170	\$691	12,636	\$2,093	0.05	0.1156	\$1,460.70
11	2026	0.1665	8,255	\$1,375	211	\$35	4,170	\$694	12,636	\$2,104	0.05	0.1165	\$1,472.53
12	2027	0.1674	8,255	\$1,382	211	\$35	4,170	\$698	12,636	\$2,116	0.05	0.1174	\$1,483.90
13	2028	0.1683	8,255	\$1,389	211	\$36	4,170	\$702	12,636	\$2,126	0.05	0.1183	\$1,494.37
14	2029	0.1692	8,255	\$1,396	211	\$36	4,170	\$705	12,636	\$2,138	0.05	0.1192	\$1,505.74
15	2030	0.1701	8,255	\$1,404	211	\$36	4,170	\$709	12,636	\$2,149	0.05	0.1201	\$1,517.57
16	2031	0.1704	8,255	\$1,406	211	\$36	4,170	\$710	12,636	\$2,153	0.05	0.1204	\$1,520.75
17	2032	0.1705	8,255	\$1,407	211	\$36	4,170	\$711	12,636	\$2,154	0.05	0.1205	\$1,522.57
18	2033	0.1707	8,255	\$1,410	211	\$36	4,170	\$712	12,636	\$2,158	0.05	0.1207	\$1,525.75
19	2034	0.1710	8,255	\$1,412	211	\$36	4,170	\$713	12,636	\$2,161	0.05	0.1210	\$1,529.39
20	2035	0.1713	8,255	\$1,414	211	\$36	4,170	\$714	12,636	\$2,164	0.05	0.1213	\$1,532.58
21	2036	0.1714	8,255	\$1,415	211	\$36	4,170	\$715	12,636	\$2,166	0.05	0.1214	\$1,534.40
22	2037	0.1717	8,255	\$1,417	211	\$36	4,170	\$716	12,636	\$2,169	0.05	0.1217	\$1,537.58
23	2038	0.1720	8,255	\$1,420	211	\$36	4,170	\$717	12,636	\$2,173	0.05	0.1220	\$1,541.22
24	2039	0.1722	8,255	\$1,422	211	\$36	4,170	\$718	12,636	\$2,176	0.05	0.1222	\$1,544.41
25	2040	0.1724	8,255	\$1,423	211	\$36	4,170	\$719	12,636	\$2,178	0.05	0.1224	\$1,546.22
26	2041	0.1734	8,255	\$1,431	211	\$37	4,170	\$723	12,636	\$2,191	0.05	0.1234	\$1,558.82
27	2042	0.1744	8,255	\$1,439	211	\$37	4,170	\$727	12,636	\$2,203	0.05	0.1244	\$1,571.50
28	2043	0.1754	8,255	\$1,448	211	\$37	4,170	\$731	12,636	\$2,216	0.05	0.1254	\$1,584.24
29	2044	0.1764	8,255	\$1,456	211	\$37	4,170	\$736	12,636	\$2,229	0.05	0.1264	\$1,597.06
30	2045	0.1774	8,255	\$1,465	211	\$37	4,170	\$740	12,636	\$2,242	0.05	0.1274	\$1,609.96
31	2046	0.1784	8,255	\$1,473	211	\$38	4,170	\$744	12,636	\$2,255	0.05	0.1284	\$1,622.92
32	2047	0.1795	8,255	\$1,482	211	\$38	4,170	\$748	12,636	\$2,268	0.05	0.1295	\$1,635.97
33	2048	0.1805	8,255	\$1,490	211	\$38	4,170	\$753	12,636	\$2,281	0.05	0.1305	\$1,649.09
34	2049	0.1816	8,255	\$1,499	211	\$38	4,170	\$757	12,636	\$2,294	0.05	0.1316	\$1,662.28
35	2050	0.1826	8,255	\$1,507	211	\$39	4,170	\$761	12,636	\$2,307	0.05	0.1326	\$1,675.55
36	2051	0.1837	8,255	\$1,516	211	\$39	4,170	\$766	12,636	\$2,321	0.05	0.1337	\$1,688.90
37	2052	0.1847	8,255	\$1,525	211	\$39	4,170	\$770	12,636	\$2,334	0.05	0.1347	\$1,702.32
38	2053	0.1858	8,255	\$1,534	211	\$39	4,170	\$775	12,636	\$2,348	0.05	0.1358	\$1,715.83
39	2054	0.1869	8,255	\$1,543	211	\$39	4,170	\$779	12,636	\$2,361	0.05	0.1369	\$1,729.41
40	2055	0.1879	8,255	\$1,551	211	\$40	4,170	\$784	12,636	\$2,375	0.05	0.1379	\$1,743.07
41	2056	0.1890	8,255	\$1,560	211	\$40	4,170	\$788	12,636	\$2,389	0.05	0.1390	\$1,756.80
42	2057	0.1901	8,255	\$1,569	211	\$40	4,170	\$793	12,636	\$2,402	0.05	0.1401	\$1,770.62
43	2058	0.1912	8,255	\$1,579	211	\$40	4,170	\$797	12,636	\$2,416	0.05	0.1412	\$1,784.52
44	2059	0.1923	8,255	\$1,588	211	\$41	4,170	\$802	12,636	\$2,430	0.05	0.1423	\$1,798.50
45	2060	0.1934	8,255	\$1,597	211	\$41	4,170	\$807	12,636	\$2,444	0.05	0.1434	\$1,812.56
46	2061	0.1946	8,255	\$1,606	211	\$41	4,170	\$811	12,636	\$2,458	0.05	0.1446	\$1,826.70
47	2062	0.1957	8,255	\$1,615	211	\$41	4,170	\$816	12,636	\$2,473	0.05	0.1457	\$1,840.92
48	2063	0.1968	8,255	\$1,625	211	\$42	4,170	\$821	12,636	\$2,487	0.05	0.1468	\$1,855.22
49	2064	0.1980	8,255	\$1,634	211	\$42	4,170	\$825	12,636	\$2,501	0.05	0.1480	\$1,869.61
50	2065	0.1991	8,255	\$1,644	211	\$42	4,170	\$830	12,636	\$2,516	0.05	0.1491	\$1,884.08
51	2066	0.2003	8,255	\$1,653	211	\$42	4,170	\$835	12,636	\$2,530	0.05	0.1503	\$1,898.64
52	2067	0.2014	8,255	\$1,663	211	\$42	4,170	\$840	12,636	\$2,545	0.05	0.1514	\$1,913.27
53	2068	0.2026	8,255	\$1,672	211	\$43	4,170	\$845	12,636	\$2,560	0.05	0.1526	\$1,928.00
54	2069	0.2038	8,255	\$1,682	211	\$43	4,170	\$850	12,636	\$2,575	0.05	0.1538	\$1,942.80
55	2070	0.2049	8,255	\$1,692	211	\$43	4,170	\$855	12,636	\$2,589	0.05	0.1549	\$1,957.70
56	2071	0.2061	8,255	\$1,701	211	\$43	4,170	\$860	12,636	\$2,604	0.05	0.1561	\$1,972.68
57	2072	0.2073	8,255	\$1,711	211	\$44	4,170	\$864	12,636	\$2,620	0.05	0.1573	\$1,987.74
58	2073	0.2085	8,255	\$1,721	211	\$44	4,170	\$869	12,636	\$2,635	0.05	0.1585	\$2,002.90
59	2074	0.2097	8,255	\$1,731	211	\$44	4,170	\$875	12,636	\$2,650	0.05	0.1597	\$2,018.14
60	2075	0.2109	8,255	\$1,741	211	\$45	4,170	\$880	12,636	\$2,665	0.05	0.1609	\$2,033.47

Table D1-1.65: Annual Operating Costs (H.GSHP) of a 2,000 square feet detached house above grade (average construction type) in the city of Kenora (two life cycles and three life cycles for a 60 year project lifespan); base case scenario in comparison with feed in-tariff (FIT) scenario. In the FIT scenario, an incentive of \$0.05/KWh is provided on electricity bills throughout the project lifespan

Traditional HVAC Applications

Base Case Scenario															Carbon Taxes							
#	Year	Electricity Rates \$/KWh	Natural Gas Rates \$/m ³	Heating		Heating Operating Cost \$ (Electricity)	Heating Operating Cost \$ (Gas)	Total Heating Operating Cost \$	Cooling KWh	Cooling Operating Cost \$	Hot Water m ³	Hot Water Operating Cost \$	Total KWh	Total m ³	Total Electricity Operating Cost \$ (KWh)	Total Natural Gas Operating Cost \$ (m ³)	Total	Conversion of m ³ into Tons	Total Tons	Carbon Tax 10	Operating Costs	
				KWh (Electricity)	m ³ (Gas)																	
1	2016	0.1501	0.3458	2,288	3,574	\$343	\$1,236	\$1,579	971	\$146	1.105	\$382	3,259	4,679	489	\$1,618	\$2,107	8.47	8.47	\$10	\$84.69	\$2,191.95
2	2017	0.1542	0.3588	2,288	3,574	\$353	\$1,282	\$1,635	971	\$150	1.105	\$170	3,259	4,679	502	\$1,679	\$2,181	8.47	8.47	\$20	\$169.38	\$2,350.87
3	2018	0.1583	0.3718	2,288	3,574	\$362	\$1,329	\$1,691	971	\$154	1.105	\$175	3,259	4,679	516	\$1,740	\$2,256	8.47	8.47	\$30	\$254.07	\$2,509.80
4	2019	0.1625	0.3776	2,288	3,574	\$372	\$1,349	\$1,721	971	\$158	1.105	\$180	3,259	4,679	530	\$1,767	\$2,296	8.47	8.47	\$40	\$338.76	\$2,635.18
5	2020	0.1668	0.3841	2,288	3,574	\$382	\$1,373	\$1,754	971	\$162	1.105	\$184	3,259	4,679	544	\$1,797	\$2,341	8.47	8.47	\$50	\$423.45	\$2,764.14
6	2021	0.1621	0.3883	2,288	3,574	\$371	\$1,388	\$1,759	971	\$157	1.105	\$179	3,259	4,679	528	\$1,817	\$2,345	8.47	8.47	\$60	\$508.14	\$2,853.39
7	2022	0.1629	0.3929	2,288	3,574	\$373	\$1,404	\$1,777	971	\$158	1.105	\$180	3,259	4,679	531	\$1,838	\$2,369	8.47	8.47	\$70	\$592.83	\$2,962.14
8	2023	0.1639	0.3967	2,288	3,574	\$375	\$1,418	\$1,793	971	\$159	1.105	\$181	3,259	4,679	534	\$1,856	\$2,390	8.47	8.47	\$80	\$677.52	\$3,067.78
9	2024	0.1648	0.4005	2,288	3,574	\$377	\$1,432	\$1,809	971	\$160	1.105	\$182	3,259	4,679	537	\$1,874	\$2,411	8.47	8.47	\$90	\$762.21	\$3,173.42
10	2025	0.1656	0.4040	2,288	3,574	\$379	\$1,444	\$1,823	971	\$161	1.105	\$183	3,259	4,679	540	\$1,890	\$2,430	8.47	8.47	\$100	\$846.90	\$3,276.80
11	2026	0.1665	0.4070	2,288	3,574	\$381	\$1,455	\$1,836	971	\$162	1.105	\$184	3,259	4,679	543	\$1,905	\$2,447	8.47	8.47	\$110	\$931.59	\$3,378.86
12	2027	0.1674	0.4097	2,288	3,574	\$383	\$1,464	\$1,847	971	\$163	1.105	\$185	3,259	4,679	546	\$1,917	\$2,463	8.47	8.47	\$120	\$1,016.28	\$3,479.01
13	2028	0.1683	0.4124	2,288	3,574	\$385	\$1,474	\$1,859	971	\$163	1.105	\$186	3,259	4,679	548	\$1,930	\$2,478	8.47	8.47	\$130	\$1,100.97	\$3,578.93
14	2029	0.1692	0.4151	2,288	3,574	\$387	\$1,483	\$1,871	971	\$164	1.105	\$187	3,259	4,679	551	\$1,942	\$2,493	8.47	8.47	\$140	\$1,185.66	\$3,679.08
15	2030	0.1701	0.4170	2,288	3,574	\$389	\$1,490	\$1,879	971	\$165	1.105	\$188	3,259	4,679	554	\$1,951	\$2,505	8.47	8.47	\$150	\$1,270.35	\$3,775.77
16	2031	0.1704	0.4189	2,288	3,574	\$390	\$1,497	\$1,887	971	\$165	1.105	\$188	3,259	4,679	555	\$1,960	\$2,515	8.47	8.47	\$160	\$1,355.04	\$3,870.24
17	2032	0.1705	0.4204	2,288	3,574	\$390	\$1,503	\$1,893	971	\$166	1.105	\$188	3,259	4,679	556	\$1,967	\$2,523	8.47	8.47	\$170	\$1,439.73	\$3,962.56
18	2033	0.1707	0.4223	2,288	3,574	\$391	\$1,509	\$1,900	971	\$166	1.105	\$189	3,259	4,679	556	\$1,976	\$2,533	8.47	8.47	\$180	\$1,524.42	\$4,057.02
19	2034	0.1710	0.4246	2,288	3,574	\$391	\$1,518	\$1,909	971	\$166	1.105	\$189	3,259	4,679	557	\$1,987	\$2,544	8.47	8.47	\$190	\$1,609.11	\$4,153.38
20	2035	0.1713	0.4265	2,288	3,574	\$392	\$1,524	\$1,916	971	\$166	1.105	\$189	3,259	4,679	558	\$1,996	\$2,554	8.47	8.47	\$200	\$1,693.80	\$4,247.85
21	2036	0.1741	0.4288	2,288	3,574	\$393	\$1,533	\$1,925	971	\$167	1.105	\$189	3,259	4,679	559	\$2,007	\$2,565	8.47	8.47	\$210	\$1,778.49	\$4,343.74
22	2037	0.1717	0.4311	2,288	3,574	\$393	\$1,541	\$1,934	971	\$167	1.105	\$190	3,259	4,679	560	\$2,017	\$2,577	8.47	8.47	\$220	\$1,863.18	\$4,440.00
23	2038	0.1720	0.4331	2,288	3,574	\$393	\$1,548	\$1,941	971	\$167	1.105	\$190	3,259	4,679	560	\$2,026	\$2,587	8.47	8.47	\$230	\$1,947.87	\$4,534.57
24	2039	0.1722	0.4353	2,288	3,574	\$394	\$1,556	\$1,950	971	\$167	1.105	\$190	3,259	4,679	561	\$2,037	\$2,598	8.47	8.47	\$240	\$2,032.56	\$4,630.83
25	2040	0.1724	0.4376	2,288	3,574	\$394	\$1,564	\$1,959	971	\$167	1.105	\$190	3,259	4,679	562	\$2,048	\$2,609	8.47	8.47	\$250	\$2,117.25	\$4,726.72
26	2041	0.1734	0.4420	2,288	3,574	\$397	\$1,580	\$1,976	971	\$168	1.105	\$192	3,259	4,679	565	\$2,068	\$2,633	8.47	8.47	\$260	\$2,201.94	\$4,834.85
27	2042	0.1744	0.4463	2,288	3,574	\$399	\$1,594	\$1,994	971	\$169	1.105	\$193	3,259	4,679	568	\$2,088	\$2,657	8.47	8.47	\$270	\$2,286.63	\$4,943.20
28	2043	0.1754	0.4507	2,288	3,574	\$401	\$1,611	\$2,012	971	\$170	1.105	\$194	3,259	4,679	572	\$2,109	\$2,680	8.47	8.47	\$280	\$2,371.32	\$5,051.76
29	2044	0.1764	0.4552	2,288	3,574	\$404	\$1,627	\$2,030	971	\$171	1.105	\$195	3,259	4,679	575	\$2,130	\$2,705	8.47	8.47	\$290	\$2,456.01	\$5,160.55
30	2045	0.1774	0.4596	2,288	3,574	\$406	\$1,643	\$2,049	971	\$172	1.105	\$196	3,259	4,679	578	\$2,151	\$2,729	8.47	8.47	\$300	\$2,540.70	\$5,269.56
31	2046	0.1784	0.4642	2,288	3,574	\$408	\$1,659	\$2,067	971	\$173	1.105	\$197	3,259	4,679	582	\$2,172	\$2,753	8.47	8.47	\$310	\$2,625.39	\$5,378.07
32	2047	0.1795	0.4688	2,288	3,574	\$411	\$2,086	\$2,086	971	\$175	1.105	\$198	3,259	4,679	585	\$2,193	\$2,778	8.47	8.47	\$320	\$2,710.08	\$5,486.27
33	2048	0.1805	0.4734	2,288	3,574	\$413	\$1,692	\$2,105	971	\$175	1.105	\$199	3,259	4,679	588	\$2,215	\$2,803	8.47	8.47	\$330	\$2,794.77	\$5,597.97
34	2049	0.1816	0.4780	2,288	3,574	\$415	\$1,709	\$2,124	971	\$176	1.105	\$201	3,259	4,679	592	\$2,237	\$2,828	8.47	8.47	\$340	\$2,879.46	\$5,707.90
35	2050	0.1826	0.4828	2,288	3,574	\$418	\$1,725	\$2,143	971	\$177	1.105	\$202	3,259	4,679	595	\$2,259	\$2,854	8.47	8.47	\$350	\$2,964.15	\$5,818.06
36	2051	0.1837	0.4875	2,288	3,574	\$420	\$1,742	\$2,163	971	\$178	1.105	\$203	3,259	4,679	599	\$2,281	\$2,880	8.47	8.47	\$360	\$3,048.84	\$5,928.46
37	2052	0.1847	0.4923	2,288	3,574	\$423	\$1,760	\$2,182	971	\$179	1.105	\$204	3,259	4,679	602	\$2,304	\$2,906	8.47	8.47	\$370	\$3,133.53	\$6,039.10
38	2053	0.1858	0.4972	2,288	3,574	\$425	\$1,777	\$2,202	971	\$180	1.105	\$205	3,259	4,679	605	\$2,326	\$2,932	8.47	8.47	\$380	\$3,218.22	\$6,149.99
39	2054	0.1869	0.5021	2,288	3,574	\$428	\$1,794	\$2,222	971	\$181	1.105	\$206	3,259	4,679	609	\$2,349	\$2,958	8.47	8.47	\$390	\$3,302.91	\$6,261.11
40	2055	0.1879	0.5070	2,288	3,574	\$430	\$1,812	\$2,242	971	\$182	1.105	\$208	3,259	4,679	613	\$2,372	\$2,985	8.47	8.47	\$400	\$3,387.60	\$6,372.49
41	2056	0.1890	0.5120	2,288	3,574	\$433	\$1,830	\$2,262	971	\$184	1.105	\$209	3,259	4,679	616	\$2,396	\$3,012	8.47	8.47	\$410	\$3,472.29	\$6,484.11
42	2057	0.1901	0.5171	2,288	3,574	\$435	\$1,848	\$2,283	971	\$185	1.105	\$210	3,259	4,679	620	\$2,419	\$3,039	8.47	8.47	\$420	\$3,556.98	\$6,595.98
43	2058	0.1912	0.5222	2,288	3,574	\$438	\$1,866	\$2,304	971	\$186	1.105	\$211	3,259	4,679	623	\$2,443	\$3,066	8.47	8.47	\$430	\$3,641.67	\$6,708.11
44	2059	0.1923	0.5273	2,288	3,574	\$440	\$1,885	\$2,325	971	\$187	1.105	\$213	3,259	4,679	627	\$2,467	\$3,094	8.47	8.47	\$440	\$3,726.36	\$6,820.49
45	2060	0.1934	0.5325	2,288	3,574	\$443	\$1,903	\$2,346	971	\$188	1.105	\$214	3,259	4,679	630	\$2,492	\$3,122	8.47	8.47	\$450	\$3,811.05	\$6,933.14
46	2061	0.1946	0.5378	2,288	3,574	\$445	\$1,922	\$2,367	971	\$189	1.105	\$215	3,259	4,679	634	\$2,516	\$3,150	8.47	8.47	\$460	\$3,895.74	\$7,046.04
47	2062	0.1957	0.5431	2,288	3,574	\$448	\$1,941	\$2,389	971	\$190	1.105	\$216	3,259	4,679	638	\$2,541	\$3,179	8.47	8.47	\$470	\$3,980.43	\$7,159.20
48	2063	0.1968	0.5484	2,288	3,574	\$450	\$1,960	\$2,410	971	\$191	1.105	\$217	3,259	4,679	641	\$2,566	\$3,208	8.47	8.47	\$480	\$4,065.12	\$7,272.63
49	2064	0.1980	0.5538	2,288	3,574	\$453	\$1,979	\$2,432	971	\$192	1.105	\$219	3,259	4,679	645	\$2,591	\$3,237	8.47	8.47	\$490	\$4,149.81	\$7,386.33
50	2065	0.1991	0.5593	2,288	3,574	\$456	\$1,999	\$2,454	971	\$193	1.105	\$220	3,259	4,679	649	\$2,617	\$3,266	8.47	8.47	\$500	\$4,234.50	\$7,500.30
51	2066	0.2003	0.5648	2,288	3,574	\$458	\$2,019	\$2,477	971	\$194	1.105	\$221	3,259	4,679	653	\$2,643	\$3,295	8.47	8.47	\$510	\$4,319.18	\$7,614.55
52	2067	0.2014	0.5704	2,288	3,574	\$461	\$2,039	\$2,499	971	\$196	1.105	\$223	3,259	4,679	656	\$2,669	\$3,325	8.47	8.47	\$520	\$4,403.87	\$7,729.07
53	2068	0.2026	0.5760	2,288	3,574	\$464	\$2,059	\$2,522	971	\$197	1.105	\$224	3,259	4,679	660	\$2,695	\$3,355	8.47	8.47	\$530	\$4,488.56	\$7,843.87
5																						

23. North Bay (North) – Annual Operating Costs

Vertical Ground Source Heat Pump (V.GSHP)

Base Case Scenario											Feed in Tariff (FIT)		
#	Year	Electricity Rates		V.GSHP		Hot Water		Total	Total Operating Cost		FIT		
		\$/KWh	KWh	Heating Operating Cost	Cooling Operating Cost	Hot Water Operating Cost	KWh				Operating Cost	\$/KWh	
1	2016	0.1501	6,390	\$959	\$26	4,172	\$626	10,734	\$1,611	0.05	0.1001	\$1,074.29	
2	2017	0.1542	6,390	\$985	\$27	4,172	\$643	10,734	\$1,655	0.05	0.1042	\$1,118.34	
3	2018	0.1583	6,390	\$1,011	\$27	4,172	\$660	10,734	\$1,699	0.05	0.1083	\$1,162.39	
4	2019	0.1625	6,390	\$1,039	\$28	4,172	\$678	10,734	\$1,745	0.05	0.1125	\$1,207.99	
5	2020	0.1668	6,390	\$1,066	\$29	4,172	\$696	10,734	\$1,790	0.05	0.1168	\$1,253.59	
6	2021	0.1621	6,390	\$1,036	\$28	4,172	\$676	10,734	\$1,740	0.05	0.1121	\$1,203.74	
7	2022	0.1629	6,390	\$1,041	\$28	4,172	\$680	10,734	\$1,749	0.05	0.1129	\$1,212.24	
8	2023	0.1639	6,390	\$1,047	\$28	4,172	\$684	10,734	\$1,759	0.05	0.1139	\$1,222.29	
9	2024	0.1648	6,390	\$1,053	\$28	4,172	\$688	10,734	\$1,769	0.05	0.1148	\$1,232.33	
10	2025	0.1656	6,390	\$1,058	\$28	4,172	\$691	10,734	\$1,778	0.05	0.1156	\$1,240.84	
11	2026	0.1665	6,390	\$1,064	\$29	4,172	\$695	10,734	\$1,788	0.05	0.1165	\$1,250.88	
12	2027	0.1674	6,390	\$1,070	\$29	4,172	\$699	10,734	\$1,797	0.05	0.1174	\$1,260.54	
13	2028	0.1683	6,390	\$1,075	\$29	4,172	\$702	10,734	\$1,806	0.05	0.1183	\$1,269.43	
14	2029	0.1692	6,390	\$1,081	\$29	4,172	\$706	10,734	\$1,816	0.05	0.1192	\$1,279.09	
15	2030	0.1701	6,390	\$1,087	\$29	4,172	\$710	10,734	\$1,826	0.05	0.1201	\$1,289.14	
16	2031	0.1704	6,390	\$1,089	\$29	4,172	\$711	10,734	\$1,829	0.05	0.1204	\$1,291.84	
17	2032	0.1705	6,390	\$1,089	\$29	4,172	\$711	10,734	\$1,830	0.05	0.1205	\$1,293.39	
18	2033	0.1707	6,390	\$1,091	\$29	4,172	\$712	10,734	\$1,833	0.05	0.1207	\$1,295.09	
19	2034	0.1710	6,390	\$1,093	\$29	4,172	\$714	10,734	\$1,836	0.05	0.1210	\$1,299.19	
20	2035	0.1713	6,390	\$1,095	\$29	4,172	\$715	10,734	\$1,839	0.05	0.1213	\$1,301.89	
21	2036	0.1714	6,390	\$1,095	\$29	4,172	\$715	10,734	\$1,840	0.05	0.1214	\$1,303.44	
22	2037	0.1717	6,390	\$1,097	\$30	4,172	\$716	10,734	\$1,843	0.05	0.1217	\$1,306.14	
23	2038	0.1720	6,390	\$1,099	\$30	4,172	\$717	10,734	\$1,846	0.05	0.1220	\$1,309.23	
24	2039	0.1722	6,390	\$1,101	\$30	4,172	\$719	10,734	\$1,849	0.05	0.1222	\$1,311.94	
25	2040	0.1724	6,390	\$1,101	\$30	4,172	\$719	10,734	\$1,850	0.05	0.1224	\$1,313.48	
26	2041	0.1734	6,390	\$1,108	\$30	4,172	\$723	10,734	\$1,861	0.05	0.1234	\$1,324.19	
27	2042	0.1744	6,390	\$1,114	\$30	4,172	\$727	10,734	\$1,872	0.05	0.1244	\$1,334.95	
28	2043	0.1754	6,390	\$1,121	\$30	4,172	\$732	10,734	\$1,882	0.05	0.1254	\$1,345.78	
29	2044	0.1764	6,390	\$1,127	\$30	4,172	\$736	10,734	\$1,893	0.05	0.1264	\$1,356.67	
30	2045	0.1774	6,390	\$1,134	\$31	4,172	\$740	10,734	\$1,904	0.05	0.1274	\$1,367.62	
31	2046	0.1784	6,390	\$1,140	\$31	4,172	\$744	10,734	\$1,915	0.05	0.1284	\$1,378.64	
32	2047	0.1795	6,390	\$1,147	\$31	4,172	\$749	10,734	\$1,926	0.05	0.1295	\$1,389.72	
33	2048	0.1805	6,390	\$1,153	\$31	4,172	\$753	10,734	\$1,938	0.05	0.1305	\$1,400.86	
34	2049	0.1816	6,390	\$1,160	\$31	4,172	\$757	10,734	\$1,949	0.05	0.1316	\$1,412.07	
35	2050	0.1826	6,390	\$1,167	\$31	4,172	\$762	10,734	\$1,960	0.05	0.1326	\$1,423.34	
36	2051	0.1837	6,390	\$1,174	\$32	4,172	\$766	10,734	\$1,971	0.05	0.1337	\$1,434.68	
37	2052	0.1847	6,390	\$1,180	\$32	4,172	\$771	10,734	\$1,983	0.05	0.1347	\$1,446.09	
38	2053	0.1858	6,390	\$1,187	\$32	4,172	\$775	10,734	\$1,994	0.05	0.1358	\$1,457.56	
39	2054	0.1869	6,390	\$1,194	\$32	4,172	\$780	10,734	\$2,006	0.05	0.1369	\$1,469.09	
40	2055	0.1879	6,390	\$1,201	\$32	4,172	\$784	10,734	\$2,017	0.05	0.1379	\$1,480.70	
41	2056	0.1890	6,390	\$1,208	\$33	4,172	\$789	10,734	\$2,029	0.05	0.1390	\$1,492.37	
42	2057	0.1901	6,390	\$1,215	\$33	4,172	\$793	10,734	\$2,041	0.05	0.1401	\$1,504.10	
43	2058	0.1912	6,390	\$1,222	\$33	4,172	\$798	10,734	\$2,053	0.05	0.1412	\$1,515.91	
44	2059	0.1923	6,390	\$1,229	\$33	4,172	\$802	10,734	\$2,064	0.05	0.1423	\$1,527.78	
45	2060	0.1934	6,390	\$1,236	\$33	4,172	\$807	10,734	\$2,076	0.05	0.1434	\$1,539.73	
46	2061	0.1946	6,390	\$1,243	\$33	4,172	\$812	10,734	\$2,088	0.05	0.1446	\$1,551.74	
47	2062	0.1957	6,390	\$1,250	\$34	4,172	\$816	10,734	\$2,101	0.05	0.1457	\$1,563.82	
48	2063	0.1968	6,390	\$1,258	\$34	4,172	\$821	10,734	\$2,113	0.05	0.1468	\$1,575.97	
49	2064	0.1980	6,390	\$1,265	\$34	4,172	\$826	10,734	\$2,125	0.05	0.1480	\$1,588.19	
50	2065	0.1991	6,390	\$1,272	\$34	4,172	\$831	10,734	\$2,137	0.05	0.1491	\$1,600.48	
51	2066	0.2003	6,390	\$1,280	\$34	4,172	\$835	10,734	\$2,150	0.05	0.1503	\$1,612.85	
52	2067	0.2014	6,390	\$1,287	\$35	4,172	\$840	10,734	\$2,162	0.05	0.1514	\$1,625.28	
53	2068	0.2026	6,390	\$1,294	\$35	4,172	\$845	10,734	\$2,174	0.05	0.1526	\$1,637.79	
54	2069	0.2038	6,390	\$1,302	\$35	4,172	\$850	10,734	\$2,187	0.05	0.1538	\$1,650.37	
55	2070	0.2049	6,390	\$1,310	\$35	4,172	\$855	10,734	\$2,200	0.05	0.1549	\$1,663.02	
56	2071	0.2061	6,390	\$1,317	\$35	4,172	\$860	10,734	\$2,212	0.05	0.1561	\$1,675.75	
57	2072	0.2073	6,390	\$1,325	\$36	4,172	\$865	10,734	\$2,225	0.05	0.1573	\$1,688.54	
58	2073	0.2085	6,390	\$1,332	\$36	4,172	\$870	10,734	\$2,238	0.05	0.1585	\$1,701.42	
59	2074	0.2097	6,390	\$1,340	\$36	4,172	\$875	10,734	\$2,251	0.05	0.1597	\$1,714.36	
60	2075	0.2109	6,390	\$1,348	\$36	4,172	\$880	10,734	\$2,264	0.05	0.1609	\$1,727.39	

Table D1-1.67: Annual Operating Costs (V.GSHP) of a 2,000 square feet detached house above grade (average construction type) in the city of North Bay (two life cycles and three life cycles for a 60 year project lifespan); base case scenario in comparison with feed-in-tariff (FIT) scenario. In the FIT scenario, an incentive of \$0.05/KWh is provided on electricity bills throughout the project lifespan

Horizontal Ground Source Heat Pump (H.GSHP)

Base Case Scenario											Feed in Tariff (FIT)		
H.GSHP											FIT		
#	Year	Electricity Rates \$/KWh	Heating KWh	Heating Operating Cost \$	Cooling KWh	Cooling Operating Cost \$	Hot Water KWh	Hot Water Operating Cost \$	Total KWh	Total Operating Cost \$	Incentives (\$/KWh)	S/KWh	Operating Cost
1	2016	0.1501	6,533	\$980	179	\$27	4,170	\$626	10,882	\$1,633	0.05	0.1001	\$1,089.10
2	2017	0.1542	6,533	\$1,007	179	\$28	4,170	\$643	10,882	\$1,678	0.05	0.1042	\$1,133.76
3	2018	0.1583	6,533	\$1,034	179	\$28	4,170	\$660	10,882	\$1,723	0.05	0.1083	\$1,178.42
4	2019	0.1625	6,533	\$1,062	179	\$29	4,170	\$678	10,882	\$1,769	0.05	0.1125	\$1,224.65
5	2020	0.1668	6,533	\$1,090	179	\$30	4,170	\$696	10,882	\$1,815	0.05	0.1168	\$1,270.87
6	2021	0.1621	6,533	\$1,059	179	\$29	4,170	\$676	10,882	\$1,764	0.05	0.1121	\$1,220.34
7	2022	0.1629	6,533	\$1,064	179	\$29	4,170	\$679	10,882	\$1,773	0.05	0.1129	\$1,228.96
8	2023	0.1639	6,533	\$1,071	179	\$29	4,170	\$683	10,882	\$1,783	0.05	0.1139	\$1,239.14
9	2024	0.1648	6,533	\$1,077	179	\$30	4,170	\$687	10,882	\$1,793	0.05	0.1148	\$1,249.33
10	2025	0.1656	6,533	\$1,082	179	\$30	4,170	\$691	10,882	\$1,802	0.05	0.1156	\$1,257.94
11	2026	0.1665	6,533	\$1,088	179	\$30	4,170	\$694	10,882	\$1,812	0.05	0.1165	\$1,268.13
12	2027	0.1674	6,533	\$1,094	179	\$30	4,170	\$698	10,882	\$1,822	0.05	0.1174	\$1,277.92
13	2028	0.1683	6,533	\$1,099	179	\$30	4,170	\$702	10,882	\$1,831	0.05	0.1183	\$1,286.93
14	2029	0.1692	6,533	\$1,105	179	\$30	4,170	\$705	10,882	\$1,841	0.05	0.1192	\$1,296.73
15	2030	0.1701	6,533	\$1,111	179	\$30	4,170	\$709	10,882	\$1,851	0.05	0.1201	\$1,306.91
16	2031	0.1704	6,533	\$1,113	179	\$30	4,170	\$710	10,882	\$1,854	0.05	0.1204	\$1,309.66
17	2032	0.1705	6,533	\$1,114	179	\$31	4,170	\$711	10,882	\$1,855	0.05	0.1205	\$1,311.22
18	2033	0.1707	6,533	\$1,115	179	\$31	4,170	\$712	10,882	\$1,858	0.05	0.1207	\$1,313.96
19	2034	0.1710	6,533	\$1,117	179	\$31	4,170	\$713	10,882	\$1,861	0.05	0.1210	\$1,317.10
20	2035	0.1713	6,533	\$1,119	179	\$31	4,170	\$714	10,882	\$1,864	0.05	0.1213	\$1,319.84
21	2036	0.1714	6,533	\$1,120	179	\$31	4,170	\$715	10,882	\$1,866	0.05	0.1214	\$1,321.41
22	2037	0.1717	6,533	\$1,122	179	\$31	4,170	\$716	10,882	\$1,868	0.05	0.1217	\$1,324.15
23	2038	0.1720	6,533	\$1,123	179	\$31	4,170	\$717	10,882	\$1,871	0.05	0.1220	\$1,327.28
24	2039	0.1722	6,533	\$1,125	179	\$31	4,170	\$718	10,882	\$1,874	0.05	0.1222	\$1,330.03
25	2040	0.1724	6,533	\$1,126	179	\$31	4,170	\$719	10,882	\$1,876	0.05	0.1224	\$1,331.59
26	2041	0.1734	6,533	\$1,133	179	\$31	4,170	\$723	10,882	\$1,887	0.05	0.1234	\$1,342.44
27	2042	0.1744	6,533	\$1,139	179	\$31	4,170	\$727	10,882	\$1,897	0.05	0.1244	\$1,353.36
28	2043	0.1754	6,533	\$1,146	179	\$31	4,170	\$731	10,882	\$1,908	0.05	0.1254	\$1,364.33
29	2044	0.1764	6,533	\$1,152	179	\$32	4,170	\$736	10,882	\$1,919	0.05	0.1264	\$1,375.37
30	2045	0.1774	6,533	\$1,159	179	\$32	4,170	\$740	10,882	\$1,931	0.05	0.1274	\$1,386.48
31	2046	0.1784	6,533	\$1,166	179	\$32	4,170	\$744	10,882	\$1,942	0.05	0.1284	\$1,397.65
32	2047	0.1795	6,533	\$1,172	179	\$32	4,170	\$748	10,882	\$1,953	0.05	0.1295	\$1,408.88
33	2048	0.1805	6,533	\$1,179	179	\$32	4,170	\$753	10,882	\$1,964	0.05	0.1305	\$1,420.18
34	2049	0.1816	6,533	\$1,186	179	\$32	4,170	\$757	10,882	\$1,976	0.05	0.1316	\$1,431.54
35	2050	0.1826	6,533	\$1,193	179	\$33	4,170	\$761	10,882	\$1,987	0.05	0.1326	\$1,442.97
36	2051	0.1837	6,533	\$1,200	179	\$33	4,170	\$766	10,882	\$1,999	0.05	0.1337	\$1,454.46
37	2052	0.1847	6,533	\$1,207	179	\$33	4,170	\$770	10,882	\$2,010	0.05	0.1347	\$1,466.02
38	2053	0.1858	6,533	\$1,214	179	\$33	4,170	\$775	10,882	\$2,022	0.05	0.1358	\$1,477.65
39	2054	0.1869	6,533	\$1,221	179	\$33	4,170	\$779	10,882	\$2,033	0.05	0.1369	\$1,489.35
40	2055	0.1879	6,533	\$1,228	179	\$34	4,170	\$784	10,882	\$2,045	0.05	0.1379	\$1,501.11
41	2056	0.1890	6,533	\$1,235	179	\$34	4,170	\$788	10,882	\$2,057	0.05	0.1390	\$1,512.94
42	2057	0.1901	6,533	\$1,242	179	\$34	4,170	\$793	10,882	\$2,069	0.05	0.1401	\$1,524.84
43	2058	0.1912	6,533	\$1,249	179	\$34	4,170	\$797	10,882	\$2,081	0.05	0.1412	\$1,536.81
44	2059	0.1923	6,533	\$1,257	179	\$34	4,170	\$802	10,882	\$2,093	0.05	0.1423	\$1,548.85
45	2060	0.1934	6,533	\$1,264	179	\$35	4,170	\$807	10,882	\$2,105	0.05	0.1434	\$1,560.96
46	2061	0.1946	6,533	\$1,271	179	\$35	4,170	\$811	10,882	\$2,117	0.05	0.1446	\$1,573.13
47	2062	0.1957	6,533	\$1,278	179	\$35	4,170	\$816	10,882	\$2,129	0.05	0.1457	\$1,585.38
48	2063	0.1968	6,533	\$1,286	179	\$35	4,170	\$821	10,882	\$2,142	0.05	0.1468	\$1,597.70
49	2064	0.1980	6,533	\$1,293	179	\$35	4,170	\$825	10,882	\$2,154	0.05	0.1480	\$1,610.09
50	2065	0.1991	6,533	\$1,301	179	\$36	4,170	\$830	10,882	\$2,167	0.05	0.1491	\$1,622.55
51	2066	0.2003	6,533	\$1,308	179	\$36	4,170	\$835	10,882	\$2,179	0.05	0.1503	\$1,635.09
52	2067	0.2014	6,533	\$1,316	179	\$36	4,170	\$840	10,882	\$2,192	0.05	0.1514	\$1,647.69
53	2068	0.2026	6,533	\$1,323	179	\$36	4,170	\$845	10,882	\$2,204	0.05	0.1526	\$1,660.37
54	2069	0.2038	6,533	\$1,331	179	\$36	4,170	\$850	10,882	\$2,217	0.05	0.1538	\$1,673.12
55	2070	0.2049	6,533	\$1,339	179	\$37	4,170	\$855	10,882	\$2,230	0.05	0.1549	\$1,685.95
56	2071	0.2061	6,533	\$1,347	179	\$37	4,170	\$860	10,882	\$2,243	0.05	0.1561	\$1,698.85
57	2072	0.2073	6,533	\$1,354	179	\$37	4,170	\$864	10,882	\$2,256	0.05	0.1573	\$1,711.83
58	2073	0.2085	6,533	\$1,362	179	\$37	4,170	\$869	10,882	\$2,269	0.05	0.1585	\$1,724.88
59	2074	0.2097	6,533	\$1,370	179	\$38	4,170	\$875	10,882	\$2,282	0.05	0.1597	\$1,738.00
60	2075	0.2109	6,533	\$1,378	179	\$38	4,170	\$880	10,882	\$2,295	0.05	0.1609	\$1,751.20

Table D1-1.68: Annual Operating Costs (H.GSHP) of a 2,000 square feet detached house above grade (average construction type) in the city of North Bay (two life cycles and three life cycles for a 60 year project lifespan); base case scenario in comparison with feed in-tariff (FIT) scenario. In the FIT scenario, an incentive of \$0.05/KWh is provided on electricity bills throughout the project lifespan

Traditional HVAC Applications

Base Case Scenario															Carbon Taxes						
#	Year	Electricity Rates	Natural Gas Rates	Heating		Heating Operating Cost	Heating Operating Cost	Total Heating Operating Cost	Cooling	Cooling Operating Cost	Hot Water	Hot Water Operating Cost	Total	Total	Total Electricity Operating Cost	Total Natural Gas Operating Cost	Total	Conversion of m ³ into Tons	Total Tons	Carbon Tax	Operating Costs
				KWh (Electricity)	m ³ (Gas)																
1	2016	0.1501	0.3458	1,782	2,987	\$1,033	\$1,300	750	\$113	1,061	\$367	2,532	4,048	380	\$1,400	\$1,780	7.33	7.33	\$10	\$73.27	\$1,853.20
2	2017	0.1542	0.3588	1,782	2,987	\$275	\$1,072	750	\$116	1,061	\$164	2,532	4,048	390	\$1,453	\$1,843	7.33	7.33	\$20	\$146.54	\$1,989.51
3	2018	0.1583	0.3718	1,782	2,987	\$282	\$1,111	750	\$119	1,061	\$168	2,532	4,048	401	\$1,505	\$1,906	7.33	7.33	\$30	\$219.81	\$2,125.82
4	2019	0.1625	0.3776	1,782	2,987	\$290	\$1,128	750	\$122	1,061	\$172	2,532	4,048	412	\$1,528	\$1,940	7.33	7.33	\$40	\$293.08	\$2,233.08
5	2020	0.1668	0.3841	1,782	2,987	\$297	\$1,147	750	\$125	1,061	\$177	2,532	4,048	422	\$1,555	\$1,977	7.33	7.33	\$50	\$366.34	\$2,343.43
6	2021	0.1621	0.3883	1,782	2,987	\$289	\$1,160	750	\$122	1,061	\$172	2,532	4,048	411	\$1,572	\$1,982	7.33	7.33	\$60	\$439.61	\$2,421.97
7	2022	0.1629	0.3929	1,782	2,987	\$290	\$1,174	750	\$122	1,061	\$173	2,532	4,048	413	\$1,590	\$2,003	7.33	7.33	\$70	\$512.88	\$2,515.83
8	2023	0.1639	0.3967	1,782	2,987	\$292	\$1,185	750	\$123	1,061	\$174	2,532	4,048	415	\$1,606	\$2,021	7.33	7.33	\$80	\$586.15	\$2,606.95
9	2024	0.1648	0.4005	1,782	2,987	\$294	\$1,196	750	\$124	1,061	\$175	2,532	4,048	417	\$1,621	\$2,039	7.33	7.33	\$90	\$659.42	\$2,698.08
10	2025	0.1656	0.4040	1,782	2,987	\$295	\$1,207	750	\$124	1,061	\$176	2,532	4,048	419	\$1,635	\$2,055	7.33	7.33	\$100	\$732.69	\$2,787.29
11	2026	0.1665	0.4070	1,782	2,987	\$297	\$1,216	750	\$125	1,061	\$177	2,532	4,048	422	\$1,648	\$2,069	7.33	7.33	\$110	\$805.96	\$2,875.32
12	2027	0.1674	0.4097	1,782	2,987	\$298	\$1,224	750	\$126	1,061	\$178	2,532	4,048	424	\$1,659	\$2,082	7.33	7.33	\$120	\$879.23	\$2,961.70
13	2028	0.1683	0.4124	1,782	2,987	\$300	\$1,232	750	\$126	1,061	\$179	2,532	4,048	426	\$1,669	\$2,095	7.33	7.33	\$130	\$952.49	\$3,047.91
14	2029	0.1692	0.4151	1,782	2,987	\$301	\$1,240	750	\$127	1,061	\$179	2,532	4,048	428	\$1,680	\$2,109	7.33	7.33	\$140	\$1,025.76	\$3,134.30
15	2030	0.1701	0.4170	1,782	2,987	\$303	\$1,246	750	\$128	1,061	\$180	2,532	4,048	431	\$1,688	\$2,119	7.33	7.33	\$150	\$1,099.03	\$3,217.68
16	2031	0.1704	0.4189	1,782	2,987	\$304	\$1,251	750	\$128	1,061	\$181	2,532	4,048	431	\$1,696	\$2,127	7.33	7.33	\$160	\$1,172.30	\$3,299.33
17	2032	0.1705	0.4204	1,782	2,987	\$304	\$1,256	750	\$128	1,061	\$181	2,532	4,048	432	\$1,702	\$2,134	7.33	7.33	\$170	\$1,245.57	\$3,379.16
18	2033	0.1707	0.4223	1,782	2,987	\$304	\$1,262	750	\$128	1,061	\$181	2,532	4,048	432	\$1,710	\$2,142	7.33	7.33	\$180	\$1,318.84	\$3,460.81
19	2034	0.1710	0.4246	1,782	2,987	\$305	\$1,268	750	\$128	1,061	\$181	2,532	4,048	433	\$1,719	\$2,152	7.33	7.33	\$190	\$1,392.11	\$3,544.10
20	2035	0.1713	0.4265	1,782	2,987	\$305	\$1,274	750	\$128	1,061	\$182	2,532	4,048	434	\$1,727	\$2,160	7.33	7.33	\$200	\$1,465.38	\$3,625.75
21	2036	0.1714	0.4288	1,782	2,987	\$305	\$1,281	750	\$129	1,061	\$182	2,532	4,048	434	\$1,736	\$2,170	7.33	7.33	\$210	\$1,538.64	\$3,708.67
22	2037	0.1717	0.4311	1,782	2,987	\$306	\$1,288	750	\$129	1,061	\$182	2,532	4,048	435	\$1,745	\$2,180	7.33	7.33	\$220	\$1,611.91	\$3,791.87
23	2038	0.1720	0.4331	1,782	2,987	\$306	\$1,294	750	\$129	1,061	\$182	2,532	4,048	435	\$1,753	\$2,188	7.33	7.33	\$230	\$1,685.18	\$3,873.61
24	2039	0.1722	0.4353	1,782	2,987	\$307	\$1,300	750	\$129	1,061	\$183	2,532	4,048	436	\$1,762	\$2,198	7.33	7.33	\$240	\$1,758.45	\$3,956.81
25	2040	0.1724	0.4376	1,782	2,987	\$307	\$1,307	750	\$129	1,061	\$183	2,532	4,048	436	\$1,772	\$2,208	7.33	7.33	\$250	\$1,831.72	\$4,039.73
26	2041	0.1734	0.4420	1,782	2,987	\$309	\$1,320	750	\$130	1,061	\$184	2,532	4,048	439	\$1,789	\$2,228	7.33	7.33	\$260	\$1,904.99	\$4,132.99
27	2042	0.1744	0.4463	1,782	2,987	\$311	\$1,333	750	\$131	1,061	\$185	2,532	4,048	441	\$1,807	\$2,248	7.33	7.33	\$270	\$1,978.26	\$4,226.44
28	2043	0.1754	0.4507	1,782	2,987	\$313	\$1,346	750	\$132	1,061	\$186	2,532	4,048	444	\$1,824	\$2,269	7.33	7.33	\$280	\$2,051.53	\$4,320.07
29	2044	0.1764	0.4552	1,782	2,987	\$314	\$1,360	750	\$132	1,061	\$187	2,532	4,048	447	\$1,842	\$2,289	7.33	7.33	\$290	\$2,124.80	\$4,413.90
30	2045	0.1774	0.4596	1,782	2,987	\$316	\$1,373	750	\$133	1,061	\$188	2,532	4,048	449	\$1,861	\$2,310	7.33	7.33	\$300	\$2,198.06	\$4,507.92
31	2046	0.1784	0.4642	1,782	2,987	\$318	\$1,387	750	\$134	1,061	\$189	2,532	4,048	452	\$1,879	\$2,331	7.33	7.33	\$310	\$2,271.33	\$4,602.13
32	2047	0.1795	0.4688	1,782	2,987	\$320	\$1,400	750	\$135	1,061	\$190	2,532	4,048	454	\$1,898	\$2,352	7.33	7.33	\$320	\$2,344.60	\$4,696.54
33	2048	0.1805	0.4734	1,782	2,987	\$322	\$1,414	750	\$135	1,061	\$192	2,532	4,048	457	\$1,916	\$2,373	7.33	7.33	\$330	\$2,417.87	\$4,791.14
34	2049	0.1816	0.4780	1,782	2,987	\$324	\$1,428	750	\$136	1,061	\$193	2,532	4,048	460	\$1,935	\$2,395	7.33	7.33	\$340	\$2,491.14	\$4,885.95
35	2050	0.1826	0.4828	1,782	2,987	\$325	\$1,442	750	\$137	1,061	\$194	2,532	4,048	462	\$1,954	\$2,417	7.33	7.33	\$350	\$2,564.41	\$4,980.95
36	2051	0.1837	0.4875	1,782	2,987	\$327	\$1,456	750	\$138	1,061	\$195	2,532	4,048	465	\$1,973	\$2,438	7.33	7.33	\$360	\$2,637.68	\$5,076.16
37	2052	0.1847	0.4923	1,782	2,987	\$329	\$1,471	750	\$139	1,061	\$196	2,532	4,048	468	\$1,993	\$2,461	7.33	7.33	\$370	\$2,710.95	\$5,171.58
38	2053	0.1858	0.4972	1,782	2,987	\$331	\$1,485	750	\$139	1,061	\$197	2,532	4,048	470	\$2,013	\$2,483	7.33	7.33	\$380	\$2,784.21	\$5,267.20
39	2054	0.1869	0.5021	1,782	2,987	\$333	\$1,500	750	\$140	1,061	\$198	2,532	4,048	473	\$2,032	\$2,506	7.33	7.33	\$390	\$2,857.48	\$5,363.03
40	2055	0.1879	0.5070	1,782	2,987	\$335	\$1,514	750	\$141	1,061	\$199	2,532	4,048	476	\$2,052	\$2,528	7.33	7.33	\$400	\$2,930.75	\$5,459.07
41	2056	0.1890	0.5120	1,782	2,987	\$337	\$1,529	750	\$142	1,061	\$201	2,532	4,048	479	\$2,073	\$2,551	7.33	7.33	\$410	\$3,004.02	\$5,555.33
42	2057	0.1901	0.5171	1,782	2,987	\$339	\$1,545	750	\$143	1,061	\$202	2,532	4,048	481	\$2,093	\$2,575	7.33	7.33	\$420	\$3,077.29	\$5,651.80
43	2058	0.1912	0.5222	1,782	2,987	\$341	\$1,560	750	\$143	1,061	\$203	2,532	4,048	484	\$2,114	\$2,598	7.33	7.33	\$430	\$3,150.56	\$5,748.49
44	2059	0.1923	0.5273	1,782	2,987	\$343	\$1,575	750	\$144	1,061	\$204	2,532	4,048	487	\$2,135	\$2,622	7.33	7.33	\$440	\$3,223.83	\$5,845.40
45	2060	0.1934	0.5325	1,782	2,987	\$345	\$1,591	750	\$145	1,061	\$205	2,532	4,048	490	\$2,156	\$2,645	7.33	7.33	\$450	\$3,297.10	\$5,942.53
46	2061	0.1946	0.5378	1,782	2,987	\$347	\$1,606	750	\$146	1,061	\$206	2,532	4,048	493	\$2,177	\$2,670	7.33	7.33	\$460	\$3,370.36	\$6,039.89
47	2062	0.1957	0.5431	1,782	2,987	\$349	\$1,622	750	\$147	1,061	\$208	2,532	4,048	495	\$2,198	\$2,694	7.33	7.33	\$470	\$3,443.63	\$6,137.47
48	2063	0.1968	0.5484	1,782	2,987	\$351	\$1,638	750	\$148	1,061	\$209	2,532	4,048	498	\$2,220	\$2,718	7.33	7.33	\$480	\$3,516.90	\$6,235.28
49	2064	0.1980	0.5538	1,782	2,987	\$353	\$1,654	750	\$148	1,061	\$210	2,532	4,048	501	\$2,242	\$2,743	7.33	7.33	\$490	\$3,590.17	\$6,333.32
50	2065	0.1991	0.5593	1,782	2,987	\$355	\$1,671	750	\$149	1,061	\$211	2,532	4,048	504	\$2,264	\$2,768	7.33	7.33	\$500	\$3,663.44	\$6,431.59

24. Sault Ste. Marie (North) – Annual Operating Costs

Vertical Ground Source Heat Pump (V.GSHP)

Base Case Scenario											Feed in Tariff (FIT)		
#	Year	Electricity Rates		V.GSHP		Hot Water		Total		Total Operating Cost	Incentives (\$/KWh)	FIT	
		\$/KWh	KWh	Heating Operating Cost	Cooling Operating Cost	Hot Water Operating Cost	Total	Operating Cost	Operating Cost				
1	2016	0.1501	6,560	\$985	\$	4,241	\$637	10,959	\$1,645	0.05	0.1001	\$1,096.81	
2	2017	0.1542	6,560	\$1,011	\$	4,241	\$654	10,959	\$1,690	0.05	0.1042	\$1,141.78	
3	2018	0.1583	6,560	\$1,038	\$	4,241	\$671	10,959	\$1,735	0.05	0.1083	\$1,186.76	
4	2019	0.1625	6,560	\$1,066	\$	4,241	\$689	10,959	\$1,781	0.05	0.1125	\$1,233.31	
5	2020	0.1668	6,560	\$1,094	\$	4,241	\$707	10,959	\$1,828	0.05	0.1168	\$1,279.87	
6	2021	0.1621	6,560	\$1,064	\$	4,241	\$688	10,959	\$1,777	0.05	0.1121	\$1,228.97	
7	2022	0.1629	6,560	\$1,069	\$	4,241	\$691	10,959	\$1,786	0.05	0.1129	\$1,237.65	
8	2023	0.1639	6,560	\$1,075	\$	4,241	\$695	10,959	\$1,796	0.05	0.1139	\$1,247.91	
9	2024	0.1648	6,560	\$1,081	\$	4,241	\$699	10,959	\$1,806	0.05	0.1148	\$1,258.17	
10	2025	0.1656	6,560	\$1,086	\$	4,241	\$702	10,959	\$1,815	0.05	0.1156	\$1,266.85	
11	2026	0.1665	6,560	\$1,092	\$	4,241	\$706	10,959	\$1,825	0.05	0.1165	\$1,277.10	
12	2027	0.1674	6,560	\$1,098	\$	4,241	\$710	10,959	\$1,835	0.05	0.1174	\$1,286.97	
13	2028	0.1683	6,560	\$1,104	\$	4,241	\$714	10,959	\$1,844	0.05	0.1183	\$1,296.04	
14	2029	0.1692	6,560	\$1,110	\$	4,241	\$717	10,959	\$1,854	0.05	0.1192	\$1,305.90	
15	2030	0.1701	6,560	\$1,116	\$	4,241	\$721	10,959	\$1,864	0.05	0.1201	\$1,316.16	
16	2031	0.1704	6,560	\$1,118	\$	4,241	\$722	10,959	\$1,867	0.05	0.1204	\$1,318.92	
17	2032	0.1705	6,560	\$1,118	\$	4,241	\$723	10,959	\$1,868	0.05	0.1205	\$1,320.50	
18	2033	0.1707	6,560	\$1,120	\$	4,241	\$724	10,959	\$1,871	0.05	0.1207	\$1,323.26	
19	2034	0.1710	6,560	\$1,122	\$	4,241	\$725	10,959	\$1,874	0.05	0.1210	\$1,326.42	
20	2035	0.1713	6,560	\$1,124	\$	4,241	\$726	10,959	\$1,877	0.05	0.1213	\$1,329.18	
21	2036	0.1714	6,560	\$1,125	\$	4,241	\$727	10,959	\$1,879	0.05	0.1214	\$1,330.76	
22	2037	0.1717	6,560	\$1,126	\$	4,241	\$728	10,959	\$1,881	0.05	0.1217	\$1,333.52	
23	2038	0.1720	6,560	\$1,128	\$	4,241	\$729	10,959	\$1,885	0.05	0.1220	\$1,336.68	
24	2039	0.1722	6,560	\$1,130	\$	4,241	\$730	10,959	\$1,887	0.05	0.1222	\$1,339.44	
25	2040	0.1724	6,560	\$1,131	\$	4,241	\$731	10,959	\$1,889	0.05	0.1224	\$1,341.02	
26	2041	0.1734	6,560	\$1,137	\$	4,241	\$735	10,959	\$1,900	0.05	0.1234	\$1,351.94	
27	2042	0.1744	6,560	\$1,144	\$	4,241	\$739	10,959	\$1,911	0.05	0.1244	\$1,362.93	
28	2043	0.1754	6,560	\$1,150	\$	4,241	\$744	10,959	\$1,922	0.05	0.1254	\$1,373.99	
29	2044	0.1764	6,560	\$1,157	\$	4,241	\$748	10,959	\$1,933	0.05	0.1264	\$1,385.11	
30	2045	0.1774	6,560	\$1,164	\$	4,241	\$752	10,959	\$1,944	0.05	0.1274	\$1,396.29	
31	2046	0.1784	6,560	\$1,171	\$	4,241	\$757	10,959	\$1,955	0.05	0.1284	\$1,407.54	
32	2047	0.1795	6,560	\$1,177	\$	4,241	\$761	10,959	\$1,967	0.05	0.1295	\$1,418.85	
33	2048	0.1805	6,560	\$1,184	\$	4,241	\$766	10,959	\$1,978	0.05	0.1305	\$1,430.23	
34	2049	0.1816	6,560	\$1,191	\$	4,241	\$770	10,959	\$1,990	0.05	0.1316	\$1,441.67	
35	2050	0.1826	6,560	\$1,198	\$	4,241	\$774	10,959	\$2,001	0.05	0.1326	\$1,453.18	
36	2051	0.1837	6,560	\$1,205	\$	4,241	\$779	10,959	\$2,013	0.05	0.1337	\$1,464.75	
37	2052	0.1847	6,560	\$1,212	\$	4,241	\$783	10,959	\$2,024	0.05	0.1347	\$1,476.40	
38	2053	0.1858	6,560	\$1,219	\$	4,241	\$788	10,959	\$2,036	0.05	0.1358	\$1,488.11	
39	2054	0.1869	6,560	\$1,226	\$	4,241	\$792	10,959	\$2,048	0.05	0.1369	\$1,499.89	
40	2055	0.1879	6,560	\$1,233	\$	4,241	\$797	10,959	\$2,060	0.05	0.1379	\$1,511.73	
41	2056	0.1890	6,560	\$1,240	\$	4,241	\$802	10,959	\$2,072	0.05	0.1390	\$1,523.65	
42	2057	0.1901	6,560	\$1,247	\$	4,241	\$806	10,959	\$2,084	0.05	0.1401	\$1,535.63	
43	2058	0.1912	6,560	\$1,254	\$	4,241	\$811	10,959	\$2,096	0.05	0.1412	\$1,547.69	
44	2059	0.1923	6,560	\$1,262	\$	4,241	\$816	10,959	\$2,108	0.05	0.1423	\$1,559.81	
45	2060	0.1934	6,560	\$1,269	\$	4,241	\$820	10,959	\$2,120	0.05	0.1434	\$1,572.00	
46	2061	0.1946	6,560	\$1,276	\$	4,241	\$825	10,959	\$2,132	0.05	0.1446	\$1,584.27	
47	2062	0.1957	6,560	\$1,284	\$	4,241	\$830	10,959	\$2,145	0.05	0.1457	\$1,596.60	
48	2063	0.1968	6,560	\$1,291	\$	4,241	\$835	10,959	\$2,157	0.05	0.1468	\$1,609.01	
49	2064	0.1980	6,560	\$1,299	\$	4,241	\$840	10,959	\$2,169	0.05	0.1480	\$1,621.48	
50	2065	0.1991	6,560	\$1,306	\$	4,241	\$844	10,959	\$2,182	0.05	0.1491	\$1,634.03	
51	2066	0.2003	6,560	\$1,314	\$	4,241	\$849	10,959	\$2,195	0.05	0.1503	\$1,646.66	
52	2067	0.2014	6,560	\$1,321	\$	4,241	\$854	10,959	\$2,207	0.05	0.1514	\$1,659.35	
53	2068	0.2026	6,560	\$1,329	\$	4,241	\$859	10,959	\$2,220	0.05	0.1526	\$1,672.12	
54	2069	0.2038	6,560	\$1,337	\$	4,241	\$864	10,959	\$2,233	0.05	0.1538	\$1,684.96	
55	2070	0.2049	6,560	\$1,344	\$	4,241	\$869	10,959	\$2,246	0.05	0.1549	\$1,697.88	
56	2071	0.2061	6,560	\$1,352	\$	4,241	\$874	10,959	\$2,259	0.05	0.1561	\$1,710.87	
57	2072	0.2073	6,560	\$1,360	\$	4,241	\$879	10,959	\$2,272	0.05	0.1573	\$1,723.94	
58	2073	0.2085	6,560	\$1,368	\$	4,241	\$884	10,959	\$2,285	0.05	0.1585	\$1,737.08	
59	2074	0.2097	6,560	\$1,376	\$	4,241	\$889	10,959	\$2,298	0.05	0.1597	\$1,750.30	
60	2075	0.2109	6,560	\$1,384	\$	4,241	\$895	10,959	\$2,312	0.05	0.1609	\$1,763.60	

Table D1-1.70: Annual Operating Costs (V.GSHP) of a 2,000 square feet detached house above grade (average construction type) in the city of Sault Ste. Marie (two life cycles and three life cycles for a 60 year project lifespan); base case scenario in comparison with feed in-tariff (FIT) scenario. In the FIT scenario, an incentive of \$0.05/KWh is provided on electricity bills throughout the project lifespan

Horizontal Ground Source Heat Pump (H.GSHP)

Base Case Scenario												Feed in Tariff (FIT)		
H.GSHP												FIT		
#	Year	Electricity Rates \$/KWh	Heating KWh	Heating Operating Cost \$	Cooling KWh	Cooling Operating Cost \$	Hot Water KWh	Hot Water Operating Cost \$	Total KWh	Total Operating Cost \$	Incentives (\$/KWh)	\$/KWh	Operating Cost	
1	2016	0.1501	6,656	\$999	162	\$24	4,226	\$634	11,044	\$1,658	0.05	0.1001	\$1,105.31	
2	2017	0.1542	6,656	\$1,026	162	\$25	4,226	\$652	11,044	\$1,703	0.05	0.1042	\$1,150.64	
3	2018	0.1583	6,656	\$1,054	162	\$26	4,226	\$669	11,044	\$1,748	0.05	0.1083	\$1,195.96	
4	2019	0.1625	6,656	\$1,082	162	\$26	4,226	\$687	11,044	\$1,795	0.05	0.1125	\$1,242.88	
5	2020	0.1668	6,656	\$1,110	162	\$27	4,226	\$705	11,044	\$1,842	0.05	0.1168	\$1,289.79	
6	2021	0.1621	6,656	\$1,079	162	\$26	4,226	\$685	11,044	\$1,791	0.05	0.1121	\$1,238.50	
7	2022	0.1629	6,656	\$1,084	162	\$26	4,226	\$689	11,044	\$1,799	0.05	0.1129	\$1,247.25	
8	2023	0.1639	6,656	\$1,091	162	\$27	4,226	\$693	11,044	\$1,810	0.05	0.1139	\$1,257.59	
9	2024	0.1648	6,656	\$1,097	162	\$27	4,226	\$696	11,044	\$1,820	0.05	0.1148	\$1,267.92	
10	2025	0.1656	6,656	\$1,102	162	\$27	4,226	\$700	11,044	\$1,829	0.05	0.1156	\$1,276.67	
11	2026	0.1665	6,656	\$1,108	162	\$27	4,226	\$704	11,044	\$1,839	0.05	0.1165	\$1,287.01	
12	2027	0.1674	6,656	\$1,114	162	\$27	4,226	\$708	11,044	\$1,849	0.05	0.1174	\$1,296.95	
13	2028	0.1683	6,656	\$1,120	162	\$27	4,226	\$711	11,044	\$1,858	0.05	0.1183	\$1,306.09	
14	2029	0.1692	6,656	\$1,126	162	\$27	4,226	\$715	11,044	\$1,868	0.05	0.1192	\$1,316.03	
15	2030	0.1701	6,656	\$1,132	162	\$28	4,226	\$719	11,044	\$1,879	0.05	0.1201	\$1,326.37	
16	2031	0.1704	6,656	\$1,134	162	\$28	4,226	\$720	11,044	\$1,881	0.05	0.1204	\$1,329.15	
17	2032	0.1705	6,656	\$1,135	162	\$28	4,226	\$721	11,044	\$1,883	0.05	0.1205	\$1,330.74	
18	2033	0.1707	6,656	\$1,136	162	\$28	4,226	\$722	11,044	\$1,886	0.05	0.1207	\$1,333.53	
19	2034	0.1710	6,656	\$1,138	162	\$28	4,226	\$723	11,044	\$1,889	0.05	0.1210	\$1,336.71	
20	2035	0.1713	6,656	\$1,140	162	\$28	4,226	\$724	11,044	\$1,892	0.05	0.1213	\$1,339.49	
21	2036	0.1714	6,656	\$1,141	162	\$28	4,226	\$724	11,044	\$1,893	0.05	0.1214	\$1,341.08	
22	2037	0.1717	6,656	\$1,143	162	\$28	4,226	\$726	11,044	\$1,896	0.05	0.1217	\$1,343.86	
23	2038	0.1720	6,656	\$1,145	162	\$28	4,226	\$727	11,044	\$1,899	0.05	0.1220	\$1,347.04	
24	2039	0.1722	6,656	\$1,146	162	\$28	4,226	\$728	11,044	\$1,902	0.05	0.1222	\$1,349.83	
25	2040	0.1724	6,656	\$1,147	162	\$28	4,226	\$728	11,044	\$1,904	0.05	0.1224	\$1,351.42	
26	2041	0.1734	6,656	\$1,154	162	\$28	4,226	\$733	11,044	\$1,915	0.05	0.1234	\$1,362.43	
27	2042	0.1744	6,656	\$1,161	162	\$28	4,226	\$737	11,044	\$1,926	0.05	0.1244	\$1,373.50	
28	2043	0.1754	6,656	\$1,167	162	\$28	4,226	\$741	11,044	\$1,937	0.05	0.1254	\$1,384.64	
29	2044	0.1764	6,656	\$1,174	162	\$29	4,226	\$745	11,044	\$1,948	0.05	0.1264	\$1,395.85	
30	2045	0.1774	6,656	\$1,181	162	\$29	4,226	\$750	11,044	\$1,959	0.05	0.1274	\$1,407.12	
31	2046	0.1784	6,656	\$1,188	162	\$29	4,226	\$754	11,044	\$1,971	0.05	0.1284	\$1,418.45	
32	2047	0.1795	6,656	\$1,195	162	\$29	4,226	\$758	11,044	\$1,982	0.05	0.1295	\$1,429.85	
33	2048	0.1805	6,656	\$1,201	162	\$29	4,226	\$763	11,044	\$1,994	0.05	0.1305	\$1,441.32	
34	2049	0.1816	6,656	\$1,208	162	\$29	4,226	\$767	11,044	\$2,005	0.05	0.1316	\$1,452.85	
35	2050	0.1826	6,656	\$1,215	162	\$30	4,226	\$772	11,044	\$2,017	0.05	0.1326	\$1,464.45	
36	2051	0.1837	6,656	\$1,222	162	\$30	4,226	\$776	11,044	\$2,028	0.05	0.1337	\$1,476.12	
37	2052	0.1847	6,656	\$1,229	162	\$30	4,226	\$781	11,044	\$2,040	0.05	0.1347	\$1,487.85	
38	2053	0.1858	6,656	\$1,237	162	\$30	4,226	\$785	11,044	\$2,052	0.05	0.1358	\$1,499.65	
39	2054	0.1869	6,656	\$1,244	162	\$30	4,226	\$790	11,044	\$2,064	0.05	0.1369	\$1,511.52	
40	2055	0.1879	6,656	\$1,251	162	\$30	4,226	\$794	11,044	\$2,076	0.05	0.1379	\$1,523.46	
41	2056	0.1890	6,656	\$1,258	162	\$31	4,226	\$799	11,044	\$2,088	0.05	0.1390	\$1,535.47	
42	2057	0.1901	6,656	\$1,265	162	\$31	4,226	\$803	11,044	\$2,100	0.05	0.1401	\$1,547.54	
43	2058	0.1912	6,656	\$1,273	162	\$31	4,226	\$808	11,044	\$2,112	0.05	0.1412	\$1,559.69	
44	2059	0.1923	6,656	\$1,280	162	\$31	4,226	\$813	11,044	\$2,124	0.05	0.1423	\$1,571.91	
45	2060	0.1934	6,656	\$1,288	162	\$31	4,226	\$817	11,044	\$2,136	0.05	0.1434	\$1,584.19	
46	2061	0.1946	6,656	\$1,295	162	\$32	4,226	\$822	11,044	\$2,149	0.05	0.1446	\$1,596.55	
47	2062	0.1957	6,656	\$1,303	162	\$32	4,226	\$827	11,044	\$2,161	0.05	0.1457	\$1,608.98	
48	2063	0.1968	6,656	\$1,310	162	\$32	4,226	\$832	11,044	\$2,174	0.05	0.1468	\$1,621.49	
49	2064	0.1980	6,656	\$1,318	162	\$32	4,226	\$837	11,044	\$2,186	0.05	0.1480	\$1,634.06	
50	2065	0.1991	6,656	\$1,325	162	\$32	4,226	\$841	11,044	\$2,199	0.05	0.1491	\$1,646.71	
51	2066	0.2003	6,656	\$1,333	162	\$32	4,226	\$846	11,044	\$2,212	0.05	0.1503	\$1,659.43	
52	2067	0.2014	6,656	\$1,341	162	\$33	4,226	\$851	11,044	\$2,224	0.05	0.1514	\$1,672.22	
53	2068	0.2026	6,656	\$1,348	162	\$33	4,226	\$856	11,044	\$2,237	0.05	0.1526	\$1,685.09	
54	2069	0.2038	6,656	\$1,356	162	\$33	4,226	\$861	11,044	\$2,250	0.05	0.1538	\$1,698.03	
55	2070	0.2049	6,656	\$1,364	162	\$33	4,226	\$866	11,044	\$2,263	0.05	0.1549	\$1,711.05	
56	2071	0.2061	6,656	\$1,372	162	\$33	4,226	\$871	11,044	\$2,276	0.05	0.1561	\$1,724.14	
57	2072	0.2073	6,656	\$1,380	162	\$34	4,226	\$876	11,044	\$2,290	0.05	0.1573	\$1,737.31	
58	2073	0.2085	6,656	\$1,388	162	\$34	4,226	\$881	11,044	\$2,303	0.05	0.1585	\$1,750.55	
59	2074	0.2097	6,656	\$1,396	162	\$34	4,226	\$886	11,044	\$2,316	0.05	0.1597	\$1,763.88	
60	2075	0.2109	6,656	\$1,404	162	\$34	4,226	\$891	11,044	\$2,329	0.05	0.1609	\$1,777.27	

Table D1-1.71: Annual Operating Costs (H.GSHP) of a 2,000 square feet detached house above grade (average construction type) in the city of Sault Ste. Marie (two life cycles and three life cycles for a 60 year project lifespan); base case scenario in comparison with feed in-tariff (FIT) scenario. In the FIT scenario, an incentive of \$0.05/KWh is provided on electricity bills throughout the project lifespan

Traditional HVAC Applications

Base Case Scenario																Carbon Taxes							
#	Year	Traditional													Total	Total	Total Electricity Operating Cost	Total Natural Gas Operating Cost	Total	Conversion of m ³ into Tons	Total Tons	Carbon Tax	Operating Costs
		Electricity Rates	Natural Gas Rates	Heating		Heating Operating Cost	Heating Operating Cost	Total Heating Operating Cost	Cooling	Cooling Operating Cost	Hot Water	Hot Water Operating Cost	Total	Total									
				KWh (Electricity)	m ³ (Gas)																		
1	2016	0.1501	0.3458	2,102	3,071	\$315	\$1,062	\$1,378	763	\$115	1,059	\$366	2,865	4,130	430	\$1,428	\$1,858	7.48	7.48	10	\$74.75	\$1,933.02	
2	2017	0.1542	0.3588	2,102	3,071	\$324	\$1,102	\$1,426	763	\$118	1,059	\$163	2,865	4,130	442	\$1,482	\$1,924	7.48	7.48	\$20	\$149.51	\$2,073.25	
3	2018	0.1583	0.3718	2,102	3,071	\$333	\$1,142	\$1,475	763	\$121	1,059	\$168	2,865	4,130	454	\$1,536	\$1,989	7.48	7.48	\$30	\$224.26	\$2,213.48	
4	2019	0.1625	0.3776	2,102	3,071	\$342	\$1,160	\$1,501	763	\$124	1,059	\$172	2,865	4,130	466	\$1,559	\$2,025	7.48	7.48	\$40	\$299.01	\$2,324.10	
5	2020	0.1668	0.3841	2,102	3,071	\$351	\$1,180	\$1,530	763	\$127	1,059	\$177	2,865	4,130	478	\$1,586	\$2,064	7.48	7.48	\$50	\$373.77	\$2,437.88	
6	2021	0.1621	0.3883	2,102	3,071	\$341	\$1,192	\$1,533	763	\$124	1,059	\$172	2,865	4,130	465	\$1,604	\$2,068	7.48	7.48	\$60	\$448.52	\$2,516.71	
7	2022	0.1629	0.3929	2,102	3,071	\$342	\$1,207	\$1,549	763	\$124	1,059	\$173	2,865	4,130	467	\$1,623	\$2,089	7.48	7.48	\$70	\$523.27	\$2,612.69	
8	2023	0.1639	0.3967	2,102	3,071	\$344	\$1,218	\$1,563	763	\$125	1,059	\$174	2,865	4,130	469	\$1,638	\$2,108	7.48	7.48	\$80	\$598.02	\$2,705.93	
9	2024	0.1648	0.4005	2,102	3,071	\$346	\$1,230	\$1,576	763	\$126	1,059	\$175	2,865	4,130	472	\$1,654	\$2,126	7.48	7.48	\$90	\$672.78	\$2,799.16	
10	2025	0.1656	0.4040	2,102	3,071	\$348	\$1,241	\$1,589	763	\$126	1,059	\$175	2,865	4,130	474	\$1,668	\$2,143	7.48	7.48	\$100	\$747.53	\$2,890.40	
11	2026	0.1665	0.4070	2,102	3,071	\$350	\$1,250	\$1,600	763	\$127	1,059	\$176	2,865	4,130	477	\$1,681	\$2,158	7.48	7.48	\$110	\$822.28	\$2,980.48	
12	2027	0.1674	0.4097	2,102	3,071	\$352	\$1,258	\$1,610	763	\$128	1,059	\$177	2,865	4,130	480	\$1,692	\$2,172	7.48	7.48	\$120	\$897.04	\$3,068.87	
13	2028	0.1683	0.4124	2,102	3,071	\$354	\$1,266	\$1,620	763	\$128	1,059	\$178	2,865	4,130	482	\$1,703	\$2,185	7.48	7.48	\$130	\$971.79	\$3,157.05	
14	2029	0.1692	0.4151	2,102	3,071	\$356	\$1,275	\$1,630	763	\$129	1,059	\$179	2,865	4,130	485	\$1,714	\$2,199	7.48	7.48	\$140	\$1,046.54	\$3,245.44	
15	2030	0.1701	0.4170	2,102	3,071	\$358	\$1,281	\$1,638	763	\$130	1,059	\$180	2,865	4,130	487	\$1,722	\$2,209	7.48	7.48	\$150	\$1,121.30	\$3,330.78	
16	2031	0.1704	0.4189	2,102	3,071	\$358	\$1,286	\$1,645	763	\$130	1,059	\$180	2,865	4,130	488	\$1,730	\$2,218	7.48	7.48	\$160	\$1,196.05	\$3,414.15	
17	2032	0.1705	0.4204	2,102	3,071	\$358	\$1,291	\$1,650	763	\$130	1,059	\$181	2,865	4,130	488	\$1,736	\$2,225	7.48	7.48	\$170	\$1,270.80	\$3,495.64	
18	2033	0.1707	0.4223	2,102	3,071	\$359	\$1,297	\$1,656	763	\$130	1,059	\$181	2,865	4,130	489	\$1,744	\$2,233	7.48	7.48	\$180	\$1,345.55	\$3,579.01	
19	2034	0.1710	0.4246	2,102	3,071	\$360	\$1,304	\$1,664	763	\$130	1,059	\$181	2,865	4,130	490	\$1,754	\$2,244	7.48	7.48	\$190	\$1,420.31	\$3,664.07	
20	2035	0.1713	0.4265	2,102	3,071	\$360	\$1,310	\$1,670	763	\$131	1,059	\$181	2,865	4,130	491	\$1,762	\$2,252	7.48	7.48	\$200	\$1,495.06	\$3,747.45	
21	2036	0.1714	0.4288	2,102	3,071	\$360	\$1,317	\$1,677	763	\$131	1,059	\$182	2,865	4,130	491	\$1,771	\$2,262	7.48	7.48	\$210	\$1,569.81	\$3,832.09	
22	2037	0.1717	0.4311	2,102	3,071	\$361	\$1,324	\$1,685	763	\$131	1,059	\$182	2,865	4,130	492	\$1,781	\$2,272	7.48	7.48	\$220	\$1,644.57	\$3,917.04	
23	2038	0.1720	0.4331	2,102	3,071	\$361	\$1,330	\$1,691	763	\$131	1,059	\$182	2,865	4,130	493	\$1,789	\$2,281	7.48	7.48	\$230	\$1,719.32	\$4,000.52	
24	2039	0.1722	0.4353	2,102	3,071	\$362	\$1,337	\$1,699	763	\$131	1,059	\$182	2,865	4,130	493	\$1,798	\$2,291	7.48	7.48	\$240	\$1,794.07	\$4,085.48	
25	2040	0.1724	0.4376	2,102	3,071	\$362	\$1,344	\$1,706	763	\$132	1,059	\$183	2,865	4,130	494	\$1,807	\$2,301	7.48	7.48	\$250	\$1,868.83	\$4,170.12	
26	2041	0.1734	0.4420	2,102	3,071	\$364	\$1,357	\$1,722	763	\$132	1,059	\$184	2,865	4,130	497	\$1,825	\$2,322	7.48	7.48	\$260	\$1,943.58	\$4,265.55	
27	2042	0.1744	0.4463	2,102	3,071	\$367	\$1,371	\$1,737	763	\$133	1,059	\$185	2,865	4,130	500	\$1,843	\$2,343	7.48	7.48	\$270	\$2,018.33	\$4,361.17	
28	2043	0.1754	0.4507	2,102	3,071	\$369	\$1,384	\$1,753	763	\$134	1,059	\$186	2,865	4,130	502	\$1,861	\$2,364	7.48	7.48	\$280	\$2,093.08	\$4,456.99	
29	2044	0.1764	0.4552	2,102	3,071	\$371	\$1,398	\$1,769	763	\$135	1,059	\$187	2,865	4,130	505	\$1,880	\$2,385	7.48	7.48	\$290	\$2,167.84	\$4,553.00	
30	2045	0.1774	0.4596	2,102	3,071	\$373	\$1,412	\$1,784	763	\$135	1,059	\$188	2,865	4,130	508	\$1,898	\$2,407	7.48	7.48	\$300	\$2,242.59	\$4,649.21	
31	2046	0.1784	0.4642	2,102	3,071	\$375	\$1,425	\$1,801	763	\$136	1,059	\$189	2,865	4,130	511	\$1,917	\$2,428	7.48	7.48	\$310	\$2,317.34	\$4,745.62	
32	2047	0.1795	0.4688	2,102	3,071	\$377	\$1,440	\$1,817	763	\$137	1,059	\$190	2,865	4,130	514	\$1,936	\$2,450	7.48	7.48	\$320	\$2,392.10	\$4,842.73	
33	2048	0.1805	0.4734	2,102	3,071	\$379	\$1,454	\$1,833	763	\$138	1,059	\$191	2,865	4,130	517	\$1,955	\$2,472	7.48	7.48	\$330	\$2,466.85	\$4,939.04	
34	2049	0.1816	0.4780	2,102	3,071	\$382	\$1,468	\$1,850	763	\$139	1,059	\$192	2,865	4,130	520	\$1,974	\$2,494	7.48	7.48	\$340	\$2,541.60	\$5,036.06	
35	2050	0.1826	0.4828	2,102	3,071	\$384	\$1,483	\$1,866	763	\$139	1,059	\$193	2,865	4,130	523	\$1,994	\$2,517	7.48	7.48	\$350	\$2,616.36	\$5,133.29	
36	2051	0.1837	0.4875	2,102	3,071	\$386	\$1,497	\$1,883	763	\$140	1,059	\$194	2,865	4,130	526	\$2,013	\$2,540	7.48	7.48	\$360	\$2,691.11	\$5,230.73	
37	2052	0.1847	0.4923	2,102	3,071	\$388	\$1,512	\$1,900	763	\$141	1,059	\$196	2,865	4,130	529	\$2,033	\$2,563	7.48	7.48	\$370	\$2,765.86	\$5,328.37	
38	2053	0.1858	0.4972	2,102	3,071	\$391	\$1,527	\$1,917	763	\$142	1,059	\$197	2,865	4,130	532	\$2,053	\$2,586	7.48	7.48	\$380	\$2,840.61	\$5,426.23	
39	2054	0.1869	0.5021	2,102	3,071	\$393	\$1,542	\$1,935	763	\$143	1,059	\$198	2,865	4,130	535	\$2,074	\$2,609	7.48	7.48	\$390	\$2,915.37	\$5,524.31	
40	2055	0.1879	0.5070	2,102	3,071	\$395	\$1,557	\$1,952	763	\$143	1,059	\$199	2,865	4,130	538	\$2,094	\$2,632	7.48	7.48	\$400	\$2,990.12	\$5,622.60	
41	2056	0.1890	0.5120	2,102	3,071	\$397	\$1,572	\$1,970	763	\$144	1,059	\$200	2,865	4,130	542	\$2,115	\$2,656	7.48	7.48	\$410	\$3,064.87	\$5,721.12	
42	2057	0.1901	0.5171	2,102	3,071	\$400	\$1,588	\$1,988	763	\$145	1,059	\$201	2,865	4,130	545	\$2,136	\$2,680	7.48	7.48	\$420	\$3,139.63	\$5,819.85	
43	2058	0.1912	0.5222	2,102	3,071	\$402	\$1,604	\$2,006	763	\$146	1,059	\$203	2,865	4,130	548	\$2,157	\$2,704	7.48	7.48	\$430	\$3,214.38	\$5,918.81	
44	2059	0.1923	0.5273	2,102	3,071	\$404	\$1,619	\$2,024	763	\$147	1,059	\$204	2,865	4,130	551	\$2,178	\$2,729	7.48	7.48	\$440	\$3,289.13	\$6,017.99	
45	2060	0.1934	0.5325	2,102	3,071	\$407	\$1,635	\$2,042	763	\$148	1,059	\$205	2,865	4,130	554	\$2,199	\$2,754	7.48	7.48	\$450	\$3,363.89	\$6,117.41	
46	2061	0.1946	0.5378	2,102	3,071	\$409	\$1,651	\$2,060	763	\$148	1,059	\$206	2,865	4,130	557	\$2,221	\$2,778	7.48	7.48	\$460	\$3,438.64	\$6,217.05	
47	2062	0.1957	0.5431	2,102	3,071	\$411	\$1,668	\$2,079	763	\$149	1,059	\$207	2,865	4,130	561	\$2,243	\$2,804	7.48	7.48	\$470	\$3,513.39	\$6,316.92	
48	2063	0.1968	0.5484	2,102	3,071	\$414	\$1,684	\$2,098	763	\$150	1,059	\$208	2,865	4,130	564	\$2,265	\$2,829	7.48	7.48	\$480	\$3,588.14	\$6,417.03	
49	2064	0.1980	0.5538	2,102	3,071	\$416	\$1,701	\$2,117	763	\$151	1,059	\$210	2,865	4,130	567	\$2,287	\$2,854	7.48	7.48	\$490	\$3,662.90	\$6,517.38	
50	2065	0.1991	0.5593	2,102	3,071	\$419	\$1,718	\$2,136	763	\$152	1,059	\$211	2,865	4,130	570	\$2,310	\$2,880	7.48	7.48	\$500	\$3,737.65	\$6,617.96	
51	2066	0.2003	0.5648	2,102	3,071	\$421	\$1,735	\$2,155	763	\$153	1,059	\$212	2,865	4,130	574	\$2,333	\$2,906	7.48	7.48	\$510	\$3,812.40	\$6,718.79	
52	2067	0.2014	0.5704	2,102	3,071	\$423	\$1,752	\$2,175	763	\$154	1,059	\$213	2,865	4,130	577	\$2,356	\$2,933	7.48	7.48	\$520	\$3,887.16	\$6,819.86	
53	2068	0.2026	0.5760	2,102	3,071	\$426	\$1,769	\$2,195	763	\$155	1,059	\$215	2,865	4,130	580	\$2,379	\$2,959	7.48	7				

25. Sudbury (North) – Annual Operating Costs

Vertical Ground Source Heat Pump (V.GSHP)

Base Case Scenario											Feed in Tariff (FIT)			
#	Year	V.GSHP		V.GSHP		V.GSHP		V.GSHP		Total	Total Operating Cost	Incentives (\$/KWh)	FIT	
		Electricity Rates	Heating	Heating Operating Cost	Cooling	Cooling Operating Cost	Hot Water	Hot Water Operating Cost	S/KWh				Operating Cost	
		\$/KWh	KWh	\$	KWh	\$	KWh	\$	KWh	\$				
1	2016	0.1501	7,110	\$1,067	186	\$28	3,935	\$591	11,231	\$1,686		0.05	0.1001	\$1,124.03
2	2017	0.1542	7,110	\$1,096	186	\$29	3,935	\$607	11,231	\$1,732		0.05	0.1042	\$1,170.12
3	2018	0.1583	7,110	\$1,125	186	\$29	3,935	\$623	11,231	\$1,778		0.05	0.1083	\$1,216.21
4	2019	0.1625	7,110	\$1,156	186	\$30	3,935	\$640	11,231	\$1,825		0.05	0.1125	\$1,263.92
5	2020	0.1668	7,110	\$1,186	186	\$31	3,935	\$656	11,231	\$1,873		0.05	0.1168	\$1,311.63
6	2021	0.1621	7,110	\$1,153	186	\$30	3,935	\$638	11,231	\$1,821		0.05	0.1121	\$1,259.47
7	2022	0.1629	7,110	\$1,158	186	\$30	3,935	\$641	11,231	\$1,830		0.05	0.1129	\$1,268.37
8	2023	0.1639	7,110	\$1,165	186	\$30	3,935	\$645	11,231	\$1,840		0.05	0.1139	\$1,278.88
9	2024	0.1648	7,110	\$1,172	186	\$31	3,935	\$649	11,231	\$1,851		0.05	0.1148	\$1,289.39
10	2025	0.1656	7,110	\$1,177	186	\$31	3,935	\$652	11,231	\$1,860		0.05	0.1156	\$1,298.29
11	2026	0.1665	7,110	\$1,184	186	\$31	3,935	\$655	11,231	\$1,870		0.05	0.1165	\$1,308.80
12	2027	0.1674	7,110	\$1,190	186	\$31	3,935	\$659	11,231	\$1,880		0.05	0.1174	\$1,318.91
13	2028	0.1683	7,110	\$1,196	186	\$31	3,935	\$662	11,231	\$1,890		0.05	0.1183	\$1,328.21
14	2029	0.1692	7,110	\$1,203	186	\$31	3,935	\$666	11,231	\$1,900		0.05	0.1192	\$1,338.32
15	2030	0.1701	7,110	\$1,209	186	\$32	3,935	\$669	11,231	\$1,910		0.05	0.1201	\$1,348.83
16	2031	0.1704	7,110	\$1,211	186	\$32	3,935	\$670	11,231	\$1,913		0.05	0.1204	\$1,351.66
17	2032	0.1705	7,110	\$1,212	186	\$32	3,935	\$671	11,231	\$1,915		0.05	0.1205	\$1,353.28
18	2033	0.1707	7,110	\$1,214	186	\$32	3,935	\$672	11,231	\$1,918		0.05	0.1207	\$1,356.11
19	2034	0.1710	7,110	\$1,216	186	\$32	3,935	\$673	11,231	\$1,921		0.05	0.1210	\$1,359.34
20	2035	0.1713	7,110	\$1,218	186	\$32	3,935	\$674	11,231	\$1,924		0.05	0.1213	\$1,362.17
21	2036	0.1714	7,110	\$1,219	186	\$32	3,935	\$675	11,231	\$1,925		0.05	0.1214	\$1,363.79
22	2037	0.1717	7,110	\$1,221	186	\$32	3,935	\$676	11,231	\$1,928		0.05	0.1217	\$1,366.62
23	2038	0.1720	7,110	\$1,223	186	\$32	3,935	\$677	11,231	\$1,931		0.05	0.1220	\$1,369.85
24	2039	0.1722	7,110	\$1,225	186	\$32	3,935	\$678	11,231	\$1,934		0.05	0.1222	\$1,372.68
25	2040	0.1724	7,110	\$1,226	186	\$32	3,935	\$678	11,231	\$1,936		0.05	0.1224	\$1,374.30
26	2041	0.1734	7,110	\$1,233	186	\$32	3,935	\$682	11,231	\$1,947		0.05	0.1234	\$1,385.50
27	2042	0.1744	7,110	\$1,240	186	\$32	3,935	\$686	11,231	\$1,958		0.05	0.1244	\$1,396.76
28	2043	0.1754	7,110	\$1,247	186	\$33	3,935	\$690	11,231	\$1,970		0.05	0.1254	\$1,408.09
29	2044	0.1764	7,110	\$1,254	186	\$33	3,935	\$694	11,231	\$1,981		0.05	0.1264	\$1,419.48
30	2045	0.1774	7,110	\$1,261	186	\$33	3,935	\$698	11,231	\$1,992		0.05	0.1274	\$1,430.94
31	2046	0.1784	7,110	\$1,269	186	\$33	3,935	\$702	11,231	\$2,004		0.05	0.1284	\$1,442.47
32	2047	0.1795	7,110	\$1,276	186	\$33	3,935	\$706	11,231	\$2,016		0.05	0.1295	\$1,454.06
33	2048	0.1805	7,110	\$1,283	186	\$34	3,935	\$710	11,231	\$2,027		0.05	0.1305	\$1,465.72
34	2049	0.1816	7,110	\$1,291	186	\$34	3,935	\$714	11,231	\$2,039		0.05	0.1316	\$1,477.45
35	2050	0.1826	7,110	\$1,298	186	\$34	3,935	\$719	11,231	\$2,051		0.05	0.1326	\$1,489.25
36	2051	0.1837	7,110	\$1,306	186	\$34	3,935	\$723	11,231	\$2,063		0.05	0.1337	\$1,501.11
37	2052	0.1847	7,110	\$1,313	186	\$34	3,935	\$727	11,231	\$2,075		0.05	0.1347	\$1,513.04
38	2053	0.1858	7,110	\$1,321	186	\$35	3,935	\$731	11,231	\$2,087		0.05	0.1358	\$1,525.04
39	2054	0.1869	7,110	\$1,329	186	\$35	3,935	\$735	11,231	\$2,099		0.05	0.1369	\$1,537.11
40	2055	0.1879	7,110	\$1,336	186	\$35	3,935	\$740	11,231	\$2,111		0.05	0.1379	\$1,549.25
41	2056	0.1890	7,110	\$1,344	186	\$35	3,935	\$744	11,231	\$2,123		0.05	0.1390	\$1,561.47
42	2057	0.1901	7,110	\$1,352	186	\$35	3,935	\$748	11,231	\$2,135		0.05	0.1401	\$1,573.75
43	2058	0.1912	7,110	\$1,360	186	\$36	3,935	\$752	11,231	\$2,148		0.05	0.1412	\$1,586.10
44	2059	0.1923	7,110	\$1,367	186	\$36	3,935	\$757	11,231	\$2,160		0.05	0.1423	\$1,598.52
45	2060	0.1934	7,110	\$1,375	186	\$36	3,935	\$761	11,231	\$2,173		0.05	0.1434	\$1,611.02
46	2061	0.1946	7,110	\$1,383	186	\$36	3,935	\$766	11,231	\$2,185		0.05	0.1446	\$1,623.59
47	2062	0.1957	7,110	\$1,391	186	\$36	3,935	\$770	11,231	\$2,198		0.05	0.1457	\$1,636.23
48	2063	0.1968	7,110	\$1,399	186	\$37	3,935	\$774	11,231	\$2,210		0.05	0.1468	\$1,648.94
49	2064	0.1980	7,110	\$1,407	186	\$37	3,935	\$779	11,231	\$2,223		0.05	0.1480	\$1,661.73
50	2065	0.1991	7,110	\$1,416	186	\$37	3,935	\$783	11,231	\$2,236		0.05	0.1491	\$1,674.59
51	2066	0.2003	7,110	\$1,424	186	\$37	3,935	\$788	11,231	\$2,249		0.05	0.1503	\$1,687.53
52	2067	0.2014	7,110	\$1,432	186	\$37	3,935	\$793	11,231	\$2,262		0.05	0.1514	\$1,700.54
53	2068	0.2026	7,110	\$1,440	186	\$38	3,935	\$797	11,231	\$2,275		0.05	0.1526	\$1,713.62
54	2069	0.2038	7,110	\$1,449	186	\$38	3,935	\$802	11,231	\$2,288		0.05	0.1538	\$1,726.78
55	2070	0.2049	7,110	\$1,457	186	\$38	3,935	\$806	11,231	\$2,302		0.05	0.1549	\$1,740.02
56	2071	0.2061	7,110	\$1,465	186	\$38	3,935	\$811	11,231	\$2,315		0.05	0.1561	\$1,753.34
57	2072	0.2073	7,110	\$1,474	186	\$39	3,935	\$816	11,231	\$2,328		0.05	0.1573	\$1,766.73
58	2073	0.2085	7,110	\$1,482	186	\$39	3,935	\$820	11,231	\$2,342		0.05	0.1585	\$1,780.20
59	2074	0.2097	7,110	\$1,491	186	\$39	3,935	\$825	11,231	\$2,355		0.05	0.1597	\$1,793.74
60	2075	0.2109	7,110	\$1,500	186	\$39	3,935	\$830	11,231	\$2,369		0.05	0.1609	\$1,807.37

Table D1-1.73: Annual Operating Costs (V.GSHP) of a 2,000 square feet detached house above grade (average construction type) in the city of Sudbury (two life cycles and three life cycles for a 60 year project lifespan); base case scenario in comparison with feed-in-tariff (FIT) scenario. In the FIT scenario, an incentive of \$0.05/KWh is provided on electricity bills throughout the project lifespan

Horizontal Ground Source Heat Pump (H.GSHP)

Base Case Scenario											Feed in Tariff (FIT)		
H.GSHP											FIT		
#	Year	Electricity Rates \$/KWh	Heating KWh	Heating Operating Cost \$	Cooling KWh	Cooling Operating Cost \$	Hot Water KWh	Hot Water Operating Cost \$	Total KWh	Total Operating Cost \$	Incentives (\$/KWh)	S/KWh	Operating Cost
1	2016	0.1501	7,259	\$1,089	193	\$29	3,932	\$590	11,384	\$1,709	0.05	0.1001	\$1,139.34
2	2017	0.1542	7,259	\$1,119	193	\$30	3,932	\$606	11,384	\$1,755	0.05	0.1042	\$1,186.06
3	2018	0.1583	7,259	\$1,149	193	\$31	3,932	\$622	11,384	\$1,802	0.05	0.1083	\$1,232.78
4	2019	0.1625	7,259	\$1,180	193	\$31	3,932	\$639	11,384	\$1,850	0.05	0.1125	\$1,281.14
5	2020	0.1668	7,259	\$1,211	193	\$32	3,932	\$656	11,384	\$1,899	0.05	0.1168	\$1,329.50
6	2021	0.1621	7,259	\$1,177	193	\$31	3,932	\$638	11,384	\$1,846	0.05	0.1121	\$1,276.63
7	2022	0.1629	7,259	\$1,183	193	\$31	3,932	\$641	11,384	\$1,855	0.05	0.1129	\$1,285.65
8	2023	0.1639	7,259	\$1,190	193	\$32	3,932	\$644	11,384	\$1,866	0.05	0.1139	\$1,296.30
9	2024	0.1648	7,259	\$1,196	193	\$32	3,932	\$648	11,384	\$1,876	0.05	0.1148	\$1,306.96
10	2025	0.1656	7,259	\$1,202	193	\$32	3,932	\$651	11,384	\$1,885	0.05	0.1156	\$1,315.98
11	2026	0.1665	7,259	\$1,209	193	\$32	3,932	\$655	11,384	\$1,896	0.05	0.1165	\$1,326.63
12	2027	0.1674	7,259	\$1,215	193	\$32	3,932	\$658	11,384	\$1,906	0.05	0.1174	\$1,336.88
13	2028	0.1683	7,259	\$1,221	193	\$32	3,932	\$662	11,384	\$1,916	0.05	0.1183	\$1,346.30
14	2029	0.1692	7,259	\$1,228	193	\$33	3,932	\$665	11,384	\$1,926	0.05	0.1192	\$1,356.55
15	2030	0.1701	7,259	\$1,235	193	\$33	3,932	\$669	11,384	\$1,936	0.05	0.1201	\$1,367.20
16	2031	0.1704	7,259	\$1,237	193	\$33	3,932	\$670	11,384	\$1,939	0.05	0.1204	\$1,370.07
17	2032	0.1705	7,259	\$1,238	193	\$33	3,932	\$670	11,384	\$1,941	0.05	0.1205	\$1,371.71
18	2033	0.1707	7,259	\$1,239	193	\$33	3,932	\$671	11,384	\$1,944	0.05	0.1207	\$1,374.58
19	2034	0.1710	7,259	\$1,242	193	\$33	3,932	\$673	11,384	\$1,947	0.05	0.1210	\$1,377.86
20	2035	0.1713	7,259	\$1,243	193	\$33	3,932	\$673	11,384	\$1,950	0.05	0.1213	\$1,380.73
21	2036	0.1714	7,259	\$1,244	193	\$33	3,932	\$674	11,384	\$1,952	0.05	0.1214	\$1,382.37
22	2037	0.1717	7,259	\$1,246	193	\$33	3,932	\$675	11,384	\$1,954	0.05	0.1217	\$1,385.24
23	2038	0.1720	7,259	\$1,248	193	\$33	3,932	\$676	11,384	\$1,958	0.05	0.1220	\$1,388.51
24	2039	0.1722	7,259	\$1,250	193	\$33	3,932	\$677	11,384	\$1,961	0.05	0.1222	\$1,391.38
25	2040	0.1724	7,259	\$1,251	193	\$33	3,932	\$678	11,384	\$1,962	0.05	0.1224	\$1,393.02
26	2041	0.1734	7,259	\$1,258	193	\$33	3,932	\$682	11,384	\$1,974	0.05	0.1234	\$1,404.37
27	2042	0.1744	7,259	\$1,266	193	\$34	3,932	\$686	11,384	\$1,985	0.05	0.1244	\$1,415.79
28	2043	0.1754	7,259	\$1,273	193	\$34	3,932	\$690	11,384	\$1,996	0.05	0.1254	\$1,427.27
29	2044	0.1764	7,259	\$1,280	193	\$34	3,932	\$694	11,384	\$2,008	0.05	0.1264	\$1,438.82
30	2045	0.1774	7,259	\$1,288	193	\$34	3,932	\$698	11,384	\$2,020	0.05	0.1274	\$1,450.44
31	2046	0.1784	7,259	\$1,295	193	\$34	3,932	\$702	11,384	\$2,031	0.05	0.1284	\$1,462.12
32	2047	0.1795	7,259	\$1,303	193	\$35	3,932	\$706	11,384	\$2,043	0.05	0.1295	\$1,473.87
33	2048	0.1805	7,259	\$1,310	193	\$35	3,932	\$710	11,384	\$2,055	0.05	0.1305	\$1,485.69
34	2049	0.1816	7,259	\$1,318	193	\$35	3,932	\$714	11,384	\$2,067	0.05	0.1316	\$1,497.58
35	2050	0.1826	7,259	\$1,326	193	\$35	3,932	\$718	11,384	\$2,079	0.05	0.1326	\$1,509.53
36	2051	0.1837	7,259	\$1,333	193	\$35	3,932	\$722	11,384	\$2,091	0.05	0.1337	\$1,521.56
37	2052	0.1847	7,259	\$1,341	193	\$36	3,932	\$726	11,384	\$2,103	0.05	0.1347	\$1,533.65
38	2053	0.1858	7,259	\$1,349	193	\$36	3,932	\$731	11,384	\$2,115	0.05	0.1358	\$1,545.82
39	2054	0.1869	7,259	\$1,356	193	\$36	3,932	\$735	11,384	\$2,127	0.05	0.1369	\$1,558.05
40	2055	0.1879	7,259	\$1,364	193	\$36	3,932	\$739	11,384	\$2,140	0.05	0.1379	\$1,570.36
41	2056	0.1890	7,259	\$1,372	193	\$36	3,932	\$743	11,384	\$2,152	0.05	0.1390	\$1,582.74
42	2057	0.1901	7,259	\$1,380	193	\$37	3,932	\$748	11,384	\$2,164	0.05	0.1401	\$1,595.19
43	2058	0.1912	7,259	\$1,388	193	\$37	3,932	\$752	11,384	\$2,177	0.05	0.1412	\$1,607.71
44	2059	0.1923	7,259	\$1,396	193	\$37	3,932	\$756	11,384	\$2,189	0.05	0.1423	\$1,620.30
45	2060	0.1934	7,259	\$1,404	193	\$37	3,932	\$761	11,384	\$2,202	0.05	0.1434	\$1,632.97
46	2061	0.1946	7,259	\$1,412	193	\$38	3,932	\$765	11,384	\$2,215	0.05	0.1446	\$1,645.70
47	2062	0.1957	7,259	\$1,421	193	\$38	3,932	\$769	11,384	\$2,228	0.05	0.1457	\$1,658.52
48	2063	0.1968	7,259	\$1,429	193	\$38	3,932	\$774	11,384	\$2,241	0.05	0.1468	\$1,671.40
49	2064	0.1980	7,259	\$1,437	193	\$38	3,932	\$778	11,384	\$2,254	0.05	0.1480	\$1,684.37
50	2065	0.1991	7,259	\$1,445	193	\$38	3,932	\$783	11,384	\$2,267	0.05	0.1491	\$1,697.40
51	2066	0.2003	7,259	\$1,454	193	\$39	3,932	\$787	11,384	\$2,280	0.05	0.1503	\$1,710.51
52	2067	0.2014	7,259	\$1,462	193	\$39	3,932	\$792	11,384	\$2,293	0.05	0.1514	\$1,723.70
53	2068	0.2026	7,259	\$1,471	193	\$39	3,932	\$797	11,384	\$2,306	0.05	0.1526	\$1,736.97
54	2069	0.2038	7,259	\$1,479	193	\$39	3,932	\$801	11,384	\$2,320	0.05	0.1538	\$1,750.31
55	2070	0.2049	7,259	\$1,488	193	\$40	3,932	\$806	11,384	\$2,333	0.05	0.1549	\$1,763.73
56	2071	0.2061	7,259	\$1,496	193	\$40	3,932	\$810	11,384	\$2,346	0.05	0.1561	\$1,777.22
57	2072	0.2073	7,259	\$1,505	193	\$40	3,932	\$815	11,384	\$2,360	0.05	0.1573	\$1,790.79
58	2073	0.2085	7,259	\$1,514	193	\$40	3,932	\$820	11,384	\$2,374	0.05	0.1585	\$1,804.45
59	2074	0.2097	7,259	\$1,522	193	\$40	3,932	\$825	11,384	\$2,387	0.05	0.1597	\$1,818.18
60	2075	0.2109	7,259	\$1,531	193	\$41	3,932	\$829	11,384	\$2,401	0.05	0.1609	\$1,831.99

Table D1-1.74: Annual Operating Costs (H.GSHP) of a 2,000 square feet detached house above grade (average construction type) in the city of Sudbury (two life cycles and three life cycles for a 60 year project lifespan); base case scenario in comparison with feed in-tariff (FIT) scenario. In the FIT scenario, an incentive of \$0.05/KWh is provided on electricity bills throughout the project lifespan

Traditional HVAC Applications

Base Case Scenario															Carbon Taxes							
#	Year	Electricity Rates	Natural Gas Rates	Heating		Heating Operating Cost	Heating Operating Cost	Total Heating Operating Cost	Cooling	Cooling Operating Cost	Hot Water	Hot Water Operating Cost	Total	Total	Total Electricity Operating Cost	Total Natural Gas Operating Cost	Total	Conversion of m ³ into Tons	Total Tons	Carbon Tax	Operating Costs	
				KWh (Electricity)	m ³ (Gas)																	\$ (Electricity)
1	2016	0.1501	0.3458	2.107	3.302	\$316	\$1,142	\$1,458	872	\$131	1,059	\$366	2,979	4,361	447	\$1,508	\$1,955	7.89	7.89	\$10	\$78.93	\$2,034.20
2	2017	0.1542	0.3588	2.107	3.302	\$325	\$1,185	\$1,510	872	\$134	1,059	\$163	2,979	4,361	459	\$1,565	\$2,024	7.89	7.89	\$20	\$157.87	\$2,182.08
3	2018	0.1583	0.3718	2.107	3.302	\$334	\$1,228	\$1,561	872	\$138	1,059	\$168	2,979	4,361	472	\$1,622	\$2,093	7.89	7.89	\$30	\$236.80	\$2,329.96
4	2019	0.1625	0.3776	2.107	3.302	\$342	\$1,247	\$1,589	872	\$142	1,059	\$172	2,979	4,361	484	\$1,647	\$2,131	7.89	7.89	\$40	\$315.74	\$2,446.58
5	2020	0.1668	0.3841	2.107	3.302	\$351	\$1,268	\$1,620	872	\$145	1,059	\$177	2,979	4,361	497	\$1,675	\$2,172	7.89	7.89	\$50	\$394.67	\$2,566.53
6	2021	0.1621	0.3883	2.107	3.302	\$342	\$1,282	\$1,624	872	\$141	1,059	\$172	2,979	4,361	483	\$1,693	\$2,176	7.89	7.89	\$60	\$473.60	\$2,649.98
7	2022	0.1629	0.3929	2.107	3.302	\$343	\$1,297	\$1,641	872	\$142	1,059	\$173	2,979	4,361	485	\$1,713	\$2,199	7.89	7.89	\$70	\$552.54	\$2,751.29
8	2023	0.1639	0.3967	2.107	3.302	\$345	\$1,310	\$1,655	872	\$143	1,059	\$174	2,979	4,361	488	\$1,730	\$2,218	7.89	7.89	\$80	\$631.47	\$2,849.70
9	2024	0.1648	0.4005	2.107	3.302	\$347	\$1,323	\$1,670	872	\$144	1,059	\$175	2,979	4,361	491	\$1,747	\$2,238	7.89	7.89	\$90	\$710.41	\$2,948.10
10	2025	0.1656	0.4040	2.107	3.302	\$349	\$1,334	\$1,683	872	\$144	1,059	\$175	2,979	4,361	493	\$1,762	\$2,255	7.89	7.89	\$100	\$789.34	\$3,044.41
11	2026	0.1665	0.4070	2.107	3.302	\$351	\$1,344	\$1,695	872	\$145	1,059	\$176	2,979	4,361	496	\$1,775	\$2,271	7.89	7.89	\$110	\$868.28	\$3,139.48
12	2027	0.1674	0.4097	2.107	3.302	\$353	\$1,353	\$1,706	872	\$146	1,059	\$177	2,979	4,361	499	\$1,787	\$2,286	7.89	7.89	\$120	\$947.21	\$3,232.77
13	2028	0.1683	0.4124	2.107	3.302	\$355	\$1,362	\$1,716	872	\$147	1,059	\$178	2,979	4,361	501	\$1,798	\$2,300	7.89	7.89	\$130	\$1,026.14	\$3,325.85
14	2029	0.1692	0.4151	2.107	3.302	\$356	\$1,371	\$1,727	872	\$148	1,059	\$179	2,979	4,361	504	\$1,810	\$2,314	7.89	7.89	\$140	\$1,105.08	\$3,419.14
15	2030	0.1701	0.4170	2.107	3.302	\$358	\$1,377	\$1,735	872	\$148	1,059	\$180	2,979	4,361	507	\$1,818	\$2,325	7.89	7.89	\$150	\$1,184.01	\$3,509.21
16	2031	0.1704	0.4189	2.107	3.302	\$359	\$1,383	\$1,742	872	\$149	1,059	\$180	2,979	4,361	507	\$1,827	\$2,334	7.89	7.89	\$160	\$1,262.95	\$3,597.24
17	2032	0.1705	0.4204	2.107	3.302	\$359	\$1,388	\$1,747	872	\$149	1,059	\$181	2,979	4,361	508	\$1,833	\$2,341	7.89	7.89	\$170	\$1,341.88	\$3,683.27
18	2033	0.1707	0.4223	2.107	3.302	\$360	\$1,395	\$1,754	872	\$149	1,059	\$181	2,979	4,361	509	\$1,842	\$2,350	7.89	7.89	\$180	\$1,420.81	\$3,771.30
19	2034	0.1710	0.4246	2.107	3.302	\$360	\$1,402	\$1,763	872	\$149	1,059	\$181	2,979	4,361	510	\$1,852	\$2,361	7.89	7.89	\$190	\$1,499.75	\$3,861.10
20	2035	0.1713	0.4265	2.107	3.302	\$361	\$1,408	\$1,769	872	\$149	1,059	\$181	2,979	4,361	510	\$1,860	\$2,370	7.89	7.89	\$200	\$1,578.68	\$3,949.13
21	2036	0.1714	0.4288	2.107	3.302	\$361	\$1,416	\$1,777	872	\$149	1,059	\$182	2,979	4,361	511	\$1,870	\$2,381	7.89	7.89	\$210	\$1,657.62	\$4,038.50
22	2037	0.1717	0.4311	2.107	3.302	\$362	\$1,424	\$1,785	872	\$150	1,059	\$182	2,979	4,361	512	\$1,880	\$2,392	7.89	7.89	\$220	\$1,736.55	\$4,128.19
23	2038	0.1720	0.4331	2.107	3.302	\$362	\$1,430	\$1,792	872	\$150	1,059	\$182	2,979	4,361	512	\$1,889	\$2,401	7.89	7.89	\$230	\$1,815.48	\$4,216.33
24	2039	0.1722	0.4353	2.107	3.302	\$363	\$1,438	\$1,800	872	\$150	1,059	\$182	2,979	4,361	513	\$1,899	\$2,412	7.89	7.89	\$240	\$1,894.42	\$4,306.02
25	2040	0.1724	0.4376	2.107	3.302	\$363	\$1,445	\$1,808	872	\$150	1,059	\$183	2,979	4,361	513	\$1,909	\$2,422	7.89	7.89	\$250	\$1,973.35	\$4,395.40
26	2041	0.1734	0.4420	2.107	3.302	\$365	\$1,459	\$1,825	872	\$151	1,059	\$184	2,979	4,361	516	\$1,927	\$2,444	7.89	7.89	\$260	\$2,052.29	\$4,496.12
27	2042	0.1744	0.4463	2.107	3.302	\$367	\$1,474	\$1,841	872	\$152	1,059	\$185	2,979	4,361	519	\$1,946	\$2,466	7.89	7.89	\$270	\$2,131.22	\$4,597.04
28	2043	0.1754	0.4507	2.107	3.302	\$370	\$1,488	\$1,858	872	\$153	1,059	\$186	2,979	4,361	522	\$1,966	\$2,488	7.89	7.89	\$280	\$2,210.15	\$4,698.17
29	2044	0.1764	0.4552	2.107	3.302	\$372	\$1,503	\$1,875	872	\$154	1,059	\$187	2,979	4,361	525	\$1,985	\$2,510	7.89	7.89	\$290	\$2,289.09	\$4,799.50
30	2045	0.1774	0.4596	2.107	3.302	\$374	\$1,518	\$1,892	872	\$155	1,059	\$188	2,979	4,361	529	\$2,005	\$2,533	7.89	7.89	\$300	\$2,368.02	\$4,901.05
31	2046	0.1784	0.4642	2.107	3.302	\$376	\$1,533	\$1,909	872	\$156	1,059	\$189	2,979	4,361	532	\$2,024	\$2,556	7.89	7.89	\$310	\$2,446.96	\$5,002.80
32	2047	0.1795	0.4688	2.107	3.302	\$378	\$1,548	\$1,926	872	\$156	1,059	\$190	2,979	4,361	535	\$2,044	\$2,579	7.89	7.89	\$320	\$2,525.89	\$5,104.77
33	2048	0.1805	0.4734	2.107	3.302	\$380	\$1,563	\$1,943	872	\$157	1,059	\$191	2,979	4,361	538	\$2,064	\$2,602	7.89	7.89	\$330	\$2,604.83	\$5,206.95
34	2049	0.1816	0.4780	2.107	3.302	\$383	\$1,578	\$1,961	872	\$158	1,059	\$192	2,979	4,361	541	\$2,085	\$2,626	7.89	7.89	\$340	\$2,683.76	\$5,309.35
35	2050	0.1826	0.4828	2.107	3.302	\$385	\$1,594	\$1,979	872	\$159	1,059	\$193	2,979	4,361	544	\$2,105	\$2,649	7.89	7.89	\$350	\$2,762.69	\$5,411.96
36	2051	0.1837	0.4875	2.107	3.302	\$387	\$1,610	\$1,997	872	\$160	1,059	\$194	2,979	4,361	547	\$2,126	\$2,673	7.89	7.89	\$360	\$2,841.63	\$5,514.80
37	2052	0.1847	0.4923	2.107	3.302	\$389	\$1,626	\$2,015	872	\$161	1,059	\$196	2,979	4,361	550	\$2,147	\$2,697	7.89	7.89	\$370	\$2,920.56	\$5,617.86
38	2053	0.1858	0.4972	2.107	3.302	\$391	\$1,642	\$2,033	872	\$162	1,059	\$197	2,979	4,361	553	\$2,168	\$2,722	7.89	7.89	\$380	\$2,999.50	\$5,721.14
39	2054	0.1869	0.5021	2.107	3.302	\$394	\$1,658	\$2,052	872	\$163	1,059	\$198	2,979	4,361	557	\$2,190	\$2,746	7.89	7.89	\$390	\$3,078.43	\$5,824.66
40	2055	0.1879	0.5070	2.107	3.302	\$396	\$1,674	\$2,070	872	\$164	1,059	\$199	2,979	4,361	560	\$2,211	\$2,771	7.89	7.89	\$400	\$3,157.36	\$5,928.40
41	2056	0.1890	0.5120	2.107	3.302	\$398	\$1,691	\$2,089	872	\$165	1,059	\$200	2,979	4,361	563	\$2,233	\$2,796	7.89	7.89	\$410	\$3,236.30	\$6,032.37
42	2057	0.1901	0.5171	2.107	3.302	\$401	\$1,707	\$2,108	872	\$166	1,059	\$201	2,979	4,361	566	\$2,255	\$2,821	7.89	7.89	\$420	\$3,315.23	\$6,136.58
43	2058	0.1912	0.5222	2.107	3.302	\$403	\$1,724	\$2,127	872	\$167	1,059	\$203	2,979	4,361	570	\$2,277	\$2,847	7.89	7.89	\$430	\$3,394.17	\$6,241.02
44	2059	0.1923	0.5273	2.107	3.302	\$405	\$1,741	\$2,146	872	\$168	1,059	\$204	2,979	4,361	573	\$2,300	\$2,873	7.89	7.89	\$440	\$3,473.10	\$6,345.70
45	2060	0.1934	0.5325	2.107	3.302	\$408	\$1,758	\$2,166	872	\$169	1,059	\$205	2,979	4,361	576	\$2,322	\$2,899	7.89	7.89	\$450	\$3,552.03	\$6,450.62
46	2061	0.1946	0.5378	2.107	3.302	\$410	\$1,776	\$2,186	872	\$170	1,059	\$206	2,979	4,361	580	\$2,345	\$2,925	7.89	7.89	\$460	\$3,630.97	\$6,555.78
47	2062	0.1957	0.5431	2.107	3.302	\$412	\$1,793	\$2,206	872	\$171	1,059	\$207	2,979	4,361	583	\$2,368	\$2,951	7.89	7.89	\$470	\$3,709.90	\$6,661.19
48	2063	0.1968	0.5484	2.107	3.302	\$415	\$1,811	\$2,226	872	\$172	1,059	\$208	2,979	4,361	586	\$2,392	\$2,978	7.89	7.89	\$480	\$3,788.84	\$6,766.85
49	2064	0.1980	0.5538	2.107	3.302	\$417	\$1,829	\$2,246	872	\$173	1,059	\$210	2,979	4,361	590	\$2,415	\$3,005	7.89	7.89	\$490	\$3,867.77	\$6,872.75
50	2065	0.1991	0.5593	2.107	3.302	\$420	\$1,847	\$2,266	872	\$174	1,059	\$211	2,979	4,361	593	\$2,439	\$3,032	7.89	7.89	\$500	\$3,946.71	\$6,978.91
51	2066	0.2003	0.5648	2.107	3.302	\$422	\$1,865	\$2,287	872	\$175	1,059	\$212	2,979	4,361	597	\$2,463	\$3,060	7.89	7.89	\$510	\$4,025.64	\$7,085.32
52	2067	0.2014	0.5704	2.107	3.302	\$424	\$1,883	\$2,308	872	\$176	1,059	\$213	2,979	4,361	600	\$2,487	\$3,087	7.89	7.89	\$520	\$4,104.57	\$7,191.99
53	2068	0.2026	0.5760	2.107	3.302	\$427	\$1,902	\$2,329	872	\$177	1,059	\$215	2,979	4,361	603	\$2,512	\$3,115	7.89	7.89	\$530	\$4,183.51	\$7,298.9

26. Thunder Bay (North) – Annual Operating Costs

Vertical Ground Source Heat Pump (V.GSHP)

Base Case Scenario											Feed in Tariff (FIT)		
#	Year	V.GSHP									FIT		
		Electricity Rates \$/KWh	Heating KWh	Heating Operating Cost \$	Cooling KWh	Cooling Operating Cost \$	Hot Water KWh	Hot Water Operating Cost \$	Total KWh	Total Operating Cost \$	Incentives (S/KWh)	S/KWh	Operating Cost
1	2016	0.1501	7,907	\$1,187	135	\$20	4,118	\$618	12,160	\$1,825	0.05	0.1001	\$1,217.01
2	2017	0.1542	7,907	\$1,219	135	\$21	4,118	\$635	12,160	\$1,875	0.05	0.1042	\$1,266.91
3	2018	0.1583	7,907	\$1,252	135	\$21	4,118	\$652	12,160	\$1,925	0.05	0.1083	\$1,316.82
4	2019	0.1625	7,907	\$1,285	135	\$22	4,118	\$669	12,160	\$1,976	0.05	0.1125	\$1,368.47
5	2020	0.1668	7,907	\$1,319	135	\$23	4,118	\$687	12,160	\$2,028	0.05	0.1168	\$1,420.13
6	2021	0.1621	7,907	\$1,282	135	\$22	4,118	\$668	12,160	\$1,972	0.05	0.1121	\$1,363.66
7	2022	0.1629	7,907	\$1,288	135	\$22	4,118	\$671	12,160	\$1,981	0.05	0.1129	\$1,373.29
8	2023	0.1639	7,907	\$1,296	135	\$22	4,118	\$675	12,160	\$1,993	0.05	0.1139	\$1,384.67
9	2024	0.1648	7,907	\$1,303	135	\$22	4,118	\$679	12,160	\$2,004	0.05	0.1148	\$1,396.05
10	2025	0.1656	7,907	\$1,309	135	\$22	4,118	\$682	12,160	\$2,014	0.05	0.1156	\$1,405.68
11	2026	0.1665	7,907	\$1,317	135	\$22	4,118	\$686	12,160	\$2,025	0.05	0.1165	\$1,417.06
12	2027	0.1674	7,907	\$1,324	135	\$23	4,118	\$689	12,160	\$2,036	0.05	0.1174	\$1,428.01
13	2028	0.1683	7,907	\$1,330	135	\$23	4,118	\$693	12,160	\$2,046	0.05	0.1183	\$1,438.07
14	2029	0.1692	7,907	\$1,338	135	\$23	4,118	\$697	12,160	\$2,057	0.05	0.1192	\$1,449.02
15	2030	0.1701	7,907	\$1,345	135	\$23	4,118	\$700	12,160	\$2,068	0.05	0.1201	\$1,460.40
16	2031	0.1704	7,907	\$1,347	135	\$23	4,118	\$702	12,160	\$2,071	0.05	0.1204	\$1,463.46
17	2032	0.1705	7,907	\$1,348	135	\$23	4,118	\$702	12,160	\$2,073	0.05	0.1205	\$1,465.21
18	2033	0.1707	7,907	\$1,350	135	\$23	4,118	\$703	12,160	\$2,076	0.05	0.1207	\$1,468.28
19	2034	0.1710	7,907	\$1,352	135	\$23	4,118	\$704	12,160	\$2,080	0.05	0.1210	\$1,471.78
20	2035	0.1713	7,907	\$1,354	135	\$23	4,118	\$705	12,160	\$2,083	0.05	0.1213	\$1,475.85
21	2036	0.1714	7,907	\$1,356	135	\$23	4,118	\$706	12,160	\$2,085	0.05	0.1214	\$1,476.60
22	2037	0.1717	7,907	\$1,357	135	\$23	4,118	\$707	12,160	\$2,088	0.05	0.1217	\$1,479.66
23	2038	0.1720	7,907	\$1,360	135	\$23	4,118	\$708	12,160	\$2,091	0.05	0.1220	\$1,483.16
24	2039	0.1722	7,907	\$1,362	135	\$23	4,118	\$709	12,160	\$2,094	0.05	0.1222	\$1,486.23
25	2040	0.1724	7,907	\$1,363	135	\$23	4,118	\$710	12,160	\$2,096	0.05	0.1224	\$1,487.98
26	2041	0.1734	7,907	\$1,371	135	\$23	4,118	\$714	12,160	\$2,108	0.05	0.1234	\$1,500.10
27	2042	0.1744	7,907	\$1,379	135	\$24	4,118	\$718	12,160	\$2,120	0.05	0.1244	\$1,512.30
28	2043	0.1754	7,907	\$1,387	135	\$24	4,118	\$722	12,160	\$2,133	0.05	0.1254	\$1,524.56
29	2044	0.1764	7,907	\$1,395	135	\$24	4,118	\$726	12,160	\$2,145	0.05	0.1264	\$1,536.90
30	2045	0.1774	7,907	\$1,403	135	\$24	4,118	\$731	12,160	\$2,157	0.05	0.1274	\$1,549.31
31	2046	0.1784	7,907	\$1,411	135	\$24	4,118	\$735	12,160	\$2,170	0.05	0.1284	\$1,561.79
32	2047	0.1795	7,907	\$1,419	135	\$24	4,118	\$739	12,160	\$2,182	0.05	0.1295	\$1,574.34
33	2048	0.1805	7,907	\$1,427	135	\$24	4,118	\$743	12,160	\$2,195	0.05	0.1305	\$1,586.96
34	2049	0.1816	7,907	\$1,436	135	\$25	4,118	\$748	12,160	\$2,208	0.05	0.1316	\$1,599.66
35	2050	0.1826	7,907	\$1,444	135	\$25	4,118	\$752	12,160	\$2,220	0.05	0.1326	\$1,612.43
36	2051	0.1837	7,907	\$1,452	135	\$25	4,118	\$756	12,160	\$2,233	0.05	0.1337	\$1,625.28
37	2052	0.1847	7,907	\$1,461	135	\$25	4,118	\$761	12,160	\$2,246	0.05	0.1347	\$1,638.20
38	2053	0.1858	7,907	\$1,469	135	\$25	4,118	\$765	12,160	\$2,259	0.05	0.1358	\$1,651.19
39	2054	0.1869	7,907	\$1,478	135	\$25	4,118	\$770	12,160	\$2,272	0.05	0.1369	\$1,664.26
40	2055	0.1879	7,907	\$1,486	135	\$25	4,118	\$774	12,160	\$2,285	0.05	0.1379	\$1,677.40
41	2056	0.1890	7,907	\$1,495	135	\$26	4,118	\$778	12,160	\$2,299	0.05	0.1390	\$1,690.63
42	2057	0.1901	7,907	\$1,503	135	\$26	4,118	\$783	12,160	\$2,312	0.05	0.1401	\$1,703.92
43	2058	0.1912	7,907	\$1,512	135	\$26	4,118	\$787	12,160	\$2,325	0.05	0.1412	\$1,717.30
44	2059	0.1923	7,907	\$1,521	135	\$26	4,118	\$792	12,160	\$2,339	0.05	0.1423	\$1,730.75
45	2060	0.1934	7,907	\$1,530	135	\$26	4,118	\$797	12,160	\$2,352	0.05	0.1434	\$1,744.28
46	2061	0.1946	7,907	\$1,538	135	\$26	4,118	\$801	12,160	\$2,366	0.05	0.1446	\$1,757.89
47	2062	0.1957	7,907	\$1,547	135	\$26	4,118	\$806	12,160	\$2,380	0.05	0.1457	\$1,771.57
48	2063	0.1968	7,907	\$1,556	135	\$27	4,118	\$811	12,160	\$2,393	0.05	0.1468	\$1,785.34
49	2064	0.1980	7,907	\$1,565	135	\$27	4,118	\$815	12,160	\$2,407	0.05	0.1480	\$1,799.18
50	2065	0.1991	7,907	\$1,574	135	\$27	4,118	\$820	12,160	\$2,421	0.05	0.1491	\$1,813.11
51	2066	0.2003	7,907	\$1,583	135	\$27	4,118	\$825	12,160	\$2,435	0.05	0.1503	\$1,827.11
52	2067	0.2014	7,907	\$1,593	135	\$27	4,118	\$829	12,160	\$2,449	0.05	0.1514	\$1,841.20
53	2068	0.2026	7,907	\$1,602	135	\$27	4,118	\$834	12,160	\$2,463	0.05	0.1526	\$1,855.37
54	2069	0.2038	7,907	\$1,611	135	\$28	4,118	\$839	12,160	\$2,478	0.05	0.1538	\$1,869.62
55	2070	0.2049	7,907	\$1,620	135	\$28	4,118	\$844	12,160	\$2,492	0.05	0.1549	\$1,883.95
56	2071	0.2061	7,907	\$1,630	135	\$28	4,118	\$849	12,160	\$2,506	0.05	0.1561	\$1,898.37
57	2072	0.2073	7,907	\$1,639	135	\$28	4,118	\$854	12,160	\$2,521	0.05	0.1573	\$1,912.87
58	2073	0.2085	7,907	\$1,649	135	\$28	4,118	\$859	12,160	\$2,535	0.05	0.1585	\$1,927.45
59	2074	0.2097	7,907	\$1,658	135	\$28	4,118	\$864	12,160	\$2,550	0.05	0.1597	\$1,942.12
60	2075	0.2109	7,907	\$1,668	135	\$28	4,118	\$869	12,160	\$2,565	0.05	0.1609	\$1,956.87

Table D1-1.76: Annual Operating Costs (V.GSHP) of a 2,000 square feet detached house above grade (average construction type) in the city of Thunder Bay (two life cycles and three life cycles for a 60 year project lifespan); base case scenario in comparison with feed in-tariff (FIT) scenario. In the FIT scenario, an incentive of \$0.05/KWh is provided on electricity bills throughout the project lifespan

Horizontal Ground Source Heat Pump (H.GSHP)

Base Case Scenario											Feed in Tariff (FIT)		
#	Year	H.GSHP									FIT		
		Electricity Rates \$/KWh	Heating KWh	Heating Operating Cost \$	Cooling KWh	Cooling Operating Cost \$	Hot Water KWh	Hot Water Operating Cost \$	Total KWh	Total Operating Cost \$	Incentives (\$/KWh)	S/KWh	Operating Cost
1	2016	0.1501	8,038	\$1,206	139	\$21	4,117	\$618	12,294	\$1,845	0.05	0.1001	\$1,230.42
2	2017	0.1542	8,038	\$1,239	139	\$21	4,117	\$635	12,294	\$1,896	0.05	0.1042	\$1,280.87
3	2018	0.1583	8,038	\$1,272	139	\$22	4,117	\$652	12,294	\$1,946	0.05	0.1083	\$1,331.33
4	2019	0.1625	8,038	\$1,306	139	\$23	4,117	\$669	12,294	\$1,998	0.05	0.1125	\$1,383.55
5	2020	0.1668	8,038	\$1,341	139	\$23	4,117	\$687	12,294	\$2,050	0.05	0.1168	\$1,435.55
6	2021	0.1621	8,038	\$1,303	139	\$23	4,117	\$668	12,294	\$1,993	0.05	0.1121	\$1,378.68
7	2022	0.1629	8,038	\$1,310	139	\$23	4,117	\$671	12,294	\$2,003	0.05	0.1129	\$1,388.42
8	2023	0.1639	8,038	\$1,317	139	\$23	4,117	\$675	12,294	\$2,015	0.05	0.1139	\$1,399.93
9	2024	0.1648	8,038	\$1,325	139	\$23	4,117	\$679	12,294	\$2,026	0.05	0.1148	\$1,411.43
10	2025	0.1656	8,038	\$1,331	139	\$23	4,117	\$682	12,294	\$2,036	0.05	0.1156	\$1,421.17
11	2026	0.1665	8,038	\$1,339	139	\$23	4,117	\$686	12,294	\$2,047	0.05	0.1165	\$1,432.68
12	2027	0.1674	8,038	\$1,346	139	\$23	4,117	\$689	12,294	\$2,058	0.05	0.1174	\$1,443.74
13	2028	0.1683	8,038	\$1,352	139	\$23	4,117	\$693	12,294	\$2,069	0.05	0.1183	\$1,453.92
14	2029	0.1692	8,038	\$1,360	139	\$24	4,117	\$696	12,294	\$2,080	0.05	0.1192	\$1,464.99
15	2030	0.1701	8,038	\$1,367	139	\$24	4,117	\$700	12,294	\$2,091	0.05	0.1201	\$1,476.49
16	2031	0.1704	8,038	\$1,369	139	\$24	4,117	\$701	12,294	\$2,094	0.05	0.1204	\$1,479.59
17	2032	0.1705	8,038	\$1,370	139	\$24	4,117	\$702	12,294	\$2,096	0.05	0.1205	\$1,481.36
18	2033	0.1707	8,038	\$1,372	139	\$24	4,117	\$703	12,294	\$2,099	0.05	0.1207	\$1,484.46
19	2034	0.1710	8,038	\$1,375	139	\$24	4,117	\$704	12,294	\$2,103	0.05	0.1210	\$1,488.00
20	2035	0.1713	8,038	\$1,377	139	\$24	4,117	\$705	12,294	\$2,106	0.05	0.1213	\$1,491.10
21	2036	0.1714	8,038	\$1,378	139	\$24	4,117	\$706	12,294	\$2,108	0.05	0.1214	\$1,492.87
22	2037	0.1717	8,038	\$1,380	139	\$24	4,117	\$707	12,294	\$2,111	0.05	0.1217	\$1,495.97
23	2038	0.1720	8,038	\$1,382	139	\$24	4,117	\$708	12,294	\$2,114	0.05	0.1220	\$1,499.51
24	2039	0.1722	8,038	\$1,384	139	\$24	4,117	\$709	12,294	\$2,117	0.05	0.1222	\$1,502.60
25	2040	0.1724	8,038	\$1,385	139	\$24	4,117	\$710	12,294	\$2,119	0.05	0.1224	\$1,504.38
26	2041	0.1734	8,038	\$1,393	139	\$24	4,117	\$714	12,294	\$2,131	0.05	0.1234	\$1,516.63
27	2042	0.1744	8,038	\$1,402	139	\$24	4,117	\$718	12,294	\$2,144	0.05	0.1244	\$1,528.96
28	2043	0.1754	8,038	\$1,410	139	\$24	4,117	\$722	12,294	\$2,156	0.05	0.1254	\$1,541.36
29	2044	0.1764	8,038	\$1,418	139	\$25	4,117	\$726	12,294	\$2,169	0.05	0.1264	\$1,553.84
30	2045	0.1774	8,038	\$1,426	139	\$25	4,117	\$730	12,294	\$2,181	0.05	0.1274	\$1,566.38
31	2046	0.1784	8,038	\$1,434	139	\$25	4,117	\$735	12,294	\$2,194	0.05	0.1284	\$1,579.00
32	2047	0.1795	8,038	\$1,443	139	\$25	4,117	\$739	12,294	\$2,206	0.05	0.1295	\$1,591.69
33	2048	0.1805	8,038	\$1,451	139	\$25	4,117	\$743	12,294	\$2,219	0.05	0.1305	\$1,604.45
34	2049	0.1816	8,038	\$1,459	139	\$25	4,117	\$747	12,294	\$2,232	0.05	0.1316	\$1,617.29
35	2050	0.1826	8,038	\$1,468	139	\$25	4,117	\$752	12,294	\$2,245	0.05	0.1326	\$1,630.20
36	2051	0.1837	8,038	\$1,476	139	\$26	4,117	\$756	12,294	\$2,258	0.05	0.1337	\$1,643.19
37	2052	0.1847	8,038	\$1,485	139	\$26	4,117	\$760	12,294	\$2,271	0.05	0.1347	\$1,656.25
38	2053	0.1858	8,038	\$1,493	139	\$26	4,117	\$765	12,294	\$2,284	0.05	0.1358	\$1,669.39
39	2054	0.1869	8,038	\$1,502	139	\$26	4,117	\$769	12,294	\$2,297	0.05	0.1369	\$1,682.60
40	2055	0.1879	8,038	\$1,511	139	\$26	4,117	\$774	12,294	\$2,311	0.05	0.1379	\$1,695.89
41	2056	0.1890	8,038	\$1,519	139	\$26	4,117	\$778	12,294	\$2,324	0.05	0.1390	\$1,709.26
42	2057	0.1901	8,038	\$1,528	139	\$26	4,117	\$783	12,294	\$2,337	0.05	0.1401	\$1,722.70
43	2058	0.1912	8,038	\$1,537	139	\$27	4,117	\$787	12,294	\$2,351	0.05	0.1412	\$1,736.22
44	2059	0.1923	8,038	\$1,546	139	\$27	4,117	\$792	12,294	\$2,365	0.05	0.1423	\$1,749.82
45	2060	0.1934	8,038	\$1,555	139	\$27	4,117	\$796	12,294	\$2,378	0.05	0.1434	\$1,763.50
46	2061	0.1946	8,038	\$1,564	139	\$27	4,117	\$801	12,294	\$2,392	0.05	0.1446	\$1,777.26
47	2062	0.1957	8,038	\$1,573	139	\$27	4,117	\$806	12,294	\$2,406	0.05	0.1457	\$1,791.09
48	2063	0.1968	8,038	\$1,582	139	\$27	4,117	\$810	12,294	\$2,420	0.05	0.1468	\$1,805.01
49	2064	0.1980	8,038	\$1,591	139	\$28	4,117	\$815	12,294	\$2,434	0.05	0.1480	\$1,819.01
50	2065	0.1991	8,038	\$1,600	139	\$28	4,117	\$820	12,294	\$2,448	0.05	0.1491	\$1,833.09
51	2066	0.2003	8,038	\$1,610	139	\$28	4,117	\$824	12,294	\$2,462	0.05	0.1503	\$1,847.25
52	2067	0.2014	8,038	\$1,619	139	\$28	4,117	\$829	12,294	\$2,476	0.05	0.1514	\$1,861.49
53	2068	0.2026	8,038	\$1,628	139	\$28	4,117	\$834	12,294	\$2,491	0.05	0.1526	\$1,875.81
54	2069	0.2038	8,038	\$1,638	139	\$28	4,117	\$839	12,294	\$2,505	0.05	0.1538	\$1,890.22
55	2070	0.2049	8,038	\$1,647	139	\$28	4,117	\$844	12,294	\$2,519	0.05	0.1549	\$1,904.71
56	2071	0.2061	8,038	\$1,657	139	\$29	4,117	\$849	12,294	\$2,534	0.05	0.1561	\$1,919.29
57	2072	0.2073	8,038	\$1,666	139	\$29	4,117	\$853	12,294	\$2,549	0.05	0.1573	\$1,933.95
58	2073	0.2085	8,038	\$1,676	139	\$29	4,117	\$858	12,294	\$2,563	0.05	0.1585	\$1,948.69
59	2074	0.2097	8,038	\$1,686	139	\$29	4,117	\$863	12,294	\$2,578	0.05	0.1597	\$1,963.52
60	2075	0.2109	8,038	\$1,695	139	\$29	4,117	\$868	12,294	\$2,593	0.05	0.1609	\$1,978.43

Table D1-1.77: Annual Operating Costs (H.GSHP) of a 2,000 square feet detached house above grade (average construction type) in the city of Thunder Bay (two life cycles and three life cycles for a 60 year project lifespan); base case scenario in comparison with feed in-tariff (FIT) scenario. In the FIT scenario, an incentive of \$0.05/KWh is provided on electricity bills throughout the project lifespan

Traditional HVAC Applications

Base Case Scenario																Carbon Taxes						
#	Year	Electricity Rates \$/KWh	Natural Gas Rates \$/m ³	Heating		Heating Operating Cost \$ (Electricity)	Heating Operating Cost \$ (Gas)	Total Heating Operating Cost \$	Cooling		Hot Water m ³	Hot Water Operating Cost \$	Total KWh	Total m ³	Total Electricity Operating Cost \$ (KWh)	Total Natural Gas Operating Cost \$ (m ³)	Total	Conversion of m ³ into Tons	Total Tons	Carbon Tax	Operating Costs	
				KWh (Electricity)	m ³ (Gas)				KWh	\$												
1	2016	0.1501	0.3458	2,099	3,506	\$315	\$1,212	\$1,528	616	\$92	1,106	\$382	2,715	4,612	407	\$1,595	\$2,002	8.35	8.35	\$10	\$83.48	\$2,085.92
2	2017	0.1542	0.3588	2,099	3,506	\$324	\$1,258	\$1,582	616	\$95	1,106	\$171	2,715	4,612	419	\$1,655	\$2,074	8.35	8.35	\$20	\$166.95	\$2,240.53
3	2018	0.1583	0.3718	2,099	3,506	\$332	\$1,304	\$1,636	616	\$98	1,106	\$175	2,715	4,612	430	\$1,715	\$2,145	8.35	8.35	\$30	\$250.43	\$2,395.14
4	2019	0.1625	0.3776	2,099	3,506	\$341	\$1,324	\$1,665	616	\$100	1,106	\$180	2,715	4,612	441	\$1,741	\$2,183	8.35	8.35	\$40	\$333.91	\$2,516.61
5	2020	0.1668	0.3841	2,099	3,506	\$350	\$1,347	\$1,697	616	\$103	1,106	\$184	2,715	4,612	453	\$1,771	\$2,224	8.35	8.35	\$50	\$417.39	\$2,641.62
6	2021	0.1621	0.3883	2,099	3,506	\$340	\$1,361	\$1,702	616	\$100	1,106	\$179	2,715	4,612	440	\$1,791	\$2,231	8.35	8.35	\$60	\$500.86	\$2,731.89
7	2022	0.1629	0.3929	2,099	3,506	\$342	\$1,377	\$1,719	616	\$100	1,106	\$180	2,715	4,612	442	\$1,812	\$2,254	8.35	8.35	\$70	\$584.34	\$2,838.69
8	2023	0.1639	0.3967	2,099	3,506	\$344	\$1,391	\$1,735	616	\$101	1,106	\$181	2,715	4,612	445	\$1,830	\$2,275	8.35	8.35	\$80	\$667.82	\$2,942.35
9	2024	0.1648	0.4005	2,099	3,506	\$346	\$1,404	\$1,750	616	\$102	1,106	\$182	2,715	4,612	447	\$1,847	\$2,295	8.35	8.35	\$90	\$751.29	\$3,046.02
10	2025	0.1656	0.4040	2,099	3,506	\$348	\$1,416	\$1,764	616	\$102	1,106	\$183	2,715	4,612	450	\$1,863	\$2,313	8.35	8.35	\$100	\$834.77	\$3,147.52
11	2026	0.1665	0.4070	2,099	3,506	\$350	\$1,427	\$1,777	616	\$103	1,106	\$184	2,715	4,612	452	\$1,877	\$2,329	8.35	8.35	\$110	\$918.25	\$3,247.65
12	2027	0.1674	0.4097	2,099	3,506	\$351	\$1,436	\$1,788	616	\$103	1,106	\$185	2,715	4,612	455	\$1,890	\$2,344	8.35	8.35	\$120	\$1,001.73	\$3,345.93
13	2028	0.1683	0.4124	2,099	3,506	\$353	\$1,446	\$1,799	616	\$104	1,106	\$186	2,715	4,612	457	\$1,902	\$2,359	8.35	8.35	\$130	\$1,085.20	\$3,444.00
14	2029	0.1692	0.4151	2,099	3,506	\$355	\$1,455	\$1,810	616	\$104	1,106	\$187	2,715	4,612	459	\$1,914	\$2,374	8.35	8.35	\$140	\$1,168.68	\$3,542.27
15	2030	0.1701	0.4170	2,099	3,506	\$357	\$1,462	\$1,819	616	\$105	1,106	\$188	2,715	4,612	462	\$1,923	\$2,385	8.35	8.35	\$150	\$1,252.16	\$3,637.11
16	2031	0.1704	0.4189	2,099	3,506	\$358	\$1,469	\$1,826	616	\$105	1,106	\$188	2,715	4,612	463	\$1,932	\$2,394	8.35	8.35	\$160	\$1,335.64	\$3,730.10
17	2032	0.1705	0.4204	2,099	3,506	\$358	\$1,474	\$1,832	616	\$105	1,106	\$189	2,715	4,612	463	\$1,939	\$2,402	8.35	8.35	\$170	\$1,419.11	\$3,821.02
18	2033	0.1707	0.4223	2,099	3,506	\$358	\$1,481	\$1,839	616	\$105	1,106	\$189	2,715	4,612	464	\$1,948	\$2,411	8.35	8.35	\$180	\$1,502.59	\$3,914.00
19	2034	0.1710	0.4246	2,099	3,506	\$359	\$1,489	\$1,848	616	\$105	1,106	\$189	2,715	4,612	464	\$1,958	\$2,423	8.35	8.35	\$190	\$1,586.07	\$4,008.85
20	2035	0.1713	0.4265	2,099	3,506	\$360	\$1,495	\$1,855	616	\$106	1,106	\$189	2,715	4,612	465	\$1,967	\$2,432	8.35	8.35	\$200	\$1,669.54	\$4,101.83
21	2036	0.1714	0.4288	2,099	3,506	\$360	\$1,504	\$1,863	616	\$106	1,106	\$190	2,715	4,612	465	\$1,978	\$2,443	8.35	8.35	\$210	\$1,753.02	\$4,196.29
22	2037	0.1717	0.4311	2,099	3,506	\$360	\$1,512	\$1,872	616	\$106	1,106	\$190	2,715	4,612	466	\$1,988	\$2,455	8.35	8.35	\$220	\$1,836.50	\$4,291.03
23	2038	0.1720	0.4331	2,099	3,506	\$361	\$1,518	\$1,879	616	\$106	1,106	\$190	2,715	4,612	467	\$1,997	\$2,464	8.35	8.35	\$230	\$1,919.98	\$4,384.12
24	2039	0.1722	0.4353	2,099	3,506	\$361	\$1,526	\$1,888	616	\$106	1,106	\$190	2,715	4,612	468	\$2,008	\$2,475	8.35	8.35	\$240	\$2,003.45	\$4,478.86
25	2040	0.1724	0.4376	2,099	3,506	\$362	\$1,534	\$1,896	616	\$106	1,106	\$191	2,715	4,612	468	\$2,018	\$2,486	8.35	8.35	\$250	\$2,086.93	\$4,573.32
26	2041	0.1734	0.4420	2,099	3,506	\$364	\$1,550	\$1,913	616	\$107	1,106	\$192	2,715	4,612	471	\$2,038	\$2,509	8.35	8.35	\$260	\$2,170.41	\$4,679.40
27	2042	0.1744	0.4463	2,099	3,506	\$366	\$1,565	\$1,931	616	\$107	1,106	\$193	2,715	4,612	473	\$2,058	\$2,532	8.35	8.35	\$270	\$2,253.88	\$4,785.70
28	2043	0.1754	0.4507	2,099	3,506	\$368	\$1,580	\$1,948	616	\$108	1,106	\$194	2,715	4,612	476	\$2,079	\$2,555	8.35	8.35	\$280	\$2,337.36	\$4,892.21
29	2044	0.1764	0.4552	2,099	3,506	\$370	\$1,596	\$1,966	616	\$109	1,106	\$195	2,715	4,612	479	\$2,099	\$2,578	8.35	8.35	\$290	\$2,420.84	\$4,998.93
30	2045	0.1774	0.4596	2,099	3,506	\$372	\$1,612	\$1,984	616	\$109	1,106	\$196	2,715	4,612	482	\$2,120	\$2,602	8.35	8.35	\$300	\$2,504.32	\$5,105.88
31	2046	0.1784	0.4642	2,099	3,506	\$375	\$1,627	\$2,002	616	\$110	1,106	\$197	2,715	4,612	484	\$2,141	\$2,625	8.35	8.35	\$310	\$2,587.79	\$5,213.04
32	2047	0.1795	0.4688	2,099	3,506	\$377	\$1,643	\$2,020	616	\$111	1,106	\$198	2,715	4,612	487	\$2,162	\$2,649	8.35	8.35	\$320	\$2,671.27	\$5,320.42
33	2048	0.1805	0.4734	2,099	3,506	\$379	\$1,660	\$2,039	616	\$111	1,106	\$200	2,715	4,612	490	\$2,183	\$2,673	8.35	8.35	\$330	\$2,754.75	\$5,428.03
34	2049	0.1816	0.4780	2,099	3,506	\$381	\$1,676	\$2,057	616	\$112	1,106	\$201	2,715	4,612	493	\$2,205	\$2,698	8.35	8.35	\$340	\$2,838.22	\$5,535.87
35	2050	0.1826	0.4828	2,099	3,506	\$383	\$1,693	\$2,076	616	\$112	1,106	\$202	2,715	4,612	496	\$2,226	\$2,722	8.35	8.35	\$350	\$2,921.70	\$5,643.94
36	2051	0.1837	0.4875	2,099	3,506	\$385	\$1,709	\$2,095	616	\$113	1,106	\$203	2,715	4,612	499	\$2,248	\$2,747	8.35	8.35	\$360	\$3,005.18	\$5,752.23
37	2052	0.1847	0.4923	2,099	3,506	\$388	\$1,726	\$2,114	616	\$114	1,106	\$204	2,715	4,612	502	\$2,271	\$2,772	8.35	8.35	\$370	\$3,088.66	\$5,860.76
38	2053	0.1858	0.4972	2,099	3,506	\$390	\$1,743	\$2,133	616	\$114	1,106	\$205	2,715	4,612	504	\$2,293	\$2,797	8.35	8.35	\$380	\$3,172.13	\$5,969.52
39	2054	0.1869	0.5021	2,099	3,506	\$392	\$1,760	\$2,153	616	\$115	1,106	\$207	2,715	4,612	507	\$2,316	\$2,823	8.35	8.35	\$390	\$3,255.61	\$6,078.53
40	2055	0.1879	0.5070	2,099	3,506	\$394	\$1,778	\$2,172	616	\$116	1,106	\$208	2,715	4,612	510	\$2,338	\$2,849	8.35	8.35	\$400	\$3,339.09	\$6,187.77
41	2056	0.1890	0.5120	2,099	3,506	\$397	\$1,795	\$2,192	616	\$116	1,106	\$209	2,715	4,612	513	\$2,361	\$2,875	8.35	8.35	\$410	\$3,422.57	\$6,297.25
42	2057	0.1901	0.5171	2,099	3,506	\$399	\$1,813	\$2,212	616	\$117	1,106	\$210	2,715	4,612	516	\$2,385	\$2,901	8.35	8.35	\$420	\$3,506.04	\$6,406.98
43	2058	0.1912	0.5222	2,099	3,506	\$401	\$1,831	\$2,232	616	\$118	1,106	\$211	2,715	4,612	519	\$2,408	\$2,927	8.35	8.35	\$430	\$3,589.52	\$6,516.95
44	2059	0.1923	0.5273	2,099	3,506	\$404	\$1,849	\$2,252	616	\$118	1,106	\$213	2,715	4,612	522	\$2,432	\$2,954	8.35	8.35	\$440	\$3,673.00	\$6,627.18
45	2060	0.1934	0.5325	2,099	3,506	\$406	\$1,867	\$2,273	616	\$119	1,106	\$214	2,715	4,612	525	\$2,456	\$2,981	8.35	8.35	\$450	\$3,756.47	\$6,737.65
46	2061	0.1946	0.5378	2,099	3,506	\$408	\$1,885	\$2,294	616	\$120	1,106	\$215	2,715	4,612	528	\$2,480	\$3,008	8.35	8.35	\$460	\$3,839.95	\$6,848.38
47	2062	0.1957	0.5431	2,099	3,506	\$411	\$1,904	\$2,315	616	\$121	1,106	\$216	2,715	4,612	531	\$2,505	\$3,036	8.35	8.35	\$470	\$3,923.43	\$6,959.37
48	2063	0.1968	0.5484	2,099	3,506	\$413	\$1,923	\$2,336	616	\$121	1,106	\$218	2,715	4,612	534	\$2,529	\$3,064	8.35	8.35	\$480	\$4,006.91	\$7,070.61
49	2064	0.1980	0.5538	2,099	3,506	\$416	\$1,942	\$2,357	616	\$122	1,106	\$219	2,715	4,612	537	\$2,554	\$3,092	8.35	8.35	\$490	\$4,090.38	\$7,182.11
50	2065	0.1991	0.5593	2,099	3,506	\$418	\$1,961	\$2,379	616	\$123	1,106	\$220	2,715	4,612	541	\$2,579	\$3,120	8.35	8.35	\$500	\$4,173.86	\$7,293.88
51	2066	0.2003	0.5648	2,099	3,506	\$420	\$1,980	\$2,401	616	\$123	1,106	\$221	2,715	4,612	544	\$2,605	\$3,149	8.35	8.35	\$510	\$4,257.34	\$7,405.92
52	2067	0.2014	0.5704	2,099	3,506	\$423	\$2,000	\$2,423	616	\$124	1,106	\$223	2,715	4,612	547	\$2,631	\$3,177	8.35	8.35	\$520	\$4,340.81	\$7,518.22
53	2068	0.2026	0.5760	2,099	3,506	\$425	\$2,019	\$2,445	616	\$125	1,106	\$224	2,715	4,612	550	\$2,657	\$3,207	8.35	8.35	\$530	\$4,424.29	\$7,630.80
54	2069																					

27. Timmins (North) – Annual Operating Costs

Vertical Ground Source Heat Pump (V.GSHP)

Base Case Scenario											Feed in Tariff (FIT)			
#	Year	V.GSHP		V.GSHP		V.GSHP		V.GSHP		Total	Total Operating Cost	Incentives (\$/KWh)	FIT	
		Electricity Rates	Heating	Heating Operating Cost	Cooling	Cooling Operating Cost	Hot Water	Hot Water Operating Cost	S/KWh				Operating Cost	
		\$/KWh	KWh	\$	KWh	\$	KWh	\$	KWh	\$				
1	2016	0.1501	8,255	\$1,239	166	\$25	3,651	\$548	12,072	\$1,812	0.05	0.1001	\$1,208.20	
2	2017	0.1542	8,255	\$1,273	166	\$26	3,651	\$563	12,072	\$1,861	0.05	0.1042	\$1,257.74	
3	2018	0.1583	8,255	\$1,307	166	\$26	3,651	\$578	12,072	\$1,911	0.05	0.1083	\$1,307.29	
4	2019	0.1625	8,255	\$1,342	166	\$27	3,651	\$593	12,072	\$1,962	0.05	0.1125	\$1,358.57	
5	2020	0.1668	8,255	\$1,377	166	\$28	3,651	\$609	12,072	\$2,013	0.05	0.1168	\$1,409.85	
6	2021	0.1621	8,255	\$1,338	166	\$27	3,651	\$592	12,072	\$1,957	0.05	0.1121	\$1,353.79	
7	2022	0.1629	8,255	\$1,345	166	\$27	3,651	\$595	12,072	\$1,967	0.05	0.1129	\$1,363.35	
8	2023	0.1639	8,255	\$1,353	166	\$27	3,651	\$598	12,072	\$1,978	0.05	0.1139	\$1,374.65	
9	2024	0.1648	8,255	\$1,360	166	\$27	3,651	\$602	12,072	\$1,990	0.05	0.1148	\$1,385.95	
10	2025	0.1656	8,255	\$1,367	166	\$27	3,651	\$605	12,072	\$1,999	0.05	0.1156	\$1,395.51	
11	2026	0.1665	8,255	\$1,375	166	\$28	3,651	\$608	12,072	\$2,010	0.05	0.1165	\$1,406.81	
12	2027	0.1674	8,255	\$1,382	166	\$28	3,651	\$611	12,072	\$2,021	0.05	0.1174	\$1,417.67	
13	2028	0.1683	8,255	\$1,389	166	\$28	3,651	\$614	12,072	\$2,031	0.05	0.1183	\$1,427.67	
14	2029	0.1692	8,255	\$1,396	166	\$28	3,651	\$618	12,072	\$2,042	0.05	0.1192	\$1,438.53	
15	2030	0.1701	8,255	\$1,404	166	\$28	3,651	\$621	12,072	\$2,053	0.05	0.1201	\$1,449.83	
16	2031	0.1704	8,255	\$1,406	166	\$28	3,651	\$622	12,072	\$2,056	0.05	0.1204	\$1,452.87	
17	2032	0.1705	8,255	\$1,407	166	\$28	3,651	\$622	12,072	\$2,058	0.05	0.1205	\$1,454.61	
18	2033	0.1707	8,255	\$1,410	166	\$28	3,651	\$623	12,072	\$2,061	0.05	0.1207	\$1,457.65	
19	2034	0.1710	8,255	\$1,412	166	\$28	3,651	\$624	12,072	\$2,065	0.05	0.1210	\$1,461.13	
20	2035	0.1713	8,255	\$1,414	166	\$28	3,651	\$625	12,072	\$2,068	0.05	0.1213	\$1,464.17	
21	2036	0.1714	8,255	\$1,415	166	\$28	3,651	\$626	12,072	\$2,070	0.05	0.1214	\$1,465.91	
22	2037	0.1717	8,255	\$1,417	166	\$28	3,651	\$627	12,072	\$2,073	0.05	0.1217	\$1,468.95	
23	2038	0.1720	8,255	\$1,420	166	\$29	3,651	\$628	12,072	\$2,076	0.05	0.1220	\$1,472.43	
24	2039	0.1722	8,255	\$1,422	166	\$29	3,651	\$629	12,072	\$2,079	0.05	0.1222	\$1,475.47	
25	2040	0.1724	8,255	\$1,423	166	\$29	3,651	\$629	12,072	\$2,081	0.05	0.1224	\$1,477.21	
26	2041	0.1734	8,255	\$1,431	166	\$29	3,651	\$633	12,072	\$2,093	0.05	0.1234	\$1,489.25	
27	2042	0.1744	8,255	\$1,439	166	\$29	3,651	\$637	12,072	\$2,105	0.05	0.1244	\$1,501.35	
28	2043	0.1754	8,255	\$1,448	166	\$29	3,651	\$640	12,072	\$2,117	0.05	0.1254	\$1,513.53	
29	2044	0.1764	8,255	\$1,456	166	\$29	3,651	\$644	12,072	\$2,129	0.05	0.1264	\$1,525.78	
30	2045	0.1774	8,255	\$1,465	166	\$29	3,651	\$649	12,072	\$2,142	0.05	0.1274	\$1,538.10	
31	2046	0.1784	8,255	\$1,473	166	\$30	3,651	\$651	12,072	\$2,154	0.05	0.1284	\$1,550.49	
32	2047	0.1795	8,255	\$1,482	166	\$30	3,651	\$655	12,072	\$2,167	0.05	0.1295	\$1,562.95	
33	2048	0.1805	8,255	\$1,490	166	\$30	3,651	\$659	12,072	\$2,179	0.05	0.1305	\$1,575.48	
34	2049	0.1816	8,255	\$1,499	166	\$30	3,651	\$663	12,072	\$2,192	0.05	0.1316	\$1,588.09	
35	2050	0.1826	8,255	\$1,507	166	\$30	3,651	\$667	12,072	\$2,204	0.05	0.1326	\$1,600.76	
36	2051	0.1837	8,255	\$1,516	166	\$30	3,651	\$671	12,072	\$2,217	0.05	0.1337	\$1,613.52	
37	2052	0.1847	8,255	\$1,525	166	\$31	3,651	\$674	12,072	\$2,230	0.05	0.1347	\$1,626.34	
38	2053	0.1858	8,255	\$1,534	166	\$31	3,651	\$678	12,072	\$2,243	0.05	0.1358	\$1,639.24	
39	2054	0.1869	8,255	\$1,543	166	\$31	3,651	\$682	12,072	\$2,256	0.05	0.1369	\$1,652.22	
40	2055	0.1879	8,255	\$1,551	166	\$31	3,651	\$686	12,072	\$2,269	0.05	0.1379	\$1,665.27	
41	2056	0.1890	8,255	\$1,560	166	\$31	3,651	\$690	12,072	\$2,282	0.05	0.1390	\$1,678.39	
42	2057	0.1901	8,255	\$1,569	166	\$32	3,651	\$694	12,072	\$2,295	0.05	0.1401	\$1,691.59	
43	2058	0.1912	8,255	\$1,579	166	\$32	3,651	\$698	12,072	\$2,308	0.05	0.1412	\$1,704.87	
44	2059	0.1923	8,255	\$1,588	166	\$32	3,651	\$702	12,072	\$2,322	0.05	0.1423	\$1,718.22	
45	2060	0.1934	8,255	\$1,597	166	\$32	3,651	\$706	12,072	\$2,335	0.05	0.1434	\$1,731.65	
46	2061	0.1946	8,255	\$1,606	166	\$32	3,651	\$710	12,072	\$2,349	0.05	0.1446	\$1,745.16	
47	2062	0.1957	8,255	\$1,615	166	\$32	3,651	\$714	12,072	\$2,362	0.05	0.1457	\$1,758.75	
48	2063	0.1968	8,255	\$1,625	166	\$33	3,651	\$719	12,072	\$2,376	0.05	0.1468	\$1,772.42	
49	2064	0.1980	8,255	\$1,634	166	\$33	3,651	\$723	12,072	\$2,390	0.05	0.1480	\$1,786.16	
50	2065	0.1991	8,255	\$1,644	166	\$33	3,651	\$727	12,072	\$2,404	0.05	0.1491	\$1,799.99	
51	2066	0.2003	8,255	\$1,653	166	\$33	3,651	\$731	12,072	\$2,417	0.05	0.1503	\$1,813.89	
52	2067	0.2014	8,255	\$1,663	166	\$33	3,651	\$735	12,072	\$2,431	0.05	0.1514	\$1,827.88	
53	2068	0.2026	8,255	\$1,672	166	\$34	3,651	\$740	12,072	\$2,446	0.05	0.1526	\$1,841.94	
54	2069	0.2038	8,255	\$1,682	166	\$34	3,651	\$744	12,072	\$2,460	0.05	0.1538	\$1,856.09	
55	2070	0.2049	8,255	\$1,692	166	\$34	3,651	\$748	12,072	\$2,474	0.05	0.1549	\$1,870.32	
56	2071	0.2061	8,255	\$1,701	166	\$34	3,651	\$753	12,072	\$2,488	0.05	0.1561	\$1,884.63	
57	2072	0.2073	8,255	\$1,711	166	\$34	3,651	\$757	12,072	\$2,503	0.05	0.1573	\$1,899.02	
58	2073	0.2085	8,255	\$1,721	166	\$35	3,651	\$761	12,072	\$2,517	0.05	0.1585	\$1,913.50	
59	2074	0.2097	8,255	\$1,731	166	\$35	3,651	\$766	12,072	\$2,532	0.05	0.1597	\$1,928.06	
60	2075	0.2109	8,255	\$1,741	166	\$35	3,651	\$770	12,072	\$2,546	0.05	0.1609	\$1,942.71	

Table D1-1.79: Annual Operating Costs (V.GSHP) of a 2,000 square feet detached house above grade (average construction type) in the city of Timmins (two life cycles and three life cycles for a 60 year project lifespan); base case scenario in comparison with feed-in-tariff (FIT) scenario. In the FIT scenario, an incentive of \$0.05/KWh is provided on electricity bills throughout the project lifespan

Horizontal Ground Source Heat Pump (H.GSHP)

Base Case Scenario											Feed in Tariff (FIT)		
H.GSHP											FIT		
#	Year	Electricity Rates \$/KWh	Heating KWh	Heating Operating Cost \$	Cooling KWh	Cooling Operating Cost \$	Hot Water KWh	Hot Water Operating Cost \$	Total KWh	Total Operating Cost \$	Incentives (\$/KWh)	\$/KWh	Operating Cost
1	2016	0.1501	8,401	\$1,261	172	\$26	3,649	\$548	12,222	\$1,834	0.05	0.1001	\$1,223.21
2	2017	0.1542	8,401	\$1,295	172	\$27	3,649	\$563	12,222	\$1,884	0.05	0.1042	\$1,273.37
3	2018	0.1583	8,401	\$1,330	172	\$27	3,649	\$578	12,222	\$1,935	0.05	0.1083	\$1,323.53
4	2019	0.1625	8,401	\$1,365	172	\$28	3,649	\$593	12,222	\$1,987	0.05	0.1125	\$1,375.45
5	2020	0.1668	8,401	\$1,401	172	\$29	3,649	\$609	12,222	\$2,038	0.05	0.1168	\$1,427.37
6	2021	0.1621	8,401	\$1,362	172	\$28	3,649	\$592	12,222	\$1,982	0.05	0.1121	\$1,370.61
7	2022	0.1629	8,401	\$1,369	172	\$28	3,649	\$595	12,222	\$1,991	0.05	0.1129	\$1,380.29
8	2023	0.1639	8,401	\$1,377	172	\$28	3,649	\$598	12,222	\$2,003	0.05	0.1139	\$1,391.73
9	2024	0.1648	8,401	\$1,385	172	\$28	3,649	\$601	12,222	\$2,014	0.05	0.1148	\$1,403.17
10	2025	0.1656	8,401	\$1,391	172	\$28	3,649	\$604	12,222	\$2,024	0.05	0.1156	\$1,412.85
11	2026	0.1665	8,401	\$1,399	172	\$29	3,649	\$608	12,222	\$2,035	0.05	0.1165	\$1,424.29
12	2027	0.1674	8,401	\$1,407	172	\$29	3,649	\$611	12,222	\$2,046	0.05	0.1174	\$1,435.29
13	2028	0.1683	8,401	\$1,414	172	\$29	3,649	\$614	12,222	\$2,057	0.05	0.1183	\$1,445.41
14	2029	0.1692	8,401	\$1,421	172	\$29	3,649	\$617	12,222	\$2,068	0.05	0.1192	\$1,456.41
15	2030	0.1701	8,401	\$1,429	172	\$29	3,649	\$621	12,222	\$2,079	0.05	0.1201	\$1,467.85
16	2031	0.1704	8,401	\$1,431	172	\$29	3,649	\$622	12,222	\$2,082	0.05	0.1204	\$1,470.93
17	2032	0.1705	8,401	\$1,432	172	\$29	3,649	\$622	12,222	\$2,084	0.05	0.1205	\$1,472.69
18	2033	0.1707	8,401	\$1,434	172	\$29	3,649	\$623	12,222	\$2,087	0.05	0.1207	\$1,475.77
19	2034	0.1710	8,401	\$1,437	172	\$29	3,649	\$624	12,222	\$2,090	0.05	0.1210	\$1,479.29
20	2035	0.1713	8,401	\$1,439	172	\$29	3,649	\$625	12,222	\$2,093	0.05	0.1213	\$1,482.37
21	2036	0.1714	8,401	\$1,440	172	\$29	3,649	\$626	12,222	\$2,095	0.05	0.1214	\$1,484.13
22	2037	0.1717	8,401	\$1,442	172	\$30	3,649	\$626	12,222	\$2,098	0.05	0.1217	\$1,487.21
23	2038	0.1720	8,401	\$1,445	172	\$30	3,649	\$628	12,222	\$2,102	0.05	0.1220	\$1,490.72
24	2039	0.1722	8,401	\$1,447	172	\$30	3,649	\$628	12,222	\$2,105	0.05	0.1222	\$1,493.80
25	2040	0.1724	8,401	\$1,448	172	\$30	3,649	\$629	12,222	\$2,107	0.05	0.1224	\$1,495.56
26	2041	0.1734	8,401	\$1,456	172	\$30	3,649	\$633	12,222	\$2,119	0.05	0.1234	\$1,507.75
27	2042	0.1744	8,401	\$1,465	172	\$30	3,649	\$636	12,222	\$2,131	0.05	0.1244	\$1,520.01
28	2043	0.1754	8,401	\$1,473	172	\$30	3,649	\$640	12,222	\$2,143	0.05	0.1254	\$1,532.34
29	2044	0.1764	8,401	\$1,482	172	\$30	3,649	\$644	12,222	\$2,156	0.05	0.1264	\$1,544.74
30	2045	0.1774	8,401	\$1,490	172	\$31	3,649	\$647	12,222	\$2,168	0.05	0.1274	\$1,557.21
31	2046	0.1784	8,401	\$1,499	172	\$31	3,649	\$651	12,222	\$2,181	0.05	0.1284	\$1,569.75
32	2047	0.1795	8,401	\$1,508	172	\$31	3,649	\$655	12,222	\$2,193	0.05	0.1295	\$1,582.37
33	2048	0.1805	8,401	\$1,516	172	\$31	3,649	\$659	12,222	\$2,206	0.05	0.1305	\$1,595.06
34	2049	0.1816	8,401	\$1,525	172	\$31	3,649	\$662	12,222	\$2,219	0.05	0.1316	\$1,607.82
35	2050	0.1826	8,401	\$1,534	172	\$31	3,649	\$666	12,222	\$2,232	0.05	0.1326	\$1,620.65
36	2051	0.1837	8,401	\$1,543	172	\$32	3,649	\$670	12,222	\$2,245	0.05	0.1337	\$1,633.56
37	2052	0.1847	8,401	\$1,552	172	\$32	3,649	\$674	12,222	\$2,258	0.05	0.1347	\$1,646.55
38	2053	0.1858	8,401	\$1,561	172	\$32	3,649	\$678	12,222	\$2,271	0.05	0.1358	\$1,659.61
39	2054	0.1869	8,401	\$1,570	172	\$32	3,649	\$682	12,222	\$2,284	0.05	0.1369	\$1,672.75
40	2055	0.1879	8,401	\$1,579	172	\$32	3,649	\$686	12,222	\$2,297	0.05	0.1379	\$1,685.96
41	2056	0.1890	8,401	\$1,588	172	\$33	3,649	\$690	12,222	\$2,310	0.05	0.1390	\$1,699.25
42	2057	0.1901	8,401	\$1,597	172	\$33	3,649	\$694	12,222	\$2,324	0.05	0.1401	\$1,712.61
43	2058	0.1912	8,401	\$1,606	172	\$33	3,649	\$698	12,222	\$2,337	0.05	0.1412	\$1,726.05
44	2059	0.1923	8,401	\$1,616	172	\$33	3,649	\$702	12,222	\$2,351	0.05	0.1423	\$1,739.57
45	2060	0.1934	8,401	\$1,625	172	\$33	3,649	\$706	12,222	\$2,364	0.05	0.1434	\$1,753.17
46	2061	0.1946	8,401	\$1,635	172	\$33	3,649	\$710	12,222	\$2,378	0.05	0.1446	\$1,766.85
47	2062	0.1957	8,401	\$1,644	172	\$34	3,649	\$714	12,222	\$2,392	0.05	0.1457	\$1,780.60
48	2063	0.1968	8,401	\$1,653	172	\$34	3,649	\$718	12,222	\$2,406	0.05	0.1468	\$1,794.44
49	2064	0.1980	8,401	\$1,663	172	\$34	3,649	\$722	12,222	\$2,419	0.05	0.1480	\$1,808.36
50	2065	0.1991	8,401	\$1,673	172	\$34	3,649	\$727	12,222	\$2,433	0.05	0.1491	\$1,822.35
51	2066	0.2003	8,401	\$1,682	172	\$34	3,649	\$731	12,222	\$2,448	0.05	0.1503	\$1,836.43
52	2067	0.2014	8,401	\$1,692	172	\$35	3,649	\$735	12,222	\$2,462	0.05	0.1514	\$1,850.59
53	2068	0.2026	8,401	\$1,702	172	\$35	3,649	\$739	12,222	\$2,476	0.05	0.1526	\$1,864.83
54	2069	0.2038	8,401	\$1,712	172	\$35	3,649	\$743	12,222	\$2,490	0.05	0.1538	\$1,879.15
55	2070	0.2049	8,401	\$1,722	172	\$35	3,649	\$748	12,222	\$2,505	0.05	0.1549	\$1,893.56
56	2071	0.2061	8,401	\$1,732	172	\$35	3,649	\$752	12,222	\$2,519	0.05	0.1561	\$1,908.05
57	2072	0.2073	8,401	\$1,742	172	\$36	3,649	\$756	12,222	\$2,534	0.05	0.1573	\$1,922.62
58	2073	0.2085	8,401	\$1,752	172	\$36	3,649	\$761	12,222	\$2,548	0.05	0.1585	\$1,937.28
59	2074	0.2097	8,401	\$1,762	172	\$36	3,649	\$765	12,222	\$2,563	0.05	0.1597	\$1,952.02
60	2075	0.2109	8,401	\$1,772	172	\$36	3,649	\$770	12,222	\$2,578	0.05	0.1609	\$1,966.85

Table D1-1.80: Annual Operating Costs (H.GSHP) of a 2,000 square feet detached house above grade (average construction type) in the city of Timmins (two life cycles and three life cycles for a 60 year project lifespan); base case scenario in comparison with feed-in-tariff (FIT) scenario. In the FIT scenario, an incentive of \$0.05/KWh is provided on electricity bills throughout the project lifespan

Traditional HVAC Applications

Base Case Scenario															Carbon Taxes							
#	Year	Electricity Rates	Natural Gas Rates	Heating		Heating Operating Cost	Heating Operating Cost	Total Heating Operating Cost	Cooling	Cooling Operating Cost	Hot Water	Hot Water Operating Cost	Total	Total	Total Electricity Operating Cost	Total Natural Gas Operating Cost	Total	Conversion of m ³ into Tons	Total Tons	Carbon Tax	Operating Costs	
				KWh (Electricity)	m ³ (Gas)																	\$ (Electricity)
1	2016	0.1501	0.3458	2,272	3,785	\$341	\$1,309	\$1,650	746	\$112	1,051	\$363	3,018	4,836	453	\$1,672	\$2,125	8.75	8.75	\$10	\$875.53	\$2,212.92
2	2017	0.1542	0.3588	2,272	3,785	\$350	\$1,358	\$1,709	746	\$115	1,051	\$162	3,018	4,836	465	\$1,735	\$2,201	8.75	8.75	\$20	\$175.06	\$2,375.73
3	2018	0.1583	0.3718	2,272	3,785	\$360	\$1,407	\$1,767	746	\$118	1,051	\$166	3,018	4,836	478	\$1,798	\$2,276	8.75	8.75	\$30	\$262.59	\$2,538.55
4	2019	0.1625	0.3776	2,272	3,785	\$369	\$1,429	\$1,798	746	\$121	1,051	\$171	3,018	4,836	491	\$1,826	\$2,317	8.75	8.75	\$40	\$350.13	\$2,666.66
5	2020	0.1668	0.3841	2,272	3,785	\$379	\$1,454	\$1,833	746	\$124	1,051	\$175	3,018	4,836	503	\$1,857	\$2,361	8.75	8.75	\$50	\$437.66	\$2,798.46
6	2021	0.1621	0.3883	2,272	3,785	\$368	\$1,470	\$1,838	746	\$121	1,051	\$170	3,018	4,836	489	\$1,878	\$2,367	8.75	8.75	\$60	\$525.19	\$2,892.33
7	2022	0.1629	0.3929	2,272	3,785	\$370	\$1,487	\$1,857	746	\$122	1,051	\$171	3,018	4,836	492	\$1,900	\$2,392	8.75	8.75	\$70	\$612.72	\$3,004.45
8	2023	0.1639	0.3967	2,272	3,785	\$372	\$1,502	\$1,874	746	\$122	1,051	\$172	3,018	4,836	495	\$1,918	\$2,413	8.75	8.75	\$80	\$700.25	\$3,113.30
9	2024	0.1648	0.4005	2,272	3,785	\$374	\$1,516	\$1,890	746	\$123	1,051	\$173	3,018	4,836	497	\$1,937	\$2,434	8.75	8.75	\$90	\$787.78	\$3,222.16
10	2025	0.1656	0.4040	2,272	3,785	\$376	\$1,529	\$1,905	746	\$124	1,051	\$174	3,018	4,836	500	\$1,954	\$2,453	8.75	8.75	\$100	\$875.32	\$3,328.73
11	2026	0.1665	0.4070	2,272	3,785	\$378	\$1,541	\$1,919	746	\$124	1,051	\$175	3,018	4,836	503	\$1,968	\$2,471	8.75	8.75	\$110	\$962.85	\$3,433.89
12	2027	0.1674	0.4097	2,272	3,785	\$380	\$1,551	\$1,931	746	\$125	1,051	\$176	3,018	4,836	505	\$1,981	\$2,487	8.75	8.75	\$120	\$1,050.38	\$3,537.09
13	2028	0.1683	0.4124	2,272	3,785	\$382	\$1,561	\$1,943	746	\$126	1,051	\$177	3,018	4,836	508	\$1,994	\$2,502	8.75	8.75	\$130	\$1,137.91	\$3,640.07
14	2029	0.1692	0.4151	2,272	3,785	\$384	\$1,571	\$1,955	746	\$126	1,051	\$178	3,018	4,836	511	\$2,007	\$2,518	8.75	8.75	\$140	\$1,225.44	\$3,743.27
15	2030	0.1701	0.4170	2,272	3,785	\$386	\$1,578	\$1,965	746	\$127	1,051	\$179	3,018	4,836	513	\$2,017	\$2,530	8.75	8.75	\$150	\$1,312.97	\$3,842.87
16	2031	0.1704	0.4189	2,272	3,785	\$387	\$1,586	\$1,973	746	\$127	1,051	\$179	3,018	4,836	514	\$2,026	\$2,540	8.75	8.75	\$160	\$1,400.51	\$3,940.42
17	2032	0.1705	0.4204	2,272	3,785	\$387	\$1,591	\$1,979	746	\$127	1,051	\$179	3,018	4,836	515	\$2,033	\$2,548	8.75	8.75	\$170	\$1,488.04	\$4,035.78
18	2033	0.1707	0.4223	2,272	3,785	\$388	\$1,599	\$1,986	746	\$127	1,051	\$179	3,018	4,836	515	\$2,042	\$2,558	8.75	8.75	\$180	\$1,575.57	\$4,133.32
19	2034	0.1710	0.4246	2,272	3,785	\$389	\$1,607	\$1,996	746	\$128	1,051	\$180	3,018	4,836	516	\$2,054	\$2,570	8.75	8.75	\$190	\$1,663.10	\$4,232.83
20	2035	0.1713	0.4265	2,272	3,785	\$389	\$1,614	\$2,004	746	\$128	1,051	\$180	3,018	4,836	517	\$2,063	\$2,580	8.75	8.75	\$200	\$1,750.63	\$4,330.37
21	2036	0.1714	0.4278	2,272	3,785	\$389	\$1,623	\$2,013	746	\$128	1,051	\$180	3,018	4,836	517	\$2,071	\$2,591	8.75	8.75	\$210	\$1,838.16	\$4,429.45
22	2037	0.1717	0.4311	2,272	3,785	\$390	\$1,632	\$2,022	746	\$128	1,051	\$180	3,018	4,836	518	\$2,085	\$2,603	8.75	8.75	\$220	\$1,925.70	\$4,528.83
23	2038	0.1720	0.4331	2,272	3,785	\$391	\$1,639	\$2,030	746	\$128	1,051	\$181	3,018	4,836	519	\$2,094	\$2,613	8.75	8.75	\$230	\$2,013.23	\$4,626.48
24	2039	0.1722	0.4353	2,272	3,785	\$391	\$1,648	\$2,039	746	\$128	1,051	\$181	3,018	4,836	520	\$2,105	\$2,625	8.75	8.75	\$240	\$2,100.76	\$4,725.87
25	2040	0.1724	0.4376	2,272	3,785	\$392	\$1,656	\$2,048	746	\$129	1,051	\$181	3,018	4,836	520	\$2,116	\$2,637	8.75	8.75	\$250	\$2,188.29	\$4,824.94
26	2041	0.1734	0.4420	2,272	3,785	\$394	\$1,673	\$2,067	746	\$129	1,051	\$182	3,018	4,836	523	\$2,137	\$2,661	8.75	8.75	\$260	\$2,275.82	\$4,936.34
27	2042	0.1744	0.4463	2,272	3,785	\$396	\$1,689	\$2,085	746	\$130	1,051	\$183	3,018	4,836	526	\$2,158	\$2,685	8.75	8.75	\$270	\$2,363.35	\$5,047.97
28	2043	0.1754	0.4507	2,272	3,785	\$398	\$1,706	\$2,104	746	\$131	1,051	\$184	3,018	4,836	529	\$2,180	\$2,709	8.75	8.75	\$280	\$2,450.88	\$5,159.83
29	2044	0.1764	0.4552	2,272	3,785	\$401	\$1,723	\$2,124	746	\$132	1,051	\$185	3,018	4,836	532	\$2,201	\$2,733	8.75	8.75	\$290	\$2,538.42	\$5,271.91
30	2045	0.1774	0.4596	2,272	3,785	\$403	\$1,740	\$2,143	746	\$132	1,051	\$186	3,018	4,836	535	\$2,223	\$2,758	8.75	8.75	\$300	\$2,625.95	\$5,384.22
31	2046	0.1784	0.4640	2,272	3,785	\$405	\$1,757	\$2,162	746	\$133	1,051	\$188	3,018	4,836	539	\$2,245	\$2,783	8.75	8.75	\$310	\$2,713.48	\$5,496.77
32	2047	0.1795	0.4688	2,272	3,785	\$408	\$1,774	\$2,182	746	\$134	1,051	\$189	3,018	4,836	542	\$2,267	\$2,809	8.75	8.75	\$320	\$2,801.01	\$5,609.55
33	2048	0.1805	0.4734	2,272	3,785	\$410	\$1,792	\$2,202	746	\$135	1,051	\$190	3,018	4,836	545	\$2,289	\$2,834	8.75	8.75	\$330	\$2,888.54	\$5,722.56
34	2049	0.1816	0.4780	2,272	3,785	\$412	\$1,809	\$2,222	746	\$135	1,051	\$191	3,018	4,836	548	\$2,312	\$2,860	8.75	8.75	\$340	\$2,976.07	\$5,835.81
35	2050	0.1826	0.4828	2,272	3,785	\$415	\$1,827	\$2,242	746	\$136	1,051	\$192	3,018	4,836	551	\$2,335	\$2,886	8.75	8.75	\$350	\$3,063.61	\$5,949.31
36	2051	0.1837	0.4875	2,272	3,785	\$417	\$1,845	\$2,263	746	\$137	1,051	\$193	3,018	4,836	554	\$2,358	\$2,912	8.75	8.75	\$360	\$3,151.14	\$6,063.04
37	2052	0.1847	0.4923	2,272	3,785	\$420	\$1,863	\$2,283	746	\$138	1,051	\$194	3,018	4,836	557	\$2,381	\$2,938	8.75	8.75	\$370	\$3,238.67	\$6,177.02
38	2053	0.1858	0.4972	2,272	3,785	\$422	\$1,882	\$2,304	746	\$139	1,051	\$195	3,018	4,836	561	\$2,404	\$2,965	8.75	8.75	\$380	\$3,326.20	\$6,291.25
39	2054	0.1869	0.5021	2,272	3,785	\$425	\$1,900	\$2,325	746	\$139	1,051	\$196	3,018	4,836	564	\$2,428	\$2,992	8.75	8.75	\$390	\$3,413.73	\$6,405.73
40	2055	0.1879	0.5070	2,272	3,785	\$427	\$1,919	\$2,346	746	\$140	1,051	\$198	3,018	4,836	567	\$2,452	\$3,019	8.75	8.75	\$400	\$3,501.26	\$6,520.46
41	2056	0.1890	0.5120	2,272	3,785	\$429	\$1,938	\$2,367	746	\$141	1,051	\$199	3,018	4,836	570	\$2,476	\$3,047	8.75	8.75	\$410	\$3,588.80	\$6,635.45
42	2057	0.1901	0.5171	2,272	3,785	\$432	\$1,957	\$2,389	746	\$142	1,051	\$200	3,018	4,836	574	\$2,501	\$3,074	8.75	8.75	\$420	\$3,676.33	\$6,750.70
43	2058	0.1912	0.5222	2,272	3,785	\$434	\$1,976	\$2,411	746	\$143	1,051	\$201	3,018	4,836	577	\$2,525	\$3,102	8.75	8.75	\$430	\$3,763.86	\$6,866.20
44	2059	0.1923	0.5273	2,272	3,785	\$437	\$1,996	\$2,433	746	\$143	1,051	\$202	3,018	4,836	580	\$2,550	\$3,131	8.75	8.75	\$440	\$3,851.39	\$6,981.97
45	2060	0.1934	0.5325	2,272	3,785	\$440	\$2,016	\$2,455	746	\$144	1,051	\$203	3,018	4,836	584	\$2,575	\$3,159	8.75	8.75	\$450	\$3,938.92	\$7,098.00
46	2061	0.1946	0.5378	2,272	3,785	\$442	\$2,035	\$2,478	746	\$145	1,051	\$204	3,018	4,836	587	\$2,601	\$3,188	8.75	8.75	\$460	\$4,026.45	\$7,214.30
47	2062	0.1957	0.5431	2,272	3,785	\$445	\$2,056	\$2,500	746	\$146	1,051	\$205	3,018	4,836	591	\$2,626	\$3,217	8.75	8.75	\$470	\$4,113.99	\$7,330.86
48	2063	0.1968	0.5484	2,272	3,785	\$447	\$2,076	\$2,523	746	\$147	1,051	\$207	3,018	4,836	594	\$2,652	\$3,246	8.75	8.75	\$480	\$4,201.52	\$7,447.70
49	2064	0.1980	0.5538	2,272	3,785	\$450	\$2,096	\$2,546	746	\$148	1,051	\$208	3,018	4,836	597	\$2,678	\$3,276	8.75	8.75	\$490	\$4,289.05	\$7,564.82
50	2065	0.1991	0.5593	2,272	3,785	\$452	\$2,117	\$2,569	746	\$149	1,051	\$209	3,018	4,836	601	\$2,705	\$3,306	8.75	8.75	\$500	\$4,376.58	\$7,682.21
51	2066	0.2003	0.5648	2,272	3,785	\$455	\$2,138	\$2,593	746	\$149	1,051	\$210	3,018	4,836	604	\$2,731	\$3,336	8.75	8.75	\$510	\$4,464.11	\$7,799.89
52	2067	0.2014	0.5704	2,272	3,785	\$458	\$2,159	\$2,616	746	\$150	1,051	\$212	3,018	4,836	608	\$2,758	\$3,366	8.75	8.75	\$520	\$4,551.64	\$7,917.84
53	2068	0.2026	0.5760	2,272	3,785	\$460	\$2,180	\$2,640	746	\$151	1,051	\$213	3,018	4,836	611	\$2,786	\$3,397	8.75	8.75	\$530	\$4,639.17	\$8,03

Appendix D2 –Annual Operating Costs of HVAC Systems in Ontario Cities – Improved Construction Type

1. Cambridge (South) – Annual Operating Costs

Vertical Ground Source Heat Pump (V.GSHP)

Base Case Scenario											Feed in Tariff (FIT)		
V.GSHP													
#	Year	Electricity Rates \$/KWh	Heating KWh	Heating Operating Cost \$	Cooling KWh	Cooling Operating Cost \$	Hot Water KWh	Hot Water Operating Cost \$	Total KWh	Total Operating Cost \$	Incentives (S/KWh)	FIT S/KWh	Operating Cost
1	2016	0.1501	4,135	\$621	197	\$30	4,588	\$689	8,920	\$1,339	0.05	0.1001	\$892.74
2	2017	0.1542	4,135	\$638	197	\$30	4,588	\$707	8,920	\$1,375	0.05	0.1042	\$929.35
3	2018	0.1583	4,135	\$655	197	\$31	4,588	\$726	8,920	\$1,412	0.05	0.1083	\$965.95
4	2019	0.1625	4,135	\$672	197	\$32	4,588	\$746	8,920	\$1,450	0.05	0.1125	\$1,003.85
5	2020	0.1668	4,135	\$690	197	\$33	4,588	\$765	8,920	\$1,488	0.05	0.1168	\$1,041.74
6	2021	0.1621	4,135	\$670	197	\$32	4,588	\$744	8,920	\$1,446	0.05	0.1121	\$1,000.31
7	2022	0.1629	4,135	\$674	197	\$32	4,588	\$748	8,920	\$1,453	0.05	0.1129	\$1,007.38
8	2023	0.1639	4,135	\$678	197	\$32	4,588	\$752	8,920	\$1,462	0.05	0.1139	\$1,015.73
9	2024	0.1648	4,135	\$681	197	\$32	4,588	\$756	8,920	\$1,470	0.05	0.1148	\$1,024.08
10	2025	0.1656	4,135	\$685	197	\$33	4,588	\$760	8,920	\$1,477	0.05	0.1156	\$1,031.14
11	2026	0.1665	4,135	\$689	197	\$33	4,588	\$764	8,920	\$1,485	0.05	0.1165	\$1,039.49
12	2027	0.1674	4,135	\$692	197	\$33	4,588	\$768	8,920	\$1,494	0.05	0.1174	\$1,047.52
13	2028	0.1683	4,135	\$696	197	\$33	4,588	\$772	8,920	\$1,501	0.05	0.1183	\$1,054.90
14	2029	0.1692	4,135	\$699	197	\$33	4,588	\$776	8,920	\$1,509	0.05	0.1192	\$1,062.93
15	2030	0.1701	4,135	\$703	197	\$34	4,588	\$780	8,920	\$1,517	0.05	0.1201	\$1,071.28
16	2031	0.1704	4,135	\$704	197	\$34	4,588	\$782	8,920	\$1,520	0.05	0.1204	\$1,073.53
17	2032	0.1705	4,135	\$705	197	\$34	4,588	\$782	8,920	\$1,521	0.05	0.1205	\$1,074.81
18	2033	0.1707	4,135	\$706	197	\$34	4,588	\$783	8,920	\$1,523	0.05	0.1207	\$1,077.06
19	2034	0.1710	4,135	\$707	197	\$34	4,588	\$785	8,920	\$1,526	0.05	0.1210	\$1,079.63
20	2035	0.1713	4,135	\$708	197	\$34	4,588	\$786	8,920	\$1,528	0.05	0.1213	\$1,081.88
21	2036	0.1714	4,135	\$708	197	\$34	4,588	\$787	8,920	\$1,529	0.05	0.1214	\$1,083.16
22	2037	0.1717	4,135	\$710	197	\$34	4,588	\$788	8,920	\$1,531	0.05	0.1217	\$1,085.41
23	2038	0.1720	4,135	\$711	197	\$34	4,588	\$789	8,920	\$1,534	0.05	0.1220	\$1,087.98
24	2039	0.1722	4,135	\$712	197	\$34	4,588	\$790	8,920	\$1,536	0.05	0.1222	\$1,090.23
25	2040	0.1724	4,135	\$713	197	\$34	4,588	\$791	8,920	\$1,538	0.05	0.1224	\$1,091.51
26	2041	0.1734	4,135	\$717	197	\$34	4,588	\$795	8,920	\$1,546	0.05	0.1234	\$1,100.40
27	2042	0.1744	4,135	\$721	197	\$34	4,588	\$800	8,920	\$1,555	0.05	0.1244	\$1,109.35
28	2043	0.1754	4,135	\$725	197	\$35	4,588	\$805	8,920	\$1,564	0.05	0.1254	\$1,118.35
29	2044	0.1764	4,135	\$729	197	\$35	4,588	\$809	8,920	\$1,573	0.05	0.1264	\$1,127.40
30	2045	0.1774	4,135	\$734	197	\$35	4,588	\$814	8,920	\$1,582	0.05	0.1274	\$1,136.50
31	2046	0.1784	4,135	\$738	197	\$35	4,588	\$819	8,920	\$1,592	0.05	0.1284	\$1,145.65
32	2047	0.1795	4,135	\$742	197	\$35	4,588	\$823	8,920	\$1,601	0.05	0.1295	\$1,154.86
33	2048	0.1805	4,135	\$746	197	\$36	4,588	\$828	8,920	\$1,610	0.05	0.1305	\$1,164.12
34	2049	0.1816	4,135	\$751	197	\$36	4,588	\$833	8,920	\$1,619	0.05	0.1316	\$1,173.44
35	2050	0.1826	4,135	\$755	197	\$36	4,588	\$838	8,920	\$1,629	0.05	0.1326	\$1,182.80
36	2051	0.1837	4,135	\$759	197	\$36	4,588	\$843	8,920	\$1,638	0.05	0.1337	\$1,192.23
37	2052	0.1847	4,135	\$764	197	\$36	4,588	\$847	8,920	\$1,648	0.05	0.1347	\$1,201.70
38	2053	0.1858	4,135	\$768	197	\$37	4,588	\$852	8,920	\$1,657	0.05	0.1358	\$1,211.24
39	2054	0.1869	4,135	\$773	197	\$37	4,588	\$857	8,920	\$1,667	0.05	0.1369	\$1,220.82
40	2055	0.1879	4,135	\$777	197	\$37	4,588	\$862	8,920	\$1,676	0.05	0.1379	\$1,230.46
41	2056	0.1890	4,135	\$782	197	\$37	4,588	\$867	8,920	\$1,686	0.05	0.1390	\$1,240.16
42	2057	0.1901	4,135	\$786	197	\$37	4,588	\$872	8,920	\$1,696	0.05	0.1401	\$1,249.92
43	2058	0.1912	4,135	\$791	197	\$38	4,588	\$877	8,920	\$1,706	0.05	0.1412	\$1,259.73
44	2059	0.1923	4,135	\$795	197	\$38	4,588	\$882	8,920	\$1,716	0.05	0.1423	\$1,269.60
45	2060	0.1934	4,135	\$800	197	\$38	4,588	\$888	8,920	\$1,726	0.05	0.1434	\$1,279.52
46	2061	0.1946	4,135	\$805	197	\$38	4,588	\$893	8,920	\$1,736	0.05	0.1446	\$1,289.50
47	2062	0.1957	4,135	\$809	197	\$39	4,588	\$898	8,920	\$1,746	0.05	0.1457	\$1,299.54
48	2063	0.1968	4,135	\$814	197	\$39	4,588	\$903	8,920	\$1,756	0.05	0.1468	\$1,309.64
49	2064	0.1980	4,135	\$819	197	\$39	4,588	\$908	8,920	\$1,766	0.05	0.1480	\$1,319.79
50	2065	0.1991	4,135	\$823	197	\$39	4,588	\$913	8,920	\$1,776	0.05	0.1491	\$1,330.01
51	2066	0.2003	4,135	\$828	197	\$39	4,588	\$919	8,920	\$1,786	0.05	0.1503	\$1,340.28
52	2067	0.2014	4,135	\$833	197	\$40	4,588	\$924	8,920	\$1,797	0.05	0.1514	\$1,350.62
53	2068	0.2026	4,135	\$838	197	\$40	4,588	\$929	8,920	\$1,807	0.05	0.1526	\$1,361.01
54	2069	0.2038	4,135	\$843	197	\$40	4,588	\$935	8,920	\$1,817	0.05	0.1538	\$1,371.46
55	2070	0.2049	4,135	\$847	197	\$40	4,588	\$940	8,920	\$1,828	0.05	0.1549	\$1,381.98
56	2071	0.2061	4,135	\$852	197	\$41	4,588	\$946	8,920	\$1,839	0.05	0.1561	\$1,392.55
57	2072	0.2073	4,135	\$857	197	\$41	4,588	\$951	8,920	\$1,849	0.05	0.1573	\$1,403.19
58	2073	0.2085	4,135	\$862	197	\$41	4,588	\$957	8,920	\$1,860	0.05	0.1585	\$1,413.89
59	2074	0.2097	4,135	\$867	197	\$41	4,588	\$962	8,920	\$1,871	0.05	0.1597	\$1,424.64
60	2075	0.2109	4,135	\$872	197	\$42	4,588	\$968	8,920	\$1,881	0.05	0.1609	\$1,435.47

Table D2-1.1: Annual Operating Costs (V.GSHP) of a 2,000 square feet detached house above grade (improved construction type) in the city of Cambridge (two life cycles and three life cycles for a 60 year project lifespan); base case scenario in comparison with feed in-tariff (FIT) scenario. In the FIT scenario, an incentive of \$0.05/KWh is provided on electricity bills throughout the project lifespan

Horizontal Ground Source Heat Pump (H.GSHP)

Base Case Scenario											Feed in Tariff (FIT)		
H.GSHP											FIT		
#	Year	Electricity Rates \$/KWh	Heating KWh	Heating Operating Cost \$	Cooling KWh	Cooling Operating Cost \$	Hot Water KWh	Hot Water Operating Cost \$	Total KWh	Total Operating Cost \$	Incentives (\$/KWh)	\$/KWh	Operating Cost
1	2016	0.1501	4,201	\$630	202	\$30	4,591	\$689	8,994	\$1,350	0.05	0.1001	\$900.14
2	2017	0.1542	4,201	\$648	202	\$31	4,591	\$708	8,994	\$1,387	0.05	0.1042	\$937.06
3	2018	0.1583	4,201	\$665	202	\$32	4,591	\$727	8,994	\$1,424	0.05	0.1083	\$973.97
4	2019	0.1625	4,201	\$683	202	\$33	4,591	\$746	8,994	\$1,462	0.05	0.1125	\$1,012.17
5	2020	0.1668	4,201	\$701	202	\$34	4,591	\$766	8,994	\$1,500	0.05	0.1168	\$1,050.38
6	2021	0.1621	4,201	\$681	202	\$33	4,591	\$744	8,994	\$1,458	0.05	0.1121	\$1,008.61
7	2022	0.1629	4,201	\$684	202	\$33	4,591	\$744	8,994	\$1,458	0.05	0.1129	\$1,015.73
8	2023	0.1639	4,201	\$688	202	\$33	4,591	\$752	8,994	\$1,474	0.05	0.1139	\$1,024.15
9	2024	0.1648	4,201	\$692	202	\$33	4,591	\$757	8,994	\$1,482	0.05	0.1148	\$1,032.57
10	2025	0.1656	4,201	\$696	202	\$33	4,591	\$760	8,994	\$1,489	0.05	0.1156	\$1,039.69
11	2026	0.1665	4,201	\$700	202	\$34	4,591	\$765	8,994	\$1,498	0.05	0.1165	\$1,048.11
12	2027	0.1674	4,201	\$703	202	\$34	4,591	\$769	8,994	\$1,506	0.05	0.1174	\$1,056.21
13	2028	0.1683	4,201	\$707	202	\$34	4,591	\$772	8,994	\$1,513	0.05	0.1183	\$1,063.65
14	2029	0.1692	4,201	\$711	202	\$34	4,591	\$777	8,994	\$1,521	0.05	0.1192	\$1,071.75
15	2030	0.1701	4,201	\$715	202	\$34	4,591	\$781	8,994	\$1,530	0.05	0.1201	\$1,080.17
16	2031	0.1704	4,201	\$716	202	\$34	4,591	\$782	8,994	\$1,532	0.05	0.1204	\$1,082.43
17	2032	0.1705	4,201	\$716	202	\$34	4,591	\$783	8,994	\$1,533	0.05	0.1205	\$1,083.73
18	2033	0.1707	4,201	\$717	202	\$34	4,591	\$784	8,994	\$1,536	0.05	0.1207	\$1,086.00
19	2034	0.1710	4,201	\$719	202	\$35	4,591	\$785	8,994	\$1,538	0.05	0.1210	\$1,088.59
20	2035	0.1713	4,201	\$720	202	\$35	4,591	\$786	8,994	\$1,541	0.05	0.1213	\$1,090.85
21	2036	0.1714	4,201	\$720	202	\$35	4,591	\$787	8,994	\$1,542	0.05	0.1214	\$1,092.15
22	2037	0.1717	4,201	\$721	202	\$35	4,591	\$788	8,994	\$1,544	0.05	0.1217	\$1,094.41
23	2038	0.1720	4,201	\$722	202	\$35	4,591	\$790	8,994	\$1,547	0.05	0.1220	\$1,097.00
24	2039	0.1722	4,201	\$724	202	\$35	4,591	\$791	8,994	\$1,549	0.05	0.1222	\$1,099.27
25	2040	0.1724	4,201	\$724	202	\$35	4,591	\$791	8,994	\$1,550	0.05	0.1224	\$1,100.57
26	2041	0.1734	4,201	\$728	202	\$35	4,591	\$796	8,994	\$1,559	0.05	0.1234	\$1,109.53
27	2042	0.1744	4,201	\$733	202	\$35	4,591	\$801	8,994	\$1,568	0.05	0.1244	\$1,118.55
28	2043	0.1754	4,201	\$737	202	\$35	4,591	\$805	8,994	\$1,577	0.05	0.1254	\$1,127.63
29	2044	0.1764	4,201	\$741	202	\$36	4,591	\$810	8,994	\$1,586	0.05	0.1264	\$1,136.75
30	2045	0.1774	4,201	\$745	202	\$36	4,591	\$814	8,994	\$1,596	0.05	0.1274	\$1,145.93
31	2046	0.1784	4,201	\$750	202	\$36	4,591	\$819	8,994	\$1,605	0.05	0.1284	\$1,155.16
32	2047	0.1795	4,201	\$754	202	\$36	4,591	\$824	8,994	\$1,614	0.05	0.1295	\$1,164.44
33	2048	0.1805	4,201	\$758	202	\$36	4,591	\$829	8,994	\$1,623	0.05	0.1305	\$1,173.78
34	2049	0.1816	4,201	\$763	202	\$37	4,591	\$834	8,994	\$1,633	0.05	0.1316	\$1,183.17
35	2050	0.1826	4,201	\$767	202	\$37	4,591	\$838	8,994	\$1,642	0.05	0.1326	\$1,192.62
36	2051	0.1837	4,201	\$772	202	\$37	4,591	\$843	8,994	\$1,652	0.05	0.1337	\$1,202.12
37	2052	0.1847	4,201	\$776	202	\$37	4,591	\$848	8,994	\$1,661	0.05	0.1347	\$1,211.67
38	2053	0.1858	4,201	\$780	202	\$38	4,591	\$853	8,994	\$1,671	0.05	0.1358	\$1,221.28
39	2054	0.1869	4,201	\$785	202	\$38	4,591	\$858	8,994	\$1,681	0.05	0.1369	\$1,230.95
40	2055	0.1879	4,201	\$790	202	\$38	4,591	\$863	8,994	\$1,690	0.05	0.1379	\$1,240.67
41	2056	0.1890	4,201	\$794	202	\$38	4,591	\$868	8,994	\$1,700	0.05	0.1390	\$1,250.45
42	2057	0.1901	4,201	\$799	202	\$38	4,591	\$873	8,994	\$1,710	0.05	0.1401	\$1,260.29
43	2058	0.1912	4,201	\$803	202	\$39	4,591	\$878	8,994	\$1,720	0.05	0.1412	\$1,270.18
44	2059	0.1923	4,201	\$808	202	\$39	4,591	\$883	8,994	\$1,730	0.05	0.1423	\$1,280.13
45	2060	0.1934	4,201	\$813	202	\$39	4,591	\$888	8,994	\$1,740	0.05	0.1434	\$1,290.13
46	2061	0.1946	4,201	\$817	202	\$39	4,591	\$893	8,994	\$1,750	0.05	0.1446	\$1,300.20
47	2062	0.1957	4,201	\$822	202	\$40	4,591	\$898	8,994	\$1,760	0.05	0.1457	\$1,310.32
48	2063	0.1968	4,201	\$827	202	\$40	4,591	\$904	8,994	\$1,770	0.05	0.1468	\$1,320.50
49	2064	0.1980	4,201	\$832	202	\$40	4,591	\$909	8,994	\$1,780	0.05	0.1480	\$1,330.74
50	2065	0.1991	4,201	\$836	202	\$40	4,591	\$914	8,994	\$1,791	0.05	0.1491	\$1,341.04
51	2066	0.2003	4,201	\$841	202	\$40	4,591	\$919	8,994	\$1,801	0.05	0.1503	\$1,351.40
52	2067	0.2014	4,201	\$846	202	\$41	4,591	\$925	8,994	\$1,812	0.05	0.1514	\$1,361.82
53	2068	0.2026	4,201	\$851	202	\$41	4,591	\$930	8,994	\$1,822	0.05	0.1526	\$1,372.30
54	2069	0.2038	4,201	\$856	202	\$41	4,591	\$935	8,994	\$1,833	0.05	0.1538	\$1,382.84
55	2070	0.2049	4,201	\$861	202	\$41	4,591	\$941	8,994	\$1,843	0.05	0.1549	\$1,393.44
56	2071	0.2061	4,201	\$866	202	\$42	4,591	\$946	8,994	\$1,854	0.05	0.1561	\$1,404.10
57	2072	0.2073	4,201	\$871	202	\$42	4,591	\$952	8,994	\$1,865	0.05	0.1573	\$1,414.83
58	2073	0.2085	4,201	\$876	202	\$42	4,591	\$957	8,994	\$1,875	0.05	0.1585	\$1,425.61
59	2074	0.2097	4,201	\$881	202	\$42	4,591	\$963	8,994	\$1,886	0.05	0.1597	\$1,436.46
60	2075	0.2109	4,201	\$886	202	\$43	4,591	\$968	8,994	\$1,897	0.05	0.1609	\$1,447.37

Table D2-1.2: Annual Operating Costs (H.GSHP) of a 2,000 square feet detached house above grade (improved construction type) in the city of Cambridge (two life cycles and three life cycles for a 60 year project lifespan); base case scenario in comparison with feed in-tariff (FIT) scenario. In the FIT scenario, an incentive of \$0.05/KWh is provided on electricity bills throughout the project lifespan

Traditional HVAC Applications

Base Case Scenario															Carbon Taxes								
#	Year	Traditional												Total	Total	Total Electricity Operating Cost	Total Natural Gas Operating Cost	Total	Conversion of m ³ into Tons	Total Tons	Carbon Tax	Operating Costs	
		Electricity Rates	Natural Gas Rates	Heating		Heating Operating Cost	Heating Operating Cost	Total Heating Operating Cost	Cooling		Hot Water	Hot Water Operating Cost	Total										Total
				KWh (Electricity)	m ³ (Gas)				\$ (Electricity)	\$ (Gas)													
\$/KWh	\$/m ³																						
1	2016	0.1501	0.3458	1,408	2,040	\$211	\$705	\$917	796	\$119	1,029	\$356	2,204	3,069	331	\$1,061	\$1,392	5.55	5.55	\$10	\$55.55	\$1,447.68	
2	2017	0.1542	0.3588	1,408	2,040	\$217	\$732	\$949	796	\$123	1,029	\$159	2,204	3,069	340	\$1,101	\$1,441	5.55	5.55	\$20	\$111.10	\$1,552.20	
3	2018	0.1583	0.3718	1,408	2,040	\$223	\$759	\$981	796	\$126	1,029	\$163	2,204	3,069	349	\$1,141	\$1,490	5.55	5.55	\$30	\$166.65	\$1,656.71	
4	2019	0.1625	0.3776	1,408	2,040	\$229	\$770	\$999	796	\$129	1,029	\$167	2,204	3,069	358	\$1,159	\$1,517	5.55	5.55	\$40	\$222.20	\$1,739.23	
5	2020	0.1668	0.3841	1,408	2,040	\$235	\$784	\$1,018	796	\$132	1,029	\$172	2,204	3,069	368	\$1,179	\$1,546	5.55	5.55	\$50	\$277.74	\$1,824.10	
6	2021	0.1621	0.3883	1,408	2,040	\$228	\$792	\$1,020	796	\$129	1,029	\$167	2,204	3,069	357	\$1,192	\$1,549	5.55	5.55	\$60	\$333.29	\$1,882.33	
7	2022	0.1629	0.3929	1,408	2,040	\$229	\$801	\$1,031	796	\$130	1,029	\$168	2,204	3,069	359	\$1,206	\$1,565	5.55	5.55	\$70	\$388.84	\$1,953.71	
8	2023	0.1639	0.3967	1,408	2,040	\$231	\$809	\$1,040	796	\$130	1,029	\$169	2,204	3,069	361	\$1,218	\$1,579	5.55	5.55	\$80	\$444.39	\$2,023.07	
9	2024	0.1648	0.4005	1,408	2,040	\$232	\$817	\$1,049	796	\$131	1,029	\$170	2,204	3,069	363	\$1,229	\$1,592	5.55	5.55	\$90	\$499.94	\$2,092.42	
10	2025	0.1656	0.4040	1,408	2,040	\$233	\$824	\$1,057	796	\$132	1,029	\$170	2,204	3,069	365	\$1,240	\$1,605	5.55	5.55	\$100	\$555.49	\$2,160.28	
11	2026	0.1665	0.4070	1,408	2,040	\$234	\$830	\$1,065	796	\$133	1,029	\$171	2,204	3,069	367	\$1,249	\$1,616	5.55	5.55	\$110	\$611.04	\$2,227.28	
12	2027	0.1674	0.4097	1,408	2,040	\$236	\$836	\$1,072	796	\$133	1,029	\$172	2,204	3,069	369	\$1,257	\$1,626	5.55	5.55	\$120	\$666.59	\$2,293.03	
13	2028	0.1683	0.4124	1,408	2,040	\$237	\$841	\$1,078	796	\$134	1,029	\$173	2,204	3,069	371	\$1,266	\$1,636	5.55	5.55	\$130	\$722.14	\$2,358.63	
14	2029	0.1692	0.4151	1,408	2,040	\$238	\$847	\$1,085	796	\$135	1,029	\$174	2,204	3,069	373	\$1,274	\$1,647	5.55	5.55	\$140	\$777.68	\$2,424.38	
15	2030	0.1701	0.4170	1,408	2,040	\$239	\$851	\$1,090	796	\$135	1,029	\$175	2,204	3,069	375	\$1,280	\$1,655	5.55	5.55	\$150	\$833.23	\$2,487.86	
16	2031	0.1704	0.4189	1,408	2,040	\$240	\$855	\$1,094	796	\$136	1,029	\$175	2,204	3,069	375	\$1,286	\$1,661	5.55	5.55	\$160	\$888.78	\$2,549.83	
17	2032	0.1705	0.4204	1,408	2,040	\$240	\$858	\$1,098	796	\$136	1,029	\$175	2,204	3,069	376	\$1,290	\$1,666	5.55	5.55	\$170	\$944.33	\$2,610.40	
18	2033	0.1707	0.4223	1,408	2,040	\$240	\$862	\$1,102	796	\$136	1,029	\$176	2,204	3,069	376	\$1,296	\$1,672	5.55	5.55	\$180	\$999.88	\$2,672.37	
19	2034	0.1710	0.4246	1,408	2,040	\$241	\$866	\$1,107	796	\$136	1,029	\$176	2,204	3,069	377	\$1,303	\$1,680	5.55	5.55	\$190	\$1,055.43	\$2,735.60	
20	2035	0.1713	0.4265	1,408	2,040	\$241	\$870	\$1,111	796	\$136	1,029	\$176	2,204	3,069	378	\$1,309	\$1,687	5.55	5.55	\$200	\$1,110.98	\$2,797.57	
21	2036	0.1714	0.4288	1,408	2,040	\$241	\$875	\$1,116	796	\$136	1,029	\$176	2,204	3,069	378	\$1,316	\$1,694	5.55	5.55	\$210	\$1,166.53	\$2,860.48	
22	2037	0.1717	0.4311	1,408	2,040	\$242	\$880	\$1,121	796	\$137	1,029	\$177	2,204	3,069	378	\$1,323	\$1,702	5.55	5.55	\$220	\$1,222.08	\$2,923.63	
23	2038	0.1720	0.4331	1,408	2,040	\$242	\$883	\$1,126	796	\$137	1,029	\$177	2,204	3,069	379	\$1,329	\$1,708	5.55	5.55	\$230	\$1,277.62	\$2,985.69	
24	2039	0.1722	0.4353	1,408	2,040	\$242	\$888	\$1,131	796	\$137	1,029	\$177	2,204	3,069	380	\$1,336	\$1,716	5.55	5.55	\$240	\$1,333.17	\$3,048.84	
25	2040	0.1724	0.4376	1,408	2,040	\$243	\$893	\$1,135	796	\$137	1,029	\$177	2,204	3,069	380	\$1,343	\$1,723	5.55	5.55	\$250	\$1,388.72	\$3,111.75	
26	2041	0.1734	0.4420	1,408	2,040	\$244	\$902	\$1,146	796	\$138	1,029	\$178	2,204	3,069	382	\$1,356	\$1,738	5.55	5.55	\$260	\$1,444.27	\$3,182.73	
27	2042	0.1744	0.4463	1,408	2,040	\$246	\$910	\$1,156	796	\$139	1,029	\$179	2,204	3,069	384	\$1,370	\$1,754	5.55	5.55	\$270	\$1,499.82	\$3,253.87	
28	2043	0.1754	0.4507	1,408	2,040	\$247	\$919	\$1,166	796	\$140	1,029	\$180	2,204	3,069	387	\$1,383	\$1,770	5.55	5.55	\$280	\$1,555.37	\$3,325.14	
29	2044	0.1764	0.4552	1,408	2,040	\$248	\$929	\$1,177	796	\$140	1,029	\$182	2,204	3,069	389	\$1,397	\$1,786	5.55	5.55	\$290	\$1,610.92	\$3,396.57	
30	2045	0.1774	0.4596	1,408	2,040	\$250	\$938	\$1,187	796	\$141	1,029	\$183	2,204	3,069	391	\$1,411	\$1,802	5.55	5.55	\$300	\$1,666.47	\$3,468.13	
31	2046	0.1784	0.4642	1,408	2,040	\$251	\$947	\$1,198	796	\$142	1,029	\$184	2,204	3,069	393	\$1,425	\$1,818	5.55	5.55	\$310	\$1,722.02	\$3,539.85	
32	2047	0.1795	0.4688	1,408	2,040	\$253	\$956	\$1,209	796	\$143	1,029	\$185	2,204	3,069	396	\$1,439	\$1,834	5.55	5.55	\$320	\$1,777.56	\$3,611.72	
33	2048	0.1805	0.4734	1,408	2,040	\$254	\$966	\$1,220	796	\$144	1,029	\$186	2,204	3,069	398	\$1,453	\$1,851	5.55	5.55	\$330	\$1,833.11	\$3,683.74	
34	2049	0.1816	0.4780	1,408	2,040	\$256	\$975	\$1,231	796	\$145	1,029	\$187	2,204	3,069	400	\$1,467	\$1,867	5.55	5.55	\$340	\$1,888.66	\$3,755.92	
35	2050	0.1826	0.4828	1,408	2,040	\$257	\$985	\$1,242	796	\$145	1,029	\$188	2,204	3,069	402	\$1,482	\$1,884	5.55	5.55	\$350	\$1,944.21	\$3,828.24	
36	2051	0.1837	0.4875	1,408	2,040	\$259	\$995	\$1,253	796	\$146	1,029	\$189	2,204	3,069	405	\$1,496	\$1,901	5.55	5.55	\$360	\$1,999.76	\$3,900.73	
37	2052	0.1847	0.4923	1,408	2,040	\$260	\$1,004	\$1,264	796	\$147	1,029	\$190	2,204	3,069	407	\$1,511	\$1,918	5.55	5.55	\$370	\$2,055.31	\$3,973.37	
38	2053	0.1858	0.4972	1,408	2,040	\$262	\$1,014	\$1,276	796	\$148	1,029	\$191	2,204	3,069	409	\$1,526	\$1,935	5.55	5.55	\$380	\$2,110.86	\$4,046.17	
39	2054	0.1869	0.5021	1,408	2,040	\$263	\$1,024	\$1,287	796	\$149	1,029	\$192	2,204	3,069	412	\$1,541	\$1,953	5.55	5.55	\$390	\$2,166.41	\$4,119.13	
40	2055	0.1879	0.5070	1,408	2,040	\$265	\$1,034	\$1,299	796	\$150	1,029	\$193	2,204	3,069	414	\$1,556	\$1,970	5.55	5.55	\$400	\$2,221.96	\$4,192.25	
41	2056	0.1890	0.5120	1,408	2,040	\$266	\$1,045	\$1,311	796	\$150	1,029	\$195	2,204	3,069	417	\$1,571	\$1,988	5.55	5.55	\$410	\$2,277.50	\$4,265.54	
42	2057	0.1901	0.5171	1,408	2,040	\$268	\$1,055	\$1,323	796	\$151	1,029	\$196	2,204	3,069	419	\$1,587	\$2,006	5.55	5.55	\$420	\$2,333.05	\$4,338.99	
43	2058	0.1912	0.5222	1,408	2,040	\$269	\$1,065	\$1,334	796	\$152	1,029	\$197	2,204	3,069	421	\$1,603	\$2,024	5.55	5.55	\$430	\$2,388.60	\$4,412.61	
44	2059	0.1923	0.5273	1,408	2,040	\$271	\$1,076	\$1,347	796	\$153	1,029	\$198	2,204	3,069	424	\$1,618	\$2,042	5.55	5.55	\$440	\$2,444.15	\$4,486.40	
45	2060	0.1934	0.5325	1,408	2,040	\$272	\$1,086	\$1,359	796	\$154	1,029	\$199	2,204	3,069	426	\$1,634	\$2,061	5.55	5.55	\$450	\$2,499.70	\$4,560.35	
46	2061	0.1946	0.5378	1,408	2,040	\$274	\$1,097	\$1,371	796	\$155	1,029	\$200	2,204	3,069	429	\$1,650	\$2,079	5.55	5.55	\$460	\$2,555.25	\$4,634.48	
47	2062	0.1957	0.5431	1,408	2,040	\$276	\$1,108	\$1,383	796	\$156	1,029	\$201	2,204	3,069	431	\$1,667	\$2,098	5.55	5.55	\$470	\$2,610.80	\$4,708.78	
48	2063	0.1968	0.5484	1,408	2,040	\$277	\$1,119	\$1,396	796	\$157	1,029	\$203	2,204	3,069	434	\$1,683	\$2,117	5.55	5.55	\$480	\$2,666.35	\$4,783.26	
49	2064	0.1980	0.5538	1,408	2,040	\$279	\$1,130	\$1,409	796	\$158	1,029	\$204	2,204	3,069	436	\$1,700	\$2,136	5.55	5.55	\$490	\$2,721.90	\$4,857.91	
50	2065	0.1991	0.5593	1,408	2,040	\$280	\$1,141	\$1,421	796	\$158	1,029	\$205	2,204	3,069	439	\$1,716	\$2,155	5.55	5.55	\$500	\$2,777.45	\$4,932.74	
51	2066	0.2003	0.5648	1,408	2,040	\$282	\$1,152	\$1,434	796	\$159	1,029	\$206	2,204	3,069	441	\$1,733	\$2,175	5.55	5.55	\$510	\$2,832.99	\$5,007.75	
52	2067	0.2014	0.5704	1,408	2,040	\$284	\$1,164	\$1,447	796	\$160	1,029	\$207	2,204	3,069	444	\$1,750	\$2,194	5.55	5.55	\$520	\$2,888.54	\$5,082.94	
53	2068	0.2026	0.5760	1,408	2,040	\$285	\$1,175	\$1,460	796	\$161	1,029	\$208	2,204	3,069	446	\$1,768	\$2,214	5.55	5.55	\$530	\$2,944.09		

2. Chatham (South) – Annual Operating Costs

Vertical Ground Source Heat Pump (V.GSHP)

Base Case Scenario												Feed in Tariff (FIT)		
V.GSHP												FIT		
#	Year	Electricity Rates	Heating	Heating Operating Cost	Cooling	Cooling Operating Cost	Hot Water	Hot Water Operating Cost	Total	Total Operating Cost	Incentives (\$/KWh)	FIT		
		\$/KWh	KWh	\$	KWh	\$	KWh	\$	KWh	\$		Operating Cost	Operating Cost	
1	2016	0.1501	3,430	\$515	393	\$59	4,529	\$680	8,352	\$1,253	0.05	0.1001	\$835.89	
2	2017	0.1542	3,430	\$529	393	\$61	4,529	\$698	8,352	\$1,288	0.05	0.1042	\$870.17	
3	2018	0.1583	3,430	\$543	393	\$62	4,529	\$717	8,352	\$1,322	0.05	0.1083	\$904.44	
4	2019	0.1625	3,430	\$558	393	\$64	4,529	\$736	8,352	\$1,358	0.05	0.1125	\$939.92	
5	2020	0.1668	3,430	\$572	393	\$66	4,529	\$755	8,352	\$1,393	0.05	0.1168	\$975.40	
6	2021	0.1621	3,430	\$556	393	\$64	4,529	\$734	8,352	\$1,354	0.05	0.1121	\$936.62	
7	2022	0.1629	3,430	\$559	393	\$64	4,529	\$738	8,352	\$1,361	0.05	0.1129	\$943.23	
8	2023	0.1639	3,430	\$562	393	\$64	4,529	\$742	8,352	\$1,369	0.05	0.1139	\$951.05	
9	2024	0.1648	3,430	\$565	393	\$65	4,529	\$746	8,352	\$1,376	0.05	0.1148	\$958.87	
10	2025	0.1656	3,430	\$568	393	\$65	4,529	\$750	8,352	\$1,383	0.05	0.1156	\$965.48	
11	2026	0.1665	3,430	\$571	393	\$65	4,529	\$754	8,352	\$1,391	0.05	0.1165	\$973.30	
12	2027	0.1674	3,430	\$574	393	\$66	4,529	\$758	8,352	\$1,398	0.05	0.1174	\$980.81	
13	2028	0.1683	3,430	\$577	393	\$66	4,529	\$762	8,352	\$1,405	0.05	0.1183	\$987.73	
14	2029	0.1692	3,430	\$580	393	\$66	4,529	\$766	8,352	\$1,413	0.05	0.1192	\$995.25	
15	2030	0.1701	3,430	\$583	393	\$67	4,529	\$770	8,352	\$1,421	0.05	0.1201	\$1,003.06	
16	2031	0.1704	3,430	\$584	393	\$67	4,529	\$772	8,352	\$1,423	0.05	0.1204	\$1,005.17	
17	2032	0.1705	3,430	\$585	393	\$67	4,529	\$772	8,352	\$1,424	0.05	0.1205	\$1,006.37	
18	2033	0.1707	3,430	\$586	393	\$67	4,529	\$773	8,352	\$1,426	0.05	0.1207	\$1,008.48	
19	2034	0.1710	3,430	\$587	393	\$67	4,529	\$775	8,352	\$1,428	0.05	0.1210	\$1,010.88	
20	2035	0.1713	3,430	\$588	393	\$67	4,529	\$776	8,352	\$1,431	0.05	0.1213	\$1,012.99	
21	2036	0.1714	3,430	\$588	393	\$67	4,529	\$776	8,352	\$1,432	0.05	0.1214	\$1,014.19	
22	2037	0.1717	3,430	\$589	393	\$67	4,529	\$778	8,352	\$1,434	0.05	0.1217	\$1,016.29	
23	2038	0.1720	3,430	\$590	393	\$68	4,529	\$779	8,352	\$1,436	0.05	0.1220	\$1,018.70	
24	2039	0.1722	3,430	\$591	393	\$68	4,529	\$780	8,352	\$1,438	0.05	0.1222	\$1,020.80	
25	2040	0.1724	3,430	\$591	393	\$68	4,529	\$781	8,352	\$1,440	0.05	0.1224	\$1,022.01	
26	2041	0.1734	3,430	\$595	393	\$68	4,529	\$785	8,352	\$1,448	0.05	0.1234	\$1,030.33	
27	2042	0.1744	3,430	\$598	393	\$69	4,529	\$790	8,352	\$1,456	0.05	0.1244	\$1,038.71	
28	2043	0.1754	3,430	\$602	393	\$69	4,529	\$794	8,352	\$1,465	0.05	0.1254	\$1,047.13	
29	2044	0.1764	3,430	\$605	393	\$69	4,529	\$799	8,352	\$1,473	0.05	0.1264	\$1,055.61	
30	2045	0.1774	3,430	\$609	393	\$70	4,529	\$803	8,352	\$1,482	0.05	0.1274	\$1,064.13	
31	2046	0.1784	3,430	\$612	393	\$70	4,529	\$808	8,352	\$1,490	0.05	0.1284	\$1,072.70	
32	2047	0.1795	3,430	\$616	393	\$71	4,529	\$813	8,352	\$1,499	0.05	0.1295	\$1,081.32	
33	2048	0.1805	3,430	\$619	393	\$71	4,529	\$818	8,352	\$1,508	0.05	0.1305	\$1,089.99	
34	2049	0.1816	3,430	\$623	393	\$71	4,529	\$822	8,352	\$1,516	0.05	0.1316	\$1,098.72	
35	2050	0.1826	3,430	\$626	393	\$72	4,529	\$827	8,352	\$1,525	0.05	0.1326	\$1,107.49	
36	2051	0.1837	3,430	\$630	393	\$72	4,529	\$832	8,352	\$1,534	0.05	0.1337	\$1,116.31	
37	2052	0.1847	3,430	\$634	393	\$73	4,529	\$837	8,352	\$1,543	0.05	0.1347	\$1,125.18	
38	2053	0.1858	3,430	\$637	393	\$73	4,529	\$841	8,352	\$1,552	0.05	0.1358	\$1,134.11	
39	2054	0.1869	3,430	\$641	393	\$73	4,529	\$846	8,352	\$1,561	0.05	0.1369	\$1,143.08	
40	2055	0.1879	3,430	\$645	393	\$74	4,529	\$851	8,352	\$1,570	0.05	0.1379	\$1,152.11	
41	2056	0.1890	3,430	\$648	393	\$74	4,529	\$856	8,352	\$1,579	0.05	0.1390	\$1,161.19	
42	2057	0.1901	3,430	\$652	393	\$75	4,529	\$861	8,352	\$1,588	0.05	0.1401	\$1,170.33	
43	2058	0.1912	3,430	\$656	393	\$75	4,529	\$866	8,352	\$1,597	0.05	0.1412	\$1,179.51	
44	2059	0.1923	3,430	\$660	393	\$76	4,529	\$871	8,352	\$1,606	0.05	0.1423	\$1,188.75	
45	2060	0.1934	3,430	\$664	393	\$76	4,529	\$876	8,352	\$1,616	0.05	0.1434	\$1,198.04	
46	2061	0.1946	3,430	\$667	393	\$76	4,529	\$881	8,352	\$1,625	0.05	0.1446	\$1,207.39	
47	2062	0.1957	3,430	\$671	393	\$77	4,529	\$886	8,352	\$1,634	0.05	0.1457	\$1,216.79	
48	2063	0.1968	3,430	\$675	393	\$77	4,529	\$891	8,352	\$1,644	0.05	0.1468	\$1,226.24	
49	2064	0.1980	3,430	\$679	393	\$78	4,529	\$897	8,352	\$1,653	0.05	0.1480	\$1,235.75	
50	2065	0.1991	3,430	\$683	393	\$78	4,529	\$902	8,352	\$1,663	0.05	0.1491	\$1,245.32	
51	2066	0.2003	3,430	\$687	393	\$79	4,529	\$907	8,352	\$1,673	0.05	0.1503	\$1,254.94	
52	2067	0.2014	3,430	\$691	393	\$79	4,529	\$912	8,352	\$1,682	0.05	0.1514	\$1,264.61	
53	2068	0.2026	3,430	\$695	393	\$80	4,529	\$917	8,352	\$1,692	0.05	0.1526	\$1,274.35	
54	2069	0.2038	3,430	\$699	393	\$80	4,529	\$923	8,352	\$1,702	0.05	0.1538	\$1,284.13	
55	2070	0.2049	3,430	\$703	393	\$81	4,529	\$928	8,352	\$1,712	0.05	0.1549	\$1,293.98	
56	2071	0.2061	3,430	\$707	393	\$81	4,529	\$933	8,352	\$1,721	0.05	0.1561	\$1,303.88	
57	2072	0.2073	3,430	\$711	393	\$81	4,529	\$939	8,352	\$1,731	0.05	0.1573	\$1,313.84	
58	2073	0.2085	3,430	\$715	393	\$82	4,529	\$944	8,352	\$1,741	0.05	0.1585	\$1,323.85	
59	2074	0.2097	3,430	\$719	393	\$82	4,529	\$950	8,352	\$1,752	0.05	0.1597	\$1,333.93	
60	2075	0.2109	3,430	\$723	393	\$83	4,529	\$955	8,352	\$1,762	0.05	0.1609	\$1,344.06	

Table D2-1.4: Annual Operating Costs (V.GSHP) of a 2,000 square feet detached house above grade (improved construction type) in the city of Chatham (two life cycles and three life cycles for a 60 year project lifespan); base case scenario in comparison with feed in-tariff (FIT) scenario. In the FIT scenario, an incentive of \$0.05/KWh is provided on electricity bills throughout the project lifespan

Horizontal Ground Source Heat Pump (H.GSHP)

Base Case Scenario											Feed in Tariff (FIT)		
H.GSHP											FIT		
#	Year	Electricity Rates \$/KWh	Heating KWh	Heating Operating Cost \$	Cooling KWh	Cooling Operating Cost \$	Hot Water KWh	Hot Water Operating Cost \$	Total KWh	Total Operating Cost \$	Incentives (\$/KWh)	S/KWh	Operating Cost
1	2016	0.1501	3,495	\$525	401	\$60	4,527	\$679	8,423	\$1,264	0.05	0.1001	\$843.00
2	2017	0.1542	3,495	\$539	401	\$62	4,527	\$698	8,423	\$1,299	0.05	0.1042	\$877.57
3	2018	0.1583	3,495	\$553	401	\$63	4,527	\$717	8,423	\$1,333	0.05	0.1083	\$912.13
4	2019	0.1625	3,495	\$568	401	\$65	4,527	\$736	8,423	\$1,369	0.05	0.1125	\$947.91
5	2020	0.1668	3,495	\$583	401	\$67	4,527	\$755	8,423	\$1,405	0.05	0.1168	\$983.69
6	2021	0.1621	3,495	\$567	401	\$65	4,527	\$734	8,423	\$1,366	0.05	0.1121	\$944.58
7	2022	0.1629	3,495	\$569	401	\$65	4,527	\$738	8,423	\$1,372	0.05	0.1129	\$951.25
8	2023	0.1639	3,495	\$573	401	\$66	4,527	\$742	8,423	\$1,380	0.05	0.1139	\$959.13
9	2024	0.1648	3,495	\$576	401	\$66	4,527	\$746	8,423	\$1,388	0.05	0.1148	\$967.02
10	2025	0.1656	3,495	\$579	401	\$66	4,527	\$750	8,423	\$1,395	0.05	0.1156	\$973.69
11	2026	0.1665	3,495	\$582	401	\$66	4,527	\$754	8,423	\$1,403	0.05	0.1165	\$981.57
12	2027	0.1674	3,495	\$585	401	\$67	4,527	\$758	8,423	\$1,410	0.05	0.1174	\$989.15
13	2028	0.1683	3,495	\$588	401	\$67	4,527	\$762	8,423	\$1,417	0.05	0.1183	\$996.13
14	2029	0.1692	3,495	\$591	401	\$68	4,527	\$766	8,423	\$1,425	0.05	0.1192	\$1,003.71
15	2030	0.1701	3,495	\$594	401	\$68	4,527	\$770	8,423	\$1,433	0.05	0.1201	\$1,011.59
16	2031	0.1704	3,495	\$595	401	\$68	4,527	\$771	8,423	\$1,435	0.05	0.1204	\$1,013.71
17	2032	0.1705	3,495	\$596	401	\$68	4,527	\$772	8,423	\$1,436	0.05	0.1205	\$1,014.93
18	2033	0.1707	3,495	\$597	401	\$68	4,527	\$773	8,423	\$1,438	0.05	0.1207	\$1,017.05
19	2034	0.1710	3,495	\$598	401	\$69	4,527	\$774	8,423	\$1,441	0.05	0.1210	\$1,019.47
20	2035	0.1713	3,495	\$599	401	\$69	4,527	\$775	8,423	\$1,443	0.05	0.1213	\$1,021.60
21	2036	0.1714	3,495	\$599	401	\$69	4,527	\$776	8,423	\$1,444	0.05	0.1214	\$1,022.81
22	2037	0.1717	3,495	\$600	401	\$69	4,527	\$777	8,423	\$1,446	0.05	0.1217	\$1,024.93
23	2038	0.1720	3,495	\$601	401	\$69	4,527	\$779	8,423	\$1,449	0.05	0.1220	\$1,027.36
24	2039	0.1722	3,495	\$602	401	\$69	4,527	\$780	8,423	\$1,451	0.05	0.1222	\$1,029.48
25	2040	0.1724	3,495	\$602	401	\$69	4,527	\$780	8,423	\$1,452	0.05	0.1224	\$1,030.69
26	2041	0.1734	3,495	\$606	401	\$70	4,527	\$785	8,423	\$1,460	0.05	0.1234	\$1,039.09
27	2042	0.1744	3,495	\$609	401	\$70	4,527	\$789	8,423	\$1,469	0.05	0.1244	\$1,047.54
28	2043	0.1754	3,495	\$613	401	\$70	4,527	\$794	8,423	\$1,477	0.05	0.1254	\$1,056.04
29	2044	0.1764	3,495	\$616	401	\$71	4,527	\$799	8,423	\$1,486	0.05	0.1264	\$1,064.58
30	2045	0.1774	3,495	\$620	401	\$71	4,527	\$803	8,423	\$1,494	0.05	0.1274	\$1,073.18
31	2046	0.1784	3,495	\$624	401	\$72	4,527	\$808	8,423	\$1,503	0.05	0.1284	\$1,081.82
32	2047	0.1795	3,495	\$627	401	\$72	4,527	\$812	8,423	\$1,512	0.05	0.1295	\$1,090.52
33	2048	0.1805	3,495	\$631	401	\$72	4,527	\$817	8,423	\$1,520	0.05	0.1305	\$1,099.26
34	2049	0.1816	3,495	\$635	401	\$73	4,527	\$822	8,423	\$1,529	0.05	0.1316	\$1,108.06
35	2050	0.1826	3,495	\$638	401	\$73	4,527	\$827	8,423	\$1,538	0.05	0.1326	\$1,116.90
36	2051	0.1837	3,495	\$642	401	\$74	4,527	\$831	8,423	\$1,547	0.05	0.1337	\$1,125.80
37	2052	0.1847	3,495	\$646	401	\$74	4,527	\$836	8,423	\$1,556	0.05	0.1347	\$1,134.75
38	2053	0.1858	3,495	\$649	401	\$75	4,527	\$841	8,423	\$1,565	0.05	0.1358	\$1,143.75
39	2054	0.1869	3,495	\$653	401	\$75	4,527	\$846	8,423	\$1,574	0.05	0.1369	\$1,152.80
40	2055	0.1879	3,495	\$657	401	\$75	4,527	\$851	8,423	\$1,583	0.05	0.1379	\$1,161.91
41	2056	0.1890	3,495	\$661	401	\$76	4,527	\$856	8,423	\$1,592	0.05	0.1390	\$1,171.06
42	2057	0.1901	3,495	\$664	401	\$76	4,527	\$861	8,423	\$1,601	0.05	0.1401	\$1,180.27
43	2058	0.1912	3,495	\$668	401	\$77	4,527	\$866	8,423	\$1,611	0.05	0.1412	\$1,189.54
44	2059	0.1923	3,495	\$672	401	\$77	4,527	\$871	8,423	\$1,620	0.05	0.1423	\$1,198.86
45	2060	0.1934	3,495	\$676	401	\$78	4,527	\$876	8,423	\$1,629	0.05	0.1434	\$1,208.23
46	2061	0.1946	3,495	\$680	401	\$78	4,527	\$881	8,423	\$1,639	0.05	0.1446	\$1,217.65
47	2062	0.1957	3,495	\$684	401	\$78	4,527	\$886	8,423	\$1,648	0.05	0.1457	\$1,227.13
48	2063	0.1968	3,495	\$688	401	\$79	4,527	\$891	8,423	\$1,658	0.05	0.1468	\$1,236.67
49	2064	0.1980	3,495	\$692	401	\$79	4,527	\$896	8,423	\$1,667	0.05	0.1480	\$1,246.26
50	2065	0.1991	3,495	\$696	401	\$80	4,527	\$901	8,423	\$1,677	0.05	0.1491	\$1,255.91
51	2066	0.2003	3,495	\$700	401	\$80	4,527	\$907	8,423	\$1,687	0.05	0.1503	\$1,265.61
52	2067	0.2014	3,495	\$704	401	\$81	4,527	\$912	8,423	\$1,697	0.05	0.1514	\$1,275.36
53	2068	0.2026	3,495	\$708	401	\$81	4,527	\$917	8,423	\$1,706	0.05	0.1526	\$1,285.18
54	2069	0.2038	3,495	\$712	401	\$82	4,527	\$922	8,423	\$1,716	0.05	0.1538	\$1,295.05
55	2070	0.2049	3,495	\$716	401	\$82	4,527	\$928	8,423	\$1,726	0.05	0.1549	\$1,304.98
56	2071	0.2061	3,495	\$720	401	\$83	4,527	\$933	8,423	\$1,736	0.05	0.1561	\$1,314.96
57	2072	0.2073	3,495	\$725	401	\$83	4,527	\$938	8,423	\$1,746	0.05	0.1573	\$1,325.01
58	2073	0.2085	3,495	\$729	401	\$84	4,527	\$944	8,423	\$1,756	0.05	0.1585	\$1,335.11
59	2074	0.2097	3,495	\$733	401	\$84	4,527	\$949	8,423	\$1,766	0.05	0.1597	\$1,345.27
60	2075	0.2109	3,495	\$737	401	\$85	4,527	\$955	8,423	\$1,777	0.05	0.1609	\$1,355.49

Table D2-1.5: Annual Operating Costs (H.GSHP) of a 2,000 square feet detached house above grade (improved construction type) in the city of Chatham (two life cycles and three life cycles for a 60 year project lifespan); base case scenario in comparison with feed in-tariff (FIT) scenario. In the FIT scenario, an incentive of \$0.05/KWh is provided on electricity bills throughout the project lifespan

Traditional HVAC Applications

Base Case Scenario															Carbon Taxes							
#	Year	Electricity Rates	Natural Gas Rates	Traditional											Total	Conversion of m ³ into Tons	Total Tons	Carbon Tax	Operating Costs			
				Heating		Heating Operating Cost	Heating Operating Cost	Total Heating Operating Cost	Cooling	Cooling Operating Cost	Hot Water	Hot Water Operating Cost	Total	Total						Total Electricity Operating Cost	Total Natural Gas Operating Cost	
				KWh (Electricity)	m ³ (Gas)	\$ (Electricity)	\$ (Gas)	\$	KWh	\$	m ³	\$	KWh	m ³						\$(KWh)	\$(m ³)	
1	2016	0.1501	0.3458	1,392	1,756	\$209	\$607	\$816	1,730	\$260	1,003	\$347	3,122	2,759	469	\$954	\$1,423	4.99	4.99	\$10	\$49.94	\$1,472.64
2	2017	0.1542	0.3588	1,392	1,756	\$215	\$630	\$845	1,730	\$267	1,003	\$355	3,122	2,759	481	\$990	\$1,471	4.99	4.99	\$20	\$99.88	\$1,571.28
3	2018	0.1583	0.3718	1,392	1,756	\$220	\$653	\$873	1,730	\$274	1,003	\$359	3,122	2,759	494	\$1,026	\$1,520	4.99	4.99	\$30	\$149.81	\$1,669.91
4	2019	0.1625	0.3776	1,392	1,756	\$226	\$663	\$889	1,730	\$281	1,003	\$363	3,122	2,759	507	\$1,042	\$1,549	4.99	4.99	\$40	\$199.75	\$1,748.95
5	2020	0.1668	0.3841	1,392	1,756	\$232	\$674	\$907	1,730	\$289	1,003	\$367	3,122	2,759	521	\$1,060	\$1,580	4.99	4.99	\$50	\$249.69	\$1,830.09
6	2021	0.1621	0.3883	1,392	1,756	\$226	\$682	\$908	1,730	\$281	1,003	\$363	3,122	2,759	506	\$1,071	\$1,578	4.99	4.99	\$60	\$299.63	\$1,877.14
7	2022	0.1629	0.3929	1,392	1,756	\$227	\$690	\$917	1,730	\$282	1,003	\$363	3,122	2,759	509	\$1,084	\$1,593	4.99	4.99	\$70	\$349.57	\$1,942.22
8	2023	0.1639	0.3967	1,392	1,756	\$228	\$697	\$925	1,730	\$283	1,003	\$364	3,122	2,759	512	\$1,095	\$1,606	4.99	4.99	\$80	\$399.50	\$2,005.63
9	2024	0.1648	0.4005	1,392	1,756	\$229	\$703	\$933	1,730	\$285	1,003	\$365	3,122	2,759	515	\$1,105	\$1,620	4.99	4.99	\$90	\$449.44	\$2,069.05
10	2025	0.1656	0.4040	1,392	1,756	\$231	\$709	\$940	1,730	\$286	1,003	\$366	3,122	2,759	517	\$1,115	\$1,632	4.99	4.99	\$100	\$499.38	\$2,130.95
11	2026	0.1665	0.4070	1,392	1,756	\$232	\$715	\$947	1,730	\$288	1,003	\$367	3,122	2,759	520	\$1,123	\$1,643	4.99	4.99	\$110	\$549.32	\$2,192.26
12	2027	0.1674	0.4097	1,392	1,756	\$233	\$719	\$953	1,730	\$290	1,003	\$368	3,122	2,759	523	\$1,130	\$1,653	4.99	4.99	\$120	\$599.25	\$2,252.39
13	2028	0.1683	0.4124	1,392	1,756	\$234	\$724	\$958	1,730	\$291	1,003	\$369	3,122	2,759	525	\$1,138	\$1,663	4.99	4.99	\$130	\$649.19	\$2,312.31
14	2029	0.1692	0.4151	1,392	1,756	\$235	\$729	\$964	1,730	\$293	1,003	\$370	3,122	2,759	528	\$1,145	\$1,673	4.99	4.99	\$140	\$699.13	\$2,372.44
15	2030	0.1701	0.4170	1,392	1,756	\$237	\$732	\$969	1,730	\$294	1,003	\$371	3,122	2,759	531	\$1,150	\$1,682	4.99	4.99	\$150	\$749.07	\$2,430.58
16	2031	0.1704	0.4189	1,392	1,756	\$237	\$736	\$973	1,730	\$295	1,003	\$371	3,122	2,759	532	\$1,156	\$1,688	4.99	4.99	\$160	\$799.01	\$2,486.58
17	2032	0.1705	0.4204	1,392	1,756	\$237	\$738	\$976	1,730	\$295	1,003	\$371	3,122	2,759	532	\$1,160	\$1,692	4.99	4.99	\$170	\$848.94	\$2,541.19
18	2033	0.1707	0.4223	1,392	1,756	\$238	\$742	\$979	1,730	\$295	1,003	\$371	3,122	2,759	533	\$1,165	\$1,698	4.99	4.99	\$180	\$898.88	\$2,597.19
19	2034	0.1710	0.4246	1,392	1,756	\$238	\$746	\$984	1,730	\$296	1,003	\$372	3,122	2,759	534	\$1,172	\$1,706	4.99	4.99	\$190	\$948.82	\$2,654.36
20	2035	0.1713	0.4265	1,392	1,756	\$238	\$749	\$987	1,730	\$296	1,003	\$372	3,122	2,759	535	\$1,177	\$1,712	4.99	4.99	\$200	\$998.76	\$2,710.36
21	2036	0.1714	0.4288	1,392	1,756	\$239	\$753	\$992	1,730	\$297	1,003	\$372	3,122	2,759	535	\$1,183	\$1,718	4.99	4.99	\$210	\$1,048.70	\$2,767.08
22	2037	0.1717	0.4311	1,392	1,756	\$239	\$757	\$996	1,730	\$297	1,003	\$372	3,122	2,759	536	\$1,190	\$1,726	4.99	4.99	\$220	\$1,098.63	\$2,824.14
23	2038	0.1720	0.4331	1,392	1,756	\$239	\$760	\$1,000	1,730	\$298	1,003	\$372	3,122	2,759	537	\$1,195	\$1,732	4.99	4.99	\$230	\$1,148.57	\$2,880.26
24	2039	0.1722	0.4353	1,392	1,756	\$240	\$764	\$1,004	1,730	\$298	1,003	\$373	3,122	2,759	538	\$1,201	\$1,739	4.99	4.99	\$240	\$1,198.51	\$2,937.31
25	2040	0.1724	0.4376	1,392	1,756	\$240	\$769	\$1,008	1,730	\$298	1,003	\$373	3,122	2,759	538	\$1,207	\$1,746	4.99	4.99	\$250	\$1,248.45	\$2,994.03
26	2041	0.1734	0.4420	1,392	1,756	\$241	\$776	\$1,017	1,730	\$300	1,003	\$374	3,122	2,759	541	\$1,219	\$1,761	4.99	4.99	\$260	\$1,298.39	\$3,050.99
27	2042	0.1744	0.4463	1,392	1,756	\$243	\$784	\$1,026	1,730	\$302	1,003	\$375	3,122	2,759	544	\$1,231	\$1,776	4.99	4.99	\$270	\$1,348.32	\$3,124.08
28	2043	0.1754	0.4507	1,392	1,756	\$244	\$791	\$1,036	1,730	\$303	1,003	\$376	3,122	2,759	548	\$1,244	\$1,791	4.99	4.99	\$280	\$1,398.26	\$3,189.31
29	2044	0.1764	0.4552	1,392	1,756	\$246	\$799	\$1,045	1,730	\$305	1,003	\$377	3,122	2,759	551	\$1,256	\$1,806	4.99	4.99	\$290	\$1,448.20	\$3,254.67
30	2045	0.1774	0.4596	1,392	1,756	\$247	\$807	\$1,054	1,730	\$307	1,003	\$378	3,122	2,759	554	\$1,268	\$1,822	4.99	4.99	\$300	\$1,498.14	\$3,320.18
31	2046	0.1784	0.4642	1,392	1,756	\$248	\$815	\$1,063	1,730	\$309	1,003	\$379	3,122	2,759	557	\$1,281	\$1,838	4.99	4.99	\$310	\$1,548.07	\$3,385.82
32	2047	0.1795	0.4688	1,392	1,756	\$250	\$823	\$1,073	1,730	\$310	1,003	\$380	3,122	2,759	560	\$1,293	\$1,854	4.99	4.99	\$320	\$1,598.01	\$3,451.61
33	2048	0.1805	0.4734	1,392	1,756	\$251	\$831	\$1,083	1,730	\$312	1,003	\$381	3,122	2,759	564	\$1,306	\$1,870	4.99	4.99	\$330	\$1,647.95	\$3,517.54
34	2049	0.1816	0.4780	1,392	1,756	\$253	\$839	\$1,092	1,730	\$314	1,003	\$382	3,122	2,759	567	\$1,319	\$1,886	4.99	4.99	\$340	\$1,697.89	\$3,583.61
35	2050	0.1826	0.4828	1,392	1,756	\$254	\$848	\$1,102	1,730	\$316	1,003	\$383	3,122	2,759	570	\$1,332	\$1,902	4.99	4.99	\$350	\$1,747.83	\$3,649.83
36	2051	0.1837	0.4875	1,392	1,756	\$256	\$856	\$1,112	1,730	\$318	1,003	\$384	3,122	2,759	573	\$1,345	\$1,918	4.99	4.99	\$360	\$1,797.76	\$3,716.20
37	2052	0.1847	0.4923	1,392	1,756	\$257	\$865	\$1,122	1,730	\$320	1,003	\$385	3,122	2,759	577	\$1,358	\$1,935	4.99	4.99	\$370	\$1,847.70	\$3,782.72
38	2053	0.1858	0.4972	1,392	1,756	\$259	\$873	\$1,132	1,730	\$321	1,003	\$386	3,122	2,759	580	\$1,372	\$1,952	4.99	4.99	\$380	\$1,897.64	\$3,849.38
39	2054	0.1869	0.5021	1,392	1,756	\$260	\$882	\$1,142	1,730	\$323	1,003	\$387	3,122	2,759	583	\$1,385	\$1,969	4.99	4.99	\$390	\$1,947.58	\$3,916.20
40	2055	0.1879	0.5070	1,392	1,756	\$262	\$890	\$1,152	1,730	\$325	1,003	\$389	3,122	2,759	587	\$1,399	\$1,986	4.99	4.99	\$400	\$1,997.52	\$3,983.17
41	2056	0.1890	0.5120	1,392	1,756	\$263	\$899	\$1,162	1,730	\$327	1,003	\$390	3,122	2,759	590	\$1,413	\$2,003	4.99	4.99	\$410	\$2,047.45	\$4,050.29
42	2057	0.1901	0.5171	1,392	1,756	\$265	\$908	\$1,173	1,730	\$329	1,003	\$391	3,122	2,759	594	\$1,427	\$2,020	4.99	4.99	\$420	\$2,097.39	\$4,117.57
43	2058	0.1912	0.5222	1,392	1,756	\$266	\$917	\$1,183	1,730	\$331	1,003	\$392	3,122	2,759	597	\$1,441	\$2,038	4.99	4.99	\$430	\$2,147.33	\$4,185.01
44	2059	0.1923	0.5273	1,392	1,756	\$268	\$926	\$1,194	1,730	\$333	1,003	\$393	3,122	2,759	600	\$1,455	\$2,055	4.99	4.99	\$440	\$2,197.27	\$4,252.60
45	2060	0.1934	0.5325	1,392	1,756	\$269	\$935	\$1,204	1,730	\$335	1,003	\$394	3,122	2,759	604	\$1,469	\$2,073	4.99	4.99	\$450	\$2,247.21	\$4,320.36
46	2061	0.1946	0.5378	1,392	1,756	\$271	\$944	\$1,215	1,730	\$337	1,003	\$395	3,122	2,759	607	\$1,484	\$2,091	4.99	4.99	\$460	\$2,297.14	\$4,388.27
47	2062	0.1957	0.5431	1,392	1,756	\$272	\$954	\$1,226	1,730	\$339	1,003	\$396	3,122	2,759	611	\$1,498	\$2,109	4.99	4.99	\$470	\$2,347.08	\$4,456.35
48	2063	0.1968	0.5484	1,392	1,756	\$274	\$963	\$1,237	1,730	\$340	1,003	\$397	3,122	2,759	614	\$1,513	\$2,128	4.99	4.99	\$480	\$2,397.02	\$4,524.60
49	2064	0.1980	0.5538	1,392	1,756	\$276	\$973	\$1,248	1,730	\$342	1,003	\$399	3,122	2,759	618	\$1,528	\$2,146	4.99	4.99	\$490	\$2,446.96	\$4,593.01
50	2065	0.1991	0.5593	1,392	1,756	\$277	\$982	\$1,259	1,730	\$344	1,003	\$200	3,122	2,759	622	\$1,543	\$2,165	4.99	4.99	\$500	\$2,496.90	\$4,661.59
51	2066	0.2003	0.5648	1,392	1,756	\$279	\$992	\$1,271	1,730	\$346	1,003	\$201	3,122	2,759	625	\$1,558	\$2,183	4.99	4.99	\$510	\$2,546.83	\$4,730.33
52	2067	0.2014	0.5704	1,392	1,756	\$280	\$1,002	\$1,282	1,730	\$348	1,003	\$202	3,122	2,759	629	\$1,574	\$2,202	4.99	4.99	\$520	\$2,596.77	\$4,799.25
53	2068	0.2026	0.5760	1,392	1,756	\$282	\$1,011	\$1,293	1,730	\$350	1,003	\$203	3,122	2,759	632	\$1,589	\$2,222	4.99	4.99	\$530	\$2,646.71	\$4,868.34
54	2069	0.2038	0.5817	1,392	1,756	\$284	\$1,02															

3. Guelph (South) – Annual Operating Costs

Vertical Ground Source Heat Pump (V.GSHP)

Base Case Scenario											Feed in Tariff (FIT)			
#	Year	Electricity Rates		V.GSHP		V.GSHP		V.GSHP		Total	Total Operating Cost	Incentives (\$/KWh)	FIT	
		\$/KWh	KWh	Heating Operating Cost	Cooling	Cooling Operating Cost	Hot Water	Hot Water Operating Cost	\$/KWh				Operating Cost	
1	2016	0.1501	4,336	\$651	188	\$28	4,508	\$677	9,032	\$1,356	0.05	0.1001	\$903.95	
2	2017	0.1542	4,336	\$669	188	\$29	4,508	\$695	9,032	\$1,393	0.05	0.1042	\$941.01	
3	2018	0.1583	4,336	\$686	188	\$30	4,508	\$714	9,032	\$1,430	0.05	0.1083	\$978.08	
4	2019	0.1625	4,336	\$705	188	\$31	4,508	\$733	9,032	\$1,468	0.05	0.1125	\$1,016.45	
5	2020	0.1668	4,336	\$723	188	\$31	4,508	\$752	9,032	\$1,506	0.05	0.1168	\$1,054.82	
6	2021	0.1621	4,336	\$703	188	\$30	4,508	\$731	9,032	\$1,464	0.05	0.1121	\$1,012.87	
7	2022	0.1629	4,336	\$706	188	\$31	4,508	\$735	9,032	\$1,472	0.05	0.1129	\$1,020.03	
8	2023	0.1639	4,336	\$711	188	\$31	4,508	\$739	9,032	\$1,480	0.05	0.1139	\$1,028.48	
9	2024	0.1648	4,336	\$715	188	\$31	4,508	\$743	9,032	\$1,489	0.05	0.1148	\$1,036.93	
10	2025	0.1656	4,336	\$718	188	\$31	4,508	\$747	9,032	\$1,496	0.05	0.1156	\$1,044.09	
11	2026	0.1665	4,336	\$722	188	\$31	4,508	\$751	9,032	\$1,504	0.05	0.1165	\$1,052.54	
12	2027	0.1674	4,336	\$726	188	\$31	4,508	\$755	9,032	\$1,512	0.05	0.1174	\$1,060.67	
13	2028	0.1683	4,336	\$730	188	\$32	4,508	\$759	9,032	\$1,520	0.05	0.1183	\$1,068.15	
14	2029	0.1692	4,336	\$733	188	\$32	4,508	\$763	9,032	\$1,528	0.05	0.1192	\$1,076.28	
15	2030	0.1701	4,336	\$738	188	\$32	4,508	\$767	9,032	\$1,536	0.05	0.1201	\$1,084.73	
16	2031	0.1704	4,336	\$739	188	\$32	4,508	\$768	9,032	\$1,539	0.05	0.1204	\$1,087.01	
17	2032	0.1705	4,336	\$739	188	\$32	4,508	\$769	9,032	\$1,540	0.05	0.1205	\$1,088.31	
18	2033	0.1707	4,336	\$740	188	\$32	4,508	\$770	9,032	\$1,542	0.05	0.1207	\$1,090.58	
19	2034	0.1710	4,336	\$742	188	\$32	4,508	\$771	9,032	\$1,545	0.05	0.1210	\$1,093.18	
20	2035	0.1713	4,336	\$743	188	\$32	4,508	\$772	9,032	\$1,547	0.05	0.1213	\$1,095.46	
21	2036	0.1714	4,336	\$743	188	\$32	4,508	\$773	9,032	\$1,548	0.05	0.1214	\$1,096.76	
22	2037	0.1717	4,336	\$744	188	\$32	4,508	\$774	9,032	\$1,551	0.05	0.1217	\$1,099.04	
23	2038	0.1720	4,336	\$746	188	\$32	4,508	\$775	9,032	\$1,553	0.05	0.1220	\$1,101.64	
24	2039	0.1722	4,336	\$747	188	\$32	4,508	\$776	9,032	\$1,556	0.05	0.1222	\$1,103.91	
25	2040	0.1724	4,336	\$747	188	\$32	4,508	\$777	9,032	\$1,557	0.05	0.1224	\$1,105.22	
26	2041	0.1734	4,336	\$752	188	\$33	4,508	\$782	9,032	\$1,566	0.05	0.1234	\$1,114.22	
27	2042	0.1744	4,336	\$756	188	\$33	4,508	\$786	9,032	\$1,575	0.05	0.1244	\$1,123.28	
28	2043	0.1754	4,336	\$760	188	\$33	4,508	\$791	9,032	\$1,584	0.05	0.1254	\$1,132.39	
29	2044	0.1764	4,336	\$765	188	\$33	4,508	\$795	9,032	\$1,593	0.05	0.1264	\$1,141.55	
30	2045	0.1774	4,336	\$769	188	\$33	4,508	\$800	9,032	\$1,602	0.05	0.1274	\$1,150.77	
31	2046	0.1784	4,336	\$774	188	\$34	4,508	\$804	9,032	\$1,612	0.05	0.1284	\$1,160.04	
32	2047	0.1795	4,336	\$778	188	\$34	4,508	\$809	9,032	\$1,621	0.05	0.1295	\$1,169.36	
33	2048	0.1805	4,336	\$783	188	\$34	4,508	\$814	9,032	\$1,630	0.05	0.1305	\$1,178.74	
34	2049	0.1816	4,336	\$787	188	\$34	4,508	\$818	9,032	\$1,640	0.05	0.1316	\$1,188.17	
35	2050	0.1826	4,336	\$792	188	\$34	4,508	\$823	9,032	\$1,649	0.05	0.1326	\$1,197.66	
36	2051	0.1837	4,336	\$796	188	\$35	4,508	\$828	9,032	\$1,659	0.05	0.1337	\$1,207.20	
37	2052	0.1847	4,336	\$801	188	\$35	4,508	\$833	9,032	\$1,668	0.05	0.1347	\$1,216.79	
38	2053	0.1858	4,336	\$806	188	\$35	4,508	\$838	9,032	\$1,678	0.05	0.1358	\$1,226.44	
39	2054	0.1869	4,336	\$810	188	\$35	4,508	\$842	9,032	\$1,688	0.05	0.1369	\$1,236.15	
40	2055	0.1879	4,336	\$815	188	\$35	4,508	\$847	9,032	\$1,698	0.05	0.1379	\$1,245.91	
41	2056	0.1890	4,336	\$820	188	\$36	4,508	\$852	9,032	\$1,707	0.05	0.1390	\$1,255.73	
42	2057	0.1901	4,336	\$824	188	\$36	4,508	\$857	9,032	\$1,717	0.05	0.1401	\$1,265.61	
43	2058	0.1912	4,336	\$829	188	\$36	4,508	\$862	9,032	\$1,727	0.05	0.1412	\$1,275.54	
44	2059	0.1923	4,336	\$834	188	\$36	4,508	\$867	9,032	\$1,737	0.05	0.1423	\$1,285.54	
45	2060	0.1934	4,336	\$839	188	\$36	4,508	\$872	9,032	\$1,747	0.05	0.1434	\$1,295.59	
46	2061	0.1946	4,336	\$844	188	\$37	4,508	\$877	9,032	\$1,757	0.05	0.1446	\$1,305.69	
47	2062	0.1957	4,336	\$849	188	\$37	4,508	\$882	9,032	\$1,767	0.05	0.1457	\$1,315.86	
48	2063	0.1968	4,336	\$853	188	\$37	4,508	\$887	9,032	\$1,778	0.05	0.1468	\$1,326.08	
49	2064	0.1980	4,336	\$858	188	\$37	4,508	\$892	9,032	\$1,788	0.05	0.1480	\$1,336.37	
50	2065	0.1991	4,336	\$863	188	\$37	4,508	\$898	9,032	\$1,798	0.05	0.1491	\$1,346.71	
51	2066	0.2003	4,336	\$868	188	\$38	4,508	\$903	9,032	\$1,809	0.05	0.1503	\$1,357.11	
52	2067	0.2014	4,336	\$873	188	\$38	4,508	\$908	9,032	\$1,819	0.05	0.1514	\$1,367.58	
53	2068	0.2026	4,336	\$878	188	\$38	4,508	\$913	9,032	\$1,830	0.05	0.1526	\$1,378.10	
54	2069	0.2038	4,336	\$883	188	\$38	4,508	\$919	9,032	\$1,840	0.05	0.1538	\$1,388.68	
55	2070	0.2049	4,336	\$889	188	\$39	4,508	\$924	9,032	\$1,851	0.05	0.1549	\$1,399.33	
56	2071	0.2061	4,336	\$894	188	\$39	4,508	\$929	9,032	\$1,862	0.05	0.1561	\$1,410.04	
57	2072	0.2073	4,336	\$899	188	\$39	4,508	\$935	9,032	\$1,872	0.05	0.1573	\$1,420.81	
58	2073	0.2085	4,336	\$904	188	\$39	4,508	\$940	9,032	\$1,883	0.05	0.1585	\$1,431.64	
59	2074	0.2097	4,336	\$909	188	\$39	4,508	\$945	9,032	\$1,894	0.05	0.1597	\$1,442.53	
60	2075	0.2109	4,336	\$915	188	\$40	4,508	\$951	9,032	\$1,905	0.05	0.1609	\$1,453.49	

Table D2-1.7: Annual Operating Costs (V.GSHP) of a 2,000 square feet detached house above grade (improved construction type) in the city of Guelph (two life cycles and three life cycles for a 60 year project lifespan); base case scenario in comparison with feed in-tariff (FIT) scenario. In the FIT scenario, an incentive of \$0.05/KWh is provided on electricity bills throughout the project lifespan

Horizontal Ground Source Heat Pump (H.GSHP)

Base Case Scenario											Feed in Tariff (FIT)		
H.GSHP											FIT		
#	Year	Electricity Rates \$/KWh	Heating KWh	Heating Operating Cost \$	Cooling KWh	Cooling Operating Cost \$	Hot Water KWh	Hot Water Operating Cost \$	Total KWh	Total Operating Cost \$	Incentives (\$/KWh)	Operating Cost \$	
1	2016	0.1501	4,402	\$661	193	\$29	4,511	\$677	9,106	\$1,367	0.05	\$911.35	
2	2017	0.1542	4,402	\$679	193	\$30	4,511	\$696	9,106	\$1,404	0.05	\$948.72	
3	2018	0.1583	4,402	\$697	193	\$31	4,511	\$714	9,106	\$1,441	0.05	\$986.10	
4	2019	0.1625	4,402	\$715	193	\$31	4,511	\$733	9,106	\$1,480	0.05	\$1,024.78	
5	2020	0.1668	4,402	\$734	193	\$32	4,511	\$752	9,106	\$1,519	0.05	\$1,063.46	
6	2021	0.1621	4,402	\$714	193	\$31	4,511	\$731	9,106	\$1,476	0.05	\$1,021.17	
7	2022	0.1629	4,402	\$717	193	\$31	4,511	\$735	9,106	\$1,484	0.05	\$1,028.38	
8	2023	0.1639	4,402	\$721	193	\$32	4,511	\$739	9,106	\$1,492	0.05	\$1,036.91	
9	2024	0.1648	4,402	\$725	193	\$32	4,511	\$743	9,106	\$1,501	0.05	\$1,045.43	
10	2025	0.1656	4,402	\$729	193	\$32	4,511	\$747	9,106	\$1,508	0.05	\$1,052.64	
11	2026	0.1665	4,402	\$733	193	\$32	4,511	\$751	9,106	\$1,516	0.05	\$1,061.16	
12	2027	0.1674	4,402	\$737	193	\$32	4,511	\$755	9,106	\$1,525	0.05	\$1,069.36	
13	2028	0.1683	4,402	\$741	193	\$32	4,511	\$759	9,106	\$1,532	0.05	\$1,076.90	
14	2029	0.1692	4,402	\$745	193	\$33	4,511	\$763	9,106	\$1,540	0.05	\$1,085.10	
15	2030	0.1701	4,402	\$749	193	\$33	4,511	\$767	9,106	\$1,549	0.05	\$1,093.62	
16	2031	0.1704	4,402	\$750	193	\$33	4,511	\$768	9,106	\$1,551	0.05	\$1,095.91	
17	2032	0.1705	4,402	\$751	193	\$33	4,511	\$769	9,106	\$1,553	0.05	\$1,097.22	
18	2033	0.1707	4,402	\$752	193	\$33	4,511	\$770	9,106	\$1,555	0.05	\$1,099.52	
19	2034	0.1710	4,402	\$753	193	\$33	4,511	\$772	9,106	\$1,557	0.05	\$1,102.14	
20	2035	0.1713	4,402	\$754	193	\$33	4,511	\$773	9,106	\$1,560	0.05	\$1,104.44	
21	2036	0.1714	4,402	\$755	193	\$33	4,511	\$773	9,106	\$1,561	0.05	\$1,105.75	
22	2037	0.1717	4,402	\$756	193	\$33	4,511	\$774	9,106	\$1,563	0.05	\$1,108.04	
23	2038	0.1720	4,402	\$757	193	\$33	4,511	\$776	9,106	\$1,566	0.05	\$1,110.66	
24	2039	0.1722	4,402	\$758	193	\$33	4,511	\$777	9,106	\$1,568	0.05	\$1,112.96	
25	2040	0.1724	4,402	\$759	193	\$33	4,511	\$778	9,106	\$1,570	0.05	\$1,114.27	
26	2041	0.1734	4,402	\$763	193	\$33	4,511	\$782	9,106	\$1,579	0.05	\$1,123.35	
27	2042	0.1744	4,402	\$768	193	\$34	4,511	\$787	9,106	\$1,588	0.05	\$1,132.48	
28	2043	0.1754	4,402	\$772	193	\$34	4,511	\$791	9,106	\$1,597	0.05	\$1,141.67	
29	2044	0.1764	4,402	\$776	193	\$34	4,511	\$796	9,106	\$1,606	0.05	\$1,150.91	
30	2045	0.1774	4,402	\$781	193	\$34	4,511	\$800	9,106	\$1,615	0.05	\$1,160.20	
31	2046	0.1784	4,402	\$785	193	\$34	4,511	\$805	9,106	\$1,625	0.05	\$1,169.54	
32	2047	0.1795	4,402	\$790	193	\$35	4,511	\$810	9,106	\$1,634	0.05	\$1,178.94	
33	2048	0.1805	4,402	\$795	193	\$35	4,511	\$814	9,106	\$1,644	0.05	\$1,188.40	
34	2049	0.1816	4,402	\$799	193	\$35	4,511	\$819	9,106	\$1,653	0.05	\$1,197.90	
35	2050	0.1826	4,402	\$804	193	\$35	4,511	\$824	9,106	\$1,663	0.05	\$1,207.47	
36	2051	0.1837	4,402	\$808	193	\$35	4,511	\$828	9,106	\$1,672	0.05	\$1,217.09	
37	2052	0.1847	4,402	\$813	193	\$36	4,511	\$833	9,106	\$1,682	0.05	\$1,226.76	
38	2053	0.1858	4,402	\$818	193	\$36	4,511	\$838	9,106	\$1,692	0.05	\$1,236.49	
39	2054	0.1869	4,402	\$823	193	\$36	4,511	\$843	9,106	\$1,702	0.05	\$1,246.28	
40	2055	0.1879	4,402	\$827	193	\$36	4,511	\$848	9,106	\$1,711	0.05	\$1,256.12	
41	2056	0.1890	4,402	\$832	193	\$36	4,511	\$853	9,106	\$1,721	0.05	\$1,266.02	
42	2057	0.1901	4,402	\$837	193	\$37	4,511	\$858	9,106	\$1,731	0.05	\$1,275.98	
43	2058	0.1912	4,402	\$842	193	\$37	4,511	\$863	9,106	\$1,741	0.05	\$1,286.00	
44	2059	0.1923	4,402	\$847	193	\$37	4,511	\$868	9,106	\$1,751	0.05	\$1,296.07	
45	2060	0.1934	4,402	\$852	193	\$37	4,511	\$873	9,106	\$1,762	0.05	\$1,306.20	
46	2061	0.1946	4,402	\$856	193	\$38	4,511	\$878	9,106	\$1,772	0.05	\$1,316.39	
47	2062	0.1957	4,402	\$861	193	\$38	4,511	\$883	9,106	\$1,782	0.05	\$1,326.64	
48	2063	0.1968	4,402	\$866	193	\$38	4,511	\$888	9,106	\$1,792	0.05	\$1,336.95	
49	2064	0.1980	4,402	\$871	193	\$38	4,511	\$893	9,106	\$1,803	0.05	\$1,347.32	
50	2065	0.1991	4,402	\$876	193	\$38	4,511	\$898	9,106	\$1,813	0.05	\$1,357.74	
51	2066	0.2003	4,402	\$882	193	\$39	4,511	\$903	9,106	\$1,824	0.05	\$1,368.23	
52	2067	0.2014	4,402	\$887	193	\$39	4,511	\$909	9,106	\$1,834	0.05	\$1,378.78	
53	2068	0.2026	4,402	\$892	193	\$39	4,511	\$914	9,106	\$1,845	0.05	\$1,389.39	
54	2069	0.2038	4,402	\$897	193	\$39	4,511	\$919	9,106	\$1,855	0.05	\$1,400.06	
55	2070	0.2049	4,402	\$902	193	\$40	4,511	\$924	9,106	\$1,866	0.05	\$1,410.79	
56	2071	0.2061	4,402	\$907	193	\$40	4,511	\$930	9,106	\$1,877	0.05	\$1,421.59	
57	2072	0.2073	4,402	\$913	193	\$40	4,511	\$935	9,106	\$1,888	0.05	\$1,432.45	
58	2073	0.2085	4,402	\$918	193	\$40	4,511	\$941	9,106	\$1,899	0.05	\$1,443.37	
59	2074	0.2097	4,402	\$923	193	\$40	4,511	\$946	9,106	\$1,910	0.05	\$1,454.35	
60	2075	0.2109	4,402	\$928	193	\$41	4,511	\$951	9,106	\$1,921	0.05	\$1,465.40	

Table D2-1.8: Annual Operating Costs (H.GSHP) of a 2,000 square feet detached house above grade (improved construction type) in the city of Guelph (two life cycles and three life cycles for a 60 year project lifespan); base case scenario in comparison with feed in-tariff (FIT) scenario. In the FIT scenario, an incentive of \$0.05/KWh is provided on electricity bills throughout the project lifespan

Traditional HVAC Applications

Base Case Scenario															Carbon Taxes							
#	Year	Traditional													Total	Carbon Taxes						
		Electricity Rates \$/KWh	Natural Gas Rates \$/m ³	Heating		Heating Operating Cost \$ (Electricity)	Heating Operating Cost \$ (Gas)	Total Heating Operating Cost \$	Cooling		Hot Water m ³	Hot Water Operating Cost \$	Total KWh	Total m ³		Total Electricity Operating Cost \$ (KWh)	Total Natural Gas Operating Cost \$ (m ³)	Total	Conversion of m ³ into Tons	Total Tons	Carbon Tax	Operating Costs
				KWh (Electricity)	m ³ (Gas)				Operating Cost	Operating Cost												
1	2016	0.1501	0.3458	1,472	2,131	\$221	\$958	\$737	774	\$116	1,029	\$356	2,246	3,160	337	\$1,093	\$1,430	5.72	5.72	\$10	\$57.20	\$1,487.11
2	2017	0.1542	0.3588	1,472	2,131	\$227	\$992	\$765	774	\$119	1,029	\$159	2,246	3,160	346	\$1,134	\$1,480	5.72	5.72	\$20	\$114.39	\$1,594.62
3	2018	0.1583	0.3718	1,472	2,131	\$233	\$1,025	\$792	774	\$123	1,029	\$163	2,246	3,160	356	\$1,175	\$1,531	5.72	5.72	\$30	\$171.59	\$1,702.14
4	2019	0.1625	0.3776	1,472	2,131	\$239	\$805	\$1,044	774	\$126	1,029	\$167	2,246	3,160	365	\$1,193	\$1,558	5.72	5.72	\$40	\$228.78	\$1,787.01
5	2020	0.1668	0.3841	1,472	2,131	\$246	\$818	\$1,064	774	\$129	1,029	\$172	2,246	3,160	375	\$1,214	\$1,588	5.72	5.72	\$50	\$285.98	\$1,874.29
6	2021	0.1621	0.3883	1,472	2,131	\$239	\$827	\$1,066	774	\$125	1,029	\$167	2,246	3,160	364	\$1,227	\$1,591	5.72	5.72	\$60	\$343.18	\$1,934.36
7	2022	0.1629	0.3929	1,472	2,131	\$240	\$837	\$1,077	774	\$126	1,029	\$168	2,246	3,160	366	\$1,242	\$1,607	5.72	5.72	\$70	\$400.37	\$2,007.84
8	2023	0.1639	0.3967	1,472	2,131	\$241	\$845	\$1,087	774	\$127	1,029	\$169	2,246	3,160	368	\$1,254	\$1,622	5.72	5.72	\$80	\$457.57	\$2,079.23
9	2024	0.1648	0.4005	1,472	2,131	\$243	\$854	\$1,096	774	\$128	1,029	\$170	2,246	3,160	370	\$1,266	\$1,636	5.72	5.72	\$90	\$514.76	\$2,150.61
10	2025	0.1656	0.4040	1,472	2,131	\$244	\$861	\$1,105	774	\$128	1,029	\$170	2,246	3,160	372	\$1,277	\$1,649	5.72	5.72	\$100	\$571.96	\$2,220.47
11	2026	0.1665	0.4070	1,472	2,131	\$245	\$867	\$1,113	774	\$129	1,029	\$171	2,246	3,160	374	\$1,286	\$1,660	5.72	5.72	\$110	\$629.16	\$2,289.44
12	2027	0.1674	0.4097	1,472	2,131	\$246	\$873	\$1,120	774	\$130	1,029	\$172	2,246	3,160	376	\$1,295	\$1,671	5.72	5.72	\$120	\$686.35	\$2,357.12
13	2028	0.1683	0.4124	1,472	2,131	\$248	\$879	\$1,126	774	\$130	1,029	\$173	2,246	3,160	378	\$1,303	\$1,681	5.72	5.72	\$130	\$743.55	\$2,424.63
14	2029	0.1692	0.4151	1,472	2,131	\$249	\$885	\$1,134	774	\$131	1,029	\$174	2,246	3,160	380	\$1,312	\$1,692	5.72	5.72	\$140	\$800.74	\$2,492.31
15	2030	0.1701	0.4170	1,472	2,131	\$250	\$889	\$1,139	774	\$132	1,029	\$175	2,246	3,160	382	\$1,318	\$1,700	5.72	5.72	\$150	\$857.94	\$2,557.66
16	2031	0.1704	0.4189	1,472	2,131	\$251	\$893	\$1,143	774	\$132	1,029	\$175	2,246	3,160	383	\$1,324	\$1,706	5.72	5.72	\$160	\$915.14	\$2,621.46
17	2032	0.1705	0.4204	1,472	2,131	\$251	\$896	\$1,147	774	\$132	1,029	\$175	2,246	3,160	383	\$1,329	\$1,711	5.72	5.72	\$170	\$972.33	\$2,683.82
18	2033	0.1707	0.4223	1,472	2,131	\$251	\$900	\$1,151	774	\$132	1,029	\$176	2,246	3,160	383	\$1,335	\$1,718	5.72	5.72	\$180	\$1,029.53	\$2,747.62
19	2034	0.1710	0.4246	1,472	2,131	\$252	\$905	\$1,157	774	\$132	1,029	\$176	2,246	3,160	384	\$1,342	\$1,726	5.72	5.72	\$190	\$1,086.72	\$2,812.72
20	2035	0.1713	0.4265	1,472	2,131	\$252	\$909	\$1,161	774	\$133	1,029	\$176	2,246	3,160	385	\$1,348	\$1,733	5.72	5.72	\$200	\$1,143.92	\$2,876.53
21	2036	0.1714	0.4288	1,472	2,131	\$252	\$914	\$1,166	774	\$133	1,029	\$176	2,246	3,160	385	\$1,355	\$1,740	5.72	5.72	\$210	\$1,201.12	\$2,941.30
22	2037	0.1717	0.4311	1,472	2,131	\$253	\$919	\$1,171	774	\$133	1,029	\$177	2,246	3,160	386	\$1,362	\$1,748	5.72	5.72	\$220	\$1,258.31	\$3,006.31
23	2038	0.1720	0.4331	1,472	2,131	\$253	\$923	\$1,176	774	\$133	1,029	\$177	2,246	3,160	386	\$1,368	\$1,755	5.72	5.72	\$230	\$1,315.51	\$3,070.20
24	2039	0.1722	0.4353	1,472	2,131	\$254	\$928	\$1,181	774	\$133	1,029	\$177	2,246	3,160	387	\$1,376	\$1,763	5.72	5.72	\$240	\$1,372.70	\$3,135.22
25	2040	0.1724	0.4376	1,472	2,131	\$254	\$933	\$1,186	774	\$133	1,029	\$177	2,246	3,160	387	\$1,383	\$1,770	5.72	5.72	\$250	\$1,429.90	\$3,199.99
26	2041	0.1734	0.4420	1,472	2,131	\$255	\$942	\$1,197	774	\$134	1,029	\$178	2,246	3,160	389	\$1,397	\$1,786	5.72	5.72	\$260	\$1,487.10	\$3,273.06
27	2042	0.1744	0.4463	1,472	2,131	\$257	\$951	\$1,208	774	\$135	1,029	\$179	2,246	3,160	392	\$1,410	\$1,802	5.72	5.72	\$270	\$1,544.29	\$3,346.28
28	2043	0.1754	0.4507	1,472	2,131	\$258	\$960	\$1,219	774	\$136	1,029	\$180	2,246	3,160	394	\$1,424	\$1,818	5.72	5.72	\$280	\$1,601.49	\$3,419.64
29	2044	0.1764	0.4552	1,472	2,131	\$260	\$970	\$1,230	774	\$137	1,029	\$182	2,246	3,160	396	\$1,438	\$1,834	5.72	5.72	\$290	\$1,658.68	\$3,493.16
30	2045	0.1774	0.4596	1,472	2,131	\$261	\$980	\$1,241	774	\$137	1,029	\$183	2,246	3,160	398	\$1,452	\$1,851	5.72	5.72	\$300	\$1,715.88	\$3,566.83
31	2046	0.1784	0.4642	1,472	2,131	\$263	\$989	\$1,252	774	\$138	1,029	\$184	2,246	3,160	401	\$1,467	\$1,868	5.72	5.72	\$310	\$1,773.08	\$3,640.65
32	2047	0.1795	0.4688	1,472	2,131	\$264	\$999	\$1,263	774	\$139	1,029	\$185	2,246	3,160	403	\$1,481	\$1,884	5.72	5.72	\$320	\$1,830.27	\$3,714.62
33	2048	0.1805	0.4734	1,472	2,131	\$266	\$1,009	\$1,274	774	\$140	1,029	\$186	2,246	3,160	405	\$1,496	\$1,901	5.72	5.72	\$330	\$1,887.47	\$3,788.76
34	2049	0.1816	0.4780	1,472	2,131	\$267	\$1,019	\$1,286	774	\$141	1,029	\$187	2,246	3,160	408	\$1,511	\$1,918	5.72	5.72	\$340	\$1,944.66	\$3,863.04
35	2050	0.1826	0.4828	1,472	2,131	\$269	\$1,029	\$1,298	774	\$141	1,029	\$188	2,246	3,160	410	\$1,526	\$1,936	5.72	5.72	\$350	\$2,001.86	\$3,937.49
36	2051	0.1837	0.4875	1,472	2,131	\$270	\$1,039	\$1,309	774	\$142	1,029	\$189	2,246	3,160	412	\$1,541	\$1,953	5.72	5.72	\$360	\$2,059.06	\$4,012.10
37	2052	0.1847	0.4923	1,472	2,131	\$272	\$1,049	\$1,321	774	\$143	1,029	\$190	2,246	3,160	415	\$1,556	\$1,971	5.72	5.72	\$370	\$2,116.25	\$4,086.87
38	2053	0.1858	0.4972	1,472	2,131	\$273	\$1,059	\$1,333	774	\$144	1,029	\$191	2,246	3,160	417	\$1,571	\$1,988	5.72	5.72	\$380	\$2,173.45	\$4,161.80
39	2054	0.1869	0.5021	1,472	2,131	\$275	\$1,070	\$1,345	774	\$145	1,029	\$192	2,246	3,160	420	\$1,587	\$2,006	5.72	5.72	\$390	\$2,230.64	\$4,236.90
40	2055	0.1879	0.5070	1,472	2,131	\$277	\$1,080	\$1,357	774	\$145	1,029	\$193	2,246	3,160	422	\$1,602	\$2,024	5.72	5.72	\$400	\$2,287.84	\$4,312.17
41	2056	0.1890	0.5120	1,472	2,131	\$278	\$1,091	\$1,369	774	\$146	1,029	\$195	2,246	3,160	425	\$1,618	\$2,043	5.72	5.72	\$410	\$2,345.04	\$4,387.60
42	2057	0.1901	0.5171	1,472	2,131	\$280	\$1,102	\$1,382	774	\$147	1,029	\$196	2,246	3,160	427	\$1,634	\$2,061	5.72	5.72	\$420	\$2,402.23	\$4,463.21
43	2058	0.1912	0.5222	1,472	2,131	\$281	\$1,113	\$1,394	774	\$148	1,029	\$197	2,246	3,160	429	\$1,650	\$2,080	5.72	5.72	\$430	\$2,459.43	\$4,538.98
44	2059	0.1923	0.5273	1,472	2,131	\$283	\$1,124	\$1,407	774	\$149	1,029	\$198	2,246	3,160	432	\$1,666	\$2,098	5.72	5.72	\$440	\$2,516.62	\$4,614.93
45	2060	0.1934	0.5325	1,472	2,131	\$285	\$1,135	\$1,420	774	\$150	1,029	\$199	2,246	3,160	434	\$1,683	\$2,117	5.72	5.72	\$450	\$2,573.82	\$4,691.06
46	2061	0.1946	0.5378	1,472	2,131	\$286	\$1,146	\$1,432	774	\$151	1,029	\$200	2,246	3,160	437	\$1,699	\$2,136	5.72	5.72	\$460	\$2,631.02	\$4,767.35
47	2062	0.1957	0.5431	1,472	2,131	\$288	\$1,157	\$1,445	774	\$151	1,029	\$201	2,246	3,160	440	\$1,716	\$2,156	5.72	5.72	\$470	\$2,688.21	\$4,843.83
48	2063	0.1968	0.5484	1,472	2,131	\$290	\$1,169	\$1,458	774	\$152	1,029	\$203	2,246	3,160	442	\$1,733	\$2,175	5.72	5.72	\$480	\$2,745.41	\$4,920.49
49	2064	0.1980	0.5538	1,472	2,131	\$291	\$1,180	\$1,472	774	\$153	1,029	\$204	2,246	3,160	445	\$1,750	\$2,195	5.72	5.72	\$490	\$2,802.60	\$4,997.33
50	2065	0.1991	0.5593	1,472	2,131	\$293	\$1,192	\$1,485	774	\$154	1,029	\$205	2,246	3,160	447	\$1,767	\$2,215	5.72	5.72	\$500	\$2,859.80	\$5,074.35
51	2066	0.2003	0.5648	1,472	2,131	\$295	\$1,204	\$1,498	774	\$155	1,029	\$206	2,246	3,160	450	\$1,785	\$2,235	5.72	5.72	\$510	\$2,917.00	\$5,151.56
52	2067	0.2014	0.5704	1,472	2,131	\$296	\$1,215	\$1,512	774	\$156	1,029	\$207	2,246	3,160	452	\$1,802	\$2,255	5.72	5.72	\$520	\$2,974.19	\$5,228.95
53	2068	0.2026	0.5760	1,472	2,131	\$298	\$1,227	\$1,526	774	\$157	1,029	\$208	2,246	3,160	455	\$1,820	\$2,275	5.72	5.72	\$530	\$3,031.39	\$5,306.54
54	2069	0.2038	0.5817	1,472	2,																	

4. Hamilton (South) – Annual Operating Costs

Vertical Ground Source Heat Pump (V.GSHP)

Base Case Scenario											Feed in Tariff (FIT)		
#	Year	V.GSHP									FIT		
		Electricity Rates \$/KWh	Heating KWh	Heating Operating Cost \$	Cooling KWh	Cooling Operating Cost \$	Hot Water KWh	Hot Water Operating Cost \$	Total KWh	Total Operating Cost \$	Incentives (\$/KWh)	S/KWh	Operating Cost
1	2016	0.1501	3,856	\$579	420	\$63	4,496	\$675	8,772	\$1,317	0.05	0.1001	\$877.93
2	2017	0.1542	3,856	\$595	420	\$65	4,496	\$693	8,772	\$1,353	0.05	0.1042	\$913.93
3	2018	0.1583	3,856	\$610	420	\$66	4,496	\$712	8,772	\$1,389	0.05	0.1083	\$949.93
4	2019	0.1625	3,856	\$627	420	\$68	4,496	\$731	8,772	\$1,426	0.05	0.1125	\$987.19
5	2020	0.1668	3,856	\$643	420	\$70	4,496	\$750	8,772	\$1,463	0.05	0.1168	\$1,024.45
6	2021	0.1621	3,856	\$625	420	\$68	4,496	\$729	8,772	\$1,422	0.05	0.1121	\$983.72
7	2022	0.1629	3,856	\$628	420	\$68	4,496	\$733	8,772	\$1,429	0.05	0.1129	\$990.66
8	2023	0.1639	3,856	\$632	420	\$69	4,496	\$737	8,772	\$1,437	0.05	0.1139	\$998.87
9	2024	0.1648	3,856	\$635	420	\$69	4,496	\$741	8,772	\$1,446	0.05	0.1148	\$1,007.08
10	2025	0.1656	3,856	\$639	420	\$70	4,496	\$745	8,772	\$1,453	0.05	0.1156	\$1,014.03
11	2026	0.1665	3,856	\$642	420	\$70	4,496	\$749	8,772	\$1,461	0.05	0.1165	\$1,022.24
12	2027	0.1674	3,856	\$646	420	\$70	4,496	\$753	8,772	\$1,469	0.05	0.1174	\$1,030.14
13	2028	0.1683	3,856	\$649	420	\$71	4,496	\$757	8,772	\$1,476	0.05	0.1183	\$1,037.40
14	2029	0.1692	3,856	\$652	420	\$71	4,496	\$761	8,772	\$1,484	0.05	0.1192	\$1,045.29
15	2030	0.1701	3,856	\$656	420	\$71	4,496	\$765	8,772	\$1,492	0.05	0.1201	\$1,053.51
16	2031	0.1704	3,856	\$657	420	\$72	4,496	\$766	8,772	\$1,494	0.05	0.1204	\$1,055.72
17	2032	0.1705	3,856	\$657	420	\$72	4,496	\$767	8,772	\$1,496	0.05	0.1205	\$1,056.98
18	2033	0.1707	3,856	\$658	420	\$72	4,496	\$768	8,772	\$1,498	0.05	0.1207	\$1,059.19
19	2034	0.1710	3,856	\$660	420	\$72	4,496	\$769	8,772	\$1,500	0.05	0.1210	\$1,061.72
20	2035	0.1713	3,856	\$660	420	\$72	4,496	\$770	8,772	\$1,503	0.05	0.1213	\$1,063.93
21	2036	0.1714	3,856	\$661	420	\$72	4,496	\$771	8,772	\$1,504	0.05	0.1214	\$1,065.19
22	2037	0.1717	3,856	\$662	420	\$72	4,496	\$772	8,772	\$1,506	0.05	0.1217	\$1,067.40
23	2038	0.1720	3,856	\$663	420	\$72	4,496	\$773	8,772	\$1,509	0.05	0.1220	\$1,069.93
24	2039	0.1722	3,856	\$664	420	\$72	4,496	\$774	8,772	\$1,511	0.05	0.1222	\$1,072.14
25	2040	0.1724	3,856	\$665	420	\$72	4,496	\$775	8,772	\$1,512	0.05	0.1224	\$1,073.40
26	2041	0.1734	3,856	\$668	420	\$73	4,496	\$779	8,772	\$1,521	0.05	0.1234	\$1,082.15
27	2042	0.1744	3,856	\$672	420	\$73	4,496	\$784	8,772	\$1,530	0.05	0.1244	\$1,090.94
28	2043	0.1754	3,856	\$676	420	\$74	4,496	\$788	8,772	\$1,538	0.05	0.1254	\$1,099.79
29	2044	0.1764	3,856	\$680	420	\$74	4,496	\$793	8,772	\$1,547	0.05	0.1264	\$1,108.69
30	2045	0.1774	3,856	\$684	420	\$75	4,496	\$798	8,772	\$1,556	0.05	0.1274	\$1,117.64
31	2046	0.1784	3,856	\$688	420	\$75	4,496	\$802	8,772	\$1,565	0.05	0.1284	\$1,126.65
32	2047	0.1795	3,856	\$692	420	\$75	4,496	\$807	8,772	\$1,574	0.05	0.1295	\$1,135.70
33	2048	0.1805	3,856	\$696	420	\$76	4,496	\$812	8,772	\$1,583	0.05	0.1305	\$1,144.81
34	2049	0.1816	3,856	\$700	420	\$76	4,496	\$816	8,772	\$1,593	0.05	0.1316	\$1,153.97
35	2050	0.1826	3,856	\$704	420	\$77	4,496	\$821	8,772	\$1,602	0.05	0.1326	\$1,163.18
36	2051	0.1837	3,856	\$708	420	\$77	4,496	\$826	8,772	\$1,611	0.05	0.1337	\$1,172.45
37	2052	0.1847	3,856	\$712	420	\$78	4,496	\$831	8,772	\$1,620	0.05	0.1347	\$1,181.77
38	2053	0.1858	3,856	\$716	420	\$78	4,496	\$835	8,772	\$1,630	0.05	0.1358	\$1,191.14
39	2054	0.1869	3,856	\$721	420	\$78	4,496	\$840	8,772	\$1,639	0.05	0.1369	\$1,200.57
40	2055	0.1879	3,856	\$725	420	\$79	4,496	\$845	8,772	\$1,649	0.05	0.1379	\$1,210.05
41	2056	0.1890	3,856	\$729	420	\$79	4,496	\$850	8,772	\$1,658	0.05	0.1390	\$1,219.59
42	2057	0.1901	3,856	\$733	420	\$80	4,496	\$855	8,772	\$1,668	0.05	0.1401	\$1,229.18
43	2058	0.1912	3,856	\$737	420	\$80	4,496	\$860	8,772	\$1,677	0.05	0.1412	\$1,238.83
44	2059	0.1923	3,856	\$742	420	\$81	4,496	\$865	8,772	\$1,687	0.05	0.1423	\$1,248.53
45	2060	0.1934	3,856	\$746	420	\$81	4,496	\$870	8,772	\$1,697	0.05	0.1434	\$1,258.29
46	2061	0.1946	3,856	\$750	420	\$82	4,496	\$875	8,772	\$1,707	0.05	0.1446	\$1,268.11
47	2062	0.1957	3,856	\$755	420	\$82	4,496	\$880	8,772	\$1,717	0.05	0.1457	\$1,277.98
48	2063	0.1968	3,856	\$759	420	\$83	4,496	\$885	8,772	\$1,727	0.05	0.1468	\$1,287.91
49	2064	0.1980	3,856	\$763	420	\$83	4,496	\$890	8,772	\$1,736	0.05	0.1480	\$1,297.90
50	2065	0.1991	3,856	\$768	420	\$84	4,496	\$895	8,772	\$1,747	0.05	0.1491	\$1,307.94
51	2066	0.2003	3,856	\$772	420	\$84	4,496	\$900	8,772	\$1,757	0.05	0.1503	\$1,318.05
52	2067	0.2014	3,856	\$777	420	\$85	4,496	\$906	8,772	\$1,767	0.05	0.1514	\$1,328.21
53	2068	0.2026	3,856	\$781	420	\$85	4,496	\$911	8,772	\$1,777	0.05	0.1526	\$1,338.43
54	2069	0.2038	3,856	\$786	420	\$86	4,496	\$916	8,772	\$1,787	0.05	0.1538	\$1,348.71
55	2070	0.2049	3,856	\$790	420	\$86	4,496	\$921	8,772	\$1,798	0.05	0.1549	\$1,359.05
56	2071	0.2061	3,856	\$795	420	\$87	4,496	\$927	8,772	\$1,808	0.05	0.1561	\$1,369.45
57	2072	0.2073	3,856	\$799	420	\$87	4,496	\$932	8,772	\$1,819	0.05	0.1573	\$1,379.91
58	2073	0.2085	3,856	\$804	420	\$88	4,496	\$937	8,772	\$1,829	0.05	0.1585	\$1,390.43
59	2074	0.2097	3,856	\$809	420	\$88	4,496	\$943	8,772	\$1,840	0.05	0.1597	\$1,401.01
60	2075	0.2109	3,856	\$813	420	\$89	4,496	\$948	8,772	\$1,850	0.05	0.1609	\$1,411.65

Table D2-1.10: Annual Operating Costs (V.GSHP) of a 2,000 square feet detached house above grade (improved construction type) in the city of Hamilton (two life cycles and three life cycles for a 60 year project lifespan); base case scenario in comparison with feed in-tariff (FIT) scenario. In the FIT scenario, an incentive of \$0.05/KWh is provided on electricity bills throughout the project lifespan

Horizontal Ground Source Heat Pump (H.GSHP)

Base Case Scenario											Feed in Tariff (FIT)		
#	Year	H.GSHP									FIT		
		Electricity Rates \$/KWh	Heating KWh	Heating Operating Cost \$	Cooling KWh	Cooling Operating Cost \$	Hot Water KWh	Hot Water Operating Cost \$	Total KWh	Total Operating Cost \$	Incentives (\$/KWh)	S/KWh	Operating Cost
1	2016	0.1501	3,924	\$589	430	\$65	4,492	\$674	8,846	\$1,328	0.05	0.1001	\$885.33
2	2017	0.1542	3,924	\$605	430	\$66	4,492	\$693	8,846	\$1,364	0.05	0.1042	\$921.64
3	2018	0.1583	3,924	\$621	430	\$68	4,492	\$711	8,846	\$1,400	0.05	0.1083	\$957.94
4	2019	0.1625	3,924	\$638	430	\$70	4,492	\$730	8,846	\$1,438	0.05	0.1125	\$995.52
5	2020	0.1668	3,924	\$654	430	\$72	4,492	\$749	8,846	\$1,475	0.05	0.1168	\$1,033.09
6	2021	0.1621	3,924	\$636	430	\$70	4,492	\$728	8,846	\$1,434	0.05	0.1121	\$992.01
7	2022	0.1629	3,924	\$639	430	\$70	4,492	\$732	8,846	\$1,441	0.05	0.1129	\$999.02
8	2023	0.1639	3,924	\$643	430	\$70	4,492	\$736	8,846	\$1,450	0.05	0.1139	\$1,007.30
9	2024	0.1648	3,924	\$647	430	\$71	4,492	\$740	8,846	\$1,458	0.05	0.1148	\$1,015.58
10	2025	0.1656	3,924	\$650	430	\$71	4,492	\$744	8,846	\$1,465	0.05	0.1156	\$1,022.59
11	2026	0.1665	3,924	\$653	430	\$72	4,492	\$748	8,846	\$1,473	0.05	0.1165	\$1,030.87
12	2027	0.1674	3,924	\$657	430	\$72	4,492	\$752	8,846	\$1,481	0.05	0.1174	\$1,038.83
13	2028	0.1683	3,924	\$660	430	\$72	4,492	\$756	8,846	\$1,488	0.05	0.1183	\$1,046.15
14	2029	0.1692	3,924	\$664	430	\$73	4,492	\$760	8,846	\$1,496	0.05	0.1192	\$1,054.11
15	2030	0.1701	3,924	\$667	430	\$73	4,492	\$764	8,846	\$1,505	0.05	0.1201	\$1,062.39
16	2031	0.1704	3,924	\$668	430	\$73	4,492	\$765	8,846	\$1,507	0.05	0.1204	\$1,064.62
17	2032	0.1705	3,924	\$669	430	\$73	4,492	\$766	8,846	\$1,508	0.05	0.1205	\$1,065.90
18	2033	0.1707	3,924	\$670	430	\$73	4,492	\$767	8,846	\$1,510	0.05	0.1207	\$1,068.12
19	2034	0.1710	3,924	\$671	430	\$74	4,492	\$768	8,846	\$1,513	0.05	0.1210	\$1,070.67
20	2035	0.1713	3,924	\$672	430	\$74	4,492	\$769	8,846	\$1,515	0.05	0.1213	\$1,072.90
21	2036	0.1714	3,924	\$673	430	\$74	4,492	\$770	8,846	\$1,516	0.05	0.1214	\$1,074.18
22	2037	0.1717	3,924	\$674	430	\$74	4,492	\$771	8,846	\$1,519	0.05	0.1217	\$1,076.40
23	2038	0.1720	3,924	\$675	430	\$74	4,492	\$772	8,846	\$1,521	0.05	0.1220	\$1,078.95
24	2039	0.1722	3,924	\$676	430	\$74	4,492	\$774	8,846	\$1,523	0.05	0.1222	\$1,081.18
25	2040	0.1724	3,924	\$676	430	\$74	4,492	\$774	8,846	\$1,525	0.05	0.1224	\$1,082.46
26	2041	0.1734	3,924	\$680	430	\$75	4,492	\$779	8,846	\$1,534	0.05	0.1234	\$1,091.28
27	2042	0.1744	3,924	\$684	430	\$75	4,492	\$783	8,846	\$1,542	0.05	0.1244	\$1,100.15
28	2043	0.1754	3,924	\$688	430	\$75	4,492	\$788	8,846	\$1,551	0.05	0.1254	\$1,109.07
29	2044	0.1764	3,924	\$692	430	\$76	4,492	\$792	8,846	\$1,560	0.05	0.1264	\$1,118.04
30	2045	0.1774	3,924	\$696	430	\$76	4,492	\$797	8,846	\$1,569	0.05	0.1274	\$1,127.07
31	2046	0.1784	3,924	\$700	430	\$77	4,492	\$802	8,846	\$1,578	0.05	0.1284	\$1,136.15
32	2047	0.1795	3,924	\$704	430	\$77	4,492	\$806	8,846	\$1,588	0.05	0.1295	\$1,145.28
33	2048	0.1805	3,924	\$708	430	\$78	4,492	\$811	8,846	\$1,597	0.05	0.1305	\$1,154.46
34	2049	0.1816	3,924	\$712	430	\$78	4,492	\$816	8,846	\$1,606	0.05	0.1316	\$1,163.70
35	2050	0.1826	3,924	\$717	430	\$79	4,492	\$820	8,846	\$1,615	0.05	0.1326	\$1,172.99
36	2051	0.1837	3,924	\$721	430	\$79	4,492	\$825	8,846	\$1,625	0.05	0.1337	\$1,182.34
37	2052	0.1847	3,924	\$725	430	\$79	4,492	\$830	8,846	\$1,634	0.05	0.1347	\$1,191.73
38	2053	0.1858	3,924	\$729	430	\$80	4,492	\$835	8,846	\$1,643	0.05	0.1358	\$1,201.19
39	2054	0.1869	3,924	\$733	430	\$80	4,492	\$839	8,846	\$1,653	0.05	0.1369	\$1,210.69
40	2055	0.1879	3,924	\$737	430	\$81	4,492	\$844	8,846	\$1,663	0.05	0.1379	\$1,220.26
41	2056	0.1890	3,924	\$742	430	\$81	4,492	\$849	8,846	\$1,672	0.05	0.1390	\$1,229.87
42	2057	0.1901	3,924	\$746	430	\$82	4,492	\$854	8,846	\$1,682	0.05	0.1401	\$1,239.55
43	2058	0.1912	3,924	\$750	430	\$82	4,492	\$859	8,846	\$1,692	0.05	0.1412	\$1,249.28
44	2059	0.1923	3,924	\$755	430	\$83	4,492	\$864	8,846	\$1,701	0.05	0.1423	\$1,259.06
45	2060	0.1934	3,924	\$759	430	\$83	4,492	\$869	8,846	\$1,711	0.05	0.1434	\$1,268.90
46	2061	0.1946	3,924	\$763	430	\$84	4,492	\$874	8,846	\$1,721	0.05	0.1446	\$1,278.80
47	2062	0.1957	3,924	\$768	430	\$84	4,492	\$879	8,846	\$1,731	0.05	0.1457	\$1,288.76
48	2063	0.1968	3,924	\$772	430	\$85	4,492	\$884	8,846	\$1,741	0.05	0.1468	\$1,298.77
49	2064	0.1980	3,924	\$777	430	\$85	4,492	\$889	8,846	\$1,751	0.05	0.1480	\$1,308.85
50	2065	0.1991	3,924	\$781	430	\$86	4,492	\$894	8,846	\$1,761	0.05	0.1491	\$1,318.98
51	2066	0.2003	3,924	\$786	430	\$86	4,492	\$900	8,846	\$1,771	0.05	0.1503	\$1,329.16
52	2067	0.2014	3,924	\$790	430	\$87	4,492	\$905	8,846	\$1,782	0.05	0.1514	\$1,339.41
53	2068	0.2026	3,924	\$795	430	\$87	4,492	\$910	8,846	\$1,792	0.05	0.1526	\$1,349.72
54	2069	0.2038	3,924	\$800	430	\$88	4,492	\$915	8,846	\$1,802	0.05	0.1538	\$1,360.09
55	2070	0.2049	3,924	\$804	430	\$88	4,492	\$921	8,846	\$1,813	0.05	0.1549	\$1,370.51
56	2071	0.2061	3,924	\$809	430	\$89	4,492	\$926	8,846	\$1,823	0.05	0.1561	\$1,381.00
57	2072	0.2073	3,924	\$813	430	\$89	4,492	\$931	8,846	\$1,834	0.05	0.1573	\$1,391.55
58	2073	0.2085	3,924	\$818	430	\$90	4,492	\$937	8,846	\$1,844	0.05	0.1585	\$1,402.16
59	2074	0.2097	3,924	\$823	430	\$90	4,492	\$942	8,846	\$1,855	0.05	0.1597	\$1,412.83
60	2075	0.2109	3,924	\$828	430	\$91	4,492	\$947	8,846	\$1,866	0.05	0.1609	\$1,423.56

Table D2-1.11: Annual Operating Costs (H.GSHP) of a 2,000 square feet detached house above grade (improved construction type) in the city of Hamilton (two life cycles and three life cycles for a 60 year project lifespan); base case scenario in comparison with feed-in-tariff (FIT) scenario. In the FIT scenario, an incentive of \$0.05/KWh is provided on electricity bills throughout the project lifespan

Traditional HVAC Applications

Base Case Scenario																Carbon Taxes						
#	Year	Electricity Rates \$/KWh	Natural Gas Rates \$/m ³	Traditional												Total	Conversion of m ² into Tons	Total Tons	Carbon Tax	Operating Costs		
				Heating		Heating Operating Cost \$ (Electricity)	Heating Operating Cost \$ (Gas)	Total Heating Operating Cost \$	Cooling		Hot Water m ³	Hot Water Operating Cost \$	Total KWh	Total m ³	Total Electricity Operating Cost \$ (KWh)						Total Natural Gas Operating Cost \$ (m ³)	
				KWh (Electricity)	m ³ (Gas)				KWh	\$												
1	2016	0.1501	0.3458	1,558	1,961	\$234	\$678	\$912	1,881	\$282	1,030	\$356	3,439	2,991	516	\$1,034	\$1,551	5.41	5.41	\$10	\$54.14	\$1,604.65
2	2017	0.1542	0.3588	1,558	1,961	\$240	\$704	\$944	1,881	\$290	1,030	\$159	3,439	2,991	530	\$1,073	\$1,604	5.41	5.41	\$20	\$108.27	\$1,711.80
3	2018	0.1583	0.3718	1,558	1,961	\$247	\$729	\$976	1,881	\$298	1,030	\$163	3,439	2,991	544	\$1,112	\$1,657	5.41	5.41	\$30	\$162.41	\$1,818.96
4	2019	0.1625	0.3776	1,558	1,961	\$253	\$740	\$994	1,881	\$306	1,030	\$167	3,439	2,991	559	\$1,129	\$1,688	5.41	5.41	\$40	\$216.55	\$1,904.87
5	2020	0.1668	0.3841	1,558	1,961	\$260	\$753	\$1,013	1,881	\$314	1,030	\$172	3,439	2,991	574	\$1,149	\$1,722	5.41	5.41	\$50	\$270.69	\$1,993.07
6	2021	0.1621	0.3883	1,558	1,961	\$253	\$761	\$1,014	1,881	\$305	1,030	\$167	3,439	2,991	558	\$1,161	\$1,719	5.41	5.41	\$60	\$324.82	\$2,043.82
7	2022	0.1629	0.3929	1,558	1,961	\$254	\$770	\$1,024	1,881	\$306	1,030	\$168	3,439	2,991	560	\$1,175	\$1,735	5.41	5.41	\$70	\$378.96	\$2,114.41
8	2023	0.1639	0.3967	1,558	1,961	\$255	\$778	\$1,033	1,881	\$308	1,030	\$169	3,439	2,991	564	\$1,187	\$1,750	5.41	5.41	\$80	\$433.10	\$2,183.21
9	2024	0.1648	0.4005	1,558	1,961	\$257	\$785	\$1,042	1,881	\$310	1,030	\$170	3,439	2,991	567	\$1,198	\$1,765	5.41	5.41	\$90	\$487.23	\$2,252.01
10	2025	0.1656	0.4040	1,558	1,961	\$258	\$792	\$1,050	1,881	\$311	1,030	\$171	3,439	2,991	569	\$1,208	\$1,778	5.41	5.41	\$100	\$541.37	\$2,319.16
11	2026	0.1665	0.4070	1,558	1,961	\$259	\$798	\$1,058	1,881	\$313	1,030	\$172	3,439	2,991	573	\$1,217	\$1,790	5.41	5.41	\$110	\$595.51	\$2,385.67
12	2027	0.1674	0.4097	1,558	1,961	\$261	\$803	\$1,064	1,881	\$315	1,030	\$172	3,439	2,991	576	\$1,225	\$1,801	5.41	5.41	\$120	\$649.65	\$2,450.92
13	2028	0.1683	0.4124	1,558	1,961	\$262	\$809	\$1,071	1,881	\$317	1,030	\$173	3,439	2,991	579	\$1,233	\$1,812	5.41	5.41	\$130	\$703.78	\$2,515.91
14	2029	0.1692	0.4151	1,558	1,961	\$264	\$814	\$1,078	1,881	\$318	1,030	\$174	3,439	2,991	582	\$1,241	\$1,823	5.41	5.41	\$140	\$757.92	\$2,581.15
15	2030	0.1701	0.4170	1,558	1,961	\$265	\$818	\$1,083	1,881	\$320	1,030	\$175	3,439	2,991	585	\$1,247	\$1,832	5.41	5.41	\$150	\$812.06	\$2,644.23
16	2031	0.1704	0.4189	1,558	1,961	\$265	\$821	\$1,087	1,881	\$320	1,030	\$175	3,439	2,991	586	\$1,253	\$1,839	5.41	5.41	\$160	\$866.19	\$2,704.95
17	2032	0.1705	0.4204	1,558	1,961	\$266	\$824	\$1,090	1,881	\$321	1,030	\$176	3,439	2,991	586	\$1,258	\$1,844	5.41	5.41	\$170	\$920.33	\$2,764.16
18	2033	0.1707	0.4223	1,558	1,961	\$266	\$828	\$1,094	1,881	\$321	1,030	\$176	3,439	2,991	587	\$1,263	\$1,850	5.41	5.41	\$180	\$974.47	\$2,824.89
19	2034	0.1710	0.4246	1,558	1,961	\$266	\$833	\$1,099	1,881	\$322	1,030	\$176	3,439	2,991	588	\$1,270	\$1,858	5.41	5.41	\$190	\$1,028.60	\$2,886.88
20	2035	0.1713	0.4265	1,558	1,961	\$267	\$836	\$1,103	1,881	\$322	1,030	\$176	3,439	2,991	589	\$1,276	\$1,865	5.41	5.41	\$200	\$1,082.74	\$2,947.61
21	2036	0.1714	0.4288	1,558	1,961	\$267	\$841	\$1,108	1,881	\$322	1,030	\$177	3,439	2,991	590	\$1,283	\$1,872	5.41	5.41	\$210	\$1,136.88	\$3,009.10
22	2037	0.1717	0.4311	1,558	1,961	\$267	\$845	\$1,113	1,881	\$323	1,030	\$177	3,439	2,991	590	\$1,290	\$1,880	5.41	5.41	\$220	\$1,191.02	\$3,070.97
23	2038	0.1720	0.4331	1,558	1,961	\$268	\$849	\$1,117	1,881	\$323	1,030	\$177	3,439	2,991	591	\$1,295	\$1,887	5.41	5.41	\$230	\$1,245.15	\$3,131.82
24	2039	0.1722	0.4353	1,558	1,961	\$268	\$854	\$1,122	1,881	\$324	1,030	\$177	3,439	2,991	592	\$1,302	\$1,894	5.41	5.41	\$240	\$1,299.29	\$3,193.69
25	2040	0.1724	0.4376	1,558	1,961	\$269	\$858	\$1,127	1,881	\$324	1,030	\$178	3,439	2,991	593	\$1,309	\$1,902	5.41	5.41	\$250	\$1,353.43	\$3,255.19
26	2041	0.1734	0.4420	1,558	1,961	\$270	\$867	\$1,137	1,881	\$326	1,030	\$179	3,439	2,991	596	\$1,322	\$1,918	5.41	5.41	\$260	\$1,407.56	\$3,325.66
27	2042	0.1744	0.4463	1,558	1,961	\$272	\$875	\$1,147	1,881	\$328	1,030	\$180	3,439	2,991	600	\$1,335	\$1,935	5.41	5.41	\$270	\$1,461.70	\$3,396.28
28	2043	0.1754	0.4507	1,558	1,961	\$273	\$884	\$1,157	1,881	\$330	1,030	\$181	3,439	2,991	603	\$1,348	\$1,951	5.41	5.41	\$280	\$1,515.84	\$3,467.05
29	2044	0.1764	0.4552	1,558	1,961	\$275	\$893	\$1,167	1,881	\$332	1,030	\$182	3,439	2,991	607	\$1,361	\$1,968	5.41	5.41	\$290	\$1,569.98	\$3,537.96
30	2045	0.1774	0.4596	1,558	1,961	\$276	\$901	\$1,178	1,881	\$334	1,030	\$183	3,439	2,991	610	\$1,375	\$1,985	5.41	5.41	\$300	\$1,624.11	\$3,609.03
31	2046	0.1784	0.4642	1,558	1,961	\$278	\$910	\$1,188	1,881	\$336	1,030	\$184	3,439	2,991	614	\$1,388	\$2,002	5.41	5.41	\$310	\$1,678.25	\$3,680.25
32	2047	0.1795	0.4688	1,558	1,961	\$280	\$919	\$1,199	1,881	\$338	1,030	\$185	3,439	2,991	617	\$1,402	\$2,019	5.41	5.41	\$320	\$1,732.39	\$3,751.63
33	2048	0.1805	0.4734	1,558	1,961	\$281	\$928	\$1,210	1,881	\$340	1,030	\$186	3,439	2,991	621	\$1,416	\$2,037	5.41	5.41	\$330	\$1,786.52	\$3,823.16
34	2049	0.1816	0.4780	1,558	1,961	\$283	\$937	\$1,220	1,881	\$341	1,030	\$187	3,439	2,991	624	\$1,430	\$2,054	5.41	5.41	\$340	\$1,840.66	\$3,894.84
35	2050	0.1826	0.4828	1,558	1,961	\$284	\$947	\$1,231	1,881	\$343	1,030	\$188	3,439	2,991	628	\$1,444	\$2,072	5.41	5.41	\$350	\$1,894.80	\$3,966.69
36	2051	0.1837	0.4875	1,558	1,961	\$286	\$956	\$1,242	1,881	\$345	1,030	\$189	3,439	2,991	632	\$1,458	\$2,090	5.41	5.41	\$360	\$1,948.94	\$4,038.69
37	2052	0.1847	0.4923	1,558	1,961	\$288	\$965	\$1,253	1,881	\$347	1,030	\$190	3,439	2,991	635	\$1,473	\$2,108	5.41	5.41	\$370	\$2,003.07	\$4,110.86
38	2053	0.1858	0.4972	1,558	1,961	\$289	\$975	\$1,264	1,881	\$349	1,030	\$191	3,439	2,991	639	\$1,487	\$2,126	5.41	5.41	\$380	\$2,057.21	\$4,183.19
39	2054	0.1869	0.5021	1,558	1,961	\$291	\$985	\$1,276	1,881	\$351	1,030	\$192	3,439	2,991	643	\$1,502	\$2,144	5.41	5.41	\$390	\$2,111.35	\$4,255.68
40	2055	0.1879	0.5070	1,558	1,961	\$293	\$994	\$1,287	1,881	\$354	1,030	\$194	3,439	2,991	646	\$1,517	\$2,163	5.41	5.41	\$400	\$2,165.48	\$4,328.34
41	2056	0.1890	0.5120	1,558	1,961	\$295	\$1,004	\$1,299	1,881	\$356	1,030	\$195	3,439	2,991	650	\$1,531	\$2,182	5.41	5.41	\$410	\$2,219.62	\$4,401.17
42	2057	0.1901	0.5171	1,558	1,961	\$296	\$1,014	\$1,310	1,881	\$358	1,030	\$196	3,439	2,991	654	\$1,547	\$2,200	5.41	5.41	\$420	\$2,273.76	\$4,474.17
43	2058	0.1912	0.5222	1,558	1,961	\$298	\$1,024	\$1,322	1,881	\$360	1,030	\$197	3,439	2,991	658	\$1,562	\$2,219	5.41	5.41	\$430	\$2,327.90	\$4,547.34
44	2059	0.1923	0.5273	1,558	1,961	\$300	\$1,034	\$1,334	1,881	\$362	1,030	\$198	3,439	2,991	661	\$1,577	\$2,239	5.41	5.41	\$440	\$2,382.03	\$4,620.67
45	2060	0.1934	0.5325	1,558	1,961	\$301	\$1,044	\$1,346	1,881	\$364	1,030	\$199	3,439	2,991	665	\$1,593	\$2,258	5.41	5.41	\$450	\$2,436.17	\$4,694.19
46	2061	0.1946	0.5378	1,558	1,961	\$303	\$1,055	\$1,358	1,881	\$366	1,030	\$200	3,439	2,991	669	\$1,608	\$2,278	5.41	5.41	\$460	\$2,490.31	\$4,767.88
47	2062	0.1957	0.5431	1,558	1,961	\$305	\$1,065	\$1,370	1,881	\$368	1,030	\$202	3,439	2,991	673	\$1,624	\$2,297	5.41	5.41	\$470	\$2,544.44	\$4,841.74
48	2063	0.1968	0.5484	1,558	1,961	\$307	\$1,075	\$1,382	1,881	\$370	1,030	\$203	3,439	2,991	677	\$1,640	\$2,317	5.41	5.41	\$480	\$2,598.58	\$4,915.79
49	2064	0.1980	0.5538	1,558	1,961	\$308	\$1,086	\$1,394	1,881	\$372	1,030	\$204	3,439	2,991	681	\$1,657	\$2,337	5.41	5.41	\$490	\$2,652.72	\$4,990.01
50	2065	0.1991	0.5593	1,558	1,961	\$310	\$1,097	\$1,407	1,881	\$375	1,030	\$205	3,439	2,991	685	\$1,673	\$2,358	5.41	5.41	\$500	\$2,706.86	\$5,064.42
51	2066	0.2003	0.5648	1,558	1,961	\$312	\$1,108	\$1,420	1,881	\$377	1,030	\$206	3,439	2,991	689	\$1,689	\$2,378	5.41	5.41	\$510	\$2,760.99	\$5,139.01
52	2067	0.2014	0.5704	1,558	1,961	\$314	\$1,119	\$1,432	1,881	\$379	1,030	\$207	3,439	2,991	693	\$1,706	\$2,399	5.41	5.41	\$520	\$2,815.13	\$5,213.78
53	2068	0.2026	0.5760	1,558	1,961	\$316	\$1,130	\$1,445	1,881	\$381	1,030	\$209	3,439	2,991	697	\$1,723	\$2,419	5.41	5.41	\$530	\$2,869.27	\$5,288.75

5. Kingston (South) – Annual Operating Costs

Vertical Ground Source Heat Pump (V.GSHP)

Base Case Scenario											Feed in Tariff (FIT)		
#	Year	V.GSHP									FIT		
		Electricity Rates \$/KWh	Heating KWh	Heating Operating Cost \$	Cooling KWh	Cooling Operating Cost \$	Hot Water KWh	Hot Water Operating Cost \$	Total KWh	Total Operating Cost \$	Incentives (\$/KWh)	S/KWh	Operating Cost
1	2016	0.1501	4,433	\$665	238	\$36	4,887	\$733	9,558	\$1,434	0.05	0.1001	\$956.59
2	2017	0.1542	4,433	\$684	238	\$37	4,887	\$754	9,558	\$1,474	0.05	0.1042	\$995.82
3	2018	0.1583	4,433	\$702	238	\$38	4,887	\$774	9,558	\$1,513	0.05	0.1083	\$1,035.04
4	2019	0.1625	4,433	\$721	238	\$39	4,887	\$794	9,558	\$1,554	0.05	0.1125	\$1,075.64
5	2020	0.1668	4,433	\$739	238	\$40	4,887	\$815	9,558	\$1,594	0.05	0.1168	\$1,116.25
6	2021	0.1621	4,433	\$719	238	\$39	4,887	\$792	9,558	\$1,550	0.05	0.1121	\$1,071.86
7	2022	0.1629	4,433	\$722	238	\$39	4,887	\$796	9,558	\$1,557	0.05	0.1129	\$1,079.43
8	2023	0.1639	4,433	\$726	238	\$39	4,887	\$801	9,558	\$1,566	0.05	0.1139	\$1,088.38
9	2024	0.1648	4,433	\$731	238	\$39	4,887	\$805	9,558	\$1,575	0.05	0.1148	\$1,097.32
10	2025	0.1656	4,433	\$734	238	\$39	4,887	\$809	9,558	\$1,583	0.05	0.1156	\$1,104.89
11	2026	0.1665	4,433	\$738	238	\$40	4,887	\$814	9,558	\$1,592	0.05	0.1165	\$1,113.84
12	2027	0.1674	4,433	\$742	238	\$40	4,887	\$818	9,558	\$1,600	0.05	0.1174	\$1,122.44
13	2028	0.1683	4,433	\$746	238	\$40	4,887	\$822	9,558	\$1,608	0.05	0.1183	\$1,130.35
14	2029	0.1692	4,433	\$750	238	\$40	4,887	\$827	9,558	\$1,617	0.05	0.1192	\$1,138.96
15	2030	0.1701	4,433	\$754	238	\$40	4,887	\$831	9,558	\$1,626	0.05	0.1201	\$1,147.90
16	2031	0.1704	4,433	\$755	238	\$41	4,887	\$833	9,558	\$1,628	0.05	0.1204	\$1,150.31
17	2032	0.1705	4,433	\$756	238	\$41	4,887	\$833	9,558	\$1,630	0.05	0.1205	\$1,151.69
18	2033	0.1707	4,433	\$757	238	\$41	4,887	\$834	9,558	\$1,632	0.05	0.1207	\$1,154.10
19	2034	0.1710	4,433	\$758	238	\$41	4,887	\$836	9,558	\$1,635	0.05	0.1210	\$1,156.85
20	2035	0.1713	4,433	\$759	238	\$41	4,887	\$837	9,558	\$1,637	0.05	0.1213	\$1,159.26
21	2036	0.1714	4,433	\$760	238	\$41	4,887	\$838	9,558	\$1,639	0.05	0.1214	\$1,160.63
22	2037	0.1717	4,433	\$761	238	\$41	4,887	\$839	9,558	\$1,641	0.05	0.1217	\$1,163.04
23	2038	0.1720	4,433	\$762	238	\$41	4,887	\$840	9,558	\$1,644	0.05	0.1220	\$1,165.80
24	2039	0.1722	4,433	\$763	238	\$41	4,887	\$842	9,558	\$1,646	0.05	0.1222	\$1,168.20
25	2040	0.1724	4,433	\$764	238	\$41	4,887	\$842	9,558	\$1,647	0.05	0.1224	\$1,169.58
26	2041	0.1734	4,433	\$769	238	\$41	4,887	\$847	9,558	\$1,657	0.05	0.1234	\$1,179.11
27	2042	0.1744	4,433	\$773	238	\$41	4,887	\$852	9,558	\$1,667	0.05	0.1244	\$1,188.70
28	2043	0.1754	4,433	\$777	238	\$42	4,887	\$857	9,558	\$1,676	0.05	0.1254	\$1,198.34
29	2044	0.1764	4,433	\$782	238	\$42	4,887	\$862	9,558	\$1,686	0.05	0.1264	\$1,208.03
30	2045	0.1774	4,433	\$786	238	\$42	4,887	\$867	9,558	\$1,696	0.05	0.1274	\$1,217.79
31	2046	0.1784	4,433	\$791	238	\$42	4,887	\$872	9,558	\$1,705	0.05	0.1284	\$1,227.60
32	2047	0.1795	4,433	\$796	238	\$43	4,887	\$877	9,558	\$1,715	0.05	0.1295	\$1,237.46
33	2048	0.1805	4,433	\$800	238	\$43	4,887	\$882	9,558	\$1,725	0.05	0.1305	\$1,247.39
34	2049	0.1816	4,433	\$805	238	\$43	4,887	\$887	9,558	\$1,735	0.05	0.1316	\$1,257.37
35	2050	0.1826	4,433	\$809	238	\$43	4,887	\$892	9,558	\$1,745	0.05	0.1326	\$1,267.40
36	2051	0.1837	4,433	\$814	238	\$44	4,887	\$898	9,558	\$1,755	0.05	0.1337	\$1,277.50
37	2052	0.1847	4,433	\$819	238	\$44	4,887	\$903	9,558	\$1,766	0.05	0.1347	\$1,287.66
38	2053	0.1858	4,433	\$824	238	\$44	4,887	\$908	9,558	\$1,776	0.05	0.1358	\$1,297.87
39	2054	0.1869	4,433	\$828	238	\$44	4,887	\$913	9,558	\$1,786	0.05	0.1369	\$1,308.14
40	2055	0.1879	4,433	\$833	238	\$45	4,887	\$918	9,558	\$1,796	0.05	0.1379	\$1,318.47
41	2056	0.1890	4,433	\$838	238	\$45	4,887	\$924	9,558	\$1,807	0.05	0.1390	\$1,328.87
42	2057	0.1901	4,433	\$843	238	\$45	4,887	\$929	9,558	\$1,817	0.05	0.1401	\$1,339.32
43	2058	0.1912	4,433	\$848	238	\$46	4,887	\$935	9,558	\$1,828	0.05	0.1412	\$1,349.83
44	2059	0.1923	4,433	\$853	238	\$46	4,887	\$940	9,558	\$1,838	0.05	0.1423	\$1,360.40
45	2060	0.1934	4,433	\$858	238	\$46	4,887	\$945	9,558	\$1,849	0.05	0.1434	\$1,371.04
46	2061	0.1946	4,433	\$862	238	\$46	4,887	\$951	9,558	\$1,860	0.05	0.1446	\$1,381.73
47	2062	0.1957	4,433	\$867	238	\$47	4,887	\$956	9,558	\$1,870	0.05	0.1457	\$1,392.49
48	2063	0.1968	4,433	\$873	238	\$47	4,887	\$962	9,558	\$1,881	0.05	0.1468	\$1,403.31
49	2064	0.1980	4,433	\$878	238	\$47	4,887	\$967	9,558	\$1,892	0.05	0.1480	\$1,414.19
50	2065	0.1991	4,433	\$883	238	\$47	4,887	\$973	9,558	\$1,903	0.05	0.1491	\$1,425.14
51	2066	0.2003	4,433	\$888	238	\$48	4,887	\$979	9,558	\$1,914	0.05	0.1503	\$1,436.15
52	2067	0.2014	4,433	\$893	238	\$48	4,887	\$984	9,558	\$1,925	0.05	0.1514	\$1,447.22
53	2068	0.2026	4,433	\$898	238	\$48	4,887	\$990	9,558	\$1,936	0.05	0.1526	\$1,458.36
54	2069	0.2038	4,433	\$903	238	\$48	4,887	\$996	9,558	\$1,947	0.05	0.1538	\$1,469.56
55	2070	0.2049	4,433	\$908	238	\$49	4,887	\$1,001	9,558	\$1,959	0.05	0.1549	\$1,480.82
56	2071	0.2061	4,433	\$914	238	\$49	4,887	\$1,007	9,558	\$1,970	0.05	0.1561	\$1,492.15
57	2072	0.2073	4,433	\$919	238	\$49	4,887	\$1,013	9,558	\$1,981	0.05	0.1573	\$1,503.55
58	2073	0.2085	4,433	\$924	238	\$50	4,887	\$1,019	9,558	\$1,993	0.05	0.1585	\$1,515.01
59	2074	0.2097	4,433	\$930	238	\$50	4,887	\$1,025	9,558	\$2,004	0.05	0.1597	\$1,526.54
60	2075	0.2109	4,433	\$935	238	\$50	4,887	\$1,031	9,558	\$2,016	0.05	0.1609	\$1,538.14

Table D2-1.13: Annual Operating Costs (V.GSHP) of a 2,000 square foot detached house above grade (improved construction type) in the city of Kingston (two life cycles and three life cycles for a 60 year project lifespan); base case scenario in comparison with feed in-tariff (FIT) scenario. In the FIT scenario, an incentive of \$0.05/KWh is provided on electricity bills throughout the project lifespan

Horizontal Ground Source Heat Pump (H.GSHP)

Base Case Scenario											Feed in Tariff (FIT)		
H.GSHP											FIT		
#	Year	Electricity Rates \$/KWh	Heating KWh	Heating Operating Cost \$	Cooling KWh	Cooling Operating Cost \$	Hot Water KWh	Hot Water Operating Cost \$	Total KWh	Total Operating Cost \$	Incentives (\$/KWh)	Operating Cost	Operating Cost
1	2016	0.1501	4,521	\$679	245	\$37	4,868	\$731	9,634	\$1,446	0.05	\$964.20	
2	2017	0.1542	4,521	\$697	245	\$38	4,868	\$751	9,634	\$1,485	0.05	\$1,003.74	
3	2018	0.1583	4,521	\$716	245	\$39	4,868	\$771	9,634	\$1,525	0.05	\$1,043.27	
4	2019	0.1625	4,521	\$735	245	\$40	4,868	\$791	9,634	\$1,566	0.05	\$1,084.20	
5	2020	0.1668	4,521	\$754	245	\$41	4,868	\$812	9,634	\$1,607	0.05	\$1,125.12	
6	2021	0.1621	4,521	\$733	245	\$40	4,868	\$789	9,634	\$1,562	0.05	\$1,080.38	
7	2022	0.1629	4,521	\$737	245	\$40	4,868	\$793	9,634	\$1,570	0.05	\$1,088.01	
8	2023	0.1639	4,521	\$741	245	\$40	4,868	\$798	9,634	\$1,579	0.05	\$1,097.03	
9	2024	0.1648	4,521	\$745	245	\$40	4,868	\$802	9,634	\$1,588	0.05	\$1,106.05	
10	2025	0.1656	4,521	\$749	245	\$41	4,868	\$806	9,634	\$1,595	0.05	\$1,113.68	
11	2026	0.1665	4,521	\$753	245	\$41	4,868	\$811	9,634	\$1,604	0.05	\$1,122.69	
12	2027	0.1674	4,521	\$757	245	\$41	4,868	\$815	9,634	\$1,613	0.05	\$1,131.37	
13	2028	0.1683	4,521	\$761	245	\$41	4,868	\$819	9,634	\$1,621	0.05	\$1,139.34	
14	2029	0.1692	4,521	\$765	245	\$41	4,868	\$823	9,634	\$1,630	0.05	\$1,148.01	
15	2030	0.1701	4,521	\$769	245	\$42	4,868	\$828	9,634	\$1,639	0.05	\$1,157.03	
16	2031	0.1704	4,521	\$770	245	\$42	4,868	\$829	9,634	\$1,641	0.05	\$1,159.46	
17	2032	0.1705	4,521	\$771	245	\$42	4,868	\$830	9,634	\$1,643	0.05	\$1,160.85	
18	2033	0.1707	4,521	\$772	245	\$42	4,868	\$831	9,634	\$1,645	0.05	\$1,163.27	
19	2034	0.1710	4,521	\$773	245	\$42	4,868	\$833	9,634	\$1,648	0.05	\$1,166.05	
20	2035	0.1713	4,521	\$774	245	\$42	4,868	\$834	9,634	\$1,650	0.05	\$1,168.48	
21	2036	0.1714	4,521	\$775	245	\$42	4,868	\$835	9,634	\$1,652	0.05	\$1,169.86	
22	2037	0.1717	4,521	\$776	245	\$42	4,868	\$836	9,634	\$1,654	0.05	\$1,172.29	
23	2038	0.1720	4,521	\$777	245	\$42	4,868	\$837	9,634	\$1,657	0.05	\$1,175.06	
24	2039	0.1722	4,521	\$779	245	\$42	4,868	\$838	9,634	\$1,659	0.05	\$1,177.49	
25	2040	0.1724	4,521	\$779	245	\$42	4,868	\$839	9,634	\$1,661	0.05	\$1,178.88	
26	2041	0.1734	4,521	\$784	245	\$42	4,868	\$844	9,634	\$1,670	0.05	\$1,188.49	
27	2042	0.1744	4,521	\$788	245	\$43	4,868	\$849	9,634	\$1,680	0.05	\$1,198.15	
28	2043	0.1754	4,521	\$793	245	\$43	4,868	\$854	9,634	\$1,690	0.05	\$1,207.87	
29	2044	0.1764	4,521	\$797	245	\$43	4,868	\$859	9,634	\$1,699	0.05	\$1,217.64	
30	2045	0.1774	4,521	\$802	245	\$43	4,868	\$864	9,634	\$1,709	0.05	\$1,227.47	
31	2046	0.1784	4,521	\$807	245	\$44	4,868	\$869	9,634	\$1,719	0.05	\$1,237.36	
32	2047	0.1795	4,521	\$811	245	\$44	4,868	\$874	9,634	\$1,729	0.05	\$1,247.30	
33	2048	0.1805	4,521	\$816	245	\$44	4,868	\$879	9,634	\$1,739	0.05	\$1,257.30	
34	2049	0.1816	4,521	\$821	245	\$44	4,868	\$884	9,634	\$1,749	0.05	\$1,267.36	
35	2050	0.1826	4,521	\$826	245	\$45	4,868	\$889	9,634	\$1,759	0.05	\$1,277.48	
36	2051	0.1837	4,521	\$830	245	\$45	4,868	\$894	9,634	\$1,769	0.05	\$1,287.66	
37	2052	0.1847	4,521	\$835	245	\$45	4,868	\$899	9,634	\$1,780	0.05	\$1,297.89	
38	2053	0.1858	4,521	\$840	245	\$46	4,868	\$904	9,634	\$1,790	0.05	\$1,308.19	
39	2054	0.1869	4,521	\$845	245	\$46	4,868	\$910	9,634	\$1,800	0.05	\$1,318.54	
40	2055	0.1879	4,521	\$850	245	\$46	4,868	\$915	9,634	\$1,811	0.05	\$1,328.96	
41	2056	0.1890	4,521	\$855	245	\$46	4,868	\$920	9,634	\$1,821	0.05	\$1,339.43	
42	2057	0.1901	4,521	\$860	245	\$47	4,868	\$926	9,634	\$1,832	0.05	\$1,349.97	
43	2058	0.1912	4,521	\$865	245	\$47	4,868	\$931	9,634	\$1,842	0.05	\$1,360.56	
44	2059	0.1923	4,521	\$870	245	\$47	4,868	\$936	9,634	\$1,853	0.05	\$1,371.22	
45	2060	0.1934	4,521	\$875	245	\$47	4,868	\$942	9,634	\$1,864	0.05	\$1,381.94	
46	2061	0.1946	4,521	\$880	245	\$48	4,868	\$947	9,634	\$1,874	0.05	\$1,392.72	
47	2062	0.1957	4,521	\$885	245	\$48	4,868	\$953	9,634	\$1,885	0.05	\$1,403.56	
48	2063	0.1968	4,521	\$890	245	\$48	4,868	\$958	9,634	\$1,896	0.05	\$1,414.47	
49	2064	0.1980	4,521	\$895	245	\$48	4,868	\$964	9,634	\$1,907	0.05	\$1,425.44	
50	2065	0.1991	4,521	\$900	245	\$49	4,868	\$969	9,634	\$1,918	0.05	\$1,436.47	
51	2066	0.2003	4,521	\$905	245	\$49	4,868	\$975	9,634	\$1,929	0.05	\$1,447.57	
52	2067	0.2014	4,521	\$911	245	\$49	4,868	\$980	9,634	\$1,940	0.05	\$1,458.73	
53	2068	0.2026	4,521	\$916	245	\$50	4,868	\$986	9,634	\$1,952	0.05	\$1,469.95	
54	2069	0.2038	4,521	\$921	245	\$50	4,868	\$992	9,634	\$1,963	0.05	\$1,481.24	
55	2070	0.2049	4,521	\$926	245	\$50	4,868	\$998	9,634	\$1,974	0.05	\$1,492.60	
56	2071	0.2061	4,521	\$932	245	\$50	4,868	\$1,003	9,634	\$1,986	0.05	\$1,504.02	
57	2072	0.2073	4,521	\$937	245	\$51	4,868	\$1,009	9,634	\$1,997	0.05	\$1,515.51	
58	2073	0.2085	4,521	\$943	245	\$51	4,868	\$1,015	9,634	\$2,009	0.05	\$1,527.06	
59	2074	0.2097	4,521	\$948	245	\$51	4,868	\$1,021	9,634	\$2,020	0.05	\$1,538.68	
60	2075	0.2109	4,521	\$954	245	\$52	4,868	\$1,027	9,634	\$2,032	0.05	\$1,550.37	

Table D2-1.14: Annual Operating Costs (H.GSHP) of a 2,000 square feet detached house above grade (improved construction type) in the city of Kingston (two life cycles and three life cycles for a 60 year project lifespan); base case scenario in comparison with feed in-tariff (FIT) scenario. In the FIT scenario, an incentive of \$0.05/KWh is provided on electricity bills throughout the project lifespan

Traditional HVAC Applications

Base Case Scenario															Carbon Taxes							
#	Year	Electricity Rates	Natural Gas Rates	Traditional											Total	Conversion of m ³ into Tons	Total Tons	Carbon Tax	Operating Costs			
				Heating		Heating Operating Cost	Heating Operating Cost	Total Heating Operating Cost	Cooling	Cooling Operating Cost		Hot Water	Hot Water Operating Cost	Total						Total	Total Electricity Operating Cost	Total Natural Gas Operating Cost
				KWh (Electricity)	m ³ (Gas)					\$ (Electricity)	\$ (Gas)											
1	2016	0.1501	0.3458	1,921	2,131	\$288	\$737	\$1,025	1,294	1,054	\$365	3,215	3,185	483	\$1,101	\$1,584	5.76	5.76	\$10	\$57.65	\$1,641.63	
2	2017	0.1542	0.3588	1,921	2,131	\$296	\$765	\$1,061	1,294	1,054	\$363	3,215	3,185	496	\$1,143	\$1,639	5.76	5.76	\$20	\$115.30	\$1,753.90	
3	2018	0.1583	0.3718	1,921	2,131	\$304	\$792	\$1,096	1,294	1,054	\$367	3,215	3,185	509	\$1,184	\$1,693	5.76	5.76	\$30	\$172.95	\$1,866.17	
4	2019	0.1625	0.3776	1,921	2,131	\$312	\$805	\$1,117	1,294	1,054	\$371	3,215	3,185	523	\$1,203	\$1,725	5.76	5.76	\$40	\$230.59	\$1,955.76	
5	2020	0.1668	0.3841	1,921	2,131	\$320	\$818	\$1,139	1,294	1,054	\$376	3,215	3,185	536	\$1,223	\$1,760	5.76	5.76	\$50	\$288.24	\$2,047.77	
6	2021	0.1621	0.3883	1,921	2,131	\$311	\$827	\$1,139	1,294	1,054	\$371	3,215	3,185	521	\$1,237	\$1,758	5.76	5.76	\$60	\$345.89	\$2,103.90	
7	2022	0.1629	0.3929	1,921	2,131	\$313	\$837	\$1,150	1,294	1,054	\$372	3,215	3,185	524	\$1,251	\$1,775	5.76	5.76	\$70	\$403.54	\$2,178.71	
8	2023	0.1639	0.3967	1,921	2,131	\$315	\$845	\$1,160	1,294	1,054	\$373	3,215	3,185	527	\$1,264	\$1,790	5.76	5.76	\$80	\$461.19	\$2,251.55	
9	2024	0.1648	0.4005	1,921	2,131	\$317	\$854	\$1,170	1,294	1,054	\$374	3,215	3,185	530	\$1,276	\$1,806	5.76	5.76	\$90	\$518.84	\$2,324.40	
10	2025	0.1656	0.4040	1,921	2,131	\$318	\$861	\$1,179	1,294	1,054	\$375	3,215	3,185	532	\$1,287	\$1,819	5.76	5.76	\$100	\$576.49	\$2,395.56	
11	2026	0.1665	0.4070	1,921	2,131	\$320	\$867	\$1,187	1,294	1,054	\$376	3,215	3,185	535	\$1,296	\$1,832	5.76	5.76	\$110	\$634.13	\$2,465.96	
12	2027	0.1674	0.4097	1,921	2,131	\$322	\$873	\$1,195	1,294	1,054	\$377	3,215	3,185	538	\$1,305	\$1,843	5.76	5.76	\$120	\$691.78	\$2,535.03	
13	2028	0.1683	0.4124	1,921	2,131	\$323	\$879	\$1,202	1,294	1,054	\$377	3,215	3,185	541	\$1,313	\$1,854	5.76	5.76	\$130	\$749.43	\$2,603.87	
14	2029	0.1692	0.4151	1,921	2,131	\$325	\$885	\$1,209	1,294	1,054	\$378	3,215	3,185	544	\$1,322	\$1,866	5.76	5.76	\$140	\$807.08	\$2,672.94	
15	2030	0.1701	0.4170	1,921	2,131	\$327	\$889	\$1,215	1,294	1,054	\$379	3,215	3,185	547	\$1,328	\$1,875	5.76	5.76	\$150	\$864.73	\$2,739.69	
16	2031	0.1704	0.4189	1,921	2,131	\$327	\$893	\$1,220	1,294	1,054	\$380	3,215	3,185	548	\$1,334	\$1,882	5.76	5.76	\$160	\$922.38	\$2,804.24	
17	2032	0.1705	0.4204	1,921	2,131	\$328	\$896	\$1,223	1,294	1,054	\$380	3,215	3,185	548	\$1,339	\$1,887	5.76	5.76	\$170	\$980.02	\$2,867.23	
18	2033	0.1707	0.4223	1,921	2,131	\$328	\$900	\$1,228	1,294	1,054	\$380	3,215	3,185	549	\$1,345	\$1,894	5.76	5.76	\$180	\$1,037.67	\$2,931.78	
19	2034	0.1710	0.4246	1,921	2,131	\$329	\$905	\$1,233	1,294	1,054	\$380	3,215	3,185	550	\$1,352	\$1,902	5.76	5.76	\$190	\$1,095.32	\$2,997.67	
20	2035	0.1713	0.4265	1,921	2,131	\$329	\$909	\$1,238	1,294	1,054	\$381	3,215	3,185	551	\$1,359	\$1,909	5.76	5.76	\$200	\$1,152.97	\$3,062.22	
21	2036	0.1714	0.4288	1,921	2,131	\$330	\$914	\$1,243	1,294	1,054	\$381	3,215	3,185	551	\$1,366	\$1,917	5.76	5.76	\$210	\$1,210.62	\$3,127.64	
22	2037	0.1717	0.4311	1,921	2,131	\$330	\$919	\$1,249	1,294	1,054	\$381	3,215	3,185	552	\$1,373	\$1,925	5.76	5.76	\$220	\$1,268.27	\$3,193.41	
23	2038	0.1720	0.4331	1,921	2,131	\$330	\$923	\$1,253	1,294	1,054	\$382	3,215	3,185	553	\$1,379	\$1,932	5.76	5.76	\$230	\$1,325.92	\$3,258.07	
24	2039	0.1722	0.4353	1,921	2,131	\$331	\$928	\$1,259	1,294	1,054	\$382	3,215	3,185	554	\$1,387	\$1,940	5.76	5.76	\$240	\$1,383.56	\$3,323.84	
25	2040	0.1724	0.4376	1,921	2,131	\$331	\$933	\$1,264	1,294	1,054	\$382	3,215	3,185	554	\$1,394	\$1,948	5.76	5.76	\$250	\$1,441.21	\$3,389.27	
26	2041	0.1734	0.4420	1,921	2,131	\$333	\$942	\$1,275	1,294	1,054	\$383	3,215	3,185	557	\$1,408	\$1,965	5.76	5.76	\$260	\$1,498.86	\$3,463.86	
27	2042	0.1744	0.4463	1,921	2,131	\$335	\$951	\$1,286	1,294	1,054	\$384	3,215	3,185	561	\$1,422	\$1,982	5.76	5.76	\$270	\$1,556.51	\$3,538.61	
28	2043	0.1754	0.4507	1,921	2,131	\$337	\$960	\$1,297	1,294	1,054	\$385	3,215	3,185	564	\$1,436	\$1,999	5.76	5.76	\$280	\$1,614.16	\$3,613.52	
29	2044	0.1764	0.4552	1,921	2,131	\$339	\$970	\$1,309	1,294	1,054	\$386	3,215	3,185	567	\$1,450	\$2,017	5.76	5.76	\$290	\$1,671.81	\$3,688.58	
30	2045	0.1774	0.4596	1,921	2,131	\$341	\$980	\$1,320	1,294	1,054	\$387	3,215	3,185	570	\$1,464	\$2,034	5.76	5.76	\$300	\$1,729.46	\$3,763.80	
31	2046	0.1784	0.4642	1,921	2,131	\$343	\$989	\$1,332	1,294	1,054	\$388	3,215	3,185	574	\$1,478	\$2,052	5.76	5.76	\$310	\$1,787.10	\$3,839.18	
32	2047	0.1795	0.4688	1,921	2,131	\$345	\$999	\$1,344	1,294	1,054	\$389	3,215	3,185	577	\$1,493	\$2,070	5.76	5.76	\$320	\$1,844.75	\$3,914.31	
33	2048	0.1805	0.4734	1,921	2,131	\$347	\$1,009	\$1,356	1,294	1,054	\$390	3,215	3,185	580	\$1,508	\$2,088	5.76	5.76	\$330	\$1,902.40	\$3,990.43	
34	2049	0.1816	0.4780	1,921	2,131	\$349	\$1,019	\$1,367	1,294	1,054	\$391	3,215	3,185	584	\$1,523	\$2,106	5.76	5.76	\$340	\$1,960.05	\$4,066.30	
35	2050	0.1826	0.4828	1,921	2,131	\$351	\$1,029	\$1,380	1,294	1,054	\$392	3,215	3,185	587	\$1,538	\$2,125	5.76	5.76	\$350	\$2,017.70	\$4,142.34	
36	2051	0.1837	0.4875	1,921	2,131	\$353	\$1,039	\$1,392	1,294	1,054	\$394	3,215	3,185	590	\$1,553	\$2,143	5.76	5.76	\$360	\$2,075.35	\$4,218.54	
37	2052	0.1847	0.4923	1,921	2,131	\$355	\$1,049	\$1,404	1,294	1,054	\$395	3,215	3,185	594	\$1,568	\$2,162	5.76	5.76	\$370	\$2,132.99	\$4,294.92	
38	2053	0.1858	0.4972	1,921	2,131	\$357	\$1,059	\$1,416	1,294	1,054	\$396	3,215	3,185	597	\$1,584	\$2,181	5.76	5.76	\$380	\$2,190.64	\$4,371.46	
39	2054	0.1869	0.5021	1,921	2,131	\$359	\$1,070	\$1,429	1,294	1,054	\$397	3,215	3,185	601	\$1,599	\$2,200	5.76	5.76	\$390	\$2,248.29	\$4,448.17	
40	2055	0.1879	0.5070	1,921	2,131	\$361	\$1,080	\$1,442	1,294	1,054	\$398	3,215	3,185	604	\$1,615	\$2,219	5.76	5.76	\$400	\$2,305.94	\$4,525.06	
41	2056	0.1890	0.5120	1,921	2,131	\$363	\$1,091	\$1,454	1,294	1,054	\$399	3,215	3,185	608	\$1,631	\$2,239	5.76	5.76	\$410	\$2,363.59	\$4,602.13	
42	2057	0.1901	0.5171	1,921	2,131	\$365	\$1,102	\$1,467	1,294	1,054	\$400	3,215	3,185	611	\$1,647	\$2,258	5.76	5.76	\$420	\$2,421.24	\$4,679.37	
43	2058	0.1912	0.5222	1,921	2,131	\$367	\$1,113	\$1,480	1,294	1,054	\$402	3,215	3,185	615	\$1,663	\$2,278	5.76	5.76	\$430	\$2,478.89	\$4,756.79	
44	2059	0.1923	0.5273	1,921	2,131	\$369	\$1,124	\$1,493	1,294	1,054	\$403	3,215	3,185	618	\$1,680	\$2,298	5.76	5.76	\$440	\$2,536.53	\$4,834.39	
45	2060	0.1934	0.5325	1,921	2,131	\$372	\$1,135	\$1,506	1,294	1,054	\$404	3,215	3,185	622	\$1,696	\$2,318	5.76	5.76	\$450	\$2,594.18	\$4,912.18	
46	2061	0.1946	0.5378	1,921	2,131	\$374	\$1,146	\$1,520	1,294	1,054	\$405	3,215	3,185	626	\$1,713	\$2,338	5.76	5.76	\$460	\$2,651.83	\$4,990.15	
47	2062	0.1957	0.5431	1,921	2,131	\$376	\$1,157	\$1,533	1,294	1,054	\$406	3,215	3,185	629	\$1,730	\$2,359	5.76	5.76	\$470	\$2,709.48	\$5,068.30	
48	2063	0.1968	0.5484	1,921	2,131	\$378	\$1,169	\$1,547	1,294	1,054	\$407	3,215	3,185	633	\$1,747	\$2,380	5.76	5.76	\$480	\$2,767.13	\$5,146.64	
49	2064	0.1980	0.5538	1,921	2,131	\$380	\$1,180	\$1,560	1,294	1,054	\$409	3,215	3,185	636	\$1,764	\$2,400	5.76	5.76	\$490	\$2,824.78	\$5,225.17	
50	2065	0.1991	0.5593	1,921	2,131																	

6. Kitchener-Waterloo (South) – Annual Operating Costs

Vertical Ground Source Heat Pump (V.GSHP)

Base Case Scenario												Feed in Tariff (FIT)		
#	Year	Electricity Rates		V.GSHP		Cooling		Hot Water		Total		FIT		
		\$/KWh	KWh	Heating Operating Cost \$	Cooling Operating Cost \$	Hot Water Operating Cost \$	Total Operating Cost \$	Incentives (\$/KWh)	FIT \$/KWh	Operating Cost				
1	2016	0.1501	4,373	\$656	\$54	\$699	358	4,657	\$699	9,388	\$1,409	0.05	0.1001	\$939.58
2	2017	0.1542	4,373	\$674	\$55	\$718	358	4,657	\$718	9,388	\$1,448	0.05	0.1042	\$978.11
3	2018	0.1583	4,373	\$692	\$57	\$737	358	4,657	\$737	9,388	\$1,486	0.05	0.1083	\$1,016.63
4	2019	0.1625	4,373	\$711	\$58	\$757	358	4,657	\$757	9,388	\$1,526	0.05	0.1125	\$1,056.51
5	2020	0.1668	4,373	\$729	\$60	\$777	358	4,657	\$777	9,388	\$1,566	0.05	0.1168	\$1,096.39
6	2021	0.1621	4,373	\$709	\$58	\$755	358	4,657	\$755	9,388	\$1,522	0.05	0.1121	\$1,052.80
7	2022	0.1629	4,373	\$713	\$58	\$759	358	4,657	\$759	9,388	\$1,530	0.05	0.1129	\$1,060.23
8	2023	0.1639	4,373	\$717	\$59	\$763	358	4,657	\$763	9,388	\$1,538	0.05	0.1139	\$1,069.02
9	2024	0.1648	4,373	\$721	\$59	\$768	358	4,657	\$768	9,388	\$1,547	0.05	0.1148	\$1,077.81
10	2025	0.1656	4,373	\$724	\$59	\$771	358	4,657	\$771	9,388	\$1,555	0.05	0.1156	\$1,085.24
11	2026	0.1665	4,373	\$728	\$60	\$776	358	4,657	\$776	9,388	\$1,563	0.05	0.1165	\$1,094.03
12	2027	0.1674	4,373	\$732	\$60	\$780	358	4,657	\$780	9,388	\$1,572	0.05	0.1174	\$1,102.48
13	2028	0.1683	4,373	\$736	\$61	\$784	358	4,657	\$784	9,388	\$1,580	0.05	0.1183	\$1,110.25
14	2029	0.1692	4,373	\$740	\$61	\$788	358	4,657	\$788	9,388	\$1,588	0.05	0.1192	\$1,118.70
15	2030	0.1701	4,373	\$744	\$61	\$792	358	4,657	\$792	9,388	\$1,597	0.05	0.1201	\$1,127.49
16	2031	0.1704	4,373	\$745	\$61	\$793	358	4,657	\$793	9,388	\$1,599	0.05	0.1204	\$1,129.85
17	2032	0.1705	4,373	\$746	\$61	\$794	358	4,657	\$794	9,388	\$1,601	0.05	0.1205	\$1,131.20
18	2033	0.1707	4,373	\$747	\$61	\$795	358	4,657	\$795	9,388	\$1,603	0.05	0.1207	\$1,133.57
19	2034	0.1710	4,373	\$748	\$61	\$797	358	4,657	\$797	9,388	\$1,606	0.05	0.1210	\$1,136.27
20	2035	0.1713	4,373	\$749	\$61	\$798	358	4,657	\$798	9,388	\$1,608	0.05	0.1213	\$1,138.64
21	2036	0.1714	4,373	\$750	\$61	\$798	358	4,657	\$798	9,388	\$1,609	0.05	0.1214	\$1,139.99
22	2037	0.1717	4,373	\$751	\$61	\$800	358	4,657	\$800	9,388	\$1,612	0.05	0.1217	\$1,142.36
23	2038	0.1720	4,373	\$752	\$62	\$801	358	4,657	\$801	9,388	\$1,614	0.05	0.1220	\$1,145.06
24	2039	0.1722	4,373	\$753	\$62	\$802	358	4,657	\$802	9,388	\$1,617	0.05	0.1222	\$1,147.76
25	2040	0.1724	4,373	\$754	\$62	\$803	358	4,657	\$803	9,388	\$1,618	0.05	0.1224	\$1,148.78
26	2041	0.1734	4,373	\$758	\$62	\$807	358	4,657	\$807	9,388	\$1,628	0.05	0.1234	\$1,158.14
27	2042	0.1744	4,373	\$763	\$62	\$812	358	4,657	\$812	9,388	\$1,637	0.05	0.1244	\$1,167.55
28	2043	0.1754	4,373	\$767	\$63	\$817	358	4,657	\$817	9,388	\$1,646	0.05	0.1254	\$1,177.02
29	2044	0.1764	4,373	\$771	\$63	\$821	358	4,657	\$821	9,388	\$1,656	0.05	0.1264	\$1,186.55
30	2045	0.1774	4,373	\$776	\$64	\$826	358	4,657	\$826	9,388	\$1,666	0.05	0.1274	\$1,196.13
31	2046	0.1784	4,373	\$780	\$64	\$831	358	4,657	\$831	9,388	\$1,675	0.05	0.1284	\$1,205.76
32	2047	0.1795	4,373	\$785	\$64	\$836	358	4,657	\$836	9,388	\$1,685	0.05	0.1295	\$1,215.45
33	2048	0.1805	4,373	\$789	\$65	\$841	358	4,657	\$841	9,388	\$1,695	0.05	0.1305	\$1,225.20
34	2049	0.1816	4,373	\$794	\$65	\$845	358	4,657	\$845	9,388	\$1,704	0.05	0.1316	\$1,235.00
35	2050	0.1826	4,373	\$799	\$65	\$850	358	4,657	\$850	9,388	\$1,714	0.05	0.1326	\$1,244.86
36	2051	0.1837	4,373	\$803	\$66	\$855	358	4,657	\$855	9,388	\$1,724	0.05	0.1337	\$1,254.78
37	2052	0.1847	4,373	\$808	\$66	\$860	358	4,657	\$860	9,388	\$1,734	0.05	0.1347	\$1,264.75
38	2053	0.1858	4,373	\$812	\$67	\$865	358	4,657	\$865	9,388	\$1,744	0.05	0.1358	\$1,274.78
39	2054	0.1869	4,373	\$817	\$67	\$870	358	4,657	\$870	9,388	\$1,754	0.05	0.1369	\$1,284.87
40	2055	0.1879	4,373	\$822	\$67	\$875	358	4,657	\$875	9,388	\$1,764	0.05	0.1379	\$1,295.02
41	2056	0.1890	4,373	\$827	\$68	\$880	358	4,657	\$880	9,388	\$1,775	0.05	0.1390	\$1,305.23
42	2057	0.1901	4,373	\$831	\$68	\$885	358	4,657	\$885	9,388	\$1,785	0.05	0.1401	\$1,315.50
43	2058	0.1912	4,373	\$836	\$68	\$891	358	4,657	\$891	9,388	\$1,795	0.05	0.1412	\$1,325.82
44	2059	0.1923	4,373	\$841	\$69	\$895	358	4,657	\$895	9,388	\$1,806	0.05	0.1423	\$1,336.21
45	2060	0.1934	4,373	\$846	\$69	\$901	358	4,657	\$901	9,388	\$1,816	0.05	0.1434	\$1,346.63
46	2061	0.1946	4,373	\$851	\$70	\$906	358	4,657	\$906	9,388	\$1,827	0.05	0.1446	\$1,357.16
47	2062	0.1957	4,373	\$856	\$70	\$911	358	4,657	\$911	9,388	\$1,837	0.05	0.1457	\$1,367.72
48	2063	0.1968	4,373	\$861	\$70	\$917	358	4,657	\$917	9,388	\$1,848	0.05	0.1468	\$1,378.35
49	2064	0.1980	4,373	\$866	\$71	\$922	358	4,657	\$922	9,388	\$1,858	0.05	0.1480	\$1,389.04
50	2065	0.1991	4,373	\$871	\$71	\$927	358	4,657	\$927	9,388	\$1,869	0.05	0.1491	\$1,399.79
51	2066	0.2003	4,373	\$876	\$72	\$933	358	4,657	\$933	9,388	\$1,880	0.05	0.1503	\$1,410.60
52	2067	0.2014	4,373	\$881	\$72	\$938	358	4,657	\$938	9,388	\$1,891	0.05	0.1514	\$1,421.48
53	2068	0.2026	4,373	\$886	\$73	\$943	358	4,657	\$943	9,388	\$1,902	0.05	0.1526	\$1,432.42
54	2069	0.2038	4,373	\$891	\$73	\$949	358	4,657	\$949	9,388	\$1,913	0.05	0.1538	\$1,443.42
55	2070	0.2049	4,373	\$896	\$73	\$954	358	4,657	\$954	9,388	\$1,924	0.05	0.1549	\$1,454.48
56	2071	0.2061	4,373	\$901	\$74	\$960	358	4,657	\$960	9,388	\$1,935	0.05	0.1561	\$1,465.61
57	2072	0.2073	4,373	\$907	\$74	\$965	358	4,657	\$965	9,388	\$1,946	0.05	0.1573	\$1,476.81
58	2073	0.2085	4,373	\$912	\$75	\$971	358	4,657	\$971	9,388	\$1,957	0.05	0.1585	\$1,488.07
59	2074	0.2097	4,373	\$917	\$75	\$977	358	4,657	\$977	9,388	\$1,969	0.05	0.1597	\$1,499.39
60	2075	0.2109	4,373	\$922	\$76	\$982	358	4,657	\$982	9,388	\$1,980	0.05	0.1609	\$1,510.78

Table D2-1.16: Annual Operating Costs (V.GSHP) of a 2,000 square feet detached house above grade (improved construction type) in the city of Kitchener-Waterloo (two life cycles and three life cycles for a 60 year project lifespan); base case scenario in comparison with feed in-tariff (FIT) scenario. In the FIT scenario, an incentive of \$0.05/KWh is provided on electricity bills throughout the project lifespan

Horizontal Ground Source Heat Pump (H.GSHP)

Base Case Scenario												Feed in Tariff (FIT)		
H.GSHP												FIT		
#	Year	Electricity Rates \$/KWh	Heating KWh	Heating Operating Cost \$	Cooling KWh	Cooling Operating Cost \$	Hot Water KWh	Hot Water Operating Cost \$	Total KWh	Total Operating Cost \$	Incentives (\$/KWh)	Operating Cost		
1	2016	0.1501	4,464	\$670	366	\$55	4,634	\$695	9,464	\$1,420	0.05	\$947.18		
2	2017	0.1542	4,464	\$688	366	\$56	4,634	\$715	9,464	\$1,459	0.05	\$986.02		
3	2018	0.1583	4,464	\$707	366	\$58	4,634	\$734	9,464	\$1,498	0.05	\$1,024.86		
4	2019	0.1625	4,464	\$726	366	\$59	4,634	\$753	9,464	\$1,538	0.05	\$1,065.07		
5	2020	0.1668	4,464	\$745	366	\$61	4,634	\$773	9,464	\$1,578	0.05	\$1,105.27		
6	2021	0.1621	4,464	\$724	366	\$59	4,634	\$751	9,464	\$1,535	0.05	\$1,061.32		
7	2022	0.1629	4,464	\$727	366	\$60	4,634	\$755	9,464	\$1,542	0.05	\$1,068.81		
8	2023	0.1639	4,464	\$732	366	\$60	4,634	\$759	9,464	\$1,551	0.05	\$1,077.67		
9	2024	0.1648	4,464	\$736	366	\$60	4,634	\$764	9,464	\$1,560	0.05	\$1,086.53		
10	2025	0.1656	4,464	\$739	366	\$61	4,634	\$767	9,464	\$1,567	0.05	\$1,094.03		
11	2026	0.1665	4,464	\$743	366	\$61	4,634	\$772	9,464	\$1,576	0.05	\$1,102.88		
12	2027	0.1674	4,464	\$747	366	\$61	4,634	\$776	9,464	\$1,585	0.05	\$1,111.40		
13	2028	0.1683	4,464	\$751	366	\$62	4,634	\$780	9,464	\$1,592	0.05	\$1,119.24		
14	2029	0.1692	4,464	\$755	366	\$62	4,634	\$784	9,464	\$1,601	0.05	\$1,127.76		
15	2030	0.1701	4,464	\$759	366	\$62	4,634	\$788	9,464	\$1,610	0.05	\$1,136.61		
16	2031	0.1704	4,464	\$760	366	\$62	4,634	\$789	9,464	\$1,612	0.05	\$1,139.00		
17	2032	0.1705	4,464	\$761	366	\$62	4,634	\$790	9,464	\$1,614	0.05	\$1,140.36		
18	2033	0.1707	4,464	\$762	366	\$62	4,634	\$791	9,464	\$1,616	0.05	\$1,142.75		
19	2034	0.1710	4,464	\$763	366	\$63	4,634	\$793	9,464	\$1,619	0.05	\$1,145.47		
20	2035	0.1713	4,464	\$765	366	\$63	4,634	\$794	9,464	\$1,621	0.05	\$1,147.86		
21	2036	0.1714	4,464	\$765	366	\$63	4,634	\$794	9,464	\$1,622	0.05	\$1,149.22		
22	2037	0.1717	4,464	\$766	366	\$63	4,634	\$796	9,464	\$1,625	0.05	\$1,151.60		
23	2038	0.1720	4,464	\$768	366	\$63	4,634	\$797	9,464	\$1,628	0.05	\$1,154.33		
24	2039	0.1722	4,464	\$769	366	\$63	4,634	\$798	9,464	\$1,630	0.05	\$1,156.71		
25	2040	0.1724	4,464	\$769	366	\$63	4,634	\$799	9,464	\$1,631	0.05	\$1,158.08		
26	2041	0.1734	4,464	\$774	366	\$63	4,634	\$803	9,464	\$1,641	0.05	\$1,167.51		
27	2042	0.1744	4,464	\$778	366	\$64	4,634	\$808	9,464	\$1,650	0.05	\$1,177.01		
28	2043	0.1754	4,464	\$783	366	\$64	4,634	\$813	9,464	\$1,660	0.05	\$1,186.55		
29	2044	0.1764	4,464	\$787	366	\$65	4,634	\$817	9,464	\$1,669	0.05	\$1,196.15		
30	2045	0.1774	4,464	\$792	366	\$65	4,634	\$822	9,464	\$1,679	0.05	\$1,205.81		
31	2046	0.1784	4,464	\$797	366	\$65	4,634	\$827	9,464	\$1,689	0.05	\$1,215.52		
32	2047	0.1795	4,464	\$801	366	\$66	4,634	\$832	9,464	\$1,698	0.05	\$1,225.29		
33	2048	0.1805	4,464	\$806	366	\$66	4,634	\$836	9,464	\$1,708	0.05	\$1,235.12		
34	2049	0.1816	4,464	\$810	366	\$66	4,634	\$841	9,464	\$1,718	0.05	\$1,245.00		
35	2050	0.1826	4,464	\$815	366	\$67	4,634	\$846	9,464	\$1,728	0.05	\$1,254.94		
36	2051	0.1837	4,464	\$820	366	\$67	4,634	\$851	9,464	\$1,738	0.05	\$1,264.94		
37	2052	0.1847	4,464	\$825	366	\$68	4,634	\$856	9,464	\$1,748	0.05	\$1,274.99		
38	2053	0.1858	4,464	\$829	366	\$68	4,634	\$861	9,464	\$1,758	0.05	\$1,285.10		
39	2054	0.1869	4,464	\$834	366	\$68	4,634	\$866	9,464	\$1,768	0.05	\$1,295.28		
40	2055	0.1879	4,464	\$839	366	\$69	4,634	\$871	9,464	\$1,779	0.05	\$1,305.51		
41	2056	0.1890	4,464	\$844	366	\$69	4,634	\$876	9,464	\$1,789	0.05	\$1,315.80		
42	2057	0.1901	4,464	\$849	366	\$70	4,634	\$881	9,464	\$1,799	0.05	\$1,326.15		
43	2058	0.1912	4,464	\$854	366	\$70	4,634	\$886	9,464	\$1,810	0.05	\$1,336.55		
44	2059	0.1923	4,464	\$859	366	\$70	4,634	\$891	9,464	\$1,820	0.05	\$1,347.02		
45	2060	0.1934	4,464	\$864	366	\$71	4,634	\$896	9,464	\$1,831	0.05	\$1,357.55		
46	2061	0.1946	4,464	\$869	366	\$71	4,634	\$902	9,464	\$1,841	0.05	\$1,368.14		
47	2062	0.1957	4,464	\$874	366	\$72	4,634	\$907	9,464	\$1,852	0.05	\$1,378.80		
48	2063	0.1968	4,464	\$879	366	\$72	4,634	\$912	9,464	\$1,863	0.05	\$1,389.51		
49	2064	0.1980	4,464	\$884	366	\$72	4,634	\$917	9,464	\$1,873	0.05	\$1,400.28		
50	2065	0.1991	4,464	\$889	366	\$73	4,634	\$923	9,464	\$1,884	0.05	\$1,411.12		
51	2066	0.2003	4,464	\$894	366	\$73	4,634	\$928	9,464	\$1,895	0.05	\$1,422.02		
52	2067	0.2014	4,464	\$899	366	\$74	4,634	\$933	9,464	\$1,906	0.05	\$1,432.99		
53	2068	0.2026	4,464	\$904	366	\$74	4,634	\$939	9,464	\$1,917	0.05	\$1,444.01		
54	2069	0.2038	4,464	\$910	366	\$75	4,634	\$944	9,464	\$1,928	0.05	\$1,455.10		
55	2070	0.2049	4,464	\$915	366	\$75	4,634	\$950	9,464	\$1,939	0.05	\$1,466.26		
56	2071	0.2061	4,464	\$920	366	\$75	4,634	\$955	9,464	\$1,951	0.05	\$1,477.48		
57	2072	0.2073	4,464	\$925	366	\$76	4,634	\$961	9,464	\$1,962	0.05	\$1,488.76		
58	2073	0.2085	4,464	\$931	366	\$76	4,634	\$966	9,464	\$1,973	0.05	\$1,500.11		
59	2074	0.2097	4,464	\$936	366	\$77	4,634	\$972	9,464	\$1,985	0.05	\$1,511.53		
60	2075	0.2109	4,464	\$942	366	\$77	4,634	\$977	9,464	\$1,996	0.05	\$1,523.01		

Table D2-1.17: Annual Operating Costs (H.GSHP) of a 2,000 square feet detached house above grade (improved construction type) in the city of Kitchener-Waterloo (two life cycles and three life cycles for a 60 year project lifespan); base case scenario in comparison with feed in-tariff (FIT) scenario. In the FIT scenario, an incentive of \$0.05/KWh is provided on electricity bills throughout the project lifespan

Traditional HVAC Applications

Base Case Scenario															Carbon Taxes						
#	Year	Traditional													Carbon Taxes						
		Electricity Rates \$/KWh	Natural Gas Rates \$/m ³	Heating		Heating Operating Cost \$ (Electricity)	Heating Operating Cost \$ (Gas)	Total Heating Operating Cost \$	Cooling		Hot Water m ³	Hot Water Operating Cost \$	Total KWh	Total m ³	Total Electricity Operating Cost \$ (KWh)	Total Natural Gas Operating Cost \$ (m ³)	Total	Conversion of m ³ into Tons	Total Tons	Carbon Tax	Operating Costs
				KWh (Electricity)	m ³ (Gas)				KWh	Operating Cost											
1	2016	0.1501	0.3458	1,697	2,131	\$255	\$737	1,681	\$992	1,036	\$358	3,378	3,167	507	\$1,095	\$1,602	5.73	5.73	\$10	\$57.32	\$1,659.55
2	2017	0.1542	0.3588	1,697	2,131	\$262	\$765	1,681	\$1,026	1,036	\$160	3,378	3,167	521	\$1,136	\$1,657	5.73	5.73	\$20	\$114.65	\$1,771.93
3	2018	0.1583	0.3718	1,697	2,131	\$269	\$792	1,681	\$1,061	1,036	\$164	3,378	3,167	535	\$1,178	\$1,712	5.73	5.73	\$30	\$171.97	\$1,884.30
4	2019	0.1625	0.3776	1,697	2,131	\$276	\$805	1,681	\$1,080	1,036	\$168	3,378	3,167	549	\$1,196	\$1,745	5.73	5.73	\$40	\$229.29	\$1,974.15
5	2020	0.1668	0.3841	1,697	2,131	\$283	\$818	1,681	\$1,102	1,036	\$173	3,378	3,167	563	\$1,216	\$1,780	5.73	5.73	\$50	\$286.61	\$2,066.42
6	2021	0.1621	0.3883	1,697	2,131	\$275	\$827	1,681	\$1,103	1,036	\$168	3,378	3,167	548	\$1,230	\$1,777	5.73	5.73	\$60	\$343.94	\$2,121.38
7	2022	0.1629	0.3929	1,697	2,131	\$277	\$837	1,681	\$1,114	1,036	\$169	3,378	3,167	550	\$1,244	\$1,795	5.73	5.73	\$70	\$401.26	\$2,195.92
8	2023	0.1639	0.3967	1,697	2,131	\$278	\$845	1,681	\$1,123	1,036	\$170	3,378	3,167	554	\$1,256	\$1,810	5.73	5.73	\$80	\$458.58	\$2,268.52
9	2024	0.1648	0.4005	1,697	2,131	\$280	\$854	1,681	\$1,133	1,036	\$171	3,378	3,167	557	\$1,268	\$1,825	5.73	5.73	\$90	\$515.90	\$2,341.12
10	2025	0.1656	0.4040	1,697	2,131	\$281	\$861	1,681	\$1,142	1,036	\$172	3,378	3,167	559	\$1,279	\$1,839	5.73	5.73	\$100	\$573.23	\$2,412.02
11	2026	0.1665	0.4070	1,697	2,131	\$283	\$867	1,681	\$1,150	1,036	\$173	3,378	3,167	563	\$1,289	\$1,852	5.73	5.73	\$110	\$630.55	\$2,482.20
12	2027	0.1674	0.4097	1,697	2,131	\$284	\$873	1,681	\$1,157	1,036	\$173	3,378	3,167	566	\$1,298	\$1,863	5.73	5.73	\$120	\$687.87	\$2,551.04
13	2028	0.1683	0.4124	1,697	2,131	\$286	\$879	1,681	\$1,164	1,036	\$174	3,378	3,167	568	\$1,306	\$1,874	5.73	5.73	\$130	\$745.20	\$2,619.64
14	2029	0.1692	0.4151	1,697	2,131	\$287	\$885	1,681	\$1,172	1,036	\$175	3,378	3,167	571	\$1,315	\$1,886	5.73	5.73	\$140	\$802.52	\$2,688.48
15	2030	0.1701	0.4170	1,697	2,131	\$289	\$889	1,681	\$1,177	1,036	\$176	3,378	3,167	575	\$1,321	\$1,895	5.73	5.73	\$150	\$859.84	\$2,755.03
16	2031	0.1704	0.4189	1,697	2,131	\$289	\$893	1,681	\$1,182	1,036	\$176	3,378	3,167	575	\$1,327	\$1,902	5.73	5.73	\$160	\$917.16	\$2,819.26
17	2032	0.1705	0.4204	1,697	2,131	\$289	\$896	1,681	\$1,185	1,036	\$177	3,378	3,167	576	\$1,331	\$1,907	5.73	5.73	\$170	\$974.49	\$2,881.91
18	2033	0.1707	0.4223	1,697	2,131	\$290	\$900	1,681	\$1,190	1,036	\$177	3,378	3,167	577	\$1,338	\$1,914	5.73	5.73	\$180	\$1,031.81	\$2,946.15
19	2034	0.1710	0.4246	1,697	2,131	\$290	\$905	1,681	\$1,195	1,036	\$177	3,378	3,167	578	\$1,345	\$1,923	5.73	5.73	\$190	\$1,089.13	\$3,011.71
20	2035	0.1713	0.4265	1,697	2,131	\$291	\$909	1,681	\$1,200	1,036	\$177	3,378	3,167	579	\$1,351	\$1,929	5.73	5.73	\$200	\$1,146.45	\$3,075.94
21	2036	0.1714	0.4281	1,697	2,131	\$291	\$914	1,681	\$1,205	1,036	\$178	3,378	3,167	579	\$1,358	\$1,937	5.73	5.73	\$210	\$1,203.78	\$3,141.07
22	2037	0.1717	0.4311	1,697	2,131	\$291	\$919	1,681	\$1,210	1,036	\$178	3,378	3,167	580	\$1,365	\$1,945	5.73	5.73	\$220	\$1,261.10	\$3,206.46
23	2038	0.1720	0.4331	1,697	2,131	\$292	\$923	1,681	\$1,215	1,036	\$178	3,378	3,167	581	\$1,371	\$1,952	5.73	5.73	\$230	\$1,318.42	\$3,270.82
24	2039	0.1722	0.4353	1,697	2,131	\$292	\$928	1,681	\$1,220	1,036	\$178	3,378	3,167	582	\$1,379	\$1,961	5.73	5.73	\$240	\$1,375.74	\$3,336.26
25	2040	0.1724	0.4376	1,697	2,131	\$293	\$933	1,681	\$1,225	1,036	\$179	3,378	3,167	582	\$1,386	\$1,968	5.73	5.73	\$250	\$1,433.07	\$3,401.34
26	2041	0.1734	0.4420	1,697	2,131	\$294	\$942	1,681	\$1,236	1,036	\$180	3,378	3,167	586	\$1,400	\$1,985	5.73	5.73	\$260	\$1,490.39	\$3,475.69
27	2042	0.1744	0.4463	1,697	2,131	\$296	\$951	1,681	\$1,247	1,036	\$181	3,378	3,167	589	\$1,413	\$2,002	5.73	5.73	\$270	\$1,547.71	\$3,550.20
28	2043	0.1754	0.4507	1,697	2,131	\$298	\$960	1,681	\$1,258	1,036	\$182	3,378	3,167	592	\$1,427	\$2,020	5.73	5.73	\$280	\$1,605.04	\$3,624.87
29	2044	0.1764	0.4552	1,697	2,131	\$299	\$970	1,681	\$1,269	1,036	\$183	3,378	3,167	596	\$1,441	\$2,037	5.73	5.73	\$290	\$1,662.36	\$3,699.69
30	2045	0.1774	0.4596	1,697	2,131	\$301	\$980	1,681	\$1,281	1,036	\$184	3,378	3,167	599	\$1,456	\$2,055	5.73	5.73	\$300	\$1,719.68	\$3,774.67
31	2046	0.1784	0.4640	1,697	2,131	\$303	\$989	1,681	\$1,292	1,036	\$185	3,378	3,167	603	\$1,470	\$2,073	5.73	5.73	\$310	\$1,777.00	\$3,849.84
32	2047	0.1795	0.4688	1,697	2,131	\$305	\$999	1,681	\$1,303	1,036	\$186	3,378	3,167	606	\$1,485	\$2,091	5.73	5.73	\$320	\$1,834.33	\$3,925.12
33	2048	0.1805	0.4734	1,697	2,131	\$306	\$1,009	1,681	\$1,315	1,036	\$187	3,378	3,167	610	\$1,499	\$2,109	5.73	5.73	\$330	\$1,891.65	\$4,000.58
34	2049	0.1816	0.4780	1,697	2,131	\$308	\$1,019	1,681	\$1,327	1,036	\$188	3,378	3,167	613	\$1,514	\$2,127	5.73	5.73	\$340	\$1,948.97	\$4,076.21
35	2050	0.1826	0.4828	1,697	2,131	\$310	\$1,029	1,681	\$1,339	1,036	\$189	3,378	3,167	617	\$1,529	\$2,146	5.73	5.73	\$350	\$2,006.29	\$4,152.01
36	2051	0.1837	0.4875	1,697	2,131	\$312	\$1,039	1,681	\$1,351	1,036	\$190	3,378	3,167	620	\$1,544	\$2,164	5.73	5.73	\$360	\$2,063.62	\$4,227.97
37	2052	0.1847	0.4923	1,697	2,131	\$313	\$1,049	1,681	\$1,363	1,036	\$191	3,378	3,167	624	\$1,559	\$2,183	5.73	5.73	\$370	\$2,120.94	\$4,304.11
38	2053	0.1858	0.4972	1,697	2,131	\$315	\$1,059	1,681	\$1,375	1,036	\$192	3,378	3,167	628	\$1,575	\$2,202	5.73	5.73	\$380	\$2,178.26	\$4,380.41
39	2054	0.1869	0.5021	1,697	2,131	\$317	\$1,070	1,681	\$1,387	1,036	\$194	3,378	3,167	631	\$1,590	\$2,221	5.73	5.73	\$390	\$2,235.59	\$4,456.89
40	2055	0.1879	0.5070	1,697	2,131	\$319	\$1,080	1,681	\$1,399	1,036	\$195	3,378	3,167	635	\$1,606	\$2,241	5.73	5.73	\$400	\$2,292.91	\$4,533.54
41	2056	0.1890	0.5120	1,697	2,131	\$321	\$1,091	1,681	\$1,412	1,036	\$196	3,378	3,167	639	\$1,622	\$2,260	5.73	5.73	\$410	\$2,350.23	\$4,610.37
42	2057	0.1901	0.5171	1,697	2,131	\$323	\$1,102	1,681	\$1,425	1,036	\$197	3,378	3,167	642	\$1,638	\$2,280	5.73	5.73	\$420	\$2,407.55	\$4,687.37
43	2058	0.1912	0.5222	1,697	2,131	\$325	\$1,113	1,681	\$1,437	1,036	\$198	3,378	3,167	646	\$1,654	\$2,300	5.73	5.73	\$430	\$2,464.88	\$4,764.55
44	2059	0.1923	0.5273	1,697	2,131	\$326	\$1,124	1,681	\$1,450	1,036	\$199	3,378	3,167	650	\$1,670	\$2,320	5.73	5.73	\$440	\$2,522.20	\$4,841.92
45	2060	0.1934	0.5325	1,697	2,131	\$328	\$1,135	1,681	\$1,463	1,036	\$200	3,378	3,167	653	\$1,686	\$2,340	5.73	5.73	\$450	\$2,579.52	\$4,919.46
46	2061	0.1946	0.5378	1,697	2,131	\$330	\$1,146	1,681	\$1,476	1,036	\$202	3,378	3,167	657	\$1,703	\$2,360	5.73	5.73	\$460	\$2,636.84	\$4,997.19
47	2062	0.1957	0.5431	1,697	2,131	\$332	\$1,157	1,681	\$1,489	1,036	\$203	3,378	3,167	661	\$1,720	\$2,381	5.73	5.73	\$470	\$2,694.17	\$5,075.11
48	2063	0.1968	0.5484	1,697	2,131	\$334	\$1,169	1,681	\$1,503	1,036	\$204	3,378	3,167	665	\$1,737	\$2,402	5.73	5.73	\$480	\$2,751.49	\$5,153.21
49	2064	0.1980	0.5538	1,697	2,131	\$336	\$1,180	1,681	\$1,516	1,036	\$205	3,378	3,167	669	\$1,754	\$2,423	5.73	5.73	\$490	\$2,808.81	\$5,231.50
50	2065	0.1991	0.5593	1,697	2,131	\$338	\$1,192	1,681	\$1,530	1,036	\$206	3,378	3,167	673	\$1,771	\$2,444	5.73	5.73	\$500	\$2,866.14	\$5,309.99
51	2066	0.2003	0.5648	1,697	2,131	\$340	\$1,204	1,681	\$1,543	1,036	\$207	3,378	3,167	676	\$1,789	\$2,465	5.73	5.73	\$510	\$2,923.46	\$5,388.66
52	2067	0.2014	0.5704	1,697	2,131	\$342	\$1,215	1,681	\$1,557	1,036	\$209	3,378	3,167	680	\$1,806	\$2,487	5.73	5.73	\$520	\$2,980.78	\$5,467.54
53	2068	0.2026	0.5760	1,697	2,131	\$344	\$1,227	1,681	\$1,571	1,036	\$210	3,378	3,167	684	\$1,824	\$2,508	5.73	5.73	\$530	\$3,038.10	\$5,546.60
54	2069	0.2038	0.5817	1,697	2,131	\$346	\$1,240	1,681	\$1,585	1,036	\$211	3,378	3,167	688	\$1,842	\$2,530	5.73	5.73	\$540	\$3,095.43	\$5,625.87
55	2070	0.2049	0.5874	1,697	2,131	\$348	\$1,252	1,681	\$1,600	1,036	\$212	3,378	3,167	692	\$1,860	\$2,553</					

7. London (South) – Annual Operating Costs

Vertical Ground Source Heat Pump (V.GSHP)

Base Case Scenario											Feed in Tariff (FIT)			
#	Year	Electricity Rates		Heating Operating Cost		Cooling Operating Cost		Hot Water Operating Cost		Total	Total Operating Cost	Incentives (\$/KWh)	FIT	
		\$/KWh	KWh	\$	KWh	\$	KWh	\$	KWh				\$	\$/KWh
1	2016	0.1501	4,122	\$619	287	\$43	4,513	\$677	8,922	\$1,339	0.05	0.1001	\$892.94	
2	2017	0.1542	4,122	\$636	287	\$44	4,513	\$696	8,922	\$1,376	0.05	0.1042	\$929.55	
3	2018	0.1583	4,122	\$652	287	\$45	4,513	\$714	8,922	\$1,412	0.05	0.1083	\$966.17	
4	2019	0.1625	4,122	\$670	287	\$47	4,513	\$734	8,922	\$1,450	0.05	0.1125	\$1,004.07	
5	2020	0.1668	4,122	\$687	287	\$48	4,513	\$753	8,922	\$1,488	0.05	0.1168	\$1,041.97	
6	2021	0.1621	4,122	\$668	287	\$47	4,513	\$732	8,922	\$1,447	0.05	0.1121	\$1,000.54	
7	2022	0.1629	4,122	\$672	287	\$47	4,513	\$735	8,922	\$1,454	0.05	0.1129	\$1,007.60	
8	2023	0.1639	4,122	\$675	287	\$47	4,513	\$740	8,922	\$1,462	0.05	0.1139	\$1,015.95	
9	2024	0.1648	4,122	\$679	287	\$47	4,513	\$744	8,922	\$1,470	0.05	0.1148	\$1,024.31	
10	2025	0.1656	4,122	\$683	287	\$48	4,513	\$747	8,922	\$1,477	0.05	0.1156	\$1,031.37	
11	2026	0.1665	4,122	\$686	287	\$48	4,513	\$752	8,922	\$1,486	0.05	0.1165	\$1,039.72	
12	2027	0.1674	4,122	\$690	287	\$48	4,513	\$756	8,922	\$1,494	0.05	0.1174	\$1,047.75	
13	2028	0.1683	4,122	\$694	287	\$48	4,513	\$759	8,922	\$1,501	0.05	0.1183	\$1,055.14	
14	2029	0.1692	4,122	\$697	287	\$49	4,513	\$763	8,922	\$1,509	0.05	0.1192	\$1,063.17	
15	2030	0.1701	4,122	\$701	287	\$49	4,513	\$768	8,922	\$1,518	0.05	0.1201	\$1,071.52	
16	2031	0.1704	4,122	\$702	287	\$49	4,513	\$769	8,922	\$1,520	0.05	0.1204	\$1,073.77	
17	2032	0.1705	4,122	\$703	287	\$49	4,513	\$769	8,922	\$1,521	0.05	0.1205	\$1,075.05	
18	2033	0.1707	4,122	\$704	287	\$49	4,513	\$771	8,922	\$1,523	0.05	0.1207	\$1,077.30	
19	2034	0.1710	4,122	\$705	287	\$49	4,513	\$772	8,922	\$1,526	0.05	0.1210	\$1,079.87	
20	2035	0.1713	4,122	\$706	287	\$49	4,513	\$773	8,922	\$1,528	0.05	0.1213	\$1,082.12	
21	2036	0.1714	4,122	\$707	287	\$49	4,513	\$774	8,922	\$1,530	0.05	0.1214	\$1,083.40	
22	2037	0.1717	4,122	\$708	287	\$49	4,513	\$775	8,922	\$1,532	0.05	0.1217	\$1,085.65	
23	2038	0.1720	4,122	\$709	287	\$49	4,513	\$776	8,922	\$1,534	0.05	0.1220	\$1,088.22	
24	2039	0.1722	4,122	\$710	287	\$49	4,513	\$777	8,922	\$1,537	0.05	0.1222	\$1,090.47	
25	2040	0.1724	4,122	\$710	287	\$49	4,513	\$778	8,922	\$1,538	0.05	0.1224	\$1,091.75	
26	2041	0.1734	4,122	\$715	287	\$50	4,513	\$782	8,922	\$1,547	0.05	0.1234	\$1,100.65	
27	2042	0.1744	4,122	\$719	287	\$50	4,513	\$787	8,922	\$1,556	0.05	0.1244	\$1,109.60	
28	2043	0.1754	4,122	\$723	287	\$50	4,513	\$791	8,922	\$1,565	0.05	0.1254	\$1,118.60	
29	2044	0.1764	4,122	\$727	287	\$51	4,513	\$796	8,922	\$1,574	0.05	0.1264	\$1,127.65	
30	2045	0.1774	4,122	\$731	287	\$51	4,513	\$801	8,922	\$1,583	0.05	0.1274	\$1,136.75	
31	2046	0.1784	4,122	\$736	287	\$51	4,513	\$805	8,922	\$1,592	0.05	0.1284	\$1,145.91	
32	2047	0.1795	4,122	\$740	287	\$52	4,513	\$810	8,922	\$1,601	0.05	0.1295	\$1,155.12	
33	2048	0.1805	4,122	\$744	287	\$52	4,513	\$815	8,922	\$1,610	0.05	0.1305	\$1,164.38	
34	2049	0.1816	4,122	\$748	287	\$52	4,513	\$819	8,922	\$1,620	0.05	0.1316	\$1,173.70	
35	2050	0.1826	4,122	\$753	287	\$52	4,513	\$824	8,922	\$1,629	0.05	0.1326	\$1,183.07	
36	2051	0.1837	4,122	\$757	287	\$53	4,513	\$829	8,922	\$1,639	0.05	0.1337	\$1,192.49	
37	2052	0.1847	4,122	\$761	287	\$53	4,513	\$834	8,922	\$1,648	0.05	0.1347	\$1,201.97	
38	2053	0.1858	4,122	\$766	287	\$53	4,513	\$838	8,922	\$1,658	0.05	0.1358	\$1,211.51	
39	2054	0.1869	4,122	\$770	287	\$54	4,513	\$843	8,922	\$1,667	0.05	0.1369	\$1,221.10	
40	2055	0.1879	4,122	\$775	287	\$54	4,513	\$848	8,922	\$1,677	0.05	0.1379	\$1,230.74	
41	2056	0.1890	4,122	\$779	287	\$54	4,513	\$853	8,922	\$1,687	0.05	0.1390	\$1,240.44	
42	2057	0.1901	4,122	\$784	287	\$55	4,513	\$858	8,922	\$1,696	0.05	0.1401	\$1,250.20	
43	2058	0.1912	4,122	\$788	287	\$55	4,513	\$863	8,922	\$1,706	0.05	0.1412	\$1,260.01	
44	2059	0.1923	4,122	\$793	287	\$55	4,513	\$868	8,922	\$1,716	0.05	0.1423	\$1,269.88	
45	2060	0.1934	4,122	\$797	287	\$56	4,513	\$873	8,922	\$1,726	0.05	0.1434	\$1,279.81	
46	2061	0.1946	4,122	\$802	287	\$56	4,513	\$878	8,922	\$1,736	0.05	0.1446	\$1,289.79	
47	2062	0.1957	4,122	\$807	287	\$56	4,513	\$883	8,922	\$1,746	0.05	0.1457	\$1,299.83	
48	2063	0.1968	4,122	\$811	287	\$56	4,513	\$888	8,922	\$1,756	0.05	0.1468	\$1,309.93	
49	2064	0.1980	4,122	\$816	287	\$57	4,513	\$893	8,922	\$1,766	0.05	0.1480	\$1,320.09	
50	2065	0.1991	4,122	\$821	287	\$57	4,513	\$899	8,922	\$1,776	0.05	0.1491	\$1,330.31	
51	2066	0.2003	4,122	\$825	287	\$57	4,513	\$904	8,922	\$1,787	0.05	0.1503	\$1,340.58	
52	2067	0.2014	4,122	\$830	287	\$58	4,513	\$909	8,922	\$1,797	0.05	0.1514	\$1,350.92	
53	2068	0.2026	4,122	\$835	287	\$58	4,513	\$914	8,922	\$1,807	0.05	0.1526	\$1,361.32	
54	2069	0.2038	4,122	\$840	287	\$58	4,513	\$920	8,922	\$1,818	0.05	0.1538	\$1,371.77	
55	2070	0.2049	4,122	\$845	287	\$59	4,513	\$925	8,922	\$1,828	0.05	0.1549	\$1,382.29	
56	2071	0.2061	4,122	\$850	287	\$59	4,513	\$930	8,922	\$1,839	0.05	0.1561	\$1,392.86	
57	2072	0.2073	4,122	\$855	287	\$59	4,513	\$936	8,922	\$1,850	0.05	0.1573	\$1,403.50	
58	2073	0.2085	4,122	\$859	287	\$60	4,513	\$941	8,922	\$1,860	0.05	0.1585	\$1,414.20	
59	2074	0.2097	4,122	\$864	287	\$60	4,513	\$946	8,922	\$1,871	0.05	0.1597	\$1,424.96	
60	2075	0.2109	4,122	\$869	287	\$61	4,513	\$952	8,922	\$1,882	0.05	0.1609	\$1,435.79	

Table D2-1.19: Annual Operating Costs (V.GSHP) of a 2,000 square feet detached house above grade (improved construction type) in the city of London (two life cycles and three life cycles for a 60 year project lifespan); base case scenario in comparison with feed in-tariff (FIT) scenario. In the FIT scenario, an incentive of \$0.05/KWh is provided on electricity bills throughout the project lifespan

Horizontal Ground Source Heat Pump (H.GSHP)

Base Case Scenario											Feed in Tariff (FIT)		
H.GSHP											FIT		
#	Year	Electricity Rates \$/KWh	Heating KWh	Heating Operating Cost \$	Cooling KWh	Cooling Operating Cost \$	Hot Water KWh	Hot Water Operating Cost \$	Total KWh	Total Operating Cost \$	Incentives (\$/KWh)	\$/KWh	Operating Cost
1	2016	0.1501	4,181	\$627	292	\$44	4,515	\$678	8,988	\$1,349	0.05	0.1001	\$899.54
2	2017	0.1542	4,181	\$645	292	\$45	4,515	\$696	8,988	\$1,386	0.05	0.1042	\$936.43
3	2018	0.1583	4,181	\$662	292	\$46	4,515	\$715	8,988	\$1,423	0.05	0.1083	\$973.32
4	2019	0.1625	4,181	\$680	292	\$47	4,515	\$734	8,988	\$1,461	0.05	0.1125	\$1,011.50
5	2020	0.1668	4,181	\$697	292	\$49	4,515	\$753	8,988	\$1,499	0.05	0.1168	\$1,049.68
6	2021	0.1621	4,181	\$678	292	\$47	4,515	\$732	8,988	\$1,457	0.05	0.1121	\$1,007.94
7	2022	0.1629	4,181	\$681	292	\$48	4,515	\$736	8,988	\$1,464	0.05	0.1129	\$1,015.06
8	2023	0.1639	4,181	\$685	292	\$48	4,515	\$740	8,988	\$1,473	0.05	0.1139	\$1,023.47
9	2024	0.1648	4,181	\$689	292	\$48	4,515	\$744	8,988	\$1,481	0.05	0.1148	\$1,031.88
10	2025	0.1656	4,181	\$692	292	\$48	4,515	\$748	8,988	\$1,488	0.05	0.1156	\$1,039.00
11	2026	0.1665	4,181	\$696	292	\$49	4,515	\$752	8,988	\$1,497	0.05	0.1165	\$1,047.41
12	2027	0.1674	4,181	\$700	292	\$49	4,515	\$756	8,988	\$1,505	0.05	0.1174	\$1,055.50
13	2028	0.1683	4,181	\$704	292	\$49	4,515	\$760	8,988	\$1,512	0.05	0.1183	\$1,062.94
14	2029	0.1692	4,181	\$707	292	\$49	4,515	\$764	8,988	\$1,520	0.05	0.1192	\$1,071.03
15	2030	0.1701	4,181	\$711	292	\$50	4,515	\$768	8,988	\$1,529	0.05	0.1201	\$1,079.45
16	2031	0.1704	4,181	\$712	292	\$50	4,515	\$769	8,988	\$1,531	0.05	0.1204	\$1,081.71
17	2032	0.1705	4,181	\$713	292	\$50	4,515	\$770	8,988	\$1,532	0.05	0.1205	\$1,083.01
18	2033	0.1707	4,181	\$714	292	\$50	4,515	\$771	8,988	\$1,535	0.05	0.1207	\$1,085.27
19	2034	0.1710	4,181	\$715	292	\$50	4,515	\$772	8,988	\$1,537	0.05	0.1210	\$1,087.86
20	2035	0.1713	4,181	\$716	292	\$50	4,515	\$773	8,988	\$1,540	0.05	0.1213	\$1,090.12
21	2036	0.1714	4,181	\$717	292	\$50	4,515	\$774	8,988	\$1,541	0.05	0.1214	\$1,091.42
22	2037	0.1717	4,181	\$718	292	\$50	4,515	\$775	8,988	\$1,543	0.05	0.1217	\$1,093.68
23	2038	0.1720	4,181	\$719	292	\$50	4,515	\$776	8,988	\$1,546	0.05	0.1220	\$1,096.27
24	2039	0.1722	4,181	\$720	292	\$50	4,515	\$778	8,988	\$1,548	0.05	0.1222	\$1,098.54
25	2040	0.1724	4,181	\$721	292	\$50	4,515	\$778	8,988	\$1,549	0.05	0.1224	\$1,099.83
26	2041	0.1734	4,181	\$725	292	\$51	4,515	\$783	8,988	\$1,558	0.05	0.1234	\$1,108.79
27	2042	0.1744	4,181	\$729	292	\$51	4,515	\$787	8,988	\$1,567	0.05	0.1244	\$1,117.81
28	2043	0.1754	4,181	\$733	292	\$51	4,515	\$792	8,988	\$1,576	0.05	0.1254	\$1,126.87
29	2044	0.1764	4,181	\$737	292	\$52	4,515	\$796	8,988	\$1,585	0.05	0.1264	\$1,135.99
30	2045	0.1774	4,181	\$742	292	\$52	4,515	\$801	8,988	\$1,595	0.05	0.1274	\$1,145.16
31	2046	0.1784	4,181	\$746	292	\$52	4,515	\$806	8,988	\$1,604	0.05	0.1284	\$1,154.39
32	2047	0.1795	4,181	\$750	292	\$52	4,515	\$810	8,988	\$1,613	0.05	0.1295	\$1,163.67
33	2048	0.1805	4,181	\$755	292	\$53	4,515	\$815	8,988	\$1,622	0.05	0.1305	\$1,173.00
34	2049	0.1816	4,181	\$759	292	\$53	4,515	\$820	8,988	\$1,632	0.05	0.1316	\$1,182.38
35	2050	0.1826	4,181	\$763	292	\$53	4,515	\$824	8,988	\$1,641	0.05	0.1326	\$1,191.82
36	2051	0.1837	4,181	\$768	292	\$54	4,515	\$829	8,988	\$1,651	0.05	0.1337	\$1,201.32
37	2052	0.1847	4,181	\$772	292	\$54	4,515	\$834	8,988	\$1,660	0.05	0.1347	\$1,210.86
38	2053	0.1858	4,181	\$777	292	\$54	4,515	\$839	8,988	\$1,670	0.05	0.1358	\$1,220.47
39	2054	0.1869	4,181	\$781	292	\$55	4,515	\$844	8,988	\$1,680	0.05	0.1369	\$1,230.13
40	2055	0.1879	4,181	\$786	292	\$55	4,515	\$849	8,988	\$1,689	0.05	0.1379	\$1,239.84
41	2056	0.1890	4,181	\$790	292	\$55	4,515	\$853	8,988	\$1,699	0.05	0.1390	\$1,249.62
42	2057	0.1901	4,181	\$795	292	\$56	4,515	\$858	8,988	\$1,709	0.05	0.1401	\$1,259.45
43	2058	0.1912	4,181	\$800	292	\$56	4,515	\$863	8,988	\$1,719	0.05	0.1412	\$1,269.33
44	2059	0.1923	4,181	\$804	292	\$56	4,515	\$868	8,988	\$1,729	0.05	0.1423	\$1,279.27
45	2060	0.1934	4,181	\$809	292	\$56	4,515	\$873	8,988	\$1,739	0.05	0.1434	\$1,289.27
46	2061	0.1946	4,181	\$813	292	\$57	4,515	\$878	8,988	\$1,749	0.05	0.1446	\$1,299.33
47	2062	0.1957	4,181	\$818	292	\$57	4,515	\$884	8,988	\$1,759	0.05	0.1457	\$1,309.45
48	2063	0.1968	4,181	\$823	292	\$57	4,515	\$889	8,988	\$1,769	0.05	0.1468	\$1,319.62
49	2064	0.1980	4,181	\$828	292	\$58	4,515	\$894	8,988	\$1,779	0.05	0.1480	\$1,329.86
50	2065	0.1991	4,181	\$832	292	\$58	4,515	\$899	8,988	\$1,790	0.05	0.1491	\$1,340.15
51	2066	0.2003	4,181	\$837	292	\$58	4,515	\$904	8,988	\$1,800	0.05	0.1503	\$1,350.50
52	2067	0.2014	4,181	\$842	292	\$59	4,515	\$909	8,988	\$1,810	0.05	0.1514	\$1,360.91
53	2068	0.2026	4,181	\$847	292	\$59	4,515	\$915	8,988	\$1,821	0.05	0.1526	\$1,371.39
54	2069	0.2038	4,181	\$852	292	\$59	4,515	\$920	8,988	\$1,831	0.05	0.1538	\$1,381.92
55	2070	0.2049	4,181	\$857	292	\$60	4,515	\$925	8,988	\$1,842	0.05	0.1549	\$1,392.51
56	2071	0.2061	4,181	\$862	292	\$60	4,515	\$931	8,988	\$1,853	0.05	0.1561	\$1,403.17
57	2072	0.2073	4,181	\$867	292	\$61	4,515	\$936	8,988	\$1,863	0.05	0.1573	\$1,413.88
58	2073	0.2085	4,181	\$872	292	\$61	4,515	\$941	8,988	\$1,874	0.05	0.1585	\$1,424.66
59	2074	0.2097	4,181	\$877	292	\$61	4,515	\$947	8,988	\$1,885	0.05	0.1597	\$1,435.50
60	2075	0.2109	4,181	\$882	292	\$62	4,515	\$952	8,988	\$1,896	0.05	0.1609	\$1,446.41

Table D2-1.20: Annual Operating Costs (H.GSHP) of a 2,000 square feet detached house above grade (improved construction type) in the city of London (two life cycles and three life cycles for a 60 year project lifespan); base case scenario in comparison with feed in-tariff (FIT) scenario. In the FIT scenario, an incentive of \$0.05/KWh is provided on electricity bills throughout the project lifespan

Traditional HVAC Applications

Base Case Scenario															Carbon Taxes							
#	Year	Traditional												Carbon Taxes								
		Electricity Rates	Natural Gas Rates	Heating		Heating Operating Cost	Heating Operating Cost	Total Heating Operating Cost	Cooling	Cooling Operating Cost	Hot Water	Hot Water Operating Cost	Total	Total	Total Electricity Operating Cost	Total Natural Gas Operating Cost	Total	Conversion of m ³ into Tons	Total Tons	Carbon Tax	Operating Costs	
				KWh (Electricity)	m ³ (Gas)																	\$ (Electricity)
\$/KWh	\$/m ³																					
1	2016	0.1501	0.3458	1.515	2,041	\$227	\$706	\$933	1,258	\$189	1,028	\$356	2,773	3,069	416	\$1,061	\$1,478	5.55	5.55	\$10	\$55.55	\$1,533.08
2	2017	0.1542	0.3588	1.515	2,041	\$234	\$732	\$966	1,258	\$194	1,028	\$159	2,773	3,069	428	\$1,101	\$1,529	5.55	5.55	\$20	\$111.10	\$1,639.93
3	2018	0.1583	0.3718	1.515	2,041	\$240	\$759	\$999	1,258	\$199	1,028	\$163	2,773	3,069	439	\$1,141	\$1,580	5.55	5.55	\$30	\$166.65	\$1,746.78
4	2019	0.1625	0.3776	1.515	2,041	\$246	\$771	\$1,017	1,258	\$204	1,028	\$167	2,773	3,069	451	\$1,159	\$1,610	5.55	5.55	\$40	\$222.20	\$1,831.72
5	2020	0.1668	0.3841	1.515	2,041	\$253	\$784	\$1,037	1,258	\$210	1,028	\$171	2,773	3,069	462	\$1,179	\$1,641	5.55	5.55	\$50	\$277.74	\$1,919.00
6	2021	0.1621	0.3883	1.515	2,041	\$246	\$793	\$1,038	1,258	\$204	1,028	\$167	2,773	3,069	450	\$1,192	\$1,641	5.55	5.55	\$60	\$333.29	\$1,974.59
7	2022	0.1629	0.3929	1.515	2,041	\$247	\$802	\$1,049	1,258	\$205	1,028	\$167	2,773	3,069	452	\$1,206	\$1,658	5.55	5.55	\$70	\$388.84	\$2,046.42
8	2023	0.1639	0.3967	1.515	2,041	\$248	\$810	\$1,058	1,258	\$206	1,028	\$168	2,773	3,069	454	\$1,218	\$1,672	5.55	5.55	\$80	\$444.39	\$2,116.31
9	2024	0.1648	0.4005	1.515	2,041	\$250	\$817	\$1,067	1,258	\$207	1,028	\$169	2,773	3,069	457	\$1,229	\$1,686	5.55	5.55	\$90	\$499.94	\$2,186.19
10	2025	0.1656	0.4040	1.515	2,041	\$251	\$825	\$1,075	1,258	\$208	1,028	\$170	2,773	3,069	459	\$1,240	\$1,699	5.55	5.55	\$100	\$555.49	\$2,254.50
11	2026	0.1665	0.4070	1.515	2,041	\$252	\$831	\$1,083	1,258	\$210	1,028	\$171	2,773	3,069	462	\$1,249	\$1,711	5.55	5.55	\$110	\$611.04	\$2,322.04
12	2027	0.1674	0.4097	1.515	2,041	\$254	\$836	\$1,090	1,258	\$211	1,028	\$172	2,773	3,069	464	\$1,257	\$1,722	5.55	5.55	\$120	\$666.59	\$2,388.30
13	2028	0.1683	0.4124	1.515	2,041	\$255	\$842	\$1,097	1,258	\$212	1,028	\$173	2,773	3,069	467	\$1,266	\$1,732	5.55	5.55	\$130	\$722.14	\$2,454.37
14	2029	0.1692	0.4151	1.515	2,041	\$256	\$847	\$1,103	1,258	\$213	1,028	\$174	2,773	3,069	469	\$1,274	\$1,743	5.55	5.55	\$140	\$777.68	\$2,520.61
15	2030	0.1701	0.4170	1.515	2,041	\$258	\$851	\$1,109	1,258	\$214	1,028	\$175	2,773	3,069	472	\$1,280	\$1,751	5.55	5.55	\$150	\$833.23	\$2,584.65
16	2031	0.1704	0.4189	1.515	2,041	\$258	\$855	\$1,113	1,258	\$214	1,028	\$175	2,773	3,069	472	\$1,286	\$1,758	5.55	5.55	\$160	\$888.78	\$2,646.76
17	2032	0.1705	0.4204	1.515	2,041	\$258	\$858	\$1,116	1,258	\$214	1,028	\$175	2,773	3,069	473	\$1,290	\$1,763	5.55	5.55	\$170	\$944.33	\$2,707.41
18	2033	0.1707	0.4223	1.515	2,041	\$259	\$862	\$1,121	1,258	\$215	1,028	\$176	2,773	3,069	475	\$1,296	\$1,770	5.55	5.55	\$180	\$999.88	\$2,769.53
19	2034	0.1710	0.4246	1.515	2,041	\$259	\$867	\$1,126	1,258	\$215	1,028	\$176	2,773	3,069	474	\$1,303	\$1,777	5.55	5.55	\$190	\$1,055.43	\$2,832.92
20	2035	0.1713	0.4265	1.515	2,041	\$259	\$871	\$1,130	1,258	\$215	1,028	\$176	2,773	3,069	475	\$1,309	\$1,784	5.55	5.55	\$200	\$1,110.98	\$2,896.04
21	2036	0.1714	0.4288	1.515	2,041	\$260	\$875	\$1,135	1,258	\$216	1,028	\$176	2,773	3,069	475	\$1,316	\$1,792	5.55	5.55	\$210	\$1,166.53	\$2,958.03
22	2037	0.1717	0.4311	1.515	2,041	\$260	\$880	\$1,140	1,258	\$216	1,028	\$176	2,773	3,069	476	\$1,323	\$1,799	5.55	5.55	\$220	\$1,222.08	\$3,021.32
23	2038	0.1720	0.4331	1.515	2,041	\$261	\$884	\$1,144	1,258	\$216	1,028	\$177	2,773	3,069	477	\$1,329	\$1,806	5.55	5.55	\$230	\$1,277.62	\$3,083.54
24	2039	0.1722	0.4353	1.515	2,041	\$261	\$889	\$1,149	1,258	\$217	1,028	\$177	2,773	3,069	478	\$1,336	\$1,814	5.55	5.55	\$240	\$1,333.17	\$3,146.83
25	2040	0.1724	0.4376	1.515	2,041	\$261	\$893	\$1,154	1,258	\$217	1,028	\$177	2,773	3,069	478	\$1,343	\$1,821	5.55	5.55	\$250	\$1,388.72	\$3,209.82
26	2041	0.1734	0.4420	1.515	2,041	\$263	\$902	\$1,165	1,258	\$218	1,028	\$178	2,773	3,069	481	\$1,356	\$1,837	5.55	5.55	\$260	\$1,444.27	\$3,281.38
27	2042	0.1744	0.4463	1.515	2,041	\$264	\$911	\$1,175	1,258	\$219	1,028	\$179	2,773	3,069	484	\$1,370	\$1,853	5.55	5.55	\$270	\$1,499.82	\$3,353.08
28	2043	0.1754	0.4507	1.515	2,041	\$266	\$920	\$1,186	1,258	\$221	1,028	\$180	2,773	3,069	486	\$1,383	\$1,870	5.55	5.55	\$280	\$1,555.37	\$3,424.93
29	2044	0.1764	0.4552	1.515	2,041	\$267	\$929	\$1,196	1,258	\$222	1,028	\$181	2,773	3,069	489	\$1,397	\$1,886	5.55	5.55	\$290	\$1,610.92	\$3,496.93
30	2045	0.1784	0.4606	1.515	2,041	\$269	\$938	\$1,207	1,258	\$223	1,028	\$182	2,773	3,069	492	\$1,411	\$1,903	5.55	5.55	\$300	\$1,666.47	\$3,568.68
31	2046	0.1784	0.4642	1.515	2,041	\$270	\$947	\$1,218	1,258	\$224	1,028	\$183	2,773	3,069	495	\$1,425	\$1,919	5.55	5.55	\$310	\$1,722.02	\$3,641.38
32	2047	0.1795	0.4688	1.515	2,041	\$272	\$957	\$1,229	1,258	\$226	1,028	\$184	2,773	3,069	498	\$1,439	\$1,936	5.55	5.55	\$320	\$1,777.56	\$3,713.84
33	2048	0.1805	0.4734	1.515	2,041	\$273	\$966	\$1,240	1,258	\$227	1,028	\$186	2,773	3,069	501	\$1,453	\$1,953	5.55	5.55	\$330	\$1,833.11	\$3,786.45
34	2049	0.1816	0.4780	1.515	2,041	\$275	\$976	\$1,251	1,258	\$228	1,028	\$187	2,773	3,069	503	\$1,467	\$1,971	5.55	5.55	\$340	\$1,888.66	\$3,859.22
35	2050	0.1826	0.4828	1.515	2,041	\$277	\$985	\$1,262	1,258	\$230	1,028	\$188	2,773	3,069	506	\$1,482	\$1,988	5.55	5.55	\$350	\$1,944.21	\$3,932.14
36	2051	0.1837	0.4875	1.515	2,041	\$278	\$995	\$1,273	1,258	\$231	1,028	\$189	2,773	3,069	509	\$1,496	\$2,005	5.55	5.55	\$360	\$1,999.76	\$4,005.23
37	2052	0.1847	0.4923	1.515	2,041	\$280	\$1,005	\$1,285	1,258	\$232	1,028	\$190	2,773	3,069	512	\$1,511	\$2,023	5.55	5.55	\$370	\$2,055.31	\$4,078.47
38	2053	0.1858	0.4972	1.515	2,041	\$281	\$1,015	\$1,296	1,258	\$234	1,028	\$191	2,773	3,069	515	\$1,526	\$2,041	5.55	5.55	\$380	\$2,110.86	\$4,151.88
39	2054	0.1869	0.5021	1.515	2,041	\$283	\$1,025	\$1,308	1,258	\$235	1,028	\$192	2,773	3,069	518	\$1,541	\$2,059	5.55	5.55	\$390	\$2,166.41	\$4,225.46
40	2055	0.1879	0.5070	1.515	2,041	\$285	\$1,035	\$1,320	1,258	\$236	1,028	\$193	2,773	3,069	521	\$1,556	\$2,077	5.55	5.55	\$400	\$2,221.96	\$4,299.19
41	2056	0.2003	0.5698	1.515	2,041	\$286	\$1,045	\$1,331	1,258	\$238	1,028	\$194	2,773	3,069	524	\$1,571	\$2,096	5.55	5.55	\$410	\$2,277.50	\$4,373.10
42	2057	0.1901	0.5171	1.515	2,041	\$288	\$1,055	\$1,343	1,258	\$239	1,028	\$195	2,773	3,069	527	\$1,587	\$2,114	5.55	5.55	\$420	\$2,333.05	\$4,447.17
43	2058	0.1912	0.5222	1.515	2,041	\$290	\$1,066	\$1,355	1,258	\$241	1,028	\$197	2,773	3,069	530	\$1,603	\$2,133	5.55	5.55	\$430	\$2,388.60	\$4,521.42
44	2059	0.1923	0.5273	1.515	2,041	\$291	\$1,076	\$1,368	1,258	\$242	1,028	\$198	2,773	3,069	533	\$1,618	\$2,152	5.55	5.55	\$440	\$2,444.15	\$4,595.83
45	2060	0.1934	0.5325	1.515	2,041	\$293	\$1,087	\$1,380	1,258	\$243	1,028	\$199	2,773	3,069	536	\$1,634	\$2,171	5.55	5.55	\$450	\$2,499.70	\$4,670.42
46	2061	0.1946	0.5378	1.515	2,041	\$295	\$1,098	\$1,392	1,258	\$245	1,028	\$200	2,773	3,069	540	\$1,650	\$2,190	5.55	5.55	\$460	\$2,555.25	\$4,745.19
47	2062	0.1957	0.5431	1.515	2,041	\$296	\$1,108	\$1,405	1,258	\$246	1,028	\$201	2,773	3,069	543	\$1,667	\$2,209	5.55	5.55	\$470	\$2,610.80	\$4,820.13
48	2063	0.1968	0.5484	1.515	2,041	\$298	\$1,119	\$1,418	1,258	\$248	1,028	\$202	2,773	3,069	546	\$1,683	\$2,229	5.55	5.55	\$480	\$2,666.35	\$4,895.25
49	2064	0.1980	0.5538	1.515	2,041	\$300	\$1,130	\$1,430	1,258	\$249	1,028	\$204	2,773	3,069	549	\$1,700	\$2,249	5.55	5.55	\$490	\$2,721.90	\$4,970.55
50	2065	0.1991	0.5593	1.515	2,041	\$302	\$1,142	\$1,443	1,258	\$250	1,028	\$205	2,773	3,069	552	\$1,716	\$2,269	5.55	5.55	\$500	\$2,777.45	\$5,046.03
51	2066	0.2003	0.5646	1.515	2,041	\$303	\$1,153	\$1,456	1,258	\$252	1,028	\$206	2,773	3,069	555	\$1,733	\$2,289	5.55	5.55	\$510	\$2,832.99	\$5,121.69
52	2067	0.2014	0.5704	1.515	2,041	\$305	\$1,164	\$1,469	1,258	\$253	1,028	\$207	2,773	3,069	559	\$1,750	\$2,309	5.55	5.55	\$520	\$2,888.54	\$5,197.55
53	2068	0.2026	0.5760	1.5																		

8. Mount Forest (South) – Annual Operating Costs

Vertical Ground Source Heat Pump (V.GSHP)

Base Case Scenario											Feed in Tariff (FIT)		
#	Year	Electricity Rates		V.GSHP		Hot Water		Total		Total Operating Cost	FIT		
		\$/KWh	KWh	Heating Operating Cost	Cooling	Cooling Operating Cost	Hot Water Operating Cost	KWh	\$/KWh		Incentives (\$/KWh)	\$/KWh	Operating Cost
1	2016	0.1501	4,832	\$725	191	\$29	4,433	\$665	9,456	\$1,419	0.05	0.1001	\$946.38
2	2017	0.1542	4,832	\$745	191	\$29	4,433	\$684	9,456	\$1,458	0.05	0.1042	\$985.19
3	2018	0.1583	4,832	\$765	191	\$30	4,433	\$702	9,456	\$1,497	0.05	0.1083	\$1,024.00
4	2019	0.1625	4,832	\$785	191	\$31	4,433	\$721	9,456	\$1,537	0.05	0.1125	\$1,064.17
5	2020	0.1668	4,832	\$806	191	\$32	4,433	\$739	9,456	\$1,577	0.05	0.1168	\$1,104.33
6	2021	0.1621	4,832	\$783	191	\$31	4,433	\$719	9,456	\$1,533	0.05	0.1121	\$1,060.42
7	2022	0.1629	4,832	\$787	191	\$31	4,433	\$722	9,456	\$1,541	0.05	0.1129	\$1,067.91
8	2023	0.1639	4,832	\$792	191	\$31	4,433	\$726	9,456	\$1,550	0.05	0.1139	\$1,076.76
9	2024	0.1648	4,832	\$796	191	\$31	4,433	\$731	9,456	\$1,558	0.05	0.1148	\$1,085.61
10	2025	0.1656	4,832	\$800	191	\$32	4,433	\$734	9,456	\$1,566	0.05	0.1156	\$1,093.10
11	2026	0.1665	4,832	\$805	191	\$32	4,433	\$738	9,456	\$1,575	0.05	0.1165	\$1,101.95
12	2027	0.1674	4,832	\$809	191	\$32	4,433	\$742	9,456	\$1,583	0.05	0.1174	\$1,110.46
13	2028	0.1683	4,832	\$813	191	\$32	4,433	\$746	9,456	\$1,591	0.05	0.1183	\$1,118.29
14	2029	0.1692	4,832	\$817	191	\$32	4,433	\$750	9,456	\$1,600	0.05	0.1192	\$1,126.80
15	2030	0.1701	4,832	\$822	191	\$32	4,433	\$754	9,456	\$1,608	0.05	0.1201	\$1,135.65
16	2031	0.1704	4,832	\$823	191	\$33	4,433	\$755	9,456	\$1,611	0.05	0.1204	\$1,138.04
17	2032	0.1705	4,832	\$824	191	\$33	4,433	\$756	9,456	\$1,612	0.05	0.1205	\$1,139.40
18	2033	0.1707	4,832	\$825	191	\$33	4,433	\$757	9,456	\$1,615	0.05	0.1207	\$1,141.78
19	2034	0.1710	4,832	\$826	191	\$33	4,433	\$758	9,456	\$1,617	0.05	0.1210	\$1,144.50
20	2035	0.1713	4,832	\$828	191	\$33	4,433	\$759	9,456	\$1,620	0.05	0.1213	\$1,146.89
21	2036	0.1714	4,832	\$828	191	\$33	4,433	\$760	9,456	\$1,621	0.05	0.1214	\$1,148.25
22	2037	0.1717	4,832	\$830	191	\$33	4,433	\$761	9,456	\$1,623	0.05	0.1217	\$1,150.63
23	2038	0.1720	4,832	\$831	191	\$33	4,433	\$762	9,456	\$1,626	0.05	0.1220	\$1,153.35
24	2039	0.1722	4,832	\$832	191	\$33	4,433	\$763	9,456	\$1,629	0.05	0.1222	\$1,155.74
25	2040	0.1724	4,832	\$833	191	\$33	4,433	\$764	9,456	\$1,630	0.05	0.1224	\$1,157.10
26	2041	0.1734	4,832	\$838	191	\$33	4,433	\$769	9,456	\$1,639	0.05	0.1234	\$1,166.53
27	2042	0.1744	4,832	\$843	191	\$33	4,433	\$773	9,456	\$1,649	0.05	0.1244	\$1,176.01
28	2043	0.1754	4,832	\$847	191	\$33	4,433	\$777	9,456	\$1,658	0.05	0.1254	\$1,185.55
29	2044	0.1764	4,832	\$852	191	\$34	4,433	\$782	9,456	\$1,668	0.05	0.1264	\$1,195.14
30	2045	0.1774	4,832	\$857	191	\$34	4,433	\$786	9,456	\$1,678	0.05	0.1274	\$1,204.79
31	2046	0.1784	4,832	\$862	191	\$34	4,433	\$791	9,456	\$1,687	0.05	0.1284	\$1,214.50
32	2047	0.1795	4,832	\$867	191	\$34	4,433	\$796	9,456	\$1,697	0.05	0.1295	\$1,224.26
33	2048	0.1805	4,832	\$872	191	\$34	4,433	\$800	9,456	\$1,707	0.05	0.1305	\$1,234.07
34	2049	0.1816	4,832	\$877	191	\$35	4,433	\$805	9,456	\$1,717	0.05	0.1316	\$1,243.95
35	2050	0.1826	4,832	\$882	191	\$35	4,433	\$809	9,456	\$1,727	0.05	0.1326	\$1,253.88
36	2051	0.1837	4,832	\$887	191	\$35	4,433	\$814	9,456	\$1,737	0.05	0.1337	\$1,263.87
37	2052	0.1847	4,832	\$893	191	\$35	4,433	\$819	9,456	\$1,747	0.05	0.1347	\$1,273.91
38	2053	0.1858	4,832	\$898	191	\$35	4,433	\$824	9,456	\$1,757	0.05	0.1358	\$1,284.02
39	2054	0.1869	4,832	\$903	191	\$36	4,433	\$828	9,456	\$1,767	0.05	0.1369	\$1,294.18
40	2055	0.1879	4,832	\$908	191	\$36	4,433	\$833	9,456	\$1,777	0.05	0.1379	\$1,304.40
41	2056	0.1890	4,832	\$913	191	\$36	4,433	\$838	9,456	\$1,787	0.05	0.1390	\$1,314.68
42	2057	0.1901	4,832	\$919	191	\$36	4,433	\$843	9,456	\$1,798	0.05	0.1401	\$1,325.02
43	2058	0.1912	4,832	\$924	191	\$37	4,433	\$848	9,456	\$1,808	0.05	0.1412	\$1,335.42
44	2059	0.1923	4,832	\$929	191	\$37	4,433	\$853	9,456	\$1,819	0.05	0.1423	\$1,345.88
45	2060	0.1934	4,832	\$935	191	\$37	4,433	\$858	9,456	\$1,829	0.05	0.1434	\$1,356.41
46	2061	0.1946	4,832	\$940	191	\$37	4,433	\$862	9,456	\$1,840	0.05	0.1446	\$1,366.99
47	2062	0.1957	4,832	\$946	191	\$37	4,433	\$867	9,456	\$1,850	0.05	0.1457	\$1,377.63
48	2063	0.1968	4,832	\$951	191	\$38	4,433	\$873	9,456	\$1,861	0.05	0.1468	\$1,388.33
49	2064	0.1980	4,832	\$957	191	\$38	4,433	\$878	9,456	\$1,872	0.05	0.1480	\$1,399.10
50	2065	0.1991	4,832	\$962	191	\$38	4,433	\$883	9,456	\$1,883	0.05	0.1491	\$1,409.93
51	2066	0.2003	4,832	\$968	191	\$38	4,433	\$888	9,456	\$1,894	0.05	0.1503	\$1,420.82
52	2067	0.2014	4,832	\$973	191	\$38	4,433	\$893	9,456	\$1,905	0.05	0.1514	\$1,431.78
53	2068	0.2026	4,832	\$979	191	\$39	4,433	\$898	9,456	\$1,916	0.05	0.1526	\$1,442.79
54	2069	0.2038	4,832	\$985	191	\$39	4,433	\$903	9,456	\$1,927	0.05	0.1538	\$1,453.87
55	2070	0.2049	4,832	\$990	191	\$39	4,433	\$908	9,456	\$1,938	0.05	0.1549	\$1,465.02
56	2071	0.2061	4,832	\$996	191	\$39	4,433	\$914	9,456	\$1,949	0.05	0.1561	\$1,476.23
57	2072	0.2073	4,832	\$1,002	191	\$40	4,433	\$919	9,456	\$1,960	0.05	0.1573	\$1,487.50
58	2073	0.2085	4,832	\$1,008	191	\$40	4,433	\$924	9,456	\$1,972	0.05	0.1585	\$1,498.84
59	2074	0.2097	4,832	\$1,013	191	\$40	4,433	\$930	9,456	\$1,983	0.05	0.1597	\$1,510.25
60	2075	0.2109	4,832	\$1,019	191	\$40	4,433	\$935	9,456	\$1,995	0.05	0.1609	\$1,521.72

Table D2-1.22: Annual Operating Costs (V.GSHP) of a 2,000 square feet detached house above grade (improved construction type) in the city of Mount Forest (two life cycles and three life cycles for a 60 year project lifespan); base case scenario in comparison with feed in-tariff (FIT) scenario. In the FIT scenario, an incentive of \$0.05/KWh is provided on electricity bills throughout the project lifespan

Horizontal Ground Source Heat Pump (H.GSHP)

Base Case Scenario										Feed in Tariff (FIT)			
H.GSHP										FIT			
#	Year	Electricity Rates \$/KWh	Heating KWh	Heating Operating Cost \$	Cooling KWh	Cooling Operating Cost \$	Hot Water KWh	Hot Water Operating Cost \$	Total KWh	Total Operating Cost \$	Incentives (\$/KWh)	S/KWh	Operating Cost
1	2016	0.1501	4,877	\$732	201	\$30	4,226	\$634	9,304	\$1,396	0.05	0.1001	\$931.17
2	2017	0.1542	4,877	\$752	201	\$31	4,226	\$652	9,304	\$1,435	0.05	0.1042	\$969.35
3	2018	0.1583	4,877	\$772	201	\$32	4,226	\$669	9,304	\$1,473	0.05	0.1083	\$1,007.54
4	2019	0.1625	4,877	\$793	201	\$33	4,226	\$687	9,304	\$1,512	0.05	0.1125	\$1,047.06
5	2020	0.1668	4,877	\$813	201	\$34	4,226	\$705	9,304	\$1,552	0.05	0.1168	\$1,086.58
6	2021	0.1621	4,877	\$791	201	\$33	4,226	\$685	9,304	\$1,509	0.05	0.1121	\$1,043.38
7	2022	0.1629	4,877	\$795	201	\$33	4,226	\$689	9,304	\$1,516	0.05	0.1129	\$1,050.74
8	2023	0.1639	4,877	\$799	201	\$33	4,226	\$693	9,304	\$1,525	0.05	0.1139	\$1,059.45
9	2024	0.1648	4,877	\$804	201	\$33	4,226	\$696	9,304	\$1,533	0.05	0.1148	\$1,068.16
10	2025	0.1656	4,877	\$808	201	\$33	4,226	\$700	9,304	\$1,541	0.05	0.1156	\$1,075.53
11	2026	0.1665	4,877	\$812	201	\$33	4,226	\$704	9,304	\$1,549	0.05	0.1165	\$1,084.24
12	2027	0.1674	4,877	\$817	201	\$34	4,226	\$708	9,304	\$1,558	0.05	0.1174	\$1,092.61
13	2028	0.1683	4,877	\$821	201	\$34	4,226	\$711	9,304	\$1,566	0.05	0.1183	\$1,100.32
14	2029	0.1692	4,877	\$825	201	\$34	4,226	\$715	9,304	\$1,574	0.05	0.1192	\$1,108.69
15	2030	0.1701	4,877	\$830	201	\$34	4,226	\$719	9,304	\$1,583	0.05	0.1201	\$1,117.40
16	2031	0.1704	4,877	\$831	201	\$34	4,226	\$720	9,304	\$1,585	0.05	0.1204	\$1,119.74
17	2032	0.1705	4,877	\$832	201	\$34	4,226	\$721	9,304	\$1,586	0.05	0.1205	\$1,121.08
18	2033	0.1707	4,877	\$833	201	\$34	4,226	\$722	9,304	\$1,589	0.05	0.1207	\$1,123.43
19	2034	0.1710	4,877	\$834	201	\$34	4,226	\$723	9,304	\$1,591	0.05	0.1210	\$1,126.11
20	2035	0.1713	4,877	\$835	201	\$34	4,226	\$724	9,304	\$1,594	0.05	0.1213	\$1,128.45
21	2036	0.1714	4,877	\$836	201	\$34	4,226	\$724	9,304	\$1,595	0.05	0.1214	\$1,129.79
22	2037	0.1717	4,877	\$837	201	\$35	4,226	\$726	9,304	\$1,597	0.05	0.1217	\$1,132.14
23	2038	0.1720	4,877	\$839	201	\$35	4,226	\$727	9,304	\$1,600	0.05	0.1220	\$1,134.81
24	2039	0.1722	4,877	\$840	201	\$35	4,226	\$728	9,304	\$1,602	0.05	0.1222	\$1,137.16
25	2040	0.1724	4,877	\$841	201	\$35	4,226	\$728	9,304	\$1,604	0.05	0.1224	\$1,138.50
26	2041	0.1734	4,877	\$845	201	\$35	4,226	\$733	9,304	\$1,613	0.05	0.1234	\$1,147.78
27	2042	0.1744	4,877	\$850	201	\$35	4,226	\$737	9,304	\$1,622	0.05	0.1244	\$1,157.11
28	2043	0.1754	4,877	\$855	201	\$35	4,226	\$741	9,304	\$1,632	0.05	0.1254	\$1,166.49
29	2044	0.1764	4,877	\$860	201	\$35	4,226	\$745	9,304	\$1,641	0.05	0.1264	\$1,175.93
30	2045	0.1774	4,877	\$865	201	\$36	4,226	\$750	9,304	\$1,651	0.05	0.1274	\$1,185.42
31	2046	0.1784	4,877	\$870	201	\$36	4,226	\$754	9,304	\$1,660	0.05	0.1284	\$1,194.97
32	2047	0.1795	4,877	\$875	201	\$36	4,226	\$758	9,304	\$1,670	0.05	0.1295	\$1,204.58
33	2048	0.1805	4,877	\$880	201	\$36	4,226	\$763	9,304	\$1,679	0.05	0.1305	\$1,214.24
34	2049	0.1816	4,877	\$885	201	\$36	4,226	\$767	9,304	\$1,689	0.05	0.1316	\$1,223.95
35	2050	0.1826	4,877	\$891	201	\$37	4,226	\$772	9,304	\$1,699	0.05	0.1326	\$1,233.72
36	2051	0.1837	4,877	\$896	201	\$37	4,226	\$776	9,304	\$1,709	0.05	0.1337	\$1,243.55
37	2052	0.1847	4,877	\$901	201	\$37	4,226	\$781	9,304	\$1,719	0.05	0.1347	\$1,253.44
38	2053	0.1858	4,877	\$906	201	\$37	4,226	\$785	9,304	\$1,729	0.05	0.1358	\$1,263.38
39	2054	0.1869	4,877	\$911	201	\$38	4,226	\$790	9,304	\$1,739	0.05	0.1369	\$1,273.38
40	2055	0.1879	4,877	\$917	201	\$38	4,226	\$794	9,304	\$1,749	0.05	0.1379	\$1,283.44
41	2056	0.1890	4,877	\$922	201	\$38	4,226	\$799	9,304	\$1,759	0.05	0.1390	\$1,293.55
42	2057	0.1901	4,877	\$927	201	\$38	4,226	\$803	9,304	\$1,769	0.05	0.1401	\$1,303.73
43	2058	0.1912	4,877	\$933	201	\$38	4,226	\$808	9,304	\$1,779	0.05	0.1412	\$1,313.96
44	2059	0.1923	4,877	\$938	201	\$39	4,226	\$813	9,304	\$1,789	0.05	0.1423	\$1,324.25
45	2060	0.1934	4,877	\$943	201	\$39	4,226	\$817	9,304	\$1,800	0.05	0.1434	\$1,334.60
46	2061	0.1946	4,877	\$949	201	\$39	4,226	\$822	9,304	\$1,810	0.05	0.1446	\$1,345.01
47	2062	0.1957	4,877	\$954	201	\$39	4,226	\$827	9,304	\$1,821	0.05	0.1457	\$1,355.49
48	2063	0.1968	4,877	\$960	201	\$40	4,226	\$832	9,304	\$1,831	0.05	0.1468	\$1,366.02
49	2064	0.1980	4,877	\$965	201	\$40	4,226	\$837	9,304	\$1,842	0.05	0.1480	\$1,376.61
50	2065	0.1991	4,877	\$971	201	\$40	4,226	\$841	9,304	\$1,852	0.05	0.1491	\$1,387.27
51	2066	0.2003	4,877	\$977	201	\$40	4,226	\$846	9,304	\$1,863	0.05	0.1503	\$1,397.98
52	2067	0.2014	4,877	\$982	201	\$40	4,226	\$851	9,304	\$1,874	0.05	0.1514	\$1,408.76
53	2068	0.2026	4,877	\$988	201	\$41	4,226	\$856	9,304	\$1,885	0.05	0.1526	\$1,419.60
54	2069	0.2038	4,877	\$994	201	\$41	4,226	\$861	9,304	\$1,896	0.05	0.1538	\$1,430.50
55	2070	0.2049	4,877	\$999	201	\$41	4,226	\$866	9,304	\$1,907	0.05	0.1549	\$1,441.47
56	2071	0.2061	4,877	\$1,005	201	\$41	4,226	\$871	9,304	\$1,918	0.05	0.1561	\$1,452.50
57	2072	0.2073	4,877	\$1,011	201	\$42	4,226	\$876	9,304	\$1,929	0.05	0.1573	\$1,463.59
58	2073	0.2085	4,877	\$1,017	201	\$42	4,226	\$881	9,304	\$1,940	0.05	0.1585	\$1,474.75
59	2074	0.2097	4,877	\$1,023	201	\$42	4,226	\$886	9,304	\$1,951	0.05	0.1597	\$1,485.97
60	2075	0.2109	4,877	\$1,029	201	\$42	4,226	\$891	9,304	\$1,962	0.05	0.1609	\$1,497.26

Table D2-1.23: Annual Operating Costs (H.GSHP) of a 2,000 square feet detached house above grade (improved construction type) in the city of Mount Forest (two life cycles and three life cycles for a 60 year project lifespan); base case scenario in comparison with in-tariff (FIT) scenario. In the FIT scenario, an incentive of \$0.05/KWh is provided on electricity bills throughout the project lifespan

Traditional HVAC Applications

Base Case Scenario																Carbon Taxes						
#	Year	Traditional														Total	Conversion of m ³ into Tons	Total Tons	Carbon Tax	Operating Costs		
		Electricity Rates	Natural Gas Rates	Heating		Heating Operating Cost	Heating Operating Cost	Total Heating Operating Cost	Cooling		Hot Water	Hot Water Operating Cost	Total	Total	Total Electricity Operating Cost						Total Natural Gas Operating Cost	
				KWh (Electricity)	m ³ (Gas)				\$ (Electricity)	\$ (Gas)												\$
\$/KWh	\$/m ³																					
1	2016	0.1501	0.3458	1,873	2,350	\$281	\$813	\$1,094	920	\$138	1,015	\$351	2,793	3,365	419	\$1,164	\$1,583	6.09	6.09	\$10	\$60.91	\$1,643.81
2	2017	0.1542	0.3588	1,873	2,350	\$289	\$843	\$1,132	920	\$142	1,015	\$356	2,793	3,365	431	\$1,207	\$1,638	6.09	6.09	\$20	\$121.81	\$1,759.94
3	2018	0.1583	0.3718	1,873	2,350	\$296	\$874	\$1,170	920	\$146	1,015	\$361	2,793	3,365	442	\$1,251	\$1,693	6.09	6.09	\$30	\$182.72	\$1,876.08
4	2019	0.1625	0.3776	1,873	2,350	\$304	\$887	\$1,192	920	\$150	1,015	\$365	2,793	3,365	454	\$1,271	\$1,725	6.09	6.09	\$40	\$243.63	\$1,968.16
5	2020	0.1668	0.3841	1,873	2,350	\$312	\$903	\$1,215	920	\$153	1,015	\$369	2,793	3,365	466	\$1,292	\$1,758	6.09	6.09	\$50	\$304.53	\$2,062.82
6	2021	0.1621	0.3883	1,873	2,350	\$304	\$912	\$1,216	920	\$149	1,015	\$365	2,793	3,365	453	\$1,307	\$1,759	6.09	6.09	\$60	\$365.44	\$2,124.91
7	2022	0.1629	0.3929	1,873	2,350	\$305	\$923	\$1,228	920	\$150	1,015	\$365	2,793	3,365	455	\$1,322	\$1,777	6.09	6.09	\$70	\$426.35	\$2,203.48
8	2023	0.1639	0.3967	1,873	2,350	\$307	\$932	\$1,239	920	\$151	1,015	\$366	2,793	3,365	458	\$1,335	\$1,793	6.09	6.09	\$80	\$487.25	\$2,279.87
9	2024	0.1648	0.4005	1,873	2,350	\$309	\$941	\$1,250	920	\$152	1,015	\$367	2,793	3,365	460	\$1,348	\$1,808	6.09	6.09	\$90	\$548.16	\$2,356.27
10	2025	0.1656	0.4040	1,873	2,350	\$310	\$949	\$1,260	920	\$152	1,015	\$368	2,793	3,365	463	\$1,359	\$1,822	6.09	6.09	\$100	\$609.07	\$2,430.97
11	2026	0.1665	0.4070	1,873	2,350	\$312	\$957	\$1,268	920	\$153	1,015	\$369	2,793	3,365	465	\$1,370	\$1,835	6.09	6.09	\$110	\$669.97	\$2,504.79
12	2027	0.1674	0.4097	1,873	2,350	\$314	\$963	\$1,276	920	\$154	1,015	\$370	2,793	3,365	468	\$1,379	\$1,846	6.09	6.09	\$120	\$730.88	\$2,577.72
13	2028	0.1683	0.4124	1,873	2,350	\$315	\$969	\$1,284	920	\$155	1,015	\$371	2,793	3,365	470	\$1,388	\$1,858	6.09	6.09	\$130	\$791.78	\$2,649.45
14	2029	0.1692	0.4151	1,873	2,350	\$317	\$975	\$1,292	920	\$156	1,015	\$372	2,793	3,365	472	\$1,397	\$1,869	6.09	6.09	\$140	\$852.69	\$2,721.88
15	2030	0.1701	0.4170	1,873	2,350	\$319	\$980	\$1,299	920	\$156	1,015	\$373	2,793	3,365	475	\$1,403	\$1,878	6.09	6.09	\$150	\$913.60	\$2,791.84
16	2031	0.1704	0.4189	1,873	2,350	\$319	\$984	\$1,303	920	\$157	1,015	\$373	2,793	3,365	476	\$1,410	\$1,885	6.09	6.09	\$160	\$974.50	\$2,859.89
17	2032	0.1705	0.4204	1,873	2,350	\$319	\$988	\$1,307	920	\$157	1,015	\$373	2,793	3,365	476	\$1,415	\$1,891	6.09	6.09	\$170	\$1,035.41	\$2,926.34
18	2033	0.1707	0.4223	1,873	2,350	\$320	\$993	\$1,312	920	\$157	1,015	\$373	2,793	3,365	477	\$1,421	\$1,898	6.09	6.09	\$180	\$1,096.32	\$2,994.39
19	2034	0.1710	0.4246	1,873	2,350	\$320	\$998	\$1,318	920	\$157	1,015	\$374	2,793	3,365	478	\$1,429	\$1,907	6.09	6.09	\$190	\$1,157.22	\$3,063.83
20	2035	0.1713	0.4265	1,873	2,350	\$321	\$1,002	\$1,323	920	\$158	1,015	\$374	2,793	3,365	478	\$1,435	\$1,914	6.09	6.09	\$200	\$1,218.13	\$3,131.87
21	2036	0.1714	0.4288	1,873	2,350	\$321	\$1,008	\$1,329	920	\$158	1,015	\$374	2,793	3,365	479	\$1,443	\$1,922	6.09	6.09	\$210	\$1,279.04	\$3,200.90
22	2037	0.1717	0.4311	1,873	2,350	\$322	\$1,013	\$1,335	920	\$158	1,015	\$374	2,793	3,365	480	\$1,451	\$1,930	6.09	6.09	\$220	\$1,339.94	\$3,270.24
23	2038	0.1720	0.4331	1,873	2,350	\$322	\$1,018	\$1,340	920	\$158	1,015	\$375	2,793	3,365	480	\$1,457	\$1,938	6.09	6.09	\$230	\$1,400.85	\$3,338.39
24	2039	0.1722	0.4353	1,873	2,350	\$323	\$1,023	\$1,346	920	\$158	1,015	\$375	2,793	3,365	481	\$1,465	\$1,946	6.09	6.09	\$240	\$1,461.76	\$3,407.72
25	2040	0.1724	0.4376	1,873	2,350	\$323	\$1,028	\$1,351	920	\$159	1,015	\$375	2,793	3,365	481	\$1,473	\$1,954	6.09	6.09	\$250	\$1,522.66	\$3,476.75
26	2041	0.1734	0.4420	1,873	2,350	\$325	\$1,039	\$1,363	920	\$159	1,015	\$376	2,793	3,365	484	\$1,487	\$1,971	6.09	6.09	\$260	\$1,583.57	\$3,554.96
27	2042	0.1744	0.4463	1,873	2,350	\$327	\$1,049	\$1,375	920	\$160	1,015	\$377	2,793	3,365	487	\$1,502	\$1,989	6.09	6.09	\$270	\$1,644.48	\$3,633.33
28	2043	0.1754	0.4507	1,873	2,350	\$328	\$1,059	\$1,388	920	\$161	1,015	\$378	2,793	3,365	490	\$1,517	\$2,006	6.09	6.09	\$280	\$1,705.38	\$3,711.86
29	2044	0.1764	0.4552	1,873	2,350	\$330	\$1,070	\$1,400	920	\$162	1,015	\$379	2,793	3,365	493	\$1,532	\$2,024	6.09	6.09	\$290	\$1,766.29	\$3,790.56
30	2045	0.1774	0.4596	1,873	2,350	\$332	\$1,080	\$1,412	920	\$163	1,015	\$380	2,793	3,365	496	\$1,547	\$2,042	6.09	6.09	\$300	\$1,827.20	\$3,869.41
31	2046	0.1784	0.4642	1,873	2,350	\$334	\$1,091	\$1,425	920	\$164	1,015	\$381	2,793	3,365	498	\$1,562	\$2,060	6.09	6.09	\$310	\$1,888.10	\$3,948.43
32	2047	0.1795	0.4688	1,873	2,350	\$336	\$1,102	\$1,438	920	\$165	1,015	\$382	2,793	3,365	501	\$1,577	\$2,079	6.09	6.09	\$320	\$1,949.01	\$4,027.62
33	2048	0.1805	0.4734	1,873	2,350	\$338	\$1,112	\$1,451	920	\$166	1,015	\$383	2,793	3,365	504	\$1,593	\$2,097	6.09	6.09	\$330	\$2,009.91	\$4,106.98
34	2049	0.1816	0.4780	1,873	2,350	\$340	\$1,123	\$1,463	920	\$167	1,015	\$384	2,793	3,365	507	\$1,609	\$2,116	6.09	6.09	\$340	\$2,070.82	\$4,186.51
35	2050	0.1826	0.4828	1,873	2,350	\$342	\$1,134	\$1,476	920	\$168	1,015	\$385	2,793	3,365	510	\$1,624	\$2,134	6.09	6.09	\$350	\$2,131.73	\$4,266.21
36	2051	0.1837	0.4875	1,873	2,350	\$344	\$1,146	\$1,489	920	\$169	1,015	\$386	2,793	3,365	513	\$1,640	\$2,153	6.09	6.09	\$360	\$2,192.63	\$4,346.08
37	2052	0.1847	0.4923	1,873	2,350	\$346	\$1,157	\$1,503	920	\$170	1,015	\$387	2,793	3,365	516	\$1,657	\$2,173	6.09	6.09	\$370	\$2,253.54	\$4,426.13
38	2053	0.1858	0.4972	1,873	2,350	\$348	\$1,168	\$1,516	920	\$171	1,015	\$389	2,793	3,365	519	\$1,673	\$2,192	6.09	6.09	\$380	\$2,314.45	\$4,506.35
39	2054	0.1869	0.5021	1,873	2,350	\$350	\$1,180	\$1,530	920	\$172	1,015	\$390	2,793	3,365	522	\$1,689	\$2,211	6.09	6.09	\$390	\$2,375.35	\$4,586.75
40	2055	0.1879	0.5070	1,873	2,350	\$352	\$1,192	\$1,544	920	\$173	1,015	\$391	2,793	3,365	525	\$1,706	\$2,231	6.09	6.09	\$400	\$2,436.26	\$4,667.34
41	2056	0.1890	0.5120	1,873	2,350	\$354	\$1,203	\$1,557	920	\$174	1,015	\$392	2,793	3,365	528	\$1,723	\$2,251	6.09	6.09	\$410	\$2,497.17	\$4,748.10
42	2057	0.1901	0.5171	1,873	2,350	\$356	\$1,215	\$1,571	920	\$175	1,015	\$393	2,793	3,365	531	\$1,740	\$2,271	6.09	6.09	\$420	\$2,558.07	\$4,829.05
43	2058	0.1912	0.5222	1,873	2,350	\$358	\$1,227	\$1,585	920	\$176	1,015	\$394	2,793	3,365	534	\$1,757	\$2,291	6.09	6.09	\$430	\$2,618.98	\$4,910.18
44	2059	0.1923	0.5273	1,873	2,350	\$360	\$1,239	\$1,599	920	\$177	1,015	\$395	2,793	3,365	537	\$1,774	\$2,312	6.09	6.09	\$440	\$2,679.89	\$4,991.50
45	2060	0.1934	0.5325	1,873	2,350	\$362	\$1,251	\$1,614	920	\$178	1,015	\$396	2,793	3,365	540	\$1,792	\$2,332	6.09	6.09	\$450	\$2,740.79	\$5,073.01
46	2061	0.1946	0.5378	1,873	2,350	\$364	\$1,264	\$1,628	920	\$179	1,015	\$397	2,793	3,365	543	\$1,810	\$2,353	6.09	6.09	\$460	\$2,801.70	\$5,154.71
47	2062	0.1957	0.5431	1,873	2,350	\$367	\$1,276	\$1,643	920	\$180	1,015	\$399	2,793	3,365	547	\$1,827	\$2,374	6.09	6.09	\$470	\$2,862.61	\$5,236.60
48	2063	0.1968	0.5484	1,873	2,350	\$369	\$1,289	\$1,657	920	\$181	1,015	\$400	2,793	3,365	550	\$1,845	\$2,395	6.09	6.09	\$480	\$2,923.51	\$5,318.68
49	2064	0.1980	0.5538	1,873	2,350	\$371	\$1,302	\$1,672	920	\$182	1,015	\$401	2,793	3,365	553	\$1,864	\$2,417	6.09	6.09	\$490	\$2,984.42	\$5,400.96
50	2065	0.1991	0.5593	1,873	2,350	\$373	\$1,314	\$1,687	920	\$183	1,015	\$402	2,793	3,365	556	\$1,882	\$2,438	6.09	6.09	\$500	\$3,045.33	\$5,483.44
51	2066	0.2003	0.5648	1,873	2,350	\$375	\$1,327	\$1,702	920	\$184	1,015	\$403	2,793	3,365	559	\$1,901	\$2,460	6.09	6.09	\$510	\$3,106.23	\$5,566.12
52	2067	0.2014	0.5704	1,873	2,350	\$377	\$1,340	\$1,718	920	\$185	1,015	\$404	2,793	3,365	563	\$1,919	\$2,482	6.09	6.09	\$520	\$3,167.14	\$5,649.00
53	2068	0.2026	0.5760	1,873	2,350	\$379	\$1,354	\$1,733	920	\$186	1,015	\$406	2,793	3,365	566	\$1,938	\$2,504	6.09	6			

9. Niagara Falls (South) – Annual Operating Costs

Vertical Ground Source Heat Pump (V.GSHP)

Base Case Scenario											Feed In Tariff (FIT)			
#	Year	Electricity Rates		V.GSHP		Cooling	Cooling Operating Cost	Hot Water	Hot Water Operating Cost	Total	Total Operating Cost	FIT		
		\$/KWh	KWh	Heating	Heating Operating Cost							Incentives (\$/KWh)	\$/KWh	Operating Cost
1	2016	0.1501	3,515	\$528	366	366	\$55	4,583	\$688	8,464	\$1,270	0.05	0.1001	\$847.10
2	2017	0.1542	3,515	\$542	366	366	\$56	4,583	\$707	8,464	\$1,305	0.05	0.1042	\$881.84
3	2018	0.1583	3,515	\$556	366	366	\$58	4,583	\$725	8,464	\$1,340	0.05	0.1083	\$916.57
4	2019	0.1625	3,515	\$571	366	366	\$59	4,583	\$745	8,464	\$1,376	0.05	0.1125	\$952.53
5	2020	0.1668	3,515	\$586	366	366	\$61	4,583	\$764	8,464	\$1,412	0.05	0.1168	\$988.48
6	2021	0.1621	3,515	\$570	366	366	\$59	4,583	\$743	8,464	\$1,372	0.05	0.1121	\$949.18
7	2022	0.1629	3,515	\$573	366	366	\$60	4,583	\$747	8,464	\$1,379	0.05	0.1129	\$955.88
8	2023	0.1639	3,515	\$576	366	366	\$60	4,583	\$751	8,464	\$1,387	0.05	0.1139	\$963.80
9	2024	0.1648	3,515	\$579	366	366	\$60	4,583	\$755	8,464	\$1,395	0.05	0.1148	\$971.72
10	2025	0.1656	3,515	\$582	366	366	\$61	4,583	\$759	8,464	\$1,402	0.05	0.1156	\$978.43
11	2026	0.1665	3,515	\$585	366	366	\$61	4,583	\$763	8,464	\$1,410	0.05	0.1165	\$986.35
12	2027	0.1674	3,515	\$589	366	366	\$61	4,583	\$767	8,464	\$1,417	0.05	0.1174	\$993.97
13	2028	0.1683	3,515	\$591	366	366	\$62	4,583	\$771	8,464	\$1,424	0.05	0.1183	\$1,000.98
14	2029	0.1692	3,515	\$595	366	366	\$62	4,583	\$775	8,464	\$1,432	0.05	0.1192	\$1,008.59
15	2030	0.1701	3,515	\$598	366	366	\$62	4,583	\$780	8,464	\$1,440	0.05	0.1201	\$1,016.51
16	2031	0.1704	3,515	\$599	366	366	\$62	4,583	\$781	8,464	\$1,442	0.05	0.1204	\$1,018.65
17	2032	0.1705	3,515	\$599	366	366	\$62	4,583	\$781	8,464	\$1,443	0.05	0.1205	\$1,019.87
18	2033	0.1707	3,515	\$600	366	366	\$62	4,583	\$783	8,464	\$1,445	0.05	0.1207	\$1,022.00
19	2034	0.1710	3,515	\$601	366	366	\$63	4,583	\$784	8,464	\$1,448	0.05	0.1210	\$1,024.44
20	2035	0.1713	3,515	\$602	366	366	\$63	4,583	\$785	8,464	\$1,450	0.05	0.1213	\$1,026.57
21	2036	0.1714	3,515	\$603	366	366	\$63	4,583	\$786	8,464	\$1,451	0.05	0.1214	\$1,027.79
22	2037	0.1717	3,515	\$603	366	366	\$63	4,583	\$787	8,464	\$1,453	0.05	0.1217	\$1,029.92
23	2038	0.1720	3,515	\$604	366	366	\$63	4,583	\$788	8,464	\$1,456	0.05	0.1220	\$1,032.36
24	2039	0.1722	3,515	\$605	366	366	\$63	4,583	\$789	8,464	\$1,458	0.05	0.1222	\$1,034.49
25	2040	0.1724	3,515	\$606	366	366	\$63	4,583	\$790	8,464	\$1,459	0.05	0.1224	\$1,035.71
26	2041	0.1734	3,515	\$609	366	366	\$63	4,583	\$795	8,464	\$1,467	0.05	0.1234	\$1,044.15
27	2042	0.1744	3,515	\$613	366	366	\$64	4,583	\$799	8,464	\$1,476	0.05	0.1244	\$1,052.64
28	2043	0.1754	3,515	\$616	366	366	\$64	4,583	\$804	8,464	\$1,484	0.05	0.1254	\$1,061.18
29	2044	0.1764	3,515	\$620	366	366	\$65	4,583	\$808	8,464	\$1,493	0.05	0.1264	\$1,069.76
30	2045	0.1774	3,515	\$624	366	366	\$65	4,583	\$813	8,464	\$1,502	0.05	0.1274	\$1,078.40
31	2046	0.1784	3,515	\$627	366	366	\$65	4,583	\$818	8,464	\$1,510	0.05	0.1284	\$1,087.09
32	2047	0.1795	3,515	\$631	366	366	\$66	4,583	\$823	8,464	\$1,519	0.05	0.1295	\$1,095.82
33	2048	0.1805	3,515	\$634	366	366	\$66	4,583	\$827	8,464	\$1,528	0.05	0.1305	\$1,104.61
34	2049	0.1816	3,515	\$638	366	366	\$66	4,583	\$832	8,464	\$1,537	0.05	0.1316	\$1,113.45
35	2050	0.1826	3,515	\$642	366	366	\$67	4,583	\$837	8,464	\$1,546	0.05	0.1326	\$1,122.34
36	2051	0.1837	3,515	\$646	366	366	\$67	4,583	\$842	8,464	\$1,554	0.05	0.1337	\$1,131.28
37	2052	0.1847	3,515	\$649	366	366	\$68	4,583	\$847	8,464	\$1,563	0.05	0.1347	\$1,140.27
38	2053	0.1858	3,515	\$653	366	366	\$68	4,583	\$851	8,464	\$1,573	0.05	0.1358	\$1,149.32
39	2054	0.1869	3,515	\$657	366	366	\$68	4,583	\$856	8,464	\$1,582	0.05	0.1369	\$1,158.41
40	2055	0.1879	3,515	\$661	366	366	\$69	4,583	\$861	8,464	\$1,591	0.05	0.1379	\$1,167.56
41	2056	0.1890	3,515	\$664	366	366	\$69	4,583	\$866	8,464	\$1,600	0.05	0.1390	\$1,176.76
42	2057	0.1901	3,515	\$668	366	366	\$70	4,583	\$871	8,464	\$1,609	0.05	0.1401	\$1,186.02
43	2058	0.1912	3,515	\$672	366	366	\$70	4,583	\$876	8,464	\$1,619	0.05	0.1412	\$1,195.33
44	2059	0.1923	3,515	\$676	366	366	\$70	4,583	\$881	8,464	\$1,628	0.05	0.1423	\$1,204.69
45	2060	0.1934	3,515	\$680	366	366	\$71	4,583	\$887	8,464	\$1,637	0.05	0.1434	\$1,214.11
46	2061	0.1946	3,515	\$684	366	366	\$71	4,583	\$892	8,464	\$1,647	0.05	0.1446	\$1,223.58
47	2062	0.1957	3,515	\$688	366	366	\$72	4,583	\$897	8,464	\$1,656	0.05	0.1457	\$1,233.11
48	2063	0.1968	3,515	\$692	366	366	\$72	4,583	\$902	8,464	\$1,666	0.05	0.1468	\$1,242.69
49	2064	0.1980	3,515	\$696	366	366	\$72	4,583	\$907	8,464	\$1,676	0.05	0.1480	\$1,252.33
50	2065	0.1991	3,515	\$700	366	366	\$73	4,583	\$912	8,464	\$1,685	0.05	0.1491	\$1,262.02
51	2066	0.2003	3,515	\$704	366	366	\$73	4,583	\$918	8,464	\$1,695	0.05	0.1503	\$1,271.77
52	2067	0.2014	3,515	\$708	366	366	\$74	4,583	\$923	8,464	\$1,705	0.05	0.1514	\$1,281.57
53	2068	0.2026	3,515	\$712	366	366	\$74	4,583	\$928	8,464	\$1,715	0.05	0.1526	\$1,291.43
54	2069	0.2038	3,515	\$716	366	366	\$75	4,583	\$934	8,464	\$1,725	0.05	0.1538	\$1,301.35
55	2070	0.2049	3,515	\$720	366	366	\$75	4,583	\$939	8,464	\$1,735	0.05	0.1549	\$1,311.33
56	2071	0.2061	3,515	\$724	366	366	\$75	4,583	\$945	8,464	\$1,745	0.05	0.1561	\$1,321.36
57	2072	0.2073	3,515	\$729	366	366	\$76	4,583	\$950	8,464	\$1,755	0.05	0.1573	\$1,331.46
58	2073	0.2085	3,515	\$733	366	366	\$76	4,583	\$956	8,464	\$1,765	0.05	0.1585	\$1,341.61
59	2074	0.2097	3,515	\$737	366	366	\$77	4,583	\$961	8,464	\$1,775	0.05	0.1597	\$1,351.81
60	2075	0.2109	3,515	\$741	366	366	\$77	4,583	\$967	8,464	\$1,785	0.05	0.1609	\$1,362.08

Table D2-1.25: Annual Operating Costs (V.GSHP) of a 2,000 square feet detached house above grade (improved construction type) in the city of Niagara Falls (two life cycles and three life cycles for a 60 year project lifespan); base case scenario in comparison with feed in-tariff (FIT) scenario. In the FIT scenario, an incentive of \$0.05/KWh is provided on electricity bills throughout the project lifespan

Horizontal Ground Source Heat Pump (H.GSHP)

Base Case Scenario											Feed in Tariff (FIT)		
#	Year	H.GSHP									FIT		
		Electricity Rates \$/KWh	Heating KWh	Heating Operating Cost \$	Cooling KWh	Cooling Operating Cost \$	Hot Water KWh	Hot Water Operating Cost \$	Total KWh	Total Operating Cost \$	Incentives (\$/KWh)	S/KWh	Operating Cost
1	2016	0.1501	3,582	\$538	370	\$56	4,586	\$688	8,538	\$1,281	0.05	0.1001	\$854.51
2	2017	0.1542	3,582	\$552	370	\$57	4,586	\$707	8,538	\$1,316	0.05	0.1042	\$889.55
3	2018	0.1583	3,582	\$567	370	\$59	4,586	\$726	8,538	\$1,351	0.05	0.1083	\$924.59
4	2019	0.1625	3,582	\$582	370	\$60	4,586	\$745	8,538	\$1,388	0.05	0.1125	\$960.86
5	2020	0.1668	3,582	\$597	370	\$62	4,586	\$765	8,538	\$1,424	0.05	0.1168	\$997.12
6	2021	0.1621	3,582	\$581	370	\$60	4,586	\$744	8,538	\$1,384	0.05	0.1121	\$957.47
7	2022	0.1629	3,582	\$584	370	\$60	4,586	\$747	8,538	\$1,391	0.05	0.1129	\$964.24
8	2023	0.1639	3,582	\$587	370	\$61	4,586	\$752	8,538	\$1,399	0.05	0.1139	\$972.23
9	2024	0.1648	3,582	\$590	370	\$61	4,586	\$756	8,538	\$1,407	0.05	0.1148	\$980.22
10	2025	0.1656	3,582	\$593	370	\$61	4,586	\$759	8,538	\$1,414	0.05	0.1156	\$986.98
11	2026	0.1665	3,582	\$597	370	\$62	4,586	\$764	8,538	\$1,422	0.05	0.1165	\$994.97
12	2027	0.1674	3,582	\$600	370	\$62	4,586	\$768	8,538	\$1,430	0.05	0.1174	\$1,002.66
13	2028	0.1683	3,582	\$603	370	\$62	4,586	\$772	8,538	\$1,437	0.05	0.1183	\$1,009.73
14	2029	0.1692	3,582	\$606	370	\$63	4,586	\$776	8,538	\$1,444	0.05	0.1192	\$1,017.41
15	2030	0.1701	3,582	\$609	370	\$63	4,586	\$780	8,538	\$1,452	0.05	0.1201	\$1,025.40
16	2031	0.1704	3,582	\$610	370	\$63	4,586	\$781	8,538	\$1,454	0.05	0.1204	\$1,027.55
17	2032	0.1705	3,582	\$611	370	\$63	4,586	\$782	8,538	\$1,456	0.05	0.1205	\$1,028.78
18	2033	0.1707	3,582	\$612	370	\$63	4,586	\$783	8,538	\$1,458	0.05	0.1207	\$1,030.93
19	2034	0.1710	3,582	\$613	370	\$63	4,586	\$784	8,538	\$1,460	0.05	0.1210	\$1,033.39
20	2035	0.1713	3,582	\$614	370	\$63	4,586	\$786	8,538	\$1,462	0.05	0.1213	\$1,035.55
21	2036	0.1714	3,582	\$614	370	\$63	4,586	\$786	8,538	\$1,464	0.05	0.1214	\$1,036.77
22	2037	0.1717	3,582	\$615	370	\$64	4,586	\$787	8,538	\$1,466	0.05	0.1217	\$1,038.93
23	2038	0.1720	3,582	\$616	370	\$64	4,586	\$789	8,538	\$1,468	0.05	0.1220	\$1,041.39
24	2039	0.1722	3,582	\$617	370	\$64	4,586	\$790	8,538	\$1,470	0.05	0.1222	\$1,043.54
25	2040	0.1724	3,582	\$617	370	\$64	4,586	\$790	8,538	\$1,472	0.05	0.1224	\$1,044.77
26	2041	0.1734	3,582	\$621	370	\$64	4,586	\$795	8,538	\$1,480	0.05	0.1234	\$1,053.28
27	2042	0.1744	3,582	\$625	370	\$65	4,586	\$800	8,538	\$1,489	0.05	0.1244	\$1,061.84
28	2043	0.1754	3,582	\$628	370	\$65	4,586	\$804	8,538	\$1,497	0.05	0.1254	\$1,070.45
29	2044	0.1764	3,582	\$632	370	\$65	4,586	\$809	8,538	\$1,506	0.05	0.1264	\$1,079.12
30	2045	0.1774	3,582	\$635	370	\$66	4,586	\$814	8,538	\$1,515	0.05	0.1274	\$1,087.83
31	2046	0.1784	3,582	\$639	370	\$66	4,586	\$818	8,538	\$1,523	0.05	0.1284	\$1,096.59
32	2047	0.1795	3,582	\$643	370	\$66	4,586	\$823	8,538	\$1,532	0.05	0.1295	\$1,105.40
33	2048	0.1805	3,582	\$647	370	\$67	4,586	\$828	8,538	\$1,541	0.05	0.1305	\$1,114.27
34	2049	0.1816	3,582	\$650	370	\$67	4,586	\$833	8,538	\$1,550	0.05	0.1316	\$1,123.18
35	2050	0.1826	3,582	\$654	370	\$68	4,586	\$837	8,538	\$1,559	0.05	0.1326	\$1,132.15
36	2051	0.1837	3,582	\$658	370	\$68	4,586	\$842	8,538	\$1,568	0.05	0.1337	\$1,141.17
37	2052	0.1847	3,582	\$662	370	\$68	4,586	\$847	8,538	\$1,577	0.05	0.1347	\$1,150.24
38	2053	0.1858	3,582	\$665	370	\$69	4,586	\$852	8,538	\$1,586	0.05	0.1358	\$1,159.36
39	2054	0.1869	3,582	\$669	370	\$69	4,586	\$857	8,538	\$1,595	0.05	0.1369	\$1,168.54
40	2055	0.1879	3,582	\$673	370	\$70	4,586	\$862	8,538	\$1,605	0.05	0.1379	\$1,177.77
41	2056	0.1890	3,582	\$677	370	\$70	4,586	\$867	8,538	\$1,614	0.05	0.1390	\$1,187.05
42	2057	0.1901	3,582	\$681	370	\$70	4,586	\$872	8,538	\$1,623	0.05	0.1401	\$1,196.39
43	2058	0.1912	3,582	\$685	370	\$71	4,586	\$877	8,538	\$1,633	0.05	0.1412	\$1,205.78
44	2059	0.1923	3,582	\$689	370	\$71	4,586	\$882	8,538	\$1,642	0.05	0.1423	\$1,215.22
45	2060	0.1934	3,582	\$693	370	\$72	4,586	\$887	8,538	\$1,652	0.05	0.1434	\$1,224.72
46	2061	0.1946	3,582	\$697	370	\$72	4,586	\$892	8,538	\$1,661	0.05	0.1446	\$1,234.28
47	2062	0.1957	3,582	\$701	370	\$72	4,586	\$897	8,538	\$1,671	0.05	0.1457	\$1,243.89
48	2063	0.1968	3,582	\$705	370	\$73	4,586	\$903	8,538	\$1,680	0.05	0.1468	\$1,253.55
49	2064	0.1980	3,582	\$709	370	\$73	4,586	\$908	8,538	\$1,690	0.05	0.1480	\$1,263.27
50	2065	0.1991	3,582	\$713	370	\$74	4,586	\$913	8,538	\$1,700	0.05	0.1491	\$1,273.05
51	2066	0.2003	3,582	\$717	370	\$74	4,586	\$918	8,538	\$1,710	0.05	0.1503	\$1,282.89
52	2067	0.2014	3,582	\$721	370	\$75	4,586	\$924	8,538	\$1,720	0.05	0.1514	\$1,292.78
53	2068	0.2026	3,582	\$726	370	\$75	4,586	\$929	8,538	\$1,730	0.05	0.1526	\$1,302.72
54	2069	0.2038	3,582	\$730	370	\$75	4,586	\$934	8,538	\$1,740	0.05	0.1538	\$1,312.73
55	2070	0.2049	3,582	\$734	370	\$76	4,586	\$940	8,538	\$1,750	0.05	0.1549	\$1,322.79
56	2071	0.2061	3,582	\$738	370	\$76	4,586	\$945	8,538	\$1,760	0.05	0.1561	\$1,332.92
57	2072	0.2073	3,582	\$743	370	\$77	4,586	\$951	8,538	\$1,770	0.05	0.1573	\$1,343.10
58	2073	0.2085	3,582	\$747	370	\$77	4,586	\$956	8,538	\$1,780	0.05	0.1585	\$1,353.34
59	2074	0.2097	3,582	\$751	370	\$78	4,586	\$962	8,538	\$1,791	0.05	0.1597	\$1,363.63
60	2075	0.2109	3,582	\$756	370	\$78	4,586	\$967	8,538	\$1,801	0.05	0.1609	\$1,373.99

Table D2-1.26: Annual Operating Costs (H.GSHP) of a 2,000 square feet detached house above grade (improved construction type) in the city of Niagara Falls (two life cycles and three life cycles for a 60 year project lifespan); base case scenario in comparison with feed in-tariff (FIT) scenario. In the FIT scenario, an incentive of \$0.05/KWh is provided on electricity bills throughout the project lifespan

Traditional HVAC Applications

Base Case Scenario																Carbon Taxes						
#	Year	Traditional														Total	Conversion of m ³ into Tons	Total Tons	Carbon Tax	Operating Costs		
		Electricity Rates \$/KWh	Natural Gas Rates \$/m ³	Heating		Heating Operating Cost \$ (Electricity)	Heating Operating Cost \$ (Gas)	Total Heating Operating Cost \$	Cooling		Hot Water m ³	Hot Water Operating Cost \$	Total KWh	Total m ³	Total Electricity Operating Cost \$ (KWh)						Total Natural Gas Operating Cost \$ (m ³)	Total
				KWh (Electricity)	m ³ (Gas)				Operating Cost \$	Operating Cost \$												
1	2016	0.1501	0.3458	1.812	1.776	\$272	\$614	1,710	\$257	1,015	\$351	3,522	2,791	529	\$965	\$1,494	5.05	5.05	\$10	\$50.52	\$1,544.32	
2	2017	0.1542	0.3588	1.812	1.776	\$279	\$637	1,710	\$264	1,015	\$356	3,522	2,791	543	\$1,002	\$1,545	5.05	5.05	\$20	\$101.03	\$1,645.59	
3	2018	0.1583	0.3718	1.812	1.776	\$287	\$660	1,710	\$271	1,015	\$361	3,522	2,791	557	\$1,038	\$1,595	5.05	5.05	\$30	\$151.55	\$1,746.87	
4	2019	0.1625	0.3776	1.812	1.776	\$295	\$671	1,710	\$278	1,015	\$365	3,522	2,791	572	\$1,054	\$1,626	5.05	5.05	\$40	\$202.07	\$1,828.36	
5	2020	0.1668	0.3841	1.812	1.776	\$302	\$682	1,710	\$285	1,015	\$369	3,522	2,791	587	\$1,072	\$1,659	5.05	5.05	\$50	\$252.59	\$1,911.99	
6	2021	0.1621	0.3883	1.812	1.776	\$294	\$690	1,710	\$277	1,015	\$365	3,522	2,791	571	\$1,084	\$1,655	5.05	5.05	\$60	\$303.10	\$1,957.90	
7	2022	0.1629	0.3929	1.812	1.776	\$295	\$698	1,710	\$279	1,015	\$365	3,522	2,791	574	\$1,097	\$1,670	5.05	5.05	\$70	\$353.62	\$2,024.02	
8	2023	0.1639	0.3967	1.812	1.776	\$297	\$705	1,710	\$280	1,015	\$366	3,522	2,791	577	\$1,107	\$1,684	5.05	5.05	\$80	\$404.14	\$2,088.51	
9	2024	0.1648	0.4005	1.812	1.776	\$299	\$711	1,710	\$282	1,015	\$367	3,522	2,791	580	\$1,118	\$1,698	5.05	5.05	\$90	\$454.65	\$2,153.00	
10	2025	0.1656	0.4040	1.812	1.776	\$300	\$717	1,710	\$283	1,015	\$368	3,522	2,791	583	\$1,128	\$1,711	5.05	5.05	\$100	\$505.17	\$2,215.91	
11	2026	0.1665	0.4070	1.812	1.776	\$302	\$723	1,710	\$285	1,015	\$369	3,522	2,791	587	\$1,136	\$1,723	5.05	5.05	\$110	\$555.69	\$2,278.27	
12	2027	0.1674	0.4097	1.812	1.776	\$303	\$728	1,710	\$286	1,015	\$370	3,522	2,791	590	\$1,144	\$1,733	5.05	5.05	\$120	\$606.21	\$2,339.43	
13	2028	0.1683	0.4124	1.812	1.776	\$305	\$732	1,710	\$288	1,015	\$371	3,522	2,791	593	\$1,151	\$1,744	5.05	5.05	\$130	\$656.72	\$2,400.34	
14	2029	0.1692	0.4151	1.812	1.776	\$307	\$737	1,710	\$289	1,015	\$372	3,522	2,791	596	\$1,158	\$1,754	5.05	5.05	\$140	\$707.24	\$2,461.50	
15	2030	0.1701	0.4170	1.812	1.776	\$308	\$741	1,710	\$291	1,015	\$373	3,522	2,791	599	\$1,164	\$1,763	5.05	5.05	\$150	\$757.76	\$2,520.65	
16	2031	0.1704	0.4189	1.812	1.776	\$309	\$744	1,710	\$291	1,015	\$373	3,522	2,791	600	\$1,169	\$1,769	5.05	5.05	\$160	\$808.27	\$2,577.39	
17	2032	0.1705	0.4204	1.812	1.776	\$309	\$747	1,710	\$292	1,015	\$373	3,522	2,791	600	\$1,173	\$1,774	5.05	5.05	\$170	\$858.79	\$2,632.69	
18	2033	0.1707	0.4223	1.812	1.776	\$309	\$750	1,710	\$292	1,015	\$373	3,522	2,791	601	\$1,179	\$1,780	5.05	5.05	\$180	\$909.31	\$2,689.43	
19	2034	0.1710	0.4246	1.812	1.776	\$310	\$754	1,710	\$292	1,015	\$374	3,522	2,791	602	\$1,185	\$1,788	5.05	5.05	\$190	\$959.82	\$2,747.37	
20	2035	0.1713	0.4265	1.812	1.776	\$310	\$758	1,710	\$293	1,015	\$374	3,522	2,791	603	\$1,190	\$1,794	5.05	5.05	\$200	\$1,010.34	\$2,804.11	
21	2036	0.1714	0.4288	1.812	1.776	\$311	\$762	1,710	\$293	1,015	\$374	3,522	2,791	604	\$1,197	\$1,801	5.05	5.05	\$210	\$1,060.86	\$2,861.54	
22	2037	0.1717	0.4311	1.812	1.776	\$311	\$766	1,710	\$294	1,015	\$374	3,522	2,791	605	\$1,203	\$1,808	5.05	5.05	\$220	\$1,111.38	\$2,919.35	
23	2038	0.1720	0.4331	1.812	1.776	\$312	\$769	1,710	\$294	1,015	\$375	3,522	2,791	606	\$1,209	\$1,814	5.05	5.05	\$230	\$1,161.89	\$2,976.22	
24	2039	0.1722	0.4353	1.812	1.776	\$312	\$773	1,710	\$295	1,015	\$375	3,522	2,791	607	\$1,215	\$1,822	5.05	5.05	\$240	\$1,212.41	\$3,034.04	
25	2040	0.1724	0.4376	1.812	1.776	\$312	\$777	1,710	\$295	1,015	\$375	3,522	2,791	607	\$1,221	\$1,829	5.05	5.05	\$250	\$1,262.93	\$3,091.47	
26	2041	0.1734	0.4420	1.812	1.776	\$314	\$785	1,710	\$296	1,015	\$376	3,522	2,791	611	\$1,234	\$1,844	5.05	5.05	\$260	\$1,313.44	\$3,157.54	
27	2042	0.1744	0.4463	1.812	1.776	\$316	\$793	1,710	\$298	1,015	\$377	3,522	2,791	614	\$1,246	\$1,860	5.05	5.05	\$270	\$1,363.96	\$3,223.75	
28	2043	0.1754	0.4507	1.812	1.776	\$318	\$800	1,710	\$300	1,015	\$378	3,522	2,791	618	\$1,258	\$1,876	5.05	5.05	\$280	\$1,414.48	\$3,290.10	
29	2044	0.1764	0.4552	1.812	1.776	\$320	\$808	1,710	\$302	1,015	\$379	3,522	2,791	621	\$1,270	\$1,892	5.05	5.05	\$290	\$1,465.00	\$3,356.59	
30	2045	0.1774	0.4596	1.812	1.776	\$321	\$816	1,710	\$303	1,015	\$380	3,522	2,791	625	\$1,283	\$1,908	5.05	5.05	\$300	\$1,515.51	\$3,423.23	
31	2046	0.1784	0.4642	1.812	1.776	\$323	\$824	1,710	\$305	1,015	\$381	3,522	2,791	628	\$1,296	\$1,924	5.05	5.05	\$310	\$1,566.03	\$3,490.01	
32	2047	0.1795	0.4688	1.812	1.776	\$325	\$833	1,710	\$307	1,015	\$382	3,522	2,791	632	\$1,308	\$1,940	5.05	5.05	\$320	\$1,616.55	\$3,556.93	
33	2048	0.1805	0.4734	1.812	1.776	\$327	\$841	1,710	\$309	1,015	\$383	3,522	2,791	636	\$1,321	\$1,957	5.05	5.05	\$330	\$1,667.06	\$3,624.00	
34	2049	0.1816	0.4780	1.812	1.776	\$329	\$849	1,710	\$310	1,015	\$384	3,522	2,791	639	\$1,334	\$1,974	5.05	5.05	\$340	\$1,717.58	\$3,691.23	
35	2050	0.1826	0.4828	1.812	1.776	\$331	\$857	1,710	\$312	1,015	\$385	3,522	2,791	643	\$1,347	\$1,990	5.05	5.05	\$350	\$1,768.10	\$3,758.59	
36	2051	0.1837	0.4875	1.812	1.776	\$333	\$866	1,710	\$314	1,015	\$386	3,522	2,791	647	\$1,361	\$2,007	5.05	5.05	\$360	\$1,818.62	\$3,826.11	
37	2052	0.1847	0.4923	1.812	1.776	\$335	\$874	1,710	\$316	1,015	\$387	3,522	2,791	651	\$1,374	\$2,025	5.05	5.05	\$370	\$1,869.13	\$3,893.79	
38	2053	0.1858	0.4972	1.812	1.776	\$337	\$883	1,710	\$318	1,015	\$389	3,522	2,791	654	\$1,388	\$2,042	5.05	5.05	\$380	\$1,919.65	\$3,961.62	
39	2054	0.1869	0.5021	1.812	1.776	\$339	\$892	1,710	\$320	1,015	\$390	3,522	2,791	658	\$1,401	\$2,059	5.05	5.05	\$390	\$1,970.17	\$4,029.60	
40	2055	0.1879	0.5070	1.812	1.776	\$341	\$900	1,710	\$321	1,015	\$391	3,522	2,791	662	\$1,415	\$2,077	5.05	5.05	\$400	\$2,020.68	\$4,097.74	
41	2056	0.1890	0.5120	1.812	1.776	\$343	\$909	1,710	\$323	1,015	\$392	3,522	2,791	666	\$1,429	\$2,095	5.05	5.05	\$410	\$2,071.20	\$4,166.04	
42	2057	0.1901	0.5171	1.812	1.776	\$345	\$918	1,710	\$325	1,015	\$393	3,522	2,791	670	\$1,443	\$2,113	5.05	5.05	\$420	\$2,121.72	\$4,234.49	
43	2058	0.1912	0.5222	1.812	1.776	\$346	\$927	1,710	\$327	1,015	\$394	3,522	2,791	673	\$1,457	\$2,131	5.05	5.05	\$430	\$2,172.24	\$4,303.11	
44	2059	0.1923	0.5273	1.812	1.776	\$349	\$937	1,710	\$329	1,015	\$395	3,522	2,791	677	\$1,472	\$2,149	5.05	5.05	\$440	\$2,222.75	\$4,371.89	
45	2060	0.1934	0.5325	1.812	1.776	\$351	\$946	1,710	\$331	1,015	\$396	3,522	2,791	681	\$1,486	\$2,168	5.05	5.05	\$450	\$2,273.27	\$4,440.84	
46	2061	0.1946	0.5378	1.812	1.776	\$353	\$955	1,710	\$333	1,015	\$397	3,522	2,791	685	\$1,501	\$2,186	5.05	5.05	\$460	\$2,323.79	\$4,509.95	
47	2062	0.1957	0.5431	1.812	1.776	\$355	\$964	1,710	\$335	1,015	\$399	3,522	2,791	689	\$1,516	\$2,205	5.05	5.05	\$470	\$2,374.30	\$4,579.23	
48	2063	0.1968	0.5484	1.812	1.776	\$357	\$974	1,710	\$337	1,015	\$200	3,522	2,791	693	\$1,531	\$2,224	5.05	5.05	\$480	\$2,424.82	\$4,648.68	
49	2064	0.1980	0.5538	1.812	1.776	\$359	\$984	1,710	\$339	1,015	\$201	3,522	2,791	697	\$1,546	\$2,243	5.05	5.05	\$490	\$2,475.34	\$4,718.29	
50	2065	0.1991	0.5593	1.812	1.776	\$361	\$993	1,710	\$340	1,015	\$202	3,522	2,791	701	\$1,561	\$2,262	5.05	5.05	\$500	\$2,525.86	\$4,788.08	
51	2066	0.2003	0.5648	1.812	1.776	\$363	\$1,003	1,710	\$342	1,015	\$203	3,522	2,791	705	\$1,576	\$2,282	5.05	5.05	\$510	\$2,576.37	\$4,858.05	
52	2067	0.2014	0.5704	1.812	1.776	\$365	\$1,013	1,710	\$344	1,015	\$204	3,522	2,791	709	\$1,592	\$2,301	5.05	5.05	\$520	\$2,626.89	\$4,928.19	
53	2068	0.2026	0.5760	1.812	1.776	\$367	\$1,023	1,710	\$346	1,015	\$206	3,522	2,791	713	\$1,608	\$2,321	5.05	5.05	\$530	\$2,677.41	\$4,998.50	
54	2069	0.2038	0.5817	1.812	1.776	\$369	\$1,033	1,710	\$348	1,015	\$207	3,522	2,791	718	\$1,623	\$2,341	5.05	5.05	\$540	\$2,727.92	\$5,069.00	
55	2070	0.2049	0.5874	1.812	1.776	\$371	\$1,043	1,710	\$350	1,015	\$208	3,522	2,791	722	\$1,639	\$2,361	5.05	5.05	\$550	\$2,778.44	\$5,139.67	
56	2071	0.2061	0.5932	1.812	1.776	\$373	\$1,054	1,710														

10. Sarnia (South) – Annual Operating Costs

Vertical Ground Source Heat Pump (V.GSHP)

Base Case Scenario											Feed In Tariff (FIT)			
#	Year	Electricity Rates		V.GSHP		V.GSHP		V.GSHP		V.GSHP		FIT		
		\$/KWh	KWh	Heating Operating Cost \$	Cooling KWh	Cooling Operating Cost \$	Hot Water KWh	Hot Water Operating Cost \$	Total KWh	Total Operating Cost \$	Incentives (\$/KWh)	FIT \$/KWh	Operating Cost	
1	2016	0.1501	3,777	\$567	362	\$54	4,118	\$618	8,257	\$1,239	0.05	0.1001	\$826.38	
2	2017	0.1542	3,777	\$582	362	\$56	4,118	\$635	8,257	\$1,273	0.05	0.1042	\$860.27	
3	2018	0.1583	3,777	\$598	362	\$57	4,118	\$652	8,257	\$1,307	0.05	0.1083	\$894.16	
4	2019	0.1625	3,777	\$614	362	\$59	4,118	\$669	8,257	\$1,342	0.05	0.1125	\$929.23	
5	2020	0.1668	3,777	\$630	362	\$60	4,118	\$687	8,257	\$1,377	0.05	0.1168	\$964.31	
6	2021	0.1621	3,777	\$612	362	\$59	4,118	\$668	8,257	\$1,339	0.05	0.1121	\$925.96	
7	2022	0.1629	3,777	\$615	362	\$59	4,118	\$671	8,257	\$1,345	0.05	0.1129	\$932.50	
8	2023	0.1639	3,777	\$619	362	\$59	4,118	\$675	8,257	\$1,353	0.05	0.1139	\$940.23	
9	2024	0.1648	3,777	\$622	362	\$60	4,118	\$679	8,257	\$1,361	0.05	0.1148	\$947.96	
10	2025	0.1656	3,777	\$625	362	\$60	4,118	\$682	8,257	\$1,367	0.05	0.1156	\$954.50	
11	2026	0.1665	3,777	\$629	362	\$60	4,118	\$686	8,257	\$1,375	0.05	0.1165	\$962.23	
12	2027	0.1674	3,777	\$632	362	\$61	4,118	\$689	8,257	\$1,383	0.05	0.1174	\$969.66	
13	2028	0.1683	3,777	\$636	362	\$61	4,118	\$693	8,257	\$1,389	0.05	0.1183	\$976.49	
14	2029	0.1692	3,777	\$639	362	\$61	4,118	\$697	8,257	\$1,397	0.05	0.1192	\$983.93	
15	2030	0.1701	3,777	\$642	362	\$62	4,118	\$700	8,257	\$1,405	0.05	0.1201	\$991.65	
16	2031	0.1704	3,777	\$643	362	\$62	4,118	\$702	8,257	\$1,407	0.05	0.1204	\$993.74	
17	2032	0.1705	3,777	\$644	362	\$62	4,118	\$702	8,257	\$1,408	0.05	0.1205	\$994.92	
18	2033	0.1707	3,777	\$645	362	\$62	4,118	\$703	8,257	\$1,410	0.05	0.1207	\$997.00	
19	2034	0.1710	3,777	\$646	362	\$62	4,118	\$704	8,257	\$1,412	0.05	0.1210	\$999.38	
20	2035	0.1713	3,777	\$647	362	\$62	4,118	\$705	8,257	\$1,414	0.05	0.1213	\$1,001.46	
21	2036	0.1714	3,777	\$647	362	\$62	4,118	\$706	8,257	\$1,416	0.05	0.1214	\$1,002.65	
22	2037	0.1717	3,777	\$648	362	\$62	4,118	\$707	8,257	\$1,418	0.05	0.1217	\$1,004.73	
23	2038	0.1720	3,777	\$650	362	\$62	4,118	\$708	8,257	\$1,420	0.05	0.1220	\$1,007.11	
24	2039	0.1722	3,777	\$650	362	\$62	4,118	\$709	8,257	\$1,422	0.05	0.1222	\$1,009.19	
25	2040	0.1724	3,777	\$651	362	\$62	4,118	\$710	8,257	\$1,423	0.05	0.1224	\$1,010.38	
26	2041	0.1734	3,777	\$655	362	\$63	4,118	\$714	8,257	\$1,431	0.05	0.1234	\$1,018.61	
27	2042	0.1744	3,777	\$659	362	\$63	4,118	\$718	8,257	\$1,440	0.05	0.1244	\$1,026.90	
28	2043	0.1754	3,777	\$662	362	\$63	4,118	\$722	8,257	\$1,448	0.05	0.1254	\$1,035.22	
29	2044	0.1764	3,777	\$666	362	\$64	4,118	\$726	8,257	\$1,456	0.05	0.1264	\$1,043.60	
30	2045	0.1774	3,777	\$670	362	\$64	4,118	\$731	8,257	\$1,465	0.05	0.1274	\$1,052.03	
31	2046	0.1784	3,777	\$674	362	\$65	4,118	\$735	8,257	\$1,473	0.05	0.1284	\$1,060.50	
32	2047	0.1795	3,777	\$678	362	\$65	4,118	\$739	8,257	\$1,482	0.05	0.1295	\$1,069.02	
33	2048	0.1805	3,777	\$682	362	\$65	4,118	\$743	8,257	\$1,490	0.05	0.1305	\$1,077.60	
34	2049	0.1816	3,777	\$686	362	\$66	4,118	\$748	8,257	\$1,499	0.05	0.1316	\$1,086.22	
35	2050	0.1826	3,777	\$690	362	\$66	4,118	\$752	8,257	\$1,508	0.05	0.1326	\$1,094.89	
36	2051	0.1837	3,777	\$694	362	\$66	4,118	\$756	8,257	\$1,516	0.05	0.1337	\$1,103.61	
37	2052	0.1847	3,777	\$698	362	\$67	4,118	\$761	8,257	\$1,525	0.05	0.1347	\$1,112.38	
38	2053	0.1858	3,777	\$702	362	\$67	4,118	\$765	8,257	\$1,534	0.05	0.1358	\$1,121.21	
39	2054	0.1869	3,777	\$706	362	\$68	4,118	\$770	8,257	\$1,543	0.05	0.1369	\$1,130.08	
40	2055	0.1879	3,777	\$710	362	\$68	4,118	\$774	8,257	\$1,552	0.05	0.1379	\$1,139.01	
41	2056	0.1890	3,777	\$714	362	\$68	4,118	\$778	8,257	\$1,561	0.05	0.1390	\$1,147.98	
42	2057	0.1901	3,777	\$718	362	\$69	4,118	\$783	8,257	\$1,570	0.05	0.1401	\$1,157.01	
43	2058	0.1912	3,777	\$722	362	\$69	4,118	\$787	8,257	\$1,579	0.05	0.1412	\$1,166.10	
44	2059	0.1923	3,777	\$726	362	\$70	4,118	\$792	8,257	\$1,588	0.05	0.1423	\$1,175.23	
45	2060	0.1934	3,777	\$731	362	\$70	4,118	\$797	8,257	\$1,597	0.05	0.1434	\$1,184.42	
46	2061	0.1946	3,777	\$735	362	\$70	4,118	\$801	8,257	\$1,607	0.05	0.1446	\$1,193.66	
47	2062	0.1957	3,777	\$739	362	\$71	4,118	\$806	8,257	\$1,616	0.05	0.1457	\$1,202.95	
48	2063	0.1968	3,777	\$743	362	\$71	4,118	\$811	8,257	\$1,625	0.05	0.1468	\$1,212.30	
49	2064	0.1980	3,777	\$748	362	\$72	4,118	\$815	8,257	\$1,635	0.05	0.1480	\$1,221.70	
50	2065	0.1991	3,777	\$752	362	\$72	4,118	\$820	8,257	\$1,644	0.05	0.1491	\$1,231.15	
51	2066	0.2003	3,777	\$756	362	\$72	4,118	\$825	8,257	\$1,654	0.05	0.1503	\$1,240.66	
52	2067	0.2014	3,777	\$761	362	\$73	4,118	\$829	8,257	\$1,663	0.05	0.1514	\$1,250.23	
53	2068	0.2026	3,777	\$765	362	\$73	4,118	\$834	8,257	\$1,673	0.05	0.1526	\$1,259.85	
54	2069	0.2038	3,777	\$770	362	\$74	4,118	\$839	8,257	\$1,682	0.05	0.1538	\$1,269.53	
55	2070	0.2049	3,777	\$774	362	\$74	4,118	\$844	8,257	\$1,692	0.05	0.1549	\$1,279.26	
56	2071	0.2061	3,777	\$778	362	\$75	4,118	\$849	8,257	\$1,702	0.05	0.1561	\$1,289.05	
57	2072	0.2073	3,777	\$783	362	\$75	4,118	\$854	8,257	\$1,712	0.05	0.1573	\$1,298.89	
58	2073	0.2085	3,777	\$788	362	\$75	4,118	\$859	8,257	\$1,722	0.05	0.1585	\$1,308.79	
59	2074	0.2097	3,777	\$792	362	\$76	4,118	\$864	8,257	\$1,732	0.05	0.1597	\$1,318.75	
60	2075	0.2109	3,777	\$797	362	\$76	4,118	\$869	8,257	\$1,742	0.05	0.1609	\$1,328.77	

Table D2-1.28: Annual Operating Costs (V.GSHP) of a 2,000 square feet detached house above grade (improved construction type) in the city of Sarnia (two life cycles and three life cycles for a 60 year project lifespan); base case scenario in comparison with feed in-tariff (FIT) scenario. In the FIT scenario, an incentive of \$0.05/KWh is provided on electricity bills throughout the project lifespan

Horizontal Ground Source Heat Pump (H.GSHP)

Base Case Scenario											Feed in Tariff (FIT)		
#	Year	H.GSHP									FIT		
		Electricity Rates \$/KWh	Heating KWh	Heating Operating Cost \$	Cooling KWh	Cooling Operating Cost \$	Hot Water KWh	Hot Water Operating Cost \$	Total KWh	Total Operating Cost \$	Incentives (\$/KWh)	S/KWh	Operating Cost
1	2016	0.1501	3,831	\$575	366	\$55	4,119	\$618	8,316	\$1,248	0.05	0.1001	\$832.29
2	2017	0.1542	3,831	\$591	366	\$56	4,119	\$635	8,316	\$1,282	0.05	0.1042	\$866.42
3	2018	0.1583	3,831	\$606	366	\$58	4,119	\$652	8,316	\$1,316	0.05	0.1083	\$900.55
4	2019	0.1625	3,831	\$623	366	\$59	4,119	\$669	8,316	\$1,352	0.05	0.1125	\$935.87
5	2020	0.1668	3,831	\$639	366	\$61	4,119	\$687	8,316	\$1,387	0.05	0.1168	\$971.20
6	2021	0.1621	3,831	\$621	366	\$59	4,119	\$668	8,316	\$1,348	0.05	0.1121	\$932.58
7	2022	0.1629	3,831	\$624	366	\$60	4,119	\$671	8,316	\$1,355	0.05	0.1129	\$939.16
8	2023	0.1639	3,831	\$628	366	\$60	4,119	\$675	8,316	\$1,363	0.05	0.1139	\$946.95
9	2024	0.1648	3,831	\$631	366	\$60	4,119	\$679	8,316	\$1,371	0.05	0.1148	\$954.73
10	2025	0.1656	3,831	\$634	366	\$61	4,119	\$682	8,316	\$1,377	0.05	0.1156	\$961.32
11	2026	0.1665	3,831	\$638	366	\$61	4,119	\$686	8,316	\$1,385	0.05	0.1165	\$969.10
12	2027	0.1674	3,831	\$641	366	\$61	4,119	\$690	8,316	\$1,392	0.05	0.1174	\$976.59
13	2028	0.1683	3,831	\$645	366	\$62	4,119	\$693	8,316	\$1,399	0.05	0.1183	\$983.47
14	2029	0.1692	3,831	\$648	366	\$62	4,119	\$697	8,316	\$1,407	0.05	0.1192	\$990.96
15	2030	0.1701	3,831	\$652	366	\$62	4,119	\$701	8,316	\$1,415	0.05	0.1201	\$998.74
16	2031	0.1704	3,831	\$653	366	\$62	4,119	\$702	8,316	\$1,417	0.05	0.1204	\$1,000.84
17	2032	0.1705	3,831	\$653	366	\$62	4,119	\$702	8,316	\$1,418	0.05	0.1205	\$1,002.03
18	2033	0.1707	3,831	\$654	366	\$62	4,119	\$703	8,316	\$1,420	0.05	0.1207	\$1,004.13
19	2034	0.1710	3,831	\$655	366	\$63	4,119	\$704	8,316	\$1,422	0.05	0.1210	\$1,006.52
20	2035	0.1713	3,831	\$656	366	\$63	4,119	\$706	8,316	\$1,424	0.05	0.1213	\$1,008.62
21	2036	0.1714	3,831	\$657	366	\$63	4,119	\$706	8,316	\$1,426	0.05	0.1214	\$1,009.82
22	2037	0.1717	3,831	\$658	366	\$63	4,119	\$707	8,316	\$1,428	0.05	0.1217	\$1,011.91
23	2038	0.1720	3,831	\$659	366	\$63	4,119	\$708	8,316	\$1,430	0.05	0.1220	\$1,014.31
24	2039	0.1722	3,831	\$660	366	\$63	4,119	\$709	8,316	\$1,432	0.05	0.1222	\$1,016.40
25	2040	0.1724	3,831	\$660	366	\$63	4,119	\$710	8,316	\$1,433	0.05	0.1224	\$1,017.60
26	2041	0.1734	3,831	\$664	366	\$63	4,119	\$714	8,316	\$1,442	0.05	0.1234	\$1,025.89
27	2042	0.1744	3,831	\$668	366	\$64	4,119	\$718	8,316	\$1,450	0.05	0.1244	\$1,034.23
28	2043	0.1754	3,831	\$672	366	\$64	4,119	\$722	8,316	\$1,458	0.05	0.1254	\$1,042.62
29	2044	0.1764	3,831	\$676	366	\$65	4,119	\$727	8,316	\$1,467	0.05	0.1264	\$1,051.06
30	2045	0.1774	3,831	\$680	366	\$65	4,119	\$731	8,316	\$1,475	0.05	0.1274	\$1,059.54
31	2046	0.1784	3,831	\$684	366	\$65	4,119	\$735	8,316	\$1,484	0.05	0.1284	\$1,068.08
32	2047	0.1795	3,831	\$688	366	\$66	4,119	\$739	8,316	\$1,492	0.05	0.1295	\$1,076.66
33	2048	0.1805	3,831	\$692	366	\$66	4,119	\$744	8,316	\$1,501	0.05	0.1305	\$1,085.30
34	2049	0.1816	3,831	\$696	366	\$66	4,119	\$748	8,316	\$1,510	0.05	0.1316	\$1,093.98
35	2050	0.1826	3,831	\$700	366	\$67	4,119	\$752	8,316	\$1,519	0.05	0.1326	\$1,102.71
36	2051	0.1837	3,831	\$704	366	\$67	4,119	\$756	8,316	\$1,527	0.05	0.1337	\$1,111.50
37	2052	0.1847	3,831	\$708	366	\$68	4,119	\$761	8,316	\$1,536	0.05	0.1347	\$1,120.33
38	2053	0.1858	3,831	\$712	366	\$68	4,119	\$765	8,316	\$1,545	0.05	0.1358	\$1,129.22
39	2054	0.1869	3,831	\$716	366	\$68	4,119	\$770	8,316	\$1,554	0.05	0.1369	\$1,138.16
40	2055	0.1879	3,831	\$720	366	\$69	4,119	\$774	8,316	\$1,563	0.05	0.1379	\$1,147.15
41	2056	0.1890	3,831	\$724	366	\$69	4,119	\$779	8,316	\$1,572	0.05	0.1390	\$1,156.19
42	2057	0.1901	3,831	\$728	366	\$70	4,119	\$783	8,316	\$1,581	0.05	0.1401	\$1,165.28
43	2058	0.1912	3,831	\$733	366	\$70	4,119	\$788	8,316	\$1,590	0.05	0.1412	\$1,174.43
44	2059	0.1923	3,831	\$737	366	\$70	4,119	\$792	8,316	\$1,599	0.05	0.1423	\$1,183.63
45	2060	0.1934	3,831	\$741	366	\$71	4,119	\$797	8,316	\$1,609	0.05	0.1434	\$1,192.88
46	2061	0.1946	3,831	\$745	366	\$71	4,119	\$801	8,316	\$1,618	0.05	0.1446	\$1,202.19
47	2062	0.1957	3,831	\$750	366	\$72	4,119	\$806	8,316	\$1,627	0.05	0.1457	\$1,211.55
48	2063	0.1968	3,831	\$754	366	\$72	4,119	\$811	8,316	\$1,637	0.05	0.1468	\$1,220.96
49	2064	0.1980	3,831	\$758	366	\$72	4,119	\$815	8,316	\$1,646	0.05	0.1480	\$1,230.43
50	2065	0.1991	3,831	\$763	366	\$73	4,119	\$820	8,316	\$1,656	0.05	0.1491	\$1,239.95
51	2066	0.2003	3,831	\$767	366	\$73	4,119	\$825	8,316	\$1,665	0.05	0.1503	\$1,249.53
52	2067	0.2014	3,831	\$772	366	\$74	4,119	\$830	8,316	\$1,675	0.05	0.1514	\$1,259.16
53	2068	0.2026	3,831	\$776	366	\$74	4,119	\$834	8,316	\$1,685	0.05	0.1526	\$1,268.85
54	2069	0.2038	3,831	\$781	366	\$75	4,119	\$839	8,316	\$1,694	0.05	0.1538	\$1,278.60
55	2070	0.2049	3,831	\$785	366	\$75	4,119	\$844	8,316	\$1,704	0.05	0.1549	\$1,288.40
56	2071	0.2061	3,831	\$790	366	\$75	4,119	\$849	8,316	\$1,714	0.05	0.1561	\$1,298.26
57	2072	0.2073	3,831	\$794	366	\$76	4,119	\$854	8,316	\$1,724	0.05	0.1573	\$1,308.17
58	2073	0.2085	3,831	\$799	366	\$76	4,119	\$859	8,316	\$1,734	0.05	0.1585	\$1,318.15
59	2074	0.2097	3,831	\$803	366	\$77	4,119	\$864	8,316	\$1,744	0.05	0.1597	\$1,328.18
60	2075	0.2109	3,831	\$808	366	\$77	4,119	\$869	8,316	\$1,754	0.05	0.1609	\$1,338.27

Table D2-1.29: Annual Operating Costs (H.GSHP) of a 2,000 square feet detached house above grade (improved construction type) in the city of Sarnia (two life cycles and three life cycles for a 60 year project lifespan); base case scenario in comparison with feed-in-tariff (FIT) scenario. In the FIT scenario, an incentive of \$0.05/KWh is provided on electricity bills throughout the project lifespan

Traditional HVAC Applications

Base Case Scenario															Carbon Taxes							
#	Year	Traditional												Carbon Taxes								
		Electricity Rates \$/KWh	Natural Gas Rates \$/m ³	Heating		Heating Operating Cost \$ (Electricity)	Heating Operating Cost \$ (Gas)	Total Heating Operating Cost \$	Cooling		Hot Water m ³	Hot Water Operating Cost \$	Total KWh	Total m ³	Total Electricity Operating Cost \$ (KWh)	Total Natural Gas Operating Cost \$ (m ³)	Total	Conversion of m ³ into Tons	Total Tons	Carbon Tax	Operating Costs	
				KWh (Electricity)	m ³ (Gas)				Cooling	Cooling Operating Cost												
1	2016	0.1501	0.3458	1,486	1,868	\$223	\$646	\$869	1,682	\$252	950	\$329	3,168	2,818	475	\$975	\$1,450	5.10	5.10	\$10	\$51.01	\$1,501.02
2	2017	0.1542	0.3588	1,486	1,868	\$229	\$670	\$899	1,682	\$259	950	\$346	3,168	2,818	488	\$1,011	\$1,500	5.10	5.10	\$20	\$102.01	\$1,601.68
3	2018	0.1583	0.3718	1,486	1,868	\$235	\$695	\$930	1,682	\$266	950	\$360	3,168	2,818	501	\$1,048	\$1,549	5.10	5.10	\$30	\$153.02	\$1,702.34
4	2019	0.1625	0.3776	1,486	1,868	\$242	\$705	\$947	1,682	\$273	950	\$354	3,168	2,818	515	\$1,064	\$1,579	5.10	5.10	\$40	\$204.02	\$1,782.97
5	2020	0.1668	0.3841	1,486	1,868	\$248	\$717	\$965	1,682	\$281	950	\$358	3,168	2,818	528	\$1,082	\$1,611	5.10	5.10	\$50	\$255.03	\$1,865.76
6	2021	0.1621	0.3883	1,486	1,868	\$241	\$725	\$966	1,682	\$273	950	\$354	3,168	2,818	514	\$1,094	\$1,608	5.10	5.10	\$60	\$306.03	\$1,913.91
7	2022	0.1629	0.3929	1,486	1,868	\$242	\$734	\$976	1,682	\$274	950	\$355	3,168	2,818	516	\$1,107	\$1,623	5.10	5.10	\$70	\$357.04	\$1,980.37
8	2023	0.1639	0.3967	1,486	1,868	\$244	\$741	\$985	1,682	\$276	950	\$356	3,168	2,818	519	\$1,118	\$1,637	5.10	5.10	\$80	\$408.05	\$2,045.12
9	2024	0.1648	0.4005	1,486	1,868	\$245	\$748	\$993	1,682	\$277	950	\$357	3,168	2,818	522	\$1,129	\$1,651	5.10	5.10	\$90	\$459.05	\$2,109.87
10	2025	0.1656	0.4040	1,486	1,868	\$246	\$755	\$1,001	1,682	\$279	950	\$357	3,168	2,818	525	\$1,138	\$1,663	5.10	5.10	\$100	\$510.06	\$2,173.09
11	2026	0.1665	0.4070	1,486	1,868	\$247	\$760	\$1,008	1,682	\$280	950	\$358	3,168	2,818	528	\$1,147	\$1,675	5.10	5.10	\$110	\$561.06	\$2,235.68
12	2027	0.1674	0.4097	1,486	1,868	\$249	\$765	\$1,014	1,682	\$282	950	\$359	3,168	2,818	530	\$1,155	\$1,685	5.10	5.10	\$120	\$612.07	\$2,297.08
13	2028	0.1683	0.4124	1,486	1,868	\$250	\$770	\$1,020	1,682	\$283	950	\$360	3,168	2,818	533	\$1,162	\$1,695	5.10	5.10	\$130	\$663.08	\$2,358.26
14	2029	0.1692	0.4151	1,486	1,868	\$251	\$775	\$1,027	1,682	\$285	950	\$361	3,168	2,818	536	\$1,170	\$1,706	5.10	5.10	\$140	\$714.08	\$2,419.66
15	2030	0.1701	0.4170	1,486	1,868	\$253	\$779	\$1,032	1,682	\$286	950	\$362	3,168	2,818	539	\$1,175	\$1,714	5.10	5.10	\$150	\$765.09	\$2,479.02
16	2031	0.1704	0.4189	1,486	1,868	\$253	\$783	\$1,036	1,682	\$287	950	\$362	3,168	2,818	540	\$1,180	\$1,720	5.10	5.10	\$160	\$816.09	\$2,536.22
17	2032	0.1705	0.4204	1,486	1,868	\$253	\$785	\$1,039	1,682	\$287	950	\$362	3,168	2,818	540	\$1,185	\$1,725	5.10	5.10	\$170	\$867.10	\$2,591.99
18	2033	0.1707	0.4223	1,486	1,868	\$254	\$789	\$1,043	1,682	\$287	950	\$362	3,168	2,818	541	\$1,190	\$1,731	5.10	5.10	\$180	\$918.10	\$2,649.19
19	2034	0.1710	0.4246	1,486	1,868	\$254	\$793	\$1,047	1,682	\$288	950	\$362	3,168	2,818	542	\$1,197	\$1,738	5.10	5.10	\$190	\$969.11	\$2,707.57
20	2035	0.1713	0.4265	1,486	1,868	\$255	\$797	\$1,051	1,682	\$288	950	\$363	3,168	2,818	543	\$1,202	\$1,745	5.10	5.10	\$200	\$1,020.12	\$2,764.77
21	2036	0.1714	0.4288	1,486	1,868	\$255	\$801	\$1,056	1,682	\$288	950	\$363	3,168	2,818	543	\$1,208	\$1,752	5.10	5.10	\$210	\$1,071.12	\$2,822.70
22	2037	0.1717	0.4311	1,486	1,868	\$255	\$805	\$1,060	1,682	\$289	950	\$363	3,168	2,818	544	\$1,215	\$1,759	5.10	5.10	\$220	\$1,122.13	\$2,880.97
23	2038	0.1720	0.4331	1,486	1,868	\$256	\$809	\$1,064	1,682	\$289	950	\$363	3,168	2,818	545	\$1,220	\$1,765	5.10	5.10	\$230	\$1,173.13	\$2,938.28
24	2039	0.1722	0.4353	1,486	1,868	\$256	\$813	\$1,069	1,682	\$290	950	\$364	3,168	2,818	546	\$1,227	\$1,772	5.10	5.10	\$240	\$1,224.14	\$2,996.35
25	2040	0.1724	0.4376	1,486	1,868	\$256	\$818	\$1,074	1,682	\$290	950	\$364	3,168	2,818	546	\$1,233	\$1,779	5.10	5.10	\$250	\$1,275.15	\$3,054.48
26	2041	0.1734	0.4420	1,486	1,868	\$258	\$826	\$1,083	1,682	\$292	950	\$365	3,168	2,818	549	\$1,245	\$1,795	5.10	5.10	\$260	\$1,326.15	\$3,120.81
27	2042	0.1744	0.4463	1,486	1,868	\$259	\$834	\$1,093	1,682	\$293	950	\$366	3,168	2,818	552	\$1,258	\$1,810	5.10	5.10	\$270	\$1,377.16	\$3,187.27
28	2043	0.1754	0.4507	1,486	1,868	\$261	\$842	\$1,103	1,682	\$295	950	\$367	3,168	2,818	556	\$1,270	\$1,826	5.10	5.10	\$280	\$1,428.16	\$3,253.87
29	2044	0.1764	0.4552	1,486	1,868	\$262	\$850	\$1,112	1,682	\$297	950	\$368	3,168	2,818	559	\$1,283	\$1,841	5.10	5.10	\$290	\$1,479.17	\$3,320.61
30	2045	0.1774	0.4596	1,486	1,868	\$264	\$859	\$1,122	1,682	\$298	950	\$369	3,168	2,818	562	\$1,295	\$1,857	5.10	5.10	\$300	\$1,530.17	\$3,387.49
31	2046	0.1784	0.4642	1,486	1,868	\$265	\$867	\$1,132	1,682	\$300	950	\$370	3,168	2,818	565	\$1,308	\$1,873	5.10	5.10	\$310	\$1,581.18	\$3,454.52
32	2047	0.1795	0.4688	1,486	1,868	\$267	\$876	\$1,142	1,682	\$302	950	\$370	3,168	2,818	569	\$1,321	\$1,890	5.10	5.10	\$320	\$1,632.19	\$3,521.69
33	2048	0.1805	0.4734	1,486	1,868	\$268	\$884	\$1,152	1,682	\$304	950	\$371	3,168	2,818	572	\$1,334	\$1,906	5.10	5.10	\$330	\$1,683.19	\$3,589.01
34	2049	0.1816	0.4780	1,486	1,868	\$270	\$893	\$1,163	1,682	\$305	950	\$372	3,168	2,818	575	\$1,347	\$1,922	5.10	5.10	\$340	\$1,734.20	\$3,656.48
35	2050	0.1826	0.4828	1,486	1,868	\$271	\$902	\$1,173	1,682	\$307	950	\$373	3,168	2,818	578	\$1,360	\$1,939	5.10	5.10	\$350	\$1,785.20	\$3,724.09
36	2051	0.1837	0.4875	1,486	1,868	\$273	\$911	\$1,184	1,682	\$309	950	\$374	3,168	2,818	582	\$1,374	\$1,956	5.10	5.10	\$360	\$1,836.21	\$3,791.86
37	2052	0.1847	0.4923	1,486	1,868	\$274	\$920	\$1,194	1,682	\$311	950	\$375	3,168	2,818	585	\$1,387	\$1,973	5.10	5.10	\$370	\$1,887.21	\$3,859.77
38	2053	0.1858	0.4972	1,486	1,868	\$276	\$929	\$1,205	1,682	\$312	950	\$376	3,168	2,818	589	\$1,401	\$1,990	5.10	5.10	\$380	\$1,938.22	\$3,927.84
39	2054	0.1869	0.5021	1,486	1,868	\$278	\$938	\$1,216	1,682	\$314	950	\$378	3,168	2,818	592	\$1,415	\$2,007	5.10	5.10	\$390	\$1,989.23	\$3,996.06
40	2055	0.1879	0.5070	1,486	1,868	\$279	\$947	\$1,226	1,682	\$316	950	\$379	3,168	2,818	595	\$1,429	\$2,024	5.10	5.10	\$400	\$2,040.23	\$4,064.44
41	2056	0.1890	0.5120	1,486	1,868	\$281	\$956	\$1,237	1,682	\$318	950	\$380	3,168	2,818	599	\$1,443	\$2,042	5.10	5.10	\$410	\$2,091.24	\$4,132.98
42	2057	0.1901	0.5171	1,486	1,868	\$283	\$966	\$1,248	1,682	\$320	950	\$381	3,168	2,818	602	\$1,457	\$2,059	5.10	5.10	\$420	\$2,142.24	\$4,201.68
43	2058	0.1912	0.5222	1,486	1,868	\$284	\$975	\$1,260	1,682	\$322	950	\$382	3,168	2,818	606	\$1,471	\$2,077	5.10	5.10	\$430	\$2,193.25	\$4,270.53
44	2059	0.1923	0.5273	1,486	1,868	\$286	\$985	\$1,271	1,682	\$324	950	\$383	3,168	2,818	609	\$1,486	\$2,095	5.10	5.10	\$440	\$2,244.26	\$4,339.55
45	2060	0.1934	0.5325	1,486	1,868	\$287	\$995	\$1,282	1,682	\$325	950	\$384	3,168	2,818	613	\$1,501	\$2,113	5.10	5.10	\$450	\$2,295.26	\$4,408.73
46	2061	0.1946	0.5378	1,486	1,868	\$289	\$1,005	\$1,294	1,682	\$327	950	\$385	3,168	2,818	616	\$1,515	\$2,132	5.10	5.10	\$460	\$2,346.27	\$4,478.08
47	2062	0.1957	0.5431	1,486	1,868	\$291	\$1,014	\$1,305	1,682	\$329	950	\$386	3,168	2,818	620	\$1,530	\$2,150	5.10	5.10	\$470	\$2,397.27	\$4,547.59
48	2063	0.1968	0.5484	1,486	1,868	\$292	\$1,024	\$1,317	1,682	\$331	950	\$387	3,168	2,818	624	\$1,545	\$2,169	5.10	5.10	\$480	\$2,448.28	\$4,617.27
49	2064	0.1980	0.5538	1,486	1,868	\$294	\$1,035	\$1,329	1,682	\$333	950	\$388	3,168	2,818	627	\$1,561	\$2,188	5.10	5.10	\$490	\$2,499.28	\$4,687.12
50	2065	0.1991	0.5593	1,486	1,868	\$296	\$1,045	\$1,341	1,682	\$335	950	\$389	3,168	2,818	631	\$1,576	\$2,207	5.10	5.10	\$500	\$2,550.29	\$4,757.14
51	2066	0.2003	0.5648	1,486	1,868	\$298	\$1,055	\$1,353	1,682	\$337	950	\$390	3,168	2,818	634	\$1,592	\$2,226	5.10	5.10	\$510	\$2,601.30	\$4,827.33
52	2067	0.2014	0.5704	1,486	1,868	\$299	\$1,065	\$1,365	1,682	\$339	950	\$391	3,168	2,818	638	\$1,607	\$2,245	5.10	5.10	\$520	\$2,652.30	\$4,897.70
53	2068	0.2026	0.5760	1,486	1,868	\$301	\$1,076	\$1,377	1,682	\$341	950	\$392	3,168	2,818	642	\$1,623	\$2,265	5.10	5.10	\$530	\$2,703.31	\$4,968.24
54	2069	0.2038	0.5817	1,486	1,868	\$303	\$1,087	\$1,389	1,682	\$343												

11. Simcoe (South) – Annual Operating Costs

Vertical Ground Source Heat Pump (V.GSHP)

Base Case Scenario											Feed in Tariff (FIT)		
#	Year	V.GSHP									FIT		
		Electricity Rates \$/KWh	Heating KWh	Heating Operating Cost \$	Cooling KWh	Cooling Operating Cost \$	Hot Water KWh	Hot Water Operating Cost \$	Total KWh	Total Operating Cost \$	Incentives (\$/KWh)	FIT \$/KWh	Operating Cost
1	2016	0.1501	3,846	\$577	318	\$48	4,475	\$672	8,639	\$1,297	0.05	0.1001	\$864.62
2	2017	0.1542	3,846	\$593	318	\$49	4,475	\$690	8,639	\$1,332	0.05	0.1042	\$900.07
3	2018	0.1583	3,846	\$609	318	\$50	4,475	\$708	8,639	\$1,367	0.05	0.1083	\$935.52
4	2019	0.1625	3,846	\$625	318	\$52	4,475	\$727	8,639	\$1,404	0.05	0.1125	\$972.22
5	2020	0.1668	3,846	\$641	318	\$53	4,475	\$746	8,639	\$1,441	0.05	0.1168	\$1,008.92
6	2021	0.1621	3,846	\$624	318	\$52	4,475	\$726	8,639	\$1,401	0.05	0.1121	\$968.80
7	2022	0.1629	3,846	\$627	318	\$52	4,475	\$729	8,639	\$1,408	0.05	0.1129	\$975.64
8	2023	0.1639	3,846	\$630	318	\$52	4,475	\$733	8,639	\$1,416	0.05	0.1139	\$983.73
9	2024	0.1648	3,846	\$634	318	\$52	4,475	\$738	8,639	\$1,424	0.05	0.1148	\$991.81
10	2025	0.1656	3,846	\$637	318	\$53	4,475	\$741	8,639	\$1,431	0.05	0.1156	\$998.66
11	2026	0.1665	3,846	\$640	318	\$53	4,475	\$745	8,639	\$1,439	0.05	0.1165	\$1,006.74
12	2027	0.1674	3,846	\$644	318	\$53	4,475	\$749	8,639	\$1,446	0.05	0.1174	\$1,014.52
13	2028	0.1683	3,846	\$647	318	\$54	4,475	\$753	8,639	\$1,454	0.05	0.1183	\$1,021.67
14	2029	0.1692	3,846	\$651	318	\$54	4,475	\$757	8,639	\$1,461	0.05	0.1192	\$1,029.45
15	2030	0.1701	3,846	\$654	318	\$54	4,475	\$761	8,639	\$1,469	0.05	0.1201	\$1,037.53
16	2031	0.1704	3,846	\$655	318	\$54	4,475	\$762	8,639	\$1,472	0.05	0.1204	\$1,039.71
17	2032	0.1705	3,846	\$656	318	\$54	4,475	\$763	8,639	\$1,473	0.05	0.1205	\$1,040.95
18	2033	0.1707	3,846	\$657	318	\$54	4,475	\$764	8,639	\$1,475	0.05	0.1207	\$1,043.13
19	2034	0.1710	3,846	\$658	318	\$54	4,475	\$765	8,639	\$1,478	0.05	0.1210	\$1,045.62
20	2035	0.1713	3,846	\$659	318	\$54	4,475	\$767	8,639	\$1,480	0.05	0.1213	\$1,047.80
21	2036	0.1714	3,846	\$659	318	\$55	4,475	\$767	8,639	\$1,481	0.05	0.1214	\$1,049.04
22	2037	0.1717	3,846	\$660	318	\$55	4,475	\$768	8,639	\$1,483	0.05	0.1217	\$1,051.22
23	2038	0.1720	3,846	\$661	318	\$55	4,475	\$770	8,639	\$1,486	0.05	0.1220	\$1,053.70
24	2039	0.1722	3,846	\$662	318	\$55	4,475	\$771	8,639	\$1,488	0.05	0.1222	\$1,055.88
25	2040	0.1724	3,846	\$663	318	\$55	4,475	\$771	8,639	\$1,489	0.05	0.1224	\$1,057.13
26	2041	0.1734	3,846	\$667	318	\$55	4,475	\$776	8,639	\$1,498	0.05	0.1234	\$1,065.74
27	2042	0.1744	3,846	\$671	318	\$55	4,475	\$780	8,639	\$1,506	0.05	0.1244	\$1,074.40
28	2043	0.1754	3,846	\$674	318	\$56	4,475	\$785	8,639	\$1,515	0.05	0.1254	\$1,083.12
29	2044	0.1764	3,846	\$678	318	\$56	4,475	\$789	8,639	\$1,524	0.05	0.1264	\$1,091.88
30	2045	0.1774	3,846	\$682	318	\$56	4,475	\$794	8,639	\$1,533	0.05	0.1274	\$1,100.70
31	2046	0.1784	3,846	\$686	318	\$57	4,475	\$799	8,639	\$1,542	0.05	0.1284	\$1,109.56
32	2047	0.1795	3,846	\$690	318	\$57	4,475	\$803	8,639	\$1,550	0.05	0.1295	\$1,118.48
33	2048	0.1805	3,846	\$694	318	\$57	4,475	\$808	8,639	\$1,559	0.05	0.1305	\$1,127.45
34	2049	0.1816	3,846	\$698	318	\$58	4,475	\$812	8,639	\$1,568	0.05	0.1316	\$1,136.47
35	2050	0.1826	3,846	\$702	318	\$58	4,475	\$817	8,639	\$1,577	0.05	0.1326	\$1,145.54
36	2051	0.1837	3,846	\$706	318	\$58	4,475	\$822	8,639	\$1,587	0.05	0.1337	\$1,154.67
37	2052	0.1847	3,846	\$710	318	\$59	4,475	\$827	8,639	\$1,596	0.05	0.1347	\$1,163.85
38	2053	0.1858	3,846	\$715	318	\$59	4,475	\$831	8,639	\$1,605	0.05	0.1358	\$1,173.08
39	2054	0.1869	3,846	\$719	318	\$59	4,475	\$836	8,639	\$1,614	0.05	0.1369	\$1,182.36
40	2055	0.1879	3,846	\$723	318	\$60	4,475	\$841	8,639	\$1,624	0.05	0.1379	\$1,191.70
41	2056	0.1890	3,846	\$727	318	\$60	4,475	\$846	8,639	\$1,633	0.05	0.1390	\$1,201.09
42	2057	0.1901	3,846	\$731	318	\$60	4,475	\$851	8,639	\$1,642	0.05	0.1401	\$1,210.54
43	2058	0.1912	3,846	\$735	318	\$61	4,475	\$856	8,639	\$1,652	0.05	0.1412	\$1,220.04
44	2059	0.1923	3,846	\$740	318	\$61	4,475	\$861	8,639	\$1,662	0.05	0.1423	\$1,229.60
45	2060	0.1934	3,846	\$744	318	\$62	4,475	\$866	8,639	\$1,671	0.05	0.1434	\$1,239.21
46	2061	0.1946	3,846	\$748	318	\$62	4,475	\$871	8,639	\$1,681	0.05	0.1446	\$1,248.88
47	2062	0.1957	3,846	\$753	318	\$62	4,475	\$876	8,639	\$1,691	0.05	0.1457	\$1,258.60
48	2063	0.1968	3,846	\$757	318	\$63	4,475	\$881	8,639	\$1,700	0.05	0.1468	\$1,268.38
49	2064	0.1980	3,846	\$761	318	\$63	4,475	\$886	8,639	\$1,710	0.05	0.1480	\$1,278.22
50	2065	0.1991	3,846	\$766	318	\$63	4,475	\$891	8,639	\$1,720	0.05	0.1491	\$1,288.11
51	2066	0.2003	3,846	\$770	318	\$64	4,475	\$896	8,639	\$1,730	0.05	0.1503	\$1,298.06
52	2067	0.2014	3,846	\$775	318	\$64	4,475	\$901	8,639	\$1,740	0.05	0.1514	\$1,308.07
53	2068	0.2026	3,846	\$779	318	\$64	4,475	\$907	8,639	\$1,750	0.05	0.1526	\$1,318.14
54	2069	0.2038	3,846	\$784	318	\$65	4,475	\$912	8,639	\$1,760	0.05	0.1538	\$1,328.26
55	2070	0.2049	3,846	\$788	318	\$65	4,475	\$917	8,639	\$1,770	0.05	0.1549	\$1,338.44
56	2071	0.2061	3,846	\$793	318	\$66	4,475	\$922	8,639	\$1,781	0.05	0.1561	\$1,348.68
57	2072	0.2073	3,846	\$797	318	\$66	4,475	\$928	8,639	\$1,791	0.05	0.1573	\$1,358.98
58	2073	0.2085	3,846	\$802	318	\$66	4,475	\$933	8,639	\$1,801	0.05	0.1585	\$1,369.34
59	2074	0.2097	3,846	\$807	318	\$67	4,475	\$938	8,639	\$1,812	0.05	0.1597	\$1,379.76
60	2075	0.2109	3,846	\$811	318	\$67	4,475	\$944	8,639	\$1,822	0.05	0.1609	\$1,390.25

Table D2-1.31: Annual Operating Costs (V.GSHP) of a 2,000 square feet detached house above grade (improved construction type) in the city of Simcoe (two life cycles and three life cycles for a 60 year project lifespan); base case scenario in comparison with feed in-tariff (FIT) scenario. In the FIT scenario, an incentive of \$0.05/KWh is provided on electricity bills throughout the project lifespan

Horizontal Ground Source Heat Pump (H.GSHP)

Base Case Scenario												Feed in Tariff (FIT)		
H.GSHP												FIT		
#	Year	Electricity Rates \$/KWh	Heating KWh	Heating Operating Cost \$	Cooling KWh	Cooling Operating Cost \$	Hot Water KWh	Hot Water Operating Cost \$	Total KWh	Total Operating Cost \$	Incentives (\$/KWh)	S/KWh	Operating Cost	
1	2016	0.1501	3,913	\$587	325	\$49	4,475	\$672	8,713	\$1,308	0.05	0.1001	\$872.02	
2	2017	0.1542	3,913	\$603	325	\$50	4,475	\$690	8,713	\$1,343	0.05	0.1042	\$907.78	
3	2018	0.1583	3,913	\$619	325	\$51	4,475	\$708	8,713	\$1,379	0.05	0.1083	\$943.54	
4	2019	0.1623	3,913	\$636	325	\$53	4,475	\$727	8,713	\$1,416	0.05	0.1123	\$980.55	
5	2020	0.1668	3,913	\$653	325	\$54	4,475	\$746	8,713	\$1,453	0.05	0.1168	\$1,017.56	
6	2021	0.1621	3,913	\$634	325	\$53	4,475	\$726	8,713	\$1,413	0.05	0.1121	\$977.10	
7	2022	0.1629	3,913	\$638	325	\$53	4,475	\$729	8,713	\$1,420	0.05	0.1129	\$984.00	
8	2023	0.1639	3,913	\$641	325	\$53	4,475	\$733	8,713	\$1,428	0.05	0.1139	\$992.16	
9	2024	0.1648	3,913	\$645	325	\$54	4,475	\$738	8,713	\$1,436	0.05	0.1148	\$1,000.31	
10	2025	0.1656	3,913	\$648	325	\$54	4,475	\$741	8,713	\$1,443	0.05	0.1156	\$1,007.21	
11	2026	0.1665	3,913	\$652	325	\$54	4,475	\$745	8,713	\$1,451	0.05	0.1165	\$1,015.37	
12	2027	0.1674	3,913	\$655	325	\$54	4,475	\$749	8,713	\$1,459	0.05	0.1174	\$1,023.21	
13	2028	0.1683	3,913	\$658	325	\$55	4,475	\$753	8,713	\$1,466	0.05	0.1183	\$1,030.42	
14	2029	0.1692	3,913	\$662	325	\$55	4,475	\$757	8,713	\$1,474	0.05	0.1192	\$1,038.26	
15	2030	0.1701	3,913	\$666	325	\$55	4,475	\$761	8,713	\$1,482	0.05	0.1201	\$1,046.42	
16	2031	0.1704	3,913	\$667	325	\$55	4,475	\$762	8,713	\$1,484	0.05	0.1204	\$1,048.62	
17	2032	0.1705	3,913	\$667	325	\$55	4,475	\$763	8,713	\$1,486	0.05	0.1205	\$1,049.87	
18	2033	0.1707	3,913	\$668	325	\$55	4,475	\$764	8,713	\$1,488	0.05	0.1207	\$1,052.07	
19	2034	0.1710	3,913	\$669	325	\$56	4,475	\$765	8,713	\$1,490	0.05	0.1210	\$1,054.57	
20	2035	0.1713	3,913	\$670	325	\$56	4,475	\$767	8,713	\$1,492	0.05	0.1213	\$1,056.77	
21	2036	0.1714	3,913	\$671	325	\$56	4,475	\$767	8,713	\$1,494	0.05	0.1214	\$1,058.03	
22	2037	0.1717	3,913	\$672	325	\$56	4,475	\$768	8,713	\$1,496	0.05	0.1217	\$1,060.22	
23	2038	0.1720	3,913	\$673	325	\$56	4,475	\$770	8,713	\$1,498	0.05	0.1220	\$1,062.73	
24	2039	0.1722	3,913	\$674	325	\$56	4,475	\$771	8,713	\$1,501	0.05	0.1222	\$1,064.93	
25	2040	0.1724	3,913	\$674	325	\$56	4,475	\$771	8,713	\$1,502	0.05	0.1224	\$1,066.18	
26	2041	0.1734	3,913	\$678	325	\$56	4,475	\$776	8,713	\$1,511	0.05	0.1234	\$1,074.87	
27	2042	0.1744	3,913	\$682	325	\$57	4,475	\$780	8,713	\$1,519	0.05	0.1244	\$1,083.61	
28	2043	0.1754	3,913	\$686	325	\$57	4,475	\$785	8,713	\$1,528	0.05	0.1254	\$1,092.40	
29	2044	0.1764	3,913	\$690	325	\$57	4,475	\$789	8,713	\$1,537	0.05	0.1264	\$1,101.23	
30	2045	0.1774	3,913	\$694	325	\$58	4,475	\$794	8,713	\$1,546	0.05	0.1274	\$1,110.13	
31	2046	0.1784	3,913	\$698	325	\$58	4,475	\$799	8,713	\$1,555	0.05	0.1284	\$1,119.07	
32	2047	0.1795	3,913	\$702	325	\$58	4,475	\$803	8,713	\$1,564	0.05	0.1295	\$1,128.06	
33	2048	0.1805	3,913	\$706	325	\$59	4,475	\$808	8,713	\$1,573	0.05	0.1305	\$1,137.11	
34	2049	0.1816	3,913	\$710	325	\$59	4,475	\$812	8,713	\$1,582	0.05	0.1316	\$1,146.21	
35	2050	0.1826	3,913	\$715	325	\$59	4,475	\$817	8,713	\$1,591	0.05	0.1326	\$1,155.36	
36	2051	0.1837	3,913	\$719	325	\$60	4,475	\$822	8,713	\$1,600	0.05	0.1337	\$1,164.56	
37	2052	0.1847	3,913	\$723	325	\$60	4,475	\$827	8,713	\$1,609	0.05	0.1347	\$1,173.82	
38	2053	0.1858	3,913	\$727	325	\$60	4,475	\$831	8,713	\$1,619	0.05	0.1358	\$1,183.13	
39	2054	0.1869	3,913	\$731	325	\$61	4,475	\$836	8,713	\$1,628	0.05	0.1369	\$1,192.49	
40	2055	0.1879	3,913	\$735	325	\$61	4,475	\$841	8,713	\$1,638	0.05	0.1379	\$1,201.91	
41	2056	0.1890	3,913	\$740	325	\$61	4,475	\$846	8,713	\$1,647	0.05	0.1390	\$1,211.38	
42	2057	0.1901	3,913	\$744	325	\$62	4,475	\$851	8,713	\$1,657	0.05	0.1401	\$1,220.91	
43	2058	0.1912	3,913	\$748	325	\$62	4,475	\$856	8,713	\$1,666	0.05	0.1412	\$1,230.49	
44	2059	0.1923	3,913	\$753	325	\$63	4,475	\$861	8,713	\$1,676	0.05	0.1423	\$1,240.13	
45	2060	0.1934	3,913	\$757	325	\$63	4,475	\$866	8,713	\$1,685	0.05	0.1434	\$1,249.83	
46	2061	0.1946	3,913	\$761	325	\$63	4,475	\$871	8,713	\$1,695	0.05	0.1446	\$1,259.58	
47	2062	0.1957	3,913	\$766	325	\$64	4,475	\$876	8,713	\$1,705	0.05	0.1457	\$1,269.38	
48	2063	0.1968	3,913	\$770	325	\$64	4,475	\$881	8,713	\$1,715	0.05	0.1468	\$1,279.25	
49	2064	0.1980	3,913	\$775	325	\$64	4,475	\$886	8,713	\$1,725	0.05	0.1480	\$1,289.17	
50	2065	0.1991	3,913	\$779	325	\$65	4,475	\$891	8,713	\$1,735	0.05	0.1491	\$1,299.15	
51	2066	0.2003	3,913	\$784	325	\$65	4,475	\$896	8,713	\$1,745	0.05	0.1503	\$1,309.18	
52	2067	0.2014	3,913	\$788	325	\$65	4,475	\$901	8,713	\$1,755	0.05	0.1514	\$1,319.27	
53	2068	0.2026	3,913	\$793	325	\$66	4,475	\$907	8,713	\$1,765	0.05	0.1526	\$1,329.43	
54	2069	0.2038	3,913	\$797	325	\$66	4,475	\$912	8,713	\$1,775	0.05	0.1538	\$1,339.64	
55	2070	0.2049	3,913	\$802	325	\$67	4,475	\$917	8,713	\$1,786	0.05	0.1549	\$1,349.91	
56	2071	0.2061	3,913	\$807	325	\$67	4,475	\$922	8,713	\$1,796	0.05	0.1561	\$1,360.24	
57	2072	0.2073	3,913	\$811	325	\$67	4,475	\$928	8,713	\$1,806	0.05	0.1573	\$1,370.63	
58	2073	0.2085	3,913	\$816	325	\$68	4,475	\$933	8,713	\$1,817	0.05	0.1585	\$1,381.07	
59	2074	0.2097	3,913	\$821	325	\$68	4,475	\$938	8,713	\$1,827	0.05	0.1597	\$1,391.58	
60	2075	0.2109	3,913	\$825	325	\$69	4,475	\$944	8,713	\$1,838	0.05	0.1609	\$1,402.15	

Table D2-1.32: Annual Operating Costs (H.GSHP) of a 2,000 square feet detached house above grade (improved construction type) in the city of Simcoe (two life cycles and three life cycles for a 60 year project lifespan); base case scenario in comparison with feed in-tariff (FIT) scenario. In the FIT scenario, an incentive of \$0.05/KWh is provided on electricity bills throughout the project lifespan

Traditional HVAC Applications

Base Case Scenario															Carbon Taxes							
#	Year	Electricity Rates \$/KWh	Natural Gas Rates \$/m ³	Heating		Heating Operating Cost \$ (Electricity)	Heating Operating Cost \$ (Gas)	Total Heating Operating Cost \$	Cooling KWh	Cooling Operating Cost \$	Hot Water m ³	Hot Water Operating Cost \$	Total KWh	Total m ³	Total Electricity Operating Cost \$ (KWh)	Total Natural Gas Operating Cost \$ (m ³)	Total	Conversion of m ³ into Tons	Total Tons	Carbon Tax \$10	Operating Costs	
				KWh (Electricity)	m ³ (Gas)																	
1	2016	0.1501	0.3458	1,624	1,918	\$244	\$663	\$907	1,529	\$229	1,007	\$348	3,153	2,925	473	\$1,012	\$1,485	5.29	5.29	\$10	\$52.94	\$1,537.71
2	2017	0.1542	0.3588	1,624	1,918	\$250	\$688	\$939	1,529	\$236	1,007	\$155	3,153	2,925	486	\$1,050	\$1,536	5.29	5.29	\$20	\$105.89	\$1,641.63
3	2018	0.1583	0.3718	1,624	1,918	\$257	\$713	\$970	1,529	\$242	1,007	\$159	3,153	2,925	499	\$1,088	\$1,587	5.29	5.29	\$30	\$158.83	\$1,745.56
4	2019	0.1625	0.3776	1,624	1,918	\$264	\$724	\$988	1,529	\$249	1,007	\$164	3,153	2,925	512	\$1,104	\$1,617	5.29	5.29	\$40	\$211.77	\$1,828.68
5	2020	0.1668	0.3841	1,624	1,918	\$271	\$737	\$1,008	1,529	\$255	1,007	\$168	3,153	2,925	526	\$1,123	\$1,649	5.29	5.29	\$50	\$264.71	\$1,914.04
6	2021	0.1621	0.3883	1,624	1,918	\$263	\$745	\$1,008	1,529	\$248	1,007	\$163	3,153	2,925	511	\$1,136	\$1,647	5.29	5.29	\$60	\$317.66	\$1,964.65
7	2022	0.1629	0.3929	1,624	1,918	\$265	\$754	\$1,018	1,529	\$249	1,007	\$164	3,153	2,925	514	\$1,149	\$1,663	5.29	5.29	\$70	\$370.60	\$2,033.52
8	2023	0.1639	0.3967	1,624	1,918	\$266	\$761	\$1,027	1,529	\$251	1,007	\$165	3,153	2,925	517	\$1,160	\$1,677	5.29	5.29	\$80	\$423.54	\$2,100.60
9	2024	0.1648	0.4005	1,624	1,918	\$268	\$768	\$1,036	1,529	\$252	1,007	\$166	3,153	2,925	520	\$1,172	\$1,691	5.29	5.29	\$90	\$476.48	\$2,167.68
10	2025	0.1656	0.4040	1,624	1,918	\$269	\$775	\$1,044	1,529	\$253	1,007	\$167	3,153	2,925	522	\$1,182	\$1,704	5.29	5.29	\$100	\$529.43	\$2,231.19
11	2026	0.1665	0.4070	1,624	1,918	\$270	\$781	\$1,051	1,529	\$255	1,007	\$168	3,153	2,925	525	\$1,191	\$1,716	5.29	5.29	\$110	\$582.37	\$2,298.04
12	2027	0.1674	0.4097	1,624	1,918	\$272	\$786	\$1,059	1,529	\$256	1,007	\$169	3,153	2,925	528	\$1,198	\$1,726	5.29	5.29	\$120	\$635.31	\$2,361.65
13	2028	0.1683	0.4124	1,624	1,918	\$273	\$791	\$1,064	1,529	\$257	1,007	\$169	3,153	2,925	531	\$1,206	\$1,737	5.29	5.29	\$130	\$688.25	\$2,425.04
14	2029	0.1692	0.4151	1,624	1,918	\$275	\$796	\$1,071	1,529	\$259	1,007	\$170	3,153	2,925	533	\$1,214	\$1,747	5.29	5.29	\$140	\$741.20	\$2,488.65
15	2030	0.1701	0.4170	1,624	1,918	\$276	\$800	\$1,076	1,529	\$260	1,007	\$171	3,153	2,925	536	\$1,220	\$1,756	5.29	5.29	\$150	\$794.14	\$2,550.14
16	2031	0.1704	0.4189	1,624	1,918	\$277	\$803	\$1,080	1,529	\$260	1,007	\$172	3,153	2,925	537	\$1,225	\$1,762	5.29	5.29	\$160	\$847.08	\$2,609.47
17	2032	0.1705	0.4204	1,624	1,918	\$277	\$806	\$1,083	1,529	\$261	1,007	\$172	3,153	2,925	538	\$1,230	\$1,767	5.29	5.29	\$170	\$900.02	\$2,667.35
18	2033	0.1707	0.4223	1,624	1,918	\$277	\$810	\$1,087	1,529	\$261	1,007	\$172	3,153	2,925	538	\$1,235	\$1,774	5.29	5.29	\$180	\$952.97	\$2,726.68
19	2034	0.1710	0.4246	1,624	1,918	\$278	\$814	\$1,092	1,529	\$262	1,007	\$172	3,153	2,925	539	\$1,242	\$1,781	5.29	5.29	\$190	\$1,005.91	\$2,787.24
20	2035	0.1713	0.4265	1,624	1,918	\$278	\$818	\$1,096	1,529	\$262	1,007	\$172	3,153	2,925	540	\$1,248	\$1,788	5.29	5.29	\$200	\$1,058.85	\$2,846.57
21	2036	0.1714	0.4288	1,624	1,918	\$278	\$823	\$1,101	1,529	\$262	1,007	\$173	3,153	2,925	541	\$1,254	\$1,795	5.29	5.29	\$210	\$1,111.79	\$2,906.68
22	2037	0.1717	0.4311	1,624	1,918	\$279	\$827	\$1,106	1,529	\$263	1,007	\$173	3,153	2,925	541	\$1,261	\$1,802	5.29	5.29	\$220	\$1,164.74	\$2,967.13
23	2038	0.1720	0.4331	1,624	1,918	\$279	\$831	\$1,110	1,529	\$263	1,007	\$173	3,153	2,925	542	\$1,267	\$1,809	5.29	5.29	\$230	\$1,217.68	\$3,026.58
24	2039	0.1722	0.4353	1,624	1,918	\$280	\$835	\$1,115	1,529	\$263	1,007	\$173	3,153	2,925	543	\$1,273	\$1,816	5.29	5.29	\$240	\$1,270.62	\$3,087.03
25	2040	0.1724	0.4376	1,624	1,918	\$280	\$839	\$1,119	1,529	\$264	1,007	\$174	3,153	2,925	543	\$1,280	\$1,824	5.29	5.29	\$250	\$1,323.56	\$3,147.14
26	2041	0.1734	0.4420	1,624	1,918	\$282	\$848	\$1,129	1,529	\$265	1,007	\$175	3,153	2,925	547	\$1,293	\$1,839	5.29	5.29	\$260	\$1,376.51	\$3,215.85
27	2042	0.1744	0.4463	1,624	1,918	\$283	\$856	\$1,139	1,529	\$267	1,007	\$176	3,153	2,925	550	\$1,305	\$1,855	5.29	5.29	\$270	\$1,429.45	\$3,284.70
28	2043	0.1754	0.4507	1,624	1,918	\$285	\$864	\$1,149	1,529	\$268	1,007	\$177	3,153	2,925	553	\$1,318	\$1,871	5.29	5.29	\$280	\$1,482.39	\$3,353.69
29	2044	0.1764	0.4552	1,624	1,918	\$286	\$873	\$1,159	1,529	\$270	1,007	\$178	3,153	2,925	556	\$1,331	\$1,887	5.29	5.29	\$290	\$1,535.33	\$3,422.83
30	2045	0.1774	0.4596	1,624	1,918	\$288	\$882	\$1,170	1,529	\$271	1,007	\$179	3,153	2,925	559	\$1,344	\$1,904	5.29	5.29	\$300	\$1,588.28	\$3,492.12
31	2046	0.1784	0.4642	1,624	1,918	\$290	\$890	\$1,180	1,529	\$273	1,007	\$180	3,153	2,925	563	\$1,358	\$1,920	5.29	5.29	\$310	\$1,641.22	\$3,561.55
32	2047	0.1795	0.4688	1,624	1,918	\$291	\$899	\$1,191	1,529	\$274	1,007	\$181	3,153	2,925	566	\$1,371	\$1,937	5.29	5.29	\$320	\$1,694.16	\$3,631.13
33	2048	0.1805	0.4734	1,624	1,918	\$293	\$908	\$1,201	1,529	\$276	1,007	\$182	3,153	2,925	569	\$1,385	\$1,954	5.29	5.29	\$330	\$1,747.10	\$3,700.87
34	2049	0.1816	0.4780	1,624	1,918	\$295	\$917	\$1,212	1,529	\$278	1,007	\$183	3,153	2,925	572	\$1,398	\$1,971	5.29	5.29	\$340	\$1,800.05	\$3,770.75
35	2050	0.1826	0.4828	1,624	1,918	\$297	\$926	\$1,222	1,529	\$279	1,007	\$184	3,153	2,925	576	\$1,412	\$1,988	5.29	5.29	\$350	\$1,852.99	\$3,840.79
36	2051	0.1837	0.4875	1,624	1,918	\$298	\$935	\$1,233	1,529	\$281	1,007	\$185	3,153	2,925	579	\$1,426	\$2,005	5.29	5.29	\$360	\$1,905.93	\$3,910.99
37	2052	0.1847	0.4923	1,624	1,918	\$300	\$944	\$1,244	1,529	\$282	1,007	\$186	3,153	2,925	582	\$1,440	\$2,022	5.29	5.29	\$370	\$1,958.87	\$3,981.34
38	2053	0.1858	0.4972	1,624	1,918	\$302	\$954	\$1,255	1,529	\$284	1,007	\$187	3,153	2,925	586	\$1,454	\$2,040	5.29	5.29	\$380	\$2,011.82	\$4,051.85
39	2054	0.1869	0.5021	1,624	1,918	\$303	\$963	\$1,266	1,529	\$286	1,007	\$188	3,153	2,925	589	\$1,469	\$2,058	5.29	5.29	\$390	\$2,064.76	\$4,122.51
40	2055	0.1879	0.5070	1,624	1,918	\$305	\$972	\$1,278	1,529	\$287	1,007	\$189	3,153	2,925	593	\$1,483	\$2,076	5.29	5.29	\$400	\$2,117.70	\$4,193.34
41	2056	0.1890	0.5120	1,624	1,918	\$307	\$982	\$1,289	1,529	\$289	1,007	\$190	3,153	2,925	596	\$1,498	\$2,094	5.29	5.29	\$410	\$2,170.64	\$4,264.34
42	2057	0.1901	0.5171	1,624	1,918	\$309	\$992	\$1,301	1,529	\$291	1,007	\$191	3,153	2,925	599	\$1,512	\$2,112	5.29	5.29	\$420	\$2,223.59	\$4,335.49
43	2058	0.1912	0.5222	1,624	1,918	\$311	\$1,002	\$1,312	1,529	\$292	1,007	\$193	3,153	2,925	603	\$1,527	\$2,130	5.29	5.29	\$430	\$2,276.53	\$4,406.81
44	2059	0.1923	0.5273	1,624	1,918	\$312	\$1,011	\$1,324	1,529	\$294	1,007	\$194	3,153	2,925	606	\$1,542	\$2,149	5.29	5.29	\$440	\$2,329.47	\$4,478.30
45	2060	0.1934	0.5325	1,624	1,918	\$314	\$1,021	\$1,336	1,529	\$296	1,007	\$195	3,153	2,925	610	\$1,558	\$2,168	5.29	5.29	\$450	\$2,382.41	\$4,549.96
46	2061	0.1946	0.5378	1,624	1,918	\$316	\$1,031	\$1,347	1,529	\$297	1,007	\$196	3,153	2,925	613	\$1,573	\$2,186	5.29	5.29	\$460	\$2,435.36	\$4,621.79
47	2062	0.1957	0.5431	1,624	1,918	\$318	\$1,042	\$1,359	1,529	\$299	1,007	\$197	3,153	2,925	617	\$1,588	\$2,205	5.29	5.29	\$470	\$2,488.30	\$4,693.79
48	2063	0.1968	0.5484	1,624	1,918	\$320	\$1,052	\$1,372	1,529	\$301	1,007	\$198	3,153	2,925	621	\$1,604	\$2,225	5.29	5.29	\$480	\$2,541.24	\$4,765.96
49	2064	0.1980	0.5538	1,624	1,918	\$321	\$1,062	\$1,384	1,529	\$303	1,007	\$199	3,153	2,925	624	\$1,620	\$2,244	5.29	5.29	\$490	\$2,594.18	\$4,838.31
50	2065	0.1991	0.5593	1,624	1,918	\$323	\$1,073	\$1,396	1,529	\$304	1,007	\$200	3,153	2,925	628	\$1,636	\$2,264	5.29	5.29	\$500	\$2,647.13	\$4,910.83
51	2066	0.2003	0.5648	1,624	1,918	\$325	\$1,083	\$1,409	1,529	\$306	1,007	\$202	3,153	2,925	631	\$1,652	\$2,283	5.29	5.29	\$510	\$2,700.07	\$4,983.53
52	2067	0.2014	0.5704	1,624	1,918	\$327	\$1,094	\$1,421	1,529	\$308	1,007	\$203	3,153	2,925	635	\$1,668	\$2,303	5.29	5.29	\$520	\$2,753.01	\$5,056.42
53	2068	0.2026	0.5760	1,624	1,918	\$329	\$1,105	\$1,434	1,529	\$310	1,007	\$204	3,153	2,925	639	\$1,685	\$2,324	5.29	5.29	\$530	\$2,805.95	\$5,129.48

12. Saint Catharines (South) – Annual Operating Costs

Vertical Ground Source Heat Pump (V.GSHP)

Base Case Scenario											Feed in Tariff (FIT)		
#	Year	V.GSHP									FIT		
		Electricity Rates \$/kWh	Heating kWh	Heating Operating Cost \$	Cooling kWh	Cooling Operating Cost \$	Hot Water kWh	Hot Water Operating Cost \$	Total kWh	Total Operating Cost \$	Incentives (\$/kWh)	\$/kWh	Operating Cost
1	2016	0.1501	3,518	\$528	421	\$63	4,417	\$663	8,356	\$1,254	0.05	0.1001	\$836.29
2	2017	0.1542	3,518	\$542	421	\$65	4,417	\$681	8,356	\$1,288	0.05	0.1042	\$870.58
3	2018	0.1583	3,518	\$557	421	\$67	4,417	\$699	8,356	\$1,323	0.05	0.1083	\$904.88
4	2019	0.1625	3,518	\$572	421	\$68	4,417	\$718	8,356	\$1,358	0.05	0.1125	\$940.37
5	2020	0.1668	3,518	\$587	421	\$70	4,417	\$737	8,356	\$1,394	0.05	0.1168	\$975.87
6	2021	0.1621	3,518	\$570	421	\$68	4,417	\$716	8,356	\$1,355	0.05	0.1121	\$937.06
7	2022	0.1629	3,518	\$573	421	\$69	4,417	\$720	8,356	\$1,361	0.05	0.1129	\$943.68
8	2023	0.1639	3,518	\$576	421	\$69	4,417	\$724	8,356	\$1,369	0.05	0.1139	\$951.50
9	2024	0.1648	3,518	\$580	421	\$69	4,417	\$728	8,356	\$1,377	0.05	0.1148	\$959.32
10	2025	0.1656	3,518	\$583	421	\$70	4,417	\$731	8,356	\$1,384	0.05	0.1156	\$965.94
11	2026	0.1665	3,518	\$586	421	\$70	4,417	\$736	8,356	\$1,392	0.05	0.1165	\$973.76
12	2027	0.1674	3,518	\$589	421	\$70	4,417	\$740	8,356	\$1,399	0.05	0.1174	\$981.28
13	2028	0.1683	3,518	\$592	421	\$71	4,417	\$743	8,356	\$1,406	0.05	0.1183	\$988.20
14	2029	0.1692	3,518	\$595	421	\$71	4,417	\$747	8,356	\$1,414	0.05	0.1192	\$995.72
15	2030	0.1701	3,518	\$598	421	\$72	4,417	\$751	8,356	\$1,421	0.05	0.1201	\$1,003.54
16	2031	0.1704	3,518	\$599	421	\$72	4,417	\$752	8,356	\$1,423	0.05	0.1204	\$1,005.65
17	2032	0.1705	3,518	\$600	421	\$72	4,417	\$753	8,356	\$1,425	0.05	0.1205	\$1,006.85
18	2033	0.1707	3,518	\$601	421	\$72	4,417	\$754	8,356	\$1,427	0.05	0.1207	\$1,008.96
19	2034	0.1710	3,518	\$602	421	\$72	4,417	\$755	8,356	\$1,429	0.05	0.1210	\$1,011.37
20	2035	0.1713	3,518	\$603	421	\$72	4,417	\$757	8,356	\$1,431	0.05	0.1213	\$1,013.47
21	2036	0.1714	3,518	\$603	421	\$72	4,417	\$757	8,356	\$1,432	0.05	0.1214	\$1,014.67
22	2037	0.1717	3,518	\$604	421	\$72	4,417	\$758	8,356	\$1,435	0.05	0.1217	\$1,016.78
23	2038	0.1720	3,518	\$605	421	\$72	4,417	\$760	8,356	\$1,437	0.05	0.1220	\$1,019.19
24	2039	0.1722	3,518	\$606	421	\$73	4,417	\$761	8,356	\$1,439	0.05	0.1222	\$1,021.29
25	2040	0.1724	3,518	\$606	421	\$73	4,417	\$761	8,356	\$1,440	0.05	0.1224	\$1,022.50
26	2041	0.1734	3,518	\$610	421	\$73	4,417	\$766	8,356	\$1,449	0.05	0.1234	\$1,030.83
27	2042	0.1744	3,518	\$613	421	\$73	4,417	\$770	8,356	\$1,457	0.05	0.1244	\$1,039.21
28	2043	0.1754	3,518	\$617	421	\$74	4,417	\$775	8,356	\$1,465	0.05	0.1254	\$1,047.64
29	2044	0.1764	3,518	\$621	421	\$74	4,417	\$779	8,356	\$1,474	0.05	0.1264	\$1,056.11
30	2045	0.1774	3,518	\$624	421	\$75	4,417	\$784	8,356	\$1,482	0.05	0.1274	\$1,064.64
31	2046	0.1784	3,518	\$628	421	\$75	4,417	\$788	8,356	\$1,491	0.05	0.1284	\$1,073.22
32	2047	0.1795	3,518	\$631	421	\$76	4,417	\$793	8,356	\$1,500	0.05	0.1295	\$1,081.84
33	2048	0.1805	3,518	\$635	421	\$76	4,417	\$797	8,356	\$1,508	0.05	0.1305	\$1,090.52
34	2049	0.1816	3,518	\$639	421	\$76	4,417	\$802	8,356	\$1,517	0.05	0.1316	\$1,099.24
35	2050	0.1826	3,518	\$642	421	\$77	4,417	\$807	8,356	\$1,526	0.05	0.1326	\$1,108.02
36	2051	0.1837	3,518	\$646	421	\$77	4,417	\$811	8,356	\$1,535	0.05	0.1337	\$1,116.84
37	2052	0.1847	3,518	\$650	421	\$78	4,417	\$816	8,356	\$1,544	0.05	0.1347	\$1,125.72
38	2053	0.1858	3,518	\$654	421	\$78	4,417	\$821	8,356	\$1,552	0.05	0.1358	\$1,134.65
39	2054	0.1869	3,518	\$657	421	\$79	4,417	\$825	8,356	\$1,561	0.05	0.1369	\$1,143.63
40	2055	0.1879	3,518	\$661	421	\$79	4,417	\$830	8,356	\$1,570	0.05	0.1379	\$1,152.66
41	2056	0.1890	3,518	\$665	421	\$80	4,417	\$835	8,356	\$1,580	0.05	0.1390	\$1,161.75
42	2057	0.1901	3,518	\$669	421	\$80	4,417	\$840	8,356	\$1,589	0.05	0.1401	\$1,170.89
43	2058	0.1912	3,518	\$673	421	\$81	4,417	\$845	8,356	\$1,598	0.05	0.1412	\$1,180.08
44	2059	0.1923	3,518	\$677	421	\$81	4,417	\$850	8,356	\$1,607	0.05	0.1423	\$1,189.32
45	2060	0.1934	3,518	\$681	421	\$81	4,417	\$854	8,356	\$1,616	0.05	0.1434	\$1,198.62
46	2061	0.1946	3,518	\$684	421	\$82	4,417	\$859	8,356	\$1,626	0.05	0.1446	\$1,207.97
47	2062	0.1957	3,518	\$688	421	\$82	4,417	\$864	8,356	\$1,635	0.05	0.1457	\$1,217.37
48	2063	0.1968	3,518	\$692	421	\$83	4,417	\$869	8,356	\$1,645	0.05	0.1468	\$1,226.83
49	2064	0.1980	3,518	\$696	421	\$83	4,417	\$874	8,356	\$1,654	0.05	0.1480	\$1,236.35
50	2065	0.1991	3,518	\$700	421	\$84	4,417	\$879	8,356	\$1,664	0.05	0.1491	\$1,245.92
51	2066	0.2003	3,518	\$705	421	\$84	4,417	\$885	8,356	\$1,673	0.05	0.1503	\$1,255.54
52	2067	0.2014	3,518	\$709	421	\$85	4,417	\$890	8,356	\$1,683	0.05	0.1514	\$1,265.22
53	2068	0.2026	3,518	\$713	421	\$85	4,417	\$895	8,356	\$1,693	0.05	0.1526	\$1,274.96
54	2069	0.2038	3,518	\$717	421	\$86	4,417	\$900	8,356	\$1,703	0.05	0.1538	\$1,284.75
55	2070	0.2049	3,518	\$721	421	\$86	4,417	\$905	8,356	\$1,712	0.05	0.1549	\$1,294.60
56	2071	0.2061	3,518	\$725	421	\$87	4,417	\$910	8,356	\$1,722	0.05	0.1561	\$1,304.50
57	2072	0.2073	3,518	\$729	421	\$87	4,417	\$916	8,356	\$1,732	0.05	0.1573	\$1,314.47
58	2073	0.2085	3,518	\$734	421	\$88	4,417	\$921	8,356	\$1,742	0.05	0.1585	\$1,324.49
59	2074	0.2097	3,518	\$738	421	\$88	4,417	\$926	8,356	\$1,752	0.05	0.1597	\$1,334.57
60	2075	0.2109	3,518	\$742	421	\$89	4,417	\$932	8,356	\$1,763	0.05	0.1609	\$1,344.70

Table D2-1.34: Annual Operating Costs (V.GSHP) of a 2,000 square feet detached house above grade (improved construction type) in the city of Saint Catharines (two life cycles and three life cycles for a 60 year project lifespan); base case scenario in comparison with feed in-tariff (FIT) scenario. In the FIT scenario, an incentive of \$0.05/KWh is provided on electricity bills throughout the project lifespan

Horizontal Ground Source Heat Pump (H.GSHP)

Base Case Scenario												Feed in Tariff (FIT)		
H.GSHP												FIT		
#	Year	Electricity Rates \$/KWh	Heating KWh	Heating Operating Cost \$	Cooling KWh	Cooling Operating Cost \$	Hot Water KWh	Hot Water Operating Cost \$	Total KWh	Total Operating Cost \$	Incentives (\$/KWh)	S/KWh	Operating Cost	
1	2016	0.1501	3,503	\$526	457	\$69	4,171	\$626	8,131	\$1,220	0.05	0.1001	\$813.77	
2	2017	0.1542	3,503	\$540	457	\$70	4,171	\$643	8,131	\$1,254	0.05	0.1042	\$847.14	
3	2018	0.1583	3,503	\$554	457	\$72	4,171	\$660	8,131	\$1,287	0.05	0.1083	\$880.51	
4	2019	0.1625	3,503	\$569	457	\$74	4,171	\$678	8,131	\$1,322	0.05	0.1125	\$915.05	
5	2020	0.1668	3,503	\$584	457	\$76	4,171	\$696	8,131	\$1,356	0.05	0.1168	\$949.59	
6	2021	0.1621	3,503	\$568	457	\$74	4,171	\$676	8,131	\$1,318	0.05	0.1121	\$911.83	
7	2022	0.1629	3,503	\$571	457	\$74	4,171	\$680	8,131	\$1,325	0.05	0.1129	\$918.27	
8	2023	0.1639	3,503	\$574	457	\$75	4,171	\$684	8,131	\$1,332	0.05	0.1139	\$925.88	
9	2024	0.1648	3,503	\$577	457	\$75	4,171	\$687	8,131	\$1,340	0.05	0.1148	\$933.49	
10	2025	0.1656	3,503	\$580	457	\$76	4,171	\$691	8,131	\$1,346	0.05	0.1156	\$939.93	
11	2026	0.1665	3,503	\$583	457	\$76	4,171	\$695	8,131	\$1,354	0.05	0.1165	\$947.54	
12	2027	0.1674	3,503	\$587	457	\$77	4,171	\$698	8,131	\$1,361	0.05	0.1174	\$954.86	
13	2028	0.1683	3,503	\$589	457	\$77	4,171	\$702	8,131	\$1,368	0.05	0.1183	\$961.59	
14	2029	0.1692	3,503	\$593	457	\$77	4,171	\$706	8,131	\$1,375	0.05	0.1192	\$968.91	
15	2030	0.1701	3,503	\$596	457	\$78	4,171	\$709	8,131	\$1,383	0.05	0.1201	\$976.52	
16	2031	0.1704	3,503	\$597	457	\$78	4,171	\$711	8,131	\$1,385	0.05	0.1204	\$978.57	
17	2032	0.1705	3,503	\$597	457	\$78	4,171	\$711	8,131	\$1,386	0.05	0.1205	\$979.74	
18	2033	0.1707	3,503	\$598	457	\$78	4,171	\$712	8,131	\$1,388	0.05	0.1207	\$981.79	
19	2034	0.1710	3,503	\$599	457	\$78	4,171	\$713	8,131	\$1,391	0.05	0.1210	\$984.13	
20	2035	0.1713	3,503	\$600	457	\$78	4,171	\$714	8,131	\$1,393	0.05	0.1213	\$986.18	
21	2036	0.1714	3,503	\$601	457	\$78	4,171	\$715	8,131	\$1,394	0.05	0.1214	\$987.35	
22	2037	0.1717	3,503	\$601	457	\$78	4,171	\$716	8,131	\$1,396	0.05	0.1217	\$989.40	
23	2038	0.1720	3,503	\$602	457	\$79	4,171	\$717	8,131	\$1,398	0.05	0.1220	\$991.74	
24	2039	0.1722	3,503	\$603	457	\$79	4,171	\$718	8,131	\$1,400	0.05	0.1222	\$993.79	
25	2040	0.1724	3,503	\$604	457	\$79	4,171	\$719	8,131	\$1,402	0.05	0.1224	\$994.96	
26	2041	0.1734	3,503	\$607	457	\$79	4,171	\$723	8,131	\$1,410	0.05	0.1234	\$1,003.07	
27	2042	0.1744	3,503	\$611	457	\$80	4,171	\$727	8,131	\$1,418	0.05	0.1244	\$1,011.23	
28	2043	0.1754	3,503	\$614	457	\$80	4,171	\$731	8,131	\$1,426	0.05	0.1254	\$1,019.43	
29	2044	0.1764	3,503	\$618	457	\$81	4,171	\$736	8,131	\$1,434	0.05	0.1264	\$1,027.68	
30	2045	0.1774	3,503	\$621	457	\$81	4,171	\$740	8,131	\$1,443	0.05	0.1274	\$1,035.97	
31	2046	0.1784	3,503	\$625	457	\$82	4,171	\$744	8,131	\$1,451	0.05	0.1284	\$1,044.32	
32	2047	0.1795	3,503	\$629	457	\$82	4,171	\$749	8,131	\$1,459	0.05	0.1295	\$1,052.71	
33	2048	0.1805	3,503	\$632	457	\$82	4,171	\$753	8,131	\$1,468	0.05	0.1305	\$1,061.15	
34	2049	0.1816	3,503	\$636	457	\$83	4,171	\$757	8,131	\$1,476	0.05	0.1316	\$1,069.64	
35	2050	0.1826	3,503	\$640	457	\$83	4,171	\$762	8,131	\$1,485	0.05	0.1326	\$1,078.18	
36	2051	0.1837	3,503	\$643	457	\$84	4,171	\$766	8,131	\$1,493	0.05	0.1337	\$1,086.77	
37	2052	0.1847	3,503	\$647	457	\$84	4,171	\$770	8,131	\$1,502	0.05	0.1347	\$1,095.41	
38	2053	0.1858	3,503	\$651	457	\$85	4,171	\$775	8,131	\$1,511	0.05	0.1358	\$1,104.10	
39	2054	0.1869	3,503	\$655	457	\$85	4,171	\$779	8,131	\$1,519	0.05	0.1369	\$1,112.84	
40	2055	0.1879	3,503	\$658	457	\$86	4,171	\$784	8,131	\$1,528	0.05	0.1379	\$1,121.63	
41	2056	0.1890	3,503	\$662	457	\$86	4,171	\$788	8,131	\$1,537	0.05	0.1390	\$1,130.47	
42	2057	0.1901	3,503	\$666	457	\$87	4,171	\$793	8,131	\$1,546	0.05	0.1401	\$1,139.36	
43	2058	0.1912	3,503	\$670	457	\$87	4,171	\$798	8,131	\$1,555	0.05	0.1412	\$1,148.30	
44	2059	0.1923	3,503	\$674	457	\$88	4,171	\$802	8,131	\$1,564	0.05	0.1423	\$1,157.30	
45	2060	0.1934	3,503	\$678	457	\$88	4,171	\$807	8,131	\$1,573	0.05	0.1434	\$1,166.34	
46	2061	0.1946	3,503	\$682	457	\$89	4,171	\$812	8,131	\$1,582	0.05	0.1446	\$1,175.44	
47	2062	0.1957	3,503	\$685	457	\$89	4,171	\$816	8,131	\$1,591	0.05	0.1457	\$1,184.59	
48	2063	0.1968	3,503	\$689	457	\$90	4,171	\$821	8,131	\$1,600	0.05	0.1468	\$1,193.80	
49	2064	0.1980	3,503	\$693	457	\$90	4,171	\$826	8,131	\$1,610	0.05	0.1480	\$1,203.06	
50	2065	0.1991	3,503	\$697	457	\$91	4,171	\$830	8,131	\$1,619	0.05	0.1491	\$1,212.37	
51	2066	0.2003	3,503	\$701	457	\$92	4,171	\$835	8,131	\$1,628	0.05	0.1503	\$1,221.73	
52	2067	0.2014	3,503	\$706	457	\$92	4,171	\$840	8,131	\$1,638	0.05	0.1514	\$1,231.15	
53	2068	0.2026	3,503	\$710	457	\$93	4,171	\$845	8,131	\$1,647	0.05	0.1526	\$1,240.63	
54	2069	0.2038	3,503	\$714	457	\$93	4,171	\$850	8,131	\$1,657	0.05	0.1538	\$1,250.15	
55	2070	0.2049	3,503	\$718	457	\$94	4,171	\$855	8,131	\$1,666	0.05	0.1549	\$1,259.74	
56	2071	0.2061	3,503	\$722	457	\$94	4,171	\$860	8,131	\$1,676	0.05	0.1561	\$1,269.38	
57	2072	0.2073	3,503	\$726	457	\$95	4,171	\$865	8,131	\$1,686	0.05	0.1573	\$1,279.07	
58	2073	0.2085	3,503	\$730	457	\$95	4,171	\$870	8,131	\$1,695	0.05	0.1585	\$1,288.82	
59	2074	0.2097	3,503	\$735	457	\$96	4,171	\$875	8,131	\$1,705	0.05	0.1597	\$1,298.63	
60	2075	0.2109	3,503	\$739	457	\$96	4,171	\$880	8,131	\$1,715	0.05	0.1609	\$1,308.49	

Table D2-1.35: Annual Operating Costs (H.GSHP) of a 2,000 square feet detached house above grade (improved construction type) in the city of Saint Catharines (two life cycles and three life cycles for a 60 year project lifespan); base case scenario in comparison with feed in-tariff (FIT) scenario. In the FIT scenario, an incentive of \$0.05/KWh is provided on electricity bills throughout the project lifespan

Traditional HVAC Applications

Base Case Scenario														Carbon Taxes												
#	Year	Electricity Rates	Natural Gas Rates	Traditional								Total	Total	Total Electricity Operating Cost	Total Natural Gas Operating Cost	Total	Carbon Taxes									
				Heating		Heating Operating Cost	Heating Operating Cost	Total Heating Operating Cost	Cooling		Hot Water						Hot Water Operating Cost	Total	Total	Total Electricity Operating Cost	Total Natural Gas Operating Cost	Total	Conversion of m ³ into Tons	Total Tons	Carbon Tax	Operating Costs
				KWh (Electricity)	m ³ (Gas)				\$ (Electricity)	\$ (Gas)																
1	2016	0.1501	0.3458	1,785	1,746	\$268	\$604	\$872	2,039	\$306	\$934	\$330	3,824	2,701	574	\$934	\$1,508	4.89	4.89	\$10	\$48.89	\$1,556.89				
2	2017	0.1542	0.3588	1,785	1,746	\$275	\$627	\$902	2,039	\$314	955	\$147	3,824	2,701	590	\$969	\$1,559	4.89	4.89	\$20	\$97.78	\$1,656.61				
3	2018	0.1583	0.3718	1,785	1,746	\$283	\$649	\$932	2,039	\$323	955	\$151	3,824	2,701	605	\$1,004	\$1,610	4.89	4.89	\$30	\$146.66	\$1,756.32				
4	2019	0.1625	0.3776	1,785	1,746	\$290	\$659	\$949	2,039	\$331	955	\$155	3,824	2,701	622	\$1,020	\$1,641	4.89	4.89	\$40	\$195.55	\$1,836.95				
5	2020	0.1668	0.3841	1,785	1,746	\$298	\$671	\$968	2,039	\$340	955	\$159	3,824	2,701	638	\$1,037	\$1,675	4.89	4.89	\$50	\$244.44	\$1,919.65				
6	2021	0.1621	0.3883	1,785	1,746	\$289	\$678	\$967	2,039	\$331	955	\$155	3,824	2,701	620	\$1,049	\$1,669	4.89	4.89	\$60	\$293.33	\$1,962.14				
7	2022	0.1629	0.3929	1,785	1,746	\$291	\$686	\$977	2,039	\$332	955	\$156	3,824	2,701	623	\$1,061	\$1,684	4.89	4.89	\$70	\$342.22	\$2,026.46				
8	2023	0.1639	0.3967	1,785	1,746	\$293	\$693	\$985	2,039	\$334	955	\$156	3,824	2,701	627	\$1,072	\$1,698	4.89	4.89	\$80	\$391.10	\$2,089.26				
9	2024	0.1648	0.4005	1,785	1,746	\$294	\$699	\$994	2,039	\$336	955	\$157	3,824	2,701	630	\$1,082	\$1,712	4.89	4.89	\$90	\$439.99	\$2,152.06				
10	2025	0.1656	0.4040	1,785	1,746	\$296	\$705	\$1,001	2,039	\$338	955	\$158	3,824	2,701	633	\$1,091	\$1,724	4.89	4.89	\$100	\$488.88	\$2,213.28				
11	2026	0.1665	0.4070	1,785	1,746	\$297	\$711	\$1,008	2,039	\$340	955	\$159	3,824	2,701	637	\$1,099	\$1,736	4.89	4.89	\$110	\$537.77	\$2,274.01				
12	2027	0.1674	0.4097	1,785	1,746	\$299	\$715	\$1,014	2,039	\$341	955	\$159	3,824	2,701	640	\$1,107	\$1,747	4.89	4.89	\$120	\$586.66	\$2,333.57				
13	2028	0.1683	0.4124	1,785	1,746	\$300	\$720	\$1,020	2,039	\$343	955	\$161	3,824	2,701	643	\$1,114	\$1,757	4.89	4.89	\$130	\$635.55	\$2,392.86				
14	2029	0.1692	0.4151	1,785	1,746	\$302	\$725	\$1,027	2,039	\$345	955	\$162	3,824	2,701	647	\$1,121	\$1,768	4.89	4.89	\$140	\$684.43	\$2,452.42				
15	2030	0.1701	0.4170	1,785	1,746	\$304	\$728	\$1,032	2,039	\$347	955	\$162	3,824	2,701	650	\$1,126	\$1,777	4.89	4.89	\$150	\$733.32	\$2,510.06				
16	2031	0.1704	0.4189	1,785	1,746	\$304	\$731	\$1,035	2,039	\$347	955	\$163	3,824	2,701	651	\$1,131	\$1,783	4.89	4.89	\$160	\$782.21	\$2,565.07				
17	2032	0.1705	0.4204	1,785	1,746	\$304	\$734	\$1,038	2,039	\$348	955	\$163	3,824	2,701	652	\$1,136	\$1,788	4.89	4.89	\$170	\$831.10	\$2,618.65				
18	2033	0.1707	0.4223	1,785	1,746	\$305	\$737	\$1,042	2,039	\$348	955	\$163	3,824	2,701	653	\$1,141	\$1,794	4.89	4.89	\$180	\$879.99	\$2,673.66				
19	2034	0.1710	0.4246	1,785	1,746	\$305	\$741	\$1,047	2,039	\$349	955	\$163	3,824	2,701	654	\$1,147	\$1,801	4.89	4.89	\$190	\$928.87	\$2,729.85				
20	2035	0.1713	0.4265	1,785	1,746	\$306	\$745	\$1,051	2,039	\$349	955	\$164	3,824	2,701	655	\$1,152	\$1,807	4.89	4.89	\$200	\$977.76	\$2,784.87				
21	2036	0.1714	0.4288	1,785	1,746	\$306	\$749	\$1,055	2,039	\$350	955	\$164	3,824	2,701	656	\$1,158	\$1,814	4.89	4.89	\$210	\$1,026.65	\$2,840.51				
22	2037	0.1717	0.4311	1,785	1,746	\$306	\$753	\$1,059	2,039	\$350	955	\$164	3,824	2,701	657	\$1,165	\$1,821	4.89	4.89	\$220	\$1,075.54	\$2,896.56				
23	2038	0.1720	0.4331	1,785	1,746	\$307	\$756	\$1,063	2,039	\$351	955	\$164	3,824	2,701	658	\$1,170	\$1,827	4.89	4.89	\$230	\$1,124.43	\$2,951.72				
24	2039	0.1722	0.4353	1,785	1,746	\$307	\$760	\$1,068	2,039	\$351	955	\$164	3,824	2,701	659	\$1,176	\$1,834	4.89	4.89	\$240	\$1,173.31	\$3,007.77				
25	2040	0.1724	0.4376	1,785	1,746	\$308	\$764	\$1,072	2,039	\$351	955	\$165	3,824	2,701	659	\$1,182	\$1,841	4.89	4.89	\$250	\$1,222.20	\$3,063.41				
26	2041	0.1734	0.4420	1,785	1,746	\$309	\$772	\$1,081	2,039	\$353	955	\$166	3,824	2,701	663	\$1,194	\$1,857	4.89	4.89	\$260	\$1,271.09	\$3,127.76				
27	2042	0.1744	0.4463	1,785	1,746	\$311	\$779	\$1,091	2,039	\$356	955	\$167	3,824	2,701	667	\$1,205	\$1,872	4.89	4.89	\$270	\$1,319.98	\$3,192.25				
28	2043	0.1754	0.4507	1,785	1,746	\$313	\$787	\$1,100	2,039	\$358	955	\$167	3,824	2,701	671	\$1,217	\$1,888	4.89	4.89	\$280	\$1,368.87	\$3,256.88				
29	2044	0.1764	0.4552	1,785	1,746	\$315	\$795	\$1,110	2,039	\$360	955	\$168	3,824	2,701	675	\$1,229	\$1,904	4.89	4.89	\$290	\$1,417.75	\$3,321.65				
30	2045	0.1774	0.4596	1,785	1,746	\$317	\$803	\$1,119	2,039	\$362	955	\$169	3,824	2,701	678	\$1,242	\$1,920	4.89	4.89	\$300	\$1,466.64	\$3,386.57				
31	2046	0.1784	0.4642	1,785	1,746	\$319	\$810	\$1,129	2,039	\$364	955	\$170	3,824	2,701	682	\$1,254	\$1,936	4.89	4.89	\$310	\$1,515.53	\$3,451.62				
32	2047	0.1795	0.4688	1,785	1,746	\$320	\$818	\$1,139	2,039	\$366	955	\$171	3,824	2,701	686	\$1,266	\$1,952	4.89	4.89	\$320	\$1,564.42	\$3,516.81				
33	2048	0.1805	0.4734	1,785	1,746	\$322	\$827	\$1,149	2,039	\$368	955	\$172	3,824	2,701	690	\$1,279	\$1,969	4.89	4.89	\$330	\$1,613.31	\$3,582.15				
34	2049	0.1816	0.4780	1,785	1,746	\$324	\$835	\$1,159	2,039	\$370	955	\$173	3,824	2,701	694	\$1,291	\$1,985	4.89	4.89	\$340	\$1,662.20	\$3,647.64				
35	2050	0.1826	0.4828	1,785	1,746	\$326	\$843	\$1,169	2,039	\$372	955	\$174	3,824	2,701	698	\$1,304	\$2,002	4.89	4.89	\$350	\$1,711.08	\$3,713.28				
36	2051	0.1837	0.4875	1,785	1,746	\$328	\$851	\$1,179	2,039	\$374	955	\$175	3,824	2,701	702	\$1,317	\$2,019	4.89	4.89	\$360	\$1,759.97	\$3,779.06				
37	2052	0.1847	0.4923	1,785	1,746	\$330	\$860	\$1,189	2,039	\$377	955	\$176	3,824	2,701	706	\$1,330	\$2,036	4.89	4.89	\$370	\$1,808.86	\$3,844.99				
38	2053	0.1858	0.4972	1,785	1,746	\$332	\$868	\$1,200	2,039	\$379	955	\$177	3,824	2,701	710	\$1,343	\$2,053	4.89	4.89	\$380	\$1,857.75	\$3,911.08				
39	2054	0.1869	0.5021	1,785	1,746	\$334	\$877	\$1,210	2,039	\$381	955	\$178	3,824	2,701	715	\$1,356	\$2,071	4.89	4.89	\$390	\$1,906.64	\$3,977.31				
40	2055	0.1879	0.5070	1,785	1,746	\$335	\$885	\$1,221	2,039	\$383	955	\$179	3,824	2,701	719	\$1,369	\$2,088	4.89	4.89	\$400	\$1,955.52	\$4,043.70				
41	2056	0.1890	0.5120	1,785	1,746	\$337	\$894	\$1,231	2,039	\$385	955	\$181	3,824	2,701	723	\$1,383	\$2,106	4.89	4.89	\$410	\$2,004.41	\$4,110.25				
42	2057	0.1901	0.5171	1,785	1,746	\$339	\$903	\$1,242	2,039	\$388	955	\$182	3,824	2,701	727	\$1,397	\$2,124	4.89	4.89	\$420	\$2,053.30	\$4,176.96				
43	2058	0.1912	0.5222	1,785	1,746	\$341	\$912	\$1,253	2,039	\$390	955	\$183	3,824	2,701	731	\$1,410	\$2,142	4.89	4.89	\$430	\$2,102.19	\$4,243.82				
44	2059	0.1923	0.5273	1,785	1,746	\$343	\$921	\$1,264	2,039	\$392	955	\$184	3,824	2,701	735	\$1,424	\$2,160	4.89	4.89	\$440	\$2,151.08	\$4,310.84				
45	2060	0.1934	0.5325	1,785	1,746	\$345	\$930	\$1,275	2,039	\$394	955	\$185	3,824	2,701	740	\$1,438	\$2,178	4.89	4.89	\$450	\$2,199.96	\$4,378.03				
46	2061	0.1946	0.5378	1,785	1,746	\$347	\$939	\$1,286	2,039	\$397	955	\$186	3,824	2,701	744	\$1,453	\$2,197	4.89	4.89	\$460	\$2,248.85	\$4,445.38				
47	2062	0.1957	0.5431	1,785	1,746	\$349	\$948	\$1,298	2,039	\$399	955	\$187	3,824	2,701	748	\$1,467	\$2,215	4.89	4.89	\$470	\$2,297.74	\$4,512.89				
48	2063	0.1968	0.5484	1,785	1,746	\$351	\$958	\$1,309	2,039	\$401	955	\$188	3,824	2,701	753	\$1,481	\$2,234	4.89	4.89	\$480	\$2,346.63	\$4,580.57				
49	2064	0.1980	0.5538	1,785	1,746	\$353	\$967	\$1,320	2,039	\$404	955	\$189	3,824	2,701	757	\$1,496	\$2,253	4.89	4.89	\$490	\$2,395.52	\$4,648.41				
50	2065	0.1991	0.5593	1,785	1,746	\$355	\$977	\$1,332	2,039	\$406	955	\$190	3,824	2,701	761	\$1,511	\$2,272	4.89	4.89	\$500	\$2,444.41	\$4,716.43				
51	2066	0.2003	0.5648	1,785	1,746	\$357	\$986	\$1,344	2,039	\$408	955	\$191	3,824	2,701	766	\$1,526	\$2,291	4.89	4.89	\$510	\$2,493.29	\$4,784.61				
52	2067	0.2014	0.5704	1,785	1,746	\$360	\$996	\$1,355	2,039	\$411	955	\$192	3,824	2,701	770	\$1,541	\$2,311	4.89	4.89	\$520	\$2,542.18	\$4,852.97				
53	2068	0.2026	0.5760	1,785	1,746	\$362	\$1,006	\$1,367	2,039	\$413	955	\$193	3,824	2,701	775	\$1,556	\$2,330	4.89	4.89	\$530	\$2,591.07	\$4,921.50				
54	2069	0.2038	0.5817	1,785	1,746	\$364	\$																			

13. Toronto (South) – Annual Operating Costs

Vertical Ground Source Heat Pump (V.GSHP)

Base Case Scenario											Feed in Tariff (FIT)		
#	Year	V.GSHP									FIT		
		Electricity Rates \$/KWh	Heating KWh	Heating Operating Cost \$	Cooling KWh	Cooling Operating Cost \$	Hot Water KWh	Hot Water Operating Cost \$	Total KWh	Total Operating Cost \$	Incentives (\$/KWh)	\$/KWh	Operating Cost
1	2016	0.1501	4,185	\$628	279	\$42	4,737	\$711	9,201	\$1,381	0.05	0.1001	\$920.86
2	2017	0.1542	4,185	\$645	279	\$43	4,737	\$730	9,201	\$1,419	0.05	0.1042	\$958.62
3	2018	0.1583	4,185	\$662	279	\$44	4,737	\$750	9,201	\$1,456	0.05	0.1083	\$996.38
4	2019	0.1625	4,185	\$680	279	\$45	4,737	\$770	9,201	\$1,496	0.05	0.1125	\$1,035.47
5	2020	0.1668	4,185	\$698	279	\$47	4,737	\$790	9,201	\$1,535	0.05	0.1168	\$1,074.55
6	2021	0.1621	4,185	\$679	279	\$45	4,737	\$768	9,201	\$1,492	0.05	0.1121	\$1,031.83
7	2022	0.1629	4,185	\$682	279	\$45	4,737	\$772	9,201	\$1,499	0.05	0.1129	\$1,039.11
8	2023	0.1639	4,185	\$686	279	\$46	4,737	\$776	9,201	\$1,508	0.05	0.1139	\$1,047.72
9	2024	0.1648	4,185	\$690	279	\$46	4,737	\$781	9,201	\$1,516	0.05	0.1148	\$1,056.34
10	2025	0.1656	4,185	\$693	279	\$46	4,737	\$784	9,201	\$1,524	0.05	0.1156	\$1,063.62
11	2026	0.1665	4,185	\$697	279	\$46	4,737	\$789	9,201	\$1,532	0.05	0.1165	\$1,072.24
12	2027	0.1674	4,185	\$701	279	\$47	4,737	\$793	9,201	\$1,541	0.05	0.1174	\$1,080.52
13	2028	0.1683	4,185	\$704	279	\$47	4,737	\$797	9,201	\$1,548	0.05	0.1183	\$1,088.13
14	2029	0.1692	4,185	\$708	279	\$47	4,737	\$801	9,201	\$1,556	0.05	0.1192	\$1,096.42
15	2030	0.1701	4,185	\$712	279	\$47	4,737	\$806	9,201	\$1,565	0.05	0.1201	\$1,105.03
16	2031	0.1704	4,185	\$713	279	\$48	4,737	\$807	9,201	\$1,567	0.05	0.1204	\$1,107.35
17	2032	0.1705	4,185	\$714	279	\$48	4,737	\$808	9,201	\$1,569	0.05	0.1205	\$1,108.67
18	2033	0.1707	4,185	\$715	279	\$48	4,737	\$809	9,201	\$1,571	0.05	0.1207	\$1,110.99
19	2034	0.1710	4,185	\$716	279	\$48	4,737	\$810	9,201	\$1,574	0.05	0.1210	\$1,113.64
20	2035	0.1713	4,185	\$717	279	\$48	4,737	\$811	9,201	\$1,576	0.05	0.1213	\$1,115.96
21	2036	0.1714	4,185	\$717	279	\$48	4,737	\$812	9,201	\$1,577	0.05	0.1214	\$1,117.28
22	2037	0.1717	4,185	\$718	279	\$48	4,737	\$813	9,201	\$1,580	0.05	0.1217	\$1,119.60
23	2038	0.1720	4,185	\$720	279	\$48	4,737	\$815	9,201	\$1,582	0.05	0.1220	\$1,122.25
24	2039	0.1722	4,185	\$721	279	\$48	4,737	\$816	9,201	\$1,585	0.05	0.1222	\$1,124.57
25	2040	0.1724	4,185	\$721	279	\$48	4,737	\$817	9,201	\$1,586	0.05	0.1224	\$1,125.90
26	2041	0.1734	4,185	\$726	279	\$48	4,737	\$821	9,201	\$1,595	0.05	0.1234	\$1,135.07
27	2042	0.1744	4,185	\$730	279	\$49	4,737	\$826	9,201	\$1,604	0.05	0.1244	\$1,144.30
28	2043	0.1754	4,185	\$734	279	\$49	4,737	\$831	9,201	\$1,614	0.05	0.1254	\$1,153.58
29	2044	0.1764	4,185	\$738	279	\$49	4,737	\$836	9,201	\$1,623	0.05	0.1264	\$1,162.91
30	2045	0.1774	4,185	\$742	279	\$49	4,737	\$840	9,201	\$1,632	0.05	0.1274	\$1,172.30
31	2046	0.1784	4,185	\$747	279	\$50	4,737	\$845	9,201	\$1,642	0.05	0.1284	\$1,181.74
32	2047	0.1795	4,185	\$751	279	\$50	4,737	\$850	9,201	\$1,651	0.05	0.1295	\$1,191.24
33	2048	0.1805	4,185	\$755	279	\$50	4,737	\$855	9,201	\$1,661	0.05	0.1305	\$1,200.79
34	2049	0.1816	4,185	\$760	279	\$51	4,737	\$860	9,201	\$1,670	0.05	0.1316	\$1,210.40
35	2050	0.1826	4,185	\$764	279	\$51	4,737	\$865	9,201	\$1,680	0.05	0.1326	\$1,220.07
36	2051	0.1837	4,185	\$769	279	\$51	4,737	\$870	9,201	\$1,690	0.05	0.1337	\$1,229.78
37	2052	0.1847	4,185	\$773	279	\$52	4,737	\$875	9,201	\$1,700	0.05	0.1347	\$1,239.56
38	2053	0.1858	4,185	\$778	279	\$52	4,737	\$880	9,201	\$1,709	0.05	0.1358	\$1,249.39
39	2054	0.1869	4,185	\$782	279	\$52	4,737	\$885	9,201	\$1,719	0.05	0.1369	\$1,259.28
40	2055	0.1879	4,185	\$787	279	\$52	4,737	\$890	9,201	\$1,729	0.05	0.1379	\$1,269.23
41	2056	0.1890	4,185	\$791	279	\$53	4,737	\$895	9,201	\$1,739	0.05	0.1390	\$1,279.23
42	2057	0.1901	4,185	\$796	279	\$53	4,737	\$901	9,201	\$1,749	0.05	0.1401	\$1,289.29
43	2058	0.1912	4,185	\$800	279	\$53	4,737	\$906	9,201	\$1,759	0.05	0.1412	\$1,299.41
44	2059	0.1923	4,185	\$805	279	\$54	4,737	\$911	9,201	\$1,770	0.05	0.1423	\$1,309.59
45	2060	0.1934	4,185	\$810	279	\$54	4,737	\$916	9,201	\$1,780	0.05	0.1434	\$1,319.83
46	2061	0.1946	4,185	\$814	279	\$54	4,737	\$922	9,201	\$1,790	0.05	0.1446	\$1,330.12
47	2062	0.1957	4,185	\$819	279	\$55	4,737	\$927	9,201	\$1,801	0.05	0.1457	\$1,340.48
48	2063	0.1968	4,185	\$824	279	\$55	4,737	\$932	9,201	\$1,811	0.05	0.1468	\$1,350.90
49	2064	0.1980	4,185	\$828	279	\$55	4,737	\$938	9,201	\$1,821	0.05	0.1480	\$1,361.37
50	2065	0.1991	4,185	\$833	279	\$56	4,737	\$943	9,201	\$1,832	0.05	0.1491	\$1,371.91
51	2066	0.2003	4,185	\$838	279	\$56	4,737	\$949	9,201	\$1,843	0.05	0.1503	\$1,382.51
52	2067	0.2014	4,185	\$843	279	\$56	4,737	\$954	9,201	\$1,853	0.05	0.1514	\$1,393.16
53	2068	0.2026	4,185	\$848	279	\$57	4,737	\$960	9,201	\$1,864	0.05	0.1526	\$1,403.89
54	2069	0.2038	4,185	\$853	279	\$57	4,737	\$965	9,201	\$1,875	0.05	0.1538	\$1,414.67
55	2070	0.2049	4,185	\$858	279	\$57	4,737	\$971	9,201	\$1,886	0.05	0.1549	\$1,425.51
56	2071	0.2061	4,185	\$863	279	\$58	4,737	\$976	9,201	\$1,896	0.05	0.1561	\$1,436.42
57	2072	0.2073	4,185	\$868	279	\$58	4,737	\$982	9,201	\$1,907	0.05	0.1573	\$1,447.39
58	2073	0.2085	4,185	\$873	279	\$58	4,737	\$988	9,201	\$1,918	0.05	0.1585	\$1,458.43
59	2074	0.2097	4,185	\$878	279	\$59	4,737	\$993	9,201	\$1,930	0.05	0.1597	\$1,469.52
60	2075	0.2109	4,185	\$883	279	\$59	4,737	\$999	9,201	\$1,941	0.05	0.1609	\$1,480.69

Table D2-1.37: Annual Operating Costs (V.GSHP) of a 2,000 square feet detached house above grade (improved construction type) in the city of Toronto (two life cycles and three life cycles for a 60 year project lifespan); base case scenario in comparison with feed-in-tariff (FIT) scenario. In the FIT scenario, an incentive of \$0.05/KWh is provided on electricity bills throughout the project lifespan

Horizontal Ground Source Heat Pump (H.GSHP)

Base Case Scenario											Feed in Tariff (FIT)		
H.GSHP											FIT		
#	Year	Electricity Rates \$/KWh	Heating KWh	Heating Operating Cost \$	Cooling KWh	Cooling Operating Cost \$	Hot Water KWh	Hot Water Operating Cost \$	Total KWh	Total Operating Cost \$	Incentives (\$/KWh)	S/KWh	Operating Cost
1	2016	0.1501	4,202	\$631	293	\$44	4,510	\$677	9,005	\$1,351	0.05	0.1001	\$901.25
2	2017	0.1542	4,202	\$648	293	\$45	4,510	\$695	9,005	\$1,388	0.05	0.1042	\$938.20
3	2018	0.1583	4,202	\$665	293	\$46	4,510	\$714	9,005	\$1,425	0.05	0.1083	\$975.16
4	2019	0.1625	4,202	\$683	293	\$48	4,510	\$733	9,005	\$1,464	0.05	0.1125	\$1,013.41
5	2020	0.1668	4,202	\$701	293	\$49	4,510	\$752	9,005	\$1,502	0.05	0.1168	\$1,051.66
6	2021	0.1621	4,202	\$681	293	\$48	4,510	\$731	9,005	\$1,460	0.05	0.1121	\$1,009.85
7	2022	0.1629	4,202	\$685	293	\$48	4,510	\$735	9,005	\$1,467	0.05	0.1129	\$1,016.98
8	2023	0.1639	4,202	\$689	293	\$48	4,510	\$739	9,005	\$1,476	0.05	0.1139	\$1,025.41
9	2024	0.1648	4,202	\$693	293	\$48	4,510	\$743	9,005	\$1,484	0.05	0.1148	\$1,033.83
10	2025	0.1656	4,202	\$696	293	\$49	4,510	\$747	9,005	\$1,491	0.05	0.1156	\$1,040.97
11	2026	0.1665	4,202	\$700	293	\$49	4,510	\$751	9,005	\$1,500	0.05	0.1165	\$1,049.39
12	2027	0.1674	4,202	\$704	293	\$49	4,510	\$755	9,005	\$1,508	0.05	0.1174	\$1,057.50
13	2028	0.1683	4,202	\$707	293	\$49	4,510	\$759	9,005	\$1,515	0.05	0.1183	\$1,064.96
14	2029	0.1692	4,202	\$711	293	\$50	4,510	\$763	9,005	\$1,523	0.05	0.1192	\$1,073.06
15	2030	0.1701	4,202	\$715	293	\$50	4,510	\$767	9,005	\$1,532	0.05	0.1201	\$1,081.49
16	2031	0.1704	4,202	\$716	293	\$50	4,510	\$768	9,005	\$1,534	0.05	0.1204	\$1,083.76
17	2032	0.1705	4,202	\$716	293	\$50	4,510	\$769	9,005	\$1,535	0.05	0.1205	\$1,085.05
18	2033	0.1707	4,202	\$717	293	\$50	4,510	\$770	9,005	\$1,538	0.05	0.1207	\$1,087.32
19	2034	0.1710	4,202	\$719	293	\$50	4,510	\$771	9,005	\$1,540	0.05	0.1210	\$1,089.92
20	2035	0.1713	4,202	\$720	293	\$50	4,510	\$773	9,005	\$1,542	0.05	0.1213	\$1,092.19
21	2036	0.1714	4,202	\$720	293	\$50	4,510	\$773	9,005	\$1,544	0.05	0.1214	\$1,093.48
22	2037	0.1717	4,202	\$721	293	\$50	4,510	\$774	9,005	\$1,546	0.05	0.1217	\$1,095.75
23	2038	0.1720	4,202	\$723	293	\$50	4,510	\$776	9,005	\$1,549	0.05	0.1220	\$1,098.35
24	2039	0.1722	4,202	\$724	293	\$50	4,510	\$777	9,005	\$1,551	0.05	0.1222	\$1,100.61
25	2040	0.1724	4,202	\$724	293	\$51	4,510	\$777	9,005	\$1,552	0.05	0.1224	\$1,101.91
26	2041	0.1734	4,202	\$728	293	\$51	4,510	\$782	9,005	\$1,561	0.05	0.1234	\$1,110.89
27	2042	0.1744	4,202	\$733	293	\$51	4,510	\$786	9,005	\$1,570	0.05	0.1244	\$1,119.92
28	2043	0.1754	4,202	\$737	293	\$51	4,510	\$791	9,005	\$1,579	0.05	0.1254	\$1,129.00
29	2044	0.1764	4,202	\$741	293	\$52	4,510	\$796	9,005	\$1,588	0.05	0.1264	\$1,138.14
30	2045	0.1774	4,202	\$745	293	\$52	4,510	\$800	9,005	\$1,598	0.05	0.1274	\$1,147.33
31	2046	0.1784	4,202	\$750	293	\$52	4,510	\$805	9,005	\$1,607	0.05	0.1284	\$1,156.57
32	2047	0.1795	4,202	\$754	293	\$53	4,510	\$809	9,005	\$1,616	0.05	0.1295	\$1,165.87
33	2048	0.1805	4,202	\$758	293	\$53	4,510	\$814	9,005	\$1,625	0.05	0.1305	\$1,175.22
34	2049	0.1816	4,202	\$763	293	\$53	4,510	\$819	9,005	\$1,635	0.05	0.1316	\$1,184.62
35	2050	0.1826	4,202	\$767	293	\$54	4,510	\$824	9,005	\$1,644	0.05	0.1326	\$1,194.08
36	2051	0.1837	4,202	\$772	293	\$54	4,510	\$828	9,005	\$1,654	0.05	0.1337	\$1,203.59
37	2052	0.1847	4,202	\$776	293	\$54	4,510	\$833	9,005	\$1,663	0.05	0.1347	\$1,213.16
38	2053	0.1858	4,202	\$781	293	\$54	4,510	\$838	9,005	\$1,673	0.05	0.1358	\$1,222.78
39	2054	0.1869	4,202	\$785	293	\$55	4,510	\$843	9,005	\$1,683	0.05	0.1369	\$1,232.46
40	2055	0.1879	4,202	\$790	293	\$55	4,510	\$848	9,005	\$1,692	0.05	0.1379	\$1,242.19
41	2056	0.1890	4,202	\$794	293	\$55	4,510	\$853	9,005	\$1,702	0.05	0.1390	\$1,251.98
42	2057	0.1901	4,202	\$799	293	\$56	4,510	\$857	9,005	\$1,712	0.05	0.1401	\$1,261.83
43	2058	0.1912	4,202	\$804	293	\$56	4,510	\$862	9,005	\$1,722	0.05	0.1412	\$1,271.73
44	2059	0.1923	4,202	\$808	293	\$56	4,510	\$867	9,005	\$1,732	0.05	0.1423	\$1,281.69
45	2060	0.1934	4,202	\$813	293	\$57	4,510	\$872	9,005	\$1,742	0.05	0.1434	\$1,291.71
46	2061	0.1946	4,202	\$818	293	\$57	4,510	\$877	9,005	\$1,752	0.05	0.1446	\$1,301.79
47	2062	0.1957	4,202	\$822	293	\$57	4,510	\$883	9,005	\$1,762	0.05	0.1457	\$1,311.92
48	2063	0.1968	4,202	\$827	293	\$58	4,510	\$888	9,005	\$1,772	0.05	0.1468	\$1,322.12
49	2064	0.1980	4,202	\$832	293	\$58	4,510	\$893	9,005	\$1,783	0.05	0.1480	\$1,332.37
50	2065	0.1991	4,202	\$837	293	\$58	4,510	\$898	9,005	\$1,793	0.05	0.1491	\$1,342.68
51	2066	0.2003	4,202	\$841	293	\$59	4,510	\$903	9,005	\$1,803	0.05	0.1503	\$1,353.06
52	2067	0.2014	4,202	\$846	293	\$59	4,510	\$908	9,005	\$1,814	0.05	0.1514	\$1,363.49
53	2068	0.2026	4,202	\$851	293	\$59	4,510	\$914	9,005	\$1,824	0.05	0.1526	\$1,373.98
54	2069	0.2038	4,202	\$856	293	\$60	4,510	\$919	9,005	\$1,835	0.05	0.1538	\$1,384.53
55	2070	0.2049	4,202	\$861	293	\$60	4,510	\$924	9,005	\$1,845	0.05	0.1549	\$1,395.15
56	2071	0.2061	4,202	\$866	293	\$60	4,510	\$930	9,005	\$1,856	0.05	0.1561	\$1,405.82
57	2072	0.2073	4,202	\$871	293	\$61	4,510	\$935	9,005	\$1,867	0.05	0.1573	\$1,416.56
58	2073	0.2085	4,202	\$876	293	\$61	4,510	\$940	9,005	\$1,878	0.05	0.1585	\$1,427.36
59	2074	0.2097	4,202	\$881	293	\$61	4,510	\$946	9,005	\$1,888	0.05	0.1597	\$1,438.22
60	2075	0.2109	4,202	\$886	293	\$62	4,510	\$951	9,005	\$1,899	0.05	0.1609	\$1,449.14

Table D2-1.38: Annual Operating Costs (H.GSHP) of a 2,000 square feet detached house above grade (improved construction type) in the city of Toronto (two life cycles and three life cycles for a 60 year project lifespan); base case scenario in comparison with feed in-tariff (FIT) scenario. In the FIT scenario, an incentive of \$0.05/KWh is provided on electricity bills throughout the project lifespan

Traditional HVAC Applications

Base Case Scenario															Carbon Taxes							
#	Year	Electricity Rates	Natural Gas Rates	Heating		Heating Operating Cost	Heating Operating Cost	Total Heating Operating Cost	Cooling		Hot Water	Hot Water Operating Cost	Total	Total	Total Electricity Operating Cost	Total Natural Gas Operating Cost	Total	Conversion of m ³ into Tons	Total Tons	Carbon Tax	Operating Costs	
				KWh (Electricity)	m ³ (Gas)				KWh	Operating Cost												m ³
		\$/KWh	\$/m ³			\$(Electricity)	\$(Gas)	\$(Electricity)	\$(Gas)	\$(Electricity)	\$(Gas)	KWh	m ³	\$(KWh)	\$(m ³)				10			
1	2016	0.1501	0.3458	1,626	2,047	\$244	\$708	\$952	1,333	\$200	1,028	\$356	2,959	3,075	444	\$1,063	\$1,508	5.57	5.57	\$10	\$55.66	\$1,563.18
2	2017	0.1542	0.3588	1,626	2,047	\$251	\$735	\$985	1,333	\$206	1,028	\$359	2,959	3,075	456	\$1,103	\$1,560	5.57	5.57	\$20	\$111.32	\$1,670.98
3	2018	0.1583	0.3718	1,626	2,047	\$257	\$761	\$1,019	1,333	\$211	1,028	\$363	2,959	3,075	468	\$1,143	\$1,612	5.57	5.57	\$30	\$166.97	\$1,778.77
4	2019	0.1625	0.3776	1,626	2,047	\$264	\$773	\$1,037	1,333	\$217	1,028	\$367	2,959	3,075	481	\$1,161	\$1,642	5.57	5.57	\$40	\$222.63	\$1,864.65
5	2020	0.1668	0.3841	1,626	2,047	\$271	\$786	\$1,057	1,333	\$222	1,028	\$371	2,959	3,075	494	\$1,181	\$1,675	5.57	5.57	\$50	\$278.29	\$1,952.87
6	2021	0.1621	0.3883	1,626	2,047	\$264	\$795	\$1,058	1,333	\$216	1,028	\$367	2,959	3,075	480	\$1,194	\$1,674	5.57	5.57	\$60	\$333.95	\$2,007.73
7	2022	0.1629	0.3929	1,626	2,047	\$265	\$804	\$1,069	1,333	\$217	1,028	\$367	2,959	3,075	482	\$1,208	\$1,690	5.57	5.57	\$70	\$389.60	\$2,079.85
8	2023	0.1639	0.3967	1,626	2,047	\$266	\$812	\$1,079	1,333	\$218	1,028	\$368	2,959	3,075	485	\$1,220	\$1,705	5.57	5.57	\$80	\$445.26	\$2,150.04
9	2024	0.1648	0.4005	1,626	2,047	\$268	\$820	\$1,088	1,333	\$220	1,028	\$369	2,959	3,075	488	\$1,232	\$1,719	5.57	5.57	\$90	\$500.92	\$2,220.23
10	2025	0.1656	0.4040	1,626	2,047	\$269	\$827	\$1,096	1,333	\$221	1,028	\$370	2,959	3,075	490	\$1,242	\$1,732	5.57	5.57	\$100	\$556.58	\$2,288.82
11	2026	0.1665	0.4070	1,626	2,047	\$271	\$833	\$1,104	1,333	\$222	1,028	\$371	2,959	3,075	493	\$1,252	\$1,744	5.57	5.57	\$110	\$612.23	\$2,356.65
12	2027	0.1674	0.4097	1,626	2,047	\$272	\$839	\$1,111	1,333	\$223	1,028	\$372	2,959	3,075	495	\$1,260	\$1,755	5.57	5.57	\$120	\$667.89	\$2,423.21
13	2028	0.1683	0.4124	1,626	2,047	\$274	\$844	\$1,118	1,333	\$224	1,028	\$373	2,959	3,075	498	\$1,268	\$1,766	5.57	5.57	\$130	\$723.55	\$2,489.55
14	2029	0.1692	0.4151	1,626	2,047	\$275	\$850	\$1,125	1,333	\$225	1,028	\$374	2,959	3,075	501	\$1,276	\$1,777	5.57	5.57	\$140	\$779.21	\$2,555.11
15	2030	0.1701	0.4170	1,626	2,047	\$277	\$854	\$1,130	1,333	\$227	1,028	\$375	2,959	3,075	503	\$1,282	\$1,786	5.57	5.57	\$150	\$834.86	\$2,620.41
16	2031	0.1704	0.4189	1,626	2,047	\$277	\$857	\$1,134	1,333	\$227	1,028	\$375	2,959	3,075	504	\$1,288	\$1,792	5.57	5.57	\$160	\$890.52	\$2,682.70
17	2032	0.1705	0.4204	1,626	2,047	\$277	\$861	\$1,138	1,333	\$227	1,028	\$375	2,959	3,075	504	\$1,293	\$1,797	5.57	5.57	\$170	\$946.18	\$2,743.49
18	2033	0.1707	0.4223	1,626	2,047	\$278	\$865	\$1,142	1,333	\$228	1,028	\$376	2,959	3,075	505	\$1,299	\$1,804	5.57	5.57	\$180	\$1,001.84	\$2,805.77
19	2034	0.1710	0.4246	1,626	2,047	\$278	\$869	\$1,147	1,333	\$228	1,028	\$376	2,959	3,075	506	\$1,306	\$1,812	5.57	5.57	\$190	\$1,057.49	\$2,869.34
20	2035	0.1713	0.4265	1,626	2,047	\$279	\$873	\$1,152	1,333	\$228	1,028	\$376	2,959	3,075	507	\$1,312	\$1,818	5.57	5.57	\$200	\$1,113.15	\$2,931.63
21	2036	0.1714	0.4288	1,626	2,047	\$279	\$878	\$1,157	1,333	\$229	1,028	\$376	2,959	3,075	507	\$1,319	\$1,826	5.57	5.57	\$210	\$1,168.81	\$2,994.77
22	2037	0.1717	0.4311	1,626	2,047	\$279	\$883	\$1,162	1,333	\$229	1,028	\$376	2,959	3,075	508	\$1,326	\$1,834	5.57	5.57	\$220	\$1,224.47	\$3,058.23
23	2038	0.1720	0.4331	1,626	2,047	\$280	\$886	\$1,166	1,333	\$229	1,028	\$377	2,959	3,075	509	\$1,332	\$1,840	5.57	5.57	\$230	\$1,280.12	\$3,120.67
24	2039	0.1722	0.4353	1,626	2,047	\$280	\$891	\$1,171	1,333	\$230	1,028	\$377	2,959	3,075	510	\$1,339	\$1,848	5.57	5.57	\$240	\$1,335.78	\$3,184.08
25	2040	0.1724	0.4376	1,626	2,047	\$280	\$896	\$1,176	1,333	\$230	1,028	\$377	2,959	3,075	510	\$1,346	\$1,856	5.57	5.57	\$250	\$1,391.44	\$3,247.22
26	2041	0.1734	0.4420	1,626	2,047	\$282	\$905	\$1,187	1,333	\$231	1,028	\$378	2,959	3,075	513	\$1,359	\$1,872	5.57	5.57	\$260	\$1,447.10	\$3,319.10
27	2042	0.1744	0.4463	1,626	2,047	\$284	\$914	\$1,197	1,333	\$232	1,028	\$379	2,959	3,075	516	\$1,372	\$1,888	5.57	5.57	\$270	\$1,502.75	\$3,391.12
28	2043	0.1754	0.4507	1,626	2,047	\$285	\$923	\$1,208	1,333	\$234	1,028	\$380	2,959	3,075	519	\$1,386	\$1,905	5.57	5.57	\$280	\$1,558.41	\$3,463.30
29	2044	0.1764	0.4552	1,626	2,047	\$287	\$932	\$1,219	1,333	\$235	1,028	\$381	2,959	3,075	522	\$1,400	\$1,922	5.57	5.57	\$290	\$1,614.07	\$3,535.62
30	2045	0.1774	0.4596	1,626	2,047	\$288	\$941	\$1,229	1,333	\$236	1,028	\$382	2,959	3,075	525	\$1,413	\$1,938	5.57	5.57	\$300	\$1,669.73	\$3,608.10
31	2046	0.1784	0.4642	1,626	2,047	\$290	\$950	\$1,240	1,333	\$238	1,028	\$383	2,959	3,075	528	\$1,427	\$1,955	5.57	5.57	\$310	\$1,725.38	\$3,680.72
32	2047	0.1795	0.4688	1,626	2,047	\$292	\$960	\$1,251	1,333	\$239	1,028	\$384	2,959	3,075	531	\$1,441	\$1,972	5.57	5.57	\$320	\$1,781.04	\$3,753.51
33	2048	0.1805	0.4734	1,626	2,047	\$294	\$969	\$1,263	1,333	\$241	1,028	\$386	2,959	3,075	534	\$1,456	\$1,990	5.57	5.57	\$330	\$1,836.70	\$3,826.45
34	2049	0.1816	0.4780	1,626	2,047	\$295	\$979	\$1,274	1,333	\$242	1,028	\$387	2,959	3,075	537	\$1,470	\$2,007	5.57	5.57	\$340	\$1,892.36	\$3,899.55
35	2050	0.1826	0.4828	1,626	2,047	\$297	\$988	\$1,285	1,333	\$243	1,028	\$388	2,959	3,075	540	\$1,484	\$2,025	5.57	5.57	\$350	\$1,948.01	\$3,972.81
36	2051	0.1837	0.4875	1,626	2,047	\$299	\$998	\$1,297	1,333	\$245	1,028	\$389	2,959	3,075	543	\$1,499	\$2,043	5.57	5.57	\$360	\$2,003.67	\$4,046.22
37	2052	0.1847	0.4923	1,626	2,047	\$300	\$1,008	\$1,308	1,333	\$246	1,028	\$390	2,959	3,075	547	\$1,514	\$2,060	5.57	5.57	\$370	\$2,059.33	\$4,119.80
38	2053	0.1858	0.4972	1,626	2,047	\$302	\$1,018	\$1,320	1,333	\$248	1,028	\$391	2,959	3,075	550	\$1,529	\$2,079	5.57	5.57	\$380	\$2,114.99	\$4,193.55
39	2054	0.1869	0.5021	1,626	2,047	\$304	\$1,028	\$1,332	1,333	\$249	1,028	\$392	2,959	3,075	553	\$1,544	\$2,097	5.57	5.57	\$390	\$2,170.64	\$4,267.46
40	2055	0.1879	0.5070	1,626	2,047	\$306	\$1,038	\$1,343	1,333	\$251	1,028	\$393	2,959	3,075	556	\$1,559	\$2,115	5.57	5.57	\$400	\$2,226.30	\$4,341.54
41	2056	0.1890	0.5120	1,626	2,047	\$307	\$1,048	\$1,355	1,333	\$252	1,028	\$394	2,959	3,075	559	\$1,574	\$2,134	5.57	5.57	\$410	\$2,281.96	\$4,415.78
42	2057	0.1901	0.5171	1,626	2,047	\$309	\$1,058	\$1,368	1,333	\$253	1,028	\$395	2,959	3,075	563	\$1,590	\$2,153	5.57	5.57	\$420	\$2,337.62	\$4,490.20
43	2058	0.1912	0.5222	1,626	2,047	\$311	\$1,069	\$1,380	1,333	\$255	1,028	\$397	2,959	3,075	566	\$1,606	\$2,172	5.57	5.57	\$430	\$2,393.27	\$4,564.79
44	2059	0.1923	0.5273	1,626	2,047	\$313	\$1,079	\$1,392	1,333	\$256	1,028	\$398	2,959	3,075	569	\$1,622	\$2,191	5.57	5.57	\$440	\$2,448.93	\$4,639.55
45	2060	0.1934	0.5325	1,626	2,047	\$315	\$1,090	\$1,405	1,333	\$258	1,028	\$399	2,959	3,075	572	\$1,637	\$2,210	5.57	5.57	\$450	\$2,504.59	\$4,714.48
46	2061	0.1946	0.5378	1,626	2,047	\$316	\$1,101	\$1,417	1,333	\$259	1,028	\$400	2,959	3,075	576	\$1,654	\$2,229	5.57	5.57	\$460	\$2,560.25	\$4,789.60
47	2062	0.1957	0.5431	1,626	2,047	\$318	\$1,112	\$1,430	1,333	\$261	1,028	\$401	2,959	3,075	579	\$1,670	\$2,249	5.57	5.57	\$470	\$2,615.90	\$4,864.89
48	2063	0.1968	0.5484	1,626	2,047	\$320	\$1,123	\$1,443	1,333	\$262	1,028	\$402	2,959	3,075	582	\$1,686	\$2,269	5.57	5.57	\$480	\$2,671.56	\$4,940.36
49	2064	0.1980	0.5538	1,626	2,047	\$322	\$1,134	\$1,456	1,333	\$264	1,028	\$404	2,959	3,075	586	\$1,703	\$2,289	5.57	5.57	\$490	\$2,727.22	\$5,016.01
50	2065	0.1991	0.5593	1,626	2,047	\$324	\$1,145	\$1,469	1,333	\$265	1,028	\$405	2,959	3,075	589	\$1,720	\$2,309	5.57	5.57	\$500	\$2,782.88	\$5,091.85
51	2066	0.2003	0.5648	1,626	2,047	\$326	\$1,156	\$1,482	1,333	\$267	1,028	\$406	2,959	3,075	593	\$1,737	\$2,329	5.57	5.57	\$510	\$2,838.53	\$5,167.87
52	2067	0.2014	0.5704	1,626	2,047	\$327	\$1,168	\$1,495	1,333	\$268	1,028	\$407	2,959	3,075	596	\$1,754	\$2,350	5.57	5.57	\$520	\$2,894.19	\$5,244.08
53	2068	0.2026	0.5760	1,626	2,047	\$329	\$1,179	\$1,508	1,333	\$270												

14. Trenton (South) – Annual Operating Costs

Vertical Ground Source Heat Pump (V.GSHP)

Base Case Scenario											Feed in Tariff (FIT)			
#	Year	V.GSHP		V.GSHP		V.GSHP		V.GSHP		Total	Total Operating Cost	Incentives (\$/KWh)	FIT	
		Electricity Rates	Heating	Heating Operating Cost	Cooling	Cooling Operating Cost	Hot Water	Hot Water Operating Cost	S/KWh				Operating Cost	
		\$/KWh	KWh	\$	KWh	\$	KWh	\$	KWh	\$		S/KWh	Operating Cost	
1	2016	0.1501	4,242	\$637	258	\$39	4,790	\$719	9,290	\$1,394	0.05	0.1001	\$929.77	
2	2017	0.1542	4,242	\$654	258	\$40	4,790	\$739	9,290	\$1,432	0.05	0.1042	\$967.90	
3	2018	0.1583	4,242	\$671	258	\$41	4,790	\$758	9,290	\$1,471	0.05	0.1083	\$1,006.02	
4	2019	0.1625	4,242	\$689	258	\$42	4,790	\$779	9,290	\$1,510	0.05	0.1125	\$1,045.48	
5	2020	0.1668	4,242	\$708	258	\$43	4,790	\$799	9,290	\$1,549	0.05	0.1168	\$1,084.95	
6	2021	0.1621	4,242	\$688	258	\$42	4,790	\$777	9,290	\$1,506	0.05	0.1121	\$1,041.81	
7	2022	0.1629	4,242	\$691	258	\$42	4,790	\$780	9,290	\$1,514	0.05	0.1129	\$1,049.16	
8	2023	0.1639	4,242	\$695	258	\$42	4,790	\$785	9,290	\$1,522	0.05	0.1139	\$1,057.86	
9	2024	0.1648	4,242	\$699	258	\$43	4,790	\$789	9,290	\$1,531	0.05	0.1148	\$1,066.55	
10	2025	0.1656	4,242	\$702	258	\$43	4,790	\$793	9,290	\$1,538	0.05	0.1156	\$1,073.91	
11	2026	0.1665	4,242	\$706	258	\$43	4,790	\$798	9,290	\$1,547	0.05	0.1165	\$1,082.61	
12	2027	0.1674	4,242	\$710	258	\$43	4,790	\$802	9,290	\$1,555	0.05	0.1174	\$1,090.97	
13	2028	0.1683	4,242	\$714	258	\$43	4,790	\$806	9,290	\$1,563	0.05	0.1183	\$1,098.66	
14	2029	0.1692	4,242	\$718	258	\$44	4,790	\$810	9,290	\$1,572	0.05	0.1192	\$1,107.02	
15	2030	0.1701	4,242	\$722	258	\$44	4,790	\$815	9,290	\$1,580	0.05	0.1201	\$1,115.72	
16	2031	0.1704	4,242	\$723	258	\$44	4,790	\$816	9,290	\$1,583	0.05	0.1204	\$1,118.06	
17	2032	0.1705	4,242	\$723	258	\$44	4,790	\$817	9,290	\$1,584	0.05	0.1205	\$1,119.40	
18	2033	0.1707	4,242	\$724	258	\$44	4,790	\$818	9,290	\$1,586	0.05	0.1207	\$1,121.74	
19	2034	0.1710	4,242	\$726	258	\$44	4,790	\$819	9,290	\$1,589	0.05	0.1210	\$1,124.41	
20	2035	0.1713	4,242	\$727	258	\$44	4,790	\$820	9,290	\$1,591	0.05	0.1213	\$1,126.75	
21	2036	0.1714	4,242	\$727	258	\$44	4,790	\$821	9,290	\$1,593	0.05	0.1214	\$1,128.09	
22	2037	0.1717	4,242	\$728	258	\$44	4,790	\$822	9,290	\$1,595	0.05	0.1217	\$1,130.43	
23	2038	0.1720	4,242	\$729	258	\$44	4,790	\$824	9,290	\$1,598	0.05	0.1220	\$1,133.11	
24	2039	0.1722	4,242	\$731	258	\$44	4,790	\$825	9,290	\$1,600	0.05	0.1222	\$1,135.45	
25	2040	0.1724	4,242	\$731	258	\$44	4,790	\$826	9,290	\$1,601	0.05	0.1224	\$1,136.79	
26	2041	0.1734	4,242	\$735	258	\$45	4,790	\$830	9,290	\$1,611	0.05	0.1234	\$1,146.05	
27	2042	0.1744	4,242	\$740	258	\$45	4,790	\$835	9,290	\$1,620	0.05	0.1244	\$1,155.37	
28	2043	0.1754	4,242	\$744	258	\$45	4,790	\$840	9,290	\$1,629	0.05	0.1254	\$1,164.74	
29	2044	0.1764	4,242	\$748	258	\$46	4,790	\$845	9,290	\$1,639	0.05	0.1264	\$1,174.16	
30	2045	0.1774	4,242	\$753	258	\$46	4,790	\$850	9,290	\$1,648	0.05	0.1274	\$1,183.64	
31	2046	0.1784	4,242	\$757	258	\$46	4,790	\$855	9,290	\$1,658	0.05	0.1284	\$1,193.18	
32	2047	0.1795	4,242	\$761	258	\$46	4,790	\$860	9,290	\$1,667	0.05	0.1295	\$1,202.76	
33	2048	0.1805	4,242	\$766	258	\$47	4,790	\$865	9,290	\$1,677	0.05	0.1305	\$1,212.41	
34	2049	0.1816	4,242	\$770	258	\$47	4,790	\$870	9,290	\$1,687	0.05	0.1316	\$1,222.11	
35	2050	0.1826	4,242	\$775	258	\$47	4,790	\$875	9,290	\$1,696	0.05	0.1326	\$1,231.87	
36	2051	0.1837	4,242	\$779	258	\$47	4,790	\$880	9,290	\$1,706	0.05	0.1337	\$1,241.68	
37	2052	0.1847	4,242	\$784	258	\$48	4,790	\$885	9,290	\$1,716	0.05	0.1347	\$1,251.55	
38	2053	0.1858	4,242	\$788	258	\$48	4,790	\$890	9,290	\$1,726	0.05	0.1358	\$1,261.48	
39	2054	0.1869	4,242	\$793	258	\$48	4,790	\$895	9,290	\$1,736	0.05	0.1369	\$1,271.46	
40	2055	0.1879	4,242	\$797	258	\$48	4,790	\$900	9,290	\$1,746	0.05	0.1379	\$1,281.50	
41	2056	0.1890	4,242	\$802	258	\$49	4,790	\$905	9,290	\$1,756	0.05	0.1390	\$1,291.60	
42	2057	0.1901	4,242	\$807	258	\$49	4,790	\$911	9,290	\$1,766	0.05	0.1401	\$1,301.76	
43	2058	0.1912	4,242	\$811	258	\$49	4,790	\$916	9,290	\$1,776	0.05	0.1412	\$1,311.98	
44	2059	0.1923	4,242	\$816	258	\$50	4,790	\$921	9,290	\$1,787	0.05	0.1423	\$1,322.26	
45	2060	0.1934	4,242	\$821	258	\$50	4,790	\$927	9,290	\$1,797	0.05	0.1434	\$1,332.59	
46	2061	0.1946	4,242	\$825	258	\$50	4,790	\$932	9,290	\$1,807	0.05	0.1446	\$1,342.99	
47	2062	0.1957	4,242	\$830	258	\$50	4,790	\$937	9,290	\$1,818	0.05	0.1457	\$1,353.45	
48	2063	0.1968	4,242	\$835	258	\$51	4,790	\$943	9,290	\$1,828	0.05	0.1468	\$1,363.96	
49	2064	0.1980	4,242	\$840	258	\$51	4,790	\$948	9,290	\$1,839	0.05	0.1480	\$1,374.54	
50	2065	0.1991	4,242	\$845	258	\$51	4,790	\$954	9,290	\$1,850	0.05	0.1491	\$1,385.18	
51	2066	0.2003	4,242	\$849	258	\$52	4,790	\$959	9,290	\$1,860	0.05	0.1503	\$1,395.88	
52	2067	0.2014	4,242	\$854	258	\$52	4,790	\$965	9,290	\$1,871	0.05	0.1514	\$1,406.64	
53	2068	0.2026	4,242	\$859	258	\$52	4,790	\$970	9,290	\$1,882	0.05	0.1526	\$1,417.46	
54	2069	0.2038	4,242	\$864	258	\$53	4,790	\$976	9,290	\$1,893	0.05	0.1538	\$1,428.35	
55	2070	0.2049	4,242	\$869	258	\$53	4,790	\$982	9,290	\$1,904	0.05	0.1549	\$1,439.30	
56	2071	0.2061	4,242	\$874	258	\$53	4,790	\$987	9,290	\$1,915	0.05	0.1561	\$1,450.31	
57	2072	0.2073	4,242	\$879	258	\$53	4,790	\$993	9,290	\$1,926	0.05	0.1573	\$1,461.39	
58	2073	0.2085	4,242	\$884	258	\$54	4,790	\$999	9,290	\$1,937	0.05	0.1585	\$1,472.53	
59	2074	0.2097	4,242	\$890	258	\$54	4,790	\$1,005	9,290	\$1,948	0.05	0.1597	\$1,483.74	
60	2075	0.2109	4,242	\$895	258	\$54	4,790	\$1,010	9,290	\$1,960	0.05	0.1609	\$1,495.01	

Table D2-1.40: Annual Operating Costs (V.GSHP) of a 2,000 square feet detached house above grade (improved construction type) in the city of Trenton (two life cycles and three life cycles for a 60 year project lifespan); base case scenario in comparison with feed in-tariff (FIT) scenario. In the FIT scenario, an incentive of \$0.05/KWh is provided on electricity bills throughout the project lifespan

Horizontal Ground Source Heat Pump (H.GSHP)

Base Case Scenario											Feed in Tariff (FIT)		
H.GSHP											FIT		
#	Year	Electricity Rates \$/KWh	Heating KWh	Heating Operating Cost \$	Cooling KWh	Cooling Operating Cost \$	Hot Water KWh	Hot Water Operating Cost \$	Total KWh	Total Operating Cost \$	Incentives (\$/KWh)	S/KWh	Operating Cost
1	2016	0.1501	4,323	\$649	265	\$40	4,769	\$716	9,357	\$1,404	0.05	0.1001	\$936.47
2	2017	0.1542	4,323	\$667	265	\$41	4,769	\$735	9,357	\$1,443	0.05	0.1042	\$974.88
3	2018	0.1583	4,323	\$684	265	\$42	4,769	\$755	9,357	\$1,481	0.05	0.1083	\$1,013.28
4	2019	0.1625	4,323	\$703	265	\$43	4,769	\$775	9,357	\$1,521	0.05	0.1125	\$1,053.02
5	2020	0.1668	4,323	\$721	265	\$44	4,769	\$795	9,357	\$1,561	0.05	0.1168	\$1,092.77
6	2021	0.1621	4,323	\$701	265	\$43	4,769	\$773	9,357	\$1,517	0.05	0.1121	\$1,049.32
7	2022	0.1629	4,323	\$704	265	\$43	4,769	\$777	9,357	\$1,525	0.05	0.1129	\$1,056.73
8	2023	0.1639	4,323	\$708	265	\$43	4,769	\$781	9,357	\$1,533	0.05	0.1139	\$1,065.49
9	2024	0.1648	4,323	\$712	265	\$44	4,769	\$786	9,357	\$1,542	0.05	0.1148	\$1,074.25
10	2025	0.1656	4,323	\$716	265	\$44	4,769	\$790	9,357	\$1,550	0.05	0.1156	\$1,081.66
11	2026	0.1665	4,323	\$720	265	\$44	4,769	\$794	9,357	\$1,558	0.05	0.1165	\$1,090.41
12	2027	0.1674	4,323	\$724	265	\$44	4,769	\$798	9,357	\$1,567	0.05	0.1174	\$1,098.84
13	2028	0.1683	4,323	\$727	265	\$45	4,769	\$802	9,357	\$1,574	0.05	0.1183	\$1,106.58
14	2029	0.1692	4,323	\$731	265	\$45	4,769	\$807	9,357	\$1,583	0.05	0.1192	\$1,115.00
15	2030	0.1701	4,323	\$735	265	\$45	4,769	\$811	9,357	\$1,592	0.05	0.1201	\$1,123.76
16	2031	0.1704	4,323	\$736	265	\$45	4,769	\$812	9,357	\$1,594	0.05	0.1204	\$1,126.12
17	2032	0.1705	4,323	\$737	265	\$45	4,769	\$813	9,357	\$1,595	0.05	0.1205	\$1,127.47
18	2033	0.1707	4,323	\$738	265	\$45	4,769	\$814	9,357	\$1,598	0.05	0.1207	\$1,129.83
19	2034	0.1710	4,323	\$739	265	\$45	4,769	\$816	9,357	\$1,600	0.05	0.1210	\$1,132.52
20	2035	0.1713	4,323	\$740	265	\$45	4,769	\$817	9,357	\$1,603	0.05	0.1213	\$1,134.88
21	2036	0.1714	4,323	\$741	265	\$45	4,769	\$818	9,357	\$1,604	0.05	0.1214	\$1,136.23
22	2037	0.1717	4,323	\$742	265	\$45	4,769	\$819	9,357	\$1,606	0.05	0.1217	\$1,138.58
23	2038	0.1720	4,323	\$743	265	\$46	4,769	\$820	9,357	\$1,609	0.05	0.1220	\$1,141.28
24	2039	0.1722	4,323	\$745	265	\$46	4,769	\$821	9,357	\$1,611	0.05	0.1222	\$1,143.64
25	2040	0.1724	4,323	\$745	265	\$46	4,769	\$822	9,357	\$1,613	0.05	0.1224	\$1,144.98
26	2041	0.1734	4,323	\$749	265	\$46	4,769	\$827	9,357	\$1,622	0.05	0.1234	\$1,154.31
27	2042	0.1744	4,323	\$754	265	\$46	4,769	\$832	9,357	\$1,632	0.05	0.1244	\$1,163.70
28	2043	0.1754	4,323	\$758	265	\$46	4,769	\$836	9,357	\$1,641	0.05	0.1254	\$1,173.14
29	2044	0.1764	4,323	\$763	265	\$47	4,769	\$841	9,357	\$1,650	0.05	0.1264	\$1,182.63
30	2045	0.1774	4,323	\$767	265	\$47	4,769	\$846	9,357	\$1,660	0.05	0.1274	\$1,192.18
31	2046	0.1784	4,323	\$771	265	\$47	4,769	\$851	9,357	\$1,670	0.05	0.1284	\$1,201.78
32	2047	0.1795	4,323	\$776	265	\$48	4,769	\$856	9,357	\$1,679	0.05	0.1295	\$1,211.44
33	2048	0.1805	4,323	\$780	265	\$48	4,769	\$861	9,357	\$1,689	0.05	0.1305	\$1,221.15
34	2049	0.1816	4,323	\$785	265	\$48	4,769	\$866	9,357	\$1,699	0.05	0.1316	\$1,230.92
35	2050	0.1826	4,323	\$789	265	\$48	4,769	\$871	9,357	\$1,709	0.05	0.1326	\$1,240.75
36	2051	0.1837	4,323	\$794	265	\$49	4,769	\$876	9,357	\$1,718	0.05	0.1337	\$1,250.64
37	2052	0.1847	4,323	\$799	265	\$49	4,769	\$881	9,357	\$1,728	0.05	0.1347	\$1,260.58
38	2053	0.1858	4,323	\$803	265	\$49	4,769	\$886	9,357	\$1,738	0.05	0.1358	\$1,270.58
39	2054	0.1869	4,323	\$808	265	\$50	4,769	\$891	9,357	\$1,748	0.05	0.1369	\$1,280.63
40	2055	0.1879	4,323	\$812	265	\$50	4,769	\$896	9,357	\$1,759	0.05	0.1379	\$1,290.75
41	2056	0.1890	4,323	\$817	265	\$50	4,769	\$901	9,357	\$1,769	0.05	0.1390	\$1,300.92
42	2057	0.1901	4,323	\$822	265	\$50	4,769	\$907	9,357	\$1,779	0.05	0.1401	\$1,311.15
43	2058	0.1912	4,323	\$827	265	\$51	4,769	\$912	9,357	\$1,789	0.05	0.1412	\$1,321.44
44	2059	0.1923	4,323	\$831	265	\$51	4,769	\$917	9,357	\$1,800	0.05	0.1423	\$1,331.79
45	2060	0.1934	4,323	\$836	265	\$51	4,769	\$923	9,357	\$1,810	0.05	0.1434	\$1,342.20
46	2061	0.1946	4,323	\$841	265	\$52	4,769	\$928	9,357	\$1,821	0.05	0.1446	\$1,352.68
47	2062	0.1957	4,323	\$846	265	\$52	4,769	\$933	9,357	\$1,831	0.05	0.1457	\$1,363.21
48	2063	0.1968	4,323	\$851	265	\$52	4,769	\$939	9,357	\$1,842	0.05	0.1468	\$1,373.80
49	2064	0.1980	4,323	\$856	265	\$52	4,769	\$944	9,357	\$1,852	0.05	0.1480	\$1,384.45
50	2065	0.1991	4,323	\$861	265	\$53	4,769	\$950	9,357	\$1,863	0.05	0.1491	\$1,395.17
51	2066	0.2003	4,323	\$866	265	\$53	4,769	\$955	9,357	\$1,874	0.05	0.1503	\$1,405.95
52	2067	0.2014	4,323	\$871	265	\$53	4,769	\$961	9,357	\$1,885	0.05	0.1514	\$1,416.79
53	2068	0.2026	4,323	\$876	265	\$54	4,769	\$966	9,357	\$1,896	0.05	0.1526	\$1,427.69
54	2069	0.2038	4,323	\$881	265	\$54	4,769	\$972	9,357	\$1,907	0.05	0.1538	\$1,438.65
55	2070	0.2049	4,323	\$886	265	\$54	4,769	\$977	9,357	\$1,918	0.05	0.1549	\$1,449.68
56	2071	0.2061	4,323	\$891	265	\$55	4,769	\$983	9,357	\$1,929	0.05	0.1561	\$1,460.77
57	2072	0.2073	4,323	\$896	265	\$55	4,769	\$989	9,357	\$1,940	0.05	0.1573	\$1,471.93
58	2073	0.2085	4,323	\$901	265	\$55	4,769	\$994	9,357	\$1,951	0.05	0.1585	\$1,483.15
59	2074	0.2097	4,323	\$907	265	\$56	4,769	\$1,000	9,357	\$1,962	0.05	0.1597	\$1,494.44
60	2075	0.2109	4,323	\$912	265	\$56	4,769	\$1,006	9,357	\$1,974	0.05	0.1609	\$1,505.79

Table D2-1.41: Annual Operating Costs (H.GSHP) of a 2,000 square feet detached house above grade (improved construction type) in the city of Trenton (two life cycles and three life cycles for a 60 year project lifespan); base case scenario in comparison with feed-in-tariff (FIT) scenario. In the FIT scenario, an incentive of \$0.05/KWh is provided on electricity bills throughout the project lifespan

Traditional HVAC Applications

Base Case Scenario															Carbon Taxes							
#	Year	Traditional													Carbon Taxes							
		Electricity Rates \$/KWh	Natural Gas Rates \$/m ³	Heating		Heating Operating Cost \$ (Electricity)	Heating Operating Cost \$ (Gas)	Total Heating Operating Cost \$	Cooling		Hot Water m ³	Hot Water Operating Cost \$	Total KWh	Total m ³	Total Electricity Operating Cost \$ (KWh)	Total Natural Gas Operating Cost \$ (m ³)	Total	Conversion of m ³ into Tons	Total Tons	Carbon Tax	Operating Costs	
				KWh (Electricity)	m ³ (Gas)				KWh	\$												\$
1	2016	0.1501	0.3458	1,857	2,062	\$279	\$713	\$992	1,383	\$208	1,033	\$357	3,240	3,095	486	\$1,070	\$1,612.63	5.60	5.60	\$10	\$56.02	\$1,612.63
2	2017	0.1542	0.3588	1,857	2,062	\$286	\$740	\$1,026	1,383	\$213	1,033	\$357	3,240	3,095	500	\$1,111	\$1,722.20	5.60	5.60	\$20	\$112.04	\$1,722.20
3	2018	0.1583	0.3718	1,857	2,062	\$294	\$767	\$1,061	1,383	\$219	1,033	\$357	3,240	3,095	513	\$1,151	\$1,831.78	5.60	5.60	\$30	\$168.06	\$1,831.78
4	2019	0.1625	0.3776	1,857	2,062	\$302	\$779	\$1,080	1,383	\$225	1,033	\$357	3,240	3,095	527	\$1,169	\$1,919.32	5.60	5.60	\$40	\$224.08	\$1,919.32
5	2020	0.1668	0.3841	1,857	2,062	\$310	\$792	\$1,102	1,383	\$225	1,033	\$357	3,240	3,095	540	\$1,189	\$2,009.23	5.60	5.60	\$50	\$280.10	\$2,009.23
6	2021	0.1621	0.3883	1,857	2,062	\$301	\$801	\$1,102	1,383	\$224	1,033	\$357	3,240	3,095	525	\$1,202	\$2,063.23	5.60	5.60	\$60	\$336.12	\$2,063.23
7	2022	0.1629	0.3929	1,857	2,062	\$303	\$810	\$1,113	1,383	\$225	1,033	\$357	3,240	3,095	528	\$1,216	\$2,136.02	5.60	5.60	\$70	\$392.14	\$2,136.02
8	2023	0.1639	0.3967	1,857	2,062	\$304	\$818	\$1,122	1,383	\$227	1,033	\$357	3,240	3,095	531	\$1,228	\$2,206.91	5.60	5.60	\$80	\$448.16	\$2,206.91
9	2024	0.1648	0.4005	1,857	2,062	\$306	\$825	\$1,132	1,383	\$228	1,033	\$357	3,240	3,095	534	\$1,240	\$2,277.81	5.60	5.60	\$90	\$504.18	\$2,277.81
10	2025	0.1656	0.4040	1,857	2,062	\$308	\$833	\$1,141	1,383	\$229	1,033	\$357	3,240	3,095	537	\$1,250	\$2,347.05	5.60	5.60	\$100	\$560.20	\$2,347.05
11	2026	0.1665	0.4070	1,857	2,062	\$309	\$839	\$1,149	1,383	\$230	1,033	\$357	3,240	3,095	540	\$1,260	\$2,415.57	5.60	5.60	\$110	\$616.21	\$2,415.57
12	2027	0.1674	0.4097	1,857	2,062	\$311	\$845	\$1,156	1,383	\$232	1,033	\$357	3,240	3,095	542	\$1,268	\$2,482.80	5.60	5.60	\$120	\$672.23	\$2,482.80
13	2028	0.1683	0.4124	1,857	2,062	\$312	\$850	\$1,163	1,383	\$233	1,033	\$357	3,240	3,095	545	\$1,276	\$2,549.79	5.60	5.60	\$130	\$728.25	\$2,549.79
14	2029	0.1692	0.4151	1,857	2,062	\$314	\$856	\$1,170	1,383	\$234	1,033	\$357	3,240	3,095	548	\$1,285	\$2,617.01	5.60	5.60	\$140	\$784.27	\$2,617.01
15	2030	0.1701	0.4170	1,857	2,062	\$316	\$860	\$1,176	1,383	\$235	1,033	\$357	3,240	3,095	551	\$1,291	\$2,681.98	5.60	5.60	\$150	\$840.29	\$2,681.98
16	2031	0.1704	0.4189	1,857	2,062	\$316	\$864	\$1,180	1,383	\$236	1,033	\$357	3,240	3,095	552	\$1,296	\$2,744.74	5.60	5.60	\$160	\$896.31	\$2,744.74
17	2032	0.1705	0.4204	1,857	2,062	\$317	\$867	\$1,184	1,383	\$236	1,033	\$357	3,240	3,095	552	\$1,301	\$2,805.96	5.60	5.60	\$170	\$952.33	\$2,805.96
18	2033	0.1707	0.4223	1,857	2,062	\$317	\$871	\$1,188	1,383	\$236	1,033	\$357	3,240	3,095	553	\$1,307	\$2,868.72	5.60	5.60	\$180	\$1,008.35	\$2,868.72
19	2034	0.1710	0.4246	1,857	2,062	\$318	\$876	\$1,193	1,383	\$237	1,033	\$357	3,240	3,095	554	\$1,314	\$2,932.77	5.60	5.60	\$190	\$1,064.37	\$2,932.77
20	2035	0.1713	0.4265	1,857	2,062	\$318	\$880	\$1,198	1,383	\$237	1,033	\$357	3,240	3,095	555	\$1,320	\$2,995.53	5.60	5.60	\$200	\$1,120.39	\$2,995.53
21	2036	0.1714	0.4288	1,857	2,062	\$318	\$884	\$1,203	1,383	\$237	1,033	\$357	3,240	3,095	555	\$1,327	\$3,059.12	5.60	5.60	\$210	\$1,176.41	\$3,059.12
22	2037	0.1717	0.4311	1,857	2,062	\$319	\$889	\$1,208	1,383	\$237	1,033	\$357	3,240	3,095	556	\$1,334	\$3,123.06	5.60	5.60	\$220	\$1,232.43	\$3,123.06
23	2038	0.1720	0.4331	1,857	2,062	\$319	\$893	\$1,212	1,383	\$238	1,033	\$357	3,240	3,095	557	\$1,340	\$3,185.93	5.60	5.60	\$230	\$1,288.45	\$3,185.93
24	2039	0.1722	0.4353	1,857	2,062	\$320	\$898	\$1,218	1,383	\$238	1,033	\$357	3,240	3,095	558	\$1,347	\$3,249.87	5.60	5.60	\$240	\$1,344.47	\$3,249.87
25	2040	0.1724	0.4376	1,857	2,062	\$320	\$902	\$1,223	1,383	\$238	1,033	\$357	3,240	3,095	558	\$1,355	\$3,313.46	5.60	5.60	\$250	\$1,400.49	\$3,313.46
26	2041	0.1734	0.4420	1,857	2,062	\$322	\$911	\$1,233	1,383	\$240	1,033	\$357	3,240	3,095	562	\$1,368	\$3,386.07	5.60	5.60	\$260	\$1,456.51	\$3,386.07
27	2042	0.1744	0.4463	1,857	2,062	\$324	\$920	\$1,244	1,383	\$241	1,033	\$357	3,240	3,095	565	\$1,381	\$3,458.82	5.60	5.60	\$270	\$1,512.53	\$3,458.82
28	2043	0.1754	0.4507	1,857	2,062	\$326	\$929	\$1,255	1,383	\$243	1,033	\$357	3,240	3,095	568	\$1,395	\$3,531.73	5.60	5.60	\$280	\$1,568.55	\$3,531.73
29	2044	0.1764	0.4552	1,857	2,062	\$328	\$938	\$1,266	1,383	\$244	1,033	\$357	3,240	3,095	572	\$1,409	\$3,604.79	5.60	5.60	\$290	\$1,624.57	\$3,604.79
30	2045	0.1774	0.4596	1,857	2,062	\$329	\$948	\$1,277	1,383	\$245	1,033	\$357	3,240	3,095	575	\$1,423	\$3,678.02	5.60	5.60	\$300	\$1,680.59	\$3,678.02
31	2046	0.1784	0.4642	1,857	2,062	\$331	\$957	\$1,288	1,383	\$247	1,033	\$357	3,240	3,095	578	\$1,437	\$3,751.37	5.60	5.60	\$310	\$1,736.60	\$3,751.37
32	2047	0.1795	0.4688	1,857	2,062	\$333	\$967	\$1,300	1,383	\$248	1,033	\$357	3,240	3,095	581	\$1,451	\$3,824.90	5.60	5.60	\$320	\$1,792.62	\$3,824.90
33	2048	0.1805	0.4734	1,857	2,062	\$335	\$976	\$1,311	1,383	\$250	1,033	\$357	3,240	3,095	585	\$1,465	\$3,898.58	5.60	5.60	\$330	\$1,848.64	\$3,898.58
34	2049	0.1816	0.4780	1,857	2,062	\$337	\$986	\$1,323	1,383	\$251	1,033	\$357	3,240	3,095	588	\$1,480	\$3,972.43	5.60	5.60	\$340	\$1,904.66	\$3,972.43
35	2050	0.1826	0.4828	1,857	2,062	\$339	\$995	\$1,335	1,383	\$253	1,033	\$357	3,240	3,095	592	\$1,494	\$4,046.44	5.60	5.60	\$350	\$1,960.68	\$4,046.44
36	2051	0.1837	0.4875	1,857	2,062	\$341	\$1,005	\$1,346	1,383	\$254	1,033	\$357	3,240	3,095	595	\$1,509	\$4,120.61	5.60	5.60	\$360	\$2,016.70	\$4,120.61
37	2052	0.1847	0.4923	1,857	2,062	\$343	\$1,015	\$1,358	1,383	\$255	1,033	\$357	3,240	3,095	598	\$1,524	\$4,194.95	5.60	5.60	\$370	\$2,072.72	\$4,194.95
38	2053	0.1858	0.4972	1,857	2,062	\$345	\$1,025	\$1,370	1,383	\$257	1,033	\$357	3,240	3,095	602	\$1,539	\$4,269.46	5.60	5.60	\$380	\$2,128.74	\$4,269.46
39	2054	0.1869	0.5021	1,857	2,062	\$347	\$1,035	\$1,382	1,383	\$258	1,033	\$357	3,240	3,095	605	\$1,554	\$4,344.13	5.60	5.60	\$390	\$2,184.76	\$4,344.13
40	2055	0.1879	0.5070	1,857	2,062	\$349	\$1,045	\$1,395	1,383	\$260	1,033	\$357	3,240	3,095	609	\$1,569	\$4,418.97	5.60	5.60	\$400	\$2,240.78	\$4,418.97
41	2056	0.1890	0.5120	1,857	2,062	\$351	\$1,056	\$1,407	1,383	\$261	1,033	\$357	3,240	3,095	612	\$1,585	\$4,493.98	5.60	5.60	\$410	\$2,296.80	\$4,493.98
42	2057	0.1901	0.5171	1,857	2,062	\$353	\$1,066	\$1,419	1,383	\$263	1,033	\$357	3,240	3,095	616	\$1,600	\$4,569.17	5.60	5.60	\$420	\$2,352.82	\$4,569.17
43	2058	0.1912	0.5222	1,857	2,062	\$355	\$1,077	\$1,432	1,383	\$264	1,033	\$357	3,240	3,095	620	\$1,616	\$4,644.53	5.60	5.60	\$430	\$2,408.84	\$4,644.53
44	2059	0.1923	0.5273	1,857	2,062	\$357	\$1,087	\$1,444	1,383	\$266	1,033	\$357	3,240	3,095	623	\$1,632	\$4,720.07	5.60	5.60	\$440	\$2,464.86	\$4,720.07
45	2060	0.1934	0.5325	1,857	2,062	\$359	\$1,098	\$1,457	1,383	\$268	1,033	\$357	3,240	3,095	627	\$1,648	\$4,795.78	5.60	5.60	\$450	\$2,520.88	\$4,795.78
46	2061	0.1946	0.5378	1,857	2,062	\$361	\$1,109	\$1,470	1,383	\$269	1,033	\$357	3,240	3,095	630	\$1,664	\$4,871.68	5.60	5.60	\$460	\$2,576.90	\$4,871.68
47	2062	0.1957	0.5431	1,857	2,062	\$363	\$1,120	\$1,483	1,383	\$271	1,033	\$357	3,240	3,095	634	\$1,681	\$4,947.75	5.60	5.60	\$470	\$2,632.92	\$4,947.75
48	2063	0.1968	0.5484	1,857	2,062	\$365	\$1,131	\$1,496	1,383	\$272	1,033	\$357	3,240	3,095	638	\$1,697	\$5,024.01	5.60	5.60	\$480	\$2,688.94	\$5,024.01
49	2064	0.1980	0.5538	1,857	2,062	\$368	\$1,142	\$1,510	1,383	\$274	1,033	\$357	3,240	3,095	641	\$1,714	\$5,100.45	5.60	5.60	\$490	\$2,744.96	\$5,100.45
50	2065	0.1991	0.5593	1,857	2,062	\$370	\$1,153	\$1,523	1,383	\$275	1,033	\$357	3,240	3,095	645	\$1,731	\$5,177.08	5.60	5.60	\$500	\$2,800.98	\$5,177.08
51	2066	0.2003	0.5648	1,857	2,062	\$372	\$1,165	\$1,537	1,383	\$277	1,033	\$357	3,240	3,095	649	\$1,748	\$5,253.90	5.60	5.60	\$510	\$2,856.99	\$5,253.90
52	2067	0.2014	0.5704	1,857	2,062	\$374	\$1,176	\$1,550	1,383	\$279	1,033	\$357	3,240	3,095	653	\$1,765	\$5,330.91	5.60	5.60	\$520	\$2,913.01	\$5,330.91
53	2068	0.20																				

15. Wiarnton (South) – Annual Operating Costs

Vertical Ground Source Heat Pump (V.GSHP)

Base Case Scenario											Feed In Tariff (FIT)			
#	Year	Electricity Rates		V.GSHP		Cooling	Cooling Operating Cost	Hot Water	Hot Water Operating Cost	Total	Total Operating Cost	FIT		
		\$/KWh	KWh	Heating	Heating Operating Cost							Incentives (\$/KWh)	S/KWh	Operating Cost
1	2016	0.1501	4,678	\$702	184	\$28	4,772	\$716	9,634	\$1,446	0.05	0.1001	\$964.20	
2	2017	0.1542	4,678	\$721	184	\$28	4,772	\$736	9,634	\$1,485	0.05	0.1042	\$1,003.74	
3	2018	0.1583	4,678	\$740	184	\$29	4,772	\$755	9,634	\$1,525	0.05	0.1083	\$1,043.27	
4	2019	0.1625	4,678	\$760	184	\$30	4,772	\$776	9,634	\$1,566	0.05	0.1125	\$1,084.20	
5	2020	0.1668	4,678	\$780	184	\$31	4,772	\$796	9,634	\$1,607	0.05	0.1168	\$1,125.12	
6	2021	0.1621	4,678	\$759	184	\$30	4,772	\$774	9,634	\$1,562	0.05	0.1121	\$1,080.38	
7	2022	0.1629	4,678	\$762	184	\$30	4,772	\$778	9,634	\$1,570	0.05	0.1129	\$1,088.01	
8	2023	0.1639	4,678	\$767	184	\$30	4,772	\$782	9,634	\$1,579	0.05	0.1139	\$1,097.03	
9	2024	0.1648	4,678	\$771	184	\$30	4,772	\$786	9,634	\$1,588	0.05	0.1148	\$1,106.05	
10	2025	0.1656	4,678	\$775	184	\$30	4,772	\$790	9,634	\$1,595	0.05	0.1156	\$1,113.68	
11	2026	0.1665	4,678	\$779	184	\$31	4,772	\$795	9,634	\$1,604	0.05	0.1165	\$1,122.69	
12	2027	0.1674	4,678	\$783	184	\$31	4,772	\$799	9,634	\$1,613	0.05	0.1174	\$1,131.37	
13	2028	0.1683	4,678	\$787	184	\$31	4,772	\$803	9,634	\$1,621	0.05	0.1183	\$1,139.34	
14	2029	0.1692	4,678	\$791	184	\$31	4,772	\$807	9,634	\$1,630	0.05	0.1192	\$1,148.01	
15	2030	0.1701	4,678	\$796	184	\$31	4,772	\$812	9,634	\$1,639	0.05	0.1201	\$1,157.03	
16	2031	0.1704	4,678	\$797	184	\$31	4,772	\$813	9,634	\$1,641	0.05	0.1204	\$1,159.46	
17	2032	0.1705	4,678	\$798	184	\$31	4,772	\$814	9,634	\$1,643	0.05	0.1205	\$1,160.85	
18	2033	0.1707	4,678	\$799	184	\$31	4,772	\$815	9,634	\$1,645	0.05	0.1207	\$1,163.27	
19	2034	0.1710	4,678	\$800	184	\$31	4,772	\$816	9,634	\$1,648	0.05	0.1210	\$1,166.05	
20	2035	0.1713	4,678	\$801	184	\$32	4,772	\$817	9,634	\$1,650	0.05	0.1213	\$1,168.48	
21	2036	0.1714	4,678	\$802	184	\$32	4,772	\$818	9,634	\$1,652	0.05	0.1214	\$1,169.86	
22	2037	0.1717	4,678	\$803	184	\$32	4,772	\$819	9,634	\$1,654	0.05	0.1217	\$1,172.29	
23	2038	0.1720	4,678	\$804	184	\$32	4,772	\$821	9,634	\$1,657	0.05	0.1220	\$1,175.06	
24	2039	0.1722	4,678	\$806	184	\$32	4,772	\$822	9,634	\$1,659	0.05	0.1222	\$1,177.49	
25	2040	0.1724	4,678	\$806	184	\$32	4,772	\$823	9,634	\$1,661	0.05	0.1224	\$1,178.88	
26	2041	0.1734	4,678	\$811	184	\$32	4,772	\$827	9,634	\$1,670	0.05	0.1234	\$1,188.49	
27	2042	0.1744	4,678	\$816	184	\$32	4,772	\$832	9,634	\$1,680	0.05	0.1244	\$1,198.15	
28	2043	0.1754	4,678	\$820	184	\$32	4,772	\$837	9,634	\$1,690	0.05	0.1254	\$1,207.87	
29	2044	0.1764	4,678	\$825	184	\$32	4,772	\$842	9,634	\$1,699	0.05	0.1264	\$1,217.64	
30	2045	0.1774	4,678	\$830	184	\$33	4,772	\$847	9,634	\$1,709	0.05	0.1274	\$1,227.47	
31	2046	0.1784	4,678	\$835	184	\$33	4,772	\$851	9,634	\$1,719	0.05	0.1284	\$1,237.36	
32	2047	0.1795	4,678	\$840	184	\$33	4,772	\$856	9,634	\$1,729	0.05	0.1295	\$1,247.30	
33	2048	0.1805	4,678	\$844	184	\$33	4,772	\$861	9,634	\$1,739	0.05	0.1305	\$1,257.30	
34	2049	0.1816	4,678	\$849	184	\$33	4,772	\$866	9,634	\$1,749	0.05	0.1316	\$1,267.36	
35	2050	0.1826	4,678	\$854	184	\$34	4,772	\$871	9,634	\$1,759	0.05	0.1326	\$1,277.48	
36	2051	0.1837	4,678	\$859	184	\$34	4,772	\$876	9,634	\$1,769	0.05	0.1337	\$1,287.66	
37	2052	0.1847	4,678	\$864	184	\$34	4,772	\$881	9,634	\$1,780	0.05	0.1347	\$1,297.89	
38	2053	0.1858	4,678	\$869	184	\$34	4,772	\$887	9,634	\$1,790	0.05	0.1358	\$1,308.19	
39	2054	0.1869	4,678	\$874	184	\$34	4,772	\$892	9,634	\$1,800	0.05	0.1369	\$1,318.54	
40	2055	0.1879	4,678	\$879	184	\$35	4,772	\$897	9,634	\$1,811	0.05	0.1379	\$1,328.96	
41	2056	0.1890	4,678	\$884	184	\$35	4,772	\$902	9,634	\$1,821	0.05	0.1390	\$1,339.43	
42	2057	0.1901	4,678	\$889	184	\$35	4,772	\$907	9,634	\$1,832	0.05	0.1401	\$1,349.97	
43	2058	0.1912	4,678	\$895	184	\$35	4,772	\$913	9,634	\$1,842	0.05	0.1412	\$1,360.56	
44	2059	0.1923	4,678	\$900	184	\$35	4,772	\$918	9,634	\$1,853	0.05	0.1423	\$1,371.22	
45	2060	0.1934	4,678	\$905	184	\$36	4,772	\$923	9,634	\$1,864	0.05	0.1434	\$1,381.94	
46	2061	0.1946	4,678	\$910	184	\$36	4,772	\$928	9,634	\$1,874	0.05	0.1446	\$1,392.72	
47	2062	0.1957	4,678	\$915	184	\$36	4,772	\$934	9,634	\$1,885	0.05	0.1457	\$1,403.56	
48	2063	0.1968	4,678	\$921	184	\$36	4,772	\$939	9,634	\$1,896	0.05	0.1468	\$1,414.47	
49	2064	0.1980	4,678	\$926	184	\$36	4,772	\$945	9,634	\$1,907	0.05	0.1480	\$1,425.44	
50	2065	0.1991	4,678	\$931	184	\$37	4,772	\$950	9,634	\$1,918	0.05	0.1491	\$1,436.47	
51	2066	0.2003	4,678	\$937	184	\$37	4,772	\$956	9,634	\$1,929	0.05	0.1503	\$1,447.57	
52	2067	0.2014	4,678	\$942	184	\$37	4,772	\$961	9,634	\$1,940	0.05	0.1514	\$1,458.73	
53	2068	0.2026	4,678	\$948	184	\$37	4,772	\$967	9,634	\$1,952	0.05	0.1526	\$1,469.95	
54	2069	0.2038	4,678	\$953	184	\$37	4,772	\$972	9,634	\$1,963	0.05	0.1538	\$1,481.24	
55	2070	0.2049	4,678	\$959	184	\$38	4,772	\$978	9,634	\$1,974	0.05	0.1549	\$1,492.60	
56	2071	0.2061	4,678	\$964	184	\$38	4,772	\$984	9,634	\$1,986	0.05	0.1561	\$1,504.02	
57	2072	0.2073	4,678	\$970	184	\$38	4,772	\$989	9,634	\$1,997	0.05	0.1573	\$1,515.51	
58	2073	0.2085	4,678	\$975	184	\$38	4,772	\$995	9,634	\$2,009	0.05	0.1585	\$1,527.06	
59	2074	0.2097	4,678	\$981	184	\$39	4,772	\$1,001	9,634	\$2,020	0.05	0.1597	\$1,538.68	
60	2075	0.2109	4,678	\$987	184	\$39	4,772	\$1,007	9,634	\$2,032	0.05	0.1609	\$1,550.37	

Table D2-1.43: Annual Operating Costs (V.GSHP) of a 2,000 square feet detached house above grade (improved construction type) in the city of Wiarnton (two life cycles and three life cycles for a 60 year project lifespan); base case scenario in comparison with feed in-tariff (FIT) scenario. In the FIT scenario, an incentive of \$0.05/KWh is provided on electricity bills throughout the project lifespan

Horizontal Ground Source Heat Pump (H.GSHP)

Base Case Scenario											Feed in Tariff (FIT)		
H.GSHP											FIT		
#	Year	Electricity Rates \$/KWh	Heating KWh	Heating Operating Cost \$	Cooling KWh	Cooling Operating Cost \$	Hot Water KWh	Hot Water Operating Cost \$	Total KWh	Total Operating Cost \$	Incentives (\$/KWh)	S/KWh	Operating Cost
1	2016	0.1501	4,754	\$713	187	\$28	4,758	\$714	9,699	\$1,456	0.05	0.1001	\$970.70
2	2017	0.1542	4,754	\$733	187	\$29	4,758	\$734	9,699	\$1,495	0.05	0.1042	\$1,010.51
3	2018	0.1583	4,754	\$753	187	\$30	4,758	\$753	9,699	\$1,535	0.05	0.1083	\$1,050.31
4	2019	0.1625	4,754	\$773	187	\$30	4,758	\$773	9,699	\$1,576	0.05	0.1125	\$1,091.51
5	2020	0.1668	4,754	\$793	187	\$31	4,758	\$794	9,699	\$1,618	0.05	0.1168	\$1,132.71
6	2021	0.1621	4,754	\$771	187	\$30	4,758	\$771	9,699	\$1,573	0.05	0.1121	\$1,087.67
7	2022	0.1629	4,754	\$775	187	\$30	4,758	\$775	9,699	\$1,580	0.05	0.1129	\$1,095.35
8	2023	0.1639	4,754	\$779	187	\$31	4,758	\$780	9,699	\$1,589	0.05	0.1139	\$1,104.43
9	2024	0.1648	4,754	\$783	187	\$31	4,758	\$784	9,699	\$1,598	0.05	0.1148	\$1,113.51
10	2025	0.1656	4,754	\$787	187	\$31	4,758	\$788	9,699	\$1,606	0.05	0.1156	\$1,121.19
11	2026	0.1665	4,754	\$792	187	\$31	4,758	\$792	9,699	\$1,615	0.05	0.1165	\$1,130.27
12	2027	0.1674	4,754	\$796	187	\$31	4,758	\$797	9,699	\$1,624	0.05	0.1174	\$1,139.00
13	2028	0.1683	4,754	\$800	187	\$31	4,758	\$801	9,699	\$1,632	0.05	0.1183	\$1,147.03
14	2029	0.1692	4,754	\$804	187	\$32	4,758	\$805	9,699	\$1,641	0.05	0.1192	\$1,155.76
15	2030	0.1701	4,754	\$809	187	\$32	4,758	\$809	9,699	\$1,650	0.05	0.1201	\$1,164.84
16	2031	0.1704	4,754	\$810	187	\$32	4,758	\$811	9,699	\$1,652	0.05	0.1204	\$1,167.28
17	2032	0.1705	4,754	\$811	187	\$32	4,758	\$811	9,699	\$1,654	0.05	0.1205	\$1,168.68
18	2033	0.1707	4,754	\$812	187	\$32	4,758	\$812	9,699	\$1,656	0.05	0.1207	\$1,171.12
19	2034	0.1710	4,754	\$813	187	\$32	4,758	\$814	9,699	\$1,659	0.05	0.1210	\$1,173.91
20	2035	0.1713	4,754	\$814	187	\$32	4,758	\$815	9,699	\$1,661	0.05	0.1213	\$1,176.36
21	2036	0.1714	4,754	\$815	187	\$32	4,758	\$816	9,699	\$1,663	0.05	0.1214	\$1,177.76
22	2037	0.1717	4,754	\$816	187	\$32	4,758	\$817	9,699	\$1,665	0.05	0.1217	\$1,180.20
23	2038	0.1720	4,754	\$818	187	\$32	4,758	\$818	9,699	\$1,668	0.05	0.1220	\$1,182.99
24	2039	0.1722	4,754	\$819	187	\$32	4,758	\$819	9,699	\$1,670	0.05	0.1222	\$1,185.44
25	2040	0.1724	4,754	\$819	187	\$32	4,758	\$820	9,699	\$1,672	0.05	0.1224	\$1,186.83
26	2041	0.1734	4,754	\$824	187	\$32	4,758	\$825	9,699	\$1,681	0.05	0.1234	\$1,196.50
27	2042	0.1744	4,754	\$829	187	\$33	4,758	\$830	9,699	\$1,691	0.05	0.1244	\$1,206.23
28	2043	0.1754	4,754	\$834	187	\$33	4,758	\$834	9,699	\$1,701	0.05	0.1254	\$1,216.02
29	2044	0.1764	4,754	\$839	187	\$33	4,758	\$839	9,699	\$1,711	0.05	0.1264	\$1,225.85
30	2045	0.1774	4,754	\$843	187	\$33	4,758	\$844	9,699	\$1,721	0.05	0.1274	\$1,235.75
31	2046	0.1784	4,754	\$848	187	\$33	4,758	\$849	9,699	\$1,731	0.05	0.1284	\$1,245.71
32	2047	0.1795	4,754	\$853	187	\$34	4,758	\$854	9,699	\$1,741	0.05	0.1295	\$1,255.72
33	2048	0.1805	4,754	\$858	187	\$34	4,758	\$859	9,699	\$1,751	0.05	0.1305	\$1,265.79
34	2049	0.1816	4,754	\$863	187	\$34	4,758	\$864	9,699	\$1,761	0.05	0.1316	\$1,275.91
35	2050	0.1826	4,754	\$868	187	\$34	4,758	\$869	9,699	\$1,771	0.05	0.1326	\$1,286.10
36	2051	0.1837	4,754	\$873	187	\$34	4,758	\$874	9,699	\$1,781	0.05	0.1337	\$1,296.35
37	2052	0.1847	4,754	\$878	187	\$35	4,758	\$879	9,699	\$1,792	0.05	0.1347	\$1,306.65
38	2053	0.1858	4,754	\$883	187	\$35	4,758	\$884	9,699	\$1,802	0.05	0.1358	\$1,317.01
39	2054	0.1869	4,754	\$888	187	\$35	4,758	\$889	9,699	\$1,812	0.05	0.1369	\$1,327.44
40	2055	0.1879	4,754	\$893	187	\$35	4,758	\$894	9,699	\$1,823	0.05	0.1379	\$1,337.92
41	2056	0.1890	4,754	\$899	187	\$35	4,758	\$899	9,699	\$1,833	0.05	0.1390	\$1,348.47
42	2057	0.1901	4,754	\$904	187	\$36	4,758	\$905	9,699	\$1,844	0.05	0.1401	\$1,359.07
43	2058	0.1912	4,754	\$909	187	\$36	4,758	\$910	9,699	\$1,855	0.05	0.1412	\$1,369.74
44	2059	0.1923	4,754	\$914	187	\$36	4,758	\$915	9,699	\$1,865	0.05	0.1423	\$1,380.47
45	2060	0.1934	4,754	\$920	187	\$36	4,758	\$920	9,699	\$1,876	0.05	0.1434	\$1,391.26
46	2061	0.1946	4,754	\$925	187	\$36	4,758	\$926	9,699	\$1,887	0.05	0.1446	\$1,402.12
47	2062	0.1957	4,754	\$930	187	\$37	4,758	\$931	9,699	\$1,898	0.05	0.1457	\$1,413.03
48	2063	0.1968	4,754	\$936	187	\$37	4,758	\$936	9,699	\$1,909	0.05	0.1468	\$1,424.01
49	2064	0.1980	4,754	\$941	187	\$37	4,758	\$942	9,699	\$1,920	0.05	0.1480	\$1,435.06
50	2065	0.1991	4,754	\$947	187	\$37	4,758	\$947	9,699	\$1,931	0.05	0.1491	\$1,446.16
51	2066	0.2003	4,754	\$952	187	\$37	4,758	\$953	9,699	\$1,942	0.05	0.1503	\$1,457.33
52	2067	0.2014	4,754	\$958	187	\$38	4,758	\$958	9,699	\$1,954	0.05	0.1514	\$1,468.57
53	2068	0.2026	4,754	\$963	187	\$38	4,758	\$964	9,699	\$1,965	0.05	0.1526	\$1,479.87
54	2069	0.2038	4,754	\$969	187	\$38	4,758	\$969	9,699	\$1,976	0.05	0.1538	\$1,491.24
55	2070	0.2049	4,754	\$974	187	\$38	4,758	\$975	9,699	\$1,988	0.05	0.1549	\$1,502.67
56	2071	0.2061	4,754	\$980	187	\$39	4,758	\$981	9,699	\$1,999	0.05	0.1561	\$1,514.17
57	2072	0.2073	4,754	\$986	187	\$39	4,758	\$986	9,699	\$2,011	0.05	0.1573	\$1,525.73
58	2073	0.2085	4,754	\$991	187	\$39	4,758	\$992	9,699	\$2,022	0.05	0.1585	\$1,537.36
59	2074	0.2097	4,754	\$997	187	\$39	4,758	\$998	9,699	\$2,034	0.05	0.1597	\$1,549.06
60	2075	0.2109	4,754	\$1,003	187	\$39	4,758	\$1,004	9,699	\$2,046	0.05	0.1609	\$1,560.83

Table D2-1.44: Annual Operating Costs (H.GSHP) of a 2,000 square feet detached house above grade (improved construction type) in the city of Wiaraton (two life cycles and three life cycles for a 60 year project lifespan); base case scenario in comparison with feed in-tariff (FIT) scenario. In the FIT scenario, an incentive of \$0.05/KWh is provided on electricity bills throughout the project lifespan

Traditional HVAC Applications

Base Case Scenario																	Carbon Taxes					
#	Year	Traditional														Total	Conversion of m ³ into Tons	Total Tons	Carbon Tax	Operating Costs		
		Electricity Rates	Natural Gas Rates	Heating		Heating Operating Cost	Heating Operating Cost	Total Heating Operating Cost	Cooling	Cooling Operating Cost		Hot Water	Hot Water Operating Cost	Total	Total						Total Electricity Operating Cost	Total Natural Gas Operating Cost
				KWh (Electricity)	m ³ (Gas)					\$	\$											
\$/KWh	\$/m ³			\$	\$	\$	KWh						KWh	m ³	\$ (KWh)	\$ (m ³)			10			
1	2016	0.1501	0.3458	1.893	2,231	\$284	7,742	\$1,056	948	\$142	1,052	\$364	2,841	3,283	426	\$1,135	\$1,562	5.94	5.94	\$10	\$59.42	\$1,621.17
2	2017	0.1542	0.3588	1.893	2,231	\$292	\$801	\$1,092	948	\$146	1,052	\$162	2,841	3,283	438	\$1,178	\$1,616	5.94	5.94	\$20	\$118.84	\$1,734.95
3	2018	0.1583	0.3718	1.893	2,231	\$300	\$830	\$1,129	948	\$150	1,052	\$167	2,841	3,283	450	\$1,221	\$1,670	5.94	5.94	\$30	\$178.27	\$1,848.73
4	2019	0.1625	0.3776	1.893	2,231	\$308	\$842	\$1,150	948	\$154	1,052	\$171	2,841	3,283	462	\$1,240	\$1,701	5.94	5.94	\$40	\$237.69	\$1,939.06
5	2020	0.1668	0.3841	1.893	2,231	\$316	\$857	\$1,173	948	\$158	1,052	\$175	2,841	3,283	474	\$1,261	\$1,735	5.94	5.94	\$50	\$297.11	\$2,031.91
6	2021	0.1621	0.3883	1.893	2,231	\$307	\$866	\$1,173	948	\$154	1,052	\$171	2,841	3,283	461	\$1,275	\$1,735	5.94	5.94	\$60	\$356.53	\$2,091.95
7	2022	0.1629	0.3929	1.893	2,231	\$308	\$877	\$1,185	948	\$154	1,052	\$171	2,841	3,283	463	\$1,290	\$1,753	5.94	5.94	\$70	\$415.96	\$2,168.69
8	2023	0.1639	0.3967	1.893	2,231	\$310	\$885	\$1,195	948	\$155	1,052	\$172	2,841	3,283	466	\$1,302	\$1,768	5.94	5.94	\$80	\$475.38	\$2,243.33
9	2024	0.1648	0.4005	1.893	2,231	\$312	\$894	\$1,206	948	\$156	1,052	\$173	2,841	3,283	468	\$1,315	\$1,783	5.94	5.94	\$90	\$534.80	\$2,317.97
10	2025	0.1656	0.4040	1.893	2,231	\$313	\$901	\$1,215	948	\$157	1,052	\$174	2,841	3,283	470	\$1,326	\$1,797	5.94	5.94	\$100	\$594.22	\$2,390.95
11	2026	0.1665	0.4070	1.893	2,231	\$315	\$908	\$1,223	948	\$158	1,052	\$175	2,841	3,283	473	\$1,336	\$1,809	5.94	5.94	\$110	\$653.65	\$2,463.08
12	2027	0.1674	0.4097	1.893	2,231	\$317	\$914	\$1,231	948	\$159	1,052	\$176	2,841	3,283	476	\$1,345	\$1,821	5.94	5.94	\$120	\$713.07	\$2,533.85
13	2028	0.1683	0.4124	1.893	2,231	\$319	\$920	\$1,239	948	\$160	1,052	\$177	2,841	3,283	478	\$1,354	\$1,832	5.94	5.94	\$130	\$772.49	\$2,604.42
14	2029	0.1692	0.4151	1.893	2,231	\$320	\$926	\$1,246	948	\$160	1,052	\$178	2,841	3,283	481	\$1,363	\$1,843	5.94	5.94	\$140	\$831.91	\$2,675.19
15	2030	0.1701	0.4170	1.893	2,231	\$322	\$930	\$1,252	948	\$161	1,052	\$179	2,841	3,283	483	\$1,369	\$1,852	5.94	5.94	\$150	\$891.33	\$2,743.55
16	2031	0.1704	0.4189	1.893	2,231	\$322	\$935	\$1,257	948	\$161	1,052	\$179	2,841	3,283	484	\$1,375	\$1,859	5.94	5.94	\$160	\$950.76	\$2,809.97
17	2032	0.1705	0.4204	1.893	2,231	\$323	\$938	\$1,261	948	\$162	1,052	\$179	2,841	3,283	484	\$1,380	\$1,865	5.94	5.94	\$170	\$1,010.18	\$2,874.24
18	2033	0.1707	0.4223	1.893	2,231	\$323	\$942	\$1,265	948	\$162	1,052	\$180	2,841	3,283	485	\$1,387	\$1,872	5.94	5.94	\$180	\$1,069.60	\$2,941.24
19	2034	0.1710	0.4246	1.893	2,231	\$324	\$947	\$1,271	948	\$162	1,052	\$180	2,841	3,283	486	\$1,394	\$1,880	5.94	5.94	\$190	\$1,129.02	\$3,009.01
20	2035	0.1713	0.4265	1.893	2,231	\$324	\$952	\$1,276	948	\$162	1,052	\$180	2,841	3,283	487	\$1,400	\$1,887	5.94	5.94	\$200	\$1,188.45	\$3,075.43
21	2036	0.1714	0.4288	1.893	2,231	\$325	\$957	\$1,281	948	\$163	1,052	\$180	2,841	3,283	487	\$1,408	\$1,895	5.94	5.94	\$210	\$1,247.87	\$3,142.80
22	2037	0.1717	0.4311	1.893	2,231	\$325	\$962	\$1,287	948	\$163	1,052	\$181	2,841	3,283	488	\$1,415	\$1,903	5.94	5.94	\$220	\$1,307.29	\$3,210.47
23	2038	0.1720	0.4331	1.893	2,231	\$326	\$966	\$1,292	948	\$163	1,052	\$181	2,841	3,283	489	\$1,422	\$1,910	5.94	5.94	\$230	\$1,366.71	\$3,276.99
24	2039	0.1722	0.4353	1.893	2,231	\$326	\$971	\$1,297	948	\$163	1,052	\$181	2,841	3,283	489	\$1,429	\$1,918	5.94	5.94	\$240	\$1,426.14	\$3,344.67
25	2040	0.1724	0.4376	1.893	2,231	\$326	\$976	\$1,303	948	\$163	1,052	\$181	2,841	3,283	490	\$1,437	\$1,926	5.94	5.94	\$250	\$1,485.56	\$3,412.03
26	2041	0.1734	0.4420	1.893	2,231	\$328	\$986	\$1,314	948	\$164	1,052	\$182	2,841	3,283	493	\$1,451	\$1,943	5.94	5.94	\$260	\$1,544.98	\$3,488.45
27	2042	0.1744	0.4463	1.893	2,231	\$330	\$996	\$1,326	948	\$165	1,052	\$183	2,841	3,283	495	\$1,465	\$1,961	5.94	5.94	\$270	\$1,604.40	\$3,565.03
28	2043	0.1754	0.4507	1.893	2,231	\$332	\$1,006	\$1,338	948	\$166	1,052	\$184	2,841	3,283	498	\$1,480	\$1,978	5.94	5.94	\$280	\$1,663.82	\$3,641.77
29	2044	0.1764	0.4552	1.893	2,231	\$334	\$1,015	\$1,349	948	\$167	1,052	\$186	2,841	3,283	501	\$1,494	\$1,995	5.94	5.94	\$290	\$1,723.25	\$3,718.66
30	2045	0.1774	0.4596	1.893	2,231	\$336	\$1,025	\$1,361	948	\$168	1,052	\$187	2,841	3,283	504	\$1,509	\$2,013	5.94	5.94	\$300	\$1,782.67	\$3,795.71
31	2046	0.1784	0.4642	1.893	2,231	\$338	\$1,036	\$1,373	948	\$169	1,052	\$188	2,841	3,283	507	\$1,524	\$2,031	5.94	5.94	\$310	\$1,842.09	\$3,872.93
32	2047	0.1795	0.4688	1.893	2,231	\$340	\$1,046	\$1,386	948	\$170	1,052	\$189	2,841	3,283	510	\$1,539	\$2,049	5.94	5.94	\$320	\$1,901.51	\$3,950.31
33	2048	0.1805	0.4734	1.893	2,231	\$342	\$1,056	\$1,398	948	\$171	1,052	\$190	2,841	3,283	513	\$1,554	\$2,067	5.94	5.94	\$330	\$1,960.94	\$4,027.85
34	2049	0.1816	0.4780	1.893	2,231	\$344	\$1,067	\$1,410	948	\$172	1,052	\$191	2,841	3,283	516	\$1,569	\$2,085	5.94	5.94	\$340	\$2,020.36	\$4,105.56
35	2050	0.1826	0.4828	1.893	2,231	\$346	\$1,077	\$1,423	948	\$173	1,052	\$192	2,841	3,283	519	\$1,585	\$2,104	5.94	5.94	\$350	\$2,079.78	\$4,183.44
36	2051	0.1837	0.4875	1.893	2,231	\$348	\$1,088	\$1,435	948	\$174	1,052	\$193	2,841	3,283	522	\$1,601	\$2,122	5.94	5.94	\$360	\$2,139.20	\$4,261.49
37	2052	0.1847	0.4923	1.893	2,231	\$350	\$1,098	\$1,448	948	\$175	1,052	\$194	2,841	3,283	525	\$1,616	\$2,141	5.94	5.94	\$370	\$2,198.63	\$4,339.71
38	2053	0.1858	0.4972	1.893	2,231	\$352	\$1,109	\$1,461	948	\$176	1,052	\$195	2,841	3,283	528	\$1,632	\$2,160	5.94	5.94	\$380	\$2,258.05	\$4,418.10
39	2054	0.1869	0.5021	1.893	2,231	\$354	\$1,120	\$1,474	948	\$177	1,052	\$197	2,841	3,283	531	\$1,648	\$2,179	5.94	5.94	\$390	\$2,317.47	\$4,496.67
40	2055	0.1879	0.5070	1.893	2,231	\$356	\$1,131	\$1,487	948	\$178	1,052	\$198	2,841	3,283	534	\$1,665	\$2,199	5.94	5.94	\$400	\$2,376.89	\$4,575.41
41	2056	0.1890	0.5120	1.893	2,231	\$358	\$1,142	\$1,500	948	\$179	1,052	\$199	2,841	3,283	537	\$1,681	\$2,218	5.94	5.94	\$410	\$2,436.31	\$4,654.34
42	2057	0.1901	0.5171	1.893	2,231	\$360	\$1,154	\$1,513	948	\$180	1,052	\$200	2,841	3,283	540	\$1,698	\$2,238	5.94	5.94	\$420	\$2,495.74	\$4,733.44
43	2058	0.1912	0.5222	1.893	2,231	\$362	\$1,165	\$1,527	948	\$181	1,052	\$201	2,841	3,283	543	\$1,714	\$2,258	5.94	5.94	\$430	\$2,555.16	\$4,812.72
44	2059	0.1923	0.5273	1.893	2,231	\$364	\$1,176	\$1,541	948	\$182	1,052	\$202	2,841	3,283	546	\$1,731	\$2,278	5.94	5.94	\$440	\$2,614.58	\$4,892.19
45	2060	0.1934	0.5325	1.893	2,231	\$366	\$1,188	\$1,554	948	\$183	1,052	\$204	2,841	3,283	550	\$1,748	\$2,298	5.94	5.94	\$450	\$2,674.00	\$4,971.84
46	2061	0.1946	0.5378	1.893	2,231	\$368	\$1,200	\$1,568	948	\$184	1,052	\$205	2,841	3,283	553	\$1,765	\$2,318	5.94	5.94	\$460	\$2,733.43	\$5,051.68
47	2062	0.1957	0.5431	1.893	2,231	\$370	\$1,212	\$1,582	948	\$186	1,052	\$206	2,841	3,283	556	\$1,783	\$2,339	5.94	5.94	\$470	\$2,792.85	\$5,131.70
48	2063	0.1968	0.5484	1.893	2,231	\$373	\$1,224	\$1,596	948	\$187	1,052	\$207	2,841	3,283	559	\$1,800	\$2,360	5.94	5.94	\$480	\$2,852.27	\$5,211.92
49	2064	0.1980	0.5538	1.893	2,231	\$375	\$1,236	\$1,610	948	\$188	1,052	\$208	2,841	3,283	562	\$1,818	\$2,381	5.94	5.94	\$490	\$2,911.69	\$5,292.32
50	2065	0.1991	0.5593	1.893	2,231	\$377	\$1,248	\$1,625	948	\$189	1,052	\$209	2,841	3,283	566	\$1,836	\$2,402	5.94	5.94	\$500	\$2,971.12	\$5,372.93
51	2066	0.2003	0.5648	1.893	2,231	\$379	\$1,260	\$1,639	948	\$190	1,052	\$211	2,841	3,283	569	\$1,854	\$2,423	5.94	5.94	\$510	\$3,030.54	\$5,453.72
52	2067	0.2014	0.5704	1.893	2,231	\$381	\$1,273	\$1,654	948	\$191	1,052	\$212	2,841	3,283	572	\$1,873	\$2,445	5.94	5.94	\$520	\$3,089.96	\$5,534.72
53	2068	0.2026	0.5760	1.893	2,231	\$383	\$1,285	\$1,669	948	\$192	1,052	\$213	2,841	3								

16. Windsor (South) – Annual Operating Costs

Vertical Ground Source Heat Pump (V.GSHP)

Base Case Scenario											Feed in Tariff (FIT)		
#	Year	V.GSHP									FIT		
		Electricity Rates \$/KWh	Heating KWh	Heating Operating Cost \$	Cooling KWh	Cooling Operating Cost \$	Hot Water KWh	Hot Water Operating Cost \$	Total KWh	Total Operating Cost \$	Incentives (\$/KWh)	\$/KWh	Operating Cost
1	2016	0.1501	3,445	\$517	391	\$59	4,523	\$679	8,359	\$1,255	0.001	0.1001	\$836.59
2	2017	0.1542	3,445	\$531	391	\$60	4,523	\$697	8,359	\$1,289	0.005	0.1042	\$870.90
3	2018	0.1583	3,445	\$545	391	\$62	4,523	\$716	8,359	\$1,323	0.005	0.1083	\$905.20
4	2019	0.1625	3,445	\$560	391	\$64	4,523	\$735	8,359	\$1,359	0.005	0.1125	\$940.71
5	2020	0.1668	3,445	\$575	391	\$65	4,523	\$754	8,359	\$1,394	0.005	0.1168	\$976.22
6	2021	0.1621	3,445	\$559	391	\$63	4,523	\$733	8,359	\$1,355	0.005	0.1121	\$937.40
7	2022	0.1629	3,445	\$561	391	\$64	4,523	\$737	8,359	\$1,362	0.005	0.1129	\$944.02
8	2023	0.1639	3,445	\$565	391	\$64	4,523	\$741	8,359	\$1,370	0.005	0.1139	\$951.85
9	2024	0.1648	3,445	\$568	391	\$64	4,523	\$745	8,359	\$1,378	0.005	0.1148	\$959.67
10	2025	0.1656	3,445	\$570	391	\$65	4,523	\$749	8,359	\$1,384	0.005	0.1156	\$966.29
11	2026	0.1665	3,445	\$574	391	\$65	4,523	\$753	8,359	\$1,392	0.005	0.1165	\$974.11
12	2027	0.1674	3,445	\$577	391	\$65	4,523	\$757	8,359	\$1,400	0.005	0.1174	\$981.64
13	2028	0.1683	3,445	\$580	391	\$66	4,523	\$761	8,359	\$1,407	0.005	0.1183	\$988.56
14	2029	0.1692	3,445	\$583	391	\$66	4,523	\$765	8,359	\$1,414	0.005	0.1192	\$996.08
15	2030	0.1701	3,445	\$586	391	\$67	4,523	\$769	8,359	\$1,422	0.005	0.1201	\$1,003.90
16	2031	0.1704	3,445	\$587	391	\$67	4,523	\$770	8,359	\$1,424	0.005	0.1204	\$1,006.01
17	2032	0.1705	3,445	\$587	391	\$67	4,523	\$771	8,359	\$1,425	0.005	0.1205	\$1,007.21
18	2033	0.1707	3,445	\$588	391	\$67	4,523	\$772	8,359	\$1,427	0.005	0.1207	\$1,009.32
19	2034	0.1710	3,445	\$589	391	\$67	4,523	\$774	8,359	\$1,430	0.005	0.1210	\$1,011.73
20	2035	0.1713	3,445	\$590	391	\$67	4,523	\$775	8,359	\$1,432	0.005	0.1213	\$1,013.83
21	2036	0.1714	3,445	\$591	391	\$67	4,523	\$775	8,359	\$1,433	0.005	0.1214	\$1,015.04
22	2037	0.1717	3,445	\$591	391	\$67	4,523	\$777	8,359	\$1,435	0.005	0.1217	\$1,017.15
23	2038	0.1720	3,445	\$592	391	\$67	4,523	\$778	8,359	\$1,438	0.005	0.1220	\$1,019.55
24	2039	0.1722	3,445	\$593	391	\$67	4,523	\$779	8,359	\$1,440	0.005	0.1222	\$1,021.66
25	2040	0.1724	3,445	\$594	391	\$67	4,523	\$780	8,359	\$1,441	0.005	0.1224	\$1,022.86
26	2041	0.1734	3,445	\$597	391	\$68	4,523	\$784	8,359	\$1,449	0.005	0.1234	\$1,031.20
27	2042	0.1744	3,445	\$601	391	\$68	4,523	\$789	8,359	\$1,458	0.005	0.1244	\$1,039.58
28	2043	0.1754	3,445	\$604	391	\$69	4,523	\$793	8,359	\$1,466	0.005	0.1254	\$1,048.01
29	2044	0.1764	3,445	\$608	391	\$69	4,523	\$798	8,359	\$1,474	0.005	0.1264	\$1,056.49
30	2045	0.1774	3,445	\$611	391	\$69	4,523	\$802	8,359	\$1,483	0.005	0.1274	\$1,065.02
31	2046	0.1784	3,445	\$615	391	\$70	4,523	\$807	8,359	\$1,492	0.005	0.1284	\$1,073.60
32	2047	0.1795	3,445	\$618	391	\$70	4,523	\$812	8,359	\$1,500	0.005	0.1295	\$1,082.23
33	2048	0.1805	3,445	\$622	391	\$71	4,523	\$816	8,359	\$1,509	0.005	0.1305	\$1,090.91
34	2049	0.1816	3,445	\$625	391	\$71	4,523	\$821	8,359	\$1,518	0.005	0.1316	\$1,099.64
35	2050	0.1826	3,445	\$629	391	\$71	4,523	\$826	8,359	\$1,526	0.005	0.1326	\$1,108.42
36	2051	0.1837	3,445	\$633	391	\$72	4,523	\$831	8,359	\$1,535	0.005	0.1337	\$1,117.24
37	2052	0.1847	3,445	\$636	391	\$72	4,523	\$835	8,359	\$1,544	0.005	0.1347	\$1,126.13
38	2053	0.1858	3,445	\$640	391	\$73	4,523	\$840	8,359	\$1,553	0.005	0.1358	\$1,135.06
39	2054	0.1869	3,445	\$644	391	\$73	4,523	\$845	8,359	\$1,562	0.005	0.1369	\$1,144.04
40	2055	0.1879	3,445	\$647	391	\$73	4,523	\$850	8,359	\$1,571	0.005	0.1379	\$1,153.08
41	2056	0.1890	3,445	\$651	391	\$74	4,523	\$855	8,359	\$1,580	0.005	0.1390	\$1,162.17
42	2057	0.1901	3,445	\$655	391	\$74	4,523	\$860	8,359	\$1,589	0.005	0.1401	\$1,171.31
43	2058	0.1912	3,445	\$659	391	\$75	4,523	\$865	8,359	\$1,598	0.005	0.1412	\$1,180.50
44	2059	0.1923	3,445	\$663	391	\$75	4,523	\$870	8,359	\$1,608	0.005	0.1423	\$1,189.75
45	2060	0.1934	3,445	\$666	391	\$76	4,523	\$875	8,359	\$1,617	0.005	0.1434	\$1,199.05
46	2061	0.1946	3,445	\$670	391	\$76	4,523	\$880	8,359	\$1,626	0.005	0.1446	\$1,208.40
47	2062	0.1957	3,445	\$674	391	\$77	4,523	\$885	8,359	\$1,636	0.005	0.1457	\$1,217.81
48	2063	0.1968	3,445	\$678	391	\$77	4,523	\$890	8,359	\$1,645	0.005	0.1468	\$1,227.27
49	2064	0.1980	3,445	\$682	391	\$77	4,523	\$895	8,359	\$1,655	0.005	0.1480	\$1,236.79
50	2065	0.1991	3,445	\$686	391	\$78	4,523	\$901	8,359	\$1,664	0.005	0.1491	\$1,246.36
51	2066	0.2003	3,445	\$690	391	\$78	4,523	\$906	8,359	\$1,674	0.005	0.1503	\$1,255.99
52	2067	0.2014	3,445	\$694	391	\$79	4,523	\$911	8,359	\$1,684	0.005	0.1514	\$1,265.67
53	2068	0.2026	3,445	\$698	391	\$79	4,523	\$916	8,359	\$1,693	0.005	0.1526	\$1,275.41
54	2069	0.2038	3,445	\$702	391	\$80	4,523	\$922	8,359	\$1,703	0.005	0.1538	\$1,285.21
55	2070	0.2049	3,445	\$706	391	\$80	4,523	\$927	8,359	\$1,713	0.005	0.1549	\$1,295.06
56	2071	0.2061	3,445	\$710	391	\$81	4,523	\$932	8,359	\$1,723	0.005	0.1561	\$1,304.97
57	2072	0.2073	3,445	\$714	391	\$81	4,523	\$938	8,359	\$1,733	0.005	0.1573	\$1,314.94
58	2073	0.2085	3,445	\$718	391	\$82	4,523	\$943	8,359	\$1,743	0.005	0.1585	\$1,324.96
59	2074	0.2097	3,445	\$722	391	\$82	4,523	\$949	8,359	\$1,753	0.005	0.1597	\$1,335.04
60	2075	0.2109	3,445	\$727	391	\$82	4,523	\$954	8,359	\$1,763	0.005	0.1609	\$1,345.19

Table D2-1.46: Annual Operating Costs (V.GSHP) of a 2,000 square feet detached house above grade (improved construction type) in the city of Windsor (two life cycles and three life cycles for a 60 year project lifespan); base case scenario in comparison with feed in-tariff (FIT) scenario. In the FIT scenario, an incentive of \$0.05/KWh is provided on electricity bills throughout the project lifespan

Horizontal Ground Source Heat Pump (H.GSHP)

Base Case Scenario											Feed in Tariff (FIT)		
H.GSHP											FIT		
#	Year	Electricity Rates	Heating	Heating Operating Cost	Cooling	Cooling Operating Cost	Hot Water	Hot Water Operating Cost	Total	Total Operating Cost	Incentives (\$/KWh)	S/KWh	Operating Cost
		\$/KWh	KWh	\$	KWh	\$	KWh	\$	KWh	\$			
1	2016	0.1501	3,513	\$527	400	\$60	4,521	\$679	8,434	\$1,266	0.05	0.1001	\$844.10
2	2017	0.1542	3,513	\$542	400	\$62	4,521	\$697	8,434	\$1,300	0.05	0.1042	\$878.71
3	2018	0.1583	3,513	\$556	400	\$63	4,521	\$716	8,434	\$1,335	0.05	0.1083	\$913.32
4	2019	0.1625	3,513	\$571	400	\$65	4,521	\$735	8,434	\$1,371	0.05	0.1125	\$949.15
5	2020	0.1668	3,513	\$586	400	\$67	4,521	\$754	8,434	\$1,407	0.05	0.1168	\$984.98
6	2021	0.1621	3,513	\$570	400	\$65	4,521	\$733	8,434	\$1,368	0.05	0.1121	\$945.81
7	2022	0.1629	3,513	\$572	400	\$65	4,521	\$737	8,434	\$1,374	0.05	0.1129	\$952.49
8	2023	0.1639	3,513	\$576	400	\$66	4,521	\$741	8,434	\$1,382	0.05	0.1139	\$960.39
9	2024	0.1648	3,513	\$579	400	\$66	4,521	\$745	8,434	\$1,390	0.05	0.1148	\$968.28
10	2025	0.1656	3,513	\$582	400	\$66	4,521	\$749	8,434	\$1,397	0.05	0.1156	\$974.96
11	2026	0.1665	3,513	\$585	400	\$67	4,521	\$753	8,434	\$1,405	0.05	0.1165	\$982.85
12	2027	0.1674	3,513	\$588	400	\$67	4,521	\$757	8,434	\$1,412	0.05	0.1174	\$990.44
13	2028	0.1683	3,513	\$591	400	\$67	4,521	\$761	8,434	\$1,419	0.05	0.1183	\$997.43
14	2029	0.1692	3,513	\$594	400	\$68	4,521	\$765	8,434	\$1,427	0.05	0.1192	\$1,005.02
15	2030	0.1701	3,513	\$598	400	\$68	4,521	\$769	8,434	\$1,435	0.05	0.1201	\$1,012.91
16	2031	0.1704	3,513	\$598	400	\$68	4,521	\$770	8,434	\$1,437	0.05	0.1204	\$1,015.04
17	2032	0.1705	3,513	\$599	400	\$68	4,521	\$771	8,434	\$1,438	0.05	0.1205	\$1,016.25
18	2033	0.1707	3,513	\$600	400	\$68	4,521	\$772	8,434	\$1,440	0.05	0.1207	\$1,018.38
19	2034	0.1710	3,513	\$601	400	\$68	4,521	\$773	8,434	\$1,443	0.05	0.1210	\$1,020.81
20	2035	0.1713	3,513	\$602	400	\$69	4,521	\$774	8,434	\$1,445	0.05	0.1213	\$1,022.93
21	2036	0.1714	3,513	\$602	400	\$69	4,521	\$775	8,434	\$1,446	0.05	0.1214	\$1,024.15
22	2037	0.1717	3,513	\$603	400	\$69	4,521	\$776	8,434	\$1,448	0.05	0.1217	\$1,026.27
23	2038	0.1720	3,513	\$604	400	\$69	4,521	\$777	8,434	\$1,450	0.05	0.1220	\$1,028.70
24	2039	0.1722	3,513	\$605	400	\$69	4,521	\$779	8,434	\$1,453	0.05	0.1222	\$1,030.83
25	2040	0.1724	3,513	\$606	400	\$69	4,521	\$779	8,434	\$1,454	0.05	0.1224	\$1,032.04
26	2041	0.1734	3,513	\$609	400	\$69	4,521	\$784	8,434	\$1,462	0.05	0.1234	\$1,040.45
27	2042	0.1744	3,513	\$613	400	\$70	4,521	\$788	8,434	\$1,471	0.05	0.1244	\$1,048.91
28	2043	0.1754	3,513	\$616	400	\$70	4,521	\$793	8,434	\$1,479	0.05	0.1254	\$1,057.42
29	2044	0.1764	3,513	\$620	400	\$71	4,521	\$797	8,434	\$1,488	0.05	0.1264	\$1,065.97
30	2045	0.1774	3,513	\$623	400	\$71	4,521	\$802	8,434	\$1,496	0.05	0.1274	\$1,074.58
31	2046	0.1784	3,513	\$627	400	\$71	4,521	\$807	8,434	\$1,505	0.05	0.1284	\$1,083.23
32	2047	0.1795	3,513	\$630	400	\$72	4,521	\$811	8,434	\$1,514	0.05	0.1295	\$1,091.94
33	2048	0.1805	3,513	\$634	400	\$72	4,521	\$816	8,434	\$1,522	0.05	0.1305	\$1,100.70
34	2049	0.1816	3,513	\$638	400	\$73	4,521	\$821	8,434	\$1,531	0.05	0.1316	\$1,109.50
35	2050	0.1826	3,513	\$641	400	\$73	4,521	\$826	8,434	\$1,540	0.05	0.1326	\$1,118.36
36	2051	0.1837	3,513	\$645	400	\$73	4,521	\$830	8,434	\$1,549	0.05	0.1337	\$1,127.27
37	2052	0.1847	3,513	\$649	400	\$74	4,521	\$835	8,434	\$1,558	0.05	0.1347	\$1,136.23
38	2053	0.1858	3,513	\$653	400	\$74	4,521	\$840	8,434	\$1,567	0.05	0.1358	\$1,145.24
39	2054	0.1869	3,513	\$656	400	\$75	4,521	\$845	8,434	\$1,576	0.05	0.1369	\$1,154.31
40	2055	0.1879	3,513	\$660	400	\$75	4,521	\$850	8,434	\$1,585	0.05	0.1379	\$1,163.42
41	2056	0.1890	3,513	\$664	400	\$76	4,521	\$855	8,434	\$1,594	0.05	0.1390	\$1,172.59
42	2057	0.1901	3,513	\$668	400	\$76	4,521	\$860	8,434	\$1,604	0.05	0.1401	\$1,181.82
43	2058	0.1912	3,513	\$672	400	\$76	4,521	\$865	8,434	\$1,613	0.05	0.1412	\$1,191.09
44	2059	0.1923	3,513	\$676	400	\$77	4,521	\$870	8,434	\$1,622	0.05	0.1423	\$1,200.42
45	2060	0.1934	3,513	\$680	400	\$77	4,521	\$875	8,434	\$1,632	0.05	0.1434	\$1,209.81
46	2061	0.1946	3,513	\$683	400	\$78	4,521	\$880	8,434	\$1,641	0.05	0.1446	\$1,219.24
47	2062	0.1957	3,513	\$687	400	\$78	4,521	\$885	8,434	\$1,650	0.05	0.1457	\$1,228.74
48	2063	0.1968	3,513	\$691	400	\$79	4,521	\$890	8,434	\$1,660	0.05	0.1468	\$1,238.28
49	2064	0.1980	3,513	\$695	400	\$79	4,521	\$895	8,434	\$1,670	0.05	0.1480	\$1,247.89
50	2065	0.1991	3,513	\$699	400	\$80	4,521	\$900	8,434	\$1,679	0.05	0.1491	\$1,257.55
51	2066	0.2003	3,513	\$703	400	\$80	4,521	\$905	8,434	\$1,689	0.05	0.1503	\$1,267.26
52	2067	0.2014	3,513	\$708	400	\$81	4,521	\$911	8,434	\$1,699	0.05	0.1514	\$1,277.03
53	2068	0.2026	3,513	\$712	400	\$81	4,521	\$916	8,434	\$1,709	0.05	0.1526	\$1,286.86
54	2069	0.2038	3,513	\$716	400	\$82	4,521	\$921	8,434	\$1,718	0.05	0.1538	\$1,296.74
55	2070	0.2049	3,513	\$720	400	\$82	4,521	\$926	8,434	\$1,728	0.05	0.1549	\$1,306.68
56	2071	0.2061	3,513	\$724	400	\$82	4,521	\$932	8,434	\$1,738	0.05	0.1561	\$1,316.68
57	2072	0.2073	3,513	\$728	400	\$83	4,521	\$937	8,434	\$1,748	0.05	0.1573	\$1,326.74
58	2073	0.2085	3,513	\$732	400	\$83	4,521	\$943	8,434	\$1,759	0.05	0.1585	\$1,336.85
59	2074	0.2097	3,513	\$737	400	\$84	4,521	\$948	8,434	\$1,769	0.05	0.1597	\$1,347.02
60	2075	0.2109	3,513	\$741	400	\$84	4,521	\$954	8,434	\$1,779	0.05	0.1609	\$1,357.26

Table D2-1.47: Annual Operating Costs (H.GSHP) of a 2,000 square feet detached house above grade (improved construction type) in the city of Windsor (two life cycles and three life cycles for a 60 year project lifespan); base case scenario in comparison with feed in-tariff (FIT) scenario. In the FIT scenario, an incentive of \$0.05/KWh is provided on electricity bills throughout the project lifespan

Traditional HVAC Applications

Base Case Scenario															Carbon Taxes							
#	Year	Electricity Rates	Natural Gas Rates	Traditional								Total	Total	Total Electricity Operating Cost	Total Natural Gas Operating Cost	Total	Conversion of m ³ into Tons	Total Tons	Carbon Tax	Operating Costs		
				Heating		Heating Operating Cost	Heating Operating Cost	Total Heating Operating Cost	Cooling		Hot Water										Hot Water Operating Cost	
				KWh (Electricity)	m ³ (Gas)				\$	KWh												\$
\$/KWh	\$/m ³			\$ (Electricity)	\$ (Gas)	\$																
1	2016	0.1501	0.3458	1,397	1,763	\$210	\$610	\$819	1,725	\$259	1,003	\$347	3,122	2,766	469	\$957	\$1,425	5.01	5.01	\$10	\$50.06	\$1,475.19
2	2017	0.1542	0.3588	1,397	1,763	\$215	\$633	\$848	1,725	\$266	1,003	\$355	3,122	2,766	481	\$993	\$1,474	5.01	5.01	\$20	\$100.13	\$1,574.04
3	2018	0.1583	0.3718	1,397	1,763	\$221	\$656	\$877	1,725	\$273	1,003	\$359	3,122	2,766	494	\$1,029	\$1,523	5.01	5.01	\$30	\$150.19	\$1,672.90
4	2019	0.1625	0.3776	1,397	1,763	\$227	\$666	\$893	1,725	\$280	1,003	\$363	3,122	2,766	507	\$1,044	\$1,552	5.01	5.01	\$40	\$200.26	\$1,752.10
5	2020	0.1668	0.3841	1,397	1,763	\$233	\$677	\$910	1,725	\$288	1,003	\$367	3,122	2,766	521	\$1,062	\$1,583	5.01	5.01	\$50	\$250.32	\$1,833.41
6	2021	0.1621	0.3883	1,397	1,763	\$227	\$685	\$911	1,725	\$280	1,003	\$363	3,122	2,766	506	\$1,074	\$1,580	5.01	5.01	\$60	\$300.39	\$1,880.62
7	2022	0.1629	0.3929	1,397	1,763	\$228	\$693	\$920	1,725	\$281	1,003	\$363	3,122	2,766	509	\$1,087	\$1,595	5.01	5.01	\$70	\$350.45	\$1,945.85
8	2023	0.1639	0.3967	1,397	1,763	\$229	\$699	\$928	1,725	\$283	1,003	\$364	3,122	2,766	512	\$1,097	\$1,609	5.01	5.01	\$80	\$400.52	\$2,009.42
9	2024	0.1648	0.4005	1,397	1,763	\$230	\$706	\$936	1,725	\$284	1,003	\$365	3,122	2,766	515	\$1,108	\$1,622	5.01	5.01	\$90	\$450.58	\$2,072.99
10	2025	0.1656	0.4040	1,397	1,763	\$231	\$712	\$944	1,725	\$286	1,003	\$366	3,122	2,766	517	\$1,117	\$1,634	5.01	5.01	\$100	\$500.65	\$2,135.05
11	2026	0.1665	0.4070	1,397	1,763	\$233	\$718	\$950	1,725	\$287	1,003	\$367	3,122	2,766	520	\$1,126	\$1,646	5.01	5.01	\$110	\$550.71	\$2,196.50
12	2027	0.1674	0.4097	1,397	1,763	\$234	\$722	\$956	1,725	\$289	1,003	\$368	3,122	2,766	523	\$1,133	\$1,656	5.01	5.01	\$120	\$600.78	\$2,256.78
13	2028	0.1683	0.4124	1,397	1,763	\$235	\$727	\$962	1,725	\$290	1,003	\$369	3,122	2,766	525	\$1,141	\$1,666	5.01	5.01	\$130	\$650.84	\$2,316.84
14	2029	0.1692	0.4151	1,397	1,763	\$236	\$732	\$968	1,725	\$292	1,003	\$370	3,122	2,766	528	\$1,148	\$1,676	5.01	5.01	\$140	\$700.90	\$2,377.12
15	2030	0.1701	0.4170	1,397	1,763	\$238	\$735	\$973	1,725	\$293	1,003	\$371	3,122	2,766	531	\$1,153	\$1,684	5.01	5.01	\$150	\$750.97	\$2,435.40
16	2031	0.1704	0.4189	1,397	1,763	\$238	\$739	\$976	1,725	\$294	1,003	\$371	3,122	2,766	532	\$1,159	\$1,691	5.01	5.01	\$160	\$801.03	\$2,491.54
17	2032	0.1705	0.4204	1,397	1,763	\$238	\$741	\$979	1,725	\$294	1,003	\$371	3,122	2,766	532	\$1,163	\$1,695	5.01	5.01	\$170	\$851.10	\$2,546.29
18	2033	0.1707	0.4223	1,397	1,763	\$239	\$745	\$983	1,725	\$295	1,003	\$371	3,122	2,766	533	\$1,168	\$1,701	5.01	5.01	\$180	\$901.16	\$2,602.43
19	2034	0.1710	0.4246	1,397	1,763	\$239	\$749	\$988	1,725	\$295	1,003	\$372	3,122	2,766	534	\$1,175	\$1,709	5.01	5.01	\$190	\$951.23	\$2,659.74
20	2035	0.1713	0.4265	1,397	1,763	\$239	\$752	\$991	1,725	\$295	1,003	\$372	3,122	2,766	535	\$1,180	\$1,715	5.01	5.01	\$200	\$1,001.29	\$2,715.88
21	2036	0.1714	0.4288	1,397	1,763	\$239	\$756	\$996	1,725	\$296	1,003	\$372	3,122	2,766	535	\$1,186	\$1,721	5.01	5.01	\$210	\$1,051.36	\$2,772.75
22	2037	0.1717	0.4311	1,397	1,763	\$240	\$760	\$1,000	1,725	\$296	1,003	\$372	3,122	2,766	536	\$1,193	\$1,729	5.01	5.01	\$220	\$1,101.42	\$2,829.95
23	2038	0.1720	0.4331	1,397	1,763	\$240	\$763	\$1,004	1,725	\$297	1,003	\$372	3,122	2,766	537	\$1,198	\$1,735	5.01	5.01	\$230	\$1,151.49	\$2,886.20
24	2039	0.1722	0.4353	1,397	1,763	\$241	\$768	\$1,008	1,725	\$297	1,003	\$373	3,122	2,766	538	\$1,204	\$1,742	5.01	5.01	\$240	\$1,201.55	\$2,943.40
25	2040	0.1724	0.4376	1,397	1,763	\$241	\$772	\$1,012	1,725	\$297	1,003	\$373	3,122	2,766	538	\$1,211	\$1,749	5.01	5.01	\$250	\$1,251.62	\$3,000.27
26	2041	0.1734	0.4420	1,397	1,763	\$242	\$779	\$1,021	1,725	\$299	1,003	\$374	3,122	2,766	541	\$1,222	\$1,764	5.01	5.01	\$260	\$1,301.68	\$3,065.38
27	2042	0.1744	0.4463	1,397	1,763	\$244	\$787	\$1,030	1,725	\$301	1,003	\$375	3,122	2,766	544	\$1,235	\$1,779	5.01	5.01	\$270	\$1,351.74	\$3,130.63
28	2043	0.1754	0.4507	1,397	1,763	\$245	\$795	\$1,040	1,725	\$303	1,003	\$376	3,122	2,766	548	\$1,247	\$1,794	5.01	5.01	\$280	\$1,401.81	\$3,196.01
29	2044	0.1764	0.4552	1,397	1,763	\$246	\$802	\$1,049	1,725	\$304	1,003	\$377	3,122	2,766	551	\$1,259	\$1,810	5.01	5.01	\$290	\$1,451.87	\$3,261.53
30	2045	0.1774	0.4596	1,397	1,763	\$248	\$810	\$1,058	1,725	\$306	1,003	\$378	3,122	2,766	554	\$1,271	\$1,825	5.01	5.01	\$300	\$1,501.94	\$3,327.20
31	2046	0.1784	0.4642	1,397	1,763	\$249	\$818	\$1,068	1,725	\$308	1,003	\$379	3,122	2,766	557	\$1,284	\$1,841	5.01	5.01	\$310	\$1,552.00	\$3,393.00
32	2047	0.1795	0.4688	1,397	1,763	\$251	\$826	\$1,077	1,725	\$310	1,003	\$380	3,122	2,766	560	\$1,297	\$1,857	5.01	5.01	\$320	\$1,602.07	\$3,458.94
33	2048	0.1805	0.4734	1,397	1,763	\$252	\$835	\$1,087	1,725	\$311	1,003	\$381	3,122	2,766	564	\$1,309	\$1,873	5.01	5.01	\$330	\$1,652.13	\$3,525.03
34	2049	0.1816	0.4780	1,397	1,763	\$254	\$843	\$1,096	1,725	\$313	1,003	\$382	3,122	2,766	567	\$1,322	\$1,889	5.01	5.01	\$340	\$1,702.20	\$3,591.27
35	2050	0.1826	0.4828	1,397	1,763	\$255	\$851	\$1,106	1,725	\$315	1,003	\$383	3,122	2,766	570	\$1,335	\$1,905	5.01	5.01	\$350	\$1,752.26	\$3,657.65
36	2051	0.1837	0.4875	1,397	1,763	\$257	\$859	\$1,116	1,725	\$317	1,003	\$384	3,122	2,766	573	\$1,348	\$1,922	5.01	5.01	\$360	\$1,802.33	\$3,724.17
37	2052	0.1847	0.4923	1,397	1,763	\$258	\$868	\$1,126	1,725	\$319	1,003	\$385	3,122	2,766	577	\$1,362	\$1,938	5.01	5.01	\$370	\$1,852.39	\$3,790.85
38	2053	0.1858	0.4972	1,397	1,763	\$260	\$877	\$1,136	1,725	\$320	1,003	\$386	3,122	2,766	580	\$1,375	\$1,955	5.01	5.01	\$380	\$1,902.45	\$3,857.68
39	2054	0.1869	0.5021	1,397	1,763	\$261	\$885	\$1,146	1,725	\$322	1,003	\$387	3,122	2,766	583	\$1,389	\$1,972	5.01	5.01	\$390	\$1,952.52	\$3,924.65
40	2055	0.1879	0.5070	1,397	1,763	\$263	\$894	\$1,156	1,725	\$324	1,003	\$389	3,122	2,766	587	\$1,402	\$1,989	5.01	5.01	\$400	\$2,002.58	\$3,991.78
41	2056	0.1890	0.5120	1,397	1,763	\$264	\$903	\$1,167	1,725	\$326	1,003	\$390	3,122	2,766	590	\$1,416	\$2,006	5.01	5.01	\$410	\$2,052.65	\$4,059.07
42	2057	0.1901	0.5171	1,397	1,763	\$266	\$912	\$1,177	1,725	\$328	1,003	\$391	3,122	2,766	594	\$1,430	\$2,024	5.01	5.01	\$420	\$2,102.71	\$4,126.51
43	2058	0.1912	0.5222	1,397	1,763	\$267	\$921	\$1,188	1,725	\$330	1,003	\$392	3,122	2,766	597	\$1,444	\$2,041	5.01	5.01	\$430	\$2,152.78	\$4,194.11
44	2059	0.1923	0.5273	1,397	1,763	\$269	\$930	\$1,198	1,725	\$332	1,003	\$393	3,122	2,766	600	\$1,459	\$2,059	5.01	5.01	\$440	\$2,202.84	\$4,261.87
45	2060	0.1934	0.5325	1,397	1,763	\$270	\$939	\$1,209	1,725	\$334	1,003	\$394	3,122	2,766	604	\$1,473	\$2,077	5.01	5.01	\$450	\$2,252.91	\$4,329.79
46	2061	0.1946	0.5378	1,397	1,763	\$272	\$948	\$1,220	1,725	\$336	1,003	\$395	3,122	2,766	607	\$1,487	\$2,095	5.01	5.01	\$460	\$2,302.97	\$4,397.87
47	2062	0.1957	0.5431	1,397	1,763	\$273	\$957	\$1,231	1,725	\$338	1,003	\$396	3,122	2,766	611	\$1,502	\$2,113	5.01	5.01	\$470	\$2,353.04	\$4,466.11
48	2063	0.1968	0.5484	1,397	1,763	\$275	\$967	\$1,242	1,725	\$340	1,003	\$397	3,122	2,766	614	\$1,517	\$2,131	5.01	5.01	\$480	\$2,403.10	\$4,534.52
49	2064	0.1980	0.5538	1,397	1,763	\$277	\$976	\$1,253	1,725	\$341	1,003	\$399	3,122	2,766	618	\$1,532	\$2,150	5.01	5.01	\$490	\$2,453.17	\$4,603.09
50	2065	0.1991	0.5593	1,397	1,763	\$278	\$986	\$1,264	1,725	\$343	1,003	\$200	3,122	2,766	622	\$1,547	\$2,169	5.01	5.01	\$500	\$2,503.23	\$4,671.84
51	2066	0.2003	0.5648	1,397	1,763	\$280	\$996	\$1,276	1,725	\$345	1,003	\$201	3,122	2,766	625	\$1,562	\$2,187	5.01	5.01	\$510	\$2,553.29	\$4,740.75
52	2067	0.2014	0.5704	1,397	1,763	\$281	\$1,006	\$1,287	1,725	\$347	1,003	\$202	3,122	2,766	629	\$1,578	\$2,206	5.01	5.01	\$520	\$2,603.36	\$4,809.83
53	2068	0.2026	0.5760	1,397	1,763	\$283	\$1,015	\$1,298	1,725	\$349	1,003	\$203	3,122	2,766	632	\$1,593	\$2,226	5.01	5.01	\$530	\$2,65	

17. Barrie (Distinct) – Annual Operating Costs

Vertical Ground Source Heat Pump (V.GSHP)

Base Case Scenario											Feed in Tariff (FIT)			
#	Year	Electricity Rates		V.GSHP		V.GSHP		V.GSHP		Total	Total Operating Cost	FIT	FIT	Operating Cost
		\$/KWh	KWh	Heating Operating Cost	Cooling Operating Cost	Hot Water	Hot Water Operating Cost	KWh	\$					
1	2016	0.1501	4,294	\$644	181	\$27	5,014	\$753	9,489	\$1,424	0.05	0.1001	\$949.69	
2	2017	0.1542	4,294	\$662	181	\$28	5,014	\$773	9,489	\$1,463	0.05	0.1042	\$988.63	
3	2018	0.1583	4,294	\$680	181	\$29	5,014	\$794	9,489	\$1,502	0.05	0.1083	\$1,027.57	
4	2019	0.1625	4,294	\$698	181	\$29	5,014	\$815	9,489	\$1,542	0.05	0.1125	\$1,067.88	
5	2020	0.1668	4,294	\$716	181	\$30	5,014	\$836	9,489	\$1,583	0.05	0.1168	\$1,108.19	
6	2021	0.1621	4,294	\$696	181	\$29	5,014	\$813	9,489	\$1,539	0.05	0.1121	\$1,064.12	
7	2022	0.1629	4,294	\$700	181	\$29	5,014	\$817	9,489	\$1,546	0.05	0.1129	\$1,071.64	
8	2023	0.1639	4,294	\$704	181	\$30	5,014	\$822	9,489	\$1,555	0.05	0.1139	\$1,080.52	
9	2024	0.1648	4,294	\$708	181	\$30	5,014	\$826	9,489	\$1,564	0.05	0.1148	\$1,089.40	
10	2025	0.1656	4,294	\$711	181	\$30	5,014	\$830	9,489	\$1,571	0.05	0.1156	\$1,096.92	
11	2026	0.1665	4,294	\$715	181	\$30	5,014	\$835	9,489	\$1,580	0.05	0.1165	\$1,105.80	
12	2027	0.1674	4,294	\$719	181	\$30	5,014	\$840	9,489	\$1,589	0.05	0.1174	\$1,114.34	
13	2028	0.1683	4,294	\$723	181	\$30	5,014	\$844	9,489	\$1,597	0.05	0.1183	\$1,122.19	
14	2029	0.1692	4,294	\$726	181	\$31	5,014	\$848	9,489	\$1,605	0.05	0.1192	\$1,130.73	
15	2030	0.1701	4,294	\$730	181	\$31	5,014	\$853	9,489	\$1,614	0.05	0.1201	\$1,139.62	
16	2031	0.1704	4,294	\$731	181	\$31	5,014	\$854	9,489	\$1,616	0.05	0.1204	\$1,142.01	
17	2032	0.1705	4,294	\$732	181	\$31	5,014	\$855	9,489	\$1,618	0.05	0.1205	\$1,143.37	
18	2033	0.1707	4,294	\$733	181	\$31	5,014	\$856	9,489	\$1,620	0.05	0.1207	\$1,145.76	
19	2034	0.1710	4,294	\$734	181	\$31	5,014	\$858	9,489	\$1,623	0.05	0.1210	\$1,148.50	
20	2035	0.1713	4,294	\$736	181	\$31	5,014	\$859	9,489	\$1,625	0.05	0.1213	\$1,150.89	
21	2036	0.1714	4,294	\$736	181	\$31	5,014	\$860	9,489	\$1,627	0.05	0.1214	\$1,152.26	
22	2037	0.1717	4,294	\$737	181	\$31	5,014	\$861	9,489	\$1,629	0.05	0.1217	\$1,154.65	
23	2038	0.1720	4,294	\$738	181	\$31	5,014	\$862	9,489	\$1,632	0.05	0.1220	\$1,157.38	
24	2039	0.1722	4,294	\$740	181	\$31	5,014	\$864	9,489	\$1,634	0.05	0.1222	\$1,159.77	
25	2040	0.1724	4,294	\$740	181	\$31	5,014	\$864	9,489	\$1,636	0.05	0.1224	\$1,161.14	
26	2041	0.1734	4,294	\$744	181	\$31	5,014	\$869	9,489	\$1,645	0.05	0.1234	\$1,170.60	
27	2042	0.1744	4,294	\$749	181	\$32	5,014	\$874	9,489	\$1,655	0.05	0.1244	\$1,180.11	
28	2043	0.1754	4,294	\$753	181	\$32	5,014	\$879	9,489	\$1,664	0.05	0.1254	\$1,189.69	
29	2044	0.1764	4,294	\$757	181	\$32	5,014	\$884	9,489	\$1,674	0.05	0.1264	\$1,199.31	
30	2045	0.1774	4,294	\$762	181	\$32	5,014	\$890	9,489	\$1,683	0.05	0.1274	\$1,209.00	
31	2046	0.1784	4,294	\$766	181	\$32	5,014	\$895	9,489	\$1,693	0.05	0.1284	\$1,218.73	
32	2047	0.1795	4,294	\$771	181	\$32	5,014	\$900	9,489	\$1,703	0.05	0.1295	\$1,228.53	
33	2048	0.1805	4,294	\$775	181	\$33	5,014	\$905	9,489	\$1,713	0.05	0.1305	\$1,238.38	
34	2049	0.1816	4,294	\$780	181	\$33	5,014	\$910	9,489	\$1,723	0.05	0.1316	\$1,248.29	
35	2050	0.1826	4,294	\$784	181	\$33	5,014	\$916	9,489	\$1,733	0.05	0.1326	\$1,258.25	
36	2051	0.1837	4,294	\$789	181	\$33	5,014	\$921	9,489	\$1,743	0.05	0.1337	\$1,268.28	
37	2052	0.1847	4,294	\$793	181	\$33	5,014	\$926	9,489	\$1,753	0.05	0.1347	\$1,278.36	
38	2053	0.1858	4,294	\$798	181	\$34	5,014	\$932	9,489	\$1,763	0.05	0.1358	\$1,288.50	
39	2054	0.1869	4,294	\$802	181	\$34	5,014	\$937	9,489	\$1,773	0.05	0.1369	\$1,298.70	
40	2055	0.1879	4,294	\$807	181	\$34	5,014	\$942	9,489	\$1,783	0.05	0.1379	\$1,308.96	
41	2056	0.1890	4,294	\$812	181	\$34	5,014	\$948	9,489	\$1,794	0.05	0.1390	\$1,319.27	
42	2057	0.1901	4,294	\$816	181	\$34	5,014	\$953	9,489	\$1,804	0.05	0.1401	\$1,329.65	
43	2058	0.1912	4,294	\$821	181	\$35	5,014	\$959	9,489	\$1,815	0.05	0.1412	\$1,340.08	
44	2059	0.1923	4,294	\$826	181	\$35	5,014	\$964	9,489	\$1,825	0.05	0.1423	\$1,350.58	
45	2060	0.1934	4,294	\$831	181	\$35	5,014	\$970	9,489	\$1,836	0.05	0.1434	\$1,361.14	
46	2061	0.1946	4,294	\$835	181	\$35	5,014	\$976	9,489	\$1,846	0.05	0.1446	\$1,371.76	
47	2062	0.1957	4,294	\$840	181	\$35	5,014	\$981	9,489	\$1,857	0.05	0.1457	\$1,382.44	
48	2063	0.1968	4,294	\$845	181	\$36	5,014	\$987	9,489	\$1,868	0.05	0.1468	\$1,393.18	
49	2064	0.1980	4,294	\$850	181	\$36	5,014	\$993	9,489	\$1,878	0.05	0.1480	\$1,403.98	
50	2065	0.1991	4,294	\$855	181	\$36	5,014	\$998	9,489	\$1,889	0.05	0.1491	\$1,414.85	
51	2066	0.2003	4,294	\$860	181	\$36	5,014	\$1,004	9,489	\$1,900	0.05	0.1503	\$1,425.78	
52	2067	0.2014	4,294	\$865	181	\$36	5,014	\$1,010	9,489	\$1,911	0.05	0.1514	\$1,436.77	
53	2068	0.2026	4,294	\$870	181	\$37	5,014	\$1,016	9,489	\$1,922	0.05	0.1526	\$1,447.83	
54	2069	0.2038	4,294	\$875	181	\$37	5,014	\$1,022	9,489	\$1,933	0.05	0.1538	\$1,458.95	
55	2070	0.2049	4,294	\$880	181	\$37	5,014	\$1,028	9,489	\$1,945	0.05	0.1549	\$1,470.13	
56	2071	0.2061	4,294	\$885	181	\$37	5,014	\$1,033	9,489	\$1,956	0.05	0.1561	\$1,481.38	
57	2072	0.2073	4,294	\$890	181	\$38	5,014	\$1,039	9,489	\$1,967	0.05	0.1573	\$1,492.70	
58	2073	0.2085	4,294	\$895	181	\$38	5,014	\$1,045	9,489	\$1,979	0.05	0.1585	\$1,504.08	
59	2074	0.2097	4,294	\$901	181	\$38	5,014	\$1,052	9,489	\$1,990	0.05	0.1597	\$1,515.52	
60	2075	0.2109	4,294	\$906	181	\$38	5,014	\$1,058	9,489	\$2,001	0.05	0.1609	\$1,527.03	

Table D2-1.49: Annual Operating Costs (V.GSHP) of a 2,000 square feet detached house above grade (improved construction type) in the city of Barrie (two life cycles and three life cycles for a 60 year project lifespan); base case scenario in comparison with feed in-tariff (FIT) scenario. In the FIT scenario, an incentive of \$0.05/KWh is provided on electricity bills throughout the project lifespan

Horizontal Ground Source Heat Pump (H.GSHP)

Base Case Scenario											Feed in Tariff (FIT)		
H.GSHP											FIT		
#	Year	Electricity Rates \$/KWh	Heating KWh	Heating Operating Cost \$	Cooling KWh	Cooling Operating Cost \$	Hot Water KWh	Hot Water Operating Cost \$	Total KWh	Total Operating Cost \$	Incentives (\$/KWh)	\$/KWh	Operating Cost
1	2016	0.1501	4,365	\$655	185	\$28	5,001	\$751	9,551	\$1,433	0.05	0.1001	\$955.89
2	2017	0.1542	4,365	\$673	185	\$29	5,001	\$771	9,551	\$1,473	0.05	0.1042	\$995.09
3	2018	0.1583	4,365	\$691	185	\$29	5,001	\$792	9,551	\$1,512	0.05	0.1083	\$1,034.28
4	2019	0.1625	4,365	\$709	185	\$30	5,001	\$813	9,551	\$1,552	0.05	0.1125	\$1,074.86
5	2020	0.1668	4,365	\$728	185	\$31	5,001	\$834	9,551	\$1,593	0.05	0.1168	\$1,115.43
6	2021	0.1621	4,365	\$708	185	\$30	5,001	\$811	9,551	\$1,549	0.05	0.1121	\$1,071.07
7	2022	0.1629	4,365	\$711	185	\$30	5,001	\$815	9,551	\$1,556	0.05	0.1129	\$1,078.64
8	2023	0.1639	4,365	\$715	185	\$30	5,001	\$820	9,551	\$1,565	0.05	0.1139	\$1,087.58
9	2024	0.1648	4,365	\$719	185	\$30	5,001	\$824	9,551	\$1,574	0.05	0.1148	\$1,096.52
10	2025	0.1656	4,365	\$723	185	\$31	5,001	\$828	9,551	\$1,582	0.05	0.1156	\$1,104.08
11	2026	0.1665	4,365	\$727	185	\$31	5,001	\$833	9,551	\$1,591	0.05	0.1165	\$1,113.02
12	2027	0.1674	4,365	\$731	185	\$31	5,001	\$837	9,551	\$1,599	0.05	0.1174	\$1,121.62
13	2028	0.1683	4,365	\$734	185	\$31	5,001	\$841	9,551	\$1,607	0.05	0.1183	\$1,129.53
14	2029	0.1692	4,365	\$738	185	\$31	5,001	\$846	9,551	\$1,616	0.05	0.1192	\$1,138.12
15	2030	0.1701	4,365	\$742	185	\$31	5,001	\$851	9,551	\$1,625	0.05	0.1201	\$1,147.06
16	2031	0.1704	4,365	\$744	185	\$32	5,001	\$852	9,551	\$1,627	0.05	0.1204	\$1,149.47
17	2032	0.1705	4,365	\$744	185	\$32	5,001	\$853	9,551	\$1,628	0.05	0.1205	\$1,150.84
18	2033	0.1707	4,365	\$745	185	\$32	5,001	\$854	9,551	\$1,631	0.05	0.1207	\$1,153.25
19	2034	0.1710	4,365	\$747	185	\$32	5,001	\$855	9,551	\$1,634	0.05	0.1210	\$1,156.00
20	2035	0.1713	4,365	\$748	185	\$32	5,001	\$857	9,551	\$1,636	0.05	0.1213	\$1,158.41
21	2036	0.1714	4,365	\$748	185	\$32	5,001	\$857	9,551	\$1,637	0.05	0.1214	\$1,159.78
22	2037	0.1717	4,365	\$749	185	\$32	5,001	\$859	9,551	\$1,640	0.05	0.1217	\$1,162.19
23	2038	0.1720	4,365	\$751	185	\$32	5,001	\$860	9,551	\$1,642	0.05	0.1220	\$1,164.94
24	2039	0.1722	4,365	\$752	185	\$32	5,001	\$861	9,551	\$1,645	0.05	0.1222	\$1,167.35
25	2040	0.1724	4,365	\$752	185	\$32	5,001	\$862	9,551	\$1,646	0.05	0.1224	\$1,168.72
26	2041	0.1734	4,365	\$757	185	\$32	5,001	\$867	9,551	\$1,656	0.05	0.1234	\$1,178.25
27	2042	0.1744	4,365	\$761	185	\$32	5,001	\$872	9,551	\$1,665	0.05	0.1244	\$1,187.83
28	2043	0.1754	4,365	\$766	185	\$32	5,001	\$877	9,551	\$1,675	0.05	0.1254	\$1,197.46
29	2044	0.1764	4,365	\$770	185	\$33	5,001	\$882	9,551	\$1,685	0.05	0.1264	\$1,207.15
30	2045	0.1774	4,365	\$774	185	\$33	5,001	\$887	9,551	\$1,694	0.05	0.1274	\$1,216.90
31	2046	0.1784	4,365	\$779	185	\$33	5,001	\$892	9,551	\$1,704	0.05	0.1284	\$1,226.70
32	2047	0.1795	4,365	\$783	185	\$33	5,001	\$898	9,551	\$1,714	0.05	0.1295	\$1,236.56
33	2048	0.1805	4,365	\$788	185	\$33	5,001	\$903	9,551	\$1,724	0.05	0.1305	\$1,246.47
34	2049	0.1816	4,365	\$792	185	\$34	5,001	\$908	9,551	\$1,734	0.05	0.1316	\$1,256.45
35	2050	0.1826	4,365	\$797	185	\$34	5,001	\$913	9,551	\$1,744	0.05	0.1326	\$1,266.48
36	2051	0.1837	4,365	\$802	185	\$34	5,001	\$918	9,551	\$1,754	0.05	0.1337	\$1,276.56
37	2052	0.1847	4,365	\$806	185	\$34	5,001	\$924	9,551	\$1,764	0.05	0.1347	\$1,286.71
38	2053	0.1858	4,365	\$811	185	\$34	5,001	\$929	9,551	\$1,774	0.05	0.1358	\$1,296.92
39	2054	0.1869	4,365	\$816	185	\$35	5,001	\$935	9,551	\$1,785	0.05	0.1369	\$1,307.18
40	2055	0.1879	4,365	\$820	185	\$35	5,001	\$940	9,551	\$1,795	0.05	0.1379	\$1,317.51
41	2056	0.1890	4,365	\$825	185	\$35	5,001	\$945	9,551	\$1,805	0.05	0.1390	\$1,327.89
42	2057	0.1901	4,365	\$830	185	\$35	5,001	\$951	9,551	\$1,816	0.05	0.1401	\$1,338.34
43	2058	0.1912	4,365	\$835	185	\$35	5,001	\$956	9,551	\$1,826	0.05	0.1412	\$1,348.84
44	2059	0.1923	4,365	\$840	185	\$36	5,001	\$962	9,551	\$1,837	0.05	0.1423	\$1,359.41
45	2060	0.1934	4,365	\$844	185	\$36	5,001	\$967	9,551	\$1,848	0.05	0.1434	\$1,370.03
46	2061	0.1946	4,365	\$849	185	\$36	5,001	\$973	9,551	\$1,858	0.05	0.1446	\$1,380.72
47	2062	0.1957	4,365	\$854	185	\$36	5,001	\$979	9,551	\$1,869	0.05	0.1457	\$1,391.47
48	2063	0.1968	4,365	\$859	185	\$36	5,001	\$984	9,551	\$1,880	0.05	0.1468	\$1,402.28
49	2064	0.1980	4,365	\$864	185	\$37	5,001	\$990	9,551	\$1,891	0.05	0.1480	\$1,413.16
50	2065	0.1991	4,365	\$869	185	\$37	5,001	\$996	9,551	\$1,902	0.05	0.1491	\$1,424.09
51	2066	0.2003	4,365	\$874	185	\$37	5,001	\$1,001	9,551	\$1,913	0.05	0.1503	\$1,435.10
52	2067	0.2014	4,365	\$879	185	\$37	5,001	\$1,007	9,551	\$1,924	0.05	0.1514	\$1,446.16
53	2068	0.2026	4,365	\$884	185	\$37	5,001	\$1,013	9,551	\$1,935	0.05	0.1526	\$1,457.29
54	2069	0.2038	4,365	\$889	185	\$38	5,001	\$1,019	9,551	\$1,946	0.05	0.1538	\$1,468.48
55	2070	0.2049	4,365	\$895	185	\$38	5,001	\$1,025	9,551	\$1,957	0.05	0.1549	\$1,479.74
56	2071	0.2061	4,365	\$900	185	\$38	5,001	\$1,031	9,551	\$1,969	0.05	0.1561	\$1,491.06
57	2072	0.2073	4,365	\$905	185	\$38	5,001	\$1,037	9,551	\$1,980	0.05	0.1573	\$1,502.45
58	2073	0.2085	4,365	\$910	185	\$39	5,001	\$1,043	9,551	\$1,991	0.05	0.1585	\$1,513.90
59	2074	0.2097	4,365	\$915	185	\$39	5,001	\$1,049	9,551	\$2,003	0.05	0.1597	\$1,525.42
60	2075	0.2109	4,365	\$921	185	\$39	5,001	\$1,055	9,551	\$2,015	0.05	0.1609	\$1,537.01

Table D2-1.50: Annual Operating Costs (H.GSHP) of a 2,000 square feet detached house above grade (improved construction type) in the city of Barrie (two life cycles and three life cycles for a 60 year project lifespan); base case scenario in comparison with feed in-tariff (FIT) scenario. In the FIT scenario, an incentive of \$0.05/KWh is provided on electricity bills throughout the project lifespan

Traditional HVAC Applications

Base Case Scenario															Carbon Taxes							
#	Year	Electricity Rates \$/KWh	Natural Gas Rates \$/m ³	Heating		Heating Operating Cost	Heating Operating Cost	Total Heating Operating Cost	Cooling	Cooling Operating Cost	Hot Water	Hot Water Operating Cost	Total	Total	Total Electricity Operating Cost	Total Natural Gas Operating Cost	Total	Conversion of m ³ into Tons	Total Tons	Carbon Tax	Operating Costs	
				KWh (Electricity)	m ³ (Gas)	\$(Electricity)	\$(Gas)	\$	KWh	\$	m ³	\$	KWh	m ³	\$(KWh)	\$(m ³)			10			
1	2016	0.1501	0.3458	1,520	2,051	\$228	\$709	\$937	846	\$127	1,058	\$366	2,366	3,109	355	\$1,075	\$1,430	5.63	5.63	\$10	\$56.27	\$1,486.55
2	2017	0.1542	0.3588	1,520	2,051	\$234	\$736	\$970	846	\$130	1,058	\$163	2,366	3,109	365	\$1,116	\$1,480	5.63	5.63	\$20	\$112.55	\$1,592.98
3	2018	0.1583	0.3718	1,520	2,051	\$241	\$763	\$1,003	846	\$134	1,058	\$167	2,366	3,109	375	\$1,156	\$1,531	5.63	5.63	\$30	\$168.82	\$1,699.40
4	2019	0.1625	0.3776	1,520	2,051	\$247	\$774	\$1,021	846	\$138	1,058	\$172	2,366	3,109	385	\$1,174	\$1,558	5.63	5.63	\$40	\$225.09	\$1,783.56
5	2020	0.1668	0.3841	1,520	2,051	\$254	\$788	\$1,041	846	\$141	1,058	\$176	2,366	3,109	395	\$1,194	\$1,589	5.63	5.63	\$50	\$281.36	\$1,870.10
6	2021	0.1621	0.3883	1,520	2,051	\$246	\$796	\$1,043	846	\$137	1,058	\$172	2,366	3,109	384	\$1,207	\$1,591	5.63	5.63	\$60	\$337.64	\$1,928.47
7	2022	0.1629	0.3929	1,520	2,051	\$248	\$806	\$1,053	846	\$138	1,058	\$172	2,366	3,109	386	\$1,221	\$1,607	5.63	5.63	\$70	\$393.91	\$2,000.89
8	2023	0.1639	0.3967	1,520	2,051	\$249	\$814	\$1,063	846	\$139	1,058	\$173	2,366	3,109	388	\$1,233	\$1,621	5.63	5.63	\$80	\$450.18	\$2,071.27
9	2024	0.1648	0.4005	1,520	2,051	\$251	\$821	\$1,072	846	\$139	1,058	\$174	2,366	3,109	390	\$1,245	\$1,635	5.63	5.63	\$90	\$506.46	\$2,141.65
10	2025	0.1656	0.4040	1,520	2,051	\$252	\$829	\$1,080	846	\$140	1,058	\$175	2,366	3,109	392	\$1,256	\$1,648	5.63	5.63	\$100	\$562.73	\$2,210.50
11	2026	0.1665	0.4070	1,520	2,051	\$253	\$835	\$1,088	846	\$141	1,058	\$176	2,366	3,109	394	\$1,265	\$1,660	5.63	5.63	\$110	\$619.00	\$2,278.51
12	2027	0.1674	0.4097	1,520	2,051	\$256	\$840	\$1,095	846	\$142	1,058	\$177	2,366	3,109	396	\$1,274	\$1,670	5.63	5.63	\$120	\$675.27	\$2,345.24
13	2028	0.1683	0.4124	1,520	2,051	\$256	\$846	\$1,102	846	\$142	1,058	\$178	2,366	3,109	398	\$1,282	\$1,680	5.63	5.63	\$130	\$731.55	\$2,411.79
14	2029	0.1692	0.4151	1,520	2,051	\$257	\$851	\$1,108	846	\$143	1,058	\$179	2,366	3,109	400	\$1,290	\$1,691	5.63	5.63	\$140	\$787.82	\$2,478.52
15	2030	0.1701	0.4170	1,520	2,051	\$259	\$855	\$1,114	846	\$144	1,058	\$180	2,366	3,109	402	\$1,296	\$1,699	5.63	5.63	\$150	\$844.09	\$2,542.95
16	2031	0.1704	0.4189	1,520	2,051	\$259	\$859	\$1,118	846	\$144	1,058	\$180	2,366	3,109	403	\$1,302	\$1,705	5.63	5.63	\$160	\$900.37	\$2,605.77
17	2032	0.1705	0.4204	1,520	2,051	\$259	\$862	\$1,121	846	\$144	1,058	\$180	2,366	3,109	403	\$1,307	\$1,711	5.63	5.63	\$170	\$956.64	\$2,667.14
18	2033	0.1707	0.4223	1,520	2,051	\$260	\$866	\$1,126	846	\$144	1,058	\$181	2,366	3,109	404	\$1,313	\$1,717	5.63	5.63	\$180	\$1,012.91	\$2,729.96
19	2034	0.1710	0.4246	1,520	2,051	\$260	\$871	\$1,131	846	\$145	1,058	\$181	2,366	3,109	405	\$1,320	\$1,725	5.63	5.63	\$190	\$1,069.19	\$2,794.05
20	2035	0.1713	0.4265	1,520	2,051	\$260	\$875	\$1,135	846	\$145	1,058	\$181	2,366	3,109	405	\$1,326	\$1,731	5.63	5.63	\$200	\$1,125.46	\$2,856.86
21	2036	0.1714	0.4288	1,520	2,051	\$261	\$880	\$1,140	846	\$145	1,058	\$181	2,366	3,109	406	\$1,333	\$1,739	5.63	5.63	\$210	\$1,181.73	\$2,920.61
22	2037	0.1717	0.4311	1,520	2,051	\$261	\$884	\$1,145	846	\$145	1,058	\$182	2,366	3,109	406	\$1,340	\$1,747	5.63	5.63	\$220	\$1,238.00	\$2,984.62
23	2038	0.1720	0.4331	1,520	2,051	\$261	\$888	\$1,150	846	\$145	1,058	\$182	2,366	3,109	407	\$1,346	\$1,753	5.63	5.63	\$230	\$1,294.28	\$3,047.52
24	2039	0.1722	0.4353	1,520	2,051	\$262	\$893	\$1,155	846	\$146	1,058	\$182	2,366	3,109	407	\$1,353	\$1,761	5.63	5.63	\$240	\$1,350.55	\$3,111.53
25	2040	0.1724	0.4376	1,520	2,051	\$262	\$898	\$1,160	846	\$146	1,058	\$182	2,366	3,109	408	\$1,361	\$1,768	5.63	5.63	\$250	\$1,406.82	\$3,175.28
26	2041	0.1734	0.4420	1,520	2,051	\$264	\$906	\$1,170	846	\$147	1,058	\$183	2,366	3,109	410	\$1,374	\$1,784	5.63	5.63	\$260	\$1,463.10	\$3,247.32
27	2042	0.1744	0.4463	1,520	2,051	\$265	\$915	\$1,180	846	\$148	1,058	\$184	2,366	3,109	413	\$1,388	\$1,800	5.63	5.63	\$270	\$1,519.37	\$3,319.51
28	2043	0.1754	0.4507	1,520	2,051	\$267	\$924	\$1,191	846	\$148	1,058	\$186	2,366	3,109	415	\$1,401	\$1,816	5.63	5.63	\$280	\$1,575.64	\$3,391.85
29	2044	0.1764	0.4552	1,520	2,051	\$268	\$934	\$1,202	846	\$149	1,058	\$187	2,366	3,109	417	\$1,415	\$1,832	5.63	5.63	\$290	\$1,631.91	\$3,464.34
30	2045	0.1774	0.4596	1,520	2,051	\$270	\$943	\$1,212	846	\$150	1,058	\$188	2,366	3,109	420	\$1,429	\$1,849	5.63	5.63	\$300	\$1,688.19	\$3,536.98
31	2046	0.1784	0.4642	1,520	2,051	\$271	\$952	\$1,223	846	\$151	1,058	\$189	2,366	3,109	422	\$1,443	\$1,865	5.63	5.63	\$310	\$1,744.46	\$3,609.77
32	2047	0.1795	0.4688	1,520	2,051	\$273	\$961	\$1,234	846	\$152	1,058	\$190	2,366	3,109	425	\$1,457	\$1,882	5.63	5.63	\$320	\$1,800.73	\$3,682.71
33	2048	0.1805	0.4734	1,520	2,051	\$274	\$971	\$1,245	846	\$153	1,058	\$191	2,366	3,109	427	\$1,472	\$1,899	5.63	5.63	\$330	\$1,857.01	\$3,755.81
34	2049	0.1816	0.4780	1,520	2,051	\$276	\$980	\$1,256	846	\$154	1,058	\$192	2,366	3,109	430	\$1,486	\$1,916	5.63	5.63	\$340	\$1,913.28	\$3,829.06
35	2050	0.1826	0.4828	1,520	2,051	\$278	\$990	\$1,268	846	\$154	1,058	\$193	2,366	3,109	432	\$1,501	\$1,933	5.63	5.63	\$350	\$1,969.55	\$3,902.48
36	2051	0.1837	0.4875	1,520	2,051	\$279	\$1,000	\$1,279	846	\$155	1,058	\$194	2,366	3,109	435	\$1,516	\$1,950	5.63	5.63	\$360	\$2,025.82	\$3,976.04
37	2052	0.1847	0.4923	1,520	2,051	\$281	\$1,010	\$1,291	846	\$156	1,058	\$195	2,366	3,109	437	\$1,531	\$1,968	5.63	5.63	\$370	\$2,082.10	\$4,049.77
38	2053	0.1858	0.4972	1,520	2,051	\$282	\$1,020	\$1,302	846	\$157	1,058	\$197	2,366	3,109	440	\$1,546	\$1,985	5.63	5.63	\$380	\$2,138.37	\$4,123.67
39	2054	0.1869	0.5021	1,520	2,051	\$284	\$1,030	\$1,314	846	\$158	1,058	\$198	2,366	3,109	442	\$1,561	\$2,003	5.63	5.63	\$390	\$2,194.64	\$4,197.72
40	2055	0.1879	0.5070	1,520	2,051	\$286	\$1,040	\$1,326	846	\$159	1,058	\$199	2,366	3,109	445	\$1,576	\$2,021	5.63	5.63	\$400	\$2,250.92	\$4,271.94
41	2056	0.1890	0.5120	1,520	2,051	\$287	\$1,050	\$1,337	846	\$160	1,058	\$200	2,366	3,109	447	\$1,592	\$2,039	5.63	5.63	\$410	\$2,307.19	\$4,346.33
42	2057	0.1901	0.5171	1,520	2,051	\$289	\$1,061	\$1,350	846	\$161	1,058	\$201	2,366	3,109	450	\$1,608	\$2,057	5.63	5.63	\$420	\$2,363.46	\$4,420.88
43	2058	0.1912	0.5222	1,520	2,051	\$291	\$1,071	\$1,362	846	\$162	1,058	\$202	2,366	3,109	452	\$1,623	\$2,076	5.63	5.63	\$430	\$2,419.73	\$4,495.61
44	2059	0.1923	0.5273	1,520	2,051	\$292	\$1,082	\$1,374	846	\$163	1,058	\$203	2,366	3,109	455	\$1,639	\$2,094	5.63	5.63	\$440	\$2,476.01	\$4,570.50
45	2060	0.1934	0.5325	1,520	2,051	\$294	\$1,092	\$1,386	846	\$164	1,058	\$205	2,366	3,109	458	\$1,656	\$2,113	5.63	5.63	\$450	\$2,532.28	\$4,645.57
46	2061	0.1946	0.5378	1,520	2,051	\$296	\$1,103	\$1,399	846	\$165	1,058	\$206	2,366	3,109	460	\$1,672	\$2,132	5.63	5.63	\$460	\$2,588.55	\$4,720.81
47	2062	0.1957	0.5431	1,520	2,051	\$297	\$1,114	\$1,411	846	\$166	1,058	\$207	2,366	3,109	463	\$1,688	\$2,151	5.63	5.63	\$470	\$2,644.83	\$4,796.23
48	2063	0.1968	0.5484	1,520	2,051	\$299	\$1,125	\$1,424	846	\$167	1,058	\$208	2,366	3,109	466	\$1,705	\$2,171	5.63	5.63	\$480	\$2,701.10	\$4,871.83
49	2064	0.1980	0.5538	1,520	2,051	\$301	\$1,136	\$1,437	846	\$167	1,058	\$209	2,366	3,109	468	\$1,722	\$2,190	5.63	5.63	\$490	\$2,757.37	\$4,947.61
50	2065	0.1991	0.5593	1,520	2,051	\$303	\$1,147	\$1,450	846	\$168	1,058	\$211	2,366	3,109	471	\$1,739	\$2,210	5.63	5.63	\$500	\$2,813.65	\$5,023.57
51	2066	0.2003	0.5648	1,520	2,051	\$304	\$1,158	\$1,463	846	\$169	1,058	\$212	2,366	3,109	474	\$1,756	\$2,230	5.63	5.63	\$510	\$2,869.92	\$5,099.71
52	2067	0.2014	0.5704	1,520	2,051	\$306	\$1,170	\$1,476	846	\$170	1,058	\$213	2,366	3,109	477	\$1,773	\$2,250	5.63	5.63	\$520	\$2,926.19	\$5,176.03
53	2068	0.2026	0.5760	1,520	2,051	\$308	\$1,181	\$1,489	846	\$171	1,058	\$214	2,366	3,109	479	\$1,791	\$2,270	5.63	5.63	\$530	\$2,982.46	\$5,252.54
54	2069	0.2038	0.5817	1,520	2,051	\$310	\$1,193	\$1,50														

18. Muskoka (Distinct) – Annual Operating Costs

Vertical Ground Source Heat Pump (V.GSHP)

Base Case Scenario											Feed in Tariff (FIT)		
#	Year	Electricity Rates		V.GSHP		Hot Water		Total		Total Operating Cost	FIT		
		\$/KWh	KWh	Heating Operating Cost	Cooling Operating Cost	Hot Water Operating Cost	Total Operating Cost	Incentives (\$/KWh)	\$/KWh		Operating Cost		
1	2016	0.1501	4,747	\$712	188	\$28	4,875	\$732	9,810	\$1,472	0.05	0.1001	\$981.81
2	2017	0.1542	4,747	\$732	188	\$29	4,875	\$752	9,810	\$1,513	0.05	0.1042	\$1,022.07
3	2018	0.1583	4,747	\$751	188	\$30	4,875	\$772	9,810	\$1,553	0.05	0.1083	\$1,062.33
4	2019	0.1625	4,747	\$772	188	\$31	4,875	\$792	9,810	\$1,595	0.05	0.1125	\$1,104.00
5	2020	0.1668	4,747	\$792	188	\$31	4,875	\$813	9,810	\$1,636	0.05	0.1168	\$1,145.68
6	2021	0.1621	4,747	\$770	188	\$30	4,875	\$790	9,810	\$1,591	0.05	0.1121	\$1,100.12
7	2022	0.1629	4,747	\$773	188	\$31	4,875	\$794	9,810	\$1,598	0.05	0.1129	\$1,107.89
8	2023	0.1639	4,747	\$778	188	\$31	4,875	\$799	9,810	\$1,608	0.05	0.1139	\$1,117.07
9	2024	0.1648	4,747	\$782	188	\$31	4,875	\$803	9,810	\$1,617	0.05	0.1148	\$1,126.25
10	2025	0.1656	4,747	\$786	188	\$31	4,875	\$807	9,810	\$1,625	0.05	0.1156	\$1,134.02
11	2026	0.1665	4,747	\$791	188	\$31	4,875	\$812	9,810	\$1,634	0.05	0.1165	\$1,143.21
12	2027	0.1674	4,747	\$795	188	\$31	4,875	\$816	9,810	\$1,643	0.05	0.1174	\$1,152.03
13	2028	0.1683	4,747	\$799	188	\$32	4,875	\$820	9,810	\$1,651	0.05	0.1183	\$1,160.16
14	2029	0.1692	4,747	\$803	188	\$32	4,875	\$825	9,810	\$1,659	0.05	0.1192	\$1,168.99
15	2030	0.1701	4,747	\$807	188	\$32	4,875	\$829	9,810	\$1,669	0.05	0.1201	\$1,178.17
16	2031	0.1704	4,747	\$809	188	\$32	4,875	\$830	9,810	\$1,671	0.05	0.1204	\$1,180.64
17	2032	0.1705	4,747	\$809	188	\$32	4,875	\$831	9,810	\$1,673	0.05	0.1205	\$1,182.05
18	2033	0.1707	4,747	\$811	188	\$32	4,875	\$832	9,810	\$1,675	0.05	0.1207	\$1,184.52
19	2034	0.1710	4,747	\$812	188	\$32	4,875	\$834	9,810	\$1,678	0.05	0.1210	\$1,187.35
20	2035	0.1713	4,747	\$813	188	\$32	4,875	\$835	9,810	\$1,680	0.05	0.1213	\$1,189.82
21	2036	0.1714	4,747	\$814	188	\$32	4,875	\$836	9,810	\$1,682	0.05	0.1214	\$1,191.23
22	2037	0.1717	4,747	\$815	188	\$32	4,875	\$837	9,810	\$1,684	0.05	0.1217	\$1,193.71
23	2038	0.1720	4,747	\$816	188	\$32	4,875	\$838	9,810	\$1,687	0.05	0.1220	\$1,196.53
24	2039	0.1722	4,747	\$818	188	\$32	4,875	\$840	9,810	\$1,690	0.05	0.1222	\$1,199.00
25	2040	0.1724	4,747	\$818	188	\$32	4,875	\$840	9,810	\$1,691	0.05	0.1224	\$1,200.42
26	2041	0.1734	4,747	\$823	188	\$33	4,875	\$845	9,810	\$1,701	0.05	0.1234	\$1,210.20
27	2042	0.1744	4,747	\$828	188	\$33	4,875	\$850	9,810	\$1,711	0.05	0.1244	\$1,220.04
28	2043	0.1754	4,747	\$833	188	\$33	4,875	\$855	9,810	\$1,720	0.05	0.1254	\$1,229.93
29	2044	0.1764	4,747	\$837	188	\$33	4,875	\$860	9,810	\$1,730	0.05	0.1264	\$1,239.88
30	2045	0.1774	4,747	\$842	188	\$33	4,875	\$865	9,810	\$1,740	0.05	0.1274	\$1,249.89
31	2046	0.1784	4,747	\$847	188	\$34	4,875	\$870	9,810	\$1,750	0.05	0.1284	\$1,259.96
32	2047	0.1795	4,747	\$852	188	\$34	4,875	\$875	9,810	\$1,761	0.05	0.1295	\$1,270.09
33	2048	0.1805	4,747	\$857	188	\$34	4,875	\$880	9,810	\$1,771	0.05	0.1305	\$1,280.27
34	2049	0.1816	4,747	\$862	188	\$34	4,875	\$885	9,810	\$1,781	0.05	0.1316	\$1,290.52
35	2050	0.1826	4,747	\$867	188	\$34	4,875	\$890	9,810	\$1,791	0.05	0.1326	\$1,300.82
36	2051	0.1837	4,747	\$872	188	\$35	4,875	\$895	9,810	\$1,802	0.05	0.1337	\$1,311.18
37	2052	0.1847	4,747	\$877	188	\$35	4,875	\$901	9,810	\$1,812	0.05	0.1347	\$1,321.60
38	2053	0.1858	4,747	\$882	188	\$35	4,875	\$906	9,810	\$1,823	0.05	0.1358	\$1,332.09
39	2054	0.1869	4,747	\$887	188	\$35	4,875	\$911	9,810	\$1,833	0.05	0.1369	\$1,342.63
40	2055	0.1879	4,747	\$892	188	\$35	4,875	\$916	9,810	\$1,844	0.05	0.1379	\$1,353.24
41	2056	0.1890	4,747	\$897	188	\$36	4,875	\$922	9,810	\$1,854	0.05	0.1390	\$1,363.90
42	2057	0.1901	4,747	\$903	188	\$36	4,875	\$927	9,810	\$1,865	0.05	0.1401	\$1,374.63
43	2058	0.1912	4,747	\$908	188	\$36	4,875	\$932	9,810	\$1,876	0.05	0.1412	\$1,385.42
44	2059	0.1923	4,747	\$913	188	\$36	4,875	\$938	9,810	\$1,887	0.05	0.1423	\$1,396.27
45	2060	0.1934	4,747	\$918	188	\$36	4,875	\$943	9,810	\$1,898	0.05	0.1434	\$1,407.18
46	2061	0.1946	4,747	\$924	188	\$37	4,875	\$948	9,810	\$1,909	0.05	0.1446	\$1,418.16
47	2062	0.1957	4,747	\$929	188	\$37	4,875	\$954	9,810	\$1,920	0.05	0.1457	\$1,429.20
48	2063	0.1968	4,747	\$934	188	\$37	4,875	\$959	9,810	\$1,931	0.05	0.1468	\$1,440.31
49	2064	0.1980	4,747	\$940	188	\$37	4,875	\$965	9,810	\$1,942	0.05	0.1480	\$1,451.48
50	2065	0.1991	4,747	\$945	188	\$37	4,875	\$971	9,810	\$1,953	0.05	0.1491	\$1,462.71
51	2066	0.2003	4,747	\$951	188	\$38	4,875	\$976	9,810	\$1,965	0.05	0.1503	\$1,474.01
52	2067	0.2014	4,747	\$956	188	\$38	4,875	\$982	9,810	\$1,976	0.05	0.1514	\$1,485.38
53	2068	0.2026	4,747	\$962	188	\$38	4,875	\$988	9,810	\$1,987	0.05	0.1526	\$1,496.81
54	2069	0.2038	4,747	\$967	188	\$38	4,875	\$993	9,810	\$1,999	0.05	0.1538	\$1,508.30
55	2070	0.2049	4,747	\$973	188	\$39	4,875	\$999	9,810	\$2,010	0.05	0.1549	\$1,519.87
56	2071	0.2061	4,747	\$978	188	\$39	4,875	\$1,005	9,810	\$2,022	0.05	0.1561	\$1,531.50
57	2072	0.2073	4,747	\$984	188	\$39	4,875	\$1,011	9,810	\$2,034	0.05	0.1573	\$1,543.19
58	2073	0.2085	4,747	\$990	188	\$39	4,875	\$1,016	9,810	\$2,045	0.05	0.1585	\$1,554.96
59	2074	0.2097	4,747	\$996	188	\$39	4,875	\$1,022	9,810	\$2,057	0.05	0.1597	\$1,566.79
60	2075	0.2109	4,747	\$1,001	188	\$40	4,875	\$1,028	9,810	\$2,069	0.05	0.1609	\$1,578.69

Table D2-1.52: Annual Operating Costs (V.GSHP) of a 2,000 square feet detached house above grade (improved construction type) in the city of Muskoka (two life cycles and three life cycles for a 60 year project lifespan); base case scenario in comparison with feed-in-tariff (FIT) scenario. In the FIT scenario, an incentive of \$0.05/KWh is provided on electricity bills throughout the project lifespan

Horizontal Ground Source Heat Pump (H.GSHP)

Base Case Scenario											Feed in Tariff (FIT)		
H.GSHP													
#	Year	Electricity Rates \$/KWh	Heating KWh	Heating Operating Cost \$	Cooling KWh	Cooling Operating Cost \$	Hot Water KWh	Hot Water Operating Cost \$	Total KWh	Total Operating Cost \$	Incentives (\$/KWh)	FIT \$/KWh	Operating Cost
1	2016	0.1501	4,820	\$723	192	\$29	4,860	\$729	9,872	\$1,482	0.05	0.1001	\$988.02
2	2017	0.1542	4,820	\$743	192	\$30	4,860	\$749	9,872	\$1,522	0.05	0.1042	\$1,028.53
3	2018	0.1583	4,820	\$763	192	\$30	4,860	\$769	9,872	\$1,563	0.05	0.1083	\$1,069.05
4	2019	0.1625	4,820	\$783	192	\$31	4,860	\$790	9,872	\$1,605	0.05	0.1125	\$1,110.98
5	2020	0.1668	4,820	\$804	192	\$32	4,860	\$811	9,872	\$1,647	0.05	0.1168	\$1,152.92
6	2021	0.1621	4,820	\$782	192	\$31	4,860	\$788	9,872	\$1,601	0.05	0.1121	\$1,107.07
7	2022	0.1629	4,820	\$785	192	\$31	4,860	\$792	9,872	\$1,608	0.05	0.1129	\$1,114.89
8	2023	0.1639	4,820	\$790	192	\$31	4,860	\$796	9,872	\$1,618	0.05	0.1139	\$1,124.13
9	2024	0.1648	4,820	\$794	192	\$32	4,860	\$801	9,872	\$1,627	0.05	0.1148	\$1,133.37
10	2025	0.1656	4,820	\$798	192	\$32	4,860	\$805	9,872	\$1,635	0.05	0.1156	\$1,141.19
11	2026	0.1665	4,820	\$803	192	\$32	4,860	\$809	9,872	\$1,644	0.05	0.1165	\$1,150.43
12	2027	0.1674	4,820	\$807	192	\$32	4,860	\$814	9,872	\$1,653	0.05	0.1174	\$1,159.31
13	2028	0.1683	4,820	\$811	192	\$32	4,860	\$818	9,872	\$1,661	0.05	0.1183	\$1,167.49
14	2029	0.1692	4,820	\$815	192	\$32	4,860	\$822	9,872	\$1,670	0.05	0.1192	\$1,176.37
15	2030	0.1701	4,820	\$820	192	\$33	4,860	\$827	9,872	\$1,679	0.05	0.1201	\$1,185.61
16	2031	0.1704	4,820	\$821	192	\$33	4,860	\$828	9,872	\$1,682	0.05	0.1204	\$1,188.10
17	2032	0.1705	4,820	\$822	192	\$33	4,860	\$829	9,872	\$1,683	0.05	0.1205	\$1,189.52
18	2033	0.1707	4,820	\$823	192	\$33	4,860	\$830	9,872	\$1,686	0.05	0.1207	\$1,192.01
19	2034	0.1710	4,820	\$824	192	\$33	4,860	\$831	9,872	\$1,688	0.05	0.1210	\$1,194.85
20	2035	0.1713	4,820	\$826	192	\$33	4,860	\$832	9,872	\$1,691	0.05	0.1213	\$1,197.34
21	2036	0.1714	4,820	\$826	192	\$33	4,860	\$833	9,872	\$1,692	0.05	0.1214	\$1,198.76
22	2037	0.1717	4,820	\$828	192	\$33	4,860	\$834	9,872	\$1,695	0.05	0.1217	\$1,201.25
23	2038	0.1720	4,820	\$829	192	\$33	4,860	\$836	9,872	\$1,698	0.05	0.1220	\$1,204.09
24	2039	0.1722	4,820	\$830	192	\$33	4,860	\$837	9,872	\$1,700	0.05	0.1222	\$1,206.58
25	2040	0.1724	4,820	\$831	192	\$33	4,860	\$838	9,872	\$1,702	0.05	0.1224	\$1,208.00
26	2041	0.1734	4,820	\$836	192	\$33	4,860	\$843	9,872	\$1,711	0.05	0.1234	\$1,217.85
27	2042	0.1744	4,820	\$840	192	\$33	4,860	\$847	9,872	\$1,721	0.05	0.1244	\$1,227.75
28	2043	0.1754	4,820	\$845	192	\$34	4,860	\$852	9,872	\$1,731	0.05	0.1254	\$1,237.71
29	2044	0.1764	4,820	\$850	192	\$34	4,860	\$857	9,872	\$1,741	0.05	0.1264	\$1,247.72
30	2045	0.1774	4,820	\$855	192	\$34	4,860	\$862	9,872	\$1,751	0.05	0.1274	\$1,257.79
31	2046	0.1784	4,820	\$860	192	\$34	4,860	\$867	9,872	\$1,762	0.05	0.1284	\$1,267.93
32	2047	0.1795	4,820	\$865	192	\$34	4,860	\$872	9,872	\$1,772	0.05	0.1295	\$1,278.12
33	2048	0.1805	4,820	\$870	192	\$35	4,860	\$877	9,872	\$1,782	0.05	0.1305	\$1,288.36
34	2049	0.1816	4,820	\$875	192	\$35	4,860	\$882	9,872	\$1,792	0.05	0.1316	\$1,298.67
35	2050	0.1826	4,820	\$880	192	\$35	4,860	\$887	9,872	\$1,803	0.05	0.1326	\$1,309.04
36	2051	0.1837	4,820	\$885	192	\$35	4,860	\$893	9,872	\$1,813	0.05	0.1337	\$1,319.47
37	2052	0.1847	4,820	\$890	192	\$35	4,860	\$898	9,872	\$1,824	0.05	0.1347	\$1,329.96
38	2053	0.1858	4,820	\$896	192	\$36	4,860	\$903	9,872	\$1,834	0.05	0.1358	\$1,340.51
39	2054	0.1869	4,820	\$901	192	\$36	4,860	\$908	9,872	\$1,845	0.05	0.1369	\$1,351.12
40	2055	0.1879	4,820	\$906	192	\$36	4,860	\$913	9,872	\$1,855	0.05	0.1379	\$1,361.79
41	2056	0.1890	4,820	\$911	192	\$36	4,860	\$919	9,872	\$1,866	0.05	0.1390	\$1,372.52
42	2057	0.1901	4,820	\$916	192	\$37	4,860	\$924	9,872	\$1,877	0.05	0.1401	\$1,383.32
43	2058	0.1912	4,820	\$922	192	\$37	4,860	\$929	9,872	\$1,888	0.05	0.1412	\$1,394.17
44	2059	0.1923	4,820	\$927	192	\$37	4,860	\$935	9,872	\$1,899	0.05	0.1423	\$1,405.09
45	2060	0.1934	4,820	\$932	192	\$37	4,860	\$940	9,872	\$1,910	0.05	0.1434	\$1,416.08
46	2061	0.1946	4,820	\$938	192	\$37	4,860	\$946	9,872	\$1,921	0.05	0.1446	\$1,427.13
47	2062	0.1957	4,820	\$943	192	\$38	4,860	\$951	9,872	\$1,932	0.05	0.1457	\$1,438.24
48	2063	0.1968	4,820	\$949	192	\$38	4,860	\$957	9,872	\$1,943	0.05	0.1468	\$1,449.41
49	2064	0.1980	4,820	\$954	192	\$38	4,860	\$962	9,872	\$1,954	0.05	0.1480	\$1,460.65
50	2065	0.1991	4,820	\$960	192	\$38	4,860	\$968	9,872	\$1,966	0.05	0.1491	\$1,471.96
51	2066	0.2003	4,820	\$965	192	\$38	4,860	\$973	9,872	\$1,977	0.05	0.1503	\$1,483.33
52	2067	0.2014	4,820	\$971	192	\$39	4,860	\$979	9,872	\$1,988	0.05	0.1514	\$1,494.76
53	2068	0.2026	4,820	\$976	192	\$39	4,860	\$985	9,872	\$2,000	0.05	0.1526	\$1,506.27
54	2069	0.2038	4,820	\$982	192	\$39	4,860	\$990	9,872	\$2,011	0.05	0.1538	\$1,517.84
55	2070	0.2049	4,820	\$988	192	\$39	4,860	\$996	9,872	\$2,023	0.05	0.1549	\$1,529.47
56	2071	0.2061	4,820	\$993	192	\$40	4,860	\$1,002	9,872	\$2,035	0.05	0.1561	\$1,541.17
57	2072	0.2073	4,820	\$999	192	\$40	4,860	\$1,008	9,872	\$2,047	0.05	0.1573	\$1,552.95
58	2073	0.2085	4,820	\$1,005	192	\$40	4,860	\$1,013	9,872	\$2,058	0.05	0.1585	\$1,564.78
59	2074	0.2097	4,820	\$1,011	192	\$40	4,860	\$1,019	9,872	\$2,070	0.05	0.1597	\$1,576.69
60	2075	0.2109	4,820	\$1,017	192	\$40	4,860	\$1,025	9,872	\$2,082	0.05	0.1609	\$1,588.67

Table D2-1.53: Annual Operating Costs (H.GSHP) of a 2,000 square feet detached house above grade (improved construction type) in the city of Muskoka (two life cycles and three life cycles for a 60 year project lifespan); base case scenario in comparison with feed in-tariff (FIT) scenario. In the FIT scenario, an incentive of \$0.05/KWh is provided on electricity bills throughout the project lifespan

Traditional HVAC Applications

Base Case Scenario															Carbon Taxes							
#	Year	Electricity Rates \$/KWh	Natural Gas Rates \$/m ³	Heating		Heating Operating Cost \$ (Electricity)	Heating Operating Cost \$ (Gas)	Total Heating Operating Cost \$	Cooling		Hot Water m ³	Hot Water Operating Cost \$	Total KWh	Total m ³	Total Electricity Operating Cost \$ (KWh)	Total Natural Gas Operating Cost \$ (m ³)	Total	Conversion of m ³ into Tons	Total Tons	Carbon Tax	Operating Costs	
				KWh (Electricity)	m ³ (Gas)				Cooling Operating Cost \$	Cooling Operating Cost KWh												
1	2016	0.1501	0.3458	1,679	2,259	\$252	\$781	\$1,033	903	\$136	1,067	\$369	2,582	3,326	\$1,150	\$388	\$1,538	6.02	6.02	\$10	\$60.20	\$1,597.95
2	2017	0.1542	0.3588	1,679	2,259	\$259	\$811	\$1,069	903	\$139	1,067	\$165	2,582	3,326	\$1,193	\$398	\$1,592	6.02	6.02	\$20	\$120.40	\$1,712.00
3	2018	0.1583	0.3718	1,679	2,259	\$266	\$840	\$1,106	903	\$143	1,067	\$165	2,582	3,326	\$1,237	\$409	\$1,645	6.02	6.02	\$30	\$180.60	\$1,826.06
4	2019	0.1625	0.3776	1,679	2,259	\$273	\$853	\$1,126	903	\$147	1,067	\$173	2,582	3,326	\$1,256	\$420	\$1,676	6.02	6.02	\$40	\$240.80	\$1,916.32
5	2020	0.1668	0.3841	1,679	2,259	\$280	\$868	\$1,148	903	\$151	1,067	\$178	2,582	3,326	\$1,277	\$431	\$1,708	6.02	6.02	\$50	\$300.00	\$2,009.12
6	2021	0.1621	0.3883	1,679	2,259	\$272	\$877	\$1,149	903	\$146	1,067	\$173	2,582	3,326	\$1,291	\$419	\$1,710	6.02	6.02	\$60	\$361.20	\$2,071.32
7	2022	0.1629	0.3929	1,679	2,259	\$274	\$888	\$1,161	903	\$147	1,067	\$174	2,582	3,326	\$1,307	\$421	\$1,727	6.02	6.02	\$70	\$421.40	\$2,148.84
8	2023	0.1639	0.3967	1,679	2,259	\$275	\$896	\$1,171	903	\$148	1,067	\$175	2,582	3,326	\$1,319	\$423	\$1,743	6.02	6.02	\$80	\$481.60	\$2,224.18
9	2024	0.1648	0.4005	1,679	2,259	\$277	\$905	\$1,182	903	\$149	1,067	\$176	2,582	3,326	\$1,332	\$426	\$1,758	6.02	6.02	\$90	\$541.81	\$2,299.52
10	2025	0.1656	0.4040	1,679	2,259	\$278	\$913	\$1,191	903	\$150	1,067	\$177	2,582	3,326	\$1,344	\$428	\$1,771	6.02	6.02	\$100	\$602.01	\$2,373.21
11	2026	0.1665	0.4070	1,679	2,259	\$280	\$920	\$1,199	903	\$150	1,067	\$178	2,582	3,326	\$1,354	\$430	\$1,784	6.02	6.02	\$110	\$662.21	\$2,446.01
12	2027	0.1674	0.4097	1,679	2,259	\$281	\$926	\$1,207	903	\$151	1,067	\$179	2,582	3,326	\$1,363	\$432	\$1,795	6.02	6.02	\$120	\$722.41	\$2,517.44
13	2028	0.1683	0.4124	1,679	2,259	\$283	\$932	\$1,214	903	\$152	1,067	\$180	2,582	3,326	\$1,372	\$434	\$1,806	6.02	6.02	\$130	\$782.61	\$2,588.69
14	2029	0.1692	0.4151	1,679	2,259	\$284	\$938	\$1,222	903	\$153	1,067	\$180	2,582	3,326	\$1,381	\$437	\$1,817	6.02	6.02	\$140	\$842.81	\$2,660.12
15	2030	0.1701	0.4170	1,679	2,259	\$286	\$942	\$1,228	903	\$154	1,067	\$181	2,582	3,326	\$1,387	\$439	\$1,826	6.02	6.02	\$150	\$903.01	\$2,729.10
16	2031	0.1704	0.4189	1,679	2,259	\$286	\$946	\$1,232	903	\$154	1,067	\$182	2,582	3,326	\$1,393	\$440	\$1,833	6.02	6.02	\$160	\$963.21	\$2,796.31
17	2032	0.1705	0.4204	1,679	2,259	\$286	\$950	\$1,236	903	\$154	1,067	\$182	2,582	3,326	\$1,398	\$441	\$1,839	6.02	6.02	\$170	\$1,023.41	\$2,861.97
18	2033	0.1707	0.4223	1,679	2,259	\$287	\$954	\$1,241	903	\$154	1,067	\$182	2,582	3,326	\$1,405	\$441	\$1,846	6.02	6.02	\$180	\$1,083.61	\$2,929.19
19	2034	0.1710	0.4246	1,679	2,259	\$287	\$959	\$1,246	903	\$154	1,067	\$182	2,582	3,326	\$1,412	\$442	\$1,854	6.02	6.02	\$190	\$1,143.81	\$2,997.76
20	2035	0.1713	0.4265	1,679	2,259	\$288	\$964	\$1,251	903	\$155	1,067	\$183	2,582	3,326	\$1,419	\$442	\$1,861	6.02	6.02	\$200	\$1,204.01	\$3,064.98
21	2036	0.1714	0.4288	1,679	2,259	\$288	\$969	\$1,257	903	\$155	1,067	\$183	2,582	3,326	\$1,426	\$443	\$1,869	6.02	6.02	\$210	\$1,264.21	\$3,133.18
22	2037	0.1717	0.4311	1,679	2,259	\$288	\$974	\$1,262	903	\$155	1,067	\$183	2,582	3,326	\$1,434	\$443	\$1,877	6.02	6.02	\$220	\$1,324.41	\$3,201.67
23	2038	0.1720	0.4331	1,679	2,259	\$289	\$978	\$1,267	903	\$155	1,067	\$183	2,582	3,326	\$1,440	\$444	\$1,884	6.02	6.02	\$230	\$1,384.61	\$3,268.98
24	2039	0.1722	0.4353	1,679	2,259	\$289	\$983	\$1,273	903	\$156	1,067	\$184	2,582	3,326	\$1,448	\$445	\$1,893	6.02	6.02	\$240	\$1,444.81	\$3,337.46
25	2040	0.1724	0.4376	1,679	2,259	\$289	\$989	\$1,278	903	\$156	1,067	\$184	2,582	3,326	\$1,456	\$445	\$1,901	6.02	6.02	\$250	\$1,505.01	\$3,405.67
26	2041	0.1734	0.4420	1,679	2,259	\$291	\$998	\$1,289	903	\$157	1,067	\$185	2,582	3,326	\$1,470	\$448	\$1,918	6.02	6.02	\$260	\$1,565.21	\$3,482.79
27	2042	0.1744	0.4463	1,679	2,259	\$293	\$1,008	\$1,301	903	\$157	1,067	\$186	2,582	3,326	\$1,484	\$450	\$1,935	6.02	6.02	\$270	\$1,625.41	\$3,560.08
28	2043	0.1754	0.4507	1,679	2,259	\$294	\$1,018	\$1,313	903	\$158	1,067	\$187	2,582	3,326	\$1,499	\$453	\$1,952	6.02	6.02	\$280	\$1,685.61	\$3,637.52
29	2044	0.1764	0.4552	1,679	2,259	\$296	\$1,028	\$1,324	903	\$159	1,067	\$188	2,582	3,326	\$1,514	\$455	\$1,969	6.02	6.02	\$290	\$1,745.81	\$3,715.12
30	2045	0.1774	0.4596	1,679	2,259	\$298	\$1,038	\$1,336	903	\$160	1,067	\$189	2,582	3,326	\$1,529	\$458	\$1,987	6.02	6.02	\$300	\$1,806.01	\$3,792.88
31	2046	0.1784	0.4642	1,679	2,259	\$300	\$1,049	\$1,348	903	\$161	1,067	\$190	2,582	3,326	\$1,544	\$461	\$2,005	6.02	6.02	\$310	\$1,866.21	\$3,870.80
32	2047	0.1795	0.4688	1,679	2,259	\$301	\$1,059	\$1,360	903	\$162	1,067	\$191	2,582	3,326	\$1,559	\$463	\$2,022	6.02	6.02	\$320	\$1,926.41	\$3,948.89
33	2048	0.1805	0.4734	1,679	2,259	\$303	\$1,069	\$1,372	903	\$163	1,067	\$193	2,582	3,326	\$1,574	\$466	\$2,041	6.02	6.02	\$330	\$1,986.61	\$4,027.14
34	2049	0.1816	0.4780	1,679	2,259	\$305	\$1,080	\$1,385	903	\$164	1,067	\$194	2,582	3,326	\$1,590	\$469	\$2,059	6.02	6.02	\$340	\$2,046.81	\$4,105.56
35	2050	0.1826	0.4828	1,679	2,259	\$307	\$1,091	\$1,397	903	\$165	1,067	\$195	2,582	3,326	\$1,606	\$471	\$2,077	6.02	6.02	\$350	\$2,107.01	\$4,184.14
36	2051	0.1837	0.4875	1,679	2,259	\$308	\$1,101	\$1,410	903	\$166	1,067	\$196	2,582	3,326	\$1,621	\$474	\$2,096	6.02	6.02	\$360	\$2,167.21	\$4,262.90
37	2052	0.1847	0.4923	1,679	2,259	\$310	\$1,112	\$1,422	903	\$167	1,067	\$197	2,582	3,326	\$1,637	\$477	\$2,114	6.02	6.02	\$370	\$2,227.41	\$4,341.83
38	2053	0.1858	0.4972	1,679	2,259	\$312	\$1,123	\$1,435	903	\$168	1,067	\$198	2,582	3,326	\$1,654	\$480	\$2,133	6.02	6.02	\$380	\$2,287.61	\$4,420.94
39	2054	0.1869	0.5021	1,679	2,259	\$314	\$1,134	\$1,448	903	\$169	1,067	\$199	2,582	3,326	\$1,670	\$482	\$2,152	6.02	6.02	\$390	\$2,347.81	\$4,500.21
40	2055	0.1879	0.5070	1,679	2,259	\$316	\$1,145	\$1,461	903	\$170	1,067	\$201	2,582	3,326	\$1,686	\$485	\$2,172	6.02	6.02	\$400	\$2,408.01	\$4,579.67
41	2056	0.1890	0.5120	1,679	2,259	\$317	\$1,157	\$1,474	903	\$171	1,067	\$202	2,582	3,326	\$1,703	\$488	\$2,191	6.02	6.02	\$410	\$2,468.21	\$4,659.30
42	2057	0.1901	0.5171	1,679	2,259	\$319	\$1,168	\$1,487	903	\$172	1,067	\$203	2,582	3,326	\$1,720	\$491	\$2,211	6.02	6.02	\$420	\$2,528.41	\$4,739.12
43	2058	0.1912	0.5222	1,679	2,259	\$321	\$1,180	\$1,501	903	\$173	1,067	\$204	2,582	3,326	\$1,737	\$494	\$2,230	6.02	6.02	\$430	\$2,588.61	\$4,819.11
44	2059	0.1923	0.5273	1,679	2,259	\$323	\$1,191	\$1,514	903	\$174	1,067	\$205	2,582	3,326	\$1,754	\$497	\$2,250	6.02	6.02	\$440	\$2,648.81	\$4,899.29
45	2060	0.1934	0.5325	1,679	2,259	\$325	\$1,203	\$1,528	903	\$175	1,067	\$206	2,582	3,326	\$1,771	\$499	\$2,271	6.02	6.02	\$450	\$2,709.01	\$4,979.66
46	2061	0.1946	0.5378	1,679	2,259	\$327	\$1,215	\$1,541	903	\$176	1,067	\$208	2,582	3,326	\$1,789	\$502	\$2,291	6.02	6.02	\$460	\$2,769.21	\$5,060.21
47	2062	0.1957	0.5431	1,679	2,259	\$329	\$1,227	\$1,555	903	\$177	1,067	\$209	2,582	3,326	\$1,806	\$505	\$2,312	6.02	6.02	\$470	\$2,829.41	\$5,140.95
48	2063	0.1968	0.5484	1,679	2,259	\$330	\$1,239	\$1,569	903	\$178	1,067	\$210	2,582	3,326	\$1,824	\$508	\$2,332	6.02	6.02	\$480	\$2,889.61	\$5,221.88
49	2064	0.1980	0.5538	1,679	2,259	\$332	\$1,251	\$1,583	903	\$179	1,067	\$211	2,582	3,326	\$1,842	\$511	\$2,353	6.02	6.02	\$490	\$2,949.81	\$5,303.00
50	2065	0.1991	0.5593	1,679	2,259	\$334	\$1,263	\$1,598	903	\$180	1,067	\$212	2,582	3,326	\$1,860	\$514	\$2,374	6.02	6.02	\$500	\$3,010.01	\$5,384.32
51	2066	0.2003	0.5648	1,679	2,259	\$336	\$1,276	\$1,612	903	\$181	1,067	\$214	2,582	3,326	\$1,879	\$517	\$2,396	6.02	6.02	\$510	\$3,070.21	\$5,465.84
52	2067	0.2014	0.5704	1,679	2,259	\$338	\$1,288	\$1,627	903	\$182	1,067	\$215	2,582	3,326	\$1,897	\$520	\$2,417	6.02	6.02	\$520	\$3,130.41	\$5,547.55
53	2068	0.2026	0.5760	1,679	2,259	\$340	\$1,301	\$1,641	903	\$183	1,067	\$216	2,582	3,326	\$1,916	\$523	\$2,439	6.02	6.02	\$530	\$3,190.61	\$5,629.46
54	2069	0.2038	0.5817	1,679	2,259	\$34																

19. Peterborough (Distinct) – Annual Operating Costs

Vertical Ground Source Heat Pump (V.GSHP)

Base Case Scenario											Feed in Tariff (FIT)		
#	Year	Electricity Rates		V.GSHP		Hot Water		Total		Total Operating Cost	FIT	Incentives (\$/KWh)	Operating Cost
		\$/KWh	KWh	Heating Operating Cost	Cooling Operating Cost	Hot Water Operating Cost	Total Operating Cost	\$/KWh	Operating Cost				
1	2016	0.1501	4,689	\$704	\$48	4,746	\$712	9,754	\$1,464		0.05	\$976.21	
2	2017	0.1542	4,689	\$723	\$49	4,746	\$732	9,754	\$1,504		0.05	\$1,016.24	
3	2018	0.1583	4,689	\$742	\$50	4,746	\$751	9,754	\$1,544		0.05	\$1,056.27	
4	2019	0.1625	4,689	\$762	\$52	4,746	\$771	9,754	\$1,585		0.05	\$1,097.70	
5	2020	0.1668	4,689	\$782	\$53	4,746	\$792	9,754	\$1,627		0.05	\$1,139.14	
6	2021	0.1621	4,689	\$760	\$52	4,746	\$770	9,754	\$1,582		0.05	\$1,093.84	
7	2022	0.1629	4,689	\$764	\$52	4,746	\$773	9,754	\$1,589		0.05	\$1,101.57	
8	2023	0.1639	4,689	\$768	\$52	4,746	\$778	9,754	\$1,598		0.05	\$1,110.69	
9	2024	0.1648	4,689	\$773	\$53	4,746	\$782	9,754	\$1,608		0.05	\$1,119.82	
10	2025	0.1656	4,689	\$776	\$53	4,746	\$786	9,754	\$1,615		0.05	\$1,127.55	
11	2026	0.1665	4,689	\$781	\$53	4,746	\$790	9,754	\$1,624		0.05	\$1,136.68	
12	2027	0.1674	4,689	\$785	\$53	4,746	\$795	9,754	\$1,633		0.05	\$1,145.46	
13	2028	0.1683	4,689	\$789	\$54	4,746	\$799	9,754	\$1,641		0.05	\$1,153.53	
14	2029	0.1692	4,689	\$793	\$54	4,746	\$803	9,754	\$1,650		0.05	\$1,162.31	
15	2030	0.1701	4,689	\$798	\$54	4,746	\$807	9,754	\$1,659		0.05	\$1,171.44	
16	2031	0.1704	4,689	\$799	\$54	4,746	\$808	9,754	\$1,662		0.05	\$1,173.90	
17	2032	0.1705	4,689	\$799	\$54	4,746	\$809	9,754	\$1,663		0.05	\$1,175.30	
18	2033	0.1707	4,689	\$801	\$54	4,746	\$810	9,754	\$1,665		0.05	\$1,177.76	
19	2034	0.1710	4,689	\$802	\$55	4,746	\$812	9,754	\$1,668		0.05	\$1,180.57	
20	2035	0.1713	4,689	\$803	\$55	4,746	\$813	9,754	\$1,671		0.05	\$1,183.03	
21	2036	0.1714	4,689	\$804	\$55	4,746	\$814	9,754	\$1,672		0.05	\$1,184.43	
22	2037	0.1717	4,689	\$805	\$55	4,746	\$815	9,754	\$1,675		0.05	\$1,186.89	
23	2038	0.1720	4,689	\$806	\$55	4,746	\$816	9,754	\$1,677		0.05	\$1,189.70	
24	2039	0.1722	4,689	\$808	\$55	4,746	\$817	9,754	\$1,680		0.05	\$1,192.16	
25	2040	0.1724	4,689	\$808	\$55	4,746	\$818	9,754	\$1,681		0.05	\$1,193.56	
26	2041	0.1734	4,689	\$813	\$55	4,746	\$823	9,754	\$1,691		0.05	\$1,203.29	
27	2042	0.1744	4,689	\$818	\$56	4,746	\$828	9,754	\$1,701		0.05	\$1,213.07	
28	2043	0.1754	4,689	\$822	\$56	4,746	\$832	9,754	\$1,711		0.05	\$1,222.91	
29	2044	0.1764	4,689	\$827	\$57	4,746	\$837	9,754	\$1,721		0.05	\$1,232.81	
30	2045	0.1774	4,689	\$832	\$57	4,746	\$842	9,754	\$1,730		0.05	\$1,242.76	
31	2046	0.1784	4,689	\$837	\$57	4,746	\$847	9,754	\$1,740		0.05	\$1,252.77	
32	2047	0.1795	4,689	\$842	\$57	4,746	\$852	9,754	\$1,751		0.05	\$1,262.84	
33	2048	0.1805	4,689	\$846	\$58	4,746	\$857	9,754	\$1,761		0.05	\$1,272.96	
34	2049	0.1816	4,689	\$851	\$58	4,746	\$862	9,754	\$1,771		0.05	\$1,283.15	
35	2050	0.1826	4,689	\$856	\$58	4,746	\$867	9,754	\$1,781		0.05	\$1,293.39	
36	2051	0.1837	4,689	\$861	\$59	4,746	\$872	9,754	\$1,791		0.05	\$1,303.70	
37	2052	0.1847	4,689	\$866	\$59	4,746	\$877	9,754	\$1,802		0.05	\$1,314.06	
38	2053	0.1858	4,689	\$871	\$59	4,746	\$882	9,754	\$1,812		0.05	\$1,324.48	
39	2054	0.1869	4,689	\$876	\$60	4,746	\$887	9,754	\$1,823		0.05	\$1,334.97	
40	2055	0.1879	4,689	\$881	\$60	4,746	\$892	9,754	\$1,833		0.05	\$1,345.51	
41	2056	0.1890	4,689	\$886	\$60	4,746	\$897	9,754	\$1,844		0.05	\$1,356.12	
42	2057	0.1901	4,689	\$891	\$61	4,746	\$902	9,754	\$1,854		0.05	\$1,366.78	
43	2058	0.1912	4,689	\$897	\$61	4,746	\$908	9,754	\$1,865		0.05	\$1,377.51	
44	2059	0.1923	4,689	\$902	\$61	4,746	\$913	9,754	\$1,876		0.05	\$1,388.30	
45	2060	0.1934	4,689	\$907	\$62	4,746	\$918	9,754	\$1,887		0.05	\$1,399.15	
46	2061	0.1946	4,689	\$912	\$62	4,746	\$923	9,754	\$1,898		0.05	\$1,410.07	
47	2062	0.1957	4,689	\$918	\$62	4,746	\$929	9,754	\$1,909		0.05	\$1,421.05	
48	2063	0.1968	4,689	\$923	\$63	4,746	\$934	9,754	\$1,920		0.05	\$1,432.09	
49	2064	0.1980	4,689	\$928	\$63	4,746	\$940	9,754	\$1,931		0.05	\$1,443.19	
50	2065	0.1991	4,689	\$934	\$64	4,746	\$945	9,754	\$1,942		0.05	\$1,454.36	
51	2066	0.2003	4,689	\$939	\$64	4,746	\$950	9,754	\$1,953		0.05	\$1,465.60	
52	2067	0.2014	4,689	\$944	\$64	4,746	\$956	9,754	\$1,965		0.05	\$1,476.90	
53	2068	0.2026	4,689	\$950	\$65	4,746	\$961	9,754	\$1,976		0.05	\$1,488.26	
54	2069	0.2038	4,689	\$955	\$65	4,746	\$967	9,754	\$1,987		0.05	\$1,499.69	
55	2070	0.2049	4,689	\$961	\$65	4,746	\$973	9,754	\$1,999		0.05	\$1,511.19	
56	2071	0.2061	4,689	\$966	\$66	4,746	\$978	9,754	\$2,010		0.05	\$1,522.75	
57	2072	0.2073	4,689	\$972	\$66	4,746	\$984	9,754	\$2,022		0.05	\$1,534.38	
58	2073	0.2085	4,689	\$978	\$67	4,746	\$990	9,754	\$2,034		0.05	\$1,546.08	
59	2074	0.2097	4,689	\$983	\$67	4,746	\$995	9,754	\$2,046		0.05	\$1,557.85	
60	2075	0.2109	4,689	\$989	\$67	4,746	\$1,001	9,754	\$2,057		0.05	\$1,569.68	

Table D2-1.55: Annual Operating Costs (V.GSHP) of a 2,000 square feet detached house above grade (improved construction type) in the city of Peterborough (two life cycles and three life cycles for a 60 year project lifespan); base case scenario in comparison with feed in-tariff (FIT) scenario. In the FIT scenario, an incentive of \$0.05/KWh is provided on electricity bills throughout the project lifespan

Horizontal Ground Source Heat Pump (H.GSHP)

Base Case Scenario											Feed in Tariff (FIT)		
H.GSHP											FIT		
#	Year	Electricity Rates \$/KWh	Heating KWh	Heating Operating Cost \$	Cooling KWh	Cooling Operating Cost \$	Hot Water KWh	Hot Water Operating Cost \$	Total KWh	Total Operating Cost \$	Incentives (\$/KWh)	\$/KWh	Operating Cost
1	2016	0.1501	4,778	\$717	327	\$49	4,724	\$709	9,829	\$1,475	0.05	0.1001	\$983.71
2	2017	0.1542	4,778	\$737	327	\$50	4,724	\$728	9,829	\$1,516	0.05	0.1042	\$1,024.05
3	2018	0.1583	4,778	\$756	327	\$52	4,724	\$748	9,829	\$1,556	0.05	0.1083	\$1,064.39
4	2019	0.1625	4,778	\$777	327	\$53	4,724	\$768	9,829	\$1,598	0.05	0.1125	\$1,106.14
5	2020	0.1668	4,778	\$797	327	\$55	4,724	\$788	9,829	\$1,639	0.05	0.1168	\$1,147.90
6	2021	0.1621	4,778	\$775	327	\$53	4,724	\$766	9,829	\$1,594	0.05	0.1121	\$1,102.25
7	2022	0.1629	4,778	\$779	327	\$53	4,724	\$770	9,829	\$1,601	0.05	0.1129	\$1,110.04
8	2023	0.1639	4,778	\$783	327	\$54	4,724	\$774	9,829	\$1,611	0.05	0.1139	\$1,119.24
9	2024	0.1648	4,778	\$787	327	\$54	4,724	\$779	9,829	\$1,620	0.05	0.1148	\$1,128.43
10	2025	0.1656	4,778	\$791	327	\$54	4,724	\$782	9,829	\$1,628	0.05	0.1156	\$1,136.22
11	2026	0.1665	4,778	\$796	327	\$54	4,724	\$787	9,829	\$1,637	0.05	0.1165	\$1,145.42
12	2027	0.1674	4,778	\$800	327	\$55	4,724	\$791	9,829	\$1,646	0.05	0.1174	\$1,154.27
13	2028	0.1683	4,778	\$804	327	\$55	4,724	\$795	9,829	\$1,654	0.05	0.1183	\$1,162.40
14	2029	0.1692	4,778	\$808	327	\$55	4,724	\$799	9,829	\$1,663	0.05	0.1192	\$1,171.25
15	2030	0.1701	4,778	\$813	327	\$56	4,724	\$804	9,829	\$1,672	0.05	0.1201	\$1,180.45
16	2031	0.1704	4,778	\$814	327	\$56	4,724	\$805	9,829	\$1,674	0.05	0.1204	\$1,182.93
17	2032	0.1705	4,778	\$815	327	\$56	4,724	\$805	9,829	\$1,676	0.05	0.1205	\$1,184.34
18	2033	0.1707	4,778	\$816	327	\$56	4,724	\$807	9,829	\$1,678	0.05	0.1207	\$1,186.82
19	2034	0.1710	4,778	\$817	327	\$56	4,724	\$808	9,829	\$1,681	0.05	0.1210	\$1,189.65
20	2035	0.1713	4,778	\$818	327	\$56	4,724	\$809	9,829	\$1,684	0.05	0.1213	\$1,192.13
21	2036	0.1714	4,778	\$819	327	\$56	4,724	\$810	9,829	\$1,685	0.05	0.1214	\$1,193.54
22	2037	0.1717	4,778	\$820	327	\$56	4,724	\$811	9,829	\$1,687	0.05	0.1217	\$1,196.02
23	2038	0.1720	4,778	\$822	327	\$56	4,724	\$812	9,829	\$1,690	0.05	0.1220	\$1,198.85
24	2039	0.1722	4,778	\$823	327	\$56	4,724	\$814	9,829	\$1,693	0.05	0.1222	\$1,201.33
25	2040	0.1724	4,778	\$824	327	\$56	4,724	\$814	9,829	\$1,694	0.05	0.1224	\$1,202.74
26	2041	0.1734	4,778	\$828	327	\$57	4,724	\$819	9,829	\$1,704	0.05	0.1234	\$1,212.54
27	2042	0.1744	4,778	\$833	327	\$57	4,724	\$824	9,829	\$1,714	0.05	0.1244	\$1,222.40
28	2043	0.1754	4,778	\$838	327	\$57	4,724	\$828	9,829	\$1,724	0.05	0.1254	\$1,232.31
29	2044	0.1764	4,778	\$843	327	\$58	4,724	\$833	9,829	\$1,734	0.05	0.1264	\$1,242.29
30	2045	0.1774	4,778	\$848	327	\$58	4,724	\$838	9,829	\$1,744	0.05	0.1274	\$1,252.32
31	2046	0.1784	4,778	\$853	327	\$58	4,724	\$843	9,829	\$1,754	0.05	0.1284	\$1,262.40
32	2047	0.1795	4,778	\$858	327	\$59	4,724	\$848	9,829	\$1,764	0.05	0.1295	\$1,272.55
33	2048	0.1805	4,778	\$862	327	\$59	4,724	\$853	9,829	\$1,774	0.05	0.1305	\$1,282.75
34	2049	0.1816	4,778	\$867	327	\$59	4,724	\$858	9,829	\$1,784	0.05	0.1316	\$1,293.02
35	2050	0.1826	4,778	\$872	327	\$60	4,724	\$863	9,829	\$1,795	0.05	0.1326	\$1,303.34
36	2051	0.1837	4,778	\$878	327	\$60	4,724	\$868	9,829	\$1,805	0.05	0.1337	\$1,313.72
37	2052	0.1847	4,778	\$883	327	\$60	4,724	\$873	9,829	\$1,816	0.05	0.1347	\$1,324.16
38	2053	0.1858	4,778	\$888	327	\$61	4,724	\$878	9,829	\$1,826	0.05	0.1358	\$1,334.67
39	2054	0.1869	4,778	\$893	327	\$61	4,724	\$883	9,829	\$1,837	0.05	0.1369	\$1,345.23
40	2055	0.1879	4,778	\$898	327	\$61	4,724	\$888	9,829	\$1,847	0.05	0.1379	\$1,355.86
41	2056	0.1890	4,778	\$903	327	\$62	4,724	\$893	9,829	\$1,858	0.05	0.1390	\$1,366.54
42	2057	0.1901	4,778	\$908	327	\$62	4,724	\$898	9,829	\$1,869	0.05	0.1401	\$1,377.29
43	2058	0.1912	4,778	\$914	327	\$63	4,724	\$903	9,829	\$1,880	0.05	0.1412	\$1,388.10
44	2059	0.1923	4,778	\$919	327	\$63	4,724	\$909	9,829	\$1,890	0.05	0.1423	\$1,398.97
45	2060	0.1934	4,778	\$924	327	\$63	4,724	\$914	9,829	\$1,901	0.05	0.1434	\$1,409.91
46	2061	0.1946	4,778	\$930	327	\$64	4,724	\$919	9,829	\$1,912	0.05	0.1446	\$1,420.91
47	2062	0.1957	4,778	\$935	327	\$64	4,724	\$924	9,829	\$1,923	0.05	0.1457	\$1,431.97
48	2063	0.1968	4,778	\$940	327	\$64	4,724	\$930	9,829	\$1,935	0.05	0.1468	\$1,443.10
49	2064	0.1980	4,778	\$946	327	\$65	4,724	\$935	9,829	\$1,946	0.05	0.1480	\$1,454.29
50	2065	0.1991	4,778	\$951	327	\$65	4,724	\$941	9,829	\$1,957	0.05	0.1491	\$1,465.55
51	2066	0.2003	4,778	\$957	327	\$65	4,724	\$946	9,829	\$1,968	0.05	0.1503	\$1,476.87
52	2067	0.2014	4,778	\$962	327	\$66	4,724	\$951	9,829	\$1,980	0.05	0.1514	\$1,488.25
53	2068	0.2026	4,778	\$968	327	\$66	4,724	\$957	9,829	\$1,991	0.05	0.1526	\$1,499.71
54	2069	0.2038	4,778	\$974	327	\$67	4,724	\$963	9,829	\$2,003	0.05	0.1538	\$1,511.22
55	2070	0.2049	4,778	\$979	327	\$67	4,724	\$968	9,829	\$2,014	0.05	0.1549	\$1,522.81
56	2071	0.2061	4,778	\$985	327	\$67	4,724	\$974	9,829	\$2,026	0.05	0.1561	\$1,534.46
57	2072	0.2073	4,778	\$991	327	\$68	4,724	\$979	9,829	\$2,038	0.05	0.1573	\$1,546.18
58	2073	0.2085	4,778	\$996	327	\$68	4,724	\$985	9,829	\$2,049	0.05	0.1585	\$1,557.97
59	2074	0.2097	4,778	\$1,002	327	\$69	4,724	\$991	9,829	\$2,061	0.05	0.1597	\$1,569.82
60	2075	0.2109	4,778	\$1,008	327	\$69	4,724	\$996	9,829	\$2,073	0.05	0.1609	\$1,581.75

Table D2-1.56: Annual Operating Costs (H.GSHP) of a 2,000 square feet detached house above grade (improved construction type) in the city of Peterborough (two life cycles and three life cycles for a 60 year project lifespan); base case scenario in comparison with feed in-tariff (FIT) scenario. In the FIT scenario, an incentive of \$0.05/KWh is provided on electricity bills throughout the project lifespan

Traditional HVAC Applications

Base Case Scenario																	Carbon Taxes									
#	Year	Electricity Rates	Natural Gas Rates	Traditional									Total	Total	Total Electricity Operating Cost	Total Natural Gas Operating Cost	Total	Conversion of m³ into Tons	Total Tons	Carbon Tax	Operating Costs					
				Heating		Heating Operating Cost	Heating Operating Cost	Total Heating Operating Cost	Cooling		Hot Water	Hot Water Operating Cost										Total	Total	Total Electricity Operating Cost	Total Natural Gas Operating Cost	Total
				KWh (Electricity)	m³(Gas)				\$ (Electricity)	\$ (Gas)																
1	2016	0.1501	0.3458	1,435	2,260	\$215	\$782	\$997	1,479	\$222	1,055	\$365	2,914	3,315	437	\$1,146	\$1,584	6.00	6.00	\$10	\$60.00	\$1,643.77				
2	2017	0.1542	0.3588	1,435	2,260	\$221	\$811	\$1,032	1,479	\$228	1,055	\$163	2,914	3,315	449	\$1,190	\$1,639	6.00	6.00	\$20	\$120.00	\$1,758.85				
3	2018	0.1583	0.3718	1,435	2,260	\$227	\$840	\$1,068	1,479	\$234	1,055	\$167	2,914	3,315	461	\$1,233	\$1,694	6.00	6.00	\$30	\$180.00	\$1,873.93				
4	2019	0.1625	0.3776	1,435	2,260	\$233	\$853	\$1,087	1,479	\$240	1,055	\$171	2,914	3,315	474	\$1,252	\$1,725	6.00	6.00	\$40	\$240.00	\$1,965.33				
5	2020	0.1668	0.3841	1,435	2,260	\$239	\$868	\$1,107	1,479	\$247	1,055	\$176	2,914	3,315	486	\$1,273	\$1,759	6.00	6.00	\$50	\$300.00	\$2,059.27				
6	2021	0.1621	0.3883	1,435	2,260	\$233	\$878	\$1,110	1,479	\$240	1,055	\$171	2,914	3,315	472	\$1,287	\$1,760	6.00	6.00	\$60	\$360.00	\$2,119.69				
7	2022	0.1629	0.3929	1,435	2,260	\$234	\$888	\$1,122	1,479	\$241	1,055	\$172	2,914	3,315	475	\$1,302	\$1,777	6.00	6.00	\$70	\$420.00	\$2,197.21				
8	2023	0.1639	0.3967	1,435	2,260	\$235	\$897	\$1,132	1,479	\$242	1,055	\$173	2,914	3,315	478	\$1,315	\$1,793	6.00	6.00	\$80	\$480.00	\$2,272.62				
9	2024	0.1648	0.4005	1,435	2,260	\$236	\$905	\$1,142	1,479	\$244	1,055	\$174	2,914	3,315	480	\$1,328	\$1,808	6.00	6.00	\$90	\$540.00	\$2,348.04				
10	2025	0.1656	0.4040	1,435	2,260	\$238	\$913	\$1,151	1,479	\$245	1,055	\$175	2,914	3,315	483	\$1,339	\$1,822	6.00	6.00	\$100	\$600.00	\$2,421.76				
11	2026	0.1665	0.4070	1,435	2,260	\$239	\$920	\$1,159	1,479	\$246	1,055	\$176	2,914	3,315	485	\$1,349	\$1,835	6.00	6.00	\$110	\$660.00	\$2,494.63				
12	2027	0.1674	0.4097	1,435	2,260	\$240	\$926	\$1,166	1,479	\$248	1,055	\$177	2,914	3,315	488	\$1,358	\$1,846	6.00	6.00	\$120	\$720.00	\$2,566.13				
13	2028	0.1683	0.4124	1,435	2,260	\$241	\$932	\$1,173	1,479	\$249	1,055	\$178	2,914	3,315	490	\$1,367	\$1,857	6.00	6.00	\$130	\$780.00	\$2,637.43				
14	2029	0.1692	0.4151	1,435	2,260	\$243	\$938	\$1,181	1,479	\$250	1,055	\$178	2,914	3,315	493	\$1,376	\$1,869	6.00	6.00	\$140	\$840.00	\$2,708.93				
15	2030	0.1701	0.4170	1,435	2,260	\$244	\$942	\$1,186	1,479	\$252	1,055	\$179	2,914	3,315	496	\$1,382	\$1,878	6.00	6.00	\$150	\$900.00	\$2,778.00				
16	2031	0.1704	0.4189	1,435	2,260	\$244	\$947	\$1,191	1,479	\$252	1,055	\$180	2,914	3,315	496	\$1,389	\$1,885	6.00	6.00	\$160	\$960.00	\$2,845.07				
17	2032	0.1705	0.4204	1,435	2,260	\$245	\$950	\$1,195	1,479	\$252	1,055	\$180	2,914	3,315	497	\$1,394	\$1,891	6.00	6.00	\$170	\$1,020.00	\$2,910.57				
18	2033	0.1707	0.4223	1,435	2,260	\$245	\$954	\$1,200	1,479	\$253	1,055	\$180	2,914	3,315	498	\$1,400	\$1,898	6.00	6.00	\$180	\$1,080.00	\$2,977.64				
19	2034	0.1710	0.4246	1,435	2,260	\$245	\$960	\$1,205	1,479	\$253	1,055	\$180	2,914	3,315	498	\$1,408	\$1,906	6.00	6.00	\$190	\$1,140.00	\$3,046.09				
20	2035	0.1713	0.4265	1,435	2,260	\$246	\$964	\$1,210	1,479	\$253	1,055	\$181	2,914	3,315	499	\$1,414	\$1,913	6.00	6.00	\$200	\$1,200.00	\$3,113.17				
21	2036	0.1714	0.4288	1,435	2,260	\$246	\$969	\$1,215	1,479	\$254	1,055	\$181	2,914	3,315	500	\$1,422	\$1,921	6.00	6.00	\$210	\$1,260.00	\$3,181.20				
22	2037	0.1717	0.4311	1,435	2,260	\$246	\$974	\$1,221	1,479	\$254	1,055	\$181	2,914	3,315	500	\$1,429	\$1,930	6.00	6.00	\$220	\$1,320.00	\$3,249.55				
23	2038	0.1720	0.4331	1,435	2,260	\$247	\$979	\$1,225	1,479	\$254	1,055	\$181	2,914	3,315	501	\$1,436	\$1,937	6.00	6.00	\$230	\$1,380.00	\$3,316.73				
24	2039	0.1722	0.4353	1,435	2,260	\$247	\$984	\$1,231	1,479	\$255	1,055	\$182	2,914	3,315	502	\$1,443	\$1,945	6.00	6.00	\$240	\$1,440.00	\$3,385.07				
25	2040	0.1724	0.4376	1,435	2,260	\$247	\$989	\$1,236	1,479	\$255	1,055	\$182	2,914	3,315	502	\$1,451	\$1,953	6.00	6.00	\$250	\$1,500.00	\$3,453.10				
26	2041	0.1734	0.4420	1,435	2,260	\$249	\$999	\$1,248	1,479	\$256	1,055	\$183	2,914	3,315	505	\$1,465	\$1,970	6.00	6.00	\$260	\$1,560.00	\$3,520.31				
27	2042	0.1744	0.4463	1,435	2,260	\$250	\$1,009	\$1,259	1,479	\$258	1,055	\$184	2,914	3,315	508	\$1,480	\$1,988	6.00	6.00	\$270	\$1,620.00	\$3,607.68				
28	2043	0.1754	0.4507	1,435	2,260	\$252	\$1,019	\$1,270	1,479	\$259	1,055	\$185	2,914	3,315	511	\$1,494	\$2,005	6.00	6.00	\$280	\$1,680.00	\$3,685.21				
29	2044	0.1764	0.4552	1,435	2,260	\$253	\$1,029	\$1,282	1,479	\$261	1,055	\$186	2,914	3,315	514	\$1,509	\$2,023	6.00	6.00	\$290	\$1,740.00	\$3,762.90				
30	2045	0.1774	0.4596	1,435	2,260	\$255	\$1,039	\$1,293	1,479	\$262	1,055	\$187	2,914	3,315	517	\$1,524	\$2,041	6.00	6.00	\$300	\$1,800.00	\$3,840.75				
31	2046	0.1784	0.4642	1,435	2,260	\$256	\$1,049	\$1,305	1,479	\$264	1,055	\$188	2,914	3,315	520	\$1,539	\$2,059	6.00	6.00	\$310	\$1,860.00	\$3,918.76				
32	2047	0.1795	0.4688	1,435	2,260	\$258	\$1,059	\$1,317	1,479	\$265	1,055	\$189	2,914	3,315	523	\$1,554	\$2,077	6.00	6.00	\$320	\$1,920.00	\$3,996.94				
33	2048	0.1805	0.4734	1,435	2,260	\$259	\$1,070	\$1,329	1,479	\$267	1,055	\$190	2,914	3,315	526	\$1,569	\$2,095	6.00	6.00	\$330	\$1,980.00	\$4,075.29				
34	2049	0.1816	0.4780	1,435	2,260	\$261	\$1,080	\$1,341	1,479	\$269	1,055	\$192	2,914	3,315	529	\$1,585	\$2,114	6.00	6.00	\$340	\$2,040.00	\$4,153.80				
35	2050	0.1826	0.4828	1,435	2,260	\$262	\$1,091	\$1,353	1,479	\$270	1,055	\$193	2,914	3,315	532	\$1,600	\$2,132	6.00	6.00	\$350	\$2,100.00	\$4,232.49				
36	2051	0.1837	0.4875	1,435	2,260	\$264	\$1,102	\$1,365	1,479	\$272	1,055	\$194	2,914	3,315	535	\$1,616	\$2,151	6.00	6.00	\$360	\$2,160.00	\$4,311.35				
37	2052	0.1847	0.4923	1,435	2,260	\$265	\$1,113	\$1,378	1,479	\$273	1,055	\$195	2,914	3,315	538	\$1,632	\$2,170	6.00	6.00	\$370	\$2,220.00	\$4,390.38				
38	2053	0.1858	0.4972	1,435	2,260	\$267	\$1,124	\$1,390	1,479	\$275	1,055	\$196	2,914	3,315	541	\$1,648	\$2,189	6.00	6.00	\$380	\$2,280.00	\$4,469.58				
39	2054	0.1869	0.5021	1,435	2,260	\$268	\$1,135	\$1,403	1,479	\$276	1,055	\$197	2,914	3,315	545	\$1,664	\$2,209	6.00	6.00	\$390	\$2,340.00	\$4,548.97				
40	2055	0.1879	0.5070	1,435	2,260	\$270	\$1,146	\$1,416	1,479	\$278	1,055	\$198	2,914	3,315	548	\$1,681	\$2,228	6.00	6.00	\$400	\$2,400.00	\$4,628.53				
41	2056	0.1890	0.5120	1,435	2,260	\$271	\$1,157	\$1,428	1,479	\$280	1,055	\$199	2,914	3,315	551	\$1,697	\$2,248	6.00	6.00	\$410	\$2,460.00	\$4,708.27				
42	2057	0.1901	0.5171	1,435	2,260	\$273	\$1,169	\$1,441	1,479	\$281	1,055	\$201	2,914	3,315	554	\$1,714	\$2,268	6.00	6.00	\$420	\$2,520.00	\$4,788.19				
43	2058	0.1912	0.5222	1,435	2,260	\$274	\$1,180	\$1,455	1,479	\$283	1,055	\$202	2,914	3,315	557	\$1,731	\$2,288	6.00	6.00	\$430	\$2,580.00	\$4,868.29				
44	2059	0.1923	0.5273	1,435	2,260	\$276	\$1,192	\$1,468	1,479	\$284	1,055	\$203	2,914	3,315	560	\$1,748	\$2,309	6.00	6.00	\$440	\$2,640.00	\$4,948.59				
45	2060	0.1934	0.5325	1,435	2,260	\$278	\$1,203	\$1,481	1,479	\$286	1,055	\$204	2,914	3,315	564	\$1,765	\$2,329	6.00	6.00	\$450	\$2,700.00	\$5,029.06				
46	2061	0.1946	0.5378	1,435	2,260	\$279	\$1,215	\$1,495	1,479	\$288	1,055	\$205	2,914	3,315	567	\$1,783	\$2,350	6.00	6.00	\$460	\$2,760.00	\$5,109.73				
47	2062	0.1957	0.5431	1,435	2,260	\$281	\$1,227	\$1,508	1,479	\$289	1,055	\$206	2,914	3,315	570	\$1,800	\$2,371	6.00	6.00	\$470	\$2,820.00	\$5,190.59				
48	2063	0.1968	0.5484	1,435	2,260	\$282	\$1,239	\$1,522	1,479	\$291	1,055	\$208	2,914	3,315	574	\$1,818	\$2,392	6.00	6.00	\$480	\$2,880.00	\$5,271.64				
49	2064	0.1980	0.5538	1,435	2,260	\$284	\$1,252	\$1,536	1,479	\$293	1,055	\$209	2,914	3,315	577	\$1,836	\$2,413	6.00	6.00	\$490	\$2,940.00	\$5,352.88				
50	2065	0.1991	0.5593	1,435	2,260	\$286	\$1,264	\$1,550	1,479	\$294	1,055	\$210	2,914	3,315	580	\$1,854	\$2,434	6.00	6.00	\$500	\$3,000.00	\$5,434.32				
51	2066	0.2003	0.5648	1,435	2,260	\$287	\$1,276	\$1,564	1,479	\$296	1,055	\$211	2,914	3,315	584	\$1,872	\$2,456	6.00	6.00	\$510	\$3,060.00	\$5,515.96				
52	2067	0.2014	0.5704	1,435	2,260	\$289	\$1,289	\$1,578	1,479	\$298	1,055	\$212	2,914	3,315	587	\$1,891	\$2,478	6.00	6.00	\$520	\$3,120.00	\$5,				

20. Ottawa (Distinct) – Annual Operating Costs

Vertical Ground Source Heat Pump (V.GSHP)

Base Case Scenario											Feed In Tariff (FIT)		
#	Year	Electricity Rates		V.GSHP		Hot Water		Total		Total Operating Cost	FIT		
		\$/KWh	KWh	Heating Operating Cost \$	Cooling Operating Cost \$	Hot Water Operating Cost \$	Total Operating Cost \$	Incentives (\$/KWh)	\$/KWh		Operating Cost		
1	2016	0.1501	4,444	\$667	240	\$36	4,832	\$725	9,516	\$1,428	0.05	0.1001	\$952.39
2	2017	0.1542	4,444	\$685	240	\$37	4,832	\$745	9,516	\$1,467	0.05	0.1042	\$991.44
3	2018	0.1583	4,444	\$703	240	\$38	4,832	\$765	9,516	\$1,506	0.05	0.1083	\$1,030.49
4	2019	0.1625	4,444	\$722	240	\$39	4,832	\$785	9,516	\$1,547	0.05	0.1125	\$1,070.92
5	2020	0.1668	4,444	\$741	240	\$40	4,832	\$806	9,516	\$1,587	0.05	0.1168	\$1,111.34
6	2021	0.1621	4,444	\$721	240	\$39	4,832	\$783	9,516	\$1,543	0.05	0.1121	\$1,067.15
7	2022	0.1629	4,444	\$724	240	\$39	4,832	\$787	9,516	\$1,550	0.05	0.1129	\$1,074.69
8	2023	0.1639	4,444	\$728	240	\$39	4,832	\$792	9,516	\$1,559	0.05	0.1139	\$1,083.59
9	2024	0.1648	4,444	\$732	240	\$40	4,832	\$796	9,516	\$1,568	0.05	0.1148	\$1,092.50
10	2025	0.1656	4,444	\$736	240	\$40	4,832	\$800	9,516	\$1,576	0.05	0.1156	\$1,100.04
11	2026	0.1665	4,444	\$740	240	\$40	4,832	\$805	9,516	\$1,585	0.05	0.1165	\$1,108.94
12	2027	0.1674	4,444	\$744	240	\$40	4,832	\$809	9,516	\$1,593	0.05	0.1174	\$1,117.51
13	2028	0.1683	4,444	\$748	240	\$40	4,832	\$813	9,516	\$1,601	0.05	0.1183	\$1,125.39
14	2029	0.1692	4,444	\$752	240	\$41	4,832	\$817	9,516	\$1,610	0.05	0.1192	\$1,133.95
15	2030	0.1701	4,444	\$756	240	\$41	4,832	\$822	9,516	\$1,619	0.05	0.1201	\$1,142.86
16	2031	0.1704	4,444	\$757	240	\$41	4,832	\$823	9,516	\$1,621	0.05	0.1204	\$1,145.26
17	2032	0.1705	4,444	\$758	240	\$41	4,832	\$824	9,516	\$1,622	0.05	0.1205	\$1,146.63
18	2033	0.1707	4,444	\$759	240	\$41	4,832	\$825	9,516	\$1,625	0.05	0.1207	\$1,149.02
19	2034	0.1710	4,444	\$760	240	\$41	4,832	\$826	9,516	\$1,628	0.05	0.1210	\$1,151.77
20	2035	0.1713	4,444	\$761	240	\$41	4,832	\$828	9,516	\$1,630	0.05	0.1213	\$1,154.16
21	2036	0.1714	4,444	\$762	240	\$41	4,832	\$828	9,516	\$1,631	0.05	0.1214	\$1,155.53
22	2037	0.1717	4,444	\$763	240	\$41	4,832	\$830	9,516	\$1,634	0.05	0.1217	\$1,157.93
23	2038	0.1720	4,444	\$764	240	\$41	4,832	\$831	9,516	\$1,636	0.05	0.1220	\$1,160.67
24	2039	0.1722	4,444	\$765	240	\$41	4,832	\$832	9,516	\$1,639	0.05	0.1222	\$1,163.07
25	2040	0.1724	4,444	\$766	240	\$41	4,832	\$833	9,516	\$1,640	0.05	0.1224	\$1,164.44
26	2041	0.1734	4,444	\$770	240	\$42	4,832	\$838	9,516	\$1,650	0.05	0.1234	\$1,173.93
27	2042	0.1744	4,444	\$775	240	\$42	4,832	\$843	9,516	\$1,659	0.05	0.1244	\$1,183.47
28	2043	0.1754	4,444	\$779	240	\$42	4,832	\$847	9,516	\$1,669	0.05	0.1254	\$1,193.07
29	2044	0.1764	4,444	\$784	240	\$42	4,832	\$852	9,516	\$1,679	0.05	0.1264	\$1,202.73
30	2045	0.1774	4,444	\$788	240	\$43	4,832	\$857	9,516	\$1,688	0.05	0.1274	\$1,212.44
31	2046	0.1784	4,444	\$793	240	\$43	4,832	\$862	9,516	\$1,698	0.05	0.1284	\$1,222.20
32	2047	0.1795	4,444	\$798	240	\$43	4,832	\$867	9,516	\$1,708	0.05	0.1295	\$1,232.02
33	2048	0.1805	4,444	\$802	240	\$43	4,832	\$872	9,516	\$1,718	0.05	0.1305	\$1,241.90
34	2049	0.1816	4,444	\$807	240	\$44	4,832	\$877	9,516	\$1,728	0.05	0.1316	\$1,251.84
35	2050	0.1826	4,444	\$811	240	\$44	4,832	\$882	9,516	\$1,738	0.05	0.1326	\$1,261.83
36	2051	0.1837	4,444	\$816	240	\$44	4,832	\$887	9,516	\$1,748	0.05	0.1337	\$1,271.89
37	2052	0.1847	4,444	\$821	240	\$44	4,832	\$893	9,516	\$1,758	0.05	0.1347	\$1,282.00
38	2053	0.1858	4,444	\$826	240	\$45	4,832	\$898	9,516	\$1,768	0.05	0.1358	\$1,292.17
39	2054	0.1869	4,444	\$830	240	\$45	4,832	\$903	9,516	\$1,778	0.05	0.1369	\$1,302.39
40	2055	0.1879	4,444	\$835	240	\$45	4,832	\$908	9,516	\$1,788	0.05	0.1379	\$1,312.68
41	2056	0.1890	4,444	\$840	240	\$45	4,832	\$913	9,516	\$1,799	0.05	0.1390	\$1,323.03
42	2057	0.1901	4,444	\$845	240	\$46	4,832	\$919	9,516	\$1,809	0.05	0.1401	\$1,333.43
43	2058	0.1912	4,444	\$850	240	\$46	4,832	\$924	9,516	\$1,820	0.05	0.1412	\$1,343.90
44	2059	0.1923	4,444	\$855	240	\$46	4,832	\$929	9,516	\$1,830	0.05	0.1423	\$1,354.42
45	2060	0.1934	4,444	\$860	240	\$46	4,832	\$935	9,516	\$1,841	0.05	0.1434	\$1,365.01
46	2061	0.1946	4,444	\$865	240	\$47	4,832	\$940	9,516	\$1,851	0.05	0.1446	\$1,375.66
47	2062	0.1957	4,444	\$870	240	\$47	4,832	\$946	9,516	\$1,862	0.05	0.1457	\$1,386.37
48	2063	0.1968	4,444	\$875	240	\$47	4,832	\$951	9,516	\$1,873	0.05	0.1468	\$1,397.14
49	2064	0.1980	4,444	\$880	240	\$48	4,832	\$957	9,516	\$1,884	0.05	0.1480	\$1,407.98
50	2065	0.1991	4,444	\$885	240	\$48	4,832	\$962	9,516	\$1,895	0.05	0.1491	\$1,418.88
51	2066	0.2003	4,444	\$890	240	\$48	4,832	\$968	9,516	\$1,906	0.05	0.1503	\$1,429.84
52	2067	0.2014	4,444	\$895	240	\$48	4,832	\$973	9,516	\$1,917	0.05	0.1514	\$1,440.86
53	2068	0.2026	4,444	\$900	240	\$49	4,832	\$979	9,516	\$1,928	0.05	0.1526	\$1,451.95
54	2069	0.2038	4,444	\$905	240	\$49	4,832	\$985	9,516	\$1,939	0.05	0.1538	\$1,463.10
55	2070	0.2049	4,444	\$911	240	\$49	4,832	\$990	9,516	\$1,950	0.05	0.1549	\$1,474.32
56	2071	0.2061	4,444	\$916	240	\$49	4,832	\$996	9,516	\$1,961	0.05	0.1561	\$1,485.60
57	2072	0.2073	4,444	\$921	240	\$50	4,832	\$1,002	9,516	\$1,973	0.05	0.1573	\$1,496.94
58	2073	0.2085	4,444	\$927	240	\$50	4,832	\$1,008	9,516	\$1,984	0.05	0.1585	\$1,508.36
59	2074	0.2097	4,444	\$932	240	\$50	4,832	\$1,013	9,516	\$1,996	0.05	0.1597	\$1,519.83
60	2075	0.2109	4,444	\$937	240	\$51	4,832	\$1,019	9,516	\$2,007	0.05	0.1609	\$1,531.38

Table D2-1.58: Annual Operating Costs (V.GSHP) of a 2,000 square feet detached house above grade (improved construction type) in the city of Ottawa (two life cycles and three life cycles for a 60 year project lifespan); base case scenario in comparison with feed-in-tariff (FIT) scenario. In the FIT scenario, an incentive of \$0.05/KWh is provided on electricity bills throughout the project lifespan

Horizontal Ground Source Heat Pump (H.GSHP)

Base Case Scenario											Feed in Tariff (FIT)		
H.GSHP											FIT		
#	Year	Electricity Rates \$/KWh	Heating KWh	Heating Operating Cost \$	Cooling KWh	Cooling Operating Cost \$	Hot Water KWh	Hot Water Operating Cost \$	Total KWh	Total Operating Cost \$	Incentives (\$/KWh)	S/KWh	Operating Cost
1	2016	0.1501	4,534	\$680	247	\$37	4,810	\$722	9,591	\$1,439	0.05	0.1001	\$959.89
2	2017	0.1542	4,534	\$699	247	\$38	4,810	\$742	9,591	\$1,479	0.05	0.1042	\$999.26
3	2018	0.1583	4,534	\$718	247	\$39	4,810	\$761	9,591	\$1,518	0.05	0.1083	\$1,038.62
4	2019	0.1625	4,534	\$737	247	\$40	4,810	\$782	9,591	\$1,559	0.05	0.1125	\$1,079.36
5	2020	0.1668	4,534	\$756	247	\$41	4,810	\$802	9,591	\$1,600	0.05	0.1168	\$1,120.10
6	2021	0.1621	4,534	\$735	247	\$40	4,810	\$780	9,591	\$1,555	0.05	0.1121	\$1,075.56
7	2022	0.1629	4,534	\$739	247	\$40	4,810	\$784	9,591	\$1,563	0.05	0.1129	\$1,083.16
8	2023	0.1639	4,534	\$743	247	\$40	4,810	\$788	9,591	\$1,572	0.05	0.1139	\$1,092.13
9	2024	0.1648	4,534	\$747	247	\$41	4,810	\$793	9,591	\$1,581	0.05	0.1148	\$1,101.11
10	2025	0.1656	4,534	\$751	247	\$41	4,810	\$797	9,591	\$1,588	0.05	0.1156	\$1,108.71
11	2026	0.1665	4,534	\$755	247	\$41	4,810	\$801	9,591	\$1,597	0.05	0.1165	\$1,117.68
12	2027	0.1674	4,534	\$759	247	\$41	4,810	\$805	9,591	\$1,606	0.05	0.1174	\$1,126.32
13	2028	0.1683	4,534	\$763	247	\$42	4,810	\$809	9,591	\$1,614	0.05	0.1183	\$1,134.26
14	2029	0.1692	4,534	\$767	247	\$42	4,810	\$814	9,591	\$1,622	0.05	0.1192	\$1,142.89
15	2030	0.1701	4,534	\$771	247	\$42	4,810	\$818	9,591	\$1,631	0.05	0.1201	\$1,151.87
16	2031	0.1704	4,534	\$772	247	\$42	4,810	\$819	9,591	\$1,634	0.05	0.1204	\$1,154.28
17	2032	0.1705	4,534	\$773	247	\$42	4,810	\$820	9,591	\$1,635	0.05	0.1205	\$1,155.66
18	2033	0.1707	4,534	\$774	247	\$42	4,810	\$821	9,591	\$1,638	0.05	0.1207	\$1,158.08
19	2034	0.1710	4,534	\$775	247	\$42	4,810	\$823	9,591	\$1,640	0.05	0.1210	\$1,160.84
20	2035	0.1713	4,534	\$777	247	\$42	4,810	\$824	9,591	\$1,643	0.05	0.1213	\$1,163.26
21	2036	0.1714	4,534	\$777	247	\$42	4,810	\$825	9,591	\$1,644	0.05	0.1214	\$1,164.64
22	2037	0.1717	4,534	\$778	247	\$42	4,810	\$826	9,591	\$1,647	0.05	0.1217	\$1,167.06
23	2038	0.1720	4,534	\$780	247	\$42	4,810	\$827	9,591	\$1,649	0.05	0.1220	\$1,169.82
24	2039	0.1722	4,534	\$781	247	\$43	4,810	\$828	9,591	\$1,652	0.05	0.1222	\$1,172.24
25	2040	0.1724	4,534	\$782	247	\$43	4,810	\$829	9,591	\$1,653	0.05	0.1224	\$1,173.62
26	2041	0.1734	4,534	\$786	247	\$43	4,810	\$834	9,591	\$1,663	0.05	0.1234	\$1,183.18
27	2042	0.1744	4,534	\$791	247	\$43	4,810	\$839	9,591	\$1,672	0.05	0.1244	\$1,192.80
28	2043	0.1754	4,534	\$795	247	\$43	4,810	\$844	9,591	\$1,682	0.05	0.1254	\$1,202.47
29	2044	0.1764	4,534	\$800	247	\$44	4,810	\$848	9,591	\$1,692	0.05	0.1264	\$1,212.20
30	2045	0.1774	4,534	\$804	247	\$44	4,810	\$853	9,591	\$1,702	0.05	0.1274	\$1,221.99
31	2046	0.1784	4,534	\$809	247	\$44	4,810	\$858	9,591	\$1,711	0.05	0.1284	\$1,231.83
32	2047	0.1795	4,534	\$814	247	\$44	4,810	\$863	9,591	\$1,721	0.05	0.1295	\$1,241.73
33	2048	0.1805	4,534	\$818	247	\$45	4,810	\$868	9,591	\$1,731	0.05	0.1305	\$1,251.69
34	2049	0.1816	4,534	\$823	247	\$45	4,810	\$873	9,591	\$1,741	0.05	0.1316	\$1,261.71
35	2050	0.1826	4,534	\$828	247	\$45	4,810	\$878	9,591	\$1,751	0.05	0.1326	\$1,271.78
36	2051	0.1837	4,534	\$833	247	\$45	4,810	\$883	9,591	\$1,761	0.05	0.1337	\$1,281.91
37	2052	0.1847	4,534	\$838	247	\$46	4,810	\$889	9,591	\$1,772	0.05	0.1347	\$1,292.10
38	2053	0.1858	4,534	\$842	247	\$46	4,810	\$894	9,591	\$1,782	0.05	0.1358	\$1,302.35
39	2054	0.1869	4,534	\$847	247	\$46	4,810	\$899	9,591	\$1,792	0.05	0.1369	\$1,312.66
40	2055	0.1879	4,534	\$852	247	\$46	4,810	\$904	9,591	\$1,803	0.05	0.1379	\$1,323.03
41	2056	0.1890	4,534	\$857	247	\$47	4,810	\$909	9,591	\$1,813	0.05	0.1390	\$1,333.45
42	2057	0.1901	4,534	\$862	247	\$47	4,810	\$915	9,591	\$1,823	0.05	0.1401	\$1,343.94
43	2058	0.1912	4,534	\$867	247	\$47	4,810	\$920	9,591	\$1,834	0.05	0.1412	\$1,354.49
44	2059	0.1923	4,534	\$872	247	\$48	4,810	\$925	9,591	\$1,845	0.05	0.1423	\$1,365.10
45	2060	0.1934	4,534	\$877	247	\$48	4,810	\$930	9,591	\$1,855	0.05	0.1434	\$1,375.77
46	2061	0.1946	4,534	\$882	247	\$48	4,810	\$936	9,591	\$1,866	0.05	0.1446	\$1,386.50
47	2062	0.1957	4,534	\$887	247	\$48	4,810	\$941	9,591	\$1,877	0.05	0.1457	\$1,397.30
48	2063	0.1968	4,534	\$892	247	\$49	4,810	\$947	9,591	\$1,888	0.05	0.1468	\$1,408.16
49	2064	0.1980	4,534	\$898	247	\$49	4,810	\$952	9,591	\$1,899	0.05	0.1480	\$1,419.08
50	2065	0.1991	4,534	\$903	247	\$49	4,810	\$958	9,591	\$1,910	0.05	0.1491	\$1,430.06
51	2066	0.2003	4,534	\$908	247	\$49	4,810	\$963	9,591	\$1,921	0.05	0.1503	\$1,441.11
52	2067	0.2014	4,534	\$913	247	\$50	4,810	\$969	9,591	\$1,932	0.05	0.1514	\$1,452.22
53	2068	0.2026	4,534	\$918	247	\$50	4,810	\$974	9,591	\$1,943	0.05	0.1526	\$1,463.39
54	2069	0.2038	4,534	\$924	247	\$50	4,810	\$980	9,591	\$1,954	0.05	0.1538	\$1,474.63
55	2070	0.2049	4,534	\$929	247	\$51	4,810	\$986	9,591	\$1,965	0.05	0.1549	\$1,485.94
56	2071	0.2061	4,534	\$935	247	\$51	4,810	\$991	9,591	\$1,977	0.05	0.1561	\$1,497.31
57	2072	0.2073	4,534	\$940	247	\$51	4,810	\$997	9,591	\$1,988	0.05	0.1573	\$1,508.74
58	2073	0.2085	4,534	\$945	247	\$52	4,810	\$1,003	9,591	\$2,000	0.05	0.1585	\$1,520.24
59	2074	0.2097	4,534	\$951	247	\$52	4,810	\$1,009	9,591	\$2,011	0.05	0.1597	\$1,531.81
60	2075	0.2109	4,534	\$956	247	\$52	4,810	\$1,015	9,591	\$2,023	0.05	0.1609	\$1,543.45

Table D2-1.59: Annual Operating Costs (H.GSHP) of a 2,000 square feet detached house above grade (improved construction type) in the city of Ottawa (two life cycles and three life cycles for a 60 year project lifespan); base case scenario in comparison with feed in-tariff (FIT) scenario. In the FIT scenario, an incentive of \$0.05/KWh is provided on electricity bills throughout the project lifespan

Traditional HVAC Applications

Base Case Scenario															Carbon Taxes									
#	Year	Traditional													Total	Carbon Taxes								
		Electricity Rates	Natural Gas Rates	Heating		Heating Operating Cost	Heating Operating Cost	Total Heating Operating Cost	Cooling	Cooling Operating Cost		Hot Water	Hot Water Operating Cost			Total	Total	Total Electricity Operating Cost	Total Natural Gas Operating Cost	Total	Conversion of m ³ into Tons	Total Tons	Carbon Tax	Operating Costs
				KWh (Electricity)	m ³ (Gas)					\$ (Electricity)	\$ (Gas)		\$	\$										
\$/KWh	\$/m ³																							
1	2016	0.1501	0.3458	1,698	2,133	\$255	\$738	\$992	1,201	\$180	1,047	\$362	2,899	3,180	435	\$1,100	\$1,535	5.76	5.76	\$10	\$57.56	\$1,592.39		
2	2017	0.1542	0.3588	1,698	2,133	\$262	\$765	\$1,027	1,201	\$185	1,047	\$161	2,899	3,180	447	\$1,141	\$1,588	5.76	5.76	\$20	\$115.12	\$1,703.21		
3	2018	0.1583	0.3718	1,698	2,133	\$269	\$793	\$1,062	1,201	\$190	1,047	\$166	2,899	3,180	459	\$1,182	\$1,641	5.76	5.76	\$30	\$172.67	\$1,814.02		
4	2019	0.1625	0.3776	1,698	2,133	\$276	\$805	\$1,081	1,201	\$195	1,047	\$170	2,899	3,180	471	\$1,201	\$1,672	5.76	5.76	\$40	\$230.23	\$1,902.14		
5	2020	0.1668	0.3841	1,698	2,133	\$283	\$819	\$1,102	1,201	\$200	1,047	\$175	2,899	3,180	484	\$1,221	\$1,705	5.76	5.76	\$50	\$287.79	\$1,992.70		
6	2021	0.1621	0.3883	1,698	2,133	\$275	\$828	\$1,104	1,201	\$195	1,047	\$170	2,899	3,180	470	\$1,235	\$1,705	5.76	5.76	\$60	\$345.35	\$2,050.17		
7	2022	0.1629	0.3929	1,698	2,133	\$277	\$838	\$1,115	1,201	\$196	1,047	\$171	2,899	3,180	472	\$1,249	\$1,722	5.76	5.76	\$70	\$402.91	\$2,124.63		
8	2023	0.1639	0.3967	1,698	2,133	\$278	\$846	\$1,124	1,201	\$197	1,047	\$172	2,899	3,180	475	\$1,262	\$1,737	5.76	5.76	\$80	\$460.46	\$2,197.06		
9	2024	0.1648	0.4005	1,698	2,133	\$280	\$854	\$1,134	1,201	\$198	1,047	\$173	2,899	3,180	478	\$1,274	\$1,751	5.76	5.76	\$90	\$518.02	\$2,269.50		
10	2025	0.1656	0.4040	1,698	2,133	\$281	\$862	\$1,143	1,201	\$199	1,047	\$173	2,899	3,180	480	\$1,285	\$1,765	5.76	5.76	\$100	\$575.58	\$2,340.30		
11	2026	0.1665	0.4070	1,698	2,133	\$283	\$868	\$1,151	1,201	\$200	1,047	\$174	2,899	3,180	483	\$1,294	\$1,777	5.76	5.76	\$110	\$633.14	\$2,410.31		
12	2027	0.1674	0.4097	1,698	2,133	\$284	\$874	\$1,158	1,201	\$201	1,047	\$175	2,899	3,180	485	\$1,303	\$1,788	5.76	5.76	\$120	\$690.70	\$2,478.99		
13	2028	0.1683	0.4124	1,698	2,133	\$286	\$880	\$1,165	1,201	\$202	1,047	\$176	2,899	3,180	488	\$1,311	\$1,799	5.76	5.76	\$130	\$748.25	\$2,547.46		
14	2029	0.1692	0.4151	1,698	2,133	\$287	\$885	\$1,173	1,201	\$203	1,047	\$177	2,899	3,180	490	\$1,320	\$1,810	5.76	5.76	\$140	\$805.81	\$2,616.15		
15	2030	0.1701	0.4170	1,698	2,133	\$289	\$889	\$1,178	1,201	\$204	1,047	\$178	2,899	3,180	493	\$1,326	\$1,819	5.76	5.76	\$150	\$863.37	\$2,682.50		
16	2031	0.1704	0.4189	1,698	2,133	\$289	\$894	\$1,183	1,201	\$205	1,047	\$178	2,899	3,180	494	\$1,332	\$1,826	5.76	5.76	\$160	\$920.93	\$2,746.87		
17	2032	0.1705	0.4204	1,698	2,133	\$289	\$897	\$1,186	1,201	\$205	1,047	\$179	2,899	3,180	494	\$1,337	\$1,831	5.76	5.76	\$170	\$978.49	\$2,809.71		
18	2033	0.1707	0.4223	1,698	2,133	\$290	\$901	\$1,191	1,201	\$205	1,047	\$179	2,899	3,180	495	\$1,343	\$1,838	5.76	5.76	\$180	\$1,036.04	\$2,874.08		
19	2034	0.1710	0.4246	1,698	2,133	\$290	\$906	\$1,196	1,201	\$205	1,047	\$179	2,899	3,180	496	\$1,350	\$1,846	5.76	5.76	\$190	\$1,093.60	\$2,939.78		
20	2035	0.1713	0.4265	1,698	2,133	\$291	\$910	\$1,201	1,201	\$206	1,047	\$179	2,899	3,180	497	\$1,356	\$1,853	5.76	5.76	\$200	\$1,151.16	\$3,004.15		
21	2036	0.1714	0.4288	1,698	2,133	\$291	\$915	\$1,206	1,201	\$206	1,047	\$179	2,899	3,180	497	\$1,364	\$1,861	5.76	5.76	\$210	\$1,208.72	\$3,069.42		
22	2037	0.1717	0.4311	1,698	2,133	\$292	\$920	\$1,211	1,201	\$206	1,047	\$180	2,899	3,180	498	\$1,371	\$1,869	5.76	5.76	\$220	\$1,266.28	\$3,135.01		
23	2038	0.1720	0.4331	1,698	2,133	\$292	\$924	\$1,216	1,201	\$207	1,047	\$180	2,899	3,180	499	\$1,377	\$1,876	5.76	5.76	\$230	\$1,323.83	\$3,199.48		
24	2039	0.1722	0.4353	1,698	2,133	\$292	\$929	\$1,221	1,201	\$207	1,047	\$180	2,899	3,180	499	\$1,384	\$1,884	5.76	5.76	\$240	\$1,381.39	\$3,265.07		
25	2040	0.1724	0.4376	1,698	2,133	\$293	\$933	\$1,226	1,201	\$207	1,047	\$180	2,899	3,180	500	\$1,392	\$1,891	5.76	5.76	\$250	\$1,438.95	\$3,330.35		
26	2041	0.1734	0.4420	1,698	2,133	\$294	\$943	\$1,237	1,201	\$208	1,047	\$182	2,899	3,180	503	\$1,405	\$1,908	5.76	5.76	\$260	\$1,496.51	\$3,404.52		
27	2042	0.1744	0.4463	1,698	2,133	\$296	\$952	\$1,248	1,201	\$209	1,047	\$183	2,899	3,180	505	\$1,419	\$1,925	5.76	5.76	\$270	\$1,554.07	\$3,478.84		
28	2043	0.1754	0.4507	1,698	2,133	\$298	\$961	\$1,259	1,201	\$211	1,047	\$184	2,899	3,180	508	\$1,433	\$1,942	5.76	5.76	\$280	\$1,611.62	\$3,553.31		
29	2044	0.1764	0.4552	1,698	2,133	\$300	\$971	\$1,270	1,201	\$212	1,047	\$185	2,899	3,180	511	\$1,447	\$1,959	5.76	5.76	\$290	\$1,669.18	\$3,627.94		
30	2045	0.1774	0.4596	1,698	2,133	\$301	\$980	\$1,282	1,201	\$213	1,047	\$186	2,899	3,180	514	\$1,462	\$1,976	5.76	5.76	\$300	\$1,726.74	\$3,702.73		
31	2046	0.1784	0.4640	1,698	2,133	\$303	\$987	\$1,293	1,201	\$216	1,047	\$187	2,899	3,180	517	\$1,476	\$1,993	5.76	5.76	\$310	\$1,784.02	\$3,777.67		
32	2047	0.1795	0.4688	1,698	2,133	\$305	\$1,000	\$1,305	1,201	\$216	1,047	\$188	2,899	3,180	520	\$1,491	\$2,011	5.76	5.76	\$320	\$1,841.86	\$3,852.78		
33	2048	0.1805	0.4734	1,698	2,133	\$307	\$1,010	\$1,316	1,201	\$217	1,047	\$189	2,899	3,180	523	\$1,505	\$2,029	5.76	5.76	\$330	\$1,899.41	\$3,928.04		
34	2049	0.1816	0.4780	1,698	2,133	\$308	\$1,020	\$1,328	1,201	\$218	1,047	\$190	2,899	3,180	526	\$1,520	\$2,046	5.76	5.76	\$340	\$1,956.97	\$4,003.47		
35	2050	0.1826	0.4828	1,698	2,133	\$310	\$1,030	\$1,340	1,201	\$219	1,047	\$191	2,899	3,180	529	\$1,535	\$2,065	5.76	5.76	\$350	\$2,014.53	\$4,079.06		
36	2051	0.1837	0.4875	1,698	2,133	\$312	\$1,040	\$1,352	1,201	\$221	1,047	\$192	2,899	3,180	532	\$1,550	\$2,083	5.76	5.76	\$360	\$2,072.09	\$4,154.81		
37	2052	0.1847	0.4923	1,698	2,133	\$314	\$1,050	\$1,364	1,201	\$222	1,047	\$193	2,899	3,180	536	\$1,566	\$2,101	5.76	5.76	\$370	\$2,129.65	\$4,230.73		
38	2053	0.1858	0.4972	1,698	2,133	\$315	\$1,060	\$1,376	1,201	\$223	1,047	\$195	2,899	3,180	539	\$1,581	\$2,120	5.76	5.76	\$380	\$2,187.20	\$4,306.82		
39	2054	0.1869	0.5021	1,698	2,133	\$317	\$1,071	\$1,388	1,201	\$224	1,047	\$196	2,899	3,180	542	\$1,597	\$2,138	5.76	5.76	\$390	\$2,244.76	\$4,383.09		
40	2055	0.1879	0.5070	1,698	2,133	\$319	\$1,081	\$1,401	1,201	\$226	1,047	\$197	2,899	3,180	545	\$1,612	\$2,157	5.76	5.76	\$400	\$2,302.32	\$4,459.52		
41	2056	0.1890	0.5120	1,698	2,133	\$321	\$1,092	\$1,413	1,201	\$227	1,047	\$198	2,899	3,180	548	\$1,628	\$2,176	5.76	5.76	\$410	\$2,359.88	\$4,536.12		
42	2057	0.1901	0.5171	1,698	2,133	\$323	\$1,103	\$1,426	1,201	\$228	1,047	\$199	2,899	3,180	551	\$1,644	\$2,195	5.76	5.76	\$420	\$2,417.44	\$4,612.91		
43	2058	0.1912	0.5222	1,698	2,133	\$325	\$1,114	\$1,438	1,201	\$230	1,047	\$200	2,899	3,180	554	\$1,661	\$2,215	5.76	5.76	\$430	\$2,474.99	\$4,689.86		
44	2059	0.1923	0.5273	1,698	2,133	\$327	\$1,125	\$1,451	1,201	\$231	1,047	\$201	2,899	3,180	558	\$1,677	\$2,234	5.76	5.76	\$440	\$2,532.55	\$4,767.00		
45	2060	0.1934	0.5325	1,698	2,133	\$328	\$1,136	\$1,464	1,201	\$232	1,047	\$203	2,899	3,180	561	\$1,693	\$2,254	5.76	5.76	\$450	\$2,590.11	\$4,844.31		
46	2061	0.1946	0.5378	1,698	2,133	\$330	\$1,147	\$1,477	1,201	\$234	1,047	\$204	2,899	3,180	564	\$1,710	\$2,274	5.76	5.76	\$460	\$2,647.67	\$4,921.81		
47	2062	0.1957	0.5431	1,698	2,133	\$332	\$1,158	\$1,491	1,201	\$235	1,047	\$205	2,899	3,180	567	\$1,727	\$2,294	5.76	5.76	\$470	\$2,705.23	\$4,999.49		
48	2063	0.1968	0.5484	1,698	2,133	\$334	\$1,170	\$1,504	1,201	\$236	1,047	\$206	2,899	3,180	571	\$1,744	\$2,315	5.76	5.76	\$480	\$2,762.78	\$5,077.36		
49	2064	0.1980	0.5538	1,698	2,133	\$336	\$1,181	\$1,517	1,201	\$238	1,047	\$207	2,899	3,180	574	\$1,761	\$2,335	5.76	5.76	\$490	\$2,820.34	\$5,155.41		
50	2065	0.1991	0.5593	1,698	2,133	\$338	\$1,193	\$1,531	1,201	\$239	1,047	\$208	2,899	3,180	577	\$1,779	\$2,356	5.76	5.76	\$500	\$2,877.90	\$5,233.65		
51	2066	0.2003	0.5648	1,698	2,133	\$340	\$1,205	\$1,545	1,201	\$241	1,047	\$210	2,899	3,180	581	\$1,796	\$2,377	5.76	5.76	\$510	\$2,935.46	\$5,312.08		
52	2067	0.2014	0.5704	1,698	2,133	\$342	\$1,217	\$1,559	1,201	\$242	1,047	\$211	2,899	3,180	584	\$1,814	\$2,398	5.76	5.76	\$520	\$2,993.02	\$5,390.71		
53	2068	0.2026																						

21. Kapuskasing (North) – Annual Operating Costs

Vertical Ground Source Heat Pump (V.GSHP)

Base Case Scenario											Feed in Tariff (FIT)			
#	Year	V.GSHP		V.GSHP		V.GSHP		V.GSHP		Total	Total Operating Cost	Incentives (\$/KWh)	FIT	
		Electricity Rates	Heating	Heating Operating Cost	Cooling	Cooling Operating Cost	Hot Water	Hot Water Operating Cost	S/KWh				Operating Cost	
		\$/KWh	KWh	\$	KWh	\$	KWh	\$	KWh	\$		S/KWh	Operating Cost	
1	2016	0.1501	6,671	\$1,001	142	\$21	4,572	\$686	11,385	\$1,709	0.05	0.1001	\$1,139.44	
2	2017	0.1542	6,671	\$1,029	142	\$22	4,572	\$705	11,385	\$1,755	0.05	0.1042	\$1,186.17	
3	2018	0.1583	6,671	\$1,056	142	\$22	4,572	\$724	11,385	\$1,802	0.05	0.1083	\$1,232.89	
4	2019	0.1625	6,671	\$1,084	142	\$23	4,572	\$743	11,385	\$1,851	0.05	0.1125	\$1,281.25	
5	2020	0.1668	6,671	\$1,113	142	\$24	4,572	\$763	11,385	\$1,899	0.05	0.1168	\$1,329.62	
6	2021	0.1621	6,671	\$1,082	142	\$23	4,572	\$741	11,385	\$1,846	0.05	0.1121	\$1,276.74	
7	2022	0.1629	6,671	\$1,087	142	\$23	4,572	\$745	11,385	\$1,855	0.05	0.1129	\$1,285.76	
8	2023	0.1639	6,671	\$1,093	142	\$23	4,572	\$749	11,385	\$1,866	0.05	0.1139	\$1,296.42	
9	2024	0.1648	6,671	\$1,099	142	\$23	4,572	\$753	11,385	\$1,876	0.05	0.1148	\$1,307.07	
10	2025	0.1656	6,671	\$1,105	142	\$24	4,572	\$757	11,385	\$1,885	0.05	0.1156	\$1,316.09	
11	2026	0.1665	6,671	\$1,111	142	\$24	4,572	\$761	11,385	\$1,896	0.05	0.1165	\$1,326.75	
12	2027	0.1674	6,671	\$1,117	142	\$24	4,572	\$766	11,385	\$1,906	0.05	0.1174	\$1,336.99	
13	2028	0.1683	6,671	\$1,122	142	\$24	4,572	\$769	11,385	\$1,916	0.05	0.1183	\$1,346.42	
14	2029	0.1692	6,671	\$1,128	142	\$24	4,572	\$773	11,385	\$1,926	0.05	0.1192	\$1,356.67	
15	2030	0.1701	6,671	\$1,135	142	\$24	4,572	\$778	11,385	\$1,937	0.05	0.1201	\$1,367.32	
16	2031	0.1704	6,671	\$1,136	142	\$24	4,572	\$779	11,385	\$1,939	0.05	0.1204	\$1,370.19	
17	2032	0.1705	6,671	\$1,137	142	\$24	4,572	\$780	11,385	\$1,941	0.05	0.1205	\$1,371.83	
18	2033	0.1707	6,671	\$1,139	142	\$24	4,572	\$781	11,385	\$1,944	0.05	0.1207	\$1,374.70	
19	2034	0.1710	6,671	\$1,141	142	\$24	4,572	\$782	11,385	\$1,947	0.05	0.1210	\$1,377.98	
20	2035	0.1713	6,671	\$1,143	142	\$24	4,572	\$783	11,385	\$1,950	0.05	0.1213	\$1,380.85	
21	2036	0.1714	6,671	\$1,144	142	\$24	4,572	\$784	11,385	\$1,952	0.05	0.1214	\$1,382.49	
22	2037	0.1717	6,671	\$1,145	142	\$24	4,572	\$785	11,385	\$1,955	0.05	0.1217	\$1,385.36	
23	2038	0.1720	6,671	\$1,147	142	\$24	4,572	\$786	11,385	\$1,958	0.05	0.1220	\$1,388.64	
24	2039	0.1722	6,671	\$1,149	142	\$24	4,572	\$787	11,385	\$1,961	0.05	0.1222	\$1,391.50	
25	2040	0.1724	6,671	\$1,150	142	\$24	4,572	\$788	11,385	\$1,962	0.05	0.1224	\$1,393.14	
26	2041	0.1724	6,671	\$1,157	142	\$25	4,572	\$793	11,385	\$1,974	0.05	0.1234	\$1,404.50	
27	2042	0.1744	6,671	\$1,163	142	\$25	4,572	\$797	11,385	\$1,985	0.05	0.1244	\$1,415.91	
28	2043	0.1754	6,671	\$1,170	142	\$25	4,572	\$802	11,385	\$1,997	0.05	0.1254	\$1,427.40	
29	2044	0.1764	6,671	\$1,177	142	\$25	4,572	\$806	11,385	\$2,008	0.05	0.1264	\$1,438.95	
30	2045	0.1774	6,671	\$1,184	142	\$25	4,572	\$811	11,385	\$2,020	0.05	0.1274	\$1,450.57	
31	2046	0.1784	6,671	\$1,190	142	\$25	4,572	\$816	11,385	\$2,031	0.05	0.1284	\$1,462.25	
32	2047	0.1795	6,671	\$1,197	142	\$25	4,572	\$821	11,385	\$2,043	0.05	0.1295	\$1,474.00	
33	2048	0.1805	6,671	\$1,204	142	\$26	4,572	\$825	11,385	\$2,055	0.05	0.1305	\$1,485.82	
34	2049	0.1816	6,671	\$1,211	142	\$26	4,572	\$830	11,385	\$2,067	0.05	0.1316	\$1,497.71	
35	2050	0.1826	6,671	\$1,218	142	\$26	4,572	\$835	11,385	\$2,079	0.05	0.1326	\$1,509.67	
36	2051	0.1837	6,671	\$1,225	142	\$26	4,572	\$840	11,385	\$2,091	0.05	0.1337	\$1,521.69	
37	2052	0.1847	6,671	\$1,232	142	\$26	4,572	\$845	11,385	\$2,103	0.05	0.1347	\$1,533.79	
38	2053	0.1858	6,671	\$1,239	142	\$26	4,572	\$849	11,385	\$2,115	0.05	0.1358	\$1,545.95	
39	2054	0.1869	6,671	\$1,247	142	\$27	4,572	\$854	11,385	\$2,127	0.05	0.1369	\$1,558.19	
40	2055	0.1879	6,671	\$1,254	142	\$27	4,572	\$859	11,385	\$2,140	0.05	0.1379	\$1,570.50	
41	2056	0.1890	6,671	\$1,261	142	\$27	4,572	\$864	11,385	\$2,152	0.05	0.1390	\$1,582.88	
42	2057	0.1901	6,671	\$1,268	142	\$27	4,572	\$869	11,385	\$2,165	0.05	0.1401	\$1,595.33	
43	2058	0.1912	6,671	\$1,276	142	\$27	4,572	\$874	11,385	\$2,177	0.05	0.1412	\$1,607.85	
44	2059	0.1923	6,671	\$1,283	142	\$27	4,572	\$879	11,385	\$2,190	0.05	0.1423	\$1,620.44	
45	2060	0.1934	6,671	\$1,290	142	\$27	4,572	\$884	11,385	\$2,202	0.05	0.1434	\$1,633.11	
46	2061	0.1946	6,671	\$1,298	142	\$28	4,572	\$890	11,385	\$2,215	0.05	0.1446	\$1,645.85	
47	2062	0.1957	6,671	\$1,305	142	\$28	4,572	\$895	11,385	\$2,228	0.05	0.1457	\$1,658.66	
48	2063	0.1968	6,671	\$1,313	142	\$28	4,572	\$900	11,385	\$2,241	0.05	0.1468	\$1,671.55	
49	2064	0.1980	6,671	\$1,321	142	\$28	4,572	\$905	11,385	\$2,254	0.05	0.1480	\$1,684.51	
50	2065	0.1991	6,671	\$1,328	142	\$28	4,572	\$910	11,385	\$2,267	0.05	0.1491	\$1,697.55	
51	2066	0.2003	6,671	\$1,336	142	\$28	4,572	\$916	11,385	\$2,280	0.05	0.1503	\$1,710.66	
52	2067	0.2014	6,671	\$1,344	142	\$29	4,572	\$921	11,385	\$2,293	0.05	0.1514	\$1,723.85	
53	2068	0.2026	6,671	\$1,351	142	\$29	4,572	\$926	11,385	\$2,306	0.05	0.1526	\$1,737.12	
54	2069	0.2038	6,671	\$1,359	142	\$29	4,572	\$932	11,385	\$2,320	0.05	0.1538	\$1,750.46	
55	2070	0.2049	6,671	\$1,367	142	\$29	4,572	\$937	11,385	\$2,333	0.05	0.1549	\$1,763.88	
56	2071	0.2061	6,671	\$1,375	142	\$29	4,572	\$942	11,385	\$2,347	0.05	0.1561	\$1,777.38	
57	2072	0.2073	6,671	\$1,383	142	\$29	4,572	\$948	11,385	\$2,360	0.05	0.1573	\$1,790.95	
58	2073	0.2085	6,671	\$1,391	142	\$30	4,572	\$953	11,385	\$2,374	0.05	0.1585	\$1,804.61	
59	2074	0.2097	6,671	\$1,399	142	\$30	4,572	\$959	11,385	\$2,388	0.05	0.1597	\$1,818.34	
60	2075	0.2109	6,671	\$1,407	142	\$30	4,572	\$964	11,385	\$2,401	0.05	0.1609	\$1,832.15	

Table D2-1.61: Annual Operating Costs (V.GSHP) of a 2,000 square foot detached house above grade (improved construction type) in the city of Kapuskasing (two life cycles and three life cycles for a 60 year project lifespan); base case scenario in comparison with feed in-tariff (FIT) scenario. In the FIT scenario, an incentive of \$0.05/KWh is provided on electricity bills throughout the project lifespan

Horizontal Ground Source Heat Pump (H.GSHP)

Base Case Scenario											Feed in Tariff (FIT)		
#	Year	H.GSHP									FIT		
		Electricity Rates \$/KWh	Heating KWh	Heating Operating Cost \$	Cooling KWh	Cooling Operating Cost \$	Hot Water KWh	Hot Water Operating Cost \$	Total KWh	Total Operating Cost \$	Incentives (\$/KWh)	S/KWh	Operating Cost
1	2016	0.1501	6,754	\$1,014	143	\$21	4,559	\$684	11,456	\$1,719	0.05	0.1001	\$1,146.55
2	2017	0.1542	6,754	\$1,041	143	\$22	4,559	\$703	11,456	\$1,766	0.05	0.1042	\$1,193.56
3	2018	0.1583	6,754	\$1,069	143	\$23	4,559	\$722	11,456	\$1,813	0.05	0.1083	\$1,240.58
4	2019	0.1625	6,754	\$1,098	143	\$23	4,559	\$741	11,456	\$1,862	0.05	0.1125	\$1,289.24
5	2020	0.1668	6,754	\$1,126	143	\$24	4,559	\$760	11,456	\$1,911	0.05	0.1168	\$1,337.91
6	2021	0.1621	6,754	\$1,095	143	\$23	4,559	\$739	11,456	\$1,858	0.05	0.1121	\$1,284.71
7	2022	0.1629	6,754	\$1,100	143	\$23	4,559	\$743	11,456	\$1,867	0.05	0.1129	\$1,293.78
8	2023	0.1639	6,754	\$1,107	143	\$23	4,559	\$747	11,456	\$1,877	0.05	0.1139	\$1,304.50
9	2024	0.1648	6,754	\$1,113	143	\$24	4,559	\$751	11,456	\$1,888	0.05	0.1148	\$1,315.23
10	2025	0.1656	6,754	\$1,118	143	\$24	4,559	\$755	11,456	\$1,897	0.05	0.1156	\$1,324.30
11	2026	0.1665	6,754	\$1,125	143	\$24	4,559	\$759	11,456	\$1,908	0.05	0.1165	\$1,335.02
12	2027	0.1674	6,754	\$1,131	143	\$24	4,559	\$763	11,456	\$1,918	0.05	0.1174	\$1,345.33
13	2028	0.1683	6,754	\$1,136	143	\$24	4,559	\$767	11,456	\$1,928	0.05	0.1183	\$1,354.82
14	2029	0.1692	6,754	\$1,143	143	\$24	4,559	\$771	11,456	\$1,938	0.05	0.1192	\$1,365.13
15	2030	0.1701	6,754	\$1,149	143	\$24	4,559	\$775	11,456	\$1,949	0.05	0.1201	\$1,375.85
16	2031	0.1704	6,754	\$1,151	143	\$24	4,559	\$777	11,456	\$1,952	0.05	0.1204	\$1,378.74
17	2032	0.1705	6,754	\$1,152	143	\$24	4,559	\$777	11,456	\$1,953	0.05	0.1205	\$1,380.39
18	2033	0.1707	6,754	\$1,153	143	\$24	4,559	\$778	11,456	\$1,956	0.05	0.1207	\$1,383.27
19	2034	0.1710	6,754	\$1,155	143	\$24	4,559	\$780	11,456	\$1,959	0.05	0.1210	\$1,386.57
20	2035	0.1713	6,754	\$1,157	143	\$24	4,559	\$781	11,456	\$1,962	0.05	0.1213	\$1,389.46
21	2036	0.1714	6,754	\$1,158	143	\$25	4,559	\$782	11,456	\$1,964	0.05	0.1214	\$1,391.11
22	2037	0.1717	6,754	\$1,160	143	\$25	4,559	\$783	11,456	\$1,967	0.05	0.1217	\$1,394.00
23	2038	0.1720	6,754	\$1,161	143	\$25	4,559	\$784	11,456	\$1,970	0.05	0.1220	\$1,397.30
24	2039	0.1722	6,754	\$1,163	143	\$25	4,559	\$785	11,456	\$1,973	0.05	0.1222	\$1,400.18
25	2040	0.1724	6,754	\$1,164	143	\$25	4,559	\$786	11,456	\$1,975	0.05	0.1224	\$1,401.83
26	2041	0.1734	6,754	\$1,171	143	\$25	4,559	\$790	11,456	\$1,986	0.05	0.1234	\$1,413.25
27	2042	0.1744	6,754	\$1,178	143	\$25	4,559	\$795	11,456	\$1,998	0.05	0.1244	\$1,424.74
28	2043	0.1754	6,754	\$1,184	143	\$25	4,559	\$800	11,456	\$2,009	0.05	0.1254	\$1,436.30
29	2044	0.1764	6,754	\$1,191	143	\$25	4,559	\$804	11,456	\$2,021	0.05	0.1264	\$1,447.92
30	2045	0.1774	6,754	\$1,198	143	\$25	4,559	\$809	11,456	\$2,032	0.05	0.1274	\$1,459.61
31	2046	0.1784	6,754	\$1,205	143	\$26	4,559	\$813	11,456	\$2,044	0.05	0.1284	\$1,471.37
32	2047	0.1795	6,754	\$1,212	143	\$26	4,559	\$818	11,456	\$2,056	0.05	0.1295	\$1,483.19
33	2048	0.1805	6,754	\$1,219	143	\$26	4,559	\$823	11,456	\$2,068	0.05	0.1305	\$1,495.09
34	2049	0.1816	6,754	\$1,226	143	\$26	4,559	\$828	11,456	\$2,080	0.05	0.1316	\$1,507.05
35	2050	0.1826	6,754	\$1,233	143	\$26	4,559	\$832	11,456	\$2,092	0.05	0.1326	\$1,519.08
36	2051	0.1837	6,754	\$1,240	143	\$26	4,559	\$837	11,456	\$2,104	0.05	0.1337	\$1,531.18
37	2052	0.1847	6,754	\$1,248	143	\$26	4,559	\$842	11,456	\$2,116	0.05	0.1347	\$1,543.35
38	2053	0.1858	6,754	\$1,255	143	\$27	4,559	\$847	11,456	\$2,128	0.05	0.1358	\$1,555.60
39	2054	0.1869	6,754	\$1,262	143	\$27	4,559	\$852	11,456	\$2,141	0.05	0.1369	\$1,567.91
40	2055	0.1879	6,754	\$1,269	143	\$27	4,559	\$857	11,456	\$2,153	0.05	0.1379	\$1,580.29
41	2056	0.1890	6,754	\$1,277	143	\$27	4,559	\$862	11,456	\$2,166	0.05	0.1390	\$1,592.75
42	2057	0.1901	6,754	\$1,284	143	\$27	4,559	\$867	11,456	\$2,178	0.05	0.1401	\$1,605.27
43	2058	0.1912	6,754	\$1,292	143	\$27	4,559	\$872	11,456	\$2,191	0.05	0.1412	\$1,617.87
44	2059	0.1923	6,754	\$1,299	143	\$28	4,559	\$877	11,456	\$2,203	0.05	0.1423	\$1,630.55
45	2060	0.1934	6,754	\$1,307	143	\$28	4,559	\$882	11,456	\$2,216	0.05	0.1434	\$1,643.29
46	2061	0.1946	6,754	\$1,314	143	\$28	4,559	\$887	11,456	\$2,229	0.05	0.1446	\$1,656.11
47	2062	0.1957	6,754	\$1,322	143	\$28	4,559	\$892	11,456	\$2,242	0.05	0.1457	\$1,669.01
48	2063	0.1968	6,754	\$1,329	143	\$28	4,559	\$897	11,456	\$2,255	0.05	0.1468	\$1,681.98
49	2064	0.1980	6,754	\$1,337	143	\$28	4,559	\$902	11,456	\$2,268	0.05	0.1480	\$1,695.02
50	2065	0.1991	6,754	\$1,345	143	\$28	4,559	\$908	11,456	\$2,281	0.05	0.1491	\$1,708.14
51	2066	0.2003	6,754	\$1,353	143	\$29	4,559	\$913	11,456	\$2,294	0.05	0.1503	\$1,721.33
52	2067	0.2014	6,754	\$1,360	143	\$29	4,559	\$918	11,456	\$2,307	0.05	0.1514	\$1,734.60
53	2068	0.2026	6,754	\$1,368	143	\$29	4,559	\$924	11,456	\$2,321	0.05	0.1526	\$1,747.95
54	2069	0.2038	6,754	\$1,376	143	\$29	4,559	\$929	11,456	\$2,334	0.05	0.1538	\$1,761.38
55	2070	0.2049	6,754	\$1,384	143	\$29	4,559	\$934	11,456	\$2,348	0.05	0.1549	\$1,774.88
56	2071	0.2061	6,754	\$1,392	143	\$29	4,559	\$940	11,456	\$2,361	0.05	0.1561	\$1,788.46
57	2072	0.2073	6,754	\$1,400	143	\$30	4,559	\$945	11,456	\$2,375	0.05	0.1573	\$1,802.12
58	2073	0.2085	6,754	\$1,408	143	\$30	4,559	\$951	11,456	\$2,389	0.05	0.1585	\$1,815.86
59	2074	0.2097	6,754	\$1,416	143	\$30	4,559	\$956	11,456	\$2,402	0.05	0.1597	\$1,829.68
60	2075	0.2109	6,754	\$1,425	143	\$30	4,559	\$962	11,456	\$2,416	0.05	0.1609	\$1,843.58

Table D2-1.62: Annual Operating Costs (H.GSHP) of a 2,000 square feet detached house above grade (improved construction type) in the city of Kapuskasing (two life cycles and three life cycles for a 60 year project lifespan); base case scenario in comparison with feed in-tariff (FIT) scenario. In the FIT scenario, an incentive of \$0.05/KWh is provided on electricity bills throughout the project lifespan

Traditional HVAC Applications

Base Case Scenario															Carbon Taxes							
#	Year	Electricity Rates	Natural Gas Rates	Heating		Heating Operating Cost	Heating Operating Cost	Total Heating Operating Cost	Cooling	Cooling		Hot Water	Hot Water Operating Cost	Total	Total	Total Electricity Operating Cost	Total Natural Gas Operating Cost	Total	Conversion of m ³ into Tons	Total Tons	Carbon Tax	Operating Costs
				KWh (Electricity)	m ³ (Gas)					\$ (Electricity)	\$ (Gas)											
1	2016	0.1501	0.3458	2,715	2,989	\$407	\$1,034	\$1,441	799	\$120	1,103	\$381	3,514	4,092	527	\$1,415	\$1,943	7.41	7.41	\$10	\$74.07	\$2,016.59
2	2017	0.1542	0.3588	2,715	2,989	\$419	\$1,073	\$1,491	799	\$123	1,103	\$170	3,514	4,092	542	\$1,468	\$2,010	7.41	7.41	\$20	\$148.13	\$2,158.30
3	2018	0.1583	0.3718	2,715	2,989	\$430	\$1,111	\$1,541	799	\$126	1,103	\$175	3,514	4,092	556	\$1,522	\$2,078	7.41	7.41	\$30	\$222.20	\$2,300.01
4	2019	0.1625	0.3776	2,715	2,989	\$441	\$1,129	\$1,570	799	\$130	1,103	\$179	3,514	4,092	571	\$1,545	\$2,116	7.41	7.41	\$40	\$296.26	\$2,412.49
5	2020	0.1668	0.3841	2,715	2,989	\$453	\$1,148	\$1,601	799	\$133	1,103	\$184	3,514	4,092	586	\$1,572	\$2,158	7.41	7.41	\$50	\$370.33	\$2,528.09
6	2021	0.1621	0.3883	2,715	2,989	\$440	\$1,161	\$1,601	799	\$130	1,103	\$179	3,514	4,092	570	\$1,589	\$2,159	7.41	7.41	\$60	\$444.39	\$2,603.06
7	2022	0.1629	0.3929	2,715	2,989	\$442	\$1,174	\$1,617	799	\$130	1,103	\$180	3,514	4,092	573	\$1,608	\$2,180	7.41	7.41	\$70	\$518.46	\$2,698.69
8	2023	0.1639	0.3967	2,715	2,989	\$445	\$1,186	\$1,631	799	\$131	1,103	\$181	3,514	4,092	576	\$1,623	\$2,199	7.41	7.41	\$80	\$592.52	\$2,791.70
9	2024	0.1648	0.4005	2,715	2,989	\$447	\$1,197	\$1,645	799	\$132	1,103	\$182	3,514	4,092	579	\$1,639	\$2,218	7.41	7.41	\$90	\$666.59	\$2,884.71
10	2025	0.1656	0.4040	2,715	2,989	\$450	\$1,207	\$1,657	799	\$132	1,103	\$183	3,514	4,092	582	\$1,653	\$2,235	7.41	7.41	\$100	\$740.65	\$2,975.65
11	2026	0.1665	0.4070	2,715	2,989	\$452	\$1,217	\$1,669	799	\$133	1,103	\$184	3,514	4,092	585	\$1,666	\$2,251	7.41	7.41	\$110	\$814.72	\$3,065.52
12	2027	0.1674	0.4097	2,715	2,989	\$455	\$1,225	\$1,679	799	\$134	1,103	\$185	3,514	4,092	588	\$1,677	\$2,265	7.41	7.41	\$120	\$888.78	\$3,153.71
13	2028	0.1683	0.4124	2,715	2,989	\$457	\$1,233	\$1,689	799	\$134	1,103	\$186	3,514	4,092	591	\$1,688	\$2,279	7.41	7.41	\$130	\$962.85	\$3,241.64
14	2029	0.1692	0.4151	2,715	2,989	\$459	\$1,241	\$1,700	799	\$135	1,103	\$187	3,514	4,092	594	\$1,698	\$2,293	7.41	7.41	\$140	\$1,036.91	\$3,329.83
15	2030	0.1701	0.4170	2,715	2,989	\$462	\$1,246	\$1,708	799	\$136	1,103	\$188	3,514	4,092	598	\$1,706	\$2,304	7.41	7.41	\$150	\$1,110.98	\$3,415.01
16	2031	0.1704	0.4189	2,715	2,989	\$463	\$1,252	\$1,715	799	\$136	1,103	\$188	3,514	4,092	599	\$1,714	\$2,313	7.41	7.41	\$160	\$1,185.04	\$3,497.79
17	2032	0.1705	0.4204	2,715	2,989	\$463	\$1,257	\$1,720	799	\$136	1,103	\$188	3,514	4,092	599	\$1,720	\$2,320	7.41	7.41	\$170	\$1,259.11	\$3,578.62
18	2033	0.1707	0.4223	2,715	2,989	\$464	\$1,262	\$1,726	799	\$136	1,103	\$188	3,514	4,092	600	\$1,728	\$2,328	7.41	7.41	\$180	\$1,333.17	\$3,661.40
19	2034	0.1710	0.4246	2,715	2,989	\$464	\$1,269	\$1,734	799	\$137	1,103	\$189	3,514	4,092	601	\$1,738	\$2,339	7.41	7.41	\$190	\$1,407.24	\$3,745.87
20	2035	0.1713	0.4265	2,715	2,989	\$465	\$1,275	\$1,740	799	\$137	1,103	\$189	3,514	4,092	602	\$1,745	\$2,347	7.41	7.41	\$200	\$1,481.30	\$3,828.65
21	2036	0.1714	0.4288	2,715	2,989	\$465	\$1,282	\$1,747	799	\$137	1,103	\$189	3,514	4,092	602	\$1,755	\$2,357	7.41	7.41	\$210	\$1,555.37	\$3,912.61
22	2037	0.1717	0.4311	2,715	2,989	\$466	\$1,289	\$1,755	799	\$137	1,103	\$189	3,514	4,092	603	\$1,764	\$2,368	7.41	7.41	\$220	\$1,629.43	\$3,996.95
23	2038	0.1720	0.4331	2,715	2,989	\$467	\$1,294	\$1,761	799	\$137	1,103	\$190	3,514	4,092	604	\$1,772	\$2,376	7.41	7.41	\$230	\$1,703.50	\$4,079.86
24	2039	0.1722	0.4353	2,715	2,989	\$468	\$1,301	\$1,769	799	\$138	1,103	\$190	3,514	4,092	605	\$1,781	\$2,387	7.41	7.41	\$240	\$1,777.56	\$4,164.20
25	2040	0.1724	0.4376	2,715	2,989	\$468	\$1,308	\$1,776	799	\$138	1,103	\$190	3,514	4,092	606	\$1,791	\$2,397	7.41	7.41	\$250	\$1,851.63	\$4,248.16
26	2041	0.1734	0.4420	2,715	2,989	\$471	\$1,321	\$1,792	799	\$139	1,103	\$191	3,514	4,092	609	\$1,808	\$2,418	7.41	7.41	\$260	\$1,925.70	\$4,343.39
27	2042	0.1744	0.4463	2,715	2,989	\$473	\$1,334	\$1,807	799	\$139	1,103	\$192	3,514	4,092	613	\$1,826	\$2,439	7.41	7.41	\$270	\$1,999.76	\$4,438.81
28	2043	0.1754	0.4507	2,715	2,989	\$476	\$1,347	\$1,823	799	\$140	1,103	\$193	3,514	4,092	616	\$1,844	\$2,461	7.41	7.41	\$280	\$2,073.83	\$4,534.42
29	2044	0.1764	0.4552	2,715	2,989	\$479	\$1,360	\$1,839	799	\$141	1,103	\$195	3,514	4,092	620	\$1,863	\$2,482	7.41	7.41	\$290	\$2,147.89	\$4,630.24
30	2045	0.1774	0.4596	2,715	2,989	\$482	\$1,374	\$1,856	799	\$142	1,103	\$196	3,514	4,092	623	\$1,881	\$2,504	7.41	7.41	\$300	\$2,221.96	\$4,726.25
31	2046	0.1784	0.4642	2,715	2,989	\$484	\$1,387	\$1,872	799	\$143	1,103	\$197	3,514	4,092	627	\$1,899	\$2,526	7.41	7.41	\$310	\$2,296.02	\$4,822.46
32	2047	0.1795	0.4688	2,715	2,989	\$487	\$1,401	\$1,888	799	\$143	1,103	\$198	3,514	4,092	631	\$1,918	\$2,549	7.41	7.41	\$320	\$2,370.09	\$4,918.88
33	2048	0.1805	0.4734	2,715	2,989	\$490	\$1,415	\$1,905	799	\$144	1,103	\$199	3,514	4,092	634	\$1,937	\$2,571	7.41	7.41	\$330	\$2,444.15	\$5,015.51
34	2049	0.1816	0.4780	2,715	2,989	\$493	\$1,429	\$1,922	799	\$145	1,103	\$200	3,514	4,092	638	\$1,956	\$2,594	7.41	7.41	\$340	\$2,518.22	\$5,112.34
35	2050	0.1826	0.4828	2,715	2,989	\$496	\$1,443	\$1,939	799	\$146	1,103	\$201	3,514	4,092	642	\$1,975	\$2,617	7.41	7.41	\$350	\$2,592.28	\$5,209.38
36	2051	0.1837	0.4875	2,715	2,989	\$499	\$1,457	\$1,956	799	\$147	1,103	\$203	3,514	4,092	645	\$1,995	\$2,640	7.41	7.41	\$360	\$2,666.35	\$5,306.63
37	2052	0.1847	0.4923	2,715	2,989	\$502	\$1,472	\$1,973	799	\$148	1,103	\$204	3,514	4,092	649	\$2,015	\$2,664	7.41	7.41	\$370	\$2,740.41	\$5,404.10
38	2053	0.1858	0.4972	2,715	2,989	\$504	\$1,486	\$1,990	799	\$148	1,103	\$205	3,514	4,092	653	\$2,034	\$2,687	7.41	7.41	\$380	\$2,814.48	\$5,501.78
39	2054	0.1869	0.5021	2,715	2,989	\$507	\$1,501	\$2,008	799	\$149	1,103	\$206	3,514	4,092	657	\$2,055	\$2,711	7.41	7.41	\$390	\$2,888.54	\$5,599.68
40	2055	0.1879	0.5070	2,715	2,989	\$510	\$1,516	\$2,026	799	\$150	1,103	\$207	3,514	4,092	660	\$2,075	\$2,735	7.41	7.41	\$400	\$2,962.61	\$5,697.80
41	2056	0.1890	0.5120	2,715	2,989	\$513	\$1,530	\$2,044	799	\$151	1,103	\$209	3,514	4,092	664	\$2,095	\$2,759	7.41	7.41	\$410	\$3,036.67	\$5,796.14
42	2057	0.1901	0.5171	2,715	2,989	\$516	\$1,546	\$2,062	799	\$152	1,103	\$210	3,514	4,092	668	\$2,116	\$2,784	7.41	7.41	\$420	\$3,110.74	\$5,894.71
43	2058	0.1912	0.5222	2,715	2,989	\$519	\$1,561	\$2,080	799	\$153	1,103	\$211	3,514	4,092	672	\$2,137	\$2,809	7.41	7.41	\$430	\$3,184.80	\$5,993.50
44	2059	0.1923	0.5273	2,715	2,989	\$522	\$1,576	\$2,098	799	\$154	1,103	\$212	3,514	4,092	676	\$2,158	\$2,834	7.41	7.41	\$440	\$3,258.87	\$6,092.52
45	2060	0.1934	0.5325	2,715	2,989	\$525	\$1,592	\$2,117	799	\$155	1,103	\$213	3,514	4,092	680	\$2,179	\$2,859	7.41	7.41	\$450	\$3,332.93	\$6,191.76
46	2061	0.1946	0.5378	2,715	2,989	\$528	\$1,607	\$2,136	799	\$155	1,103	\$215	3,514	4,092	684	\$2,201	\$2,884	7.41	7.41	\$460	\$3,407.00	\$6,291.24
47	2062	0.1957	0.5431	2,715	2,989	\$531	\$1,623	\$2,155	799	\$156	1,103	\$216	3,514	4,092	688	\$2,222	\$2,910	7.41	7.41	\$470	\$3,481.06	\$6,390.96
48	2063	0.1968	0.5484	2,715	2,989	\$534	\$1,639	\$2,174	799	\$157	1,103	\$217	3,514	4,092	692	\$2,244	\$2,936	7.41	7.41	\$480	\$3,555.13	\$6,490.91
49	2064	0.1980	0.5538	2,715	2,989	\$537	\$1,655	\$2,193	799	\$158	1,103	\$218	3,514	4,092	696	\$2,266	\$2,962	7.41	7.41	\$490	\$3,629.19	\$6,591.10
50	2065	0.1991	0.5593	2,715	2,989	\$541	\$1,672	\$2,212	799	\$159	1,103	\$220	3,514	4,092	700	\$2,289	\$2,988	7.41	7.41	\$500	\$3,703.26	\$6,691.54
51	2066	0.2003	0.5648	2,715	2,989	\$544	\$1,688	\$2,232	799	\$160	1,103	\$221	3,514	4,092	704	\$2,311	\$3,015	7.41	7.41	\$510	\$3,777.33	\$6,792.21
52	2067	0.2014	0.5704	2,715	2,989	\$547	\$1,705	\$2,252	799	\$161	1,103	\$222	3,514	4,092	708	\$2,334	\$3,042	7.41	7.41	\$520	\$3,851.39	\$6,893.13
53	2068	0.2026	0.5760	2,715	2,989	\$550	\$1,722	\$2,272	799	\$162	1,103	\$223	3,514	4,092	712	\$2,357	\$3,069	7.41	7.41	\$530	\$3,925.46	\$6,994.30

22. Kenora (North) – Annual Operating Costs

Vertical Ground Source Heat Pump (V.GSHP)

Base Case Scenario											Feed in Tariff (FIT)		
#	Year	Electricity Rates		V.GSHP		Hot Water		Total	Total Operating Cost	FIT			
		\$/KWh	KWh	Heating Operating Cost	Cooling	Cooling Operating Cost	Hot Water Operating Cost			Incentives (\$/KWh)	S/KWh	Operating Cost	
				\$	KWh	\$	KWh	\$	KWh	\$			
1	2016	0.1501	6,084	\$913	163	\$24	4,779	\$717	11,026	\$1,655	0.05	0.1001	\$1,103.51
2	2017	0.1542	6,084	\$938	163	\$25	4,779	\$737	11,026	\$1,700	0.05	0.1042	\$1,148.76
3	2018	0.1583	6,084	\$963	163	\$26	4,779	\$756	11,026	\$1,745	0.05	0.1083	\$1,194.01
4	2019	0.1625	6,084	\$989	163	\$26	4,779	\$777	11,026	\$1,792	0.05	0.1125	\$1,240.85
5	2020	0.1668	6,084	\$1,015	163	\$27	4,779	\$797	11,026	\$1,839	0.05	0.1168	\$1,287.69
6	2021	0.1621	6,084	\$986	163	\$26	4,779	\$775	11,026	\$1,788	0.05	0.1121	\$1,236.49
7	2022	0.1629	6,084	\$991	163	\$27	4,779	\$779	11,026	\$1,797	0.05	0.1129	\$1,245.72
8	2023	0.1639	6,084	\$997	163	\$27	4,779	\$783	11,026	\$1,807	0.05	0.1139	\$1,255.54
9	2024	0.1648	6,084	\$1,003	163	\$27	4,779	\$788	11,026	\$1,817	0.05	0.1148	\$1,265.86
10	2025	0.1656	6,084	\$1,008	163	\$27	4,779	\$791	11,026	\$1,826	0.05	0.1156	\$1,274.59
11	2026	0.1665	6,084	\$1,013	163	\$27	4,779	\$796	11,026	\$1,836	0.05	0.1165	\$1,284.91
12	2027	0.1674	6,084	\$1,019	163	\$27	4,779	\$800	11,026	\$1,846	0.05	0.1174	\$1,294.83
13	2028	0.1683	6,084	\$1,024	163	\$27	4,779	\$804	11,026	\$1,855	0.05	0.1183	\$1,303.96
14	2029	0.1692	6,084	\$1,029	163	\$28	4,779	\$808	11,026	\$1,865	0.05	0.1192	\$1,313.89
15	2030	0.1701	6,084	\$1,035	163	\$28	4,779	\$813	11,026	\$1,876	0.05	0.1201	\$1,324.21
16	2031	0.1704	6,084	\$1,036	163	\$28	4,779	\$814	11,026	\$1,878	0.05	0.1204	\$1,326.99
17	2032	0.1705	6,084	\$1,037	163	\$28	4,779	\$815	11,026	\$1,880	0.05	0.1205	\$1,328.57
18	2033	0.1707	6,084	\$1,039	163	\$28	4,779	\$816	11,026	\$1,883	0.05	0.1207	\$1,331.35
19	2034	0.1710	6,084	\$1,041	163	\$28	4,779	\$817	11,026	\$1,886	0.05	0.1210	\$1,334.53
20	2035	0.1713	6,084	\$1,042	163	\$28	4,779	\$819	11,026	\$1,889	0.05	0.1213	\$1,337.31
21	2036	0.1714	6,084	\$1,043	163	\$28	4,779	\$819	11,026	\$1,890	0.05	0.1214	\$1,338.89
22	2037	0.1717	6,084	\$1,045	163	\$28	4,779	\$820	11,026	\$1,893	0.05	0.1217	\$1,341.67
23	2038	0.1720	6,084	\$1,046	163	\$28	4,779	\$822	11,026	\$1,896	0.05	0.1220	\$1,344.85
24	2039	0.1722	6,084	\$1,048	163	\$28	4,779	\$823	11,026	\$1,899	0.05	0.1222	\$1,347.63
25	2040	0.1724	6,084	\$1,049	163	\$28	4,779	\$824	11,026	\$1,901	0.05	0.1224	\$1,349.21
26	2041	0.1734	6,084	\$1,055	163	\$28	4,779	\$829	11,026	\$1,912	0.05	0.1234	\$1,360.21
27	2042	0.1744	6,084	\$1,061	163	\$28	4,779	\$833	11,026	\$1,923	0.05	0.1244	\$1,371.27
28	2043	0.1754	6,084	\$1,067	163	\$29	4,779	\$838	11,026	\$1,934	0.05	0.1254	\$1,382.39
29	2044	0.1764	6,084	\$1,073	163	\$29	4,779	\$843	11,026	\$1,945	0.05	0.1264	\$1,393.57
30	2045	0.1774	6,084	\$1,079	163	\$29	4,779	\$848	11,026	\$1,956	0.05	0.1274	\$1,404.83
31	2046	0.1784	6,084	\$1,086	163	\$29	4,779	\$853	11,026	\$1,967	0.05	0.1284	\$1,416.14
32	2047	0.1795	6,084	\$1,092	163	\$29	4,779	\$858	11,026	\$1,979	0.05	0.1295	\$1,427.52
33	2048	0.1805	6,084	\$1,098	163	\$29	4,779	\$863	11,026	\$1,990	0.05	0.1305	\$1,438.97
34	2049	0.1816	6,084	\$1,105	163	\$30	4,779	\$868	11,026	\$2,002	0.05	0.1316	\$1,450.48
35	2050	0.1826	6,084	\$1,111	163	\$30	4,779	\$873	11,026	\$2,013	0.05	0.1326	\$1,462.06
36	2051	0.1837	6,084	\$1,117	163	\$30	4,779	\$878	11,026	\$2,025	0.05	0.1337	\$1,473.71
37	2052	0.1847	6,084	\$1,124	163	\$30	4,779	\$883	11,026	\$2,037	0.05	0.1347	\$1,485.42
38	2053	0.1858	6,084	\$1,130	163	\$30	4,779	\$888	11,026	\$2,049	0.05	0.1358	\$1,497.21
39	2054	0.1869	6,084	\$1,137	163	\$30	4,779	\$893	11,026	\$2,060	0.05	0.1369	\$1,509.06
40	2055	0.1879	6,084	\$1,143	163	\$31	4,779	\$898	11,026	\$2,072	0.05	0.1379	\$1,520.98
41	2056	0.1890	6,084	\$1,150	163	\$31	4,779	\$903	11,026	\$2,084	0.05	0.1390	\$1,532.96
42	2057	0.1901	6,084	\$1,157	163	\$31	4,779	\$909	11,026	\$2,096	0.05	0.1401	\$1,545.02
43	2058	0.1912	6,084	\$1,163	163	\$31	4,779	\$914	11,026	\$2,108	0.05	0.1412	\$1,557.15
44	2059	0.1923	6,084	\$1,170	163	\$31	4,779	\$919	11,026	\$2,121	0.05	0.1423	\$1,569.34
45	2060	0.1934	6,084	\$1,177	163	\$32	4,779	\$924	11,026	\$2,133	0.05	0.1434	\$1,581.61
46	2061	0.1946	6,084	\$1,184	163	\$32	4,779	\$930	11,026	\$2,145	0.05	0.1446	\$1,593.95
47	2062	0.1957	6,084	\$1,191	163	\$32	4,779	\$935	11,026	\$2,158	0.05	0.1457	\$1,606.36
48	2063	0.1968	6,084	\$1,197	163	\$32	4,779	\$941	11,026	\$2,170	0.05	0.1468	\$1,618.84
49	2064	0.1980	6,084	\$1,204	163	\$32	4,779	\$946	11,026	\$2,183	0.05	0.1480	\$1,631.40
50	2065	0.1991	6,084	\$1,211	163	\$32	4,779	\$952	11,026	\$2,195	0.05	0.1491	\$1,644.02
51	2066	0.2003	6,084	\$1,218	163	\$33	4,779	\$957	11,026	\$2,208	0.05	0.1503	\$1,656.72
52	2067	0.2014	6,084	\$1,225	163	\$33	4,779	\$963	11,026	\$2,221	0.05	0.1514	\$1,669.50
53	2068	0.2026	6,084	\$1,232	163	\$33	4,779	\$968	11,026	\$2,234	0.05	0.1526	\$1,682.34
54	2069	0.2038	6,084	\$1,240	163	\$33	4,779	\$974	11,026	\$2,247	0.05	0.1538	\$1,695.26
55	2070	0.2049	6,084	\$1,247	163	\$33	4,779	\$979	11,026	\$2,260	0.05	0.1549	\$1,708.26
56	2071	0.2061	6,084	\$1,254	163	\$34	4,779	\$985	11,026	\$2,273	0.05	0.1561	\$1,721.33
57	2072	0.2073	6,084	\$1,261	163	\$34	4,779	\$991	11,026	\$2,286	0.05	0.1573	\$1,734.48
58	2073	0.2085	6,084	\$1,269	163	\$34	4,779	\$996	11,026	\$2,299	0.05	0.1585	\$1,747.70
59	2074	0.2097	6,084	\$1,276	163	\$34	4,779	\$1,002	11,026	\$2,312	0.05	0.1597	\$1,761.00
60	2075	0.2109	6,084	\$1,283	163	\$34	4,779	\$1,008	11,026	\$2,326	0.05	0.1609	\$1,774.38

Table D2-1.64: Annual Operating Costs (V.GSHP) of a 2,000 square feet detached house above grade (improved construction type) in the city of Kenora (two life cycles and three life cycles for a 60 year project lifespan); base case scenario in comparison with feed-in-tariff (FIT) scenario. In the FIT scenario, an incentive of \$0.05/KWh is provided on electricity bills throughout the project lifespan

Horizontal Ground Source Heat Pump (H.GSHP)

Base Case Scenario											Feed in Tariff (FIT)		
H.GSHP											FIT		
#	Year	Electricity Rates \$/KWh	Heating KWh	Heating Operating Cost \$	Cooling KWh	Cooling Operating Cost \$	Hot Water KWh	Hot Water Operating Cost \$	Total KWh	Total Operating Cost \$	Incentives (\$/KWh)	S/KWh	Operating Cost
1	2016	0.1501	6,163	\$925	166	\$25	4,765	\$715	11,094	\$1,665	0.05	0.1001	\$1,110.32
2	2017	0.1542	6,163	\$950	166	\$26	4,765	\$735	11,094	\$1,711	0.05	0.1042	\$1,155.85
3	2018	0.1583	6,163	\$976	166	\$26	4,765	\$754	11,094	\$1,756	0.05	0.1083	\$1,201.38
4	2019	0.1625	6,163	\$1,002	166	\$27	4,765	\$774	11,094	\$1,803	0.05	0.1125	\$1,248.50
5	2020	0.1668	6,163	\$1,028	166	\$28	4,765	\$795	11,094	\$1,850	0.05	0.1168	\$1,295.63
6	2021	0.1621	6,163	\$999	166	\$27	4,765	\$773	11,094	\$1,799	0.05	0.1121	\$1,244.11
7	2022	0.1629	6,163	\$1,004	166	\$27	4,765	\$776	11,094	\$1,808	0.05	0.1129	\$1,252.90
8	2023	0.1639	6,163	\$1,010	166	\$27	4,765	\$781	11,094	\$1,818	0.05	0.1139	\$1,263.28
9	2024	0.1648	6,163	\$1,016	166	\$27	4,765	\$785	11,094	\$1,828	0.05	0.1148	\$1,273.67
10	2025	0.1656	6,163	\$1,021	166	\$27	4,765	\$789	11,094	\$1,837	0.05	0.1156	\$1,282.45
11	2026	0.1665	6,163	\$1,026	166	\$28	4,765	\$794	11,094	\$1,848	0.05	0.1165	\$1,292.84
12	2027	0.1674	6,163	\$1,032	166	\$28	4,765	\$798	11,094	\$1,858	0.05	0.1174	\$1,302.82
13	2028	0.1683	6,163	\$1,037	166	\$28	4,765	\$802	11,094	\$1,867	0.05	0.1183	\$1,312.01
14	2029	0.1692	6,163	\$1,043	166	\$28	4,765	\$806	11,094	\$1,877	0.05	0.1192	\$1,321.99
15	2030	0.1701	6,163	\$1,048	166	\$28	4,765	\$811	11,094	\$1,887	0.05	0.1201	\$1,332.37
16	2031	0.1704	6,163	\$1,050	166	\$28	4,765	\$812	11,094	\$1,890	0.05	0.1204	\$1,335.17
17	2032	0.1705	6,163	\$1,051	166	\$28	4,765	\$812	11,094	\$1,891	0.05	0.1205	\$1,336.77
18	2033	0.1707	6,163	\$1,052	166	\$28	4,765	\$814	11,094	\$1,894	0.05	0.1207	\$1,339.56
19	2034	0.1710	6,163	\$1,054	166	\$28	4,765	\$815	11,094	\$1,897	0.05	0.1210	\$1,342.76
20	2035	0.1713	6,163	\$1,056	166	\$28	4,765	\$816	11,094	\$1,900	0.05	0.1213	\$1,345.55
21	2036	0.1714	6,163	\$1,057	166	\$28	4,765	\$817	11,094	\$1,902	0.05	0.1214	\$1,347.15
22	2037	0.1717	6,163	\$1,058	166	\$28	4,765	\$818	11,094	\$1,905	0.05	0.1217	\$1,349.95
23	2038	0.1720	6,163	\$1,060	166	\$29	4,765	\$819	11,094	\$1,908	0.05	0.1220	\$1,353.14
24	2039	0.1722	6,163	\$1,061	166	\$29	4,765	\$821	11,094	\$1,911	0.05	0.1222	\$1,355.94
25	2040	0.1724	6,163	\$1,062	166	\$29	4,765	\$821	11,094	\$1,912	0.05	0.1224	\$1,357.54
26	2041	0.1734	6,163	\$1,068	166	\$29	4,765	\$826	11,094	\$1,923	0.05	0.1234	\$1,368.60
27	2042	0.1744	6,163	\$1,075	166	\$29	4,765	\$831	11,094	\$1,934	0.05	0.1244	\$1,379.72
28	2043	0.1754	6,163	\$1,081	166	\$29	4,765	\$836	11,094	\$1,946	0.05	0.1254	\$1,390.91
29	2044	0.1764	6,163	\$1,087	166	\$29	4,765	\$840	11,094	\$1,957	0.05	0.1264	\$1,402.17
30	2045	0.1774	6,163	\$1,093	166	\$29	4,765	\$845	11,094	\$1,968	0.05	0.1274	\$1,413.49
31	2046	0.1784	6,163	\$1,100	166	\$30	4,765	\$850	11,094	\$1,980	0.05	0.1284	\$1,424.87
32	2047	0.1795	6,163	\$1,106	166	\$30	4,765	\$855	11,094	\$1,991	0.05	0.1295	\$1,436.33
33	2048	0.1805	6,163	\$1,112	166	\$30	4,765	\$860	11,094	\$2,003	0.05	0.1305	\$1,447.84
34	2049	0.1816	6,163	\$1,119	166	\$30	4,765	\$865	11,094	\$2,014	0.05	0.1316	\$1,459.43
35	2050	0.1826	6,163	\$1,125	166	\$30	4,765	\$870	11,094	\$2,026	0.05	0.1326	\$1,471.08
36	2051	0.1837	6,163	\$1,132	166	\$30	4,765	\$875	11,094	\$2,037	0.05	0.1337	\$1,482.80
37	2052	0.1847	6,163	\$1,138	166	\$31	4,765	\$880	11,094	\$2,049	0.05	0.1347	\$1,494.59
38	2053	0.1858	6,163	\$1,145	166	\$31	4,765	\$885	11,094	\$2,061	0.05	0.1358	\$1,506.44
39	2054	0.1869	6,163	\$1,152	166	\$31	4,765	\$890	11,094	\$2,073	0.05	0.1369	\$1,518.36
40	2055	0.1879	6,163	\$1,158	166	\$31	4,765	\$896	11,094	\$2,085	0.05	0.1379	\$1,530.36
41	2056	0.1890	6,163	\$1,165	166	\$31	4,765	\$901	11,094	\$2,097	0.05	0.1390	\$1,542.42
42	2057	0.1901	6,163	\$1,172	166	\$32	4,765	\$906	11,094	\$2,109	0.05	0.1401	\$1,554.55
43	2058	0.1912	6,163	\$1,179	166	\$32	4,765	\$911	11,094	\$2,121	0.05	0.1412	\$1,566.75
44	2059	0.1923	6,163	\$1,185	166	\$32	4,765	\$916	11,094	\$2,134	0.05	0.1423	\$1,579.02
45	2060	0.1934	6,163	\$1,192	166	\$32	4,765	\$922	11,094	\$2,146	0.05	0.1434	\$1,591.37
46	2061	0.1946	6,163	\$1,199	166	\$32	4,765	\$927	11,094	\$2,158	0.05	0.1446	\$1,603.78
47	2062	0.1957	6,163	\$1,206	166	\$32	4,765	\$932	11,094	\$2,171	0.05	0.1457	\$1,616.27
48	2063	0.1968	6,163	\$1,213	166	\$33	4,765	\$938	11,094	\$2,184	0.05	0.1468	\$1,628.83
49	2064	0.1980	6,163	\$1,220	166	\$33	4,765	\$943	11,094	\$2,196	0.05	0.1480	\$1,641.46
50	2065	0.1991	6,163	\$1,227	166	\$33	4,765	\$949	11,094	\$2,209	0.05	0.1491	\$1,654.16
51	2066	0.2003	6,163	\$1,234	166	\$33	4,765	\$954	11,094	\$2,222	0.05	0.1503	\$1,666.94
52	2067	0.2014	6,163	\$1,241	166	\$33	4,765	\$960	11,094	\$2,234	0.05	0.1514	\$1,679.79
53	2068	0.2026	6,163	\$1,248	166	\$34	4,765	\$965	11,094	\$2,247	0.05	0.1526	\$1,692.72
54	2069	0.2038	6,163	\$1,256	166	\$34	4,765	\$971	11,094	\$2,260	0.05	0.1538	\$1,705.72
55	2070	0.2049	6,163	\$1,263	166	\$34	4,765	\$976	11,094	\$2,273	0.05	0.1549	\$1,718.80
56	2071	0.2061	6,163	\$1,270	166	\$34	4,765	\$982	11,094	\$2,287	0.05	0.1561	\$1,731.95
57	2072	0.2073	6,163	\$1,278	166	\$34	4,765	\$988	11,094	\$2,300	0.05	0.1573	\$1,745.18
58	2073	0.2085	6,163	\$1,285	166	\$35	4,765	\$994	11,094	\$2,313	0.05	0.1585	\$1,758.48
59	2074	0.2097	6,163	\$1,292	166	\$35	4,765	\$999	11,094	\$2,327	0.05	0.1597	\$1,771.86
60	2075	0.2109	6,163	\$1,300	166	\$35	4,765	\$1,005	11,094	\$2,340	0.05	0.1609	\$1,785.32

Table D2-1.65: Annual Operating Costs (H.GSHP) of a 2,000 square feet detached house above grade (improved construction type) in the city of Kenora (two life cycles and three life cycles for a 60 year project lifespan); base case scenario in comparison with feed in-tariff (FIT) scenario. In the FIT scenario, an incentive of \$0.05/KWh is provided on electricity bills throughout the project lifespan

Traditional HVAC Applications

Base Case Scenario															Carbon Taxes							
#	Year	Traditional													Total	Conversion of m ³ into Tons	Total Tons	Carbon Tax	Operating Costs			
		Electricity Rates	Natural Gas Rates	Heating		Heating Operating Cost	Heating Operating Cost	Total Heating Operating Cost	Cooling	Cooling Operating Cost	Hot Water	Hot Water Operating Cost	Total	Total						Total Electricity Operating Cost	Total Natural Gas Operating Cost	
				KWh (Electricity)	m ³ (Gas)																	\$ (Electricity)
1	2016	0.1501	0.3458	2,191	2,735	\$329	\$946	\$1,275	848	\$127	1,105	\$382	3,039	3,840	456	\$1,328	\$1,784	6.95	6.95	\$10	\$69.50	\$1,853.59
2	2017	0.1542	0.3588	2,191	2,735	\$338	\$981	\$1,319	848	\$131	1,105	\$170	3,039	3,840	469	\$1,378	\$1,847	6.95	6.95	\$20	\$139.01	\$1,985.52
3	2018	0.1583	0.3718	2,191	2,735	\$347	\$1,017	\$1,364	848	\$134	1,105	\$175	3,039	3,840	481	\$1,428	\$1,909	6.95	6.95	\$30	\$208.51	\$2,117.44
4	2019	0.1625	0.3776	2,191	2,735	\$356	\$1,033	\$1,389	848	\$138	1,105	\$180	3,039	3,840	494	\$1,450	\$1,944	6.95	6.95	\$40	\$278.02	\$2,221.89
5	2020	0.1668	0.3841	2,191	2,735	\$365	\$1,050	\$1,416	848	\$141	1,105	\$184	3,039	3,840	507	\$1,475	\$1,982	6.95	6.95	\$50	\$347.52	\$2,329.27
6	2021	0.1621	0.3883	2,191	2,735	\$355	\$1,062	\$1,417	848	\$137	1,105	\$179	3,039	3,840	493	\$1,491	\$1,984	6.95	6.95	\$60	\$417.02	\$2,400.82
7	2022	0.1629	0.3929	2,191	2,735	\$357	\$1,075	\$1,432	848	\$138	1,105	\$180	3,039	3,840	495	\$1,509	\$2,004	6.95	6.95	\$70	\$486.53	\$2,490.36
8	2023	0.1639	0.3967	2,191	2,735	\$359	\$1,085	\$1,444	848	\$139	1,105	\$181	3,039	3,840	498	\$1,523	\$2,021	6.95	6.95	\$80	\$556.03	\$2,577.40
9	2024	0.1648	0.4005	2,191	2,735	\$361	\$1,095	\$1,457	848	\$140	1,105	\$182	3,039	3,840	501	\$1,538	\$2,039	6.95	6.95	\$90	\$625.54	\$2,664.44
10	2025	0.1656	0.4040	2,191	2,735	\$363	\$1,105	\$1,468	848	\$140	1,105	\$183	3,039	3,840	503	\$1,551	\$2,055	6.95	6.95	\$100	\$695.04	\$2,749.57
11	2026	0.1665	0.4070	2,191	2,735	\$365	\$1,113	\$1,478	848	\$141	1,105	\$184	3,039	3,840	506	\$1,563	\$2,069	6.95	6.95	\$110	\$764.54	\$2,833.67
12	2027	0.1674	0.4097	2,191	2,735	\$367	\$1,121	\$1,487	848	\$142	1,105	\$185	3,039	3,840	509	\$1,573	\$2,082	6.95	6.95	\$120	\$834.05	\$2,916.19
13	2028	0.1683	0.4124	2,191	2,735	\$369	\$1,128	\$1,497	848	\$143	1,105	\$186	3,039	3,840	511	\$1,584	\$2,095	6.95	6.95	\$130	\$903.55	\$2,998.50
14	2029	0.1692	0.4151	2,191	2,735	\$371	\$1,135	\$1,506	848	\$143	1,105	\$187	3,039	3,840	514	\$1,594	\$2,108	6.95	6.95	\$140	\$973.06	\$3,081.02
15	2030	0.1701	0.4170	2,191	2,735	\$373	\$1,140	\$1,513	848	\$144	1,105	\$188	3,039	3,840	517	\$1,601	\$2,118	6.95	6.95	\$150	\$1,042.56	\$3,160.71
16	2031	0.1704	0.4189	2,191	2,735	\$373	\$1,146	\$1,519	848	\$144	1,105	\$188	3,039	3,840	518	\$1,609	\$2,126	6.95	6.95	\$160	\$1,112.06	\$3,238.33
17	2032	0.1705	0.4204	2,191	2,735	\$374	\$1,150	\$1,523	848	\$145	1,105	\$188	3,039	3,840	518	\$1,614	\$2,133	6.95	6.95	\$170	\$1,181.57	\$3,314.15
18	2033	0.1707	0.4223	2,191	2,735	\$374	\$1,155	\$1,529	848	\$145	1,105	\$189	3,039	3,840	519	\$1,622	\$2,141	6.95	6.95	\$180	\$1,251.07	\$3,391.76
19	2034	0.1710	0.4246	2,191	2,735	\$375	\$1,161	\$1,536	848	\$145	1,105	\$189	3,039	3,840	520	\$1,631	\$2,150	6.95	6.95	\$190	\$1,320.58	\$3,470.95
20	2035	0.1713	0.4265	2,191	2,735	\$375	\$1,167	\$1,542	848	\$145	1,105	\$189	3,039	3,840	521	\$1,638	\$2,158	6.95	6.95	\$200	\$1,390.08	\$3,548.57
21	2036	0.1714	0.4288	2,191	2,735	\$376	\$1,173	\$1,548	848	\$145	1,105	\$189	3,039	3,840	521	\$1,647	\$2,168	6.95	6.95	\$210	\$1,459.58	\$3,627.33
22	2037	0.1717	0.4311	2,191	2,735	\$376	\$1,179	\$1,555	848	\$146	1,105	\$190	3,039	3,840	522	\$1,656	\$2,177	6.95	6.95	\$220	\$1,529.09	\$3,706.41
23	2038	0.1720	0.4331	2,191	2,735	\$377	\$1,184	\$1,561	848	\$146	1,105	\$190	3,039	3,840	523	\$1,663	\$2,186	6.95	6.95	\$230	\$1,598.59	\$3,784.13
24	2039	0.1722	0.4353	2,191	2,735	\$377	\$1,191	\$1,568	848	\$146	1,105	\$190	3,039	3,840	523	\$1,672	\$2,195	6.95	6.95	\$240	\$1,668.10	\$3,863.22
25	2040	0.1724	0.4376	2,191	2,735	\$378	\$1,197	\$1,575	848	\$146	1,105	\$190	3,039	3,840	524	\$1,681	\$2,204	6.95	6.95	\$250	\$1,737.60	\$3,941.97
26	2041	0.1734	0.4420	2,191	2,735	\$380	\$1,209	\$1,589	848	\$147	1,105	\$192	3,039	3,840	527	\$1,697	\$2,224	6.95	6.95	\$260	\$1,807.10	\$4,031.08
27	2042	0.1744	0.4463	2,191	2,735	\$382	\$1,221	\$1,603	848	\$148	1,105	\$193	3,039	3,840	530	\$1,714	\$2,244	6.95	6.95	\$270	\$1,876.61	\$4,120.36
28	2043	0.1754	0.4507	2,191	2,735	\$384	\$1,233	\$1,617	848	\$149	1,105	\$194	3,039	3,840	533	\$1,731	\$2,264	6.95	6.95	\$280	\$1,946.11	\$4,209.83
29	2044	0.1764	0.4552	2,191	2,735	\$386	\$1,245	\$1,631	848	\$150	1,105	\$195	3,039	3,840	536	\$1,748	\$2,284	6.95	6.95	\$290	\$2,015.62	\$4,299.48
30	2045	0.1774	0.4596	2,191	2,735	\$389	\$1,257	\$1,646	848	\$150	1,105	\$196	3,039	3,840	539	\$1,765	\$2,304	6.95	6.95	\$300	\$2,085.12	\$4,389.31
31	2046	0.1784	0.4642	2,191	2,735	\$391	\$1,270	\$1,660	848	\$151	1,105	\$197	3,039	3,840	542	\$1,782	\$2,324	6.95	6.95	\$310	\$2,154.62	\$4,479.34
32	2047	0.1795	0.4688	2,191	2,735	\$393	\$1,282	\$1,675	848	\$152	1,105	\$198	3,039	3,840	545	\$1,800	\$2,345	6.95	6.95	\$320	\$2,224.13	\$4,569.55
33	2048	0.1805	0.4734	2,191	2,735	\$395	\$1,295	\$1,690	848	\$153	1,105	\$199	3,039	3,840	549	\$1,818	\$2,366	6.95	6.95	\$330	\$2,293.63	\$4,659.96
34	2049	0.1816	0.4780	2,191	2,735	\$398	\$1,307	\$1,705	848	\$154	1,105	\$201	3,039	3,840	552	\$1,836	\$2,387	6.95	6.95	\$340	\$2,363.14	\$4,750.56
35	2050	0.1826	0.4828	2,191	2,735	\$400	\$1,320	\$1,720	848	\$155	1,105	\$202	3,039	3,840	555	\$1,854	\$2,409	6.95	6.95	\$350	\$2,432.64	\$4,841.35
36	2051	0.1837	0.4875	2,191	2,735	\$402	\$1,333	\$1,736	848	\$156	1,105	\$203	3,039	3,840	558	\$1,872	\$2,430	6.95	6.95	\$360	\$2,502.14	\$4,932.34
37	2052	0.1847	0.4923	2,191	2,735	\$405	\$1,347	\$1,751	848	\$157	1,105	\$204	3,039	3,840	561	\$1,891	\$2,452	6.95	6.95	\$370	\$2,571.65	\$5,023.53
38	2053	0.1858	0.4972	2,191	2,735	\$407	\$1,360	\$1,767	848	\$158	1,105	\$205	3,039	3,840	565	\$1,909	\$2,474	6.95	6.95	\$380	\$2,641.15	\$5,114.92
39	2054	0.1869	0.5021	2,191	2,735	\$409	\$1,373	\$1,783	848	\$158	1,105	\$206	3,039	3,840	568	\$1,928	\$2,496	6.95	6.95	\$390	\$2,710.66	\$5,206.51
40	2055	0.1879	0.5070	2,191	2,735	\$412	\$1,387	\$1,799	848	\$159	1,105	\$208	3,039	3,840	571	\$1,947	\$2,518	6.95	6.95	\$400	\$2,780.16	\$5,298.31
41	2056	0.1890	0.5120	2,191	2,735	\$414	\$1,400	\$1,815	848	\$160	1,105	\$209	3,039	3,840	574	\$1,966	\$2,541	6.95	6.95	\$410	\$2,849.66	\$5,390.31
42	2057	0.1901	0.5171	2,191	2,735	\$417	\$1,414	\$1,831	848	\$161	1,105	\$210	3,039	3,840	578	\$1,984	\$2,563	6.95	6.95	\$420	\$2,919.17	\$5,482.52
43	2058	0.1912	0.5222	2,191	2,735	\$419	\$1,428	\$1,847	848	\$162	1,105	\$211	3,039	3,840	581	\$1,998	\$2,586	6.95	6.95	\$430	\$2,988.67	\$5,574.95
44	2059	0.1923	0.5273	2,191	2,735	\$421	\$1,442	\$1,864	848	\$163	1,105	\$213	3,039	3,840	584	\$2,025	\$2,609	6.95	6.95	\$440	\$3,058.18	\$5,667.58
45	2060	0.1934	0.5325	2,191	2,735	\$424	\$1,456	\$1,880	848	\$164	1,105	\$214	3,039	3,840	588	\$2,045	\$2,633	6.95	6.95	\$450	\$3,127.68	\$5,760.43
46	2061	0.1946	0.5378	2,191	2,735	\$426	\$1,471	\$1,897	848	\$165	1,105	\$215	3,039	3,840	591	\$2,065	\$2,656	6.95	6.95	\$460	\$3,197.18	\$5,853.49
47	2062	0.1957	0.5431	2,191	2,735	\$429	\$1,485	\$1,914	848	\$166	1,105	\$216	3,039	3,840	595	\$2,085	\$2,680	6.95	6.95	\$470	\$3,266.69	\$5,946.78
48	2063	0.1968	0.5484	2,191	2,735	\$431	\$1,500	\$1,931	848	\$167	1,105	\$217	3,039	3,840	598	\$2,106	\$2,704	6.95	6.95	\$480	\$3,336.19	\$6,040.28
49	2064	0.1980	0.5538	2,191	2,735	\$434	\$1,515	\$1,948	848	\$168	1,105	\$219	3,039	3,840	602	\$2,127	\$2,728	6.95	6.95	\$490	\$3,405.70	\$6,134.01
50	2065	0.1991	0.5593	2,191	2,735	\$436	\$1,530	\$1,966	848	\$169	1,105	\$220	3,039	3,840	605	\$2,148	\$2,753	6.95	6.95	\$500	\$3,475.20	\$6,227.96
51	2066	0.2003	0.5648	2,191	2,735	\$439	\$1,545	\$1,984	848	\$170	1,105	\$221	3,039	3,840	609	\$2,169	\$2,777	6.95	6.95	\$510	\$3,544.70	\$6,322.14
52	2067	0.2014	0.5704	2,191	2,735	\$441	\$1,560	\$2,001	848	\$171	1,105	\$223	3,039	3,840	612	\$2,192	\$2,800	6.95	6.95	\$520	\$3,614.21	\$6,416.55
53	2068	0.2026	0.5760	2,191	2,735	\$444	\$1,575	\$2,019	848	\$172	1,105	\$224	3,039	3,840	616	\$2,212	\$2,827	6.95	6.95	\$530	\$3,683.71	

23. North Bay (North) – Annual Operating Costs

Vertical Ground Source Heat Pump (V.GSHP)

Base Case Scenario											Feed In Tariff (FIT)			
#	Year	Electricity Rates		Heating Operating Cost		Cooling Operating Cost		Hot Water Operating Cost		Total Operating Cost		Incentives (\$/KWh)	FIT	
		\$/KWh	KWh	\$	KWh	\$	KWh	\$	KWh	\$	Operating Cost		Operating Cost	
1	2016	0.1501	4,825	\$724	136	\$20	4,846	\$277	9,807	\$1,472	0.05	\$0.1001	\$981.51	
2	2017	0.1542	4,825	\$744	136	\$21	4,846	\$747	9,807	\$1,512	0.05	\$0.1042	\$1,021.76	
3	2018	0.1583	4,825	\$764	136	\$22	4,846	\$767	9,807	\$1,552	0.05	\$0.1083	\$1,062.01	
4	2019	0.1625	4,825	\$784	136	\$23	4,846	\$788	9,807	\$1,594	0.05	\$0.1125	\$1,103.67	
5	2020	0.1668	4,825	\$805	136	\$23	4,846	\$808	9,807	\$1,636	0.05	\$0.1168	\$1,145.33	
6	2021	0.1621	4,825	\$782	136	\$22	4,846	\$786	9,807	\$1,590	0.05	\$0.1121	\$1,099.78	
7	2022	0.1629	4,825	\$786	136	\$22	4,846	\$790	9,807	\$1,598	0.05	\$0.1129	\$1,107.55	
8	2023	0.1639	4,825	\$791	136	\$22	4,846	\$794	9,807	\$1,607	0.05	\$0.1139	\$1,116.73	
9	2024	0.1648	4,825	\$795	136	\$22	4,846	\$799	9,807	\$1,616	0.05	\$0.1148	\$1,125.91	
10	2025	0.1656	4,825	\$799	136	\$23	4,846	\$802	9,807	\$1,624	0.05	\$0.1156	\$1,133.68	
11	2026	0.1665	4,825	\$804	136	\$23	4,846	\$807	9,807	\$1,633	0.05	\$0.1165	\$1,142.86	
12	2027	0.1674	4,825	\$808	136	\$23	4,846	\$811	9,807	\$1,642	0.05	\$0.1174	\$1,151.68	
13	2028	0.1683	4,825	\$812	136	\$23	4,846	\$815	9,807	\$1,650	0.05	\$0.1183	\$1,159.80	
14	2029	0.1692	4,825	\$816	136	\$23	4,846	\$820	9,807	\$1,659	0.05	\$0.1192	\$1,168.63	
15	2030	0.1701	4,825	\$821	136	\$23	4,846	\$824	9,807	\$1,668	0.05	\$0.1201	\$1,177.81	
16	2031	0.1704	4,825	\$822	136	\$23	4,846	\$826	9,807	\$1,671	0.05	\$0.1204	\$1,180.28	
17	2032	0.1705	4,825	\$823	136	\$23	4,846	\$826	9,807	\$1,672	0.05	\$0.1205	\$1,181.69	
18	2033	0.1707	4,825	\$824	136	\$23	4,846	\$827	9,807	\$1,675	0.05	\$0.1207	\$1,184.16	
19	2034	0.1710	4,825	\$825	136	\$23	4,846	\$829	9,807	\$1,677	0.05	\$0.1210	\$1,186.99	
20	2035	0.1713	4,825	\$826	136	\$23	4,846	\$830	9,807	\$1,680	0.05	\$0.1213	\$1,189.46	
21	2036	0.1714	4,825	\$827	136	\$23	4,846	\$831	9,807	\$1,681	0.05	\$0.1214	\$1,190.87	
22	2037	0.1717	4,825	\$828	136	\$23	4,846	\$832	9,807	\$1,684	0.05	\$0.1217	\$1,193.34	
23	2038	0.1720	4,825	\$830	136	\$23	4,846	\$833	9,807	\$1,687	0.05	\$0.1220	\$1,196.17	
24	2039	0.1722	4,825	\$831	136	\$23	4,846	\$835	9,807	\$1,689	0.05	\$0.1222	\$1,198.64	
25	2040	0.1724	4,825	\$832	136	\$23	4,846	\$835	9,807	\$1,690	0.05	\$0.1224	\$1,200.05	
26	2041	0.1734	4,825	\$836	136	\$24	4,846	\$840	9,807	\$1,700	0.05	\$0.1234	\$1,209.83	
27	2042	0.1744	4,825	\$841	136	\$24	4,846	\$845	9,807	\$1,710	0.05	\$0.1244	\$1,219.66	
28	2043	0.1754	4,825	\$846	136	\$24	4,846	\$850	9,807	\$1,720	0.05	\$0.1254	\$1,229.56	
29	2044	0.1764	4,825	\$851	136	\$24	4,846	\$855	9,807	\$1,730	0.05	\$0.1264	\$1,239.51	
30	2045	0.1774	4,825	\$856	136	\$24	4,846	\$860	9,807	\$1,740	0.05	\$0.1274	\$1,249.51	
31	2046	0.1784	4,825	\$861	136	\$24	4,846	\$865	9,807	\$1,750	0.05	\$0.1284	\$1,259.58	
32	2047	0.1795	4,825	\$866	136	\$24	4,846	\$870	9,807	\$1,760	0.05	\$0.1295	\$1,269.70	
33	2048	0.1805	4,825	\$871	136	\$25	4,846	\$875	9,807	\$1,770	0.05	\$0.1305	\$1,279.88	
34	2049	0.1816	4,825	\$876	136	\$25	4,846	\$880	9,807	\$1,780	0.05	\$0.1316	\$1,290.12	
35	2050	0.1826	4,825	\$881	136	\$25	4,846	\$885	9,807	\$1,791	0.05	\$0.1326	\$1,300.42	
36	2051	0.1837	4,825	\$886	136	\$25	4,846	\$890	9,807	\$1,801	0.05	\$0.1337	\$1,310.78	
37	2052	0.1847	4,825	\$891	136	\$25	4,846	\$895	9,807	\$1,812	0.05	\$0.1347	\$1,321.20	
38	2053	0.1858	4,825	\$896	136	\$25	4,846	\$900	9,807	\$1,822	0.05	\$0.1358	\$1,331.68	
39	2054	0.1869	4,825	\$902	136	\$25	4,846	\$906	9,807	\$1,833	0.05	\$0.1369	\$1,342.22	
40	2055	0.1879	4,825	\$907	136	\$26	4,846	\$911	9,807	\$1,843	0.05	\$0.1379	\$1,352.82	
41	2056	0.1890	4,825	\$912	136	\$26	4,846	\$916	9,807	\$1,854	0.05	\$0.1390	\$1,363.48	
42	2057	0.1901	4,825	\$917	136	\$26	4,846	\$921	9,807	\$1,865	0.05	\$0.1401	\$1,374.21	
43	2058	0.1912	4,825	\$923	136	\$26	4,846	\$927	9,807	\$1,875	0.05	\$0.1412	\$1,384.99	
44	2059	0.1923	4,825	\$928	136	\$26	4,846	\$932	9,807	\$1,886	0.05	\$0.1423	\$1,395.84	
45	2060	0.1934	4,825	\$933	136	\$26	4,846	\$937	9,807	\$1,897	0.05	\$0.1434	\$1,406.75	
46	2061	0.1946	4,825	\$939	136	\$26	4,846	\$943	9,807	\$1,908	0.05	\$0.1446	\$1,417.73	
47	2062	0.1957	4,825	\$944	136	\$27	4,846	\$948	9,807	\$1,919	0.05	\$0.1457	\$1,428.77	
48	2063	0.1968	4,825	\$950	136	\$27	4,846	\$954	9,807	\$1,930	0.05	\$0.1468	\$1,439.87	
49	2064	0.1980	4,825	\$955	136	\$27	4,846	\$959	9,807	\$1,941	0.05	\$0.1480	\$1,451.03	
50	2065	0.1991	4,825	\$961	136	\$27	4,846	\$965	9,807	\$1,953	0.05	\$0.1491	\$1,462.27	
51	2066	0.2003	4,825	\$966	136	\$27	4,846	\$970	9,807	\$1,964	0.05	\$0.1503	\$1,473.56	
52	2067	0.2014	4,825	\$972	136	\$27	4,846	\$976	9,807	\$1,975	0.05	\$0.1514	\$1,484.92	
53	2068	0.2026	4,825	\$977	136	\$28	4,846	\$982	9,807	\$1,987	0.05	\$0.1526	\$1,496.35	
54	2069	0.2038	4,825	\$983	136	\$28	4,846	\$987	9,807	\$1,998	0.05	\$0.1538	\$1,507.84	
55	2070	0.2049	4,825	\$989	136	\$28	4,846	\$993	9,807	\$2,010	0.05	\$0.1549	\$1,519.40	
56	2071	0.2061	4,825	\$995	136	\$28	4,846	\$999	9,807	\$2,021	0.05	\$0.1561	\$1,531.03	
57	2072	0.2073	4,825	\$1,000	136	\$28	4,846	\$1,005	9,807	\$2,033	0.05	\$0.1573	\$1,542.72	
58	2073	0.2085	4,825	\$1,006	136	\$28	4,846	\$1,010	9,807	\$2,045	0.05	\$0.1585	\$1,554.48	
59	2074	0.2097	4,825	\$1,012	136	\$29	4,846	\$1,016	9,807	\$2,057	0.05	\$0.1597	\$1,566.31	
60	2075	0.2109	4,825	\$1,018	136	\$29	4,846	\$1,022	9,807	\$2,069	0.05	\$0.1609	\$1,578.21	

Table D2-1.67: Annual Operating Costs (V.GSHP) of a 2,000 square feet detached house above grade (improved construction type) in the city of North Bay (two life cycles and three life cycles for a 60 year project lifespan); base case scenario in comparison with feed-in-tariff (FIT) scenario. In the FIT scenario, an incentive of \$0.05/KWh is provided on electricity bills throughout the project lifespan

Horizontal Ground Source Heat Pump (H.GSHP)

Base Case Scenario											Feed in Tariff (FIT)		
H.GSHP											FIT		
#	Year	Electricity Rates \$/KWh	Heating KWh	Heating Operating Cost \$	Cooling KWh	Cooling Operating Cost \$	Hot Water KWh	Hot Water Operating Cost \$	Total KWh	Total Operating Cost \$	Incentives (\$/KWh)	S/KWh	Operating Cost
1	2016	0.1501	4,924	\$739	140	\$21	4,831	\$725	9,895	\$1,485	0.05	0.1001	\$990.32
2	2017	0.1542	4,924	\$759	140	\$22	4,831	\$745	9,895	\$1,526	0.05	0.1042	\$1,030.93
3	2018	0.1583	4,924	\$779	140	\$22	4,831	\$765	9,895	\$1,566	0.05	0.1083	\$1,071.54
4	2019	0.1625	4,924	\$800	140	\$23	4,831	\$785	9,895	\$1,608	0.05	0.1125	\$1,113.57
5	2020	0.1668	4,924	\$821	140	\$23	4,831	\$806	9,895	\$1,650	0.05	0.1168	\$1,155.60
6	2021	0.1621	4,924	\$798	140	\$23	4,831	\$783	9,895	\$1,604	0.05	0.1121	\$1,109.65
7	2022	0.1629	4,924	\$802	140	\$23	4,831	\$787	9,895	\$1,612	0.05	0.1129	\$1,117.49
8	2023	0.1639	4,924	\$807	140	\$23	4,831	\$792	9,895	\$1,622	0.05	0.1139	\$1,126.75
9	2024	0.1648	4,924	\$812	140	\$23	4,831	\$796	9,895	\$1,631	0.05	0.1148	\$1,136.01
10	2025	0.1656	4,924	\$815	140	\$23	4,831	\$800	9,895	\$1,639	0.05	0.1156	\$1,143.85
11	2026	0.1665	4,924	\$820	140	\$23	4,831	\$805	9,895	\$1,648	0.05	0.1165	\$1,153.11
12	2027	0.1674	4,924	\$824	140	\$23	4,831	\$809	9,895	\$1,657	0.05	0.1174	\$1,162.02
13	2028	0.1683	4,924	\$829	140	\$24	4,831	\$813	9,895	\$1,665	0.05	0.1183	\$1,170.21
14	2029	0.1692	4,924	\$833	140	\$24	4,831	\$817	9,895	\$1,674	0.05	0.1192	\$1,179.11
15	2030	0.1701	4,924	\$838	140	\$24	4,831	\$822	9,895	\$1,683	0.05	0.1201	\$1,188.38
16	2031	0.1704	4,924	\$839	140	\$24	4,831	\$823	9,895	\$1,686	0.05	0.1204	\$1,190.87
17	2032	0.1705	4,924	\$840	140	\$24	4,831	\$824	9,895	\$1,687	0.05	0.1205	\$1,192.29
18	2033	0.1707	4,924	\$841	140	\$24	4,831	\$825	9,895	\$1,690	0.05	0.1207	\$1,194.79
19	2034	0.1710	4,924	\$842	140	\$24	4,831	\$826	9,895	\$1,692	0.05	0.1210	\$1,197.64
20	2035	0.1713	4,924	\$843	140	\$24	4,831	\$827	9,895	\$1,695	0.05	0.1213	\$1,200.13
21	2036	0.1714	4,924	\$844	140	\$24	4,831	\$828	9,895	\$1,696	0.05	0.1214	\$1,201.56
22	2037	0.1717	4,924	\$845	140	\$24	4,831	\$829	9,895	\$1,699	0.05	0.1217	\$1,204.05
23	2038	0.1720	4,924	\$847	140	\$24	4,831	\$831	9,895	\$1,702	0.05	0.1220	\$1,206.90
24	2039	0.1722	4,924	\$848	140	\$24	4,831	\$832	9,895	\$1,704	0.05	0.1222	\$1,209.39
25	2040	0.1724	4,924	\$849	140	\$24	4,831	\$833	9,895	\$1,706	0.05	0.1224	\$1,210.82
26	2041	0.1734	4,924	\$854	140	\$24	4,831	\$838	9,895	\$1,715	0.05	0.1234	\$1,220.68
27	2042	0.1744	4,924	\$859	140	\$24	4,831	\$842	9,895	\$1,725	0.05	0.1244	\$1,230.61
28	2043	0.1754	4,924	\$864	140	\$25	4,831	\$847	9,895	\$1,735	0.05	0.1254	\$1,240.59
29	2044	0.1764	4,924	\$869	140	\$25	4,831	\$852	9,895	\$1,745	0.05	0.1264	\$1,250.63
30	2045	0.1774	4,924	\$874	140	\$25	4,831	\$857	9,895	\$1,755	0.05	0.1274	\$1,260.72
31	2046	0.1784	4,924	\$879	140	\$25	4,831	\$862	9,895	\$1,766	0.05	0.1284	\$1,270.88
32	2047	0.1795	4,924	\$884	140	\$25	4,831	\$867	9,895	\$1,776	0.05	0.1295	\$1,281.09
33	2048	0.1805	4,924	\$889	140	\$25	4,831	\$872	9,895	\$1,786	0.05	0.1305	\$1,291.37
34	2049	0.1816	4,924	\$894	140	\$25	4,831	\$877	9,895	\$1,796	0.05	0.1316	\$1,301.70
35	2050	0.1826	4,924	\$899	140	\$26	4,831	\$882	9,895	\$1,807	0.05	0.1326	\$1,312.09
36	2051	0.1837	4,924	\$904	140	\$26	4,831	\$887	9,895	\$1,817	0.05	0.1337	\$1,322.54
37	2052	0.1847	4,924	\$910	140	\$26	4,831	\$892	9,895	\$1,828	0.05	0.1347	\$1,333.06
38	2053	0.1858	4,924	\$915	140	\$26	4,831	\$898	9,895	\$1,838	0.05	0.1358	\$1,343.63
39	2054	0.1869	4,924	\$920	140	\$26	4,831	\$903	9,895	\$1,849	0.05	0.1369	\$1,354.26
40	2055	0.1879	4,924	\$925	140	\$26	4,831	\$908	9,895	\$1,860	0.05	0.1379	\$1,364.96
41	2056	0.1890	4,924	\$931	140	\$26	4,831	\$913	9,895	\$1,870	0.05	0.1390	\$1,375.72
42	2057	0.1901	4,924	\$936	140	\$27	4,831	\$918	9,895	\$1,881	0.05	0.1401	\$1,386.54
43	2058	0.1912	4,924	\$942	140	\$27	4,831	\$924	9,895	\$1,892	0.05	0.1412	\$1,397.42
44	2059	0.1923	4,924	\$947	140	\$27	4,831	\$929	9,895	\$1,903	0.05	0.1423	\$1,408.37
45	2060	0.1934	4,924	\$953	140	\$27	4,831	\$935	9,895	\$1,914	0.05	0.1434	\$1,419.38
46	2061	0.1946	4,924	\$958	140	\$27	4,831	\$940	9,895	\$1,925	0.05	0.1446	\$1,430.45
47	2062	0.1957	4,924	\$964	140	\$27	4,831	\$945	9,895	\$1,936	0.05	0.1457	\$1,441.59
48	2063	0.1968	4,924	\$969	140	\$28	4,831	\$951	9,895	\$1,948	0.05	0.1468	\$1,452.79
49	2064	0.1980	4,924	\$975	140	\$28	4,831	\$956	9,895	\$1,959	0.05	0.1480	\$1,464.06
50	2065	0.1991	4,924	\$980	140	\$28	4,831	\$962	9,895	\$1,970	0.05	0.1491	\$1,475.39
51	2066	0.2003	4,924	\$986	140	\$28	4,831	\$967	9,895	\$1,982	0.05	0.1503	\$1,486.78
52	2067	0.2014	4,924	\$992	140	\$28	4,831	\$973	9,895	\$1,993	0.05	0.1514	\$1,498.25
53	2068	0.2026	4,924	\$998	140	\$28	4,831	\$979	9,895	\$2,005	0.05	0.1526	\$1,509.78
54	2069	0.2038	4,924	\$1,003	140	\$29	4,831	\$984	9,895	\$2,016	0.05	0.1538	\$1,521.37
55	2070	0.2049	4,924	\$1,009	140	\$29	4,831	\$990	9,895	\$2,028	0.05	0.1549	\$1,533.03
56	2071	0.2061	4,924	\$1,015	140	\$29	4,831	\$996	9,895	\$2,040	0.05	0.1561	\$1,544.76
57	2072	0.2073	4,924	\$1,021	140	\$29	4,831	\$1,002	9,895	\$2,051	0.05	0.1573	\$1,556.56
58	2073	0.2085	4,924	\$1,027	140	\$29	4,831	\$1,007	9,895	\$2,063	0.05	0.1585	\$1,568.43
59	2074	0.2097	4,924	\$1,033	140	\$29	4,831	\$1,013	9,895	\$2,075	0.05	0.1597	\$1,580.36
60	2075	0.2109	4,924	\$1,039	140	\$30	4,831	\$1,019	9,895	\$2,087	0.05	0.1609	\$1,592.37

Table D2-1.68: Annual Operating Costs (H.GSHP) of a 2,000 square feet detached house above grade (improved construction type) in the city of North Bay (two life cycles and three life cycles for a 60 year project lifespan); base case scenario in comparison with feed-in-tariff (FIT) scenario. In the FIT scenario, an incentive of \$0.05/KWh is provided on electricity bills throughout the project lifespan

Traditional HVAC Applications

Base Case Scenario															Carbon Taxes							
#	Year	Electricity Rates \$/KWh	Natural Gas Rates \$/m ³	Heating		Heating Operating Cost \$ (Electricity)	Heating Operating Cost \$ (Gas)	Total Heating Operating Cost \$	Cooling		Hot Water m ³	Hot Water Operating Cost \$	Total KWh	Total m ³	Total Electricity Operating Cost \$ (KWh)	Total Natural Gas Operating Cost \$ (m ³)	Total	Conversion of m ³ into Tons	Total Tons	Carbon Tax	Operating Costs	
				KWh (Electricity)	m ³ (Gas)				KWh	\$												
1	2016	0.1501	0.3458	1,820	2,286	\$273	\$791	\$1,064	681	\$102	1,061	\$367	2,501	3,347	375	\$1,157	\$1,533	6.06	6.06	\$10	\$60.58	\$1,593.43
2	2017	0.1542	0.3588	1,820	2,286	\$281	\$820	\$1,101	681	\$105	1,061	\$164	2,501	3,347	386	\$1,201	\$1,587	6.06	6.06	\$20	\$121.16	\$1,707.81
3	2018	0.1583	0.3718	1,820	2,286	\$288	\$850	\$1,138	681	\$108	1,061	\$168	2,501	3,347	396	\$1,245	\$1,640	6.06	6.06	\$30	\$181.74	\$1,822.19
4	2019	0.1625	0.3776	1,820	2,286	\$296	\$863	\$1,159	681	\$111	1,061	\$172	2,501	3,347	407	\$1,264	\$1,670	6.06	6.06	\$40	\$242.32	\$1,912.60
5	2020	0.1668	0.3841	1,820	2,286	\$304	\$878	\$1,182	681	\$114	1,061	\$177	2,501	3,347	417	\$1,286	\$1,703	6.06	6.06	\$50	\$302.90	\$2,005.57
6	2021	0.1621	0.3883	1,820	2,286	\$295	\$888	\$1,183	681	\$110	1,061	\$172	2,501	3,347	406	\$1,300	\$1,705	6.06	6.06	\$60	\$363.48	\$2,068.62
7	2022	0.1629	0.3929	1,820	2,286	\$297	\$898	\$1,195	681	\$111	1,061	\$173	2,501	3,347	407	\$1,315	\$1,722	6.06	6.06	\$70	\$424.06	\$2,146.55
8	2023	0.1639	0.3967	1,820	2,286	\$298	\$907	\$1,205	681	\$112	1,061	\$174	2,501	3,347	410	\$1,328	\$1,738	6.06	6.06	\$80	\$484.65	\$2,222.27
9	2024	0.1648	0.4005	1,820	2,286	\$300	\$916	\$1,216	681	\$112	1,061	\$175	2,501	3,347	412	\$1,341	\$1,753	6.06	6.06	\$90	\$545.23	\$2,298.00
10	2025	0.1656	0.4040	1,820	2,286	\$301	\$923	\$1,225	681	\$113	1,061	\$176	2,501	3,347	414	\$1,352	\$1,766	6.06	6.06	\$100	\$605.81	\$2,372.09
11	2026	0.1665	0.4070	1,820	2,286	\$303	\$930	\$1,234	681	\$113	1,061	\$177	2,501	3,347	417	\$1,362	\$1,779	6.06	6.06	\$110	\$666.39	\$2,445.25
12	2027	0.1674	0.4097	1,820	2,286	\$305	\$937	\$1,241	681	\$114	1,061	\$178	2,501	3,347	419	\$1,371	\$1,790	6.06	6.06	\$120	\$726.97	\$2,517.04
13	2028	0.1683	0.4124	1,820	2,286	\$306	\$943	\$1,249	681	\$115	1,061	\$179	2,501	3,347	421	\$1,380	\$1,801	6.06	6.06	\$130	\$787.55	\$2,588.66
14	2029	0.1692	0.4151	1,820	2,286	\$308	\$949	\$1,257	681	\$115	1,061	\$179	2,501	3,347	423	\$1,389	\$1,812	6.06	6.06	\$140	\$848.13	\$2,660.45
15	2030	0.1701	0.4170	1,820	2,286	\$310	\$953	\$1,263	681	\$116	1,061	\$180	2,501	3,347	425	\$1,396	\$1,821	6.06	6.06	\$150	\$908.71	\$2,729.78
16	2031	0.1704	0.4189	1,820	2,286	\$310	\$958	\$1,268	681	\$116	1,061	\$181	2,501	3,347	426	\$1,402	\$1,828	6.06	6.06	\$160	\$969.29	\$2,797.39
17	2032	0.1705	0.4204	1,820	2,286	\$310	\$961	\$1,271	681	\$116	1,061	\$181	2,501	3,347	426	\$1,407	\$1,834	6.06	6.06	\$170	\$1,029.87	\$2,863.45
18	2033	0.1707	0.4223	1,820	2,286	\$311	\$965	\$1,276	681	\$116	1,061	\$181	2,501	3,347	427	\$1,414	\$1,841	6.06	6.06	\$180	\$1,090.45	\$2,931.07
19	2034	0.1710	0.4246	1,820	2,286	\$311	\$971	\$1,282	681	\$116	1,061	\$181	2,501	3,347	428	\$1,421	\$1,849	6.06	6.06	\$190	\$1,151.03	\$3,000.05
20	2035	0.1713	0.4265	1,820	2,286	\$312	\$975	\$1,287	681	\$117	1,061	\$182	2,501	3,347	428	\$1,428	\$1,856	6.06	6.06	\$200	\$1,211.61	\$3,067.66
21	2036	0.1714	0.4288	1,820	2,286	\$312	\$980	\$1,292	681	\$117	1,061	\$182	2,501	3,347	429	\$1,435	\$1,864	6.06	6.06	\$210	\$1,272.19	\$3,136.29
22	2037	0.1717	0.4311	1,820	2,286	\$312	\$986	\$1,298	681	\$117	1,061	\$182	2,501	3,347	429	\$1,443	\$1,872	6.06	6.06	\$220	\$1,332.78	\$3,205.18
23	2038	0.1720	0.4331	1,820	2,286	\$313	\$990	\$1,303	681	\$117	1,061	\$182	2,501	3,347	430	\$1,449	\$1,880	6.06	6.06	\$230	\$1,393.36	\$3,272.88
24	2039	0.1722	0.4353	1,820	2,286	\$313	\$995	\$1,309	681	\$117	1,061	\$183	2,501	3,347	431	\$1,457	\$1,888	6.06	6.06	\$240	\$1,453.94	\$3,341.78
25	2040	0.1724	0.4376	1,820	2,286	\$314	\$1,000	\$1,314	681	\$117	1,061	\$183	2,501	3,347	431	\$1,465	\$1,896	6.06	6.06	\$250	\$1,514.52	\$3,410.40
26	2041	0.1734	0.4420	1,820	2,286	\$316	\$1,010	\$1,326	681	\$118	1,061	\$184	2,501	3,347	434	\$1,479	\$1,913	6.06	6.06	\$260	\$1,575.10	\$3,487.91
27	2042	0.1744	0.4463	1,820	2,286	\$317	\$1,020	\$1,338	681	\$119	1,061	\$185	2,501	3,347	436	\$1,494	\$1,930	6.06	6.06	\$270	\$1,635.68	\$3,565.59
28	2043	0.1754	0.4507	1,820	2,286	\$319	\$1,030	\$1,350	681	\$119	1,061	\$186	2,501	3,347	439	\$1,509	\$1,947	6.06	6.06	\$280	\$1,696.26	\$3,643.42
29	2044	0.1764	0.4552	1,820	2,286	\$321	\$1,040	\$1,362	681	\$120	1,061	\$187	2,501	3,347	441	\$1,523	\$1,965	6.06	6.06	\$290	\$1,756.84	\$3,721.41
30	2045	0.1774	0.4596	1,820	2,286	\$323	\$1,051	\$1,374	681	\$121	1,061	\$188	2,501	3,347	444	\$1,538	\$1,982	6.06	6.06	\$300	\$1,817.42	\$3,799.56
31	2046	0.1784	0.4642	1,820	2,286	\$325	\$1,061	\$1,386	681	\$122	1,061	\$189	2,501	3,347	446	\$1,554	\$2,000	6.06	6.06	\$310	\$1,878.00	\$3,877.86
32	2047	0.1795	0.4688	1,820	2,286	\$327	\$1,072	\$1,398	681	\$122	1,061	\$190	2,501	3,347	449	\$1,569	\$2,018	6.06	6.06	\$320	\$1,938.58	\$3,956.36
33	2048	0.1805	0.4734	1,820	2,286	\$329	\$1,082	\$1,411	681	\$123	1,061	\$192	2,501	3,347	451	\$1,584	\$2,036	6.06	6.06	\$330	\$1,999.16	\$4,035.00
34	2049	0.1816	0.4780	1,820	2,286	\$330	\$1,093	\$1,423	681	\$124	1,061	\$193	2,501	3,347	454	\$1,600	\$2,054	6.06	6.06	\$340	\$2,059.74	\$4,113.81
35	2050	0.1826	0.4828	1,820	2,286	\$332	\$1,104	\$1,436	681	\$124	1,061	\$194	2,501	3,347	457	\$1,616	\$2,072	6.06	6.06	\$350	\$2,120.32	\$4,192.80
36	2051	0.1837	0.4875	1,820	2,286	\$334	\$1,114	\$1,449	681	\$125	1,061	\$195	2,501	3,347	459	\$1,632	\$2,091	6.06	6.06	\$360	\$2,180.91	\$4,271.95
37	2052	0.1847	0.4923	1,820	2,286	\$336	\$1,125	\$1,462	681	\$126	1,061	\$196	2,501	3,347	462	\$1,648	\$2,110	6.06	6.06	\$370	\$2,241.49	\$4,351.27
38	2053	0.1858	0.4972	1,820	2,286	\$338	\$1,137	\$1,475	681	\$127	1,061	\$197	2,501	3,347	465	\$1,664	\$2,129	6.06	6.06	\$380	\$2,302.07	\$4,430.77
39	2054	0.1869	0.5021	1,820	2,286	\$340	\$1,148	\$1,488	681	\$127	1,061	\$198	2,501	3,347	467	\$1,680	\$2,148	6.06	6.06	\$390	\$2,362.65	\$4,510.45
40	2055	0.1879	0.5070	1,820	2,286	\$342	\$1,159	\$1,501	681	\$128	1,061	\$199	2,501	3,347	470	\$1,697	\$2,167	6.06	6.06	\$400	\$2,423.23	\$4,590.30
41	2056	0.1890	0.5120	1,820	2,286	\$344	\$1,170	\$1,515	681	\$129	1,061	\$201	2,501	3,347	473	\$1,714	\$2,187	6.06	6.06	\$410	\$2,483.81	\$4,670.33
42	2057	0.1901	0.5171	1,820	2,286	\$346	\$1,182	\$1,528	681	\$129	1,061	\$202	2,501	3,347	476	\$1,731	\$2,206	6.06	6.06	\$420	\$2,544.39	\$4,750.54
43	2058	0.1912	0.5222	1,820	2,286	\$348	\$1,194	\$1,542	681	\$130	1,061	\$203	2,501	3,347	478	\$1,748	\$2,226	6.06	6.06	\$430	\$2,604.97	\$4,830.93
44	2059	0.1923	0.5273	1,820	2,286	\$350	\$1,205	\$1,555	681	\$131	1,061	\$204	2,501	3,347	481	\$1,765	\$2,246	6.06	6.06	\$440	\$2,665.55	\$4,911.51
45	2060	0.1934	0.5325	1,820	2,286	\$352	\$1,217	\$1,569	681	\$132	1,061	\$205	2,501	3,347	484	\$1,782	\$2,266	6.06	6.06	\$450	\$2,726.13	\$4,992.28
46	2061	0.1946	0.5378	1,820	2,286	\$354	\$1,229	\$1,583	681	\$132	1,061	\$206	2,501	3,347	487	\$1,800	\$2,287	6.06	6.06	\$460	\$2,786.71	\$5,073.23
47	2062	0.1957	0.5431	1,820	2,286	\$356	\$1,241	\$1,598	681	\$133	1,061	\$208	2,501	3,347	489	\$1,818	\$2,307	6.06	6.06	\$470	\$2,847.29	\$5,154.37
48	2063	0.1968	0.5484	1,820	2,286	\$358	\$1,254	\$1,612	681	\$134	1,061	\$209	2,501	3,347	492	\$1,836	\$2,328	6.06	6.06	\$480	\$2,907.87	\$5,235.70
49	2064	0.1980	0.5538	1,820	2,286	\$360	\$1,266	\$1,626	681	\$135	1,061	\$210	2,501	3,347	495	\$1,854	\$2,349	6.06	6.06	\$490	\$2,968.45	\$5,317.23
50	2065	0.1991	0.5593	1,820	2,286	\$362	\$1,279	\$1,641	681	\$136	1,061	\$211	2,501	3,347	498	\$1,872	\$2,370	6.06	6.06	\$500	\$3,029.04	\$5,398.95
51	2066	0.2003	0.5648	1,820	2,286	\$364	\$1,291	\$1,656	681	\$136	1,061	\$212	2,501	3,347	501	\$1,890	\$2,391	6.06	6.06	\$510	\$3,089.62	\$5,480.86
52	2067	0.2014	0.5704	1,820	2,286	\$367	\$1,304	\$1,670	681	\$137	1,061	\$214	2,501	3,347	504	\$1,909	\$2,413	6.06	6.06	\$520	\$3,150.20	\$5,562.98
53	2068	0.2026	0.5760	1,820	2,286	\$369	\$1,317	\$1,685	681	\$138	1,061	\$215	2,501	3,347	507	\$1,928	\$2,435	6.06	6.06	\$530	\$3,210.78	\$5,645.29
54	2069	0.2038	0.5817	1,820	2,286	\$371	\$1,33															

24. Sault Ste. Marie (North) – Annual Operating Costs

Vertical Ground Source Heat Pump (V.GSHP)

Base Case Scenario											Feed in Tariff (FIT)			
#	Year	Electricity Rates		V.GSHP		V.GSHP		V.GSHP		V.GSHP		FIT		
		\$/KWh	KWh	Heating Operating Cost \$	Cooling Operating Cost \$	Hot Water Operating Cost \$	Total Operating Cost \$	Incentives (S/KWh)	S/KWh	Operating Cost				
1	2016	0.1501	4,959	\$744	\$20	\$433	\$680	9,626	\$1,445	0.05	0.1001	\$963.40		
2	2017	0.1542	4,959	\$765	\$21	\$433	\$699	9,626	\$1,484	0.05	0.1042	\$1,002.90		
3	2018	0.1583	4,959	\$785	\$21	\$433	\$718	9,626	\$1,524	0.05	0.1083	\$1,042.41		
4	2019	0.1625	4,959	\$806	\$22	\$433	\$737	9,626	\$1,565	0.05	0.1125	\$1,083.30		
5	2020	0.1668	4,959	\$827	\$22	\$433	\$756	9,626	\$1,605	0.05	0.1168	\$1,124.19		
6	2021	0.1621	4,959	\$804	\$22	\$433	\$735	9,626	\$1,561	0.05	0.1121	\$1,079.49		
7	2022	0.1629	4,959	\$808	\$22	\$433	\$739	9,626	\$1,568	0.05	0.1129	\$1,087.11		
8	2023	0.1639	4,959	\$813	\$22	\$433	\$743	9,626	\$1,577	0.05	0.1139	\$1,096.12		
9	2024	0.1648	4,959	\$817	\$22	\$433	\$747	9,626	\$1,586	0.05	0.1148	\$1,105.13		
10	2025	0.1656	4,959	\$821	\$22	\$433	\$751	9,626	\$1,594	0.05	0.1156	\$1,112.75		
11	2026	0.1665	4,959	\$826	\$22	\$433	\$755	9,626	\$1,603	0.05	0.1165	\$1,121.76		
12	2027	0.1674	4,959	\$830	\$22	\$433	\$759	9,626	\$1,612	0.05	0.1174	\$1,130.43		
13	2028	0.1683	4,959	\$834	\$23	\$433	\$763	9,626	\$1,620	0.05	0.1183	\$1,138.40		
14	2029	0.1692	4,959	\$839	\$23	\$433	\$767	9,626	\$1,628	0.05	0.1192	\$1,147.06		
15	2030	0.1701	4,959	\$844	\$23	\$433	\$771	9,626	\$1,637	0.05	0.1201	\$1,156.07		
16	2031	0.1704	4,959	\$845	\$23	\$433	\$772	9,626	\$1,640	0.05	0.1204	\$1,158.50		
17	2032	0.1705	4,959	\$845	\$23	\$433	\$773	9,626	\$1,641	0.05	0.1205	\$1,159.88		
18	2033	0.1707	4,959	\$847	\$23	\$433	\$774	9,626	\$1,644	0.05	0.1207	\$1,162.31		
19	2034	0.1710	4,959	\$848	\$23	\$433	\$775	9,626	\$1,646	0.05	0.1210	\$1,165.08		
20	2035	0.1713	4,959	\$849	\$23	\$433	\$776	9,626	\$1,649	0.05	0.1213	\$1,167.51		
21	2036	0.1714	4,959	\$850	\$23	\$433	\$777	9,626	\$1,650	0.05	0.1214	\$1,168.89		
22	2037	0.1717	4,959	\$851	\$23	\$433	\$778	9,626	\$1,653	0.05	0.1217	\$1,171.32		
23	2038	0.1720	4,959	\$853	\$23	\$433	\$780	9,626	\$1,655	0.05	0.1220	\$1,174.09		
24	2039	0.1722	4,959	\$854	\$23	\$433	\$781	9,626	\$1,658	0.05	0.1222	\$1,176.51		
25	2040	0.1724	4,959	\$855	\$23	\$433	\$781	9,626	\$1,659	0.05	0.1224	\$1,177.90		
26	2041	0.1734	4,959	\$860	\$23	\$433	\$786	9,626	\$1,669	0.05	0.1234	\$1,187.50		
27	2042	0.1744	4,959	\$865	\$23	\$433	\$790	9,626	\$1,678	0.05	0.1244	\$1,197.15		
28	2043	0.1754	4,959	\$870	\$24	\$433	\$795	9,626	\$1,688	0.05	0.1254	\$1,206.86		
29	2044	0.1764	4,959	\$875	\$24	\$433	\$800	9,626	\$1,698	0.05	0.1264	\$1,216.63		
30	2045	0.1774	4,959	\$880	\$24	\$433	\$804	9,626	\$1,708	0.05	0.1274	\$1,226.45		
31	2046	0.1784	4,959	\$885	\$24	\$433	\$809	9,626	\$1,718	0.05	0.1284	\$1,236.33		
32	2047	0.1795	4,959	\$890	\$24	\$433	\$814	9,626	\$1,728	0.05	0.1295	\$1,246.27		
33	2048	0.1805	4,959	\$895	\$24	\$433	\$818	9,626	\$1,738	0.05	0.1305	\$1,256.26		
34	2049	0.1816	4,959	\$900	\$24	\$433	\$823	9,626	\$1,748	0.05	0.1316	\$1,266.31		
35	2050	0.1826	4,959	\$906	\$24	\$433	\$828	9,626	\$1,758	0.05	0.1326	\$1,276.42		
36	2051	0.1837	4,959	\$911	\$25	\$433	\$833	9,626	\$1,768	0.05	0.1337	\$1,286.59		
37	2052	0.1847	4,959	\$916	\$25	\$433	\$837	9,626	\$1,778	0.05	0.1347	\$1,296.82		
38	2053	0.1858	4,959	\$921	\$25	\$433	\$842	9,626	\$1,788	0.05	0.1358	\$1,307.10		
39	2054	0.1869	4,959	\$927	\$25	\$433	\$847	9,626	\$1,799	0.05	0.1369	\$1,317.45		
40	2055	0.1879	4,959	\$932	\$25	\$433	\$852	9,626	\$1,809	0.05	0.1379	\$1,327.85		
41	2056	0.1890	4,959	\$937	\$25	\$433	\$857	9,626	\$1,820	0.05	0.1390	\$1,338.32		
42	2057	0.1901	4,959	\$943	\$25	\$433	\$862	9,626	\$1,830	0.05	0.1401	\$1,348.85		
43	2058	0.1912	4,959	\$948	\$26	\$433	\$867	9,626	\$1,841	0.05	0.1412	\$1,359.43		
44	2059	0.1923	4,959	\$954	\$26	\$433	\$872	9,626	\$1,851	0.05	0.1423	\$1,370.08		
45	2060	0.1934	4,959	\$959	\$26	\$433	\$877	9,626	\$1,862	0.05	0.1434	\$1,380.79		
46	2061	0.1946	4,959	\$965	\$26	\$433	\$882	9,626	\$1,873	0.05	0.1446	\$1,391.56		
47	2062	0.1957	4,959	\$970	\$26	\$433	\$887	9,626	\$1,884	0.05	0.1457	\$1,402.40		
48	2063	0.1968	4,959	\$976	\$26	\$433	\$892	9,626	\$1,895	0.05	0.1468	\$1,413.29		
49	2064	0.1980	4,959	\$982	\$27	\$433	\$897	9,626	\$1,906	0.05	0.1480	\$1,424.25		
50	2065	0.1991	4,959	\$987	\$27	\$433	\$903	9,626	\$1,917	0.05	0.1491	\$1,435.28		
51	2066	0.2003	4,959	\$993	\$27	\$433	\$908	9,626	\$1,928	0.05	0.1503	\$1,446.36		
52	2067	0.2014	4,959	\$999	\$27	\$433	\$913	9,626	\$1,939	0.05	0.1514	\$1,457.52		
53	2068	0.2026	4,959	\$1,005	\$27	\$433	\$918	9,626	\$1,950	0.05	0.1526	\$1,468.73		
54	2069	0.2038	4,959	\$1,010	\$27	\$433	\$924	9,626	\$1,961	0.05	0.1538	\$1,480.01		
55	2070	0.2049	4,959	\$1,016	\$27	\$433	\$929	9,626	\$1,973	0.05	0.1549	\$1,491.36		
56	2071	0.2061	4,959	\$1,022	\$28	\$433	\$934	9,626	\$1,984	0.05	0.1561	\$1,502.77		
57	2072	0.2073	4,959	\$1,028	\$28	\$433	\$940	9,626	\$1,996	0.05	0.1573	\$1,514.25		
58	2073	0.2085	4,959	\$1,034	\$28	\$433	\$945	9,626	\$2,007	0.05	0.1585	\$1,525.79		
59	2074	0.2097	4,959	\$1,040	\$28	\$433	\$951	9,626	\$2,019	0.05	0.1597	\$1,537.40		
60	2075	0.2109	4,959	\$1,046	\$28	\$433	\$956	9,626	\$2,030	0.05	0.1609	\$1,549.08		

Table D2-1.70: Annual Operating Costs (V.GSHP) of a 2,000 square feet detached house above grade (improved construction type) in the city of Sault Ste. Marie (two life cycles and three life cycles for a 60 year project lifespan); base case scenario in comparison with feed in-tariff (FIT) scenario. In the FIT scenario, an incentive of \$0.05/KWh is provided on electricity bills throughout the project lifespan

Horizontal Ground Source Heat Pump (H.GSHP)

Base Case Scenario												Feed in Tariff (FIT)		
H.GSHP												FIT		
#	Year	Electricity Rates \$/KWh	Heating KWh	Heating Operating Cost \$	Cooling KWh	Cooling Operating Cost \$	Hot Water KWh	Hot Water Operating Cost \$	Total KWh	Total Operating Cost \$	Incentives (\$/KWh)	S/KWh	Operating Cost	
1	2016	0.1501	5,038	\$756	138	\$21	4,538	\$681	9,714	\$1,458	0.05	0.1001	\$972.20	
2	2017	0.1542	5,038	\$777	138	\$21	4,538	\$700	9,714	\$1,498	0.05	0.1042	\$1,012.07	
3	2018	0.1583	5,038	\$797	138	\$22	4,538	\$718	9,714	\$1,538	0.05	0.1083	\$1,051.94	
4	2019	0.1625	5,038	\$819	138	\$22	4,538	\$738	9,714	\$1,579	0.05	0.1125	\$1,093.20	
5	2020	0.1668	5,038	\$840	138	\$23	4,538	\$757	9,714	\$1,620	0.05	0.1168	\$1,134.47	
6	2021	0.1621	5,038	\$817	138	\$22	4,538	\$736	9,714	\$1,575	0.05	0.1121	\$1,089.35	
7	2022	0.1629	5,038	\$821	138	\$22	4,538	\$739	9,714	\$1,583	0.05	0.1129	\$1,097.05	
8	2023	0.1639	5,038	\$826	138	\$23	4,538	\$744	9,714	\$1,592	0.05	0.1139	\$1,106.14	
9	2024	0.1648	5,038	\$830	138	\$23	4,538	\$748	9,714	\$1,601	0.05	0.1148	\$1,115.23	
10	2025	0.1656	5,038	\$834	138	\$23	4,538	\$751	9,714	\$1,609	0.05	0.1156	\$1,122.93	
11	2026	0.1665	5,038	\$839	138	\$23	4,538	\$756	9,714	\$1,618	0.05	0.1165	\$1,132.02	
12	2027	0.1674	5,038	\$844	138	\$23	4,538	\$760	9,714	\$1,626	0.05	0.1174	\$1,140.76	
13	2028	0.1683	5,038	\$848	138	\$23	4,538	\$764	9,714	\$1,635	0.05	0.1183	\$1,148.80	
14	2029	0.1692	5,038	\$852	138	\$23	4,538	\$768	9,714	\$1,643	0.05	0.1192	\$1,157.55	
15	2030	0.1701	5,038	\$857	138	\$23	4,538	\$772	9,714	\$1,652	0.05	0.1201	\$1,166.64	
16	2031	0.1704	5,038	\$858	138	\$24	4,538	\$773	9,714	\$1,655	0.05	0.1204	\$1,169.09	
17	2032	0.1705	5,038	\$859	138	\$24	4,538	\$774	9,714	\$1,656	0.05	0.1205	\$1,170.48	
18	2033	0.1707	5,038	\$860	138	\$24	4,538	\$775	9,714	\$1,659	0.05	0.1207	\$1,172.93	
19	2034	0.1710	5,038	\$862	138	\$24	4,538	\$776	9,714	\$1,661	0.05	0.1210	\$1,175.73	
20	2035	0.1713	5,038	\$863	138	\$24	4,538	\$777	9,714	\$1,664	0.05	0.1213	\$1,178.18	
21	2036	0.1714	5,038	\$864	138	\$24	4,538	\$778	9,714	\$1,665	0.05	0.1214	\$1,179.58	
22	2037	0.1717	5,038	\$865	138	\$24	4,538	\$779	9,714	\$1,668	0.05	0.1217	\$1,182.03	
23	2038	0.1720	5,038	\$866	138	\$24	4,538	\$780	9,714	\$1,671	0.05	0.1220	\$1,184.82	
24	2039	0.1722	5,038	\$868	138	\$24	4,538	\$782	9,714	\$1,673	0.05	0.1222	\$1,187.27	
25	2040	0.1724	5,038	\$868	138	\$24	4,538	\$782	9,714	\$1,674	0.05	0.1224	\$1,188.67	
26	2041	0.1734	5,038	\$873	138	\$24	4,538	\$787	9,714	\$1,684	0.05	0.1234	\$1,198.36	
27	2042	0.1744	5,038	\$878	138	\$24	4,538	\$791	9,714	\$1,694	0.05	0.1244	\$1,208.10	
28	2043	0.1754	5,038	\$884	138	\$24	4,538	\$796	9,714	\$1,704	0.05	0.1254	\$1,217.90	
29	2044	0.1764	5,038	\$889	138	\$24	4,538	\$800	9,714	\$1,713	0.05	0.1264	\$1,227.75	
30	2045	0.1774	5,038	\$894	138	\$24	4,538	\$805	9,714	\$1,723	0.05	0.1274	\$1,237.66	
31	2046	0.1784	5,038	\$899	138	\$25	4,538	\$810	9,714	\$1,733	0.05	0.1284	\$1,247.63	
32	2047	0.1795	5,038	\$904	138	\$25	4,538	\$814	9,714	\$1,743	0.05	0.1295	\$1,257.66	
33	2048	0.1805	5,038	\$909	138	\$25	4,538	\$819	9,714	\$1,753	0.05	0.1305	\$1,267.74	
34	2049	0.1816	5,038	\$915	138	\$25	4,538	\$824	9,714	\$1,764	0.05	0.1316	\$1,277.89	
35	2050	0.1826	5,038	\$920	138	\$25	4,538	\$829	9,714	\$1,774	0.05	0.1326	\$1,288.09	
36	2051	0.1837	5,038	\$925	138	\$25	4,538	\$833	9,714	\$1,784	0.05	0.1337	\$1,298.35	
37	2052	0.1847	5,038	\$931	138	\$25	4,538	\$838	9,714	\$1,794	0.05	0.1347	\$1,308.67	
38	2053	0.1858	5,038	\$936	138	\$26	4,538	\$843	9,714	\$1,805	0.05	0.1358	\$1,319.05	
39	2054	0.1869	5,038	\$941	138	\$26	4,538	\$848	9,714	\$1,815	0.05	0.1369	\$1,329.49	
40	2055	0.1879	5,038	\$947	138	\$26	4,538	\$853	9,714	\$1,826	0.05	0.1379	\$1,339.99	
41	2056	0.1890	5,038	\$952	138	\$26	4,538	\$858	9,714	\$1,836	0.05	0.1390	\$1,350.55	
42	2057	0.1901	5,038	\$958	138	\$26	4,538	\$863	9,714	\$1,847	0.05	0.1401	\$1,361.18	
43	2058	0.1912	5,038	\$963	138	\$26	4,538	\$868	9,714	\$1,858	0.05	0.1412	\$1,371.86	
44	2059	0.1923	5,038	\$969	138	\$27	4,538	\$873	9,714	\$1,868	0.05	0.1423	\$1,382.61	
45	2060	0.1934	5,038	\$975	138	\$27	4,538	\$878	9,714	\$1,879	0.05	0.1434	\$1,393.41	
46	2061	0.1946	5,038	\$980	138	\$27	4,538	\$883	9,714	\$1,890	0.05	0.1446	\$1,404.28	
47	2062	0.1957	5,038	\$986	138	\$27	4,538	\$888	9,714	\$1,901	0.05	0.1457	\$1,415.22	
48	2063	0.1968	5,038	\$992	138	\$27	4,538	\$893	9,714	\$1,912	0.05	0.1468	\$1,426.21	
49	2064	0.1980	5,038	\$997	138	\$27	4,538	\$898	9,714	\$1,923	0.05	0.1480	\$1,437.27	
50	2065	0.1991	5,038	\$1,003	138	\$27	4,538	\$904	9,714	\$1,934	0.05	0.1491	\$1,448.40	
51	2066	0.2003	5,038	\$1,009	138	\$28	4,538	\$909	9,714	\$1,945	0.05	0.1503	\$1,459.59	
52	2067	0.2014	5,038	\$1,015	138	\$28	4,538	\$914	9,714	\$1,957	0.05	0.1514	\$1,470.84	
53	2068	0.2026	5,038	\$1,021	138	\$28	4,538	\$919	9,714	\$1,968	0.05	0.1526	\$1,482.16	
54	2069	0.2038	5,038	\$1,027	138	\$28	4,538	\$925	9,714	\$1,979	0.05	0.1538	\$1,493.54	
55	2070	0.2049	5,038	\$1,032	138	\$28	4,538	\$930	9,714	\$1,991	0.05	0.1549	\$1,504.99	
56	2071	0.2061	5,038	\$1,038	138	\$28	4,538	\$935	9,714	\$2,002	0.05	0.1561	\$1,516.51	
57	2072	0.2073	5,038	\$1,044	138	\$29	4,538	\$941	9,714	\$2,014	0.05	0.1573	\$1,528.09	
58	2073	0.2085	5,038	\$1,050	138	\$29	4,538	\$946	9,714	\$2,025	0.05	0.1585	\$1,539.74	
59	2074	0.2097	5,038	\$1,057	138	\$29	4,538	\$952	9,714	\$2,037	0.05	0.1597	\$1,551.46	
60	2075	0.2109	5,038	\$1,063	138	\$29	4,538	\$957	9,714	\$2,049	0.05	0.1609	\$1,563.24	

Table D2-1.71: Annual Operating Costs (H.GSHP) of a 2,000 square feet detached house above grade (improved construction type) in the city of Sault Ste. Marie (two life cycles and three life cycles for a 60 year project lifespan); base case scenario in comparison with feed in-tariff (FIT) scenario. In the FIT scenario, an incentive of \$0.05/KWh is provided on electricity bills throughout the project lifespan

Traditional HVAC Applications

Base Case Scenario																	Carbon Taxes					
#	Year	Electricity Rates	Natural Gas Rates	Heating		Heating Operating Cost	Heating Operating Cost	Total Heating Operating Cost	Cooling		Hot Water	Hot Water Operating Cost	Total	Total	Total Electricity Operating Cost	Total Natural Gas Operating Cost	Total	Conversion of m ³ into Tons	Total Tons	Carbon Tax	Operating Costs	
				KWh (Electricity)	m ³ (Gas)				KWh	Operating Cost												m ³
		\$/KWh	\$/m ³			\$(Electricity)	\$(Gas)	\$		\$		\$	KWh	m ³	\$(KWh)	\$(m ³)						
1	2016	0.1501	0.3458	1,755	2,363	\$263	\$817	\$1,081	654	\$98	1,059	\$366	2,409	3,422	362	\$1,183	\$1,545	6.19	6.19	\$10	\$61.94	\$1,606.92
2	2017	0.1542	0.3588	1,755	2,363	\$271	\$848	\$1,119	654	\$101	1,059	\$163	2,409	3,422	371	\$1,228	\$1,599	6.19	6.19	\$20	\$123.88	\$1,723.25
3	2018	0.1583	0.3718	1,755	2,363	\$278	\$879	\$1,156	654	\$104	1,059	\$168	2,409	3,422	381	\$1,272	\$1,654	6.19	6.19	\$30	\$185.81	\$1,839.59
4	2019	0.1625	0.3776	1,755	2,363	\$285	\$892	\$1,177	654	\$106	1,059	\$172	2,409	3,422	392	\$1,292	\$1,684	6.19	6.19	\$40	\$247.75	\$1,931.39
5	2020	0.1668	0.3841	1,755	2,363	\$293	\$908	\$1,200	654	\$109	1,059	\$177	2,409	3,422	402	\$1,314	\$1,716	6.19	6.19	\$50	\$309.69	\$2,025.82
6	2021	0.1621	0.3883	1,755	2,363	\$285	\$918	\$1,202	654	\$106	1,059	\$172	2,409	3,422	391	\$1,329	\$1,719	6.19	6.19	\$60	\$371.63	\$2,090.97
7	2022	0.1629	0.3929	1,755	2,363	\$286	\$928	\$1,214	654	\$107	1,059	\$173	2,409	3,422	393	\$1,344	\$1,737	6.19	6.19	\$70	\$433.57	\$2,170.53
8	2023	0.1639	0.3967	1,755	2,363	\$288	\$937	\$1,225	654	\$107	1,059	\$174	2,409	3,422	395	\$1,358	\$1,752	6.19	6.19	\$80	\$495.51	\$2,247.81
9	2024	0.1648	0.4005	1,755	2,363	\$289	\$946	\$1,236	654	\$108	1,059	\$175	2,409	3,422	397	\$1,371	\$1,768	6.19	6.19	\$90	\$557.44	\$2,325.10
10	2025	0.1656	0.4040	1,755	2,363	\$291	\$955	\$1,245	654	\$108	1,059	\$175	2,409	3,422	399	\$1,382	\$1,781	6.19	6.19	\$100	\$619.38	\$2,400.72
11	2026	0.1665	0.4070	1,755	2,363	\$292	\$962	\$1,254	654	\$109	1,059	\$176	2,409	3,422	401	\$1,393	\$1,794	6.19	6.19	\$110	\$681.32	\$2,475.39
12	2027	0.1674	0.4097	1,755	2,363	\$294	\$968	\$1,262	654	\$110	1,059	\$177	2,409	3,422	403	\$1,402	\$1,805	6.19	6.19	\$120	\$743.26	\$2,548.66
13	2028	0.1683	0.4124	1,755	2,363	\$295	\$974	\$1,270	654	\$110	1,059	\$178	2,409	3,422	405	\$1,411	\$1,817	6.19	6.19	\$130	\$805.20	\$2,621.76
14	2029	0.1692	0.4151	1,755	2,363	\$297	\$981	\$1,278	654	\$111	1,059	\$179	2,409	3,422	408	\$1,420	\$1,828	6.19	6.19	\$140	\$867.13	\$2,695.03
15	2030	0.1701	0.4170	1,755	2,363	\$299	\$985	\$1,284	654	\$111	1,059	\$180	2,409	3,422	410	\$1,427	\$1,837	6.19	6.19	\$150	\$929.07	\$2,765.76
16	2031	0.1704	0.4189	1,755	2,363	\$299	\$990	\$1,289	654	\$111	1,059	\$180	2,409	3,422	410	\$1,433	\$1,844	6.19	6.19	\$160	\$991.01	\$2,834.86
17	2032	0.1705	0.4204	1,755	2,363	\$299	\$993	\$1,293	654	\$112	1,059	\$181	2,409	3,422	411	\$1,439	\$1,849	6.19	6.19	\$170	\$1,052.95	\$2,902.38
18	2033	0.1707	0.4223	1,755	2,363	\$300	\$998	\$1,298	654	\$112	1,059	\$181	2,409	3,422	411	\$1,445	\$1,857	6.19	6.19	\$180	\$1,114.89	\$2,971.47
19	2034	0.1710	0.4246	1,755	2,363	\$300	\$1,003	\$1,304	654	\$112	1,059	\$181	2,409	3,422	412	\$1,453	\$1,865	6.19	6.19	\$190	\$1,176.83	\$3,041.95
20	2035	0.1713	0.4265	1,755	2,363	\$301	\$1,008	\$1,309	654	\$112	1,059	\$181	2,409	3,422	413	\$1,460	\$1,872	6.19	6.19	\$200	\$1,238.76	\$3,111.05
21	2036	0.1714	0.4288	1,755	2,363	\$301	\$1,013	\$1,314	654	\$112	1,059	\$182	2,409	3,422	413	\$1,468	\$1,880	6.19	6.19	\$210	\$1,300.70	\$3,181.19
22	2037	0.1717	0.4311	1,755	2,363	\$301	\$1,019	\$1,320	654	\$112	1,059	\$182	2,409	3,422	414	\$1,475	\$1,889	6.19	6.19	\$220	\$1,362.64	\$3,251.58
23	2038	0.1720	0.4331	1,755	2,363	\$302	\$1,023	\$1,325	654	\$112	1,059	\$182	2,409	3,422	414	\$1,482	\$1,896	6.19	6.19	\$230	\$1,424.58	\$3,320.76
24	2039	0.1722	0.4353	1,755	2,363	\$302	\$1,029	\$1,331	654	\$113	1,059	\$182	2,409	3,422	415	\$1,490	\$1,905	6.19	6.19	\$240	\$1,486.52	\$3,391.16
25	2040	0.1724	0.4376	1,755	2,363	\$303	\$1,034	\$1,337	654	\$113	1,059	\$183	2,409	3,422	415	\$1,498	\$1,913	6.19	6.19	\$250	\$1,548.46	\$3,461.30
26	2041	0.1734	0.4420	1,755	2,363	\$304	\$1,044	\$1,349	654	\$113	1,059	\$184	2,409	3,422	418	\$1,512	\$1,930	6.19	6.19	\$260	\$1,610.39	\$3,540.41
27	2042	0.1744	0.4463	1,755	2,363	\$306	\$1,055	\$1,361	654	\$114	1,059	\$185	2,409	3,422	420	\$1,527	\$1,947	6.19	6.19	\$270	\$1,672.33	\$3,619.67
28	2043	0.1754	0.4507	1,755	2,363	\$308	\$1,065	\$1,373	654	\$115	1,059	\$186	2,409	3,422	422	\$1,542	\$1,965	6.19	6.19	\$280	\$1,734.27	\$3,699.10
29	2044	0.1764	0.4552	1,755	2,363	\$310	\$1,076	\$1,385	654	\$115	1,059	\$187	2,409	3,422	425	\$1,558	\$1,982	6.19	6.19	\$290	\$1,796.21	\$3,778.69
30	2045	0.1774	0.4596	1,755	2,363	\$311	\$1,086	\$1,397	654	\$116	1,059	\$188	2,409	3,422	427	\$1,573	\$2,000	6.19	6.19	\$300	\$1,858.15	\$3,858.44
31	2046	0.1784	0.4642	1,755	2,363	\$313	\$1,097	\$1,410	654	\$117	1,059	\$189	2,409	3,422	430	\$1,588	\$2,018	6.19	6.19	\$310	\$1,920.08	\$3,938.36
32	2047	0.1795	0.4688	1,755	2,363	\$315	\$1,108	\$1,423	654	\$117	1,059	\$190	2,409	3,422	432	\$1,604	\$2,036	6.19	6.19	\$320	\$1,982.02	\$4,018.44
33	2048	0.1805	0.4734	1,755	2,363	\$317	\$1,119	\$1,435	654	\$118	1,059	\$191	2,409	3,422	435	\$1,620	\$2,055	6.19	6.19	\$330	\$2,043.96	\$4,098.69
34	2049	0.1816	0.4780	1,755	2,363	\$319	\$1,130	\$1,448	654	\$119	1,059	\$192	2,409	3,422	437	\$1,636	\$2,073	6.19	6.19	\$340	\$2,105.90	\$4,179.12
35	2050	0.1826	0.4828	1,755	2,363	\$320	\$1,141	\$1,461	654	\$119	1,059	\$193	2,409	3,422	440	\$1,652	\$2,092	6.19	6.19	\$350	\$2,167.84	\$4,259.72
36	2051	0.1837	0.4875	1,755	2,363	\$322	\$1,152	\$1,474	654	\$120	1,059	\$194	2,409	3,422	442	\$1,668	\$2,111	6.19	6.19	\$360	\$2,229.78	\$4,340.48
37	2052	0.1847	0.4923	1,755	2,363	\$324	\$1,163	\$1,488	654	\$121	1,059	\$196	2,409	3,422	445	\$1,685	\$2,130	6.19	6.19	\$370	\$2,291.71	\$4,421.43
38	2053	0.1858	0.4972	1,755	2,363	\$326	\$1,175	\$1,501	654	\$122	1,059	\$197	2,409	3,422	448	\$1,701	\$2,149	6.19	6.19	\$380	\$2,353.65	\$4,502.55
39	2054	0.1869	0.5021	1,755	2,363	\$328	\$1,186	\$1,514	654	\$122	1,059	\$198	2,409	3,422	450	\$1,718	\$2,168	6.19	6.19	\$390	\$2,415.59	\$4,583.85
40	2055	0.1879	0.5070	1,755	2,363	\$330	\$1,198	\$1,528	654	\$123	1,059	\$199	2,409	3,422	453	\$1,735	\$2,188	6.19	6.19	\$400	\$2,477.53	\$4,665.33
41	2056	0.1890	0.5120	1,755	2,363	\$332	\$1,210	\$1,542	654	\$124	1,059	\$200	2,409	3,422	455	\$1,752	\$2,208	6.19	6.19	\$410	\$2,539.47	\$4,747.00
42	2057	0.1901	0.5171	1,755	2,363	\$334	\$1,222	\$1,556	654	\$124	1,059	\$201	2,409	3,422	458	\$1,769	\$2,227	6.19	6.19	\$420	\$2,601.40	\$4,828.84
43	2058	0.1912	0.5222	1,755	2,363	\$336	\$1,234	\$1,569	654	\$125	1,059	\$203	2,409	3,422	461	\$1,787	\$2,248	6.19	6.19	\$430	\$2,663.34	\$4,910.88
44	2059	0.1923	0.5273	1,755	2,363	\$338	\$1,246	\$1,584	654	\$126	1,059	\$204	2,409	3,422	463	\$1,804	\$2,268	6.19	6.19	\$440	\$2,725.28	\$4,993.10
45	2060	0.1934	0.5325	1,755	2,363	\$339	\$1,258	\$1,598	654	\$127	1,059	\$205	2,409	3,422	466	\$1,822	\$2,288	6.19	6.19	\$450	\$2,787.22	\$5,075.51
46	2061	0.1946	0.5378	1,755	2,363	\$341	\$1,271	\$1,612	654	\$127	1,059	\$206	2,409	3,422	469	\$1,840	\$2,309	6.19	6.19	\$460	\$2,849.16	\$5,158.11
47	2062	0.1957	0.5431	1,755	2,363	\$343	\$1,283	\$1,627	654	\$128	1,059	\$207	2,409	3,422	471	\$1,858	\$2,330	6.19	6.19	\$470	\$2,911.10	\$5,240.90
48	2063	0.1968	0.5484	1,755	2,363	\$345	\$1,296	\$1,641	654	\$129	1,059	\$208	2,409	3,422	474	\$1,877	\$2,351	6.19	6.19	\$480	\$2,973.03	\$5,323.88
49	2064	0.1980	0.5538	1,755	2,363	\$347	\$1,309	\$1,656	654	\$129	1,059	\$210	2,409	3,422	477	\$1,895	\$2,371	6.19	6.19	\$490	\$3,034.97	\$5,407.07
50	2065	0.1991	0.5593	1,755	2,363	\$349	\$1,322	\$1,671	654	\$130	1,059	\$211	2,409	3,422	480	\$1,914	\$2,394	6.19	6.19	\$500	\$3,096.91	\$5,490.45
51	2066	0.2003	0.5648	1,755	2,363	\$351	\$1,335	\$1,686	654	\$131	1,059	\$212	2,409	3,422	482	\$1,933	\$2,415	6.19	6.19	\$510	\$3,158.85	\$5,574.03
52	2067	0.2014	0.5704	1,755	2,363	\$353	\$1,348	\$1,701	654	\$132	1,059	\$213	2,409	3,422	485	\$1,952	\$2,437	6.19	6.19	\$520	\$3,220.79	\$5,657.82
53	2068	0.2026	0.5760	1,755	2,363	\$356	\$1,361	\$1,717	654	\$132	1,059	\$215	2,409	3,422	488	\$1,971	\$2,459	6.19	6.19	\$530		

25. Sudbury (North) – Annual Operating Costs

Vertical Ground Source Heat Pump (V.GSHP)

Base Case Scenario											Feed in Tariff (FIT)		
#	Year	Electricity Rates		V.GSHP		Hot Water		Total	Total Operating Cost	Incentives (\$/KWh)	FIT		
		\$/KWh	KWh	Heating Operating Cost \$	Cooling Operating Cost \$	Hot Water Operating Cost \$	KWh				\$/KWh	Operating Cost	
1	2016	0.1501	5,359	\$804	\$22	148	4,616	\$693	10,123	\$1,519	0.05	\$1,013.14	
2	2017	0.1542	5,359	\$826	\$23	148	4,616	\$712	10,123	\$1,561	0.05	\$1,054.68	
3	2018	0.1583	5,359	\$848	\$23	148	4,616	\$731	10,123	\$1,602	0.05	\$1,096.23	
4	2019	0.1625	5,359	\$871	\$24	148	4,616	\$750	10,123	\$1,645	0.05	\$1,139.23	
5	2020	0.1668	5,359	\$894	\$25	148	4,616	\$770	10,123	\$1,688	0.05	\$1,182.23	
6	2021	0.1621	5,359	\$869	\$24	148	4,616	\$748	10,123	\$1,641	0.05	\$1,135.22	
7	2022	0.1629	5,359	\$873	\$24	148	4,616	\$752	10,123	\$1,649	0.05	\$1,143.24	
8	2023	0.1639	5,359	\$878	\$24	148	4,616	\$756	10,123	\$1,659	0.05	\$1,152.71	
9	2024	0.1648	5,359	\$883	\$24	148	4,616	\$761	10,123	\$1,668	0.05	\$1,162.19	
10	2025	0.1656	5,359	\$887	\$25	148	4,616	\$764	10,123	\$1,676	0.05	\$1,170.21	
11	2026	0.1665	5,359	\$892	\$25	148	4,616	\$769	10,123	\$1,686	0.05	\$1,179.68	
12	2027	0.1674	5,359	\$897	\$25	148	4,616	\$773	10,123	\$1,695	0.05	\$1,188.79	
13	2028	0.1683	5,359	\$902	\$25	148	4,616	\$777	10,123	\$1,703	0.05	\$1,197.17	
14	2029	0.1692	5,359	\$907	\$25	148	4,616	\$781	10,123	\$1,712	0.05	\$1,206.28	
15	2030	0.1701	5,359	\$912	\$25	148	4,616	\$785	10,123	\$1,722	0.05	\$1,215.76	
16	2031	0.1704	5,359	\$913	\$25	148	4,616	\$786	10,123	\$1,724	0.05	\$1,218.31	
17	2032	0.1705	5,359	\$914	\$25	148	4,616	\$787	10,123	\$1,726	0.05	\$1,219.77	
18	2033	0.1707	5,359	\$915	\$25	148	4,616	\$788	10,123	\$1,728	0.05	\$1,220.32	
19	2034	0.1710	5,359	\$917	\$25	148	4,616	\$789	10,123	\$1,731	0.05	\$1,225.23	
20	2035	0.1713	5,359	\$918	\$25	148	4,616	\$791	10,123	\$1,734	0.05	\$1,227.78	
21	2036	0.1714	5,359	\$919	\$25	148	4,616	\$791	10,123	\$1,735	0.05	\$1,229.24	
22	2037	0.1717	5,359	\$920	\$25	148	4,616	\$792	10,123	\$1,738	0.05	\$1,231.79	
23	2038	0.1720	5,359	\$922	\$25	148	4,616	\$794	10,123	\$1,741	0.05	\$1,234.71	
24	2039	0.1722	5,359	\$923	\$25	148	4,616	\$795	10,123	\$1,743	0.05	\$1,237.26	
25	2040	0.1724	5,359	\$924	\$26	148	4,616	\$796	10,123	\$1,745	0.05	\$1,238.72	
26	2041	0.1734	5,359	\$929	\$26	148	4,616	\$800	10,123	\$1,755	0.05	\$1,248.81	
27	2042	0.1744	5,359	\$934	\$26	148	4,616	\$805	10,123	\$1,765	0.05	\$1,258.96	
28	2043	0.1754	5,359	\$940	\$26	148	4,616	\$810	10,123	\$1,775	0.05	\$1,269.17	
29	2044	0.1764	5,359	\$945	\$26	148	4,616	\$814	10,123	\$1,786	0.05	\$1,279.44	
30	2045	0.1774	5,359	\$951	\$26	148	4,616	\$819	10,123	\$1,796	0.05	\$1,289.77	
31	2046	0.1784	5,359	\$956	\$26	148	4,616	\$824	10,123	\$1,806	0.05	\$1,300.16	
32	2047	0.1795	5,359	\$962	\$27	148	4,616	\$828	10,123	\$1,817	0.05	\$1,310.61	
33	2048	0.1805	5,359	\$967	\$27	148	4,616	\$833	10,123	\$1,827	0.05	\$1,321.12	
34	2049	0.1816	5,359	\$973	\$27	148	4,616	\$838	10,123	\$1,838	0.05	\$1,331.69	
35	2050	0.1826	5,359	\$979	\$27	148	4,616	\$843	10,123	\$1,848	0.05	\$1,342.32	
36	2051	0.1837	5,359	\$984	\$27	148	4,616	\$848	10,123	\$1,859	0.05	\$1,353.02	
37	2052	0.1847	5,359	\$990	\$27	148	4,616	\$853	10,123	\$1,870	0.05	\$1,363.77	
38	2053	0.1858	5,359	\$996	\$27	148	4,616	\$858	10,123	\$1,881	0.05	\$1,374.59	
39	2054	0.1869	5,359	\$1,001	\$28	148	4,616	\$863	10,123	\$1,892	0.05	\$1,385.47	
40	2055	0.1879	5,359	\$1,007	\$28	148	4,616	\$868	10,123	\$1,903	0.05	\$1,396.41	
41	2056	0.1890	5,359	\$1,013	\$28	148	4,616	\$873	10,123	\$1,914	0.05	\$1,407.42	
42	2057	0.1901	5,359	\$1,019	\$28	148	4,616	\$878	10,123	\$1,925	0.05	\$1,418.49	
43	2058	0.1912	5,359	\$1,025	\$28	148	4,616	\$883	10,123	\$1,936	0.05	\$1,429.62	
44	2059	0.1923	5,359	\$1,031	\$28	148	4,616	\$888	10,123	\$1,947	0.05	\$1,440.82	
45	2060	0.1934	5,359	\$1,037	\$29	148	4,616	\$893	10,123	\$1,958	0.05	\$1,452.08	
46	2061	0.1946	5,359	\$1,043	\$29	148	4,616	\$898	10,123	\$1,970	0.05	\$1,463.41	
47	2062	0.1957	5,359	\$1,049	\$29	148	4,616	\$903	10,123	\$1,981	0.05	\$1,474.80	
48	2063	0.1968	5,359	\$1,055	\$29	148	4,616	\$909	10,123	\$1,992	0.05	\$1,486.26	
49	2064	0.1980	5,359	\$1,061	\$29	148	4,616	\$914	10,123	\$2,004	0.05	\$1,497.79	
50	2065	0.1991	5,359	\$1,067	\$29	148	4,616	\$919	10,123	\$2,016	0.05	\$1,509.38	
51	2066	0.2003	5,359	\$1,073	\$30	148	4,616	\$924	10,123	\$2,027	0.05	\$1,521.04	
52	2067	0.2014	5,359	\$1,079	\$30	148	4,616	\$930	10,123	\$2,039	0.05	\$1,532.77	
53	2068	0.2026	5,359	\$1,086	\$30	148	4,616	\$935	10,123	\$2,051	0.05	\$1,544.56	
54	2069	0.2038	5,359	\$1,092	\$30	148	4,616	\$941	10,123	\$2,063	0.05	\$1,556.43	
55	2070	0.2049	5,359	\$1,098	\$30	148	4,616	\$946	10,123	\$2,075	0.05	\$1,568.36	
56	2071	0.2061	5,359	\$1,105	\$31	148	4,616	\$951	10,123	\$2,087	0.05	\$1,580.36	
57	2072	0.2073	5,359	\$1,111	\$31	148	4,616	\$957	10,123	\$2,099	0.05	\$1,592.43	
58	2073	0.2085	5,359	\$1,117	\$31	148	4,616	\$962	10,123	\$2,111	0.05	\$1,604.57	
59	2074	0.2097	5,359	\$1,124	\$31	148	4,616	\$968	10,123	\$2,123	0.05	\$1,616.78	
60	2075	0.2109	5,359	\$1,130	\$31	148	4,616	\$974	10,123	\$2,135	0.05	\$1,629.06	

Table D2-1.73: Annual Operating Costs (V.GSHP) of a 2,000 square foot detached house above grade (improved construction type) in the city of Sudbury (two life cycles and three life cycles for a 60 year project lifespan); base case scenario in comparison with feed in-tariff (FIT) scenario. In the FIT scenario, an incentive of \$0.05/KWh is provided on electricity bills throughout the project lifespan

Horizontal Ground Source Heat Pump (H.GSHP)

Base Case Scenario											Feed in Tariff (FIT)		
#	Year	H.GSHP									FIT		
		Electricity Rates \$/KWh	Heating KWh	Heating Operating Cost \$	Cooling KWh	Cooling Operating Cost \$	Hot Water KWh	Hot Water Operating Cost \$	Total KWh	Total Operating Cost \$	Incentives (\$/KWh)	S/KWh	Operating Cost
1	2016	0.1501	5,462	\$820	153	\$23	4,599	\$690	10,214	\$1,533	0.05	0.1001	\$1,022.25
2	2017	0.1542	5,462	\$842	153	\$24	4,599	\$709	10,214	\$1,575	0.05	0.1042	\$1,064.16
3	2018	0.1583	5,462	\$865	153	\$24	4,599	\$728	10,214	\$1,617	0.05	0.1083	\$1,106.08
4	2019	0.1625	5,462	\$888	153	\$25	4,599	\$748	10,214	\$1,660	0.05	0.1125	\$1,149.47
5	2020	0.1668	5,462	\$911	153	\$26	4,599	\$767	10,214	\$1,704	0.05	0.1168	\$1,192.86
6	2021	0.1621	5,462	\$886	153	\$25	4,599	\$746	10,214	\$1,656	0.05	0.1121	\$1,145.43
7	2022	0.1629	5,462	\$890	153	\$25	4,599	\$749	10,214	\$1,664	0.05	0.1129	\$1,153.51
8	2023	0.1639	5,462	\$895	153	\$25	4,599	\$754	10,214	\$1,674	0.05	0.1139	\$1,163.08
9	2024	0.1648	5,462	\$900	153	\$25	4,599	\$758	10,214	\$1,683	0.05	0.1148	\$1,172.64
10	2025	0.1656	5,462	\$904	153	\$25	4,599	\$762	10,214	\$1,691	0.05	0.1156	\$1,180.72
11	2026	0.1665	5,462	\$910	153	\$25	4,599	\$766	10,214	\$1,701	0.05	0.1165	\$1,190.29
12	2027	0.1674	5,462	\$915	153	\$26	4,599	\$770	10,214	\$1,710	0.05	0.1174	\$1,199.48
13	2028	0.1683	5,462	\$919	153	\$26	4,599	\$774	10,214	\$1,719	0.05	0.1183	\$1,207.93
14	2029	0.1692	5,462	\$924	153	\$26	4,599	\$778	10,214	\$1,728	0.05	0.1192	\$1,217.13
15	2030	0.1701	5,462	\$929	153	\$26	4,599	\$782	10,214	\$1,737	0.05	0.1201	\$1,226.69
16	2031	0.1704	5,462	\$930	153	\$26	4,599	\$783	10,214	\$1,740	0.05	0.1204	\$1,229.26
17	2032	0.1705	5,462	\$931	153	\$26	4,599	\$784	10,214	\$1,741	0.05	0.1205	\$1,230.73
18	2033	0.1707	5,462	\$933	153	\$26	4,599	\$785	10,214	\$1,744	0.05	0.1207	\$1,233.31
19	2034	0.1710	5,462	\$934	153	\$26	4,599	\$787	10,214	\$1,747	0.05	0.1210	\$1,236.25
20	2035	0.1713	5,462	\$936	153	\$26	4,599	\$788	10,214	\$1,750	0.05	0.1213	\$1,238.82
21	2036	0.1714	5,462	\$936	153	\$26	4,599	\$788	10,214	\$1,751	0.05	0.1214	\$1,240.29
22	2037	0.1717	5,462	\$938	153	\$26	4,599	\$790	10,214	\$1,754	0.05	0.1217	\$1,242.87
23	2038	0.1720	5,462	\$939	153	\$26	4,599	\$791	10,214	\$1,757	0.05	0.1220	\$1,245.81
24	2039	0.1722	5,462	\$941	153	\$26	4,599	\$792	10,214	\$1,759	0.05	0.1222	\$1,248.38
25	2040	0.1724	5,462	\$941	153	\$26	4,599	\$793	10,214	\$1,761	0.05	0.1224	\$1,249.85
26	2041	0.1734	5,462	\$947	153	\$27	4,599	\$797	10,214	\$1,771	0.05	0.1234	\$1,260.04
27	2042	0.1744	5,462	\$952	153	\$27	4,599	\$802	10,214	\$1,781	0.05	0.1244	\$1,270.28
28	2043	0.1754	5,462	\$958	153	\$27	4,599	\$807	10,214	\$1,791	0.05	0.1254	\$1,280.58
29	2044	0.1764	5,462	\$963	153	\$27	4,599	\$811	10,214	\$1,802	0.05	0.1264	\$1,290.95
30	2045	0.1774	5,462	\$969	153	\$27	4,599	\$816	10,214	\$1,812	0.05	0.1274	\$1,301.37
31	2046	0.1784	5,462	\$975	153	\$27	4,599	\$821	10,214	\$1,823	0.05	0.1284	\$1,311.85
32	2047	0.1795	5,462	\$980	153	\$27	4,599	\$825	10,214	\$1,833	0.05	0.1295	\$1,322.39
33	2048	0.1805	5,462	\$986	153	\$28	4,599	\$830	10,214	\$1,844	0.05	0.1305	\$1,333.00
34	2049	0.1816	5,462	\$992	153	\$28	4,599	\$835	10,214	\$1,854	0.05	0.1316	\$1,343.66
35	2050	0.1826	5,462	\$997	153	\$28	4,599	\$840	10,214	\$1,865	0.05	0.1326	\$1,354.39
36	2051	0.1837	5,462	\$1,003	153	\$28	4,599	\$845	10,214	\$1,876	0.05	0.1337	\$1,365.18
37	2052	0.1847	5,462	\$1,009	153	\$28	4,599	\$850	10,214	\$1,887	0.05	0.1347	\$1,376.03
38	2053	0.1858	5,462	\$1,015	153	\$28	4,599	\$854	10,214	\$1,898	0.05	0.1358	\$1,386.95
39	2054	0.1869	5,462	\$1,021	153	\$29	4,599	\$859	10,214	\$1,909	0.05	0.1369	\$1,397.92
40	2055	0.1879	5,462	\$1,027	153	\$29	4,599	\$864	10,214	\$1,920	0.05	0.1379	\$1,408.96
41	2056	0.1890	5,462	\$1,032	153	\$29	4,599	\$869	10,214	\$1,931	0.05	0.1390	\$1,420.07
42	2057	0.1901	5,462	\$1,038	153	\$29	4,599	\$874	10,214	\$1,942	0.05	0.1401	\$1,431.24
43	2058	0.1912	5,462	\$1,044	153	\$29	4,599	\$879	10,214	\$1,953	0.05	0.1412	\$1,442.47
44	2059	0.1923	5,462	\$1,051	153	\$29	4,599	\$885	10,214	\$1,964	0.05	0.1423	\$1,453.77
45	2060	0.1934	5,462	\$1,057	153	\$30	4,599	\$890	10,214	\$1,976	0.05	0.1434	\$1,465.14
46	2061	0.1946	5,462	\$1,063	153	\$30	4,599	\$895	10,214	\$1,987	0.05	0.1446	\$1,476.57
47	2062	0.1957	5,462	\$1,069	153	\$30	4,599	\$900	10,214	\$1,999	0.05	0.1457	\$1,488.06
48	2063	0.1968	5,462	\$1,075	153	\$30	4,599	\$905	10,214	\$2,010	0.05	0.1468	\$1,499.62
49	2064	0.1980	5,462	\$1,081	153	\$30	4,599	\$910	10,214	\$2,022	0.05	0.1480	\$1,511.25
50	2065	0.1991	5,462	\$1,088	153	\$30	4,599	\$916	10,214	\$2,034	0.05	0.1491	\$1,522.95
51	2066	0.2003	5,462	\$1,094	153	\$31	4,599	\$921	10,214	\$2,045	0.05	0.1503	\$1,534.72
52	2067	0.2014	5,462	\$1,100	153	\$31	4,599	\$926	10,214	\$2,057	0.05	0.1514	\$1,546.55
53	2068	0.2026	5,462	\$1,106	153	\$31	4,599	\$932	10,214	\$2,069	0.05	0.1526	\$1,558.45
54	2069	0.2038	5,462	\$1,113	153	\$31	4,599	\$937	10,214	\$2,081	0.05	0.1538	\$1,570.42
55	2070	0.2049	5,462	\$1,119	153	\$31	4,599	\$942	10,214	\$2,093	0.05	0.1549	\$1,582.46
56	2071	0.2061	5,462	\$1,126	153	\$32	4,599	\$948	10,214	\$2,105	0.05	0.1561	\$1,594.57
57	2072	0.2073	5,462	\$1,132	153	\$32	4,599	\$953	10,214	\$2,117	0.05	0.1573	\$1,606.74
58	2073	0.2085	5,462	\$1,139	153	\$32	4,599	\$959	10,214	\$2,130	0.05	0.1585	\$1,618.99
59	2074	0.2097	5,462	\$1,145	153	\$32	4,599	\$964	10,214	\$2,142	0.05	0.1597	\$1,631.31
60	2075	0.2109	5,462	\$1,152	153	\$32	4,599	\$970	10,214	\$2,154	0.05	0.1609	\$1,643.70

Table D2-1.74: Annual Operating Costs (H.GSHP) of a 2,000 square feet detached house above grade (improved construction type) in the city of Sudbury (two life cycles and three life cycles for a 60 year project lifespan); base case scenario in comparison with feed-in-tariff (FIT) scenario. In the FIT scenario, an incentive of \$0.05/KWh is provided on electricity bills throughout the project lifespan

Traditional HVAC Applications

Base Case Scenario																	Carbon Taxes					
#	Year	Electricity Rates \$/KWh	Natural Gas Rates \$/m ³	Heating		Heating Operating Cost \$ (Electricity)	Heating Operating Cost \$ (Gas)	Total Heating Operating Cost \$	Cooling		Hot Water m ³	Hot Water Operating Cost \$	Total KWh	Total m ³	Total Electricity Operating Cost \$ (KWh)	Total Natural Gas Operating Cost \$ (m ³)	Total	Conversion of m ³ into Tons	Total Tons	Carbon Tax	Operating Costs	
				KWh (Electricity)	m ³ (Gas)				Operating Cost \$	Operating Cost \$												
1	2016	0.1501	0.3458	2,152	2,528	\$323	\$874	\$1,297	804	\$121	1,059	\$366	2,956	3,587	444	\$1,240	6.49	6.49	\$10	\$64.92	\$1,749.06	
2	2017	0.1542	0.3588	2,152	2,528	\$332	\$907	\$1,239	804	\$124	1,059	\$163	2,956	3,587	456	\$1,287	\$1,743	6.49	6.49	\$20	\$129.85	\$1,872.77
3	2018	0.1583	0.3718	2,152	2,528	\$341	\$940	\$1,281	804	\$127	1,059	\$168	2,956	3,587	468	\$1,334	\$1,802	6.49	6.49	\$30	\$194.77	\$1,996.49
4	2019	0.1625	0.3776	2,152	2,528	\$350	\$955	\$1,304	804	\$131	1,059	\$172	2,956	3,587	480	\$1,354	\$1,835	6.49	6.49	\$40	\$259.70	\$2,094.55
5	2020	0.1668	0.3841	2,152	2,528	\$359	\$971	\$1,330	804	\$134	1,059	\$177	2,956	3,587	493	\$1,378	\$1,871	6.49	6.49	\$50	\$324.62	\$2,195.36
6	2021	0.1621	0.3883	2,152	2,528	\$349	\$982	\$1,331	804	\$130	1,059	\$172	2,956	3,587	479	\$1,393	\$1,872	6.49	6.49	\$60	\$389.55	\$2,261.65
7	2022	0.1629	0.3929	2,152	2,528	\$351	\$993	\$1,344	804	\$131	1,059	\$173	2,956	3,587	482	\$1,409	\$1,891	6.49	6.49	\$70	\$454.47	\$2,345.38
8	2023	0.1639	0.3967	2,152	2,528	\$353	\$1,003	\$1,356	804	\$132	1,059	\$174	2,956	3,587	484	\$1,423	\$1,907	6.49	6.49	\$80	\$519.40	\$2,426.80
9	2024	0.1648	0.4005	2,152	2,528	\$355	\$1,013	\$1,367	804	\$133	1,059	\$175	2,956	3,587	487	\$1,437	\$1,924	6.49	6.49	\$90	\$584.32	\$2,508.21
10	2025	0.1656	0.4040	2,152	2,528	\$356	\$1,021	\$1,378	804	\$133	1,059	\$175	2,956	3,587	490	\$1,449	\$1,939	6.49	6.49	\$100	\$649.25	\$2,587.83
11	2026	0.1665	0.4070	2,152	2,528	\$358	\$1,029	\$1,387	804	\$134	1,059	\$176	2,956	3,587	492	\$1,460	\$1,952	6.49	6.49	\$110	\$714.17	\$2,666.50
12	2027	0.1674	0.4097	2,152	2,528	\$360	\$1,036	\$1,396	804	\$135	1,059	\$177	2,956	3,587	495	\$1,470	\$1,965	6.49	6.49	\$120	\$779.10	\$2,743.69
13	2028	0.1683	0.4124	2,152	2,528	\$362	\$1,043	\$1,405	804	\$135	1,059	\$178	2,956	3,587	497	\$1,479	\$1,977	6.49	6.49	\$130	\$844.02	\$2,820.67
14	2029	0.1692	0.4151	2,152	2,528	\$364	\$1,049	\$1,413	804	\$136	1,059	\$179	2,956	3,587	500	\$1,489	\$1,989	6.49	6.49	\$140	\$908.95	\$2,897.86
15	2030	0.1701	0.4170	2,152	2,528	\$366	\$1,054	\$1,420	804	\$137	1,059	\$180	2,956	3,587	503	\$1,496	\$1,999	6.49	6.49	\$150	\$973.87	\$2,972.41
16	2031	0.1704	0.4189	2,152	2,528	\$367	\$1,059	\$1,426	804	\$137	1,059	\$180	2,956	3,587	504	\$1,503	\$2,006	6.49	6.49	\$160	\$1,038.80	\$3,044.94
17	2032	0.1705	0.4204	2,152	2,528	\$367	\$1,063	\$1,430	804	\$137	1,059	\$181	2,956	3,587	504	\$1,508	\$2,012	6.49	6.49	\$170	\$1,103.72	\$3,115.78
18	2033	0.1707	0.4223	2,152	2,528	\$367	\$1,068	\$1,435	804	\$137	1,059	\$181	2,956	3,587	505	\$1,515	\$2,020	6.49	6.49	\$180	\$1,168.64	\$3,188.31
19	2034	0.1710	0.4246	2,152	2,528	\$368	\$1,073	\$1,442	804	\$138	1,059	\$181	2,956	3,587	506	\$1,523	\$2,029	6.49	6.49	\$190	\$1,233.57	\$3,262.32
20	2035	0.1713	0.4265	2,152	2,528	\$369	\$1,078	\$1,447	804	\$138	1,059	\$181	2,956	3,587	506	\$1,530	\$2,036	6.49	6.49	\$200	\$1,298.49	\$3,334.85
21	2036	0.1714	0.4288	2,152	2,528	\$369	\$1,084	\$1,453	804	\$138	1,059	\$182	2,956	3,587	507	\$1,538	\$2,045	6.49	6.49	\$210	\$1,363.42	\$3,408.43
22	2037	0.1717	0.4311	2,152	2,528	\$369	\$1,090	\$1,459	804	\$138	1,059	\$182	2,956	3,587	507	\$1,546	\$2,054	6.49	6.49	\$220	\$1,428.34	\$3,482.34
23	2038	0.1720	0.4331	2,152	2,528	\$370	\$1,095	\$1,465	804	\$138	1,059	\$182	2,956	3,587	508	\$1,553	\$2,062	6.49	6.49	\$230	\$1,493.27	\$3,554.97
24	2039	0.1722	0.4353	2,152	2,528	\$371	\$1,101	\$1,471	804	\$138	1,059	\$182	2,956	3,587	509	\$1,562	\$2,071	6.49	6.49	\$240	\$1,558.19	\$3,628.88
25	2040	0.1724	0.4376	2,152	2,528	\$371	\$1,106	\$1,477	804	\$139	1,059	\$183	2,956	3,587	510	\$1,570	\$2,079	6.49	6.49	\$250	\$1,623.12	\$3,702.46
26	2041	0.1734	0.4420	2,152	2,528	\$373	\$1,117	\$1,490	804	\$139	1,059	\$184	2,956	3,587	512	\$1,585	\$2,098	6.49	6.49	\$260	\$1,688.04	\$3,785.81
27	2042	0.1744	0.4463	2,152	2,528	\$375	\$1,128	\$1,504	804	\$140	1,059	\$185	2,956	3,587	515	\$1,601	\$2,116	6.49	6.49	\$270	\$1,752.97	\$3,869.33
28	2043	0.1754	0.4507	2,152	2,528	\$377	\$1,139	\$1,517	804	\$141	1,059	\$186	2,956	3,587	518	\$1,617	\$2,135	6.49	6.49	\$280	\$1,817.89	\$3,953.02
29	2044	0.1764	0.4552	2,152	2,528	\$380	\$1,151	\$1,530	804	\$142	1,059	\$187	2,956	3,587	521	\$1,633	\$2,154	6.49	6.49	\$290	\$1,882.82	\$4,036.88
30	2045	0.1774	0.4596	2,152	2,528	\$382	\$1,162	\$1,544	804	\$143	1,059	\$188	2,956	3,587	524	\$1,649	\$2,173	6.49	6.49	\$300	\$1,947.74	\$4,120.92
31	2046	0.1784	0.4642	2,152	2,528	\$384	\$1,173	\$1,557	804	\$143	1,059	\$189	2,956	3,587	527	\$1,665	\$2,192	6.49	6.49	\$310	\$2,012.67	\$4,205.13
32	2047	0.1795	0.4688	2,152	2,528	\$386	\$1,185	\$1,571	804	\$144	1,059	\$190	2,956	3,587	531	\$1,681	\$2,212	6.49	6.49	\$320	\$2,077.59	\$4,289.52
33	2048	0.1805	0.4734	2,152	2,528	\$388	\$1,197	\$1,585	804	\$145	1,059	\$191	2,956	3,587	534	\$1,698	\$2,232	6.49	6.49	\$330	\$2,142.52	\$4,374.09
34	2049	0.1816	0.4780	2,152	2,528	\$391	\$1,208	\$1,599	804	\$146	1,059	\$192	2,956	3,587	537	\$1,715	\$2,251	6.49	6.49	\$340	\$2,207.44	\$4,458.85
35	2050	0.1826	0.4828	2,152	2,528	\$393	\$1,220	\$1,613	804	\$147	1,059	\$193	2,956	3,587	540	\$1,732	\$2,271	6.49	6.49	\$350	\$2,272.36	\$4,543.78
36	2051	0.1837	0.4875	2,152	2,528	\$395	\$1,232	\$1,628	804	\$148	1,059	\$194	2,956	3,587	543	\$1,749	\$2,292	6.49	6.49	\$360	\$2,337.29	\$4,628.90
37	2052	0.1847	0.4923	2,152	2,528	\$398	\$1,245	\$1,642	804	\$149	1,059	\$196	2,956	3,587	546	\$1,766	\$2,312	6.49	6.49	\$370	\$2,402.21	\$4,714.21
38	2053	0.1858	0.4972	2,152	2,528	\$400	\$1,257	\$1,657	804	\$149	1,059	\$197	2,956	3,587	549	\$1,783	\$2,333	6.49	6.49	\$380	\$2,467.14	\$4,799.70
39	2054	0.1869	0.5021	2,152	2,528	\$402	\$1,269	\$1,671	804	\$150	1,059	\$198	2,956	3,587	552	\$1,801	\$2,353	6.49	6.49	\$390	\$2,532.06	\$4,885.38
40	2055	0.1879	0.5070	2,152	2,528	\$404	\$1,282	\$1,686	804	\$151	1,059	\$199	2,956	3,587	556	\$1,819	\$2,374	6.49	6.49	\$400	\$2,596.99	\$4,971.26
41	2056	0.1890	0.5120	2,152	2,528	\$407	\$1,294	\$1,701	804	\$152	1,059	\$200	2,956	3,587	559	\$1,837	\$2,395	6.49	6.49	\$410	\$2,661.91	\$5,057.33
42	2057	0.1901	0.5171	2,152	2,528	\$409	\$1,307	\$1,716	804	\$153	1,059	\$201	2,956	3,587	562	\$1,855	\$2,417	6.49	6.49	\$420	\$2,726.84	\$5,143.59
43	2058	0.1912	0.5222	2,152	2,528	\$412	\$1,320	\$1,732	804	\$154	1,059	\$203	2,956	3,587	565	\$1,873	\$2,438	6.49	6.49	\$430	\$2,791.76	\$5,230.05
44	2059	0.1923	0.5273	2,152	2,528	\$414	\$1,333	\$1,747	804	\$155	1,059	\$204	2,956	3,587	569	\$1,891	\$2,460	6.49	6.49	\$440	\$2,856.69	\$5,316.72
45	2060	0.1934	0.5325	2,152	2,528	\$416	\$1,346	\$1,762	804	\$156	1,059	\$205	2,956	3,587	572	\$1,910	\$2,482	6.49	6.49	\$450	\$2,921.61	\$5,403.58
46	2061	0.1946	0.5378	2,152	2,528	\$419	\$1,359	\$1,778	804	\$156	1,059	\$206	2,956	3,587	575	\$1,929	\$2,504	6.49	6.49	\$460	\$2,986.54	\$5,490.64
47	2062	0.1957	0.5431	2,152	2,528	\$421	\$1,373	\$1,794	804	\$157	1,059	\$207	2,956	3,587	578	\$1,948	\$2,526	6.49	6.49	\$470	\$3,051.46	\$5,577.91
48	2063	0.1968	0.5484	2,152	2,528	\$424	\$1,386	\$1,810	804	\$158	1,059	\$208	2,956	3,587	582	\$1,967	\$2,549	6.49	6.49	\$480	\$3,116.39	\$5,665.39
49	2064	0.1980	0.5538	2,152	2,528	\$426	\$1,400	\$1,826	804	\$159	1,059	\$210	2,956	3,587	585	\$1,987	\$2,572	6.49	6.49	\$490	\$3,181.31	\$5,753.07
50	2065	0.1991	0.5593	2,152	2,528	\$428	\$1,414	\$1,842	804	\$160	1,059	\$211	2,956	3,587	589	\$2,006	\$2,595	6.49	6.49	\$500	\$3,246.24	\$5,840.97
51	2066	0.2003	0.5648	2,152	2,528	\$431	\$1,428	\$1,859	804	\$161	1,059	\$212	2,956	3,587	592	\$2,026	\$2,618	6.49	6.49	\$510	\$3,311.16	\$5,929.08
52	2067	0.2014	0.5704	2,152	2,528	\$433	\$1,442	\$1,875	804	\$162	1,059	\$213	2,956	3,587	595	\$2,046	\$2,641	6.49	6.49	\$520	\$3,376.08	\$6,017.40
53	2068	0.2026	0.5760	2,152	2,528	\$436	\$1,456	\$1,892	804	\$163	1,059	\$215	2,956	3,587	599	\$2,066	\$2,665	6.49	6.49	\$530	\$3,441.01	\$6,105.94
54	2069	0.2038	0.5817																			

26. Thunder Bay (North) – Annual Operating Costs

Vertical Ground Source Heat Pump (V.GSHP)

Base Case Scenario											Feed in Tariff (FIT)			
#	Year	V.GSHP		V.GSHP		V.GSHP		V.GSHP		Total	Total Operating Cost	Incentives (\$/KWh)	FIT	
		Electricity Rates	Heating	Heating Operating Cost	Cooling	Cooling Operating Cost	Hot Water	Hot Water Operating Cost	\$/KWh				Operating Cost	
		\$/KWh	KWh	\$	KWh	\$	KWh	\$	KWh	\$				
1	2016	0.1501	5,926	\$889	108	\$16	4,828	\$725	10,862	\$1,630	0.05	0.1001	\$1,087.10	
2	2017	0.1542	5,926	\$914	108	\$17	4,828	\$744	10,862	\$1,675	0.05	0.1042	\$1,131.68	
3	2018	0.1583	5,926	\$938	108	\$17	4,828	\$764	10,862	\$1,719	0.05	0.1083	\$1,176.25	
4	2019	0.1625	5,926	\$963	108	\$18	4,828	\$785	10,862	\$1,765	0.05	0.1125	\$1,222.40	
5	2020	0.1668	5,926	\$988	108	\$18	4,828	\$805	10,862	\$1,812	0.05	0.1168	\$1,268.54	
6	2021	0.1621	5,926	\$961	108	\$18	4,828	\$783	10,862	\$1,761	0.05	0.1121	\$1,218.09	
7	2022	0.1629	5,926	\$966	108	\$18	4,828	\$787	10,862	\$1,770	0.05	0.1129	\$1,226.70	
8	2023	0.1639	5,926	\$971	108	\$18	4,828	\$791	10,862	\$1,780	0.05	0.1139	\$1,236.86	
9	2024	0.1648	5,926	\$977	108	\$18	4,828	\$796	10,862	\$1,790	0.05	0.1148	\$1,247.03	
10	2025	0.1656	5,926	\$981	108	\$18	4,828	\$800	10,862	\$1,799	0.05	0.1156	\$1,255.63	
11	2026	0.1665	5,926	\$987	108	\$18	4,828	\$804	10,862	\$1,809	0.05	0.1165	\$1,265.80	
12	2027	0.1674	5,926	\$992	108	\$18	4,828	\$808	10,862	\$1,819	0.05	0.1174	\$1,275.58	
13	2028	0.1683	5,926	\$997	108	\$18	4,828	\$812	10,862	\$1,828	0.05	0.1183	\$1,284.57	
14	2029	0.1692	5,926	\$1,002	108	\$18	4,828	\$817	10,862	\$1,837	0.05	0.1192	\$1,294.34	
15	2030	0.1701	5,926	\$1,008	108	\$18	4,828	\$821	10,862	\$1,848	0.05	0.1201	\$1,304.51	
16	2031	0.1704	5,926	\$1,009	108	\$18	4,828	\$822	10,862	\$1,850	0.05	0.1204	\$1,307.25	
17	2032	0.1705	5,926	\$1,010	108	\$18	4,828	\$823	10,862	\$1,852	0.05	0.1205	\$1,308.81	
18	2033	0.1707	5,926	\$1,012	108	\$18	4,828	\$824	10,862	\$1,855	0.05	0.1207	\$1,311.55	
19	2034	0.1710	5,926	\$1,014	108	\$18	4,828	\$826	10,862	\$1,858	0.05	0.1210	\$1,314.68	
20	2035	0.1713	5,926	\$1,015	108	\$18	4,828	\$827	10,862	\$1,861	0.05	0.1213	\$1,317.42	
21	2036	0.1714	5,926	\$1,016	108	\$19	4,828	\$828	10,862	\$1,862	0.05	0.1214	\$1,318.98	
22	2037	0.1717	5,926	\$1,017	108	\$19	4,828	\$829	10,862	\$1,865	0.05	0.1217	\$1,321.72	
23	2038	0.1720	5,926	\$1,019	108	\$19	4,828	\$830	10,862	\$1,868	0.05	0.1220	\$1,324.84	
24	2039	0.1722	5,926	\$1,021	108	\$19	4,828	\$831	10,862	\$1,871	0.05	0.1222	\$1,327.58	
25	2040	0.1724	5,926	\$1,021	108	\$19	4,828	\$832	10,862	\$1,872	0.05	0.1224	\$1,329.15	
26	2041	0.1734	5,926	\$1,027	108	\$19	4,828	\$837	10,862	\$1,883	0.05	0.1234	\$1,339.98	
27	2042	0.1744	5,926	\$1,033	108	\$19	4,828	\$842	10,862	\$1,894	0.05	0.1244	\$1,350.87	
28	2043	0.1754	5,926	\$1,039	108	\$19	4,828	\$847	10,862	\$1,905	0.05	0.1254	\$1,361.83	
29	2044	0.1764	5,926	\$1,045	108	\$19	4,828	\$852	10,862	\$1,916	0.05	0.1264	\$1,372.85	
30	2045	0.1774	5,926	\$1,051	108	\$19	4,828	\$857	10,862	\$1,927	0.05	0.1274	\$1,383.93	
31	2046	0.1784	5,926	\$1,057	108	\$19	4,828	\$861	10,862	\$1,938	0.05	0.1284	\$1,395.08	
32	2047	0.1795	5,926	\$1,064	108	\$19	4,828	\$866	10,862	\$1,949	0.05	0.1295	\$1,406.29	
33	2048	0.1805	5,926	\$1,070	108	\$19	4,828	\$871	10,862	\$1,961	0.05	0.1305	\$1,417.57	
34	2049	0.1816	5,926	\$1,076	108	\$20	4,828	\$877	10,862	\$1,972	0.05	0.1316	\$1,428.91	
35	2050	0.1826	5,926	\$1,082	108	\$20	4,828	\$882	10,862	\$1,983	0.05	0.1326	\$1,440.32	
36	2051	0.1837	5,926	\$1,088	108	\$20	4,828	\$887	10,862	\$1,995	0.05	0.1337	\$1,451.79	
37	2052	0.1847	5,926	\$1,095	108	\$20	4,828	\$892	10,862	\$2,006	0.05	0.1347	\$1,463.33	
38	2053	0.1858	5,926	\$1,101	108	\$20	4,828	\$897	10,862	\$2,018	0.05	0.1358	\$1,474.94	
39	2054	0.1869	5,926	\$1,107	108	\$20	4,828	\$902	10,862	\$2,030	0.05	0.1369	\$1,486.61	
40	2055	0.1879	5,926	\$1,114	108	\$20	4,828	\$907	10,862	\$2,041	0.05	0.1379	\$1,498.35	
41	2056	0.1890	5,926	\$1,120	108	\$20	4,828	\$913	10,862	\$2,053	0.05	0.1390	\$1,510.16	
42	2057	0.1901	5,926	\$1,127	108	\$21	4,828	\$918	10,862	\$2,065	0.05	0.1401	\$1,522.04	
43	2058	0.1912	5,926	\$1,133	108	\$21	4,828	\$923	10,862	\$2,077	0.05	0.1412	\$1,533.99	
44	2059	0.1923	5,926	\$1,140	108	\$21	4,828	\$929	10,862	\$2,089	0.05	0.1423	\$1,546.00	
45	2060	0.1934	5,926	\$1,146	108	\$21	4,828	\$934	10,862	\$2,101	0.05	0.1434	\$1,558.09	
46	2061	0.1946	5,926	\$1,153	108	\$21	4,828	\$939	10,862	\$2,113	0.05	0.1446	\$1,570.24	
47	2062	0.1957	5,926	\$1,160	108	\$21	4,828	\$945	10,862	\$2,126	0.05	0.1457	\$1,582.47	
48	2063	0.1968	5,926	\$1,166	108	\$21	4,828	\$950	10,862	\$2,138	0.05	0.1468	\$1,594.76	
49	2064	0.1980	5,926	\$1,173	108	\$21	4,828	\$956	10,862	\$2,150	0.05	0.1480	\$1,607.13	
50	2065	0.1991	5,926	\$1,180	108	\$22	4,828	\$961	10,862	\$2,163	0.05	0.1491	\$1,619.57	
51	2066	0.2003	5,926	\$1,187	108	\$22	4,828	\$967	10,862	\$2,175	0.05	0.1503	\$1,632.08	
52	2067	0.2014	5,926	\$1,194	108	\$22	4,828	\$972	10,862	\$2,188	0.05	0.1514	\$1,644.66	
53	2068	0.2026	5,926	\$1,200	108	\$22	4,828	\$978	10,862	\$2,200	0.05	0.1526	\$1,657.32	
54	2069	0.2038	5,926	\$1,207	108	\$22	4,828	\$984	10,862	\$2,213	0.05	0.1538	\$1,670.05	
55	2070	0.2049	5,926	\$1,214	108	\$22	4,828	\$989	10,862	\$2,226	0.05	0.1549	\$1,682.85	
56	2071	0.2061	5,926	\$1,221	108	\$22	4,828	\$995	10,862	\$2,239	0.05	0.1561	\$1,695.73	
57	2072	0.2073	5,926	\$1,229	108	\$22	4,828	\$1,001	10,862	\$2,252	0.05	0.1573	\$1,708.68	
58	2073	0.2085	5,926	\$1,236	108	\$23	4,828	\$1,007	10,862	\$2,265	0.05	0.1585	\$1,721.71	
59	2074	0.2097	5,926	\$1,243	108	\$23	4,828	\$1,012	10,862	\$2,278	0.05	0.1597	\$1,734.81	
60	2075	0.2109	5,926	\$1,250	108	\$23	4,828	\$1,018	10,862	\$2,291	0.05	0.1609	\$1,747.99	

Table D2-1.76: Annual Operating Costs (V.GSHP) of a 2,000 square foot detached house above grade (improved construction type) in the city of Thunder Bay (two life cycles and three life cycles for a 60 year project lifespan); base case scenario in comparison with feed in-tariff (FIT) scenario. In the FIT scenario, an incentive of \$0.05/KWh is provided on electricity bills throughout the project lifespan

Horizontal Ground Source Heat Pump (H.GSHP)

Base Case Scenario											Feed in Tariff (FIT)		
H.GSHP											FIT		
#	Year	Electricity Rates \$/KWh	Heating KWh	Heating Operating Cost \$	Cooling KWh	Cooling Operating Cost \$	Hot Water KWh	Hot Water Operating Cost \$	Total KWh	Total Operating Cost \$	Incentives (\$/KWh)	S/KWh	Operating Cost
1	2016	0.1501	6,018	\$903	110	\$17	4,815	\$723	10,943	\$1,642	0.05	0.1001	\$1,095.21
2	2017	0.1542	6,018	\$928	110	\$17	4,815	\$742	10,943	\$1,687	0.05	0.1042	\$1,140.12
3	2018	0.1583	6,018	\$953	110	\$17	4,815	\$762	10,943	\$1,732	0.05	0.1083	\$1,185.03
4	2019	0.1625	6,018	\$978	110	\$18	4,815	\$783	10,943	\$1,779	0.05	0.1125	\$1,231.51
5	2020	0.1668	6,018	\$1,004	110	\$18	4,815	\$803	10,943	\$1,825	0.05	0.1168	\$1,278.00
6	2021	0.1621	6,018	\$976	110	\$18	4,815	\$781	10,943	\$1,774	0.05	0.1121	\$1,227.18
7	2022	0.1629	6,018	\$981	110	\$18	4,815	\$785	10,943	\$1,783	0.05	0.1129	\$1,235.84
8	2023	0.1639	6,018	\$986	110	\$18	4,815	\$789	10,943	\$1,793	0.05	0.1139	\$1,246.09
9	2024	0.1648	6,018	\$992	110	\$18	4,815	\$794	10,943	\$1,803	0.05	0.1148	\$1,256.33
10	2025	0.1656	6,018	\$997	110	\$18	4,815	\$797	10,943	\$1,812	0.05	0.1156	\$1,265.00
11	2026	0.1665	6,018	\$1,002	110	\$18	4,815	\$802	10,943	\$1,822	0.05	0.1165	\$1,275.24
12	2027	0.1674	6,018	\$1,008	110	\$18	4,815	\$806	10,943	\$1,832	0.05	0.1174	\$1,285.09
13	2028	0.1683	6,018	\$1,013	110	\$19	4,815	\$810	10,943	\$1,841	0.05	0.1183	\$1,294.15
14	2029	0.1692	6,018	\$1,018	110	\$19	4,815	\$815	10,943	\$1,851	0.05	0.1192	\$1,304.00
15	2030	0.1701	6,018	\$1,024	110	\$19	4,815	\$819	10,943	\$1,861	0.05	0.1201	\$1,314.24
16	2031	0.1704	6,018	\$1,025	110	\$19	4,815	\$820	10,943	\$1,864	0.05	0.1204	\$1,317.00
17	2032	0.1705	6,018	\$1,026	110	\$19	4,815	\$821	10,943	\$1,866	0.05	0.1205	\$1,318.57
18	2033	0.1707	6,018	\$1,028	110	\$19	4,815	\$822	10,943	\$1,868	0.05	0.1207	\$1,321.33
19	2034	0.1710	6,018	\$1,029	110	\$19	4,815	\$824	10,943	\$1,872	0.05	0.1210	\$1,324.48
20	2035	0.1713	6,018	\$1,031	110	\$19	4,815	\$825	10,943	\$1,874	0.05	0.1213	\$1,327.24
21	2036	0.1714	6,018	\$1,032	110	\$19	4,815	\$825	10,943	\$1,876	0.05	0.1214	\$1,328.82
22	2037	0.1717	6,018	\$1,033	110	\$19	4,815	\$827	10,943	\$1,879	0.05	0.1217	\$1,331.57
23	2038	0.1720	6,018	\$1,035	110	\$19	4,815	\$828	10,943	\$1,882	0.05	0.1220	\$1,334.72
24	2039	0.1722	6,018	\$1,036	110	\$19	4,815	\$829	10,943	\$1,885	0.05	0.1222	\$1,337.48
25	2040	0.1724	6,018	\$1,037	110	\$19	4,815	\$830	10,943	\$1,886	0.05	0.1224	\$1,339.06
26	2041	0.1734	6,018	\$1,043	110	\$19	4,815	\$835	10,943	\$1,897	0.05	0.1234	\$1,349.97
27	2042	0.1744	6,018	\$1,049	110	\$19	4,815	\$840	10,943	\$1,908	0.05	0.1244	\$1,360.94
28	2043	0.1754	6,018	\$1,055	110	\$19	4,815	\$844	10,943	\$1,919	0.05	0.1254	\$1,371.98
29	2044	0.1764	6,018	\$1,062	110	\$19	4,815	\$849	10,943	\$1,930	0.05	0.1264	\$1,383.08
30	2045	0.1774	6,018	\$1,068	110	\$20	4,815	\$854	10,943	\$1,941	0.05	0.1274	\$1,394.25
31	2046	0.1784	6,018	\$1,074	110	\$20	4,815	\$859	10,943	\$1,953	0.05	0.1284	\$1,405.48
32	2047	0.1795	6,018	\$1,080	110	\$20	4,815	\$864	10,943	\$1,964	0.05	0.1295	\$1,416.78
33	2048	0.1805	6,018	\$1,086	110	\$20	4,815	\$869	10,943	\$1,975	0.05	0.1305	\$1,428.14
34	2049	0.1816	6,018	\$1,093	110	\$20	4,815	\$874	10,943	\$1,987	0.05	0.1316	\$1,439.56
35	2050	0.1826	6,018	\$1,099	110	\$20	4,815	\$879	10,943	\$1,998	0.05	0.1326	\$1,451.06
36	2051	0.1837	6,018	\$1,105	110	\$20	4,815	\$884	10,943	\$2,010	0.05	0.1337	\$1,462.62
37	2052	0.1847	6,018	\$1,112	110	\$20	4,815	\$889	10,943	\$2,021	0.05	0.1347	\$1,474.24
38	2053	0.1858	6,018	\$1,118	110	\$20	4,815	\$895	10,943	\$2,033	0.05	0.1358	\$1,485.94
39	2054	0.1869	6,018	\$1,125	110	\$21	4,815	\$900	10,943	\$2,045	0.05	0.1369	\$1,497.70
40	2055	0.1879	6,018	\$1,131	110	\$21	4,815	\$905	10,943	\$2,057	0.05	0.1379	\$1,509.53
41	2056	0.1890	6,018	\$1,138	110	\$21	4,815	\$910	10,943	\$2,069	0.05	0.1390	\$1,521.42
42	2057	0.1901	6,018	\$1,144	110	\$21	4,815	\$915	10,943	\$2,081	0.05	0.1401	\$1,533.39
43	2058	0.1912	6,018	\$1,151	110	\$21	4,815	\$921	10,943	\$2,093	0.05	0.1412	\$1,545.43
44	2059	0.1923	6,018	\$1,157	110	\$21	4,815	\$926	10,943	\$2,105	0.05	0.1423	\$1,557.53
45	2060	0.1934	6,018	\$1,164	110	\$21	4,815	\$931	10,943	\$2,117	0.05	0.1434	\$1,569.71
46	2061	0.1946	6,018	\$1,171	110	\$21	4,815	\$937	10,943	\$2,129	0.05	0.1446	\$1,581.95
47	2062	0.1957	6,018	\$1,178	110	\$22	4,815	\$942	10,943	\$2,141	0.05	0.1457	\$1,594.27
48	2063	0.1968	6,018	\$1,184	110	\$22	4,815	\$948	10,943	\$2,154	0.05	0.1468	\$1,606.66
49	2064	0.1980	6,018	\$1,191	110	\$22	4,815	\$953	10,943	\$2,166	0.05	0.1480	\$1,619.12
50	2065	0.1991	6,018	\$1,198	110	\$22	4,815	\$959	10,943	\$2,179	0.05	0.1491	\$1,631.65
51	2066	0.2003	6,018	\$1,205	110	\$22	4,815	\$964	10,943	\$2,191	0.05	0.1503	\$1,644.25
52	2067	0.2014	6,018	\$1,212	110	\$22	4,815	\$970	10,943	\$2,204	0.05	0.1514	\$1,656.93
53	2068	0.2026	6,018	\$1,219	110	\$22	4,815	\$975	10,943	\$2,217	0.05	0.1526	\$1,669.68
54	2069	0.2038	6,018	\$1,226	110	\$22	4,815	\$981	10,943	\$2,230	0.05	0.1538	\$1,682.50
55	2070	0.2049	6,018	\$1,233	110	\$23	4,815	\$987	10,943	\$2,243	0.05	0.1549	\$1,695.40
56	2071	0.2061	6,018	\$1,240	110	\$23	4,815	\$992	10,943	\$2,256	0.05	0.1561	\$1,708.37
57	2072	0.2073	6,018	\$1,248	110	\$23	4,815	\$998	10,943	\$2,269	0.05	0.1573	\$1,721.42
58	2073	0.2085	6,018	\$1,255	110	\$23	4,815	\$1,004	10,943	\$2,282	0.05	0.1585	\$1,734.55
59	2074	0.2097	6,018	\$1,262	110	\$23	4,815	\$1,010	10,943	\$2,295	0.05	0.1597	\$1,747.74
60	2075	0.2109	6,018	\$1,269	110	\$23	4,815	\$1,016	10,943	\$2,308	0.05	0.1609	\$1,761.02

Table D2-1.77: Annual Operating Costs (H.GSHP) of a 2,000 square feet detached house above grade (improved construction type) in the city of Thunder Bay (two life cycles and three life cycles for a 60 year project lifespan); base case scenario in comparison with feed in-tariff (FIT) scenario. In the FIT scenario, an incentive of \$0.05/KWh is provided on electricity bills throughout the project lifespan

Traditional HVAC Applications

Base Case Scenario															Carbon Taxes								
#	Year	Traditional													Total	Carbon Taxes							
		Electricity Rates \$/KWh	Natural Gas Rates \$/m ³	Heating		Heating Operating Cost		Total Heating Operating Cost		Cooling		Hot Water		Total KWh		Total m ³	Total Electricity Operating Cost \$ (KWh)	Total Natural Gas Operating Cost \$ (m ³)	Total	Conversion of m ³ into Tons	Total Tons	Carbon Tax	Operating Costs
				KWh (Electricity)	m ³ (Gas)	\$ (Electricity)	\$ (Gas)	\$	\$	m ²	\$												
1	2016	0.1501	0.3458	2,144	2,684	\$322	\$928	\$1,250	568	\$85	1,106	\$382	2,712	3,790	407	\$1,311	\$1,718	6.86	6.86	\$10	\$68.60	\$1,786.32	
2	2017	0.1542	0.3588	2,144	2,684	\$331	\$963	\$1,294	568	\$88	1,106	\$171	2,712	3,790	418	\$1,360	\$1,778	6.86	6.86	\$20	\$137.20	\$1,915.34	
3	2018	0.1583	0.3718	2,144	2,684	\$339	\$998	\$1,337	568	\$90	1,106	\$175	2,712	3,790	429	\$1,409	\$1,839	6.86	6.86	\$30	\$205.80	\$2,044.37	
4	2019	0.1625	0.3776	2,144	2,684	\$348	\$1,013	\$1,362	568	\$92	1,106	\$180	2,712	3,790	441	\$1,431	\$1,872	6.86	6.86	\$40	\$274.40	\$2,146.24	
5	2020	0.1668	0.3841	2,144	2,684	\$358	\$1,031	\$1,388	568	\$95	1,106	\$184	2,712	3,790	452	\$1,456	\$1,908	6.86	6.86	\$50	\$343.00	\$2,251.01	
6	2021	0.1621	0.3883	2,144	2,684	\$348	\$1,042	\$1,390	568	\$92	1,106	\$179	2,712	3,790	440	\$1,472	\$1,911	6.86	6.86	\$60	\$411.59	\$2,322.96	
7	2022	0.1629	0.3929	2,144	2,684	\$349	\$1,055	\$1,404	568	\$93	1,106	\$180	2,712	3,790	442	\$1,489	\$1,931	6.86	6.86	\$70	\$480.19	\$2,411.10	
8	2023	0.1639	0.3967	2,144	2,684	\$351	\$1,065	\$1,416	568	\$93	1,106	\$181	2,712	3,790	444	\$1,504	\$1,948	6.86	6.86	\$80	\$548.79	\$2,496.74	
9	2024	0.1648	0.4005	2,144	2,684	\$353	\$1,075	\$1,428	568	\$94	1,106	\$182	2,712	3,790	447	\$1,518	\$1,965	6.86	6.86	\$90	\$617.39	\$2,582.38	
10	2025	0.1656	0.4040	2,144	2,684	\$355	\$1,084	\$1,439	568	\$94	1,106	\$183	2,712	3,790	449	\$1,531	\$1,980	6.86	6.86	\$100	\$685.99	\$2,666.17	
11	2026	0.1665	0.4070	2,144	2,684	\$357	\$1,092	\$1,450	568	\$95	1,106	\$184	2,712	3,790	452	\$1,543	\$1,994	6.86	6.86	\$110	\$754.59	\$2,748.91	
12	2027	0.1674	0.4097	2,144	2,684	\$359	\$1,100	\$1,459	568	\$95	1,106	\$185	2,712	3,790	454	\$1,553	\$2,007	6.86	6.86	\$120	\$823.19	\$2,830.10	
13	2028	0.1683	0.4124	2,144	2,684	\$361	\$1,107	\$1,468	568	\$96	1,106	\$186	2,712	3,790	456	\$1,563	\$2,019	6.86	6.86	\$130	\$891.79	\$2,911.09	
14	2029	0.1692	0.4151	2,144	2,684	\$363	\$1,114	\$1,477	568	\$96	1,106	\$187	2,712	3,790	459	\$1,573	\$2,032	6.86	6.86	\$140	\$960.39	\$2,992.28	
15	2030	0.1701	0.4170	2,144	2,684	\$365	\$1,119	\$1,484	568	\$97	1,106	\$188	2,712	3,790	461	\$1,580	\$2,042	6.86	6.86	\$150	\$1,028.99	\$3,070.67	
16	2031	0.1704	0.4189	2,144	2,684	\$365	\$1,124	\$1,490	568	\$97	1,106	\$188	2,712	3,790	462	\$1,588	\$2,050	6.86	6.86	\$160	\$1,097.58	\$3,147.20	
17	2032	0.1705	0.4204	2,144	2,684	\$366	\$1,128	\$1,494	568	\$97	1,106	\$189	2,712	3,790	462	\$1,593	\$2,056	6.86	6.86	\$170	\$1,166.18	\$3,221.99	
18	2033	0.1707	0.4223	2,144	2,684	\$366	\$1,134	\$1,500	568	\$97	1,106	\$189	2,712	3,790	463	\$1,601	\$2,064	6.86	6.86	\$180	\$1,234.78	\$3,298.52	
19	2034	0.1710	0.4246	2,144	2,684	\$367	\$1,140	\$1,506	568	\$97	1,106	\$189	2,712	3,790	464	\$1,609	\$2,073	6.86	6.86	\$190	\$1,303.38	\$3,376.60	
20	2035	0.1713	0.4265	2,144	2,684	\$367	\$1,145	\$1,512	568	\$97	1,106	\$189	2,712	3,790	465	\$1,617	\$2,081	6.86	6.86	\$200	\$1,371.98	\$3,453.13	
21	2036	0.1714	0.4288	2,144	2,684	\$368	\$1,151	\$1,519	568	\$97	1,106	\$190	2,712	3,790	465	\$1,625	\$2,090	6.86	6.86	\$210	\$1,440.58	\$3,530.82	
22	2037	0.1717	0.4311	2,144	2,684	\$368	\$1,157	\$1,525	568	\$98	1,106	\$190	2,712	3,790	466	\$1,634	\$2,100	6.86	6.86	\$220	\$1,509.18	\$3,608.80	
23	2038	0.1720	0.4331	2,144	2,684	\$369	\$1,162	\$1,531	568	\$98	1,106	\$190	2,712	3,790	466	\$1,641	\$2,108	6.86	6.86	\$230	\$1,577.78	\$3,685.43	
24	2039	0.1722	0.4353	2,144	2,684	\$369	\$1,168	\$1,538	568	\$98	1,106	\$190	2,712	3,790	467	\$1,650	\$2,117	6.86	6.86	\$240	\$1,646.38	\$3,763.41	
25	2040	0.1724	0.4376	2,144	2,684	\$370	\$1,175	\$1,544	568	\$98	1,106	\$191	2,712	3,790	467	\$1,659	\$2,126	6.86	6.86	\$250	\$1,714.98	\$3,841.10	
26	2041	0.1734	0.4420	2,144	2,684	\$372	\$1,186	\$1,558	568	\$98	1,106	\$192	2,712	3,790	470	\$1,675	\$2,145	6.86	6.86	\$260	\$1,783.57	\$3,928.76	
27	2042	0.1744	0.4463	2,144	2,684	\$374	\$1,198	\$1,572	568	\$99	1,106	\$193	2,712	3,790	473	\$1,692	\$2,164	6.86	6.86	\$270	\$1,852.17	\$4,016.59	
28	2043	0.1754	0.4507	2,144	2,684	\$376	\$1,210	\$1,586	568	\$100	1,106	\$194	2,712	3,790	476	\$1,708	\$2,184	6.86	6.86	\$280	\$1,920.77	\$4,104.60	
29	2044	0.1764	0.4552	2,144	2,684	\$378	\$1,222	\$1,600	568	\$100	1,106	\$195	2,712	3,790	478	\$1,725	\$2,203	6.86	6.86	\$290	\$1,989.37	\$4,192.79	
30	2045	0.1774	0.4596	2,144	2,684	\$380	\$1,234	\$1,614	568	\$101	1,106	\$196	2,712	3,790	481	\$1,742	\$2,223	6.86	6.86	\$300	\$2,057.97	\$4,281.17	
31	2046	0.1784	0.4642	2,144	2,684	\$383	\$1,246	\$1,628	568	\$101	1,106	\$197	2,712	3,790	484	\$1,759	\$2,243	6.86	6.86	\$310	\$2,126.57	\$4,369.72	
32	2047	0.1795	0.4688	2,144	2,684	\$385	\$1,258	\$1,643	568	\$102	1,106	\$198	2,712	3,790	487	\$1,777	\$2,263	6.86	6.86	\$320	\$2,195.17	\$4,458.47	
33	2048	0.1805	0.4734	2,144	2,684	\$387	\$1,271	\$1,658	568	\$103	1,106	\$200	2,712	3,790	490	\$1,794	\$2,284	6.86	6.86	\$330	\$2,263.77	\$4,547.40	
34	2049	0.1816	0.4780	2,144	2,684	\$389	\$1,283	\$1,672	568	\$103	1,106	\$201	2,712	3,790	492	\$1,812	\$2,304	6.86	6.86	\$340	\$2,332.37	\$4,636.52	
35	2050	0.1826	0.4828	2,144	2,684	\$391	\$1,296	\$1,687	568	\$104	1,106	\$202	2,712	3,790	495	\$1,830	\$2,325	6.86	6.86	\$350	\$2,400.97	\$4,725.83	
36	2051	0.1837	0.4875	2,144	2,684	\$394	\$1,308	\$1,702	568	\$104	1,106	\$203	2,712	3,790	498	\$1,848	\$2,346	6.86	6.86	\$360	\$2,469.56	\$4,815.33	
37	2052	0.1847	0.4923	2,144	2,684	\$396	\$1,321	\$1,717	568	\$105	1,106	\$204	2,712	3,790	501	\$1,866	\$2,367	6.86	6.86	\$370	\$2,538.16	\$4,905.02	
38	2053	0.1858	0.4972	2,144	2,684	\$398	\$1,334	\$1,733	568	\$106	1,106	\$205	2,712	3,790	504	\$1,884	\$2,388	6.86	6.86	\$380	\$2,606.76	\$4,994.92	
39	2054	0.1869	0.5021	2,144	2,684	\$401	\$1,348	\$1,748	568	\$106	1,106	\$207	2,712	3,790	507	\$1,903	\$2,410	6.86	6.86	\$390	\$2,675.36	\$5,085.01	
40	2055	0.1879	0.5070	2,144	2,684	\$403	\$1,361	\$1,764	568	\$107	1,106	\$208	2,712	3,790	510	\$1,922	\$2,431	6.86	6.86	\$400	\$2,743.96	\$5,175.30	
41	2056	0.1890	0.5120	2,144	2,684	\$405	\$1,374	\$1,780	568	\$107	1,106	\$209	2,712	3,790	513	\$1,941	\$2,453	6.86	6.86	\$410	\$2,812.56	\$5,265.79	
42	2057	0.1901	0.5171	2,144	2,684	\$408	\$1,388	\$1,795	568	\$108	1,106	\$210	2,712	3,790	516	\$1,960	\$2,475	6.86	6.86	\$420	\$2,881.16	\$5,356.49	
43	2058	0.1912	0.5222	2,144	2,684	\$410	\$1,402	\$1,811	568	\$109	1,106	\$211	2,712	3,790	519	\$1,979	\$2,498	6.86	6.86	\$430	\$2,949.76	\$5,447.39	
44	2059	0.1923	0.5273	2,144	2,684	\$412	\$1,415	\$1,828	568	\$109	1,106	\$213	2,712	3,790	522	\$1,999	\$2,520	6.86	6.86	\$440	\$3,018.36	\$5,538.50	
45	2060	0.1934	0.5325	2,144	2,684	\$415	\$1,429	\$1,844	568	\$110	1,106	\$214	2,712	3,790	525	\$2,018	\$2,543	6.86	6.86	\$450	\$3,086.96	\$5,629.82	
46	2061	0.1946	0.5378	2,144	2,684	\$417	\$1,443	\$1,861	568	\$111	1,106	\$215	2,712	3,790	528	\$2,038	\$2,566	6.86	6.86	\$460	\$3,155.55	\$5,721.35	
47	2062	0.1957	0.5431	2,144	2,684	\$420	\$1,458	\$1,877	568	\$111	1,106	\$216	2,712	3,790	531	\$2,058	\$2,589	6.86	6.86	\$470	\$3,224.15	\$5,813.10	
48	2063	0.1968	0.5484	2,144	2,684	\$422	\$1,472	\$1,894	568	\$112	1,106	\$218	2,712	3,790	534	\$2,079	\$2,612	6.86	6.86	\$480	\$3,292.75	\$5,905.06	
49	2064	0.1980	0.5538	2,144	2,684	\$424	\$1,486	\$1,911	568	\$112	1,106	\$219	2,712	3,790	537	\$2,099	\$2,636	6.86	6.86	\$490	\$3,361.35	\$5,997.24	
50	2065	0.1991	0.5593	2,144	2,684	\$427	\$1,501	\$1,928	568	\$113	1,106	\$220	2,712	3,790	540	\$2,120	\$2,660	6.86	6.86	\$500	\$3,429.95	\$6,089.64	
51	2066	0.2003	0.5648	2,144	2,684	\$429	\$1,516	\$1,945	568	\$114	1,106	\$221	2,712	3,790	543	\$2,141	\$2,684	6.86	6.86	\$510	\$3,498.55	\$6,182.26	
52	2067	0.2014	0.5704	2,144	2,684	\$432	\$1,531	\$1,963	568	\$114	1,106	\$223	2,712	3,790	546	\$2,162	\$2,708	6.86	6.86	\$520	\$3,567.15	\$6,275.10	
53	2068	0.2026	0.5760	2,144	2,684	\$434	\$1,546	\$1,980	568	\$115	1,106	\$224	2,712	3,790	549	\$2,183	\$2,732	6.86	6.86	\$530	\$3,635.75	\$6,368.18	
54	2069	0.2038	0.5817</																				

27. Timmins (North) – Annual Operating Costs

Vertical Ground Source Heat Pump (V.GSHP)

Base Case Scenario											Feed in Tariff (FIT)			
#	Year	V.GSHP		V.GSHP		V.GSHP		V.GSHP		Total	Total Operating Cost	Incentives (\$/KWh)	FIT	
		Electricity Rates \$/KWh	Heating KWh	Heating Operating Cost \$	Cooling KWh	Cooling Operating Cost \$	Hot Water KWh	Hot Water Operating Cost \$	KWh				\$	Operating Cost
1	2016	0.1501	6,199	\$930	132	\$20	4,319	\$648	10,650	\$1,598	0.05	0.1001	\$1,065.88	
2	2017	0.1542	6,199	\$956	132	\$20	4,319	\$666	10,650	\$1,642	0.05	0.1042	\$1,109.59	
3	2018	0.1583	6,199	\$981	132	\$21	4,319	\$684	10,650	\$1,686	0.05	0.1083	\$1,153.30	
4	2019	0.1625	6,199	\$1,008	132	\$21	4,319	\$702	10,650	\$1,731	0.05	0.1125	\$1,198.54	
5	2020	0.1668	6,199	\$1,034	132	\$22	4,319	\$720	10,650	\$1,776	0.05	0.1168	\$1,243.78	
6	2021	0.1621	6,199	\$1,005	132	\$21	4,319	\$700	10,650	\$1,727	0.05	0.1121	\$1,194.32	
7	2022	0.1629	6,199	\$1,010	132	\$22	4,319	\$704	10,650	\$1,735	0.05	0.1129	\$1,202.75	
8	2023	0.1639	6,199	\$1,016	132	\$22	4,319	\$708	10,650	\$1,745	0.05	0.1139	\$1,212.72	
9	2024	0.1648	6,199	\$1,022	132	\$22	4,319	\$712	10,650	\$1,755	0.05	0.1148	\$1,222.69	
10	2025	0.1656	6,199	\$1,027	132	\$22	4,319	\$715	10,650	\$1,764	0.05	0.1156	\$1,231.13	
11	2026	0.1665	6,199	\$1,032	132	\$22	4,319	\$719	10,650	\$1,774	0.05	0.1165	\$1,241.09	
12	2027	0.1674	6,199	\$1,038	132	\$22	4,319	\$723	10,650	\$1,783	0.05	0.1174	\$1,250.68	
13	2028	0.1683	6,199	\$1,043	132	\$22	4,319	\$727	10,650	\$1,792	0.05	0.1183	\$1,259.50	
14	2029	0.1692	6,199	\$1,049	132	\$22	4,319	\$731	10,650	\$1,802	0.05	0.1192	\$1,269.08	
15	2030	0.1701	6,199	\$1,054	132	\$22	4,319	\$735	10,650	\$1,812	0.05	0.1201	\$1,279.05	
16	2031	0.1704	6,199	\$1,056	132	\$22	4,319	\$736	10,650	\$1,814	0.05	0.1204	\$1,281.73	
17	2032	0.1705	6,199	\$1,057	132	\$23	4,319	\$736	10,650	\$1,816	0.05	0.1205	\$1,283.27	
18	2033	0.1707	6,199	\$1,058	132	\$23	4,319	\$737	10,650	\$1,818	0.05	0.1207	\$1,285.95	
19	2034	0.1710	6,199	\$1,060	132	\$23	4,319	\$739	10,650	\$1,822	0.05	0.1210	\$1,289.02	
20	2035	0.1713	6,199	\$1,062	132	\$23	4,319	\$740	10,650	\$1,824	0.05	0.1213	\$1,291.70	
21	2036	0.1714	6,199	\$1,063	132	\$23	4,319	\$740	10,650	\$1,826	0.05	0.1214	\$1,293.24	
22	2037	0.1717	6,199	\$1,064	132	\$23	4,319	\$741	10,650	\$1,828	0.05	0.1217	\$1,295.92	
23	2038	0.1720	6,199	\$1,066	132	\$23	4,319	\$743	10,650	\$1,831	0.05	0.1220	\$1,298.99	
24	2039	0.1722	6,199	\$1,068	132	\$23	4,319	\$744	10,650	\$1,834	0.05	0.1222	\$1,301.67	
25	2040	0.1724	6,199	\$1,069	132	\$23	4,319	\$744	10,650	\$1,836	0.05	0.1224	\$1,303.20	
26	2041	0.1734	6,199	\$1,075	132	\$23	4,319	\$749	10,650	\$1,846	0.05	0.1234	\$1,313.82	
27	2042	0.1744	6,199	\$1,081	132	\$23	4,319	\$753	10,650	\$1,857	0.05	0.1244	\$1,324.50	
28	2043	0.1754	6,199	\$1,087	132	\$23	4,319	\$757	10,650	\$1,868	0.05	0.1254	\$1,335.25	
29	2044	0.1764	6,199	\$1,093	132	\$23	4,319	\$762	10,650	\$1,879	0.05	0.1264	\$1,346.05	
30	2045	0.1774	6,199	\$1,100	132	\$23	4,319	\$766	10,650	\$1,889	0.05	0.1274	\$1,356.92	
31	2046	0.1784	6,199	\$1,106	132	\$24	4,319	\$771	10,650	\$1,900	0.05	0.1284	\$1,367.85	
32	2047	0.1795	6,199	\$1,113	132	\$24	4,319	\$775	10,650	\$1,911	0.05	0.1295	\$1,378.84	
33	2048	0.1805	6,199	\$1,119	132	\$24	4,319	\$780	10,650	\$1,922	0.05	0.1305	\$1,389.90	
34	2049	0.1816	6,199	\$1,125	132	\$24	4,319	\$784	10,650	\$1,934	0.05	0.1316	\$1,401.02	
35	2050	0.1826	6,199	\$1,132	132	\$24	4,319	\$789	10,650	\$1,945	0.05	0.1326	\$1,412.20	
36	2051	0.1837	6,199	\$1,138	132	\$24	4,319	\$793	10,650	\$1,956	0.05	0.1337	\$1,423.45	
37	2052	0.1847	6,199	\$1,145	132	\$24	4,319	\$798	10,650	\$1,967	0.05	0.1347	\$1,434.77	
38	2053	0.1858	6,199	\$1,152	132	\$25	4,319	\$802	10,650	\$1,979	0.05	0.1358	\$1,446.15	
39	2054	0.1869	6,199	\$1,158	132	\$25	4,319	\$807	10,650	\$1,990	0.05	0.1369	\$1,457.60	
40	2055	0.1879	6,199	\$1,165	132	\$25	4,319	\$812	10,650	\$2,002	0.05	0.1379	\$1,469.11	
41	2056	0.1890	6,199	\$1,172	132	\$25	4,319	\$816	10,650	\$2,013	0.05	0.1390	\$1,480.69	
42	2057	0.1901	6,199	\$1,179	132	\$25	4,319	\$821	10,650	\$2,025	0.05	0.1401	\$1,492.33	
43	2058	0.1912	6,199	\$1,185	132	\$25	4,319	\$826	10,650	\$2,037	0.05	0.1412	\$1,504.05	
44	2059	0.1923	6,199	\$1,192	132	\$25	4,319	\$831	10,650	\$2,048	0.05	0.1423	\$1,515.83	
45	2060	0.1934	6,199	\$1,199	132	\$26	4,319	\$835	10,650	\$2,060	0.05	0.1434	\$1,527.68	
46	2061	0.1946	6,199	\$1,206	132	\$26	4,319	\$840	10,650	\$2,072	0.05	0.1446	\$1,539.60	
47	2062	0.1957	6,199	\$1,213	132	\$26	4,319	\$845	10,650	\$2,084	0.05	0.1457	\$1,551.58	
48	2063	0.1968	6,199	\$1,220	132	\$26	4,319	\$850	10,650	\$2,096	0.05	0.1468	\$1,563.64	
49	2064	0.1980	6,199	\$1,227	132	\$26	4,319	\$855	10,650	\$2,108	0.05	0.1480	\$1,575.76	
50	2065	0.1991	6,199	\$1,234	132	\$26	4,319	\$860	10,650	\$2,120	0.05	0.1491	\$1,587.96	
51	2066	0.2003	6,199	\$1,241	132	\$26	4,319	\$865	10,650	\$2,133	0.05	0.1503	\$1,600.23	
52	2067	0.2014	6,199	\$1,249	132	\$27	4,319	\$870	10,650	\$2,145	0.05	0.1514	\$1,612.56	
53	2068	0.2026	6,199	\$1,256	132	\$27	4,319	\$875	10,650	\$2,157	0.05	0.1526	\$1,624.97	
54	2069	0.2038	6,199	\$1,263	132	\$27	4,319	\$880	10,650	\$2,170	0.05	0.1538	\$1,637.45	
55	2070	0.2049	6,199	\$1,270	132	\$27	4,319	\$885	10,650	\$2,183	0.05	0.1549	\$1,650.01	
56	2071	0.2061	6,199	\$1,278	132	\$27	4,319	\$890	10,650	\$2,195	0.05	0.1561	\$1,662.63	
57	2072	0.2073	6,199	\$1,285	132	\$27	4,319	\$895	10,650	\$2,208	0.05	0.1573	\$1,675.33	
58	2073	0.2085	6,199	\$1,293	132	\$28	4,319	\$901	10,650	\$2,221	0.05	0.1585	\$1,688.10	
59	2074	0.2097	6,199	\$1,300	132	\$28	4,319	\$906	10,650	\$2,233	0.05	0.1597	\$1,700.95	
60	2075	0.2109	6,199	\$1,308	132	\$28	4,319	\$911	10,650	\$2,246	0.05	0.1609	\$1,713.87	

Table D2-1.79: Annual Operating Costs (V.GSHP) of a 2,000 square feet detached house above grade (improved construction type) in the city of Timmins (two life cycles and three life cycles for a 60 year project lifespan); base case scenario in comparison with feed-in-tariff (FIT) scenario. In the FIT scenario, an incentive of \$0.05/KWh is provided on electricity bills throughout the project lifespan

Horizontal Ground Source Heat Pump (H.GSHP)

Base Case Scenario											Feed in Tariff (FIT)		
H.GSHP											FIT		
#	Year	Electricity Rates \$/KWh	Heating KWh	Heating Operating Cost \$	Cooling KWh	Cooling Operating Cost \$	Hot Water KWh	Hot Water Operating Cost \$	Total KWh	Total Operating Cost \$	Incentives (\$/KWh)	S/KWh	Operating Cost
1	2016	0.1501	6,302	\$946	136	\$20	4,304	\$646	####	\$1,612	0.05	0.1001	\$1,075.09
2	2017	0.1542	6,302	\$972	136	\$21	4,304	\$664	####	\$1,656	0.05	0.1042	\$1,119.17
3	2018	0.1583	6,302	\$998	136	\$22	4,304	\$681	####	\$1,700	0.05	0.1083	\$1,163.26
4	2019	0.1625	6,302	\$1,024	136	\$22	4,304	\$700	####	\$1,746	0.05	0.1125	\$1,208.89
5	2020	0.1668	6,302	\$1,051	136	\$23	4,304	\$718	####	\$1,792	0.05	0.1168	\$1,254.52
6	2021	0.1621	6,302	\$1,022	136	\$22	4,304	\$698	####	\$1,742	0.05	0.1121	\$1,204.64
7	2022	0.1629	6,302	\$1,027	136	\$22	4,304	\$701	####	\$1,750	0.05	0.1129	\$1,213.14
8	2023	0.1639	6,302	\$1,033	136	\$22	4,304	\$705	####	\$1,760	0.05	0.1139	\$1,223.20
9	2024	0.1648	6,302	\$1,039	136	\$22	4,304	\$709	####	\$1,770	0.05	0.1148	\$1,233.25
10	2025	0.1656	6,302	\$1,044	136	\$23	4,304	\$713	####	\$1,779	0.05	0.1156	\$1,241.76
11	2026	0.1665	6,302	\$1,050	136	\$23	4,304	\$717	####	\$1,789	0.05	0.1165	\$1,251.82
12	2027	0.1674	6,302	\$1,055	136	\$23	4,304	\$721	####	\$1,799	0.05	0.1174	\$1,261.48
13	2028	0.1683	6,302	\$1,060	136	\$23	4,304	\$724	####	\$1,807	0.05	0.1183	\$1,270.38
14	2029	0.1692	6,302	\$1,066	136	\$23	4,304	\$728	####	\$1,817	0.05	0.1192	\$1,280.05
15	2030	0.1701	6,302	\$1,072	136	\$23	4,304	\$732	####	\$1,827	0.05	0.1201	\$1,290.10
16	2031	0.1704	6,302	\$1,074	136	\$23	4,304	\$733	####	\$1,830	0.05	0.1204	\$1,292.81
17	2032	0.1705	6,302	\$1,074	136	\$23	4,304	\$734	####	\$1,831	0.05	0.1205	\$1,294.35
18	2033	0.1707	6,302	\$1,076	136	\$23	4,304	\$735	####	\$1,834	0.05	0.1207	\$1,297.06
19	2034	0.1710	6,302	\$1,078	136	\$23	4,304	\$736	####	\$1,837	0.05	0.1210	\$1,300.15
20	2035	0.1713	6,302	\$1,079	136	\$23	4,304	\$737	####	\$1,840	0.05	0.1213	\$1,302.86
21	2036	0.1714	6,302	\$1,080	136	\$23	4,304	\$738	####	\$1,842	0.05	0.1214	\$1,304.41
22	2037	0.1717	6,302	\$1,082	136	\$23	4,304	\$739	####	\$1,844	0.05	0.1217	\$1,307.11
23	2038	0.1720	6,302	\$1,084	136	\$23	4,304	\$740	####	\$1,847	0.05	0.1220	\$1,310.21
24	2039	0.1722	6,302	\$1,085	136	\$23	4,304	\$741	####	\$1,850	0.05	0.1222	\$1,312.92
25	2040	0.1724	6,302	\$1,086	136	\$23	4,304	\$742	####	\$1,852	0.05	0.1224	\$1,314.46
26	2041	0.1734	6,302	\$1,093	136	\$24	4,304	\$746	####	\$1,862	0.05	0.1234	\$1,325.17
27	2042	0.1744	6,302	\$1,099	136	\$24	4,304	\$750	####	\$1,873	0.05	0.1244	\$1,335.95
28	2043	0.1754	6,302	\$1,105	136	\$24	4,304	\$755	####	\$1,884	0.05	0.1254	\$1,346.78
29	2044	0.1764	6,302	\$1,112	136	\$24	4,304	\$759	####	\$1,895	0.05	0.1264	\$1,357.68
30	2045	0.1774	6,302	\$1,118	136	\$24	4,304	\$764	####	\$1,906	0.05	0.1274	\$1,368.64
31	2046	0.1784	6,302	\$1,125	136	\$24	4,304	\$768	####	\$1,917	0.05	0.1284	\$1,379.67
32	2047	0.1795	6,302	\$1,131	136	\$24	4,304	\$772	####	\$1,928	0.05	0.1295	\$1,390.75
33	2048	0.1805	6,302	\$1,138	136	\$25	4,304	\$777	####	\$1,939	0.05	0.1305	\$1,401.91
34	2049	0.1816	6,302	\$1,144	136	\$25	4,304	\$781	####	\$1,950	0.05	0.1316	\$1,413.12
35	2050	0.1826	6,302	\$1,151	136	\$25	4,304	\$786	####	\$1,962	0.05	0.1326	\$1,424.40
36	2051	0.1837	6,302	\$1,157	136	\$25	4,304	\$790	####	\$1,973	0.05	0.1337	\$1,435.75
37	2052	0.1847	6,302	\$1,164	136	\$25	4,304	\$795	####	\$1,984	0.05	0.1347	\$1,447.16
38	2053	0.1858	6,302	\$1,171	136	\$25	4,304	\$800	####	\$1,996	0.05	0.1358	\$1,458.64
39	2054	0.1869	6,302	\$1,178	136	\$25	4,304	\$804	####	\$2,007	0.05	0.1369	\$1,470.19
40	2055	0.1879	6,302	\$1,184	136	\$26	4,304	\$809	####	\$2,019	0.05	0.1379	\$1,481.80
41	2056	0.1890	6,302	\$1,191	136	\$26	4,304	\$814	####	\$2,031	0.05	0.1390	\$1,493.48
42	2057	0.1901	6,302	\$1,198	136	\$26	4,304	\$818	####	\$2,042	0.05	0.1401	\$1,505.23
43	2058	0.1912	6,302	\$1,205	136	\$26	4,304	\$823	####	\$2,054	0.05	0.1412	\$1,517.04
44	2059	0.1923	6,302	\$1,212	136	\$26	4,304	\$828	####	\$2,066	0.05	0.1423	\$1,528.92
45	2060	0.1934	6,302	\$1,219	136	\$26	4,304	\$833	####	\$2,078	0.05	0.1434	\$1,540.87
46	2061	0.1946	6,302	\$1,226	136	\$26	4,304	\$837	####	\$2,090	0.05	0.1446	\$1,552.90
47	2062	0.1957	6,302	\$1,233	136	\$27	4,304	\$842	####	\$2,102	0.05	0.1457	\$1,564.99
48	2063	0.1968	6,302	\$1,240	136	\$27	4,304	\$847	####	\$2,114	0.05	0.1468	\$1,577.15
49	2064	0.1980	6,302	\$1,248	136	\$27	4,304	\$852	####	\$2,126	0.05	0.1480	\$1,589.38
50	2065	0.1991	6,302	\$1,255	136	\$27	4,304	\$857	####	\$2,139	0.05	0.1491	\$1,601.68
51	2066	0.2003	6,302	\$1,262	136	\$27	4,304	\$862	####	\$2,151	0.05	0.1503	\$1,614.05
52	2067	0.2014	6,302	\$1,269	136	\$27	4,304	\$867	####	\$2,164	0.05	0.1514	\$1,626.49
53	2068	0.2026	6,302	\$1,277	136	\$28	4,304	\$872	####	\$2,176	0.05	0.1526	\$1,639.01
54	2069	0.2038	6,302	\$1,284	136	\$28	4,304	\$877	####	\$2,189	0.05	0.1538	\$1,651.60
55	2070	0.2049	6,302	\$1,291	136	\$28	4,304	\$882	####	\$2,201	0.05	0.1549	\$1,664.26
56	2071	0.2061	6,302	\$1,299	136	\$28	4,304	\$887	####	\$2,214	0.05	0.1561	\$1,676.99
57	2072	0.2073	6,302	\$1,306	136	\$28	4,304	\$892	####	\$2,227	0.05	0.1573	\$1,689.80
58	2073	0.2085	6,302	\$1,314	136	\$28	4,304	\$897	####	\$2,240	0.05	0.1585	\$1,702.69
59	2074	0.2097	6,302	\$1,322	136	\$29	4,304	\$903	####	\$2,253	0.05	0.1597	\$1,715.64
60	2075	0.2109	6,302	\$1,329	136	\$29	4,304	\$908	####	\$2,266	0.05	0.1609	\$1,728.67

Table D2-1.80: Annual Operating Costs (H.GSHP) of a 2,000 square feet detached house above grade (improved construction type) in the city of Timmins (two life cycles and three life cycles for a 60 year project lifespan); base case scenario in comparison with feed in-tariff (FIT) scenario. In the FIT scenario, an incentive of \$0.05/KWh is provided on electricity bills throughout the project lifespan

Traditional HVAC Applications

Base Case Scenario																	Carbon Taxes					
#	Year	Electricity Rates \$/KWh	Natural Gas Rates \$/m ³	Heating		Heating Operating Cost \$ (Electricity)	Heating Operating Cost \$ (Gas)	Total Heating Operating Cost \$	Cooling		Hot Water m ³	Hot Water Operating Cost \$	Total KWh	Total m ³	Total Electricity Operating Cost \$ (KWh)	Total Natural Gas Operating Cost \$ (m ³)	Total	Conversion of m ³ into Tons	Total Tons	Carbon Tax	Operating Costs	
				KWh (Electricity)	m ³ (Gas)				KWh	Operating Cost												
1	2016	0.1501	0.3458	2,321	2,896	\$348	\$1,002	\$1,350	684	\$103	1,051	\$363	3,005	3,947	451	\$1,365	\$1,816	7.14	7.14	\$10	\$71.44	\$1,887.43
2	2017	0.1542	0.3588	2,321	2,896	\$358	\$1,039	\$1,397	684	\$105	1,051	\$162	3,005	3,947	463	\$1,416	\$1,880	7.14	7.14	\$20	\$142.88	\$2,022.54
3	2018	0.1583	0.3718	2,321	2,896	\$367	\$1,077	\$1,444	684	\$108	1,051	\$166	3,005	3,947	476	\$1,468	\$1,943	7.14	7.14	\$30	\$214.32	\$2,157.65
4	2019	0.1625	0.3776	2,321	2,896	\$377	\$1,093	\$1,471	684	\$111	1,051	\$171	3,005	3,947	488	\$1,490	\$1,979	7.14	7.14	\$40	\$285.76	\$2,264.51
5	2020	0.1668	0.3841	2,321	2,896	\$387	\$1,112	\$1,499	684	\$114	1,051	\$175	3,005	3,947	501	\$1,516	\$2,017	7.14	7.14	\$50	\$357.20	\$2,374.38
6	2021	0.1621	0.3883	2,321	2,896	\$376	\$1,124	\$1,501	684	\$111	1,051	\$170	3,005	3,947	487	\$1,533	\$2,020	7.14	7.14	\$60	\$428.64	\$2,448.48
7	2022	0.1629	0.3929	2,321	2,896	\$378	\$1,138	\$1,516	684	\$111	1,051	\$171	3,005	3,947	490	\$1,551	\$2,040	7.14	7.14	\$70	\$500.08	\$2,540.42
8	2023	0.1639	0.3967	2,321	2,896	\$380	\$1,149	\$1,529	684	\$112	1,051	\$172	3,005	3,947	492	\$1,566	\$2,058	7.14	7.14	\$80	\$571.53	\$2,629.77
9	2024	0.1648	0.4005	2,321	2,896	\$383	\$1,160	\$1,542	684	\$113	1,051	\$173	3,005	3,947	495	\$1,581	\$2,076	7.14	7.14	\$90	\$642.97	\$2,719.12
10	2025	0.1656	0.4040	2,321	2,896	\$384	\$1,170	\$1,554	684	\$113	1,051	\$174	3,005	3,947	498	\$1,595	\$2,092	7.14	7.14	\$100	\$714.41	\$2,806.53
11	2026	0.1665	0.4070	2,321	2,896	\$387	\$1,179	\$1,565	684	\$114	1,051	\$175	3,005	3,947	500	\$1,607	\$2,107	7.14	7.14	\$110	\$785.85	\$2,892.87
12	2027	0.1674	0.4097	2,321	2,896	\$389	\$1,187	\$1,575	684	\$115	1,051	\$176	3,005	3,947	503	\$1,617	\$2,120	7.14	7.14	\$120	\$857.29	\$2,977.58
13	2028	0.1683	0.4124	2,321	2,896	\$391	\$1,194	\$1,585	684	\$115	1,051	\$177	3,005	3,947	506	\$1,628	\$2,133	7.14	7.14	\$130	\$928.73	\$3,062.08
14	2029	0.1692	0.4151	2,321	2,896	\$393	\$1,202	\$1,595	684	\$116	1,051	\$178	3,005	3,947	508	\$1,638	\$2,147	7.14	7.14	\$140	\$1,000.17	\$3,146.80
15	2030	0.1701	0.4170	2,321	2,896	\$395	\$1,208	\$1,602	684	\$116	1,051	\$179	3,005	3,947	511	\$1,646	\$2,157	7.14	7.14	\$150	\$1,071.61	\$3,228.60
16	2031	0.1704	0.4189	2,321	2,896	\$395	\$1,213	\$1,609	684	\$117	1,051	\$179	3,005	3,947	512	\$1,653	\$2,165	7.14	7.14	\$160	\$1,143.05	\$3,308.35
17	2032	0.1705	0.4204	2,321	2,896	\$396	\$1,218	\$1,613	684	\$117	1,051	\$179	3,005	3,947	512	\$1,659	\$2,172	7.14	7.14	\$170	\$1,214.49	\$3,386.26
18	2033	0.1707	0.4223	2,321	2,896	\$396	\$1,223	\$1,619	684	\$117	1,051	\$179	3,005	3,947	513	\$1,667	\$2,180	7.14	7.14	\$180	\$1,285.93	\$3,466.01
19	2034	0.1710	0.4246	2,321	2,896	\$397	\$1,230	\$1,627	684	\$117	1,051	\$180	3,005	3,947	514	\$1,676	\$2,190	7.14	7.14	\$190	\$1,357.37	\$3,547.37
20	2035	0.1713	0.4265	2,321	2,896	\$398	\$1,235	\$1,633	684	\$117	1,051	\$180	3,005	3,947	515	\$1,684	\$2,198	7.14	7.14	\$200	\$1,428.81	\$3,627.12
21	2036	0.1714	0.4288	2,321	2,896	\$398	\$1,242	\$1,640	684	\$117	1,051	\$180	3,005	3,947	515	\$1,693	\$2,208	7.14	7.14	\$210	\$1,500.25	\$3,708.05
22	2037	0.1717	0.4311	2,321	2,896	\$399	\$1,249	\$1,647	684	\$117	1,051	\$180	3,005	3,947	516	\$1,702	\$2,218	7.14	7.14	\$220	\$1,571.70	\$3,789.11
23	2038	0.1720	0.4331	2,321	2,896	\$399	\$1,254	\$1,653	684	\$118	1,051	\$181	3,005	3,947	517	\$1,709	\$2,226	7.14	7.14	\$230	\$1,643.14	\$3,869.17
24	2039	0.1722	0.4353	2,321	2,896	\$400	\$1,261	\$1,660	684	\$118	1,051	\$181	3,005	3,947	518	\$1,718	\$2,236	7.14	7.14	\$240	\$1,714.58	\$3,950.42
25	2040	0.1724	0.4376	2,321	2,896	\$400	\$1,267	\$1,667	684	\$118	1,051	\$181	3,005	3,947	518	\$1,727	\$2,245	7.14	7.14	\$250	\$1,786.02	\$4,031.36
26	2041	0.1734	0.4420	2,321	2,896	\$402	\$1,280	\$1,682	684	\$119	1,051	\$182	3,005	3,947	521	\$1,744	\$2,265	7.14	7.14	\$260	\$1,857.46	\$4,112.83
27	2042	0.1744	0.4463	2,321	2,896	\$405	\$1,293	\$1,697	684	\$119	1,051	\$183	3,005	3,947	524	\$1,762	\$2,286	7.14	7.14	\$270	\$1,928.90	\$4,194.48
28	2043	0.1754	0.4507	2,321	2,896	\$407	\$1,305	\$1,712	684	\$120	1,051	\$184	3,005	3,947	527	\$1,779	\$2,306	7.14	7.14	\$280	\$2,000.34	\$4,276.33
29	2044	0.1764	0.4552	2,321	2,896	\$409	\$1,318	\$1,728	684	\$121	1,051	\$185	3,005	3,947	530	\$1,797	\$2,327	7.14	7.14	\$290	\$2,071.78	\$4,358.35
30	2045	0.1774	0.4596	2,321	2,896	\$412	\$1,331	\$1,743	684	\$121	1,051	\$186	3,005	3,947	533	\$1,814	\$2,347	7.14	7.14	\$300	\$2,143.22	\$4,440.56
31	2046	0.1784	0.4642	2,321	2,896	\$414	\$1,344	\$1,758	684	\$122	1,051	\$188	3,005	3,947	536	\$1,832	\$2,368	7.14	7.14	\$310	\$2,214.66	\$4,522.98
32	2047	0.1795	0.4698	2,321	2,896	\$417	\$1,358	\$1,774	684	\$123	1,051	\$189	3,005	3,947	539	\$1,850	\$2,389	7.14	7.14	\$320	\$2,286.10	\$4,605.58
33	2048	0.1805	0.4734	2,321	2,896	\$419	\$1,371	\$1,790	684	\$123	1,051	\$190	3,005	3,947	542	\$1,868	\$2,411	7.14	7.14	\$330	\$2,357.54	\$4,688.38
34	2049	0.1816	0.4780	2,321	2,896	\$421	\$1,384	\$1,806	684	\$124	1,051	\$191	3,005	3,947	546	\$1,887	\$2,432	7.14	7.14	\$340	\$2,428.98	\$4,771.38
35	2050	0.1826	0.4828	2,321	2,896	\$424	\$1,398	\$1,822	684	\$125	1,051	\$192	3,005	3,947	549	\$1,905	\$2,454	7.14	7.14	\$350	\$2,500.42	\$4,854.58
36	2051	0.1837	0.4875	2,321	2,896	\$426	\$1,412	\$1,838	684	\$126	1,051	\$193	3,005	3,947	552	\$1,924	\$2,476	7.14	7.14	\$360	\$2,571.87	\$4,937.98
37	2052	0.1847	0.4923	2,321	2,896	\$429	\$1,426	\$1,854	684	\$126	1,051	\$194	3,005	3,947	555	\$1,943	\$2,498	7.14	7.14	\$370	\$2,643.31	\$5,021.58
38	2053	0.1858	0.4972	2,321	2,896	\$431	\$1,440	\$1,871	684	\$127	1,051	\$195	3,005	3,947	558	\$1,962	\$2,521	7.14	7.14	\$380	\$2,714.75	\$5,105.39
39	2054	0.1869	0.5021	2,321	2,896	\$434	\$1,454	\$1,888	684	\$128	1,051	\$196	3,005	3,947	562	\$1,982	\$2,543	7.14	7.14	\$390	\$2,786.19	\$5,189.41
40	2055	0.1879	0.5070	2,321	2,896	\$436	\$1,468	\$1,905	684	\$129	1,051	\$198	3,005	3,947	565	\$2,001	\$2,566	7.14	7.14	\$400	\$2,857.63	\$5,273.64
41	2056	0.1890	0.5120	2,321	2,896	\$439	\$1,483	\$1,922	684	\$129	1,051	\$199	3,005	3,947	568	\$2,021	\$2,589	7.14	7.14	\$410	\$2,929.07	\$5,358.08
42	2057	0.1901	0.5171	2,321	2,896	\$441	\$1,497	\$1,939	684	\$130	1,051	\$200	3,005	3,947	571	\$2,041	\$2,612	7.14	7.14	\$420	\$3,000.51	\$5,442.73
43	2058	0.1912	0.5222	2,321	2,896	\$444	\$1,512	\$1,956	684	\$131	1,051	\$201	3,005	3,947	575	\$2,061	\$2,636	7.14	7.14	\$430	\$3,071.95	\$5,527.59
44	2059	0.1923	0.5273	2,321	2,896	\$446	\$1,527	\$1,974	684	\$132	1,051	\$202	3,005	3,947	578	\$2,081	\$2,659	7.14	7.14	\$440	\$3,143.39	\$5,612.68
45	2060	0.1934	0.5325	2,321	2,896	\$449	\$1,542	\$1,991	684	\$132	1,051	\$203	3,005	3,947	581	\$2,102	\$2,683	7.14	7.14	\$450	\$3,214.83	\$5,697.98
46	2061	0.1946	0.5378	2,321	2,896	\$452	\$1,557	\$2,009	684	\$133	1,051	\$204	3,005	3,947	585	\$2,123	\$2,707	7.14	7.14	\$460	\$3,286.27	\$5,783.51
47	2062	0.1957	0.5431	2,321	2,896	\$454	\$1,573	\$2,027	684	\$134	1,051	\$206	3,005	3,947	588	\$2,144	\$2,732	7.14	7.14	\$470	\$3,357.71	\$5,869.26
48	2063	0.1968	0.5484	2,321	2,896	\$457	\$1,588	\$2,045	684	\$135	1,051	\$207	3,005	3,947	591	\$2,165	\$2,756	7.14	7.14	\$480	\$3,429.15	\$5,955.23
49	2064	0.1980	0.5538	2,321	2,896	\$459	\$1,604	\$2,063	684	\$135	1,051	\$208	3,005	3,947	595	\$2,186	\$2,781	7.14	7.14	\$490	\$3,500.59	\$6,041.44
50	2065	0.1991	0.5593	2,321	2,896	\$462	\$1,620	\$2,082	684	\$136	1,051	\$209	3,005	3,947	598	\$2,208	\$2,806	7.14	7.14	\$500	\$3,572.04	\$6,127.87
51	2066	0.2003	0.5648	2,321	2,896	\$465	\$1,636	\$2,100	684	\$137	1,051	\$210	3,005	3,947	602	\$2,229	\$2,831	7.14	7.14	\$510	\$3,643.48	\$6,214.54
52	2067	0.2014	0.5704	2,321	2,896	\$467	\$1,652	\$2,119	684	\$138	1,051	\$213	3,005	3,947	605	\$2,251	\$2,857	7.14	7.14	\$520	\$3,714.92	\$6,301.44
53	2068	0.2026	0.5760	2,321	2,896	\$470	\$1,668	\$2,138	684	\$139	1,051	\$213	3,005	3,947	609	\$2,273	\$2,882	7.14	7.14	\$530	\$3,786.36	\$6,388.57
54	2069																					

Appendix E1 – Economic Variation of HVAC Technologies for Different Scenarios Based on Present Value at Various Discount Factors – Average Construction Type

1. Two Life Cycles of V.GSHP and H.GSHP and Five Life Cycles of Traditional HVAC Applications @ 5% Discount Rate

Base Case Scenario

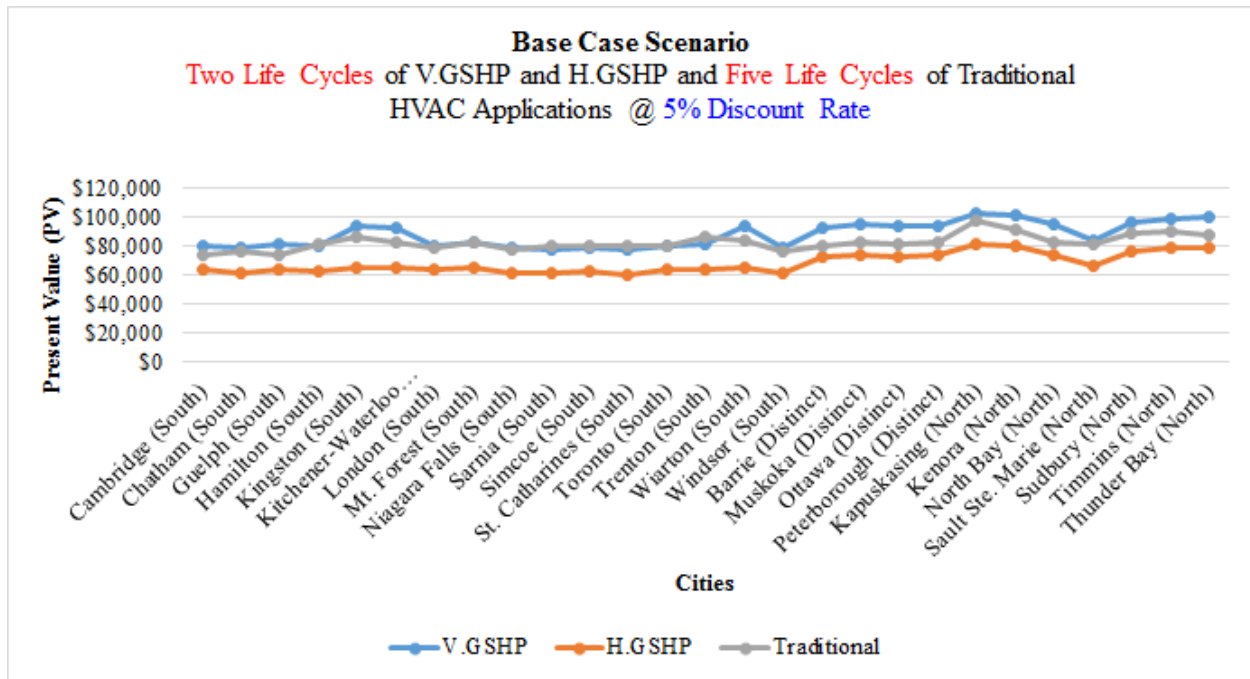

Table E1-1.1: Economic Variation of HVAC technologies for base case scenario (average construction type) at a discount rate of 5% (two life cycles of V.GSHP and H.GSHP and five life cycles of Traditional HVAC Applications for a 60 year project lifespan)

Carbon Taxes – (#1)

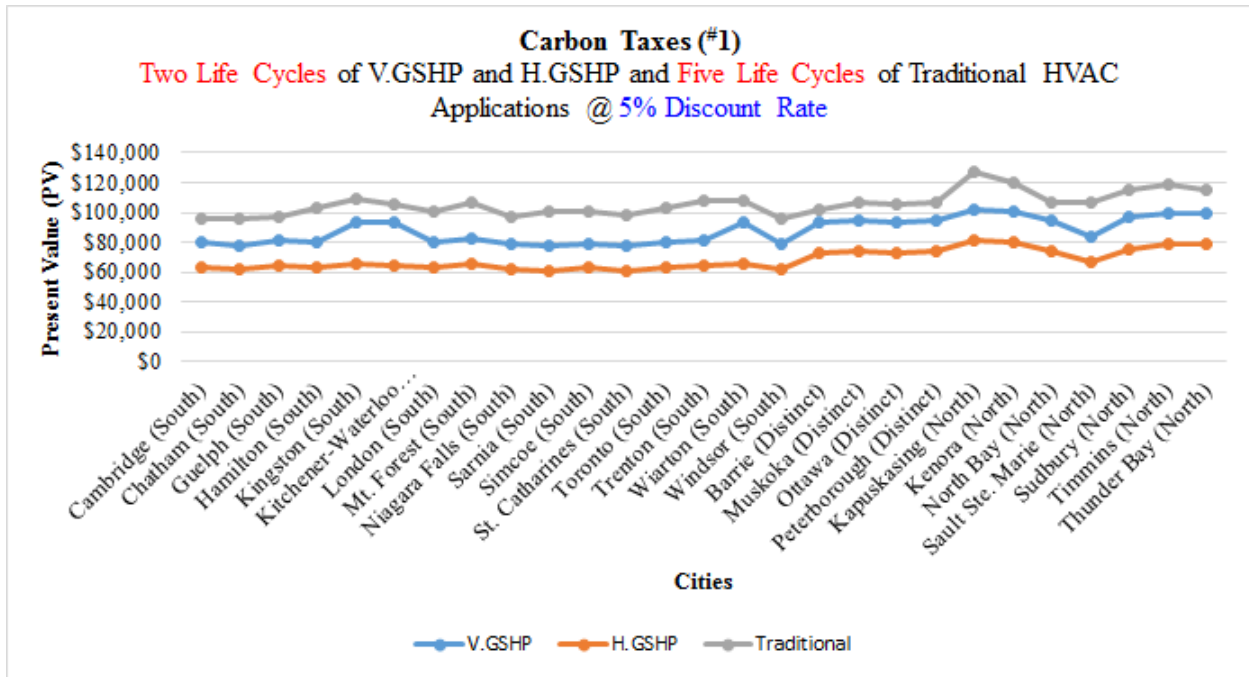

Table E1-1.2: Economic Variation of HVAC technologies for carbon taxes scenario (average construction type) at a discount rate of 5% (two life cycles of V.GSHP and H.GSHP and five life cycles of Traditional HVAC Applications for a 60 year project lifespan)

FIT – (#2)

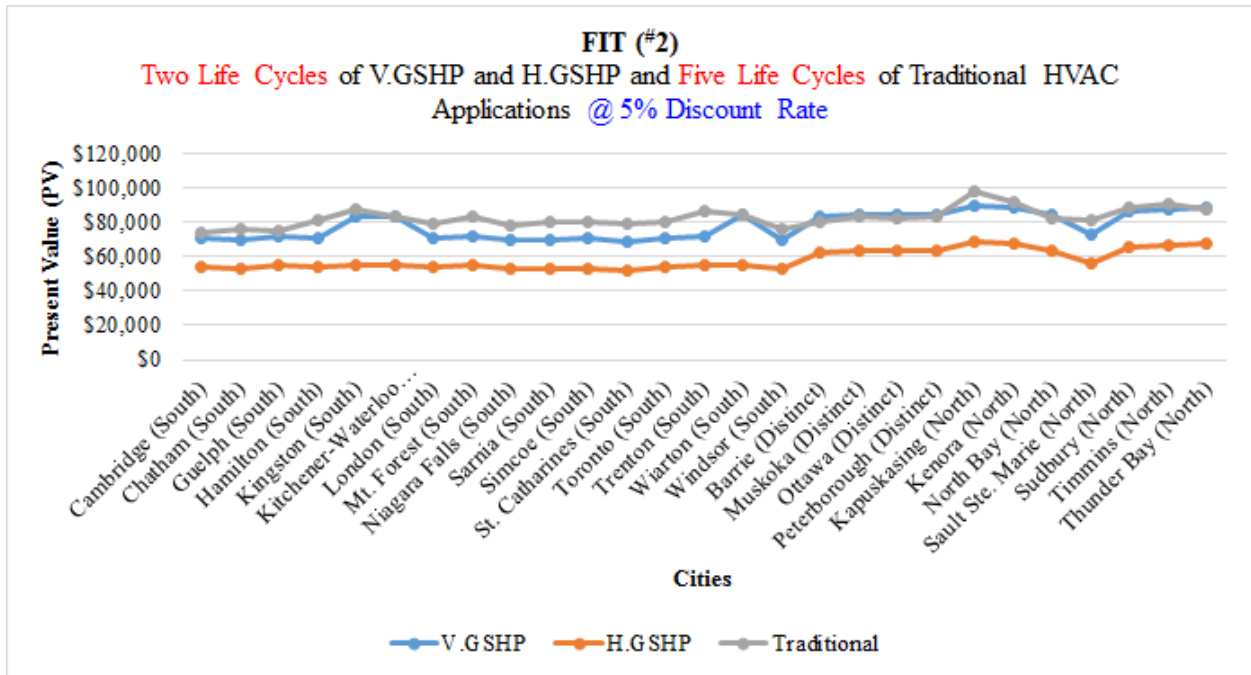

Table E1-1.3: Economic Variation of HVAC technologies for feed-in tariff scenario (average construction type) at a discount rate of 5% (two life cycles of V.GSHP and H.GSHP and five life cycles of Traditional HVAC Applications for a 60 year project lifespan)

Rebates – (#3)

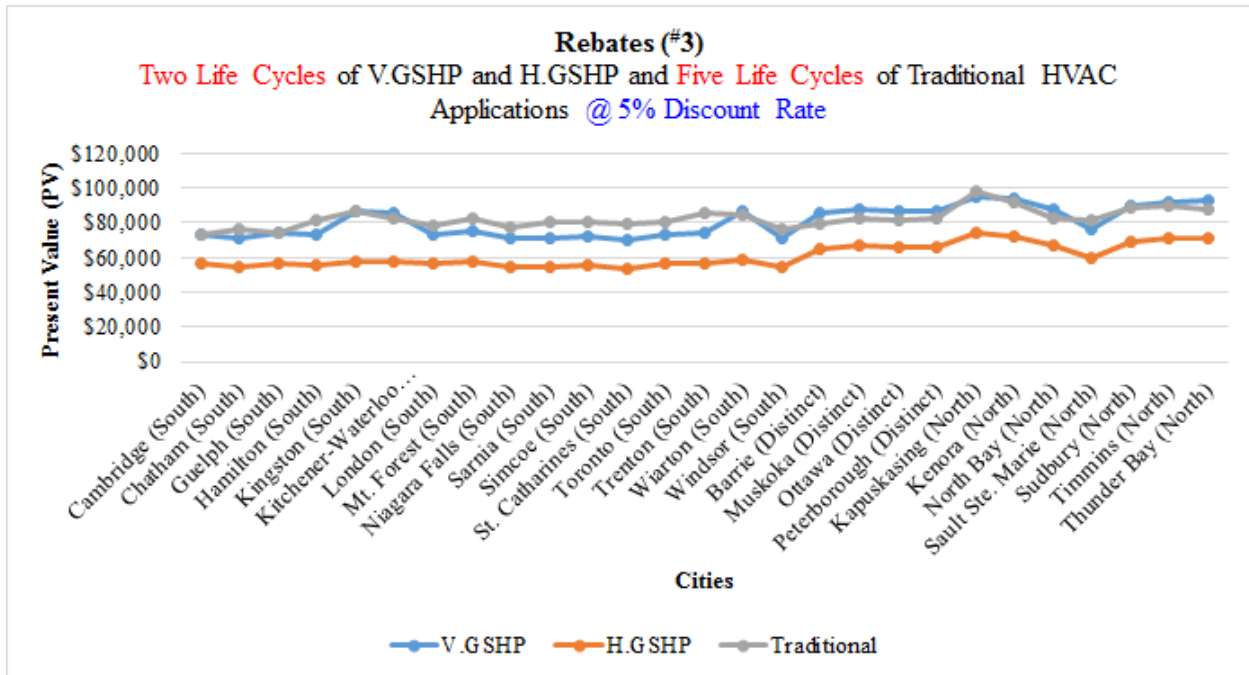

Table E1-1.4: Economic Variation of HVAC technologies for rebates scenario (average construction type) at a discount rate of 5% (two life cycles of V.GSHP and H.GSHP and five life cycles of Traditional HVAC Applications for a 60 year project lifespan)

FIT + Rebates – (#4)

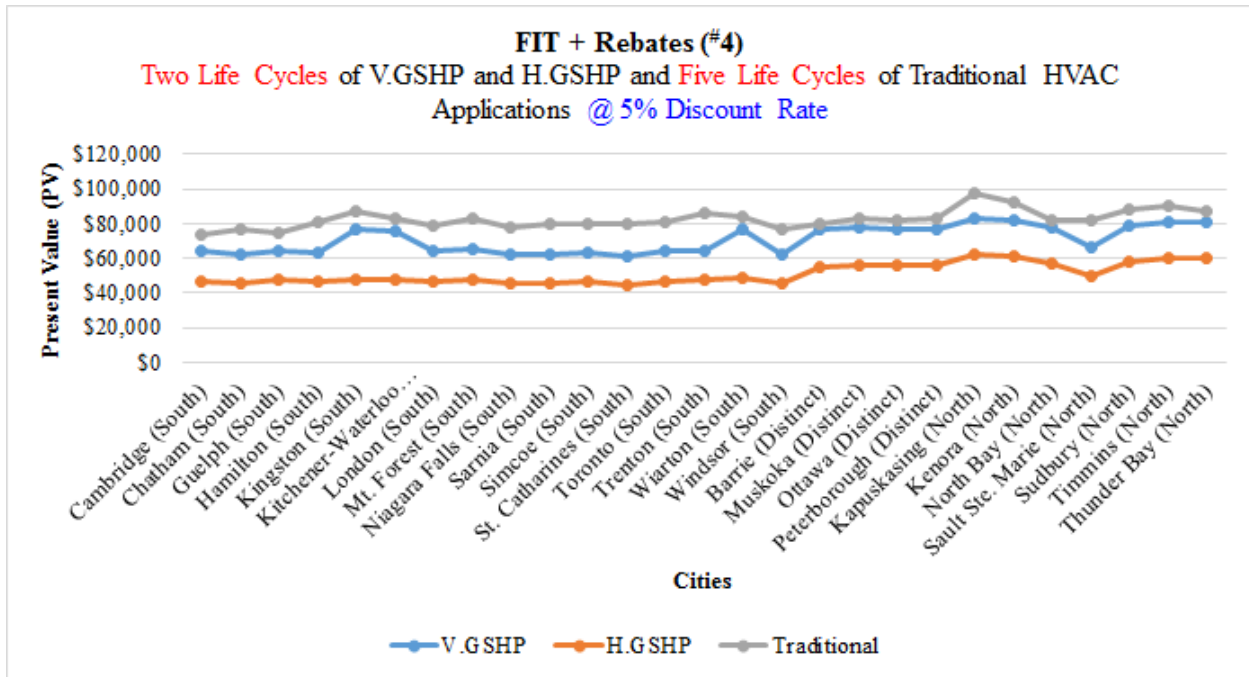

Table E1-1.5: Economic Variation of HVAC technologies for feed-in tariff + rebates scenario (average construction type) at a discount rate of 5% (two life cycles of V.GSHP and H.GSHP and five life cycles of Traditional HVAC Applications for a 60 year project lifespan)

(FIT + Rebates) + Carbon Taxes – (#5)

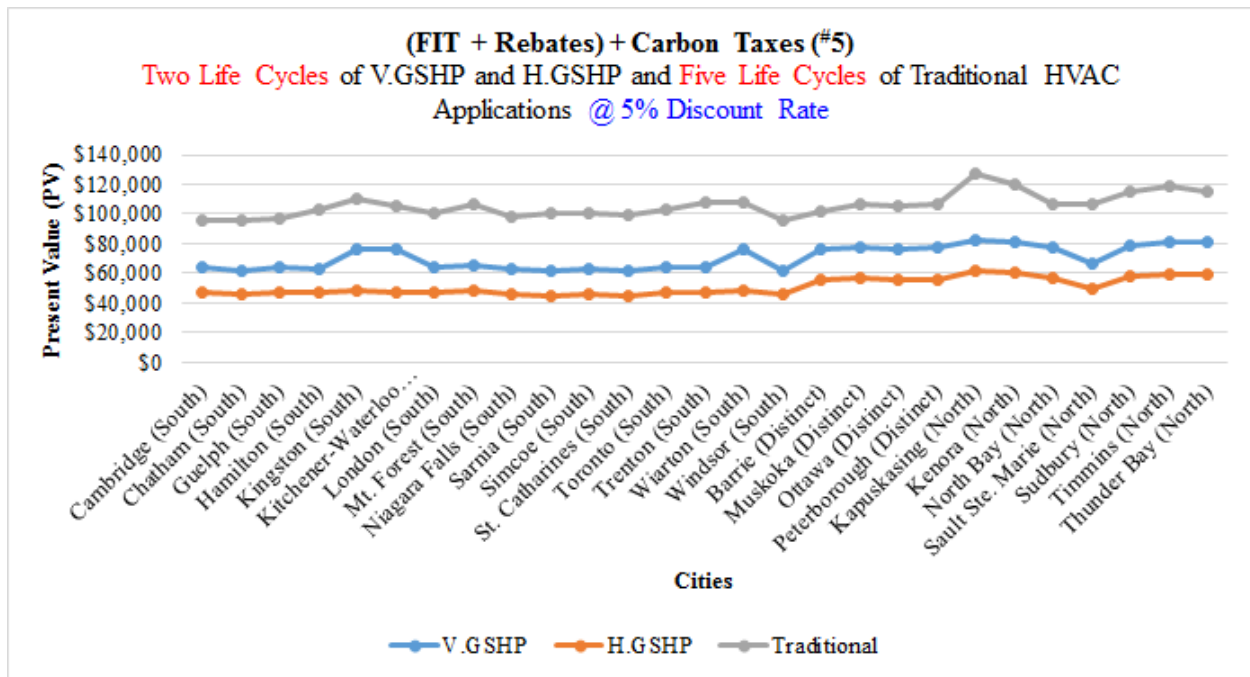

Table E1-1.6: Economic Variation of HVAC technologies for feed-in tariff + rebates + carbon tax scenario (average construction type) at a discount rate of 5% (two life cycles of V.GSHP and H.GSHP and five life cycles of Traditional HVAC Applications for a 60 year project lifespan)

2. Two Life Cycles of V.GSHP and H.GSHP and Five Life Cycles of Traditional HVAC Applications @ 7% Discount Rate

Base Case Scenario

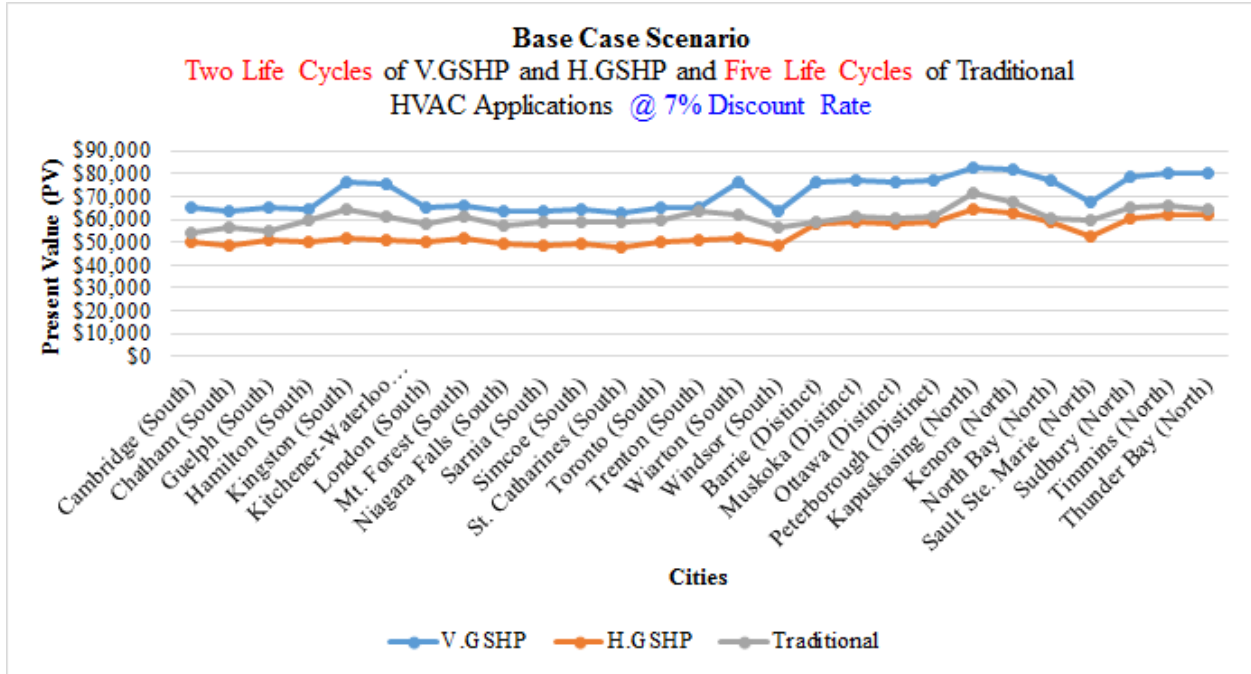

Table E1-1.7: Economic Variation of HVAC technologies for base case scenario (average construction type) at a discount rate of 7% (two life cycles of V.GSHP and H.GSHP and five life cycles of Traditional HVAC Applications for a 60 year project lifespan)

Carbon Taxes – (#1)

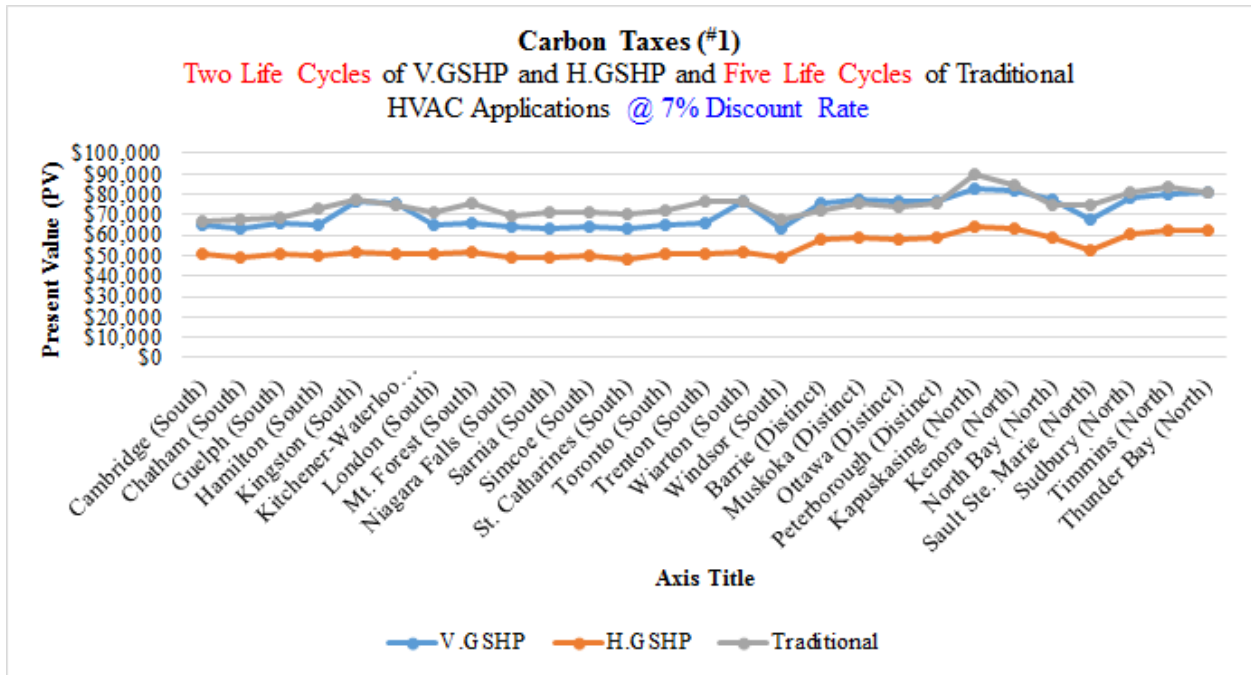

Table E1-1.8: Economic Variation of HVAC technologies for carbon taxes scenario (average construction type) at a discount rate of 7% (two life cycles of V.GSHP and H.GSHP and five life cycles of Traditional HVAC Applications for a 60 year project lifespan)

FIT – (#2)

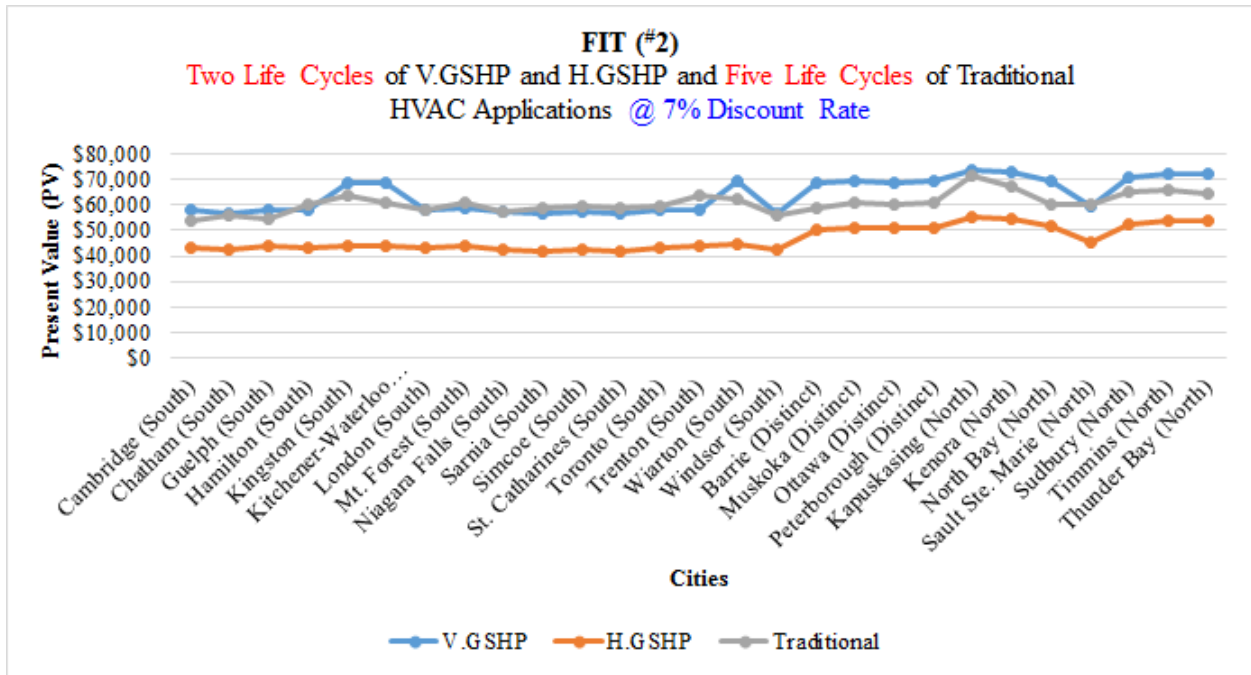

Table E1-1.9: Economic Variation of HVAC technologies for feed-in tariff scenario (average construction type) at a discount rate of 7% (two life cycles of V.GSHP and H.GSHP and five life cycles of Traditional HVAC Applications for a 60 year project lifespan)

Rebates – (#3)

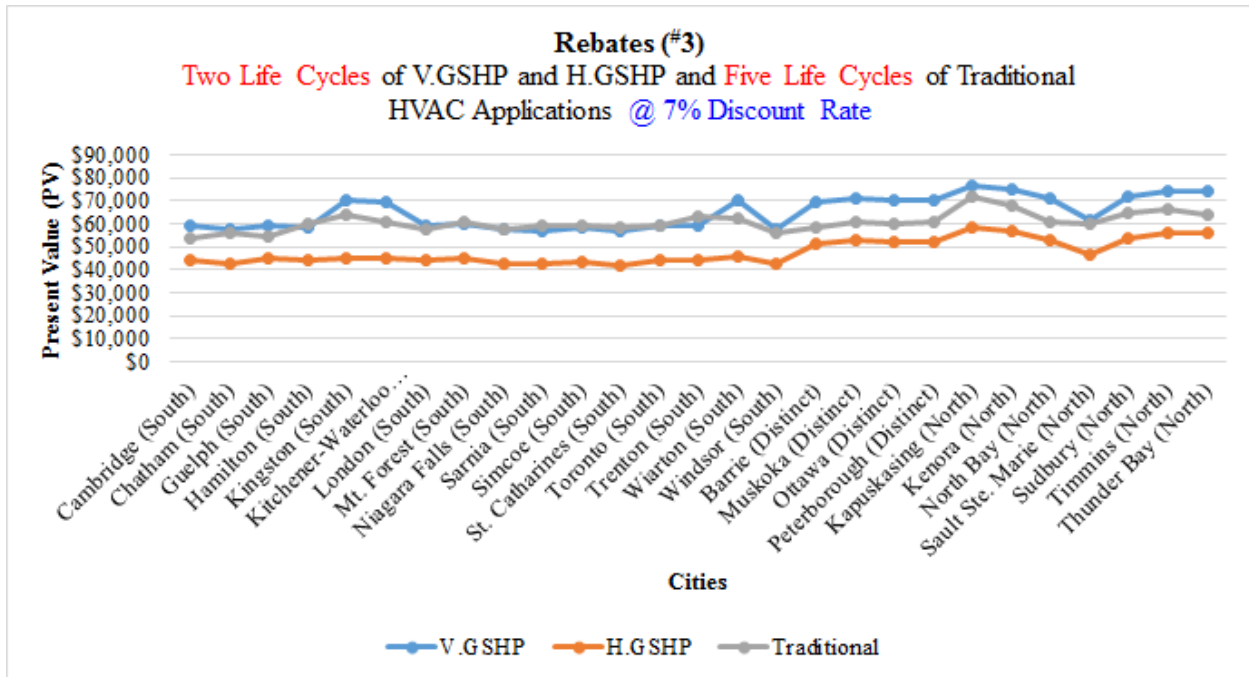

Table E1-1.10: Economic Variation of HVAC technologies for rebates scenario (average construction type) at a discount rate of 7% (two life cycles of V.GSHP and H.GSHP and five life cycles of Traditional HVAC Applications for a 60 year project lifespan)

FIT + Rebates – (#4)

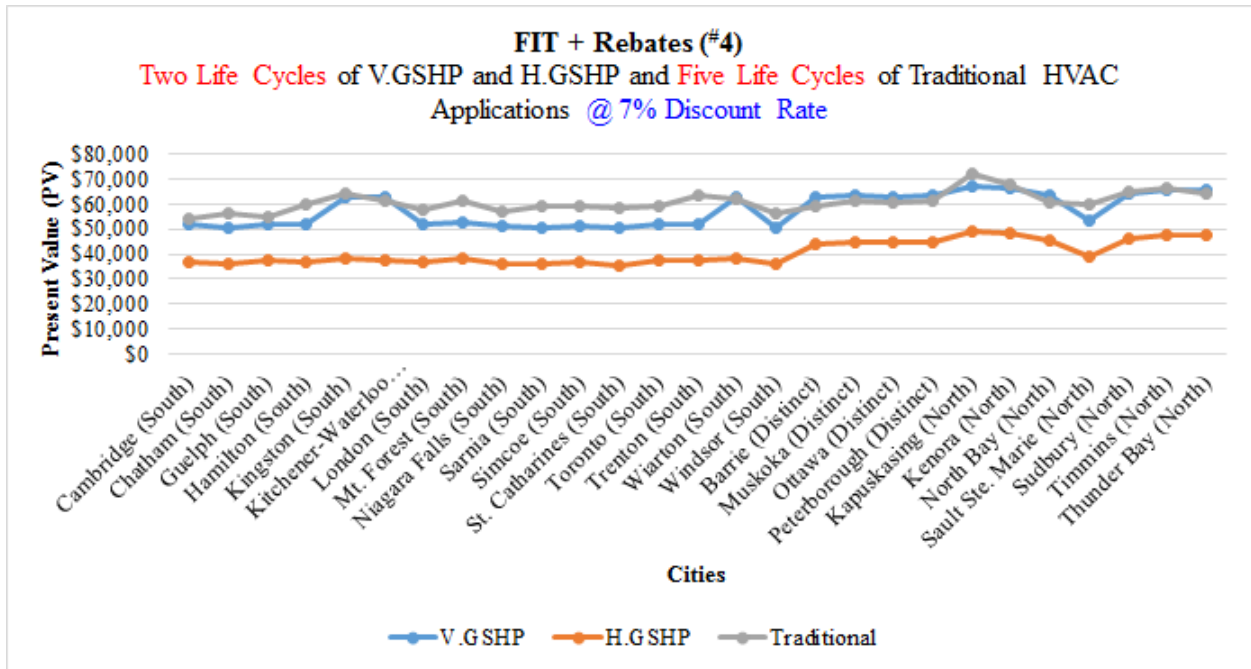

Table E1-1.11: Economic Variation of HVAC technologies for feed-in tariff + rebates scenario (average construction type) at a discount rate of 7% (two life cycles of V.GSHP and H.GSHP and five life cycles of Traditional HVAC Applications for a 60 year project lifespan)

(FIT + Rebates) + Carbon Taxes – (#5)

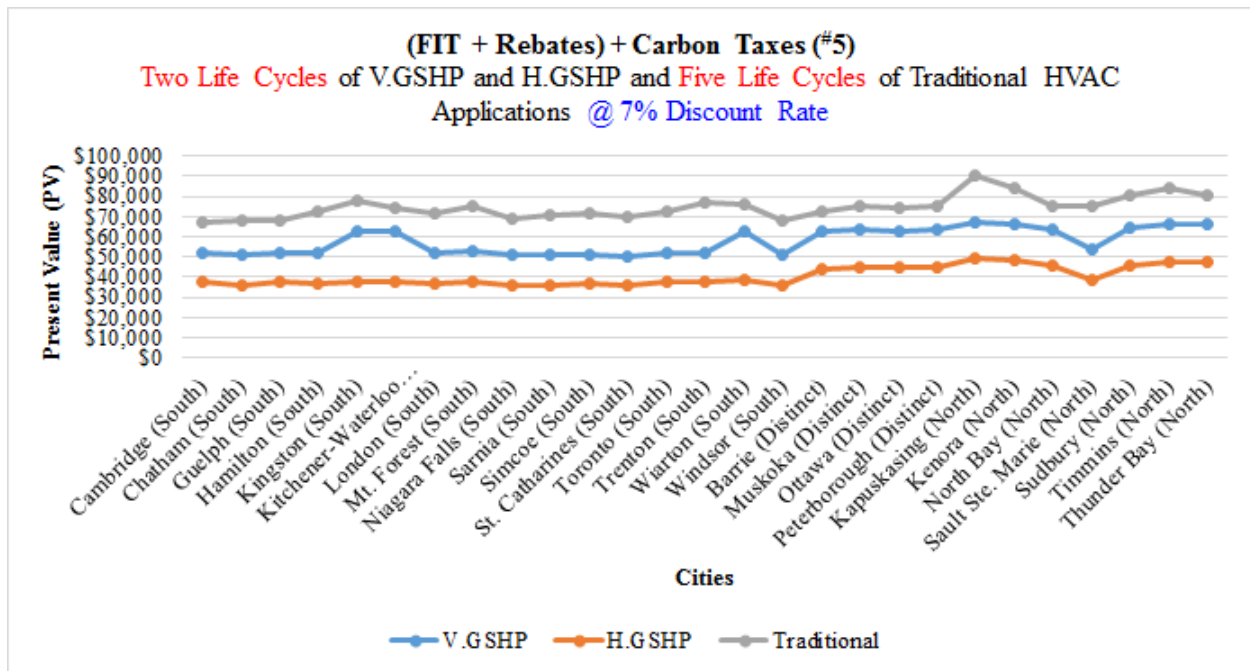

Table E1-1.12: Economic Variation of HVAC technologies for feed-in tariff + rebates + carbon tax scenario (average construction type) at a discount rate of 7% (two life cycles of V.GSHP and H.GSHP and five life cycles of Traditional HVAC Applications for a 60 year project lifespan)

3. Two Life Cycles of V.GSHP and H.GSHP and Five Life Cycles of Traditional HVAC Applications @ 7.5% Discount Rate

Base Case Scenario

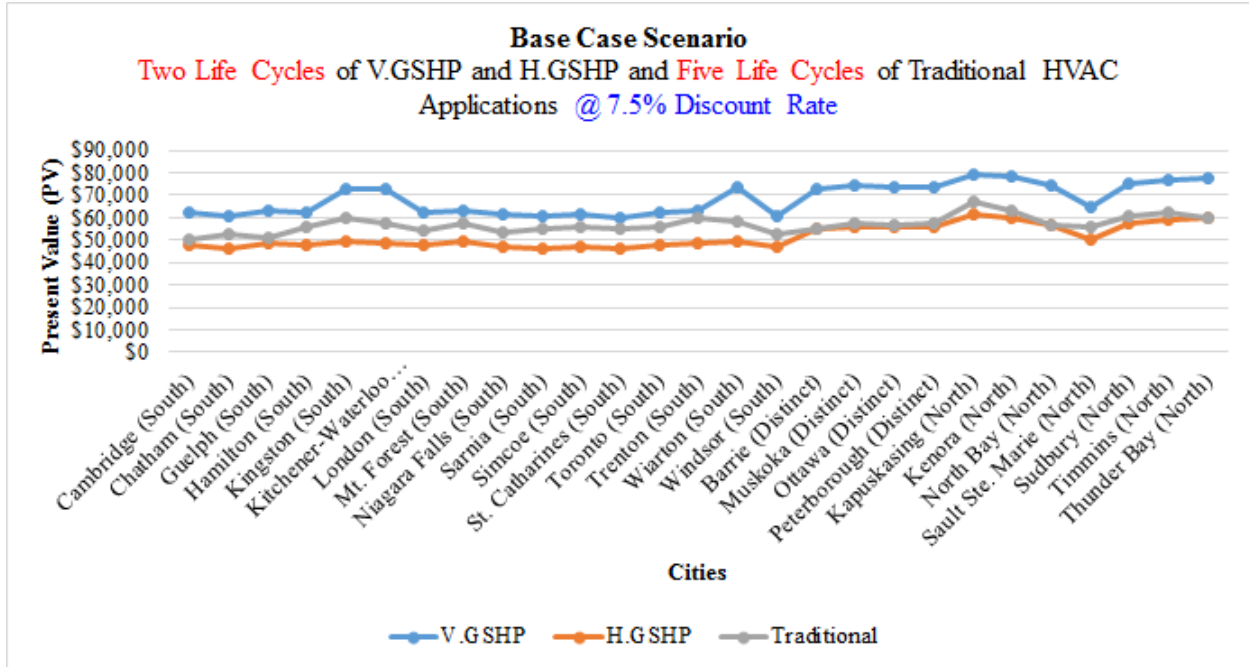

Table E1-1.13: Economic Variation of HVAC technologies for base case scenario (average construction type) at a discount rate of 7.5% (two life cycles of V.GSHP and H.GSHP and five life cycles of Traditional HVAC Applications for a 60 year project lifespan)

Carbon Taxes – (#1)

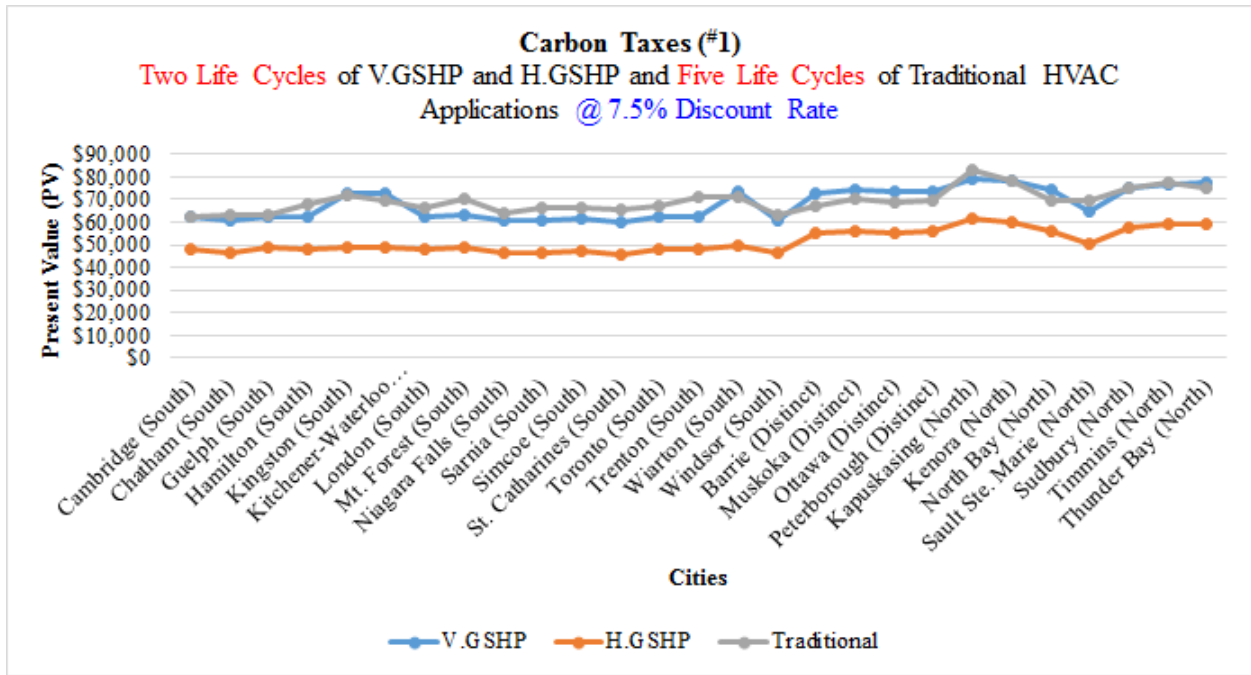

Table E1-1.14: Economic Variation of HVAC technologies for carbon taxes scenario (average construction type) at a discount rate of 7.5% (two life cycles of V.GSHP and H.GSHP and five life cycles of Traditional HVAC Applications for a 60 year project lifespan)

FIT – (#2)

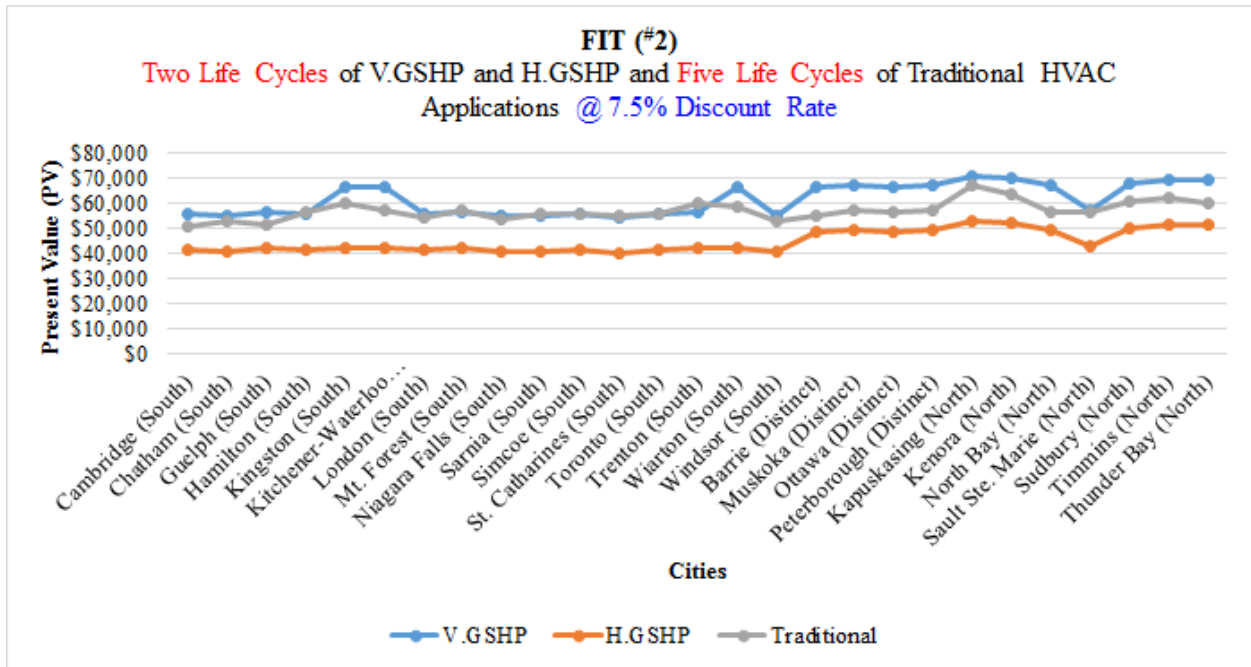

Table E1-1.15: Economic Variation of HVAC technologies for feed-in tariff scenario (average construction type) at a discount rate of 7.5% (two life cycles of V.GSHP and H.GSHP and five life cycles of Traditional HVAC Applications for a 60 year project lifespan)

Rebates – (#3)

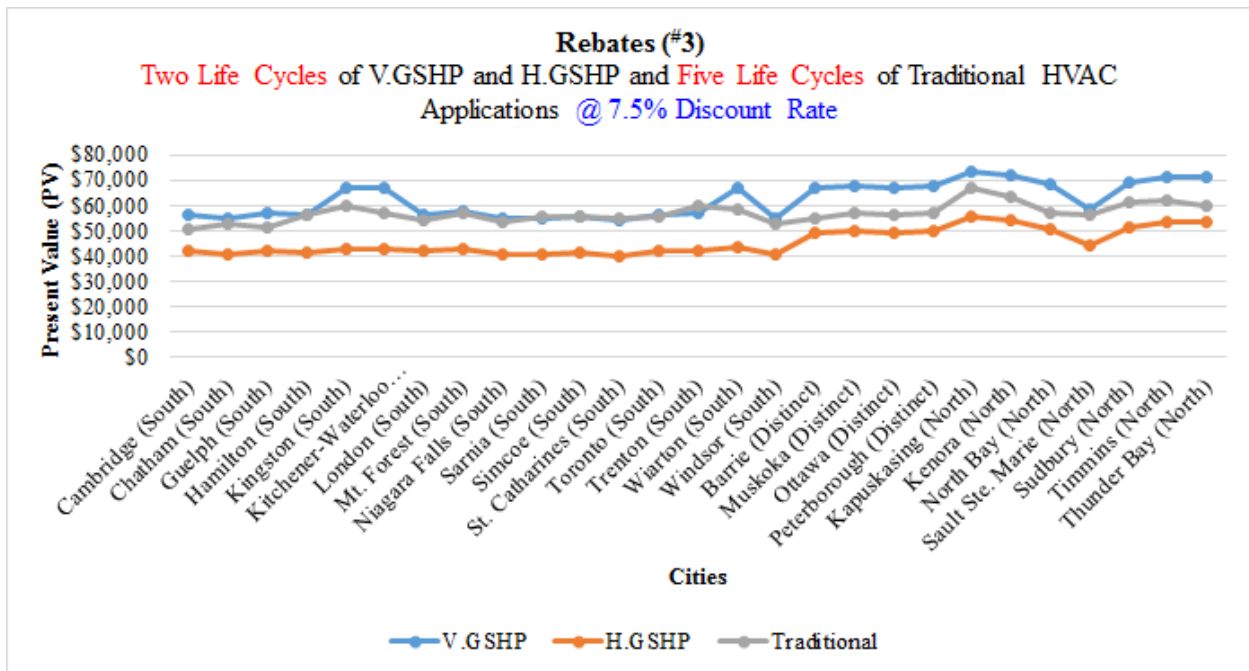

Table E1-1.16: Economic Variation of HVAC technologies for rebates scenario (average construction type) at a discount rate of 7.5% (two life cycles of V.GSHP and H.GSHP and five life cycles of Traditional HVAC Applications for a 60 year project lifespan)

FIT + Rebates – (#4)

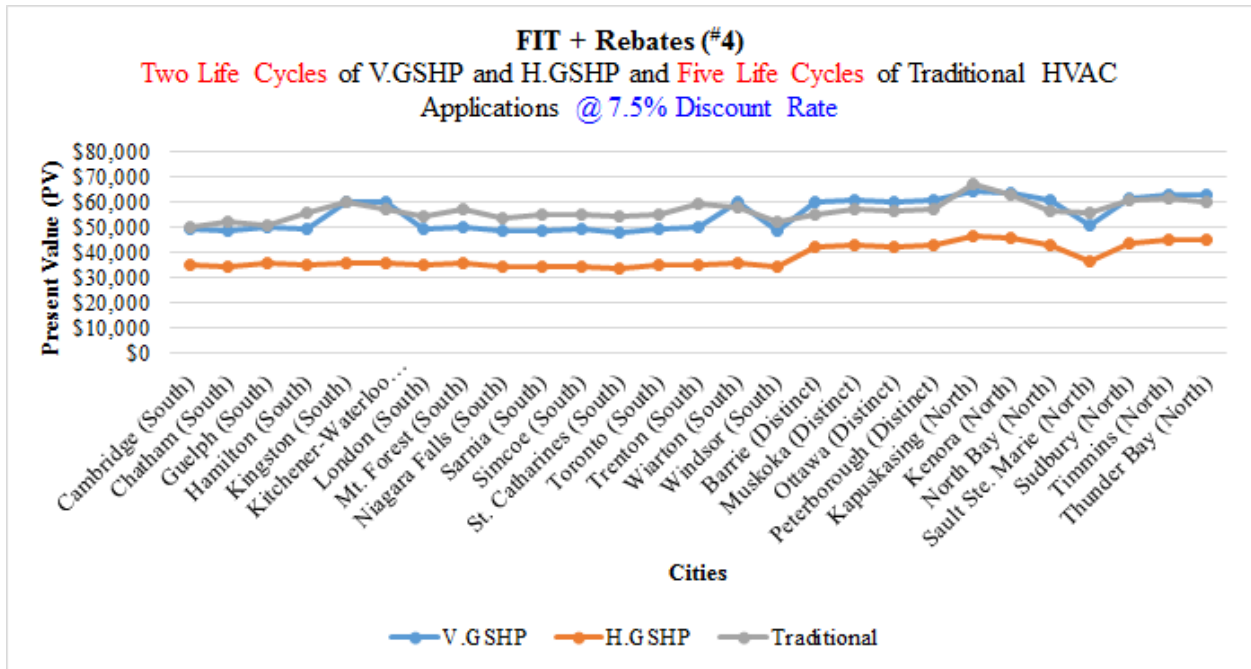

Table E1-1.17: Economic Variation of HVAC technologies for feed-in tariff + rebates scenario (average construction type) at a discount rate of 7.5% (two life cycles of V.GSHP and H.GSHP and five life cycles of Traditional HVAC Applications for a 60 year project lifespan)

(FIT + Rebates) + Carbon Taxes – (#5)

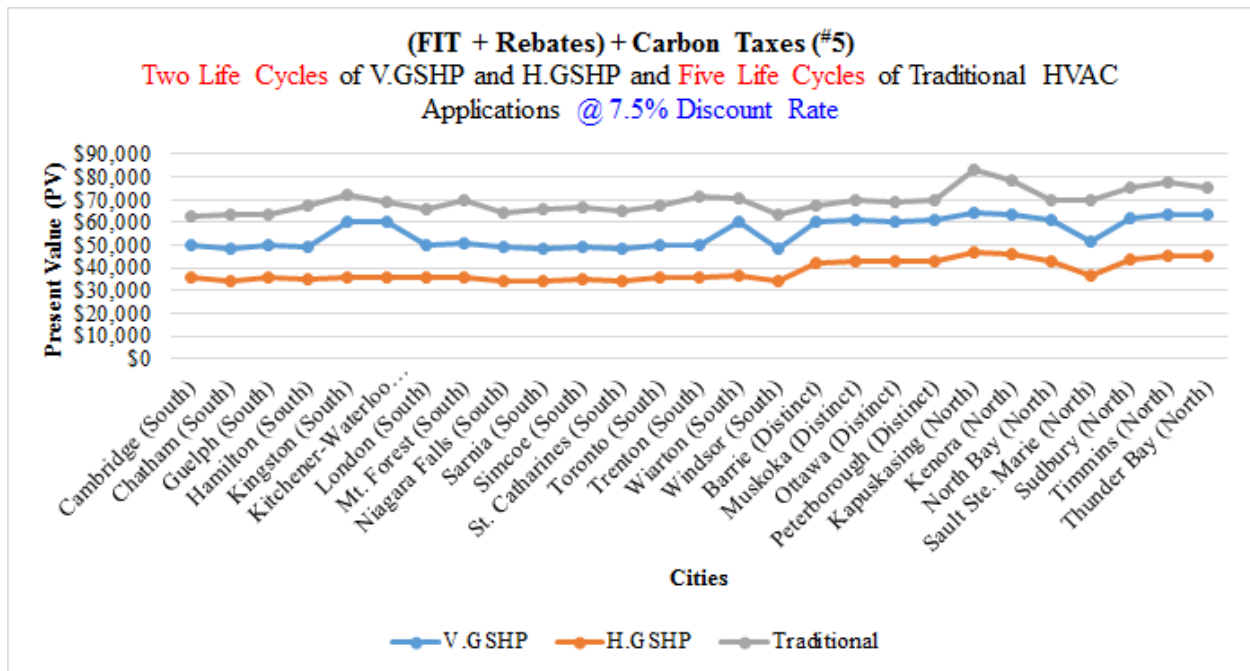

Table E1-1.18: Economic Variation of HVAC technologies for feed-in tariff + rebates + carbon tax scenario (average construction type) at a discount rate of 7.5% (two life cycles of V.GSHP and H.GSHP and five life cycles of Traditional HVAC Applications for a 60 year project lifespan)

4. Two Life Cycles of V.GSHP and H.GSHP and Five Life Cycles of Traditional HVAC Applications @ 8.5% Discount Rate

Base Case Scenario

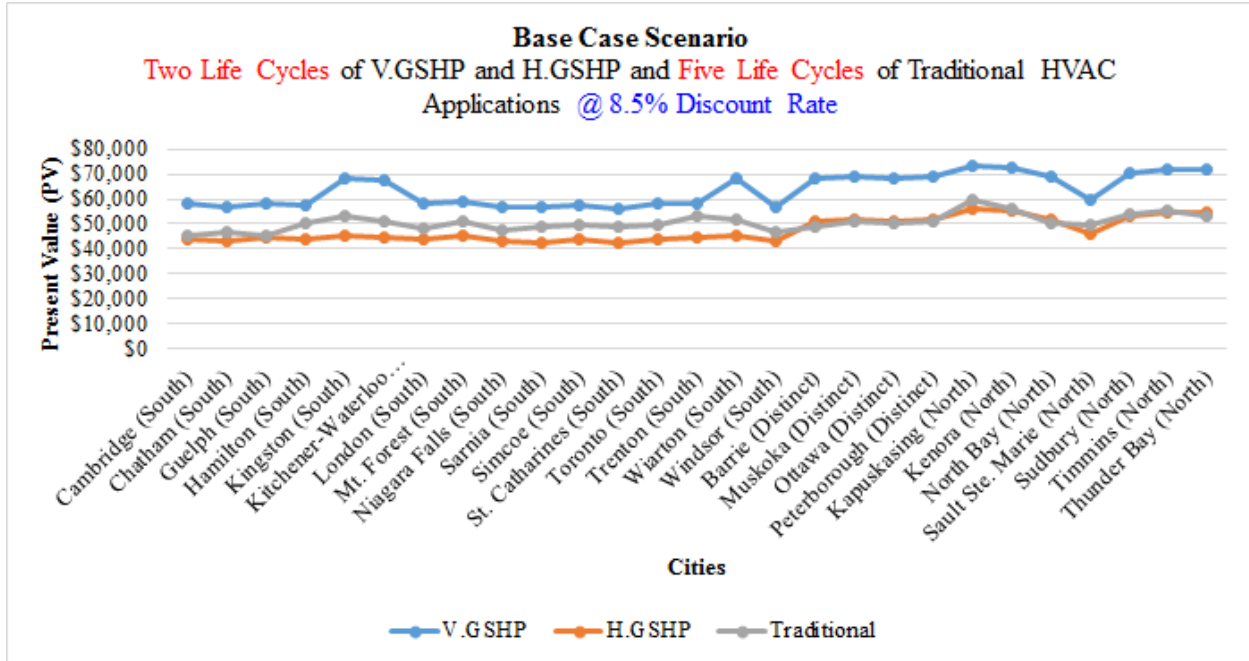

Table E1-1.19: Economic Variation of HVAC technologies for base case scenario (average construction type) at a discount rate of 8.5% (two life cycles of V.GSHP and H.GSHP and five life cycles of Traditional HVAC Applications for a 60 year project lifespan)

Carbon Taxes – (#1)

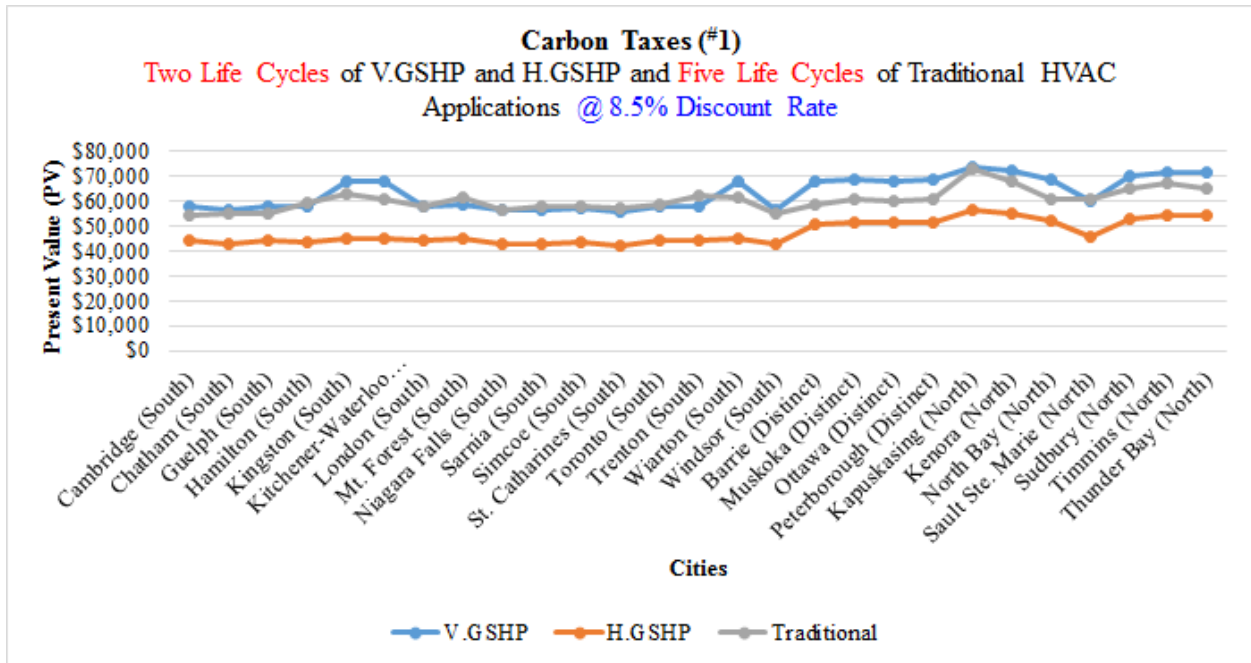

Table E1-1.20: Economic Variation of HVAC technologies for carbon taxes scenario (average construction type) at a discount rate of 8.5% (two life cycles of V.GSHP and H.GSHP and five life cycles of Traditional HVAC Applications for a 60 year project lifespan)

FIT – (#2)

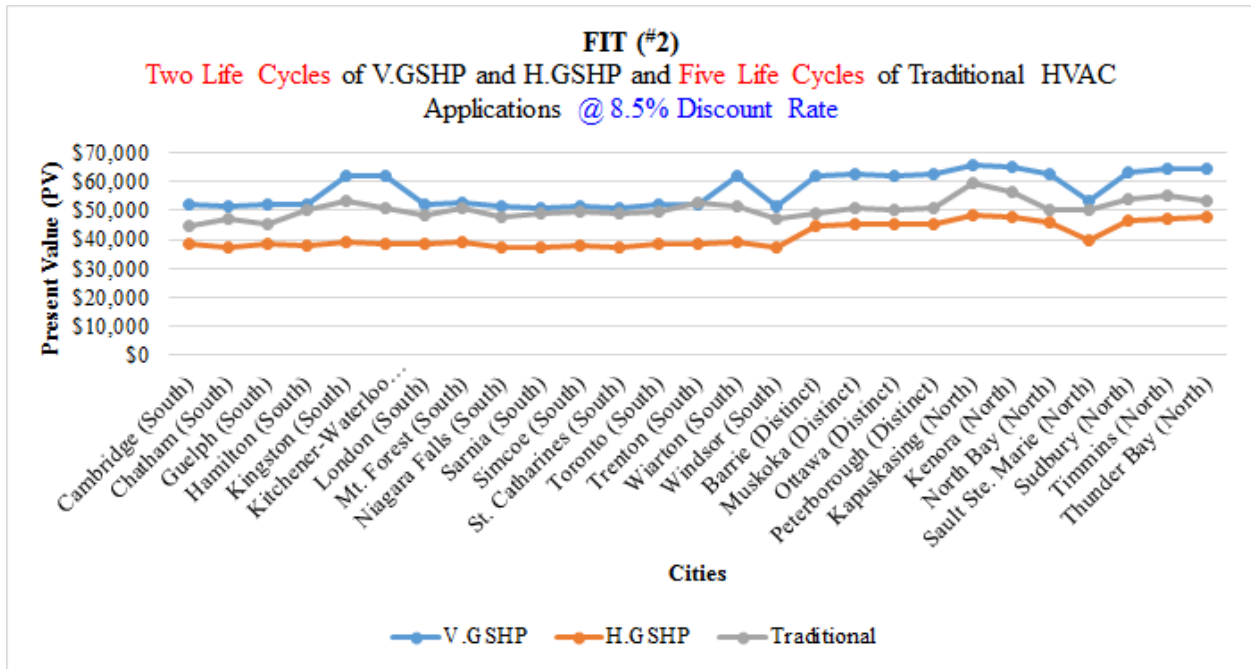

Table E1-1.21: Economic Variation of HVAC technologies for feed-in tariff scenario (average construction type) at a discount rate of 8.5% (two life cycles of V.GSHP and H.GSHP and five life cycles of Traditional HVAC Applications for a 60 year project lifespan)

Rebates – (#3)

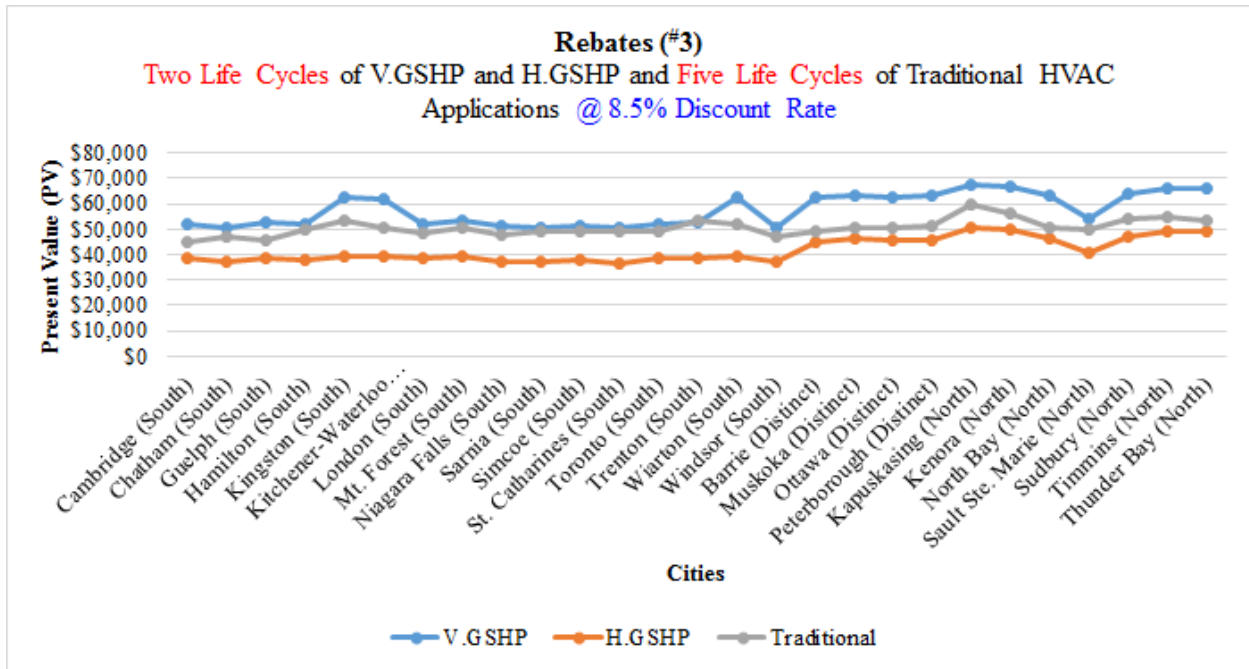

Table E1-1.22: Economic Variation of HVAC technologies for rebates scenario (average construction type) at a discount rate of 8.5% (two life cycles of V.GSHP and H.GSHP and five life cycles of Traditional HVAC Applications for a 60 year project lifespan)

FIT + Rebates – (#4)

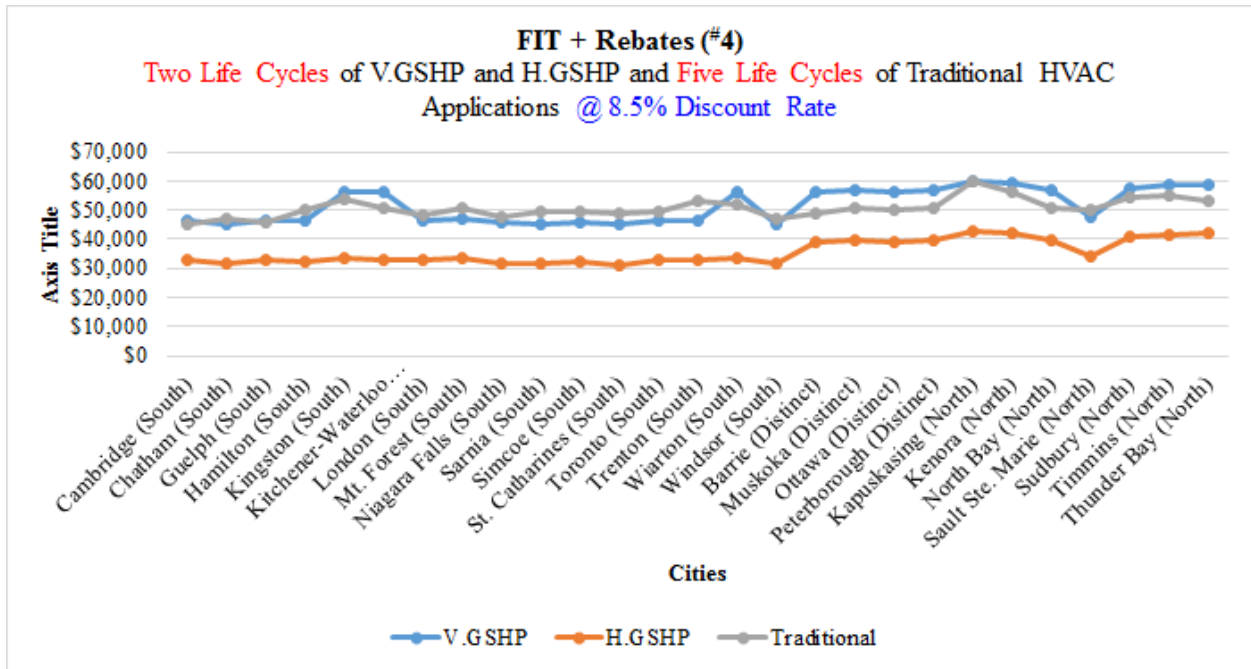

Table E1-1.23: Economic Variation of HVAC technologies for feed-in tariff + rebates scenario (average construction type) at a discount rate of 8.5% (two life cycles of V.GSHP and H.GSHP and five life cycles of Traditional HVAC Applications for a 60 year project lifespan)

(FIT + Rebates) + Carbon Taxes – (#5)

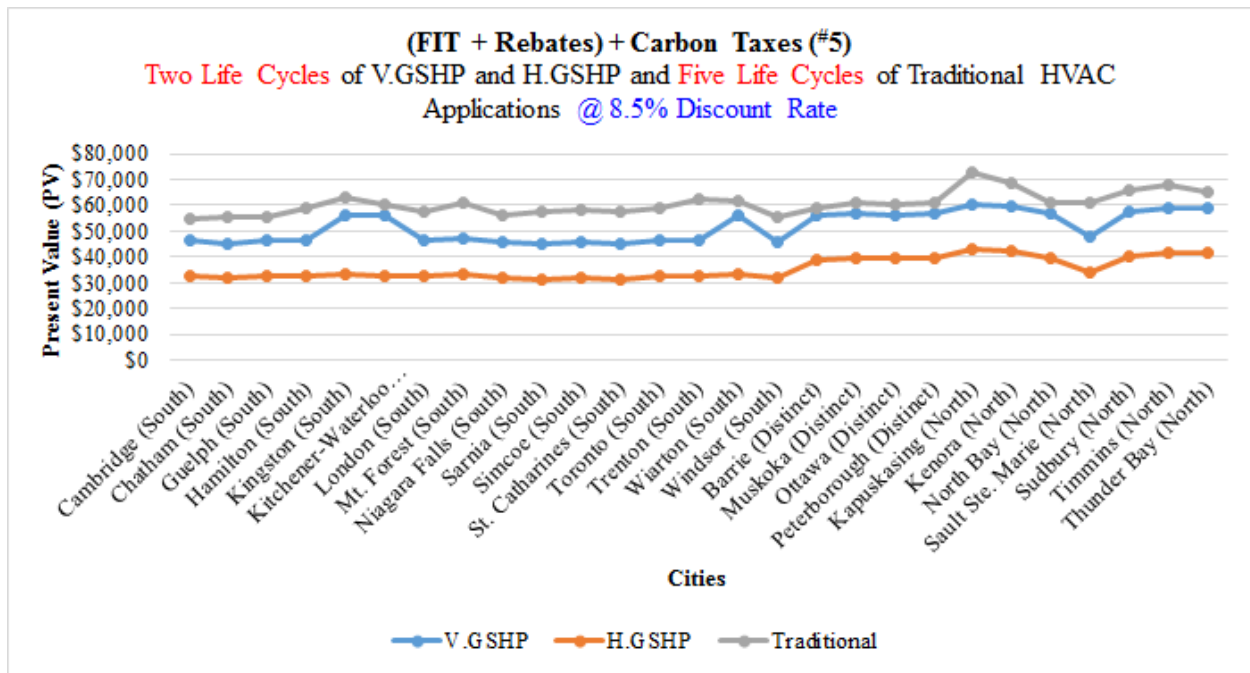

Table E1-1.24: Economic Variation of HVAC technologies for feed-in tariff + rebates + carbon tax scenario (average construction type) at a discount rate of 8.5% (two life cycles of V.GSHP and H.GSHP and five life cycles of Traditional HVAC Applications for a 60 year project lifespan)

5. Two Life Cycles of V.GSHP and H.GSHP and Five Life Cycles of Traditional HVAC Applications @ 10% Discount Rate

Base Case Scenario

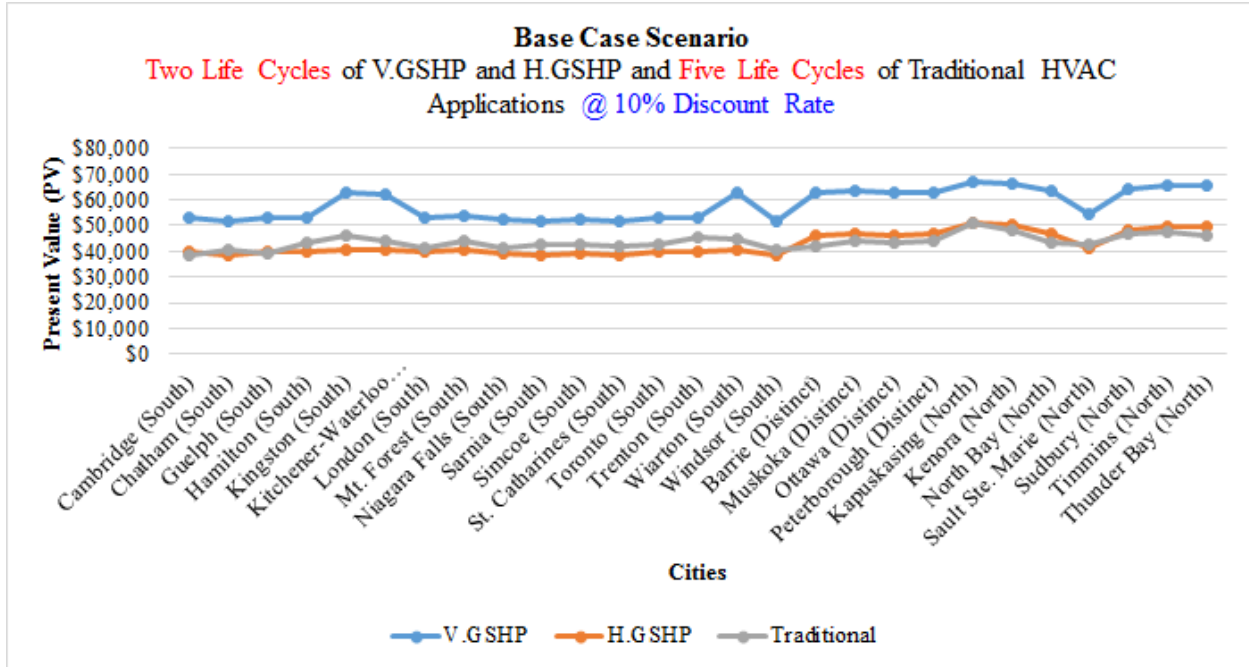

Table E1-1.25: Economic Variation of HVAC technologies for base case scenario (average construction type) at a discount rate of 10% (two life cycles of V.GSHP and H.GSHP and five life cycles of Traditional HVAC Applications for a 60 year project lifespan)

Carbon Taxes – (#1)

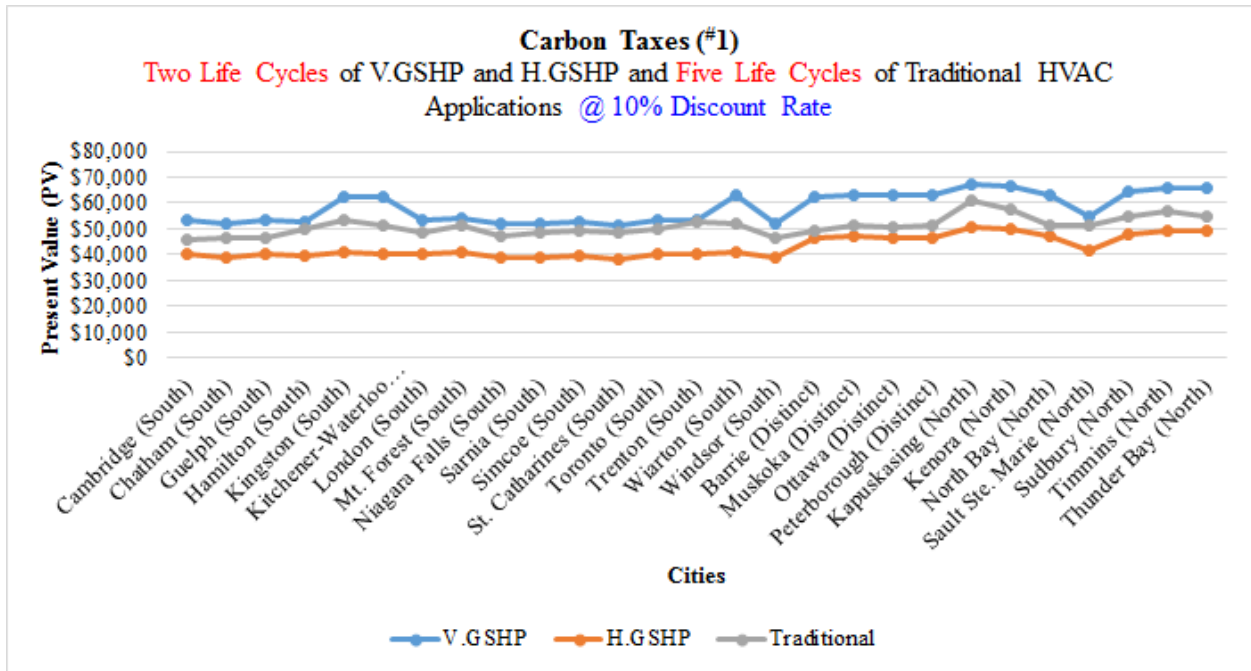

Table E1-1.26: Economic Variation of HVAC technologies for carbon taxes scenario (average construction type) at a discount rate of 10% (two life cycles of V.GSHP and H.GSHP and five life cycles of Traditional HVAC Applications for a 60 year project lifespan)

FIT – (#2)

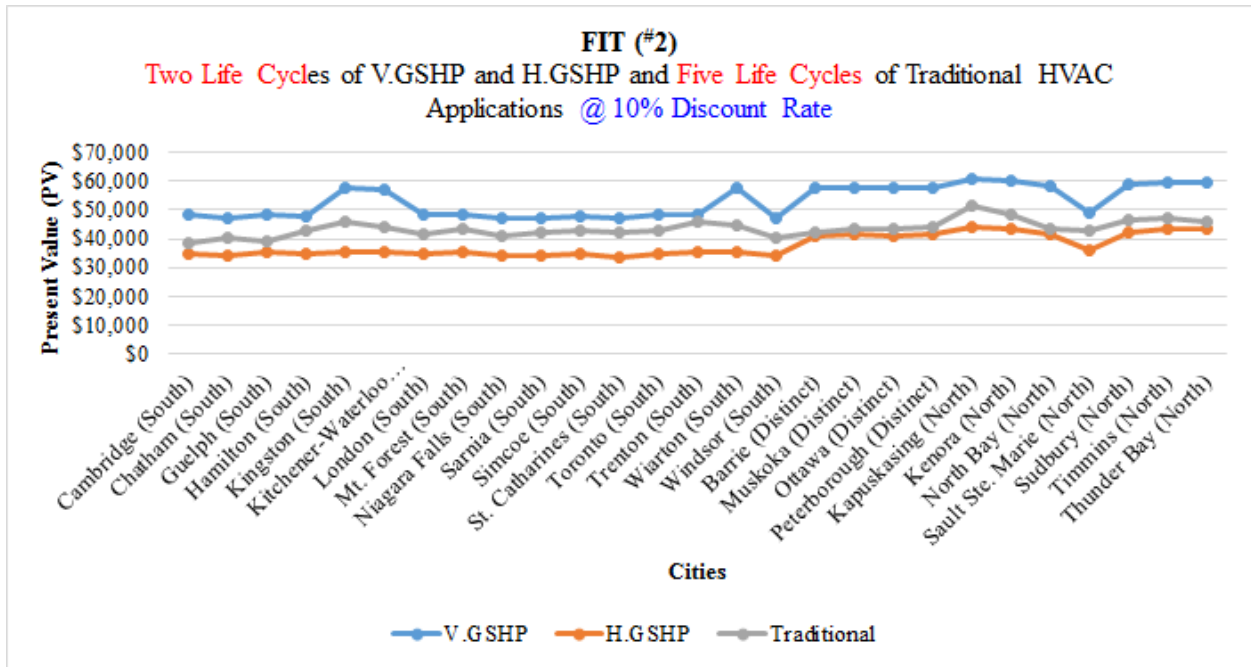

Table E1-1.27: Economic Variation of HVAC technologies for feed-in tariff scenario (average construction type) at a discount rate of 10% (two life cycles of V.GSHP and H.GSHP and five life cycles of Traditional HVAC Applications for a 60 year project lifespan)

Rebates – (#3)

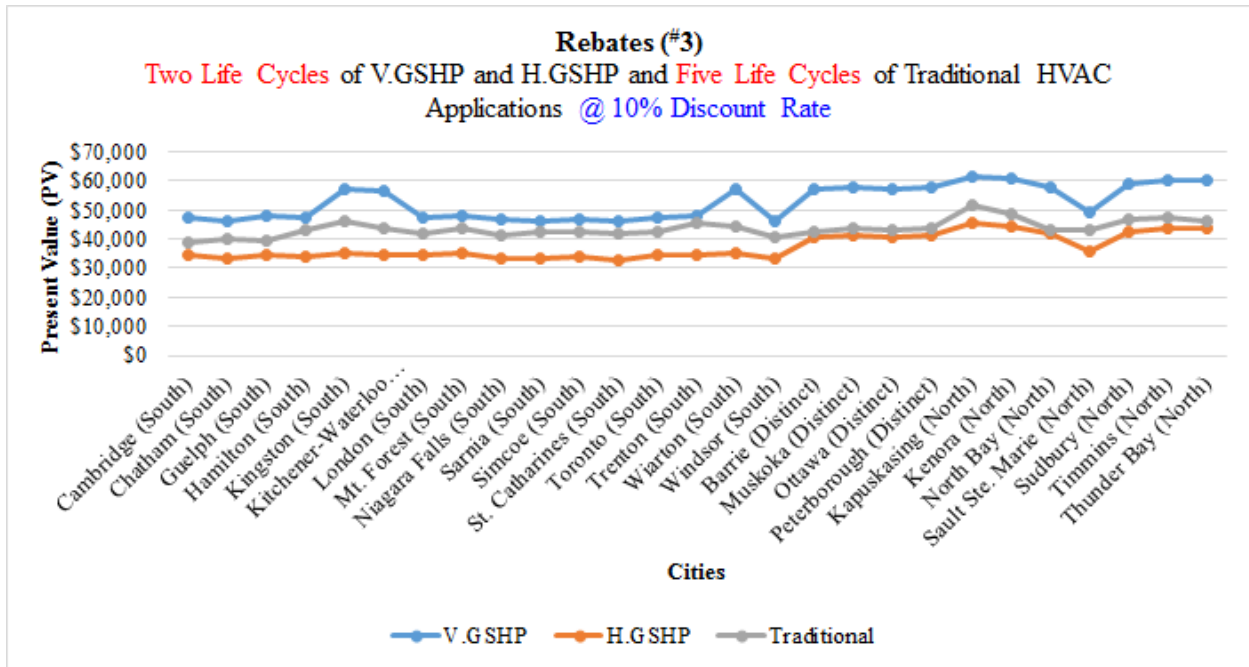

Table E1-1.28: Economic Variation of HVAC technologies for rebates scenario (average construction type) at a discount rate of 10% (two life cycles of V.GSHP and H.GSHP and five life cycles of Traditional HVAC Applications for a 60 year project lifespan)

FIT + Rebates – (#4)

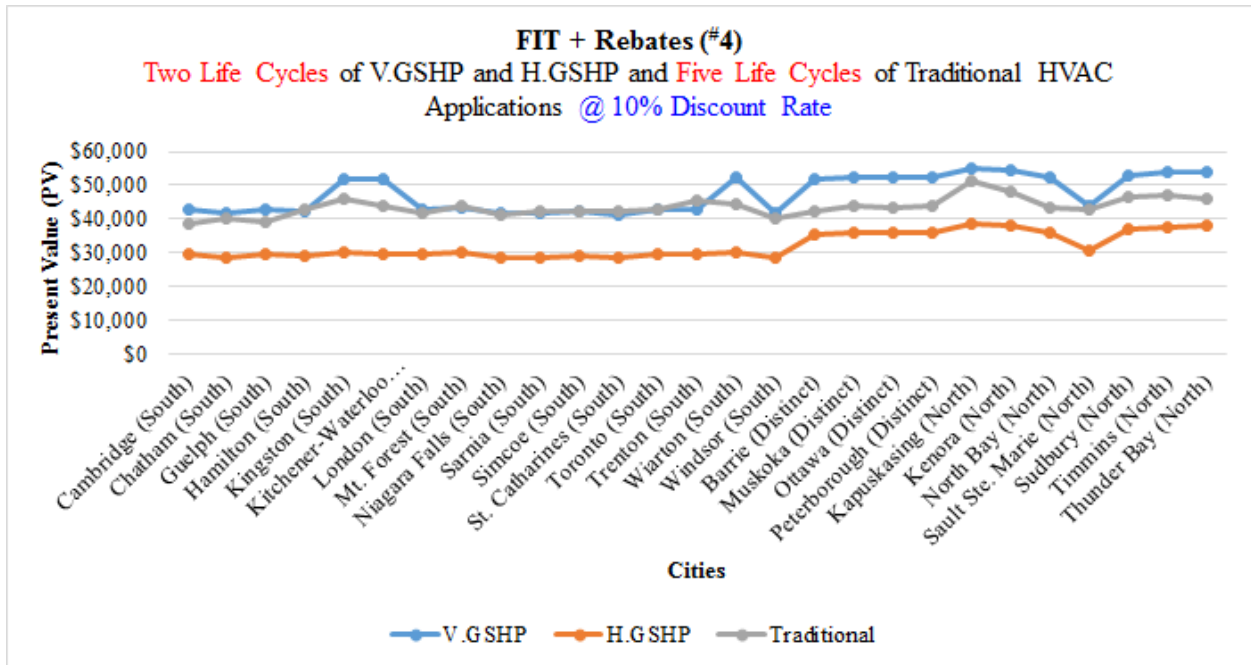

Table E1-1.29: Economic Variation of HVAC technologies for feed-in tariff + rebates scenario (average construction type) at a discount rate of 10% (two life cycles of V.GSHP and H.GSHP and five life cycles of Traditional HVAC Applications for a 60 year project lifespan)

(FIT + Rebates) + Carbon Taxes – (#5)

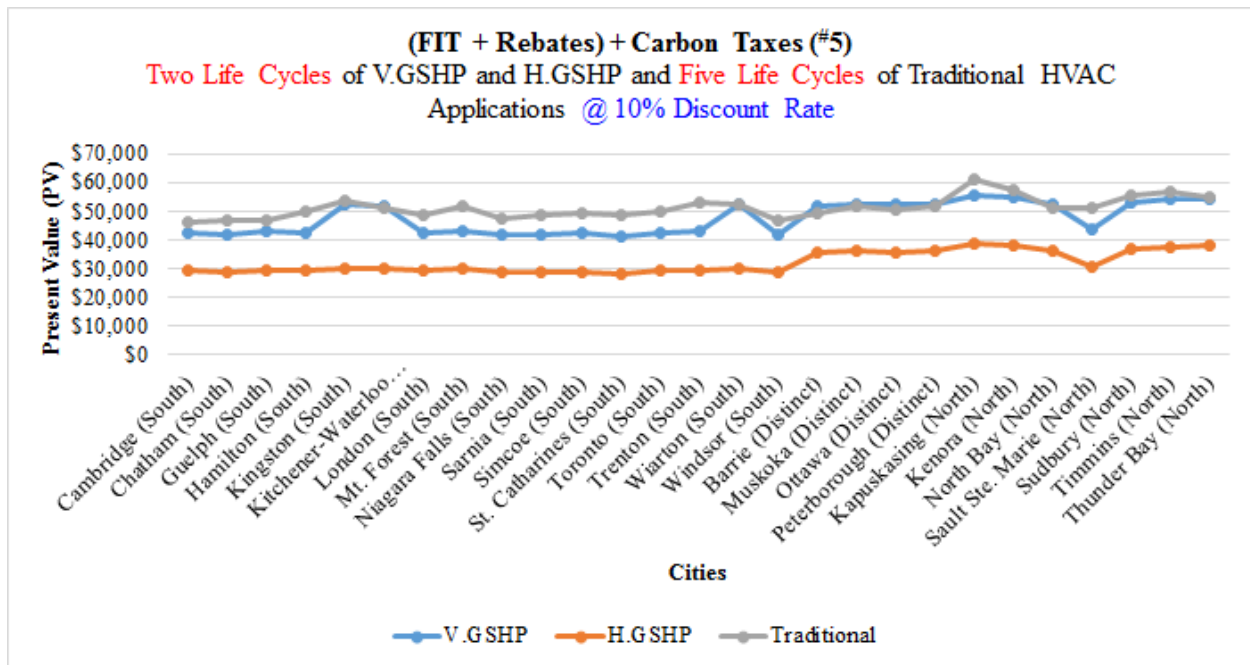

Table E1-1.30: Economic Variation of HVAC technologies for feed-in tariff + rebates + carbon tax scenario (average construction type) at a discount rate of 10% (two life cycles of V.GSHP and H.GSHP and five life cycles of Traditional HVAC Applications for a 60 year project lifespan)

6. Two Life Cycles of V.GSHP and H.GSHP and Five Life Cycles of Traditional HVAC Applications @ 12% Discount Rate

Base Case Scenario

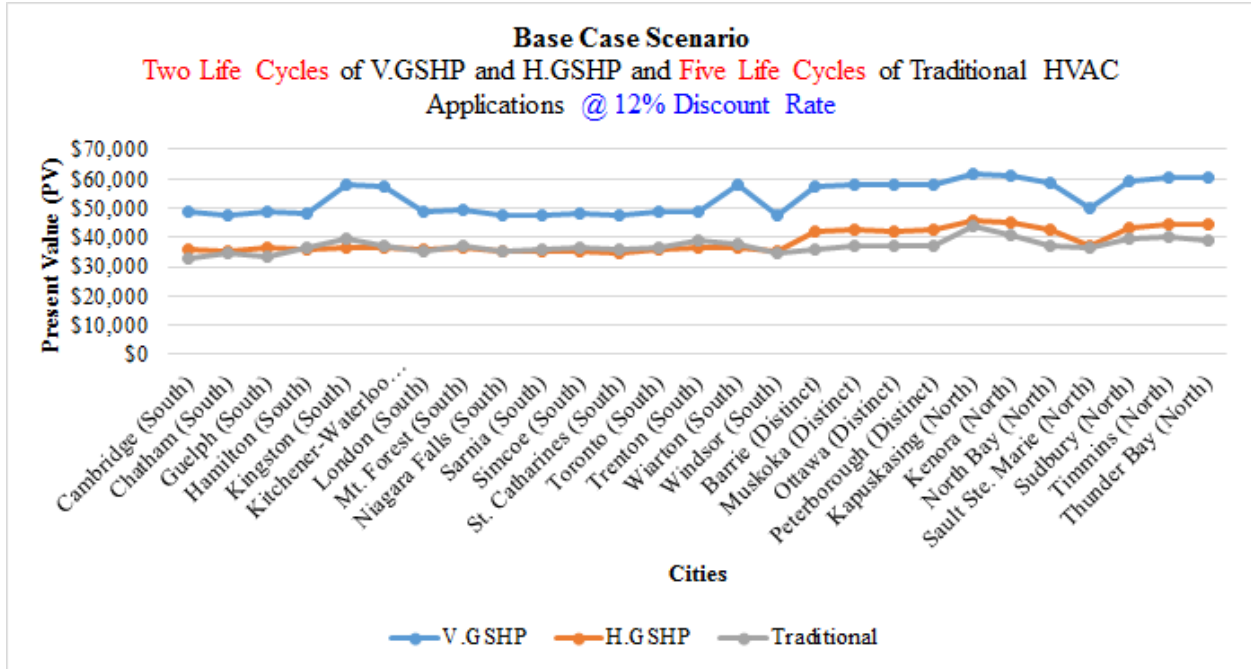

Table E1-1.31: Economic Variation of HVAC technologies for base case scenario (average construction type) at a discount rate of 12% (two life cycles of V.GSHP and H.GSHP and five life cycles of Traditional HVAC Applications for a 60 year project lifespan)

Carbon Taxes – (#1)

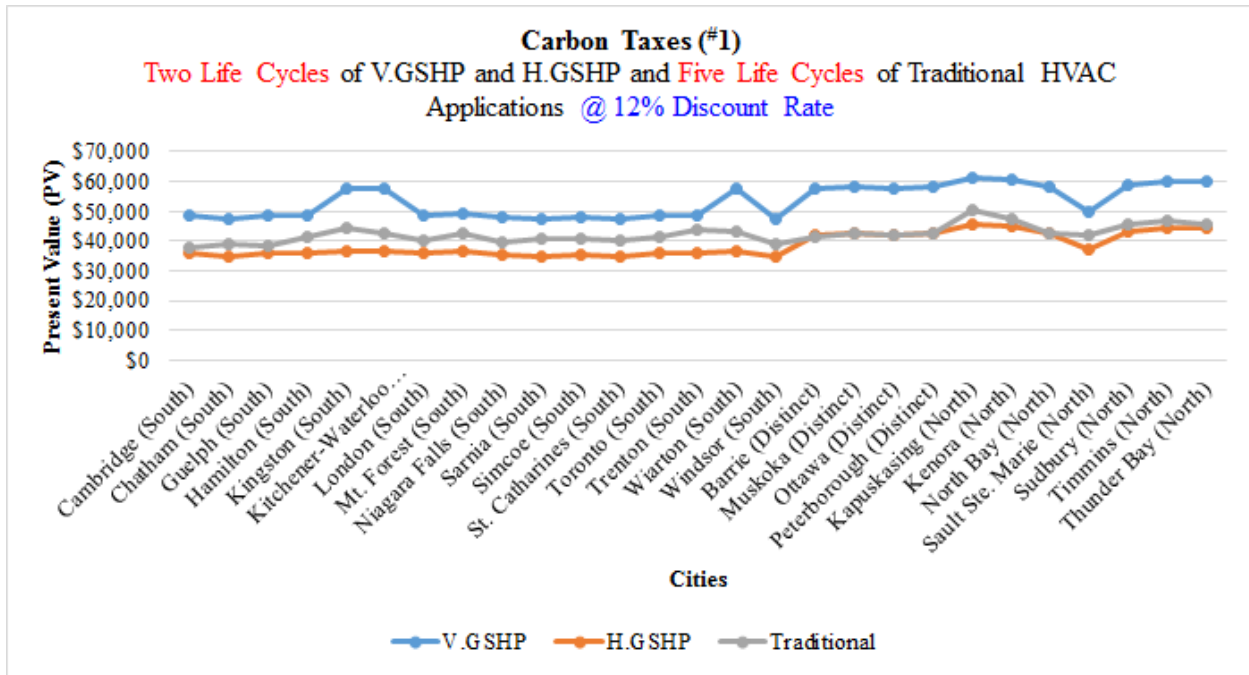

Table E1-1.32: Economic Variation of HVAC technologies for carbon taxes scenario (average construction type) at a discount rate of 12% (two life cycles of V.GSHP and H.GSHP and five life cycles of Traditional HVAC Applications for a 60 year project lifespan)

FIT – (#2)

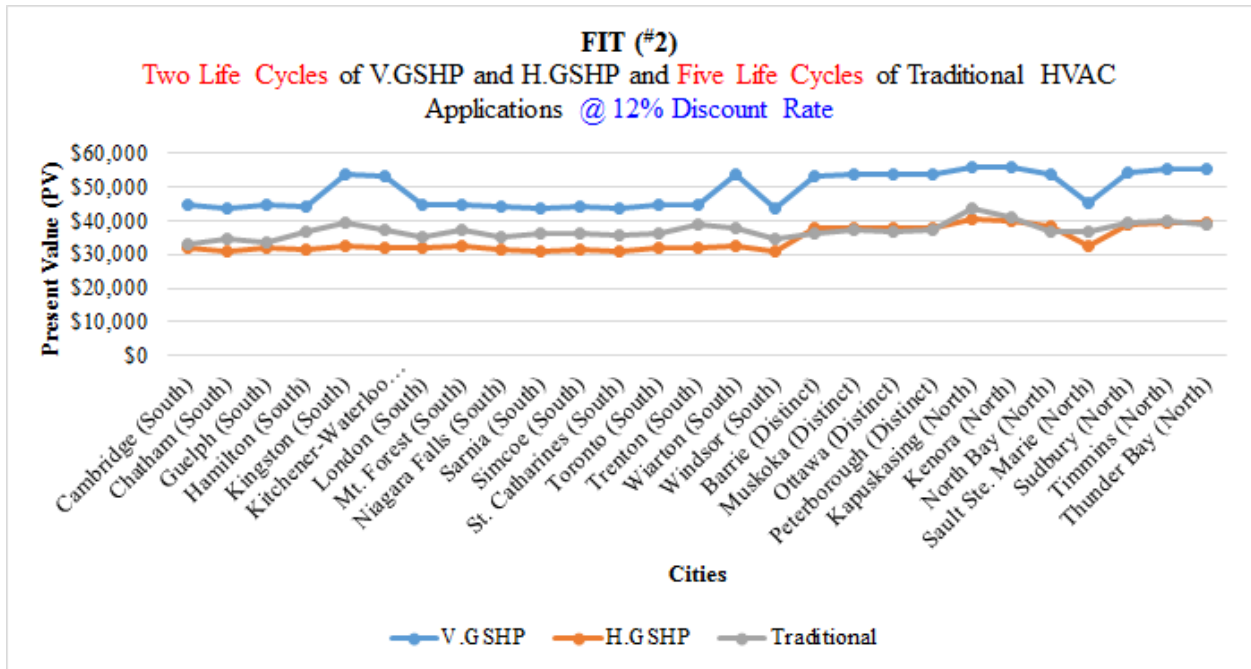

Table E1-1.33: Economic Variation of HVAC technologies for feed-in tariff scenario (average construction type) at a discount rate of 12% (two life cycles of V.GSHP and H.GSHP and five life cycles of Traditional HVAC Applications for a 60 year project lifespan)

Rebates – (#3)

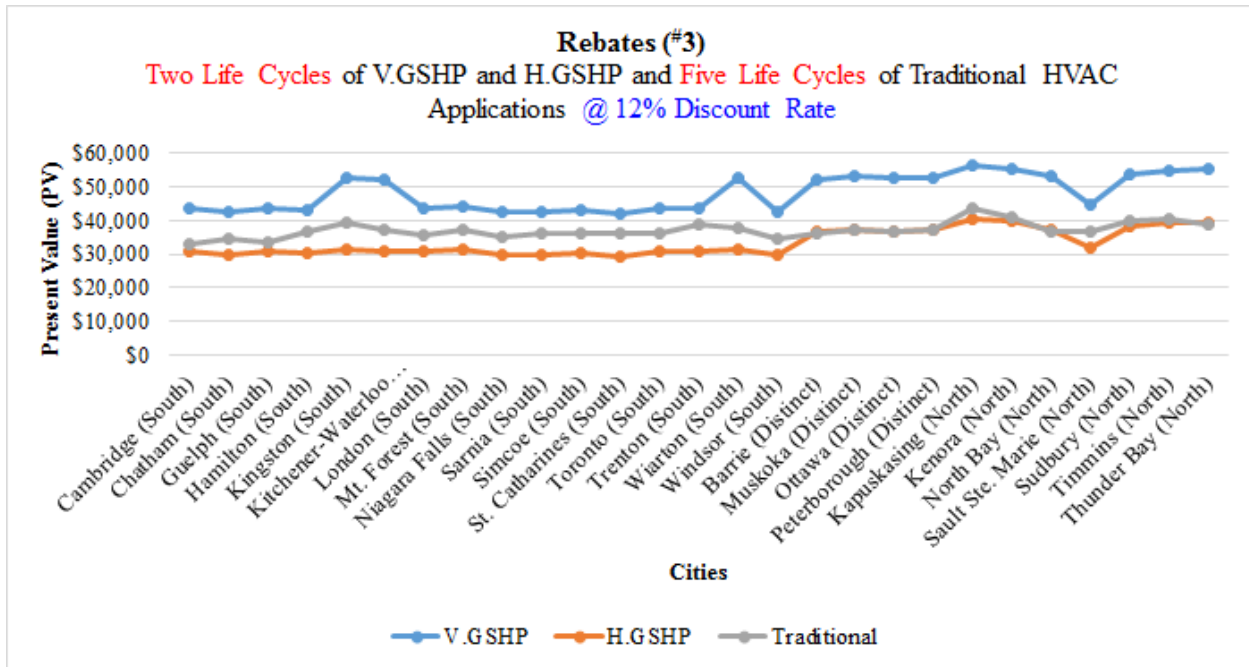

Table E1-1.34: Economic Variation of HVAC technologies for rebates scenario (average construction type) at a discount rate of 12% (two life cycles of V.GSHP and H.GSHP and five life cycles of Traditional HVAC Applications for a 60 year project lifespan)

FIT + Rebates – (#4)

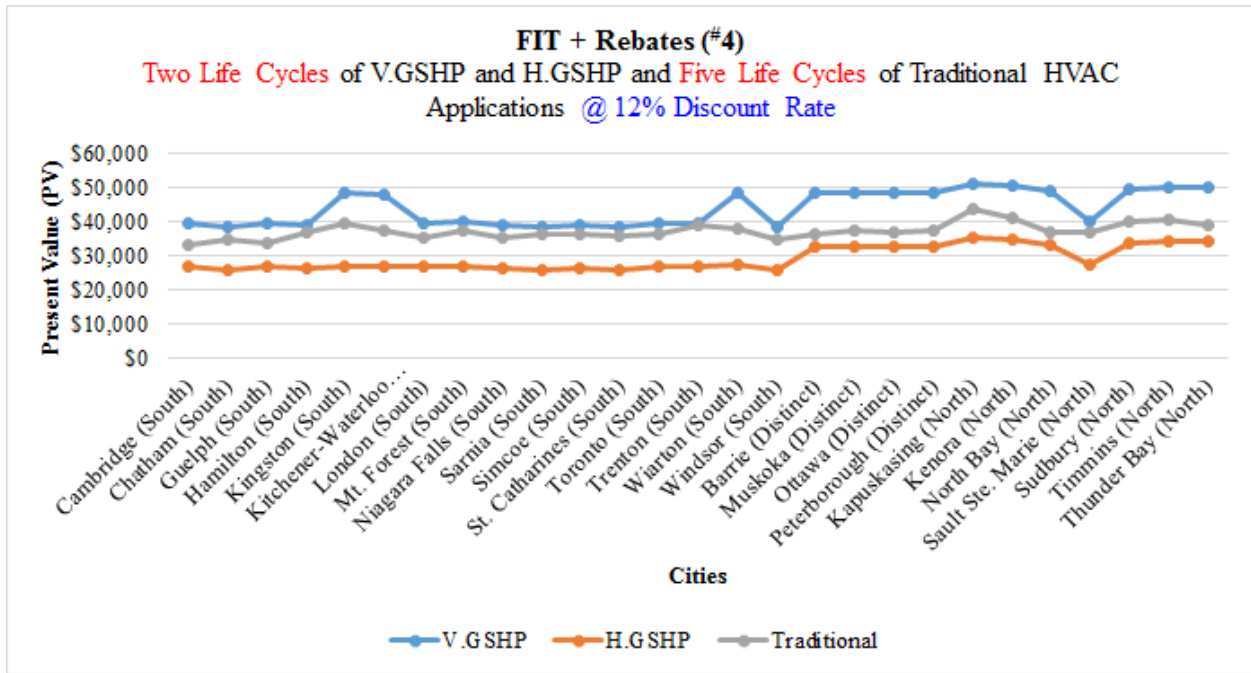

Table E1-1.35: Economic Variation of HVAC technologies for feed-in tariff + rebates scenario (average construction type) at a discount rate of 12% (two life cycles of V.GSHP and H.GSHP and five life cycles of Traditional HVAC Applications for a 60 year project lifespan)

(FIT + Rebates) + Carbon Taxes – (#5)

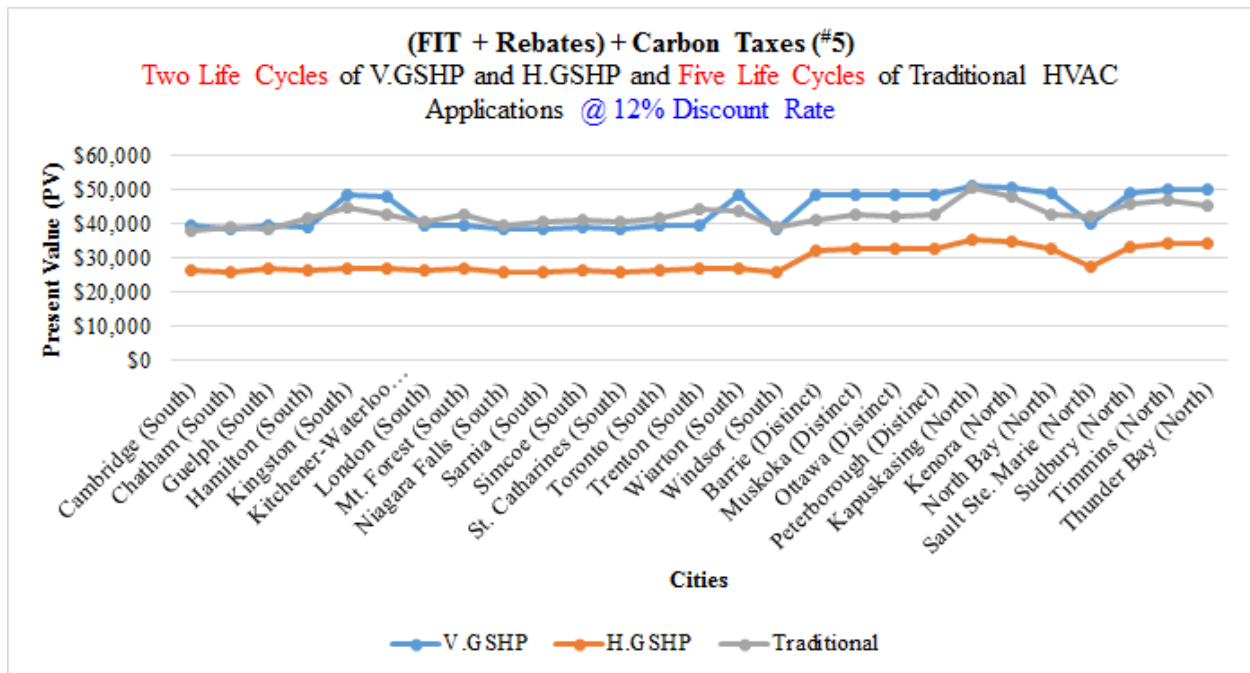

Table E1-1.36: Economic Variation of HVAC technologies for feed-in tariff + rebates + carbon tax scenario (average construction type) at a discount rate of 12% (two life cycles of V.GSHP and H.GSHP and five life cycles of Traditional HVAC Applications for a 60 year project lifespan)

7. Three Life Cycles of V.GSHP and H.GSHP and Five Life Cycles of Traditional HVAC Applications @ 5% Discount Rate

Base Case Scenario

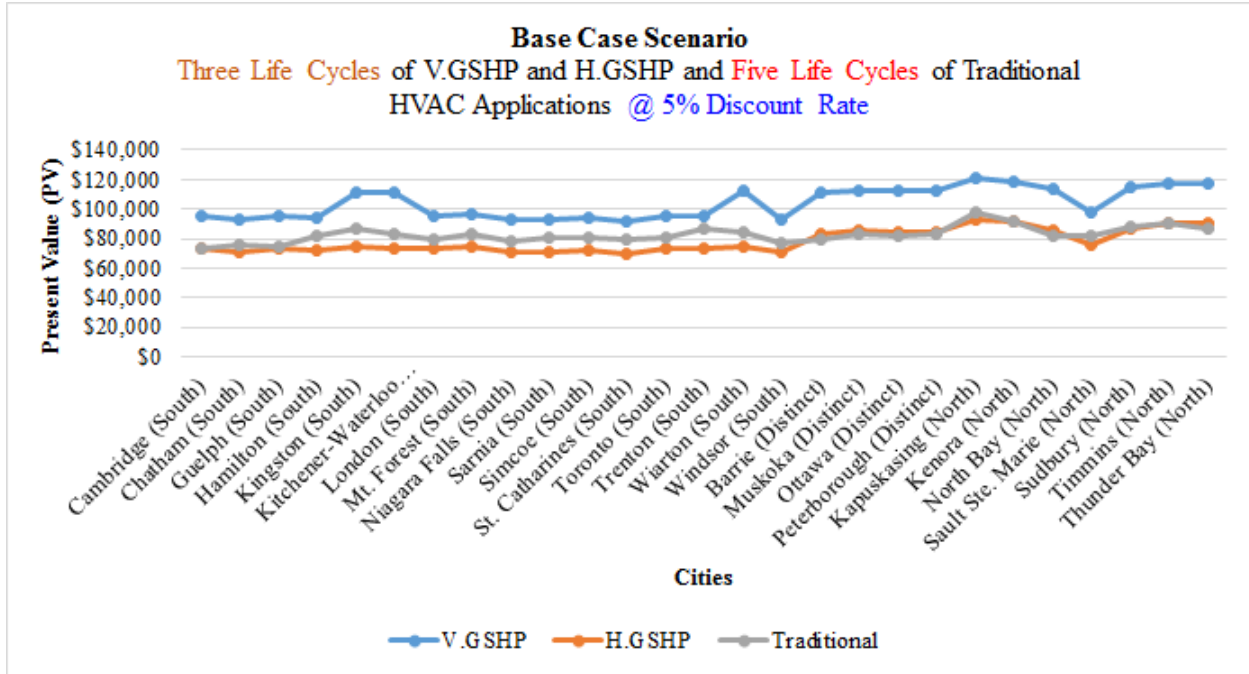

Table E1-1.37: Economic Variation of HVAC technologies for base case scenario (average construction type) at a discount rate of 5% (three life cycles of V.GSHP and H.GSHP and five life cycles of Traditional HVAC Applications for a 60 year project lifespan)

Carbon Taxes – (#1)

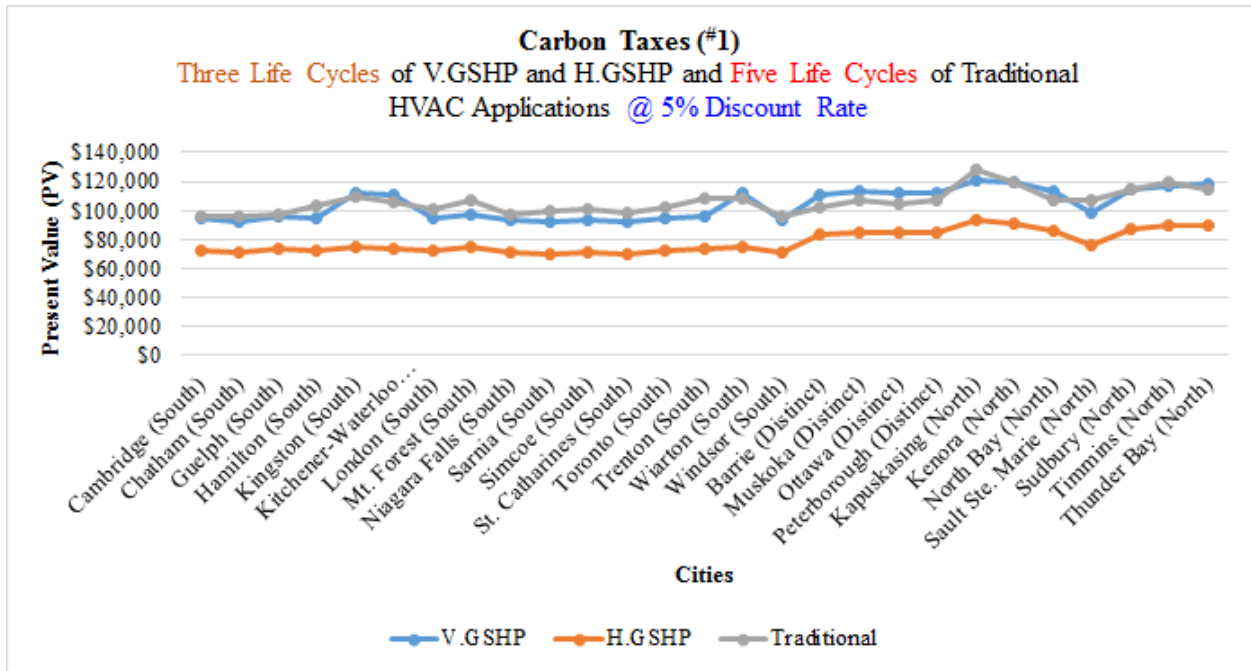

Table E1-1.38: Economic Variation of HVAC technologies for carbon taxes scenario (average construction type) at a discount rate of 5% (three life cycles of V.GSHP and H.GSHP and five life cycles of Traditional HVAC Applications for a 60 year project lifespan)

FIT – (#2)

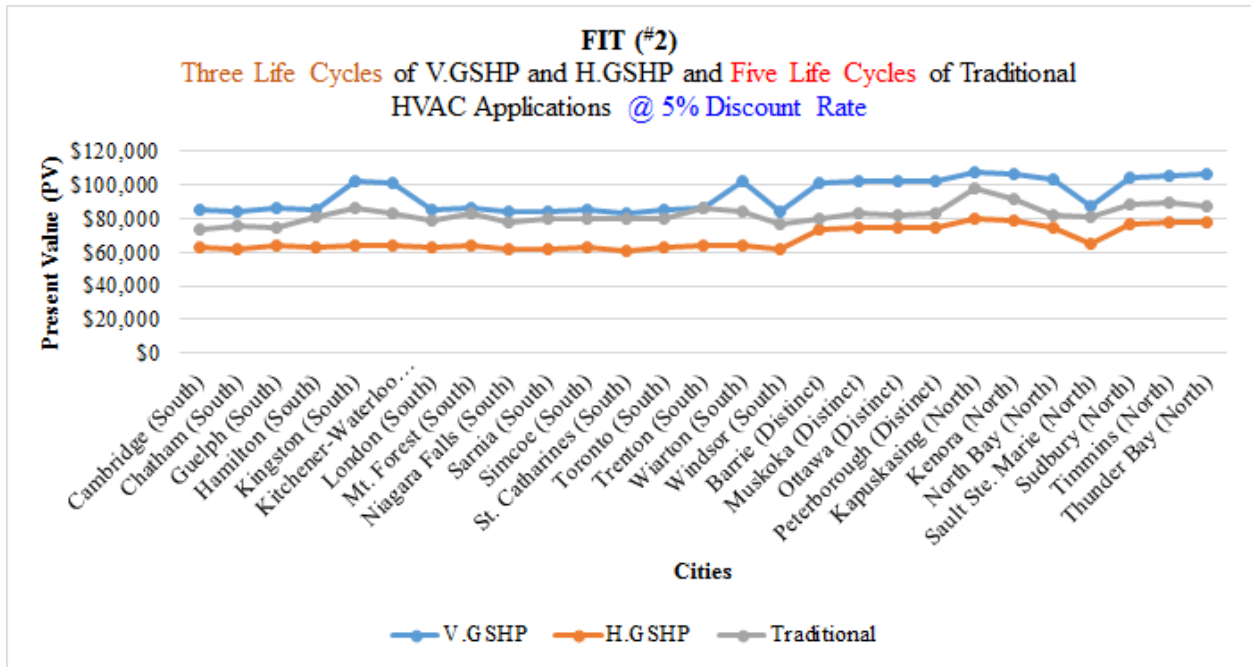

Table E1-1.39: Economic Variation of HVAC technologies for feed-in tariff scenario (average construction type) at a discount rate of 5% (three life cycles of V.GSHP and H.GSHP and five life cycles of Traditional HVAC Applications for a 60 year project lifespan)

Rebates – (#3)

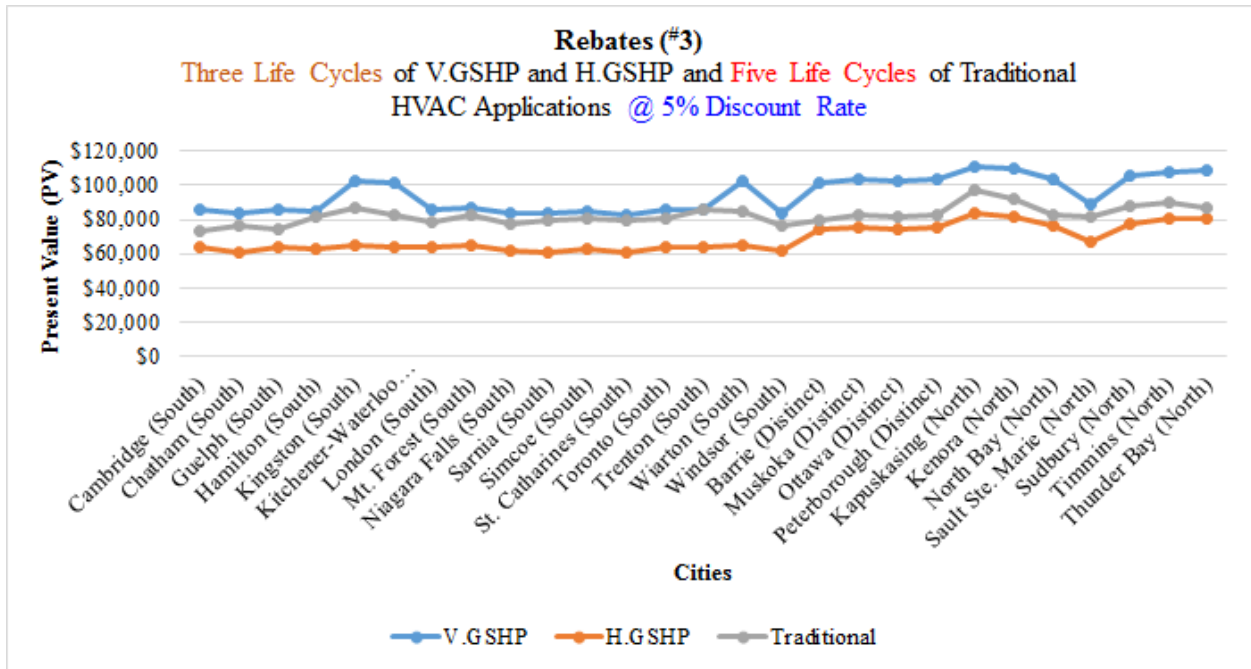

Table E1-1.40: Economic Variation of HVAC technologies for rebates scenario (average construction type) at a discount rate of 5% (three life cycles of V.GSHP and H.GSHP and five life cycles of Traditional HVAC Applications for a 60 year project lifespan)

FIT + Rebates – (#4)

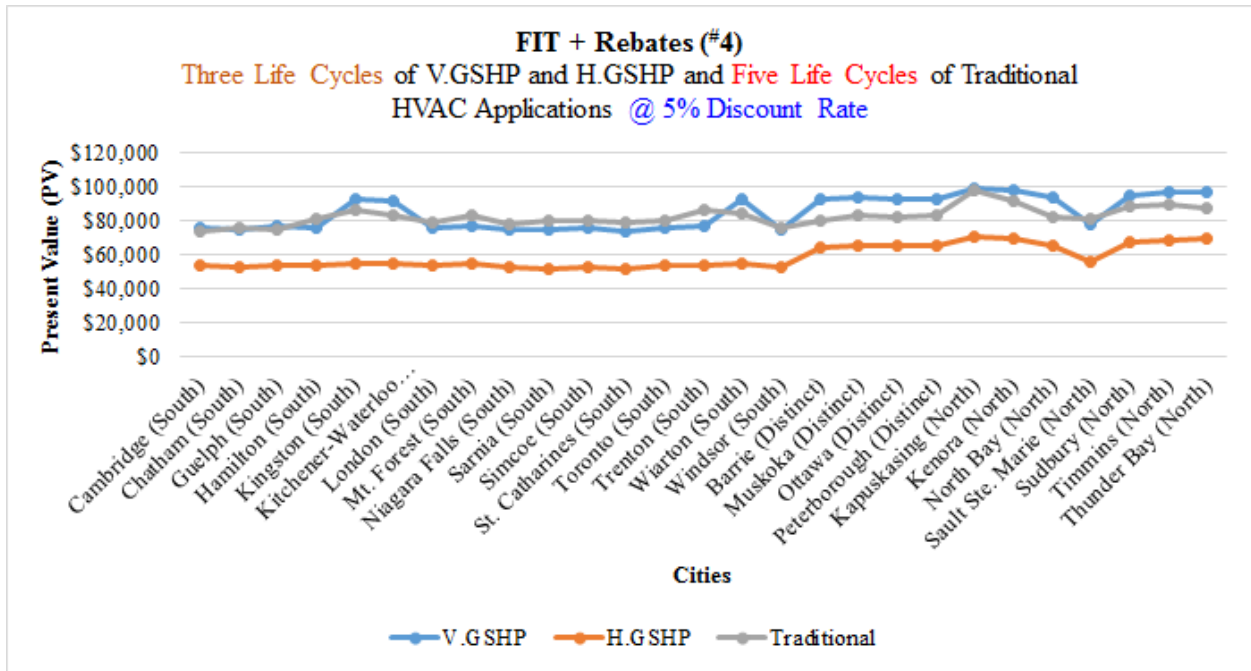

Table E1-1.41: Economic Variation of HVAC technologies for feed-in tariff + rebates scenario (average construction type) at a discount rate of 5% (three life cycles of V.GSHP and H.GSHP and five life cycles of Traditional HVAC Applications for a 60 year project lifespan)

(FIT + Rebates) + Carbon Taxes – (#5)

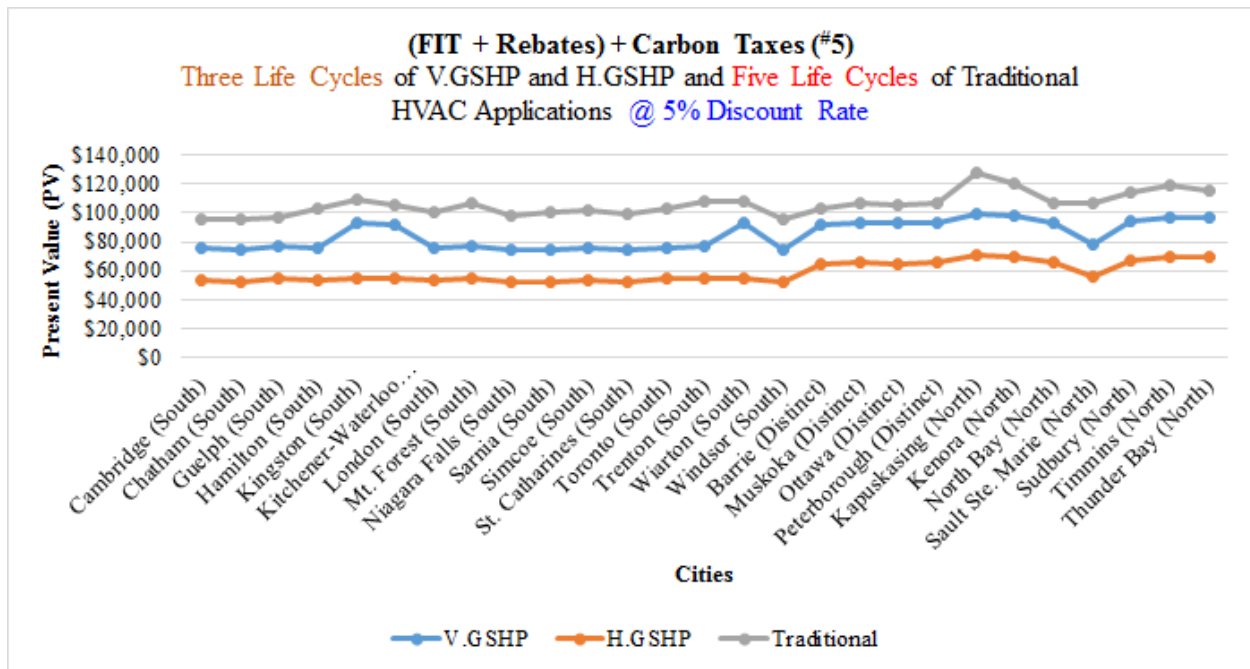

Table E1-1.42: Economic Variation of HVAC technologies for feed-in tariff + rebates + carbon tax scenario (average construction type) at a discount rate of 5% (three life cycles of V.GSHP and H.GSHP and five life cycles of Traditional HVAC Applications for a 60 year project lifespan)

8. Three Life Cycles of V.GSHP and H.GSHP and Five Life Cycles of Traditional HVAC Applications @ 7% Discount Rate

Base Case Scenario

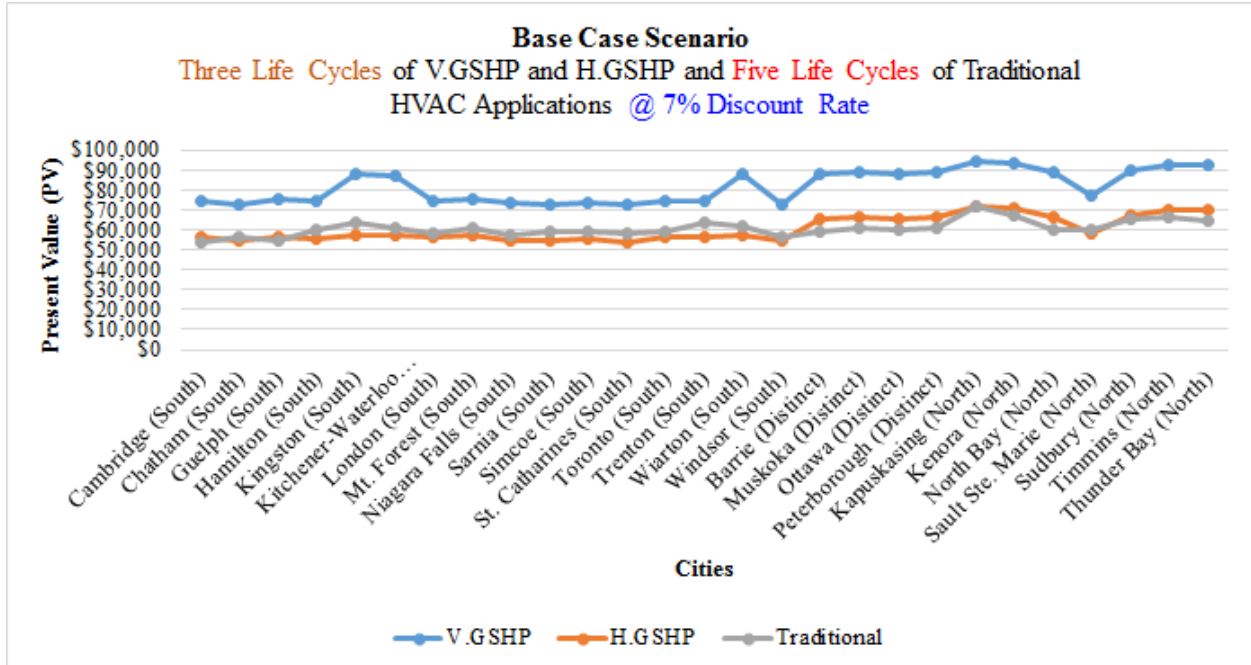

Table E1-1.43: Economic Variation of HVAC technologies for base case scenario (average construction type) at a discount rate of 7% (three life cycles of V.GSHP and H.GSHP and five life cycles of Traditional HVAC Applications for a 60 year project lifespan)

Carbon Taxes – (#1)

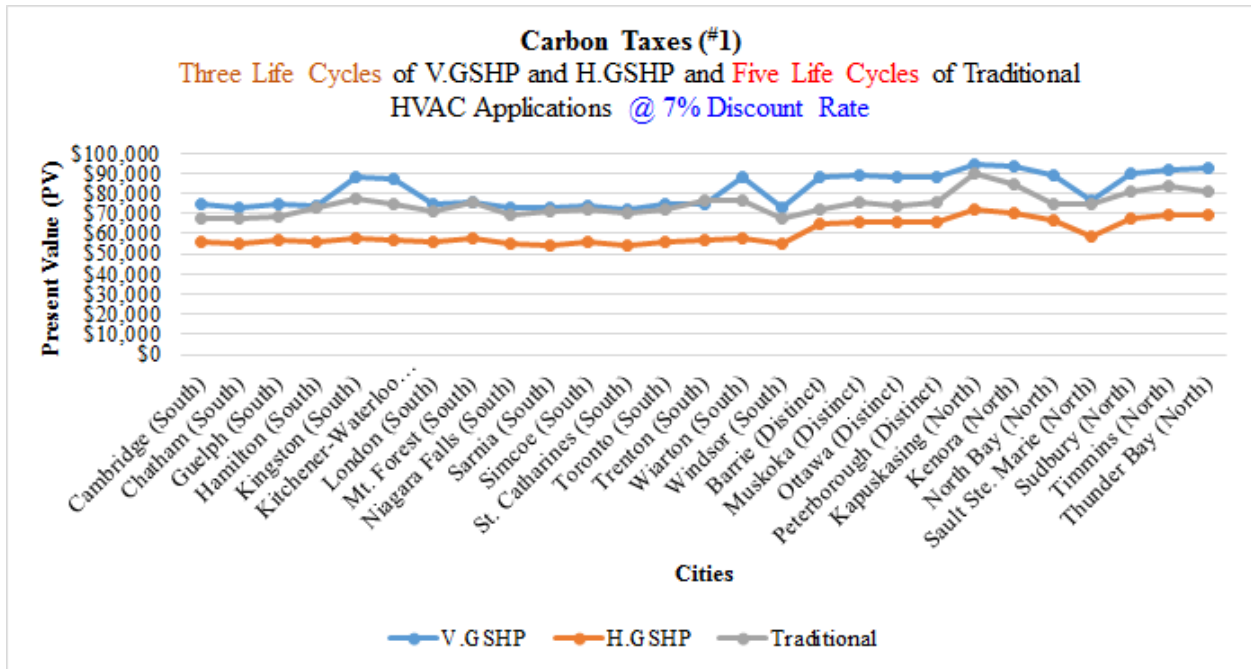

Table E1-1.44: Economic Variation of HVAC technologies for carbon taxes scenario (average construction type) at a discount rate of 7% (three life cycles of V.GSHP and H.GSHP and five life cycles of Traditional HVAC Applications for a 60 year project lifespan)

FIT – (#2)

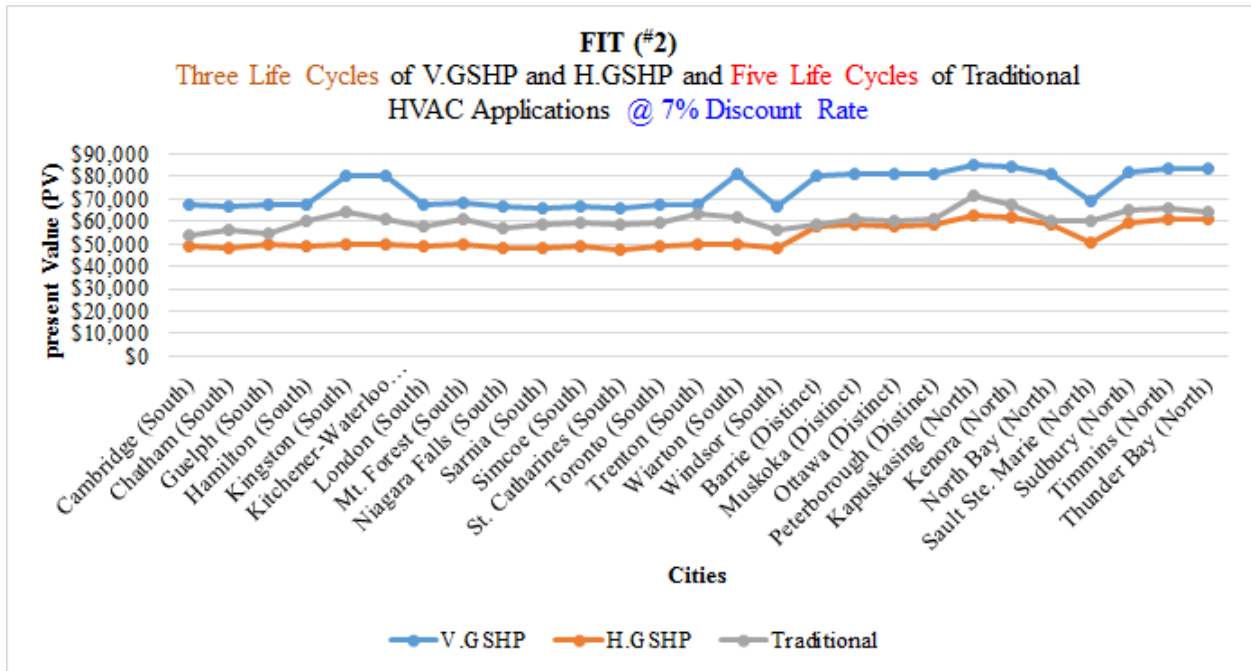

Table E1-1.45: Economic Variation of HVAC technologies for feed-in tariff scenario (average construction type) at a discount rate of 7% (three life cycles of V.GSHP and H.GSHP and five life cycles of Traditional HVAC Applications for a 60 year project lifespan)

Rebates – (#3)

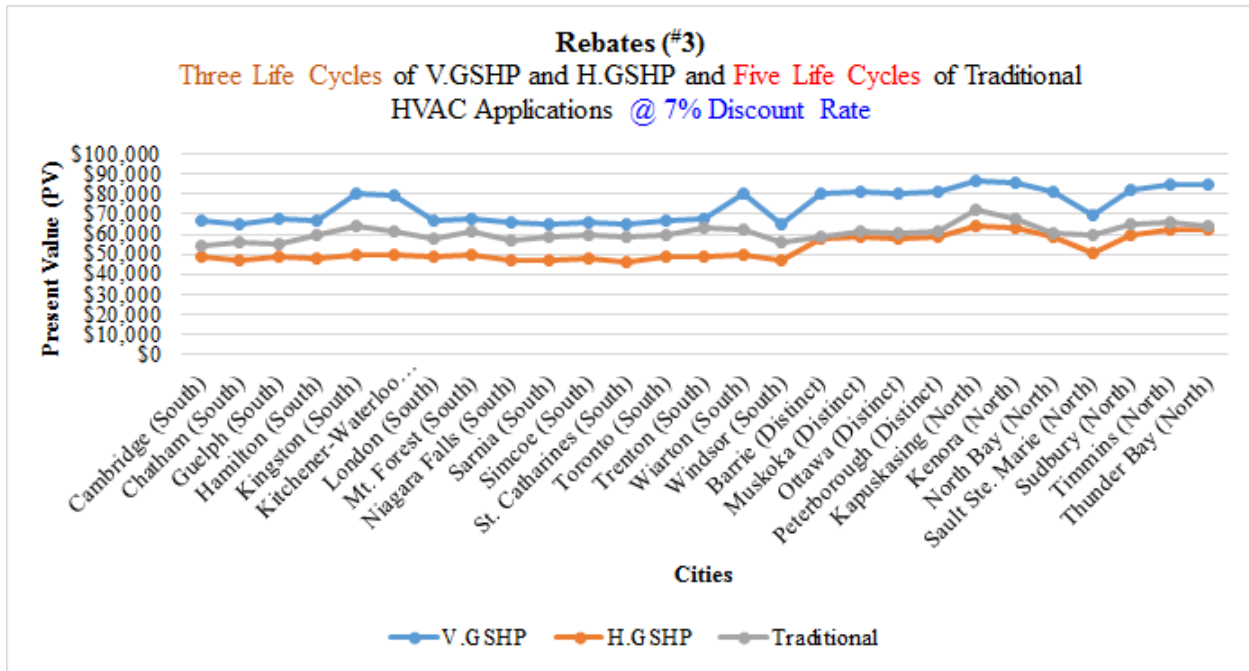

Table E1-1.46: Economic Variation of HVAC technologies for rebates scenario (average construction type) at a discount rate of 7% (three life cycles of V.GSHP and H.GSHP and five life cycles of Traditional HVAC Applications for a 60 year project lifespan)

FIT + Rebates – (#4)

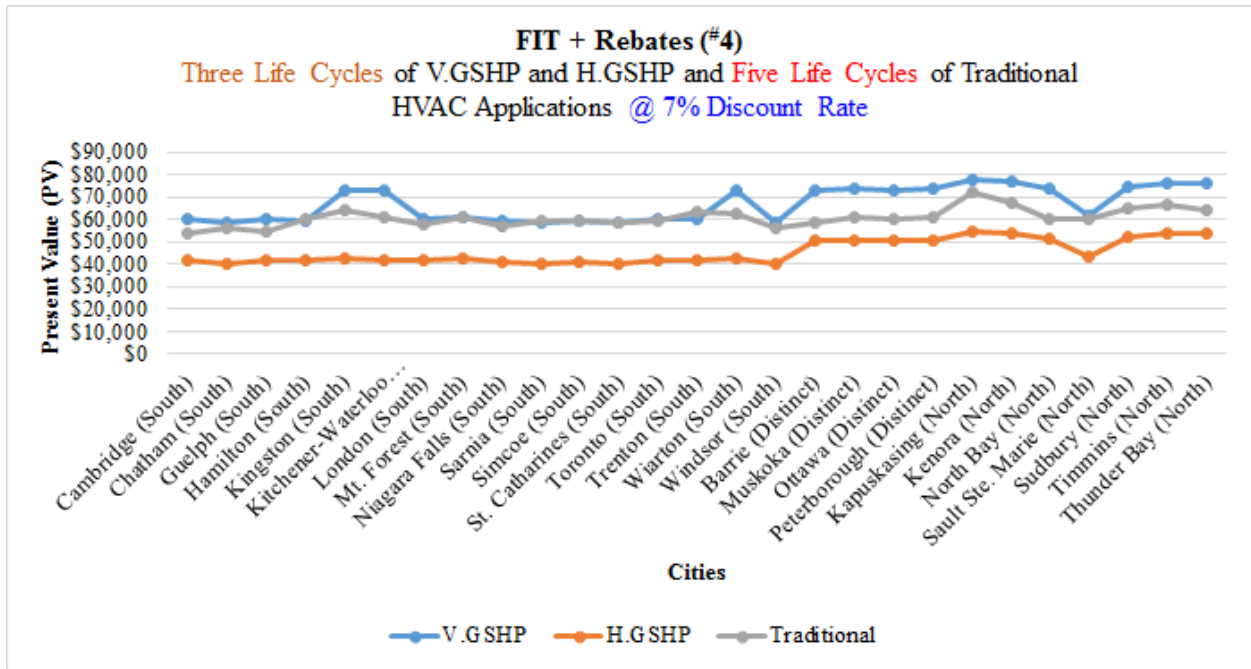

Table E1-1.47: Economic Variation of HVAC technologies for feed-in tariff + rebates scenario (average construction type) at a discount rate of 7% (three life cycles of V.GSHP and H.GSHP and five life cycles of Traditional HVAC Applications for a 60 year project lifespan)

(FIT + Rebates) + Carbon Taxes – (#5)

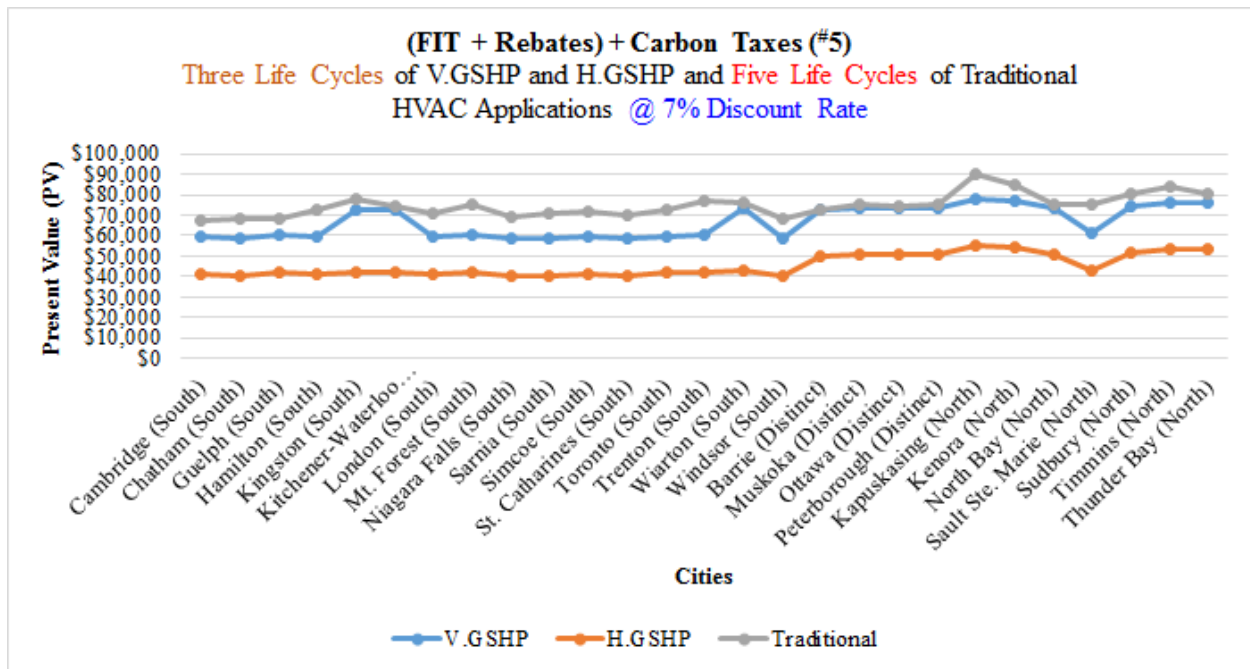

Table E1-1.48: Economic Variation of HVAC technologies for feed-in tariff + rebates + carbon tax scenario (average construction type) at a discount rate of 7% (three life cycles of V.GSHP and H.GSHP and five life cycles of Traditional HVAC Applications for a 60 year project lifespan)

9. Three Life Cycles of V.GSHP and H.GSHP and Five Life Cycles of Traditional HVAC Applications @ 7.5% Discount Rate

Base Case Scenario

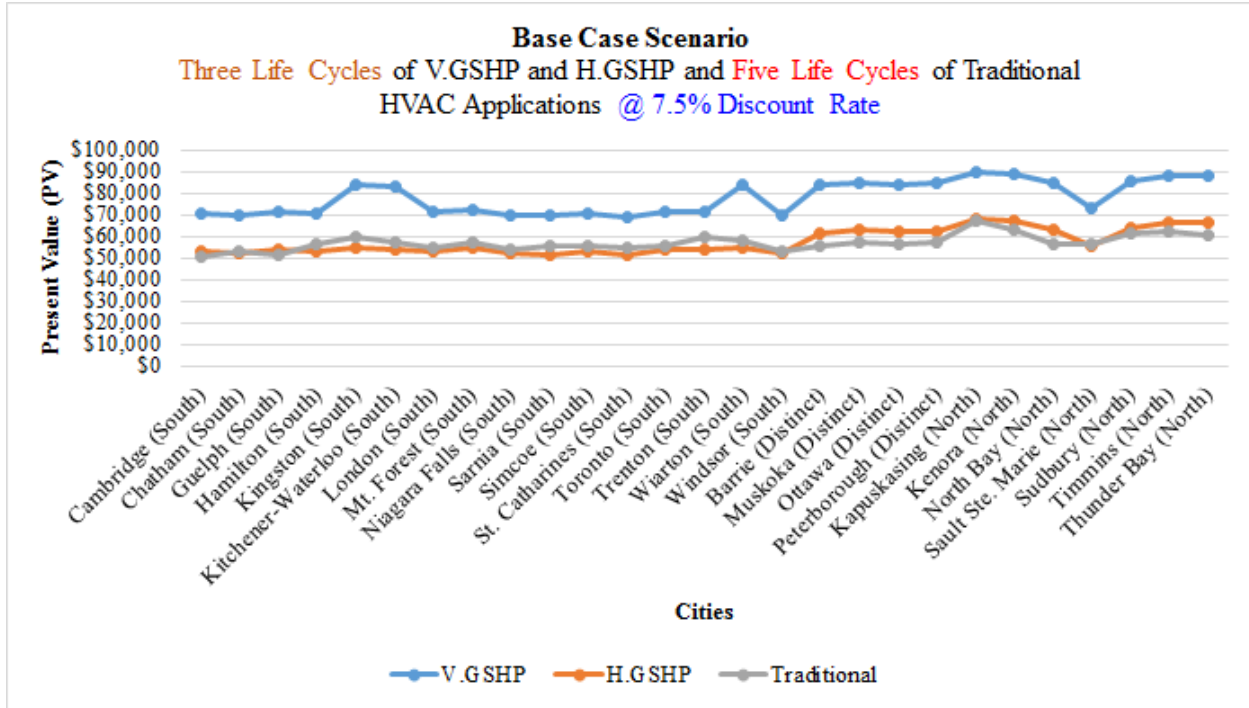

Table E1-1.49: Economic Variation of HVAC technologies for base case scenario (average construction type) at a discount rate of 7.5% (three life cycles of V.GSHP and H.GSHP and five life cycles of Traditional HVAC Applications for a 60 year project lifespan)

Carbon Taxes – (#1)

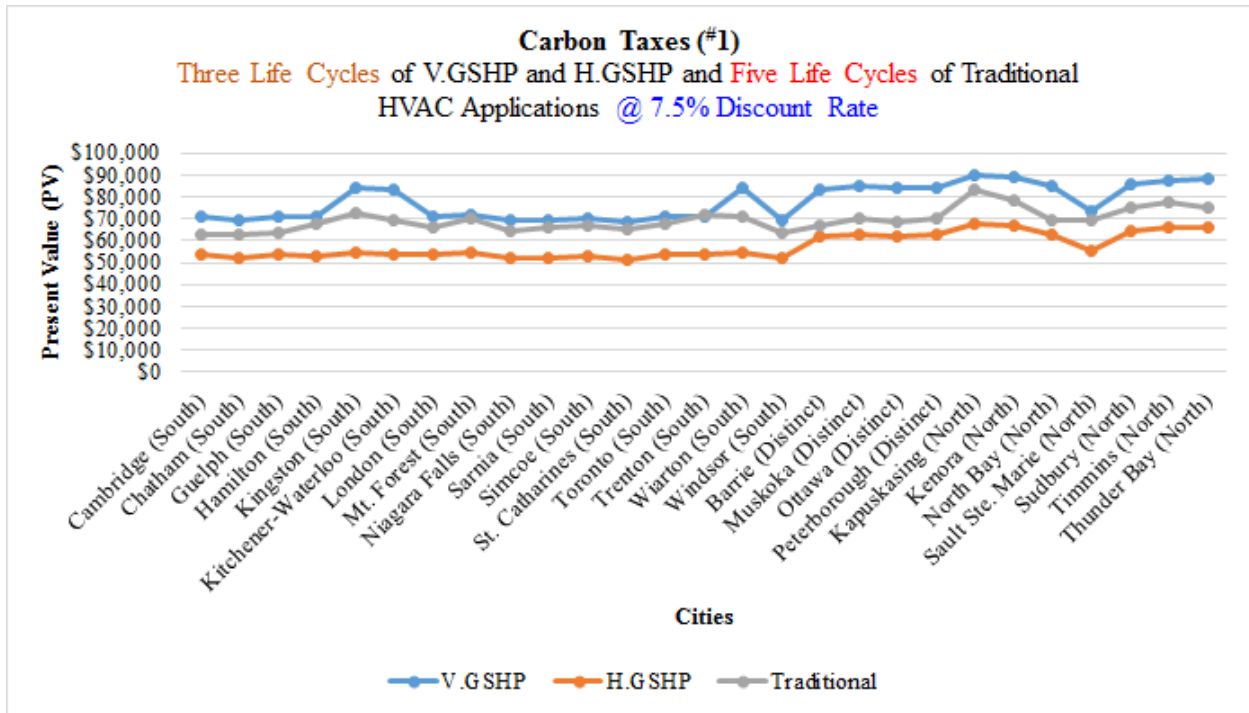

Table E1-1.50: Economic Variation of HVAC technologies for carbon taxes scenario (average construction type) at a discount rate of 7.5% (three life cycles of V.GSHP and H.GSHP and five life cycles of Traditional HVAC Applications for a 60 year project lifespan)

FIT – (#2)

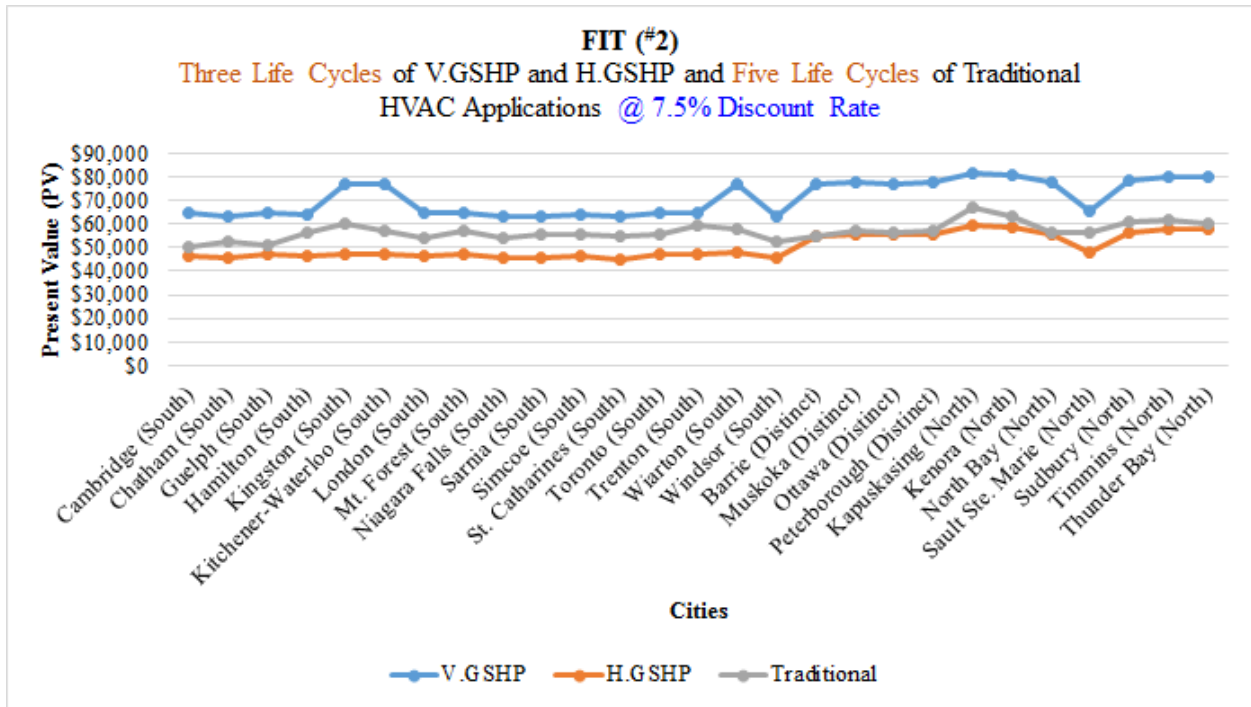

Table E1-1.51: Economic Variation of HVAC technologies for feed-in tariff scenario (average construction type) at a discount rate of 7.5% (three life cycles of V.GSHP and H.GSHP and five life cycles of Traditional HVAC Applications for a 60 year project lifespan)

Rebates – (#3)

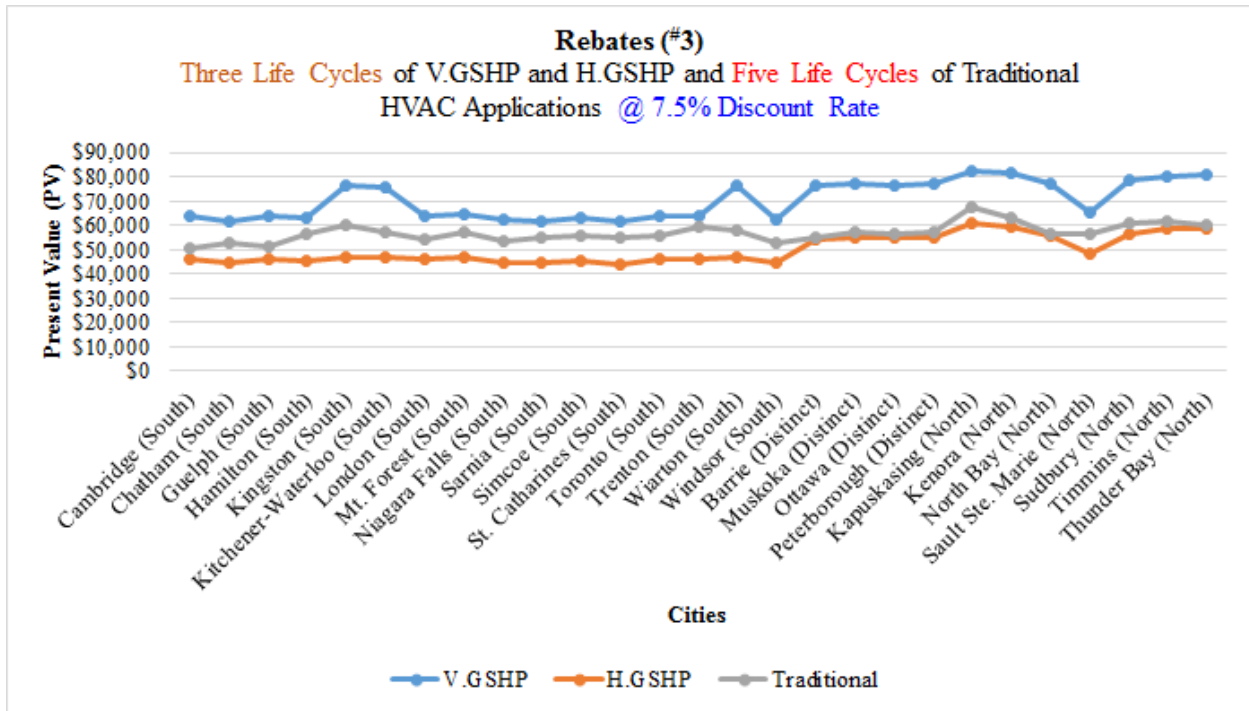

Table E1-1.52: Economic Variation of HVAC technologies for rebates scenario (average construction type) at a discount rate of 7.5% (three life cycles of V.GSHP and H.GSHP and five life cycles of Traditional HVAC Applications for a 60 year project lifespan)

FIT + Rebates – (#4)

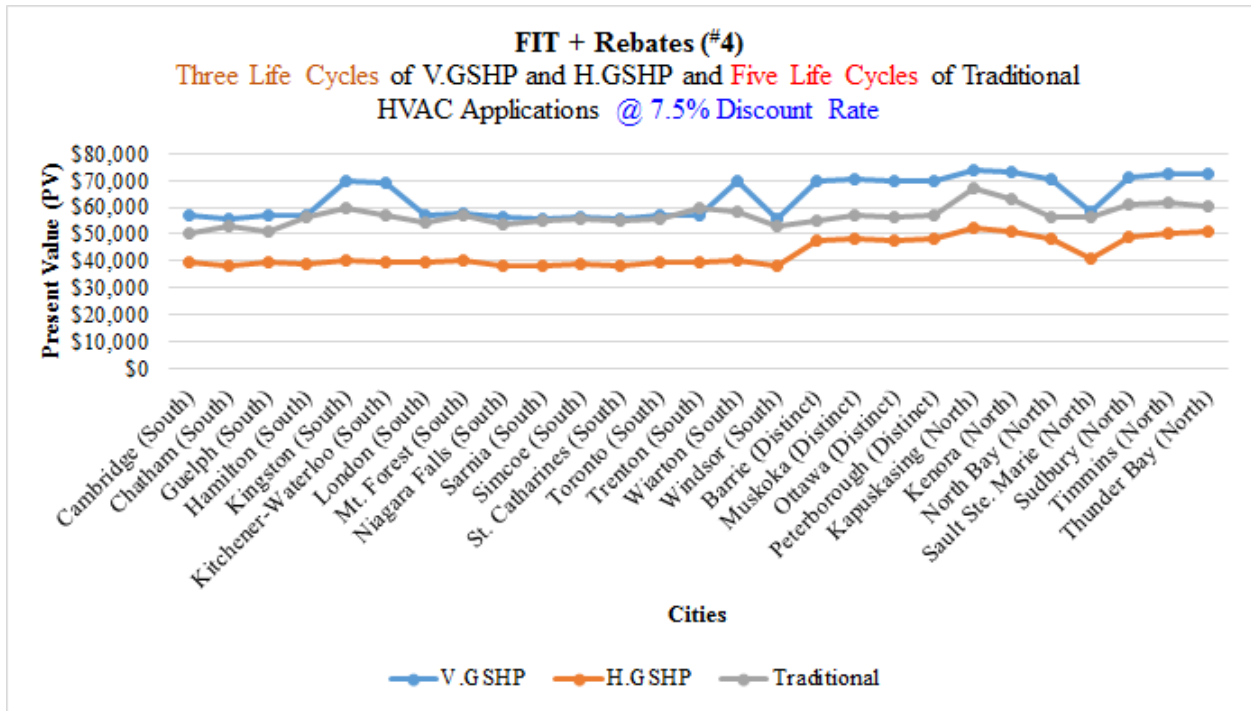

Table E1-1.53: Economic Variation of HVAC technologies for feed-in tariff + rebates scenario (average construction type) at a discount rate of 7.5% (three life cycles of V.GSHP and H.GSHP and five life cycles of Traditional HVAC Applications for a 60 year project lifespan)

(FIT + Rebates) + Carbon Taxes – (#5)

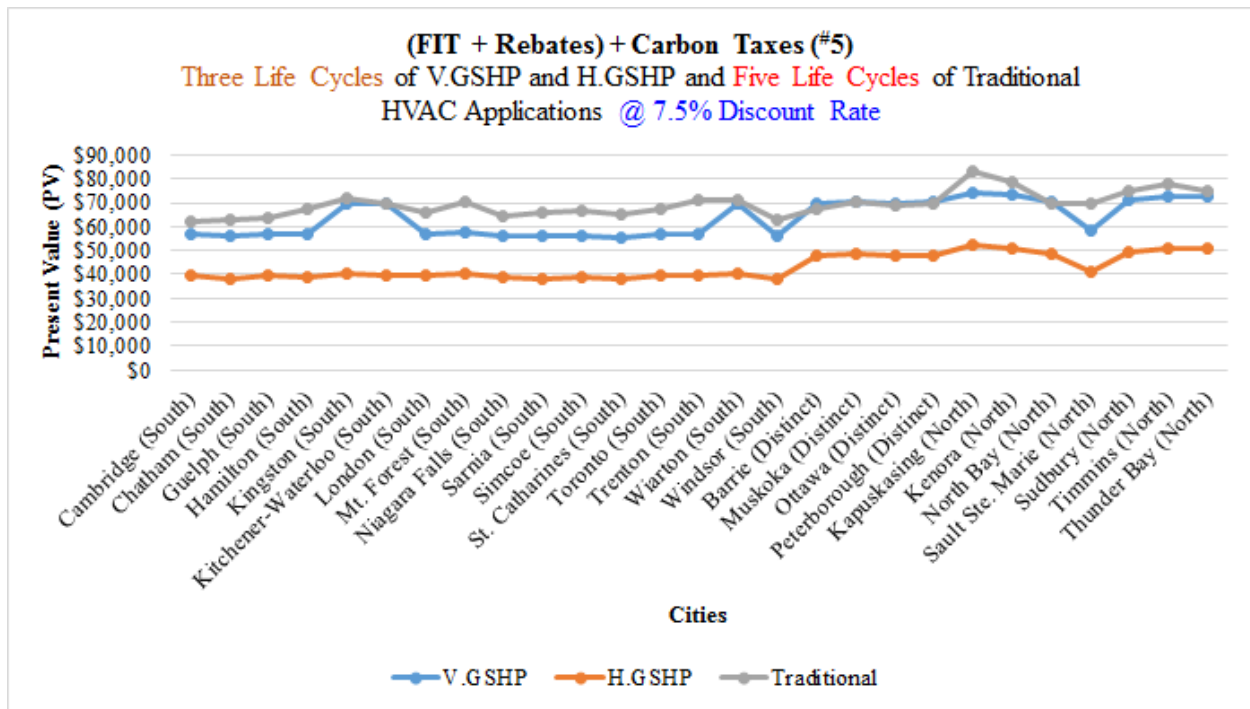

Table E1-1.54: Economic Variation of HVAC technologies for feed-in tariff + rebates + carbon tax scenario (average construction type) at a discount rate of 7.5% (three life cycles of V.GSHP and H.GSHP and five life cycles of Traditional HVAC Applications for a 60 year project lifespan)

10. Three Life Cycles of V.GSHP and H.GSHP and Five Life Cycles of Traditional HVAC Applications @ 8.5% Discount Rate

Base Case Scenario

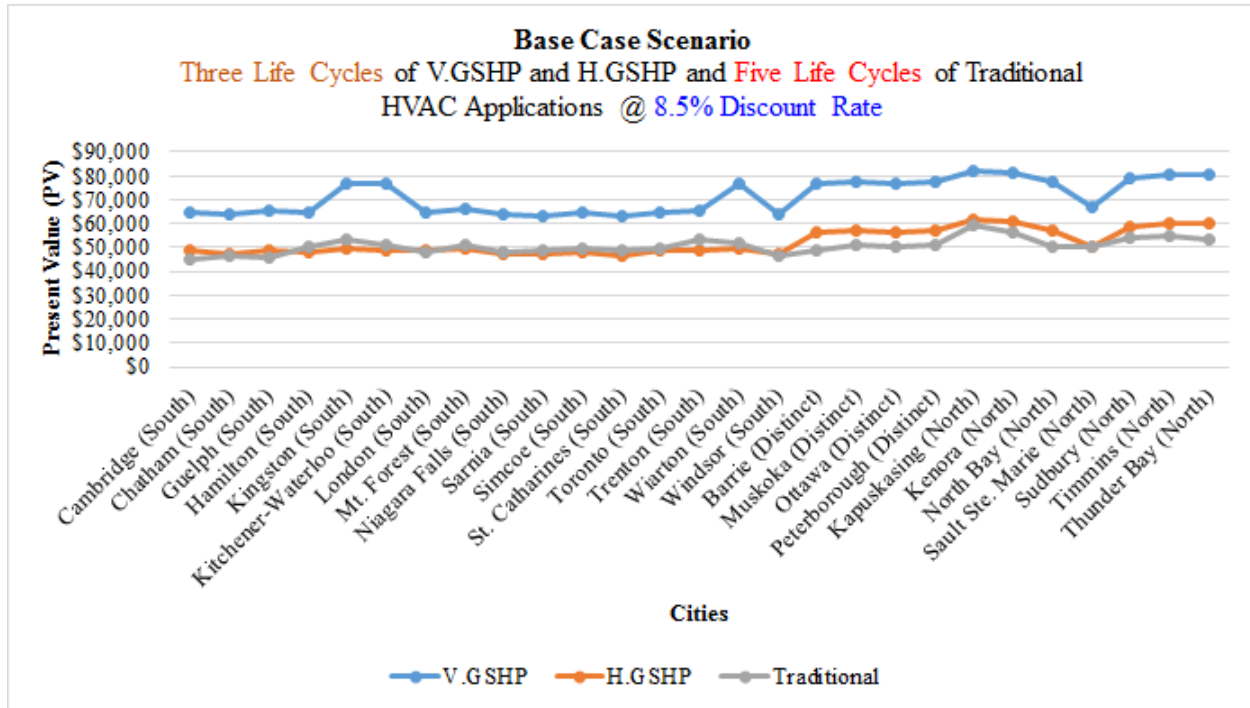

Table E1-1.55: Economic Variation of HVAC technologies for base case scenario (average construction type) at a discount rate of 8.5% (three life cycles of V.GSHP and H.GSHP and five life cycles of Traditional HVAC Applications for a 60 year project lifespan)

Carbon Taxes – (#1)

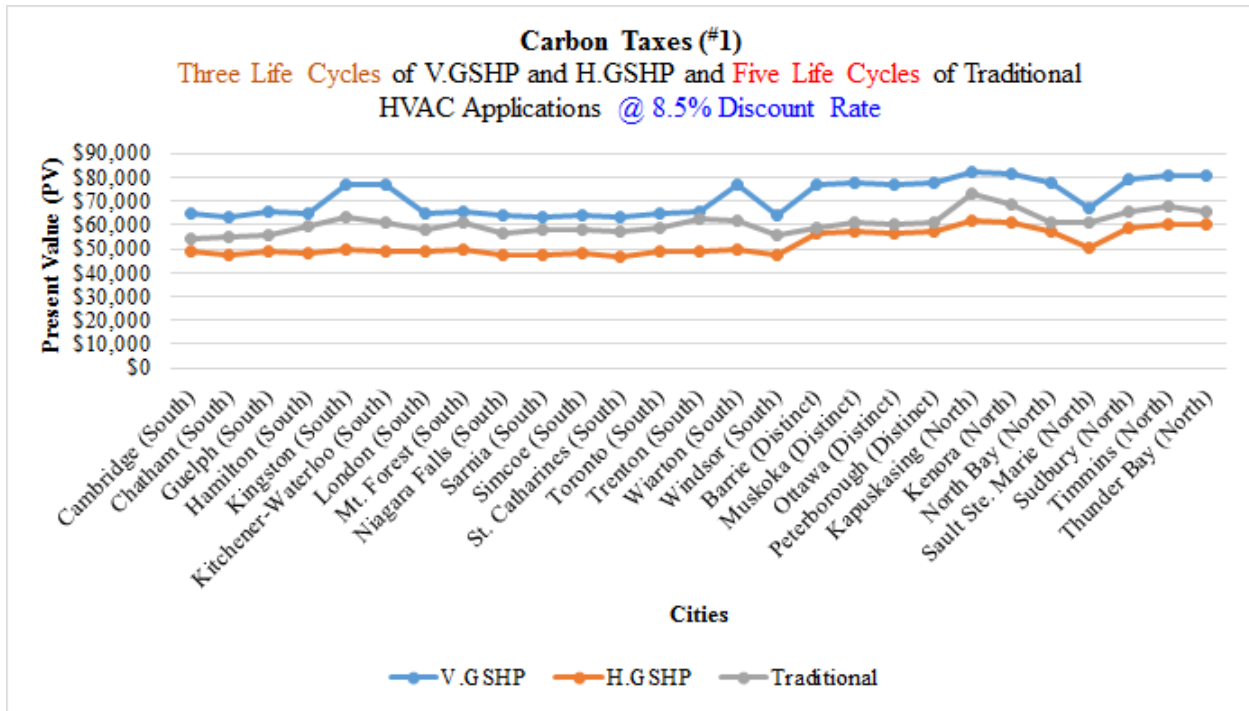

Table E1-1.56: Economic Variation of HVAC technologies for carbon taxes scenario (average construction type) at a discount rate of 8.5% (three life cycles of V.GSHP and H.GSHP and five life cycles of Traditional HVAC Applications for a 60 year project lifespan)

FIT – (#2)

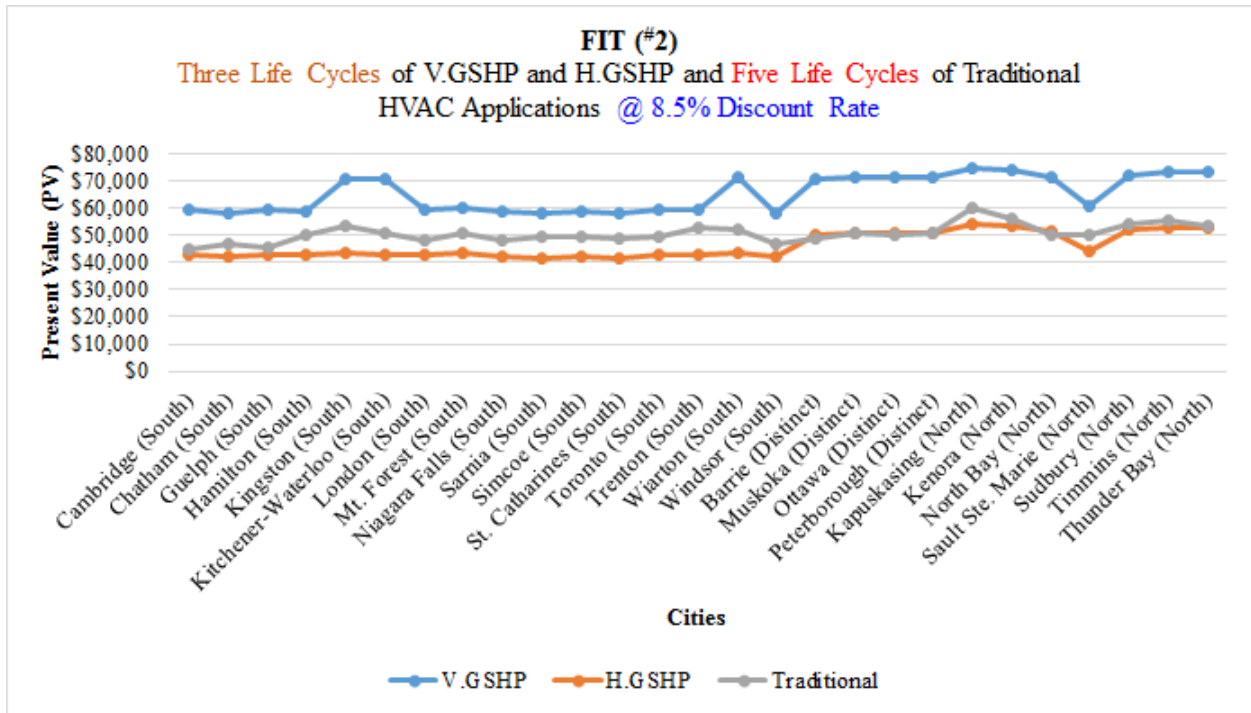

Table E1-1.57: Economic Variation of HVAC technologies for feed-in tariff scenario (average construction type) at a discount rate of 8.5% (three life cycles of V.GSHP and H.GSHP and five life cycles of Traditional HVAC Applications for a 60 year project lifespan)

Rebates – (#3)

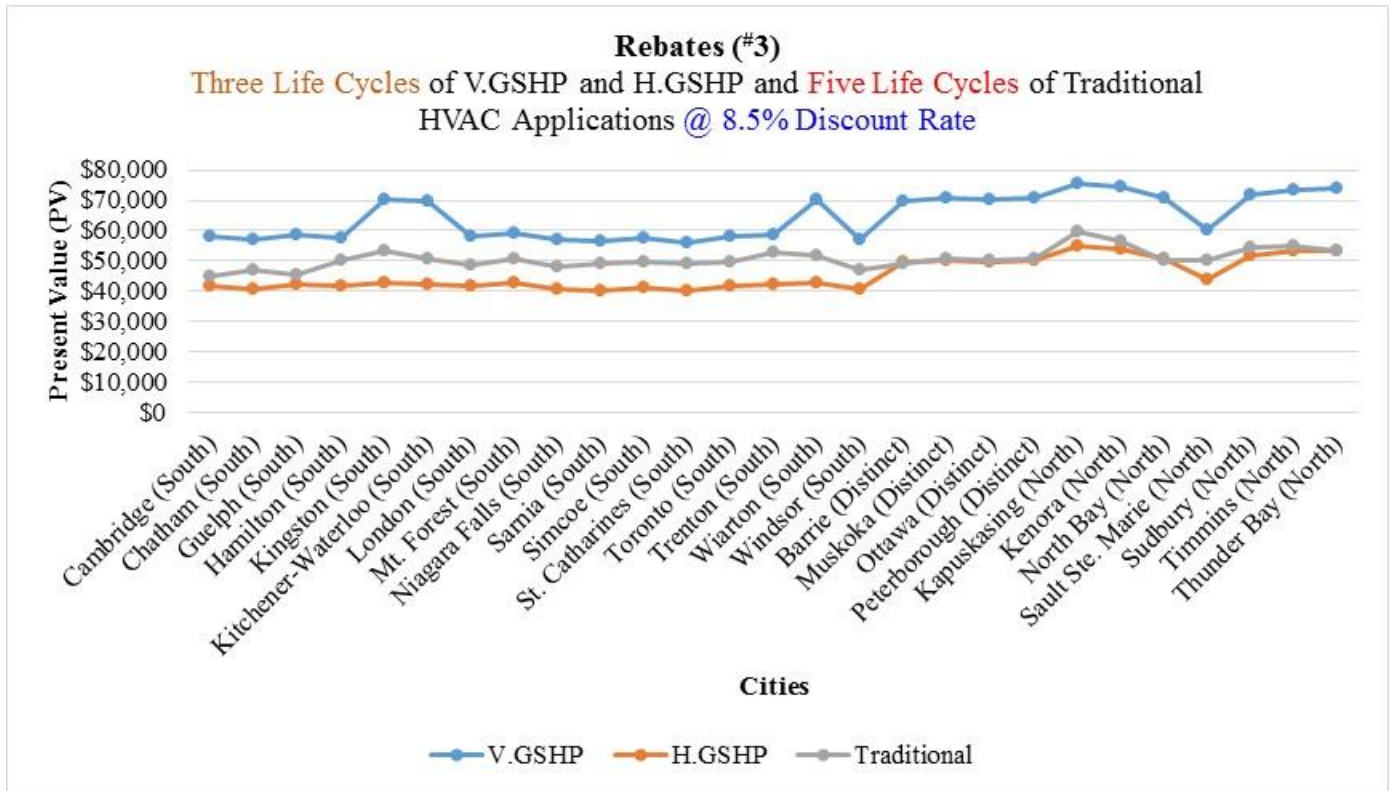

Table E1-1.58: Economic Variation of HVAC technologies for rebates scenario (average construction type) at a discount rate of 8.5% (three life cycles of V.GSHP and H.GSHP and five life cycles of Traditional HVAC Applications for a 60 year project lifespan)

FIT + Rebates – (#4)

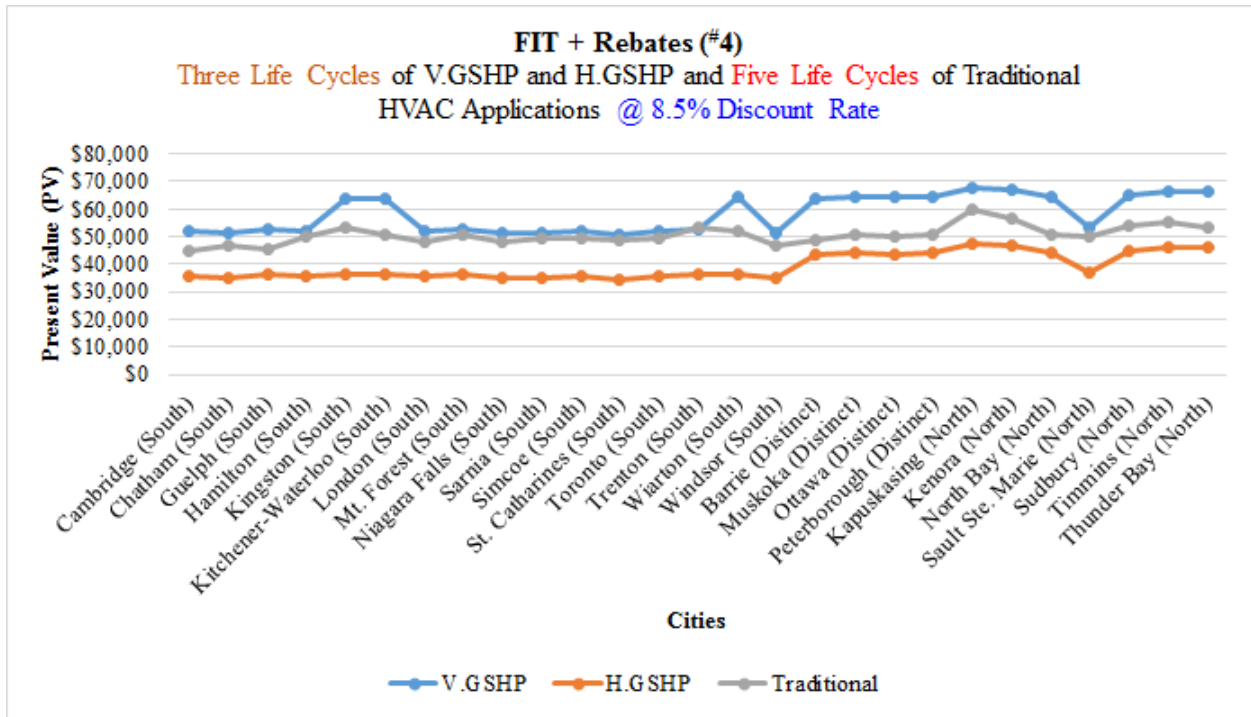

Table E1-1.59: Economic Variation of HVAC technologies for feed-in tariff + rebates scenario (average construction type) at a discount rate of 8.5% (three life cycles of V.GSHP and H.GSHP and five life cycles of Traditional HVAC Applications for a 60 year project lifespan)

(FIT + Rebates) + Carbon Taxes – (#5)

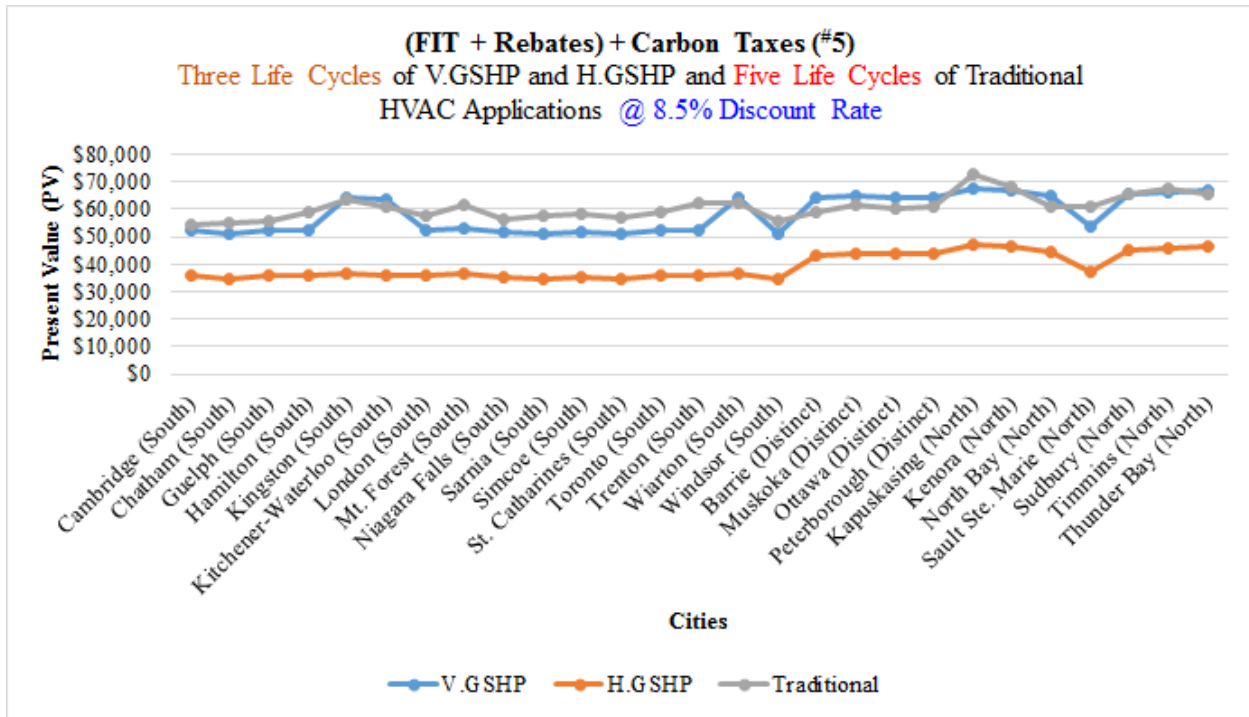

Table E1-1.60: Economic Variation of HVAC technologies for feed-in tariff + rebates + carbon tax scenario (average construction type) at a discount rate of 8.5% (three life cycles of V.GSHP and H.GSHP and five life cycles of Traditional HVAC Applications for a 60 year project lifespan)

11. Three Life Cycles of V.GSHP and H.GSHP and Five Life Cycles of Traditional HVAC Applications @ 10% Discount Rate

Base Case Scenario

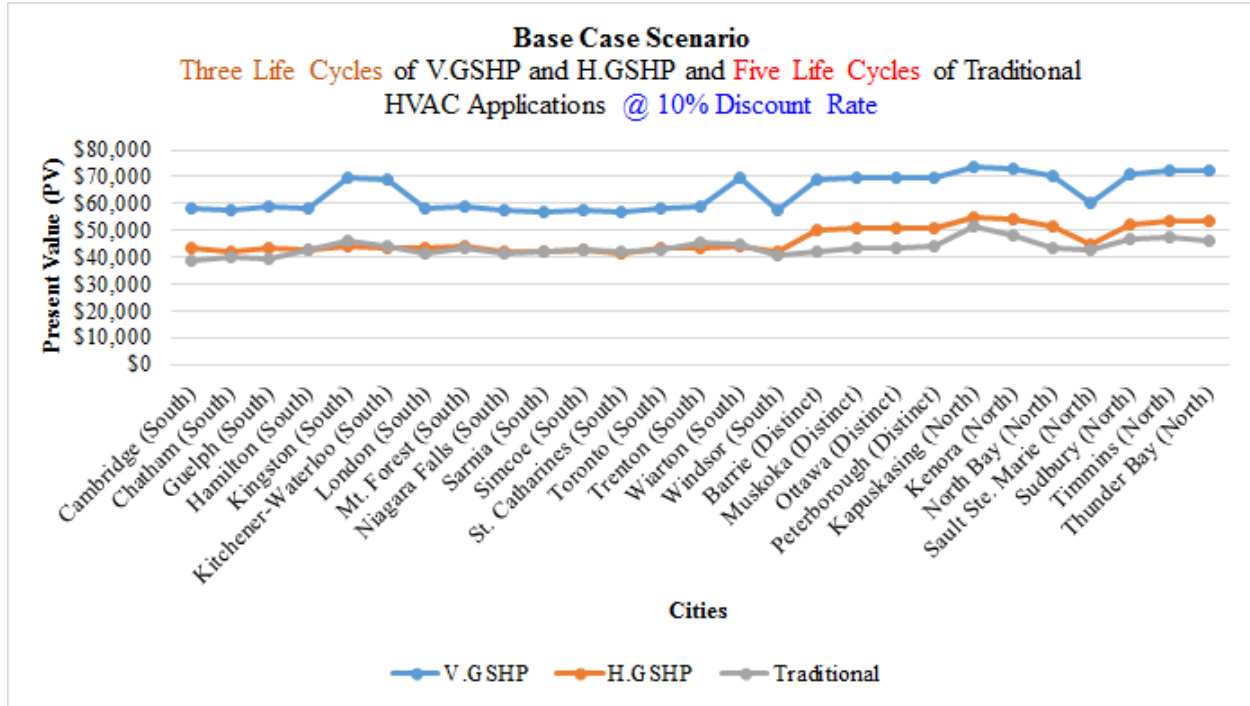

Table E1-1.61: Economic Variation of HVAC technologies for base case scenario (average construction type) at a discount rate of 10% (three life cycles of V.GSHP and H.GSHP and five life cycles of Traditional HVAC Applications for a 60 year project lifespan)

Carbon Taxes – (#1)

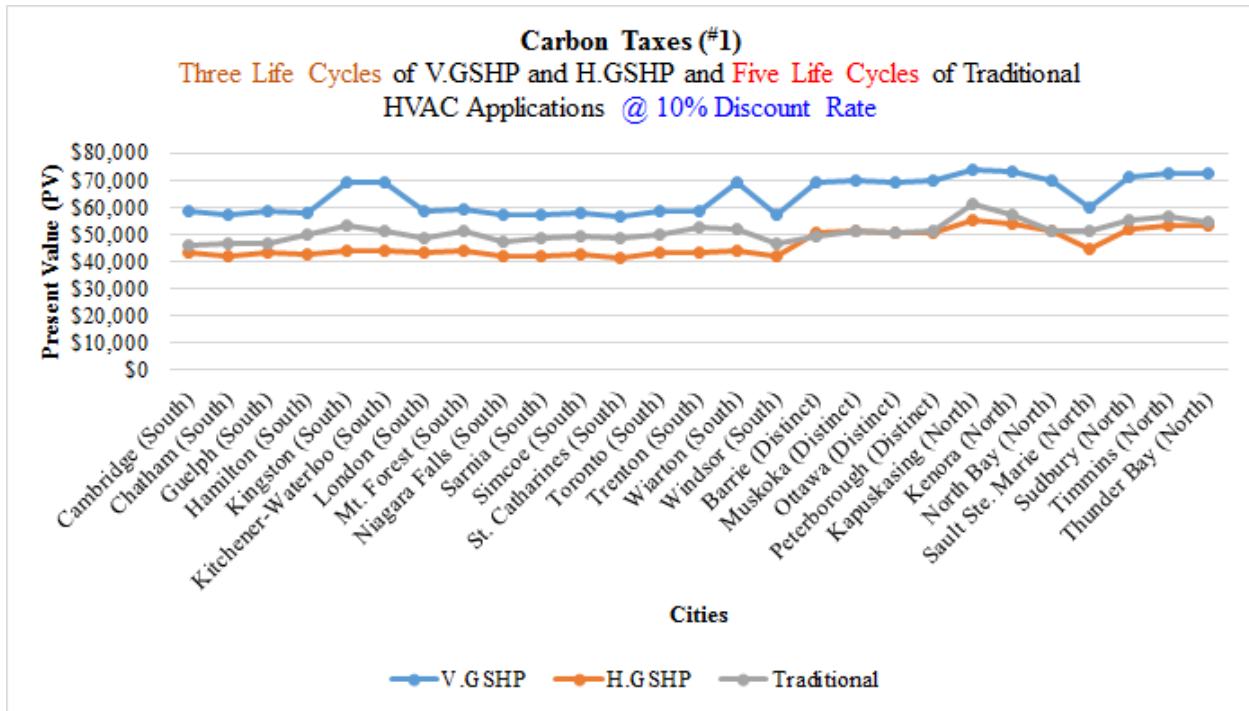

Table E1-1.62: Economic Variation of HVAC technologies for carbon taxes scenario (average construction type) at a discount rate of 10% (three life cycles of V.GSHP and H.GSHP and five life cycles of Traditional HVAC Applications for a 60 year project lifespan)

FIT – (#2)

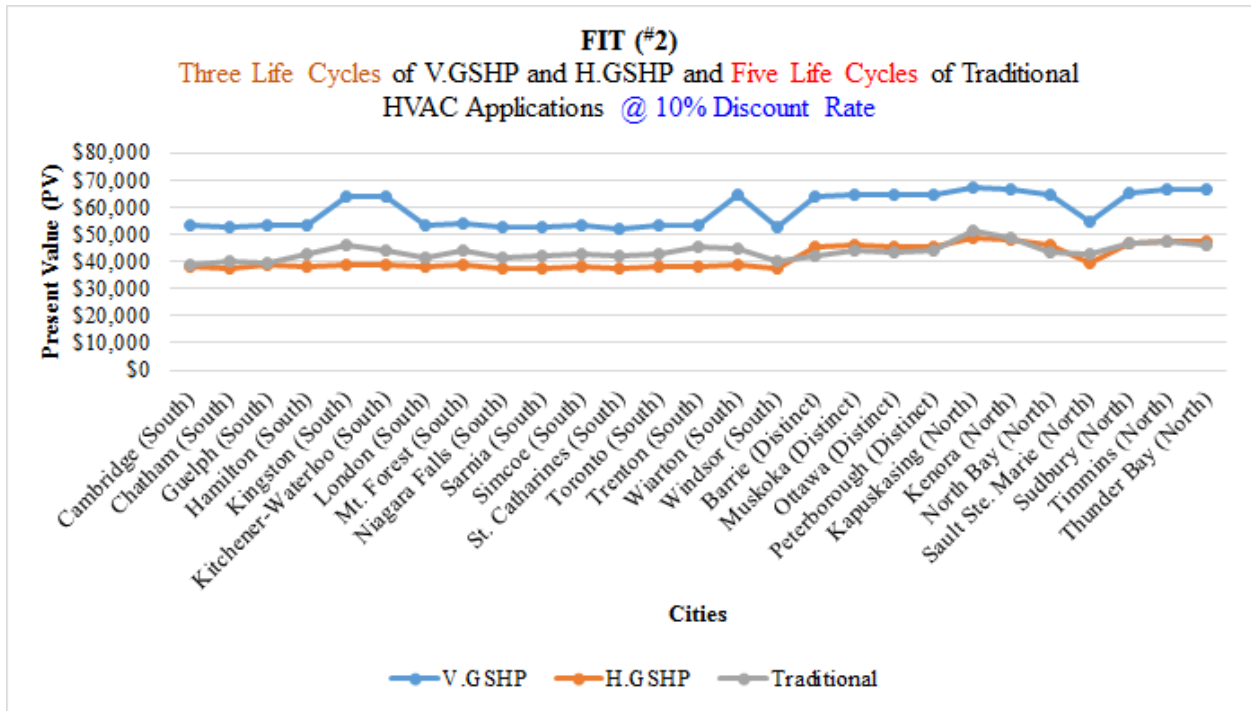

Table E1-1.63: Economic Variation of HVAC technologies for feed-in tariff scenario (average construction type) at a discount rate of 10% (three life cycles of V.GSHP and H.GSHP and five life cycles of Traditional HVAC Applications for a 60 year project lifespan)

Rebates – (#3)

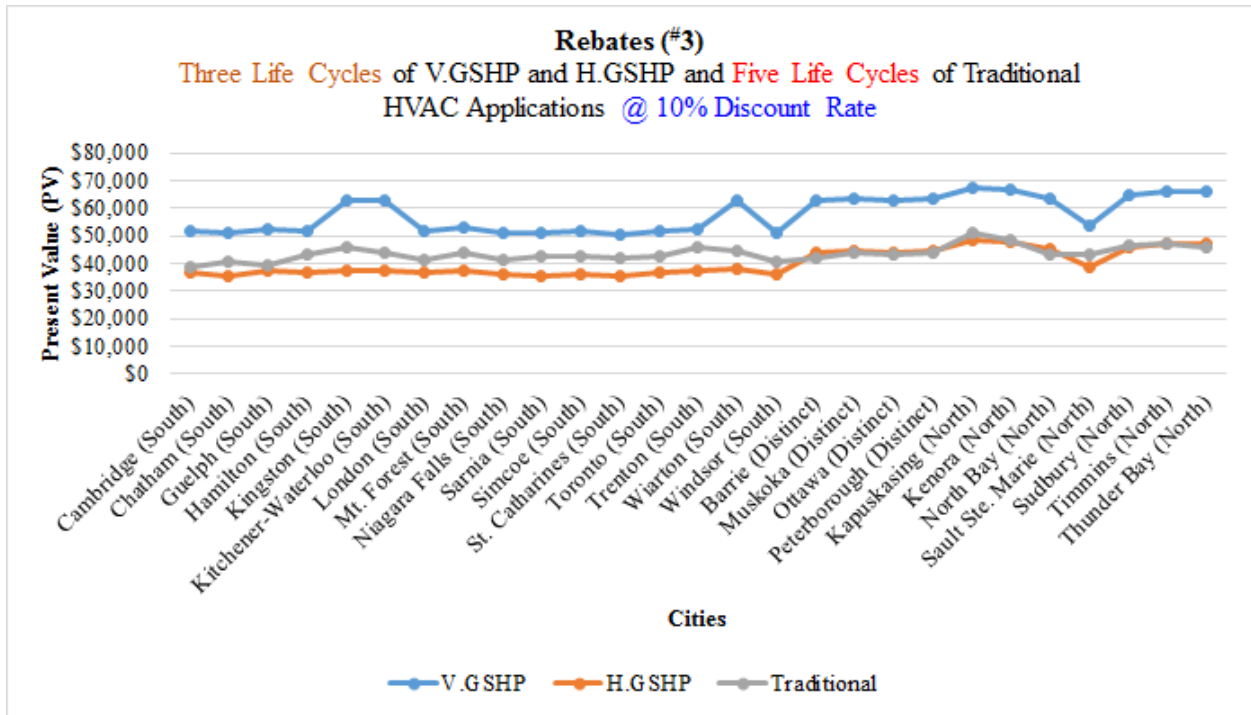

Table E1-1.64: Economic Variation of HVAC technologies for rebates scenario (average construction type) at a discount rate of 10% (three life cycles of V.GSHP and H.GSHP and five life cycles of Traditional HVAC Applications for a 60 year project lifespan)

FIT + Rebates – (#4)

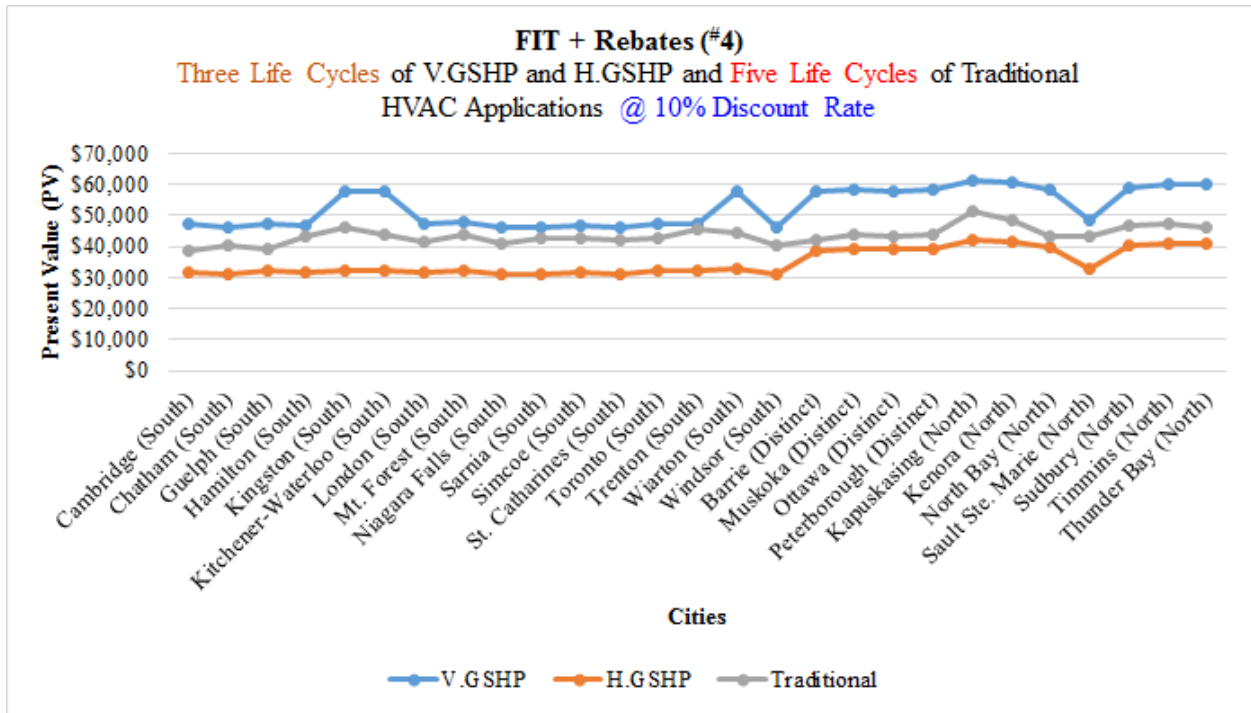

Table E1-1.65: Economic Variation of HVAC technologies for feed-in tariff + rebates scenario (average construction type) at a discount rate of 10% (three life cycles of V.GSHP and H.GSHP and five life cycles of Traditional HVAC Applications for a 60 year project lifespan)

(FIT + Rebates) + Carbon Taxes – (#5)

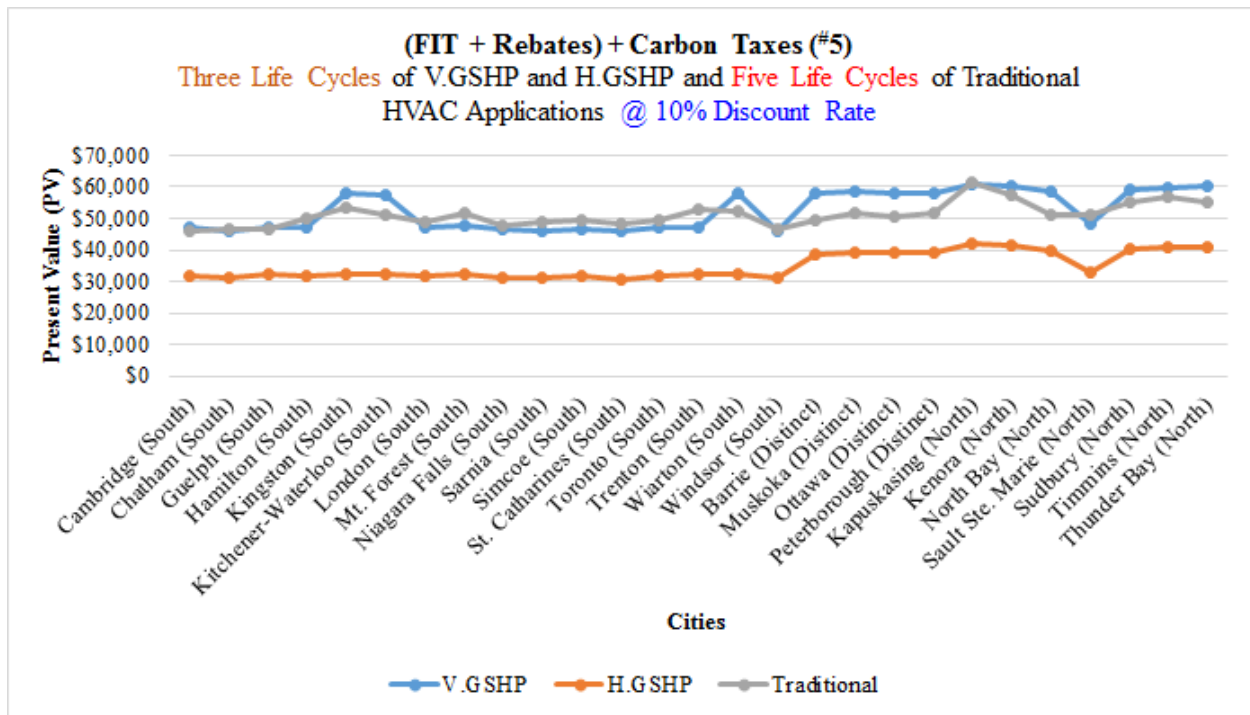

Table E1-1.66: Economic Variation of HVAC technologies for feed-in tariff + rebates + carbon tax scenario (average construction type) at a discount rate of 10% (three life cycles of V.GSHP and H.GSHP and five life cycles of Traditional HVAC Applications for a 60 year project lifespan)

12. Three Life Cycles of V.GSHP and H.GSHP and Five Life Cycles of Traditional HVAC Applications @ 12% Discount Rate

Base Case Scenario

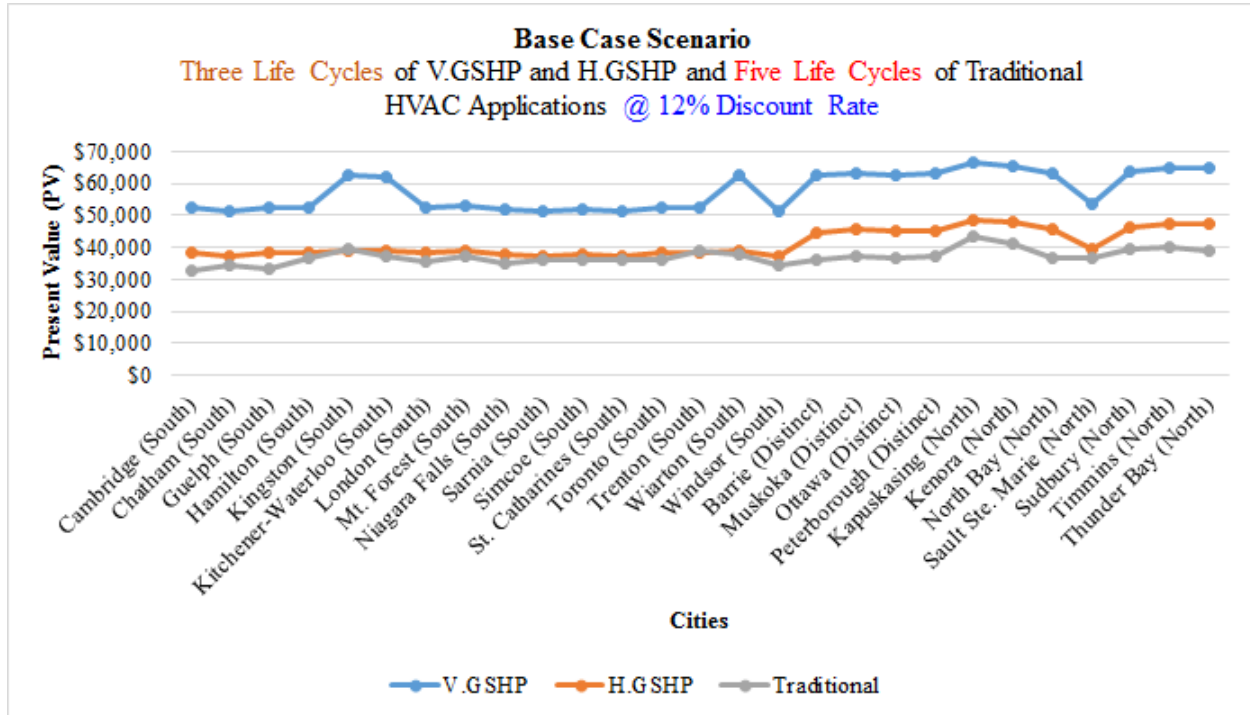

Table E1-1.67: Economic Variation of HVAC technologies for base case scenario (average construction type) at a discount rate of 12% (three life cycles of V.GSHP and H.GSHP and five life cycles of Traditional HVAC Applications for a 60 year project lifespan)

Carbon Taxes – (#1)

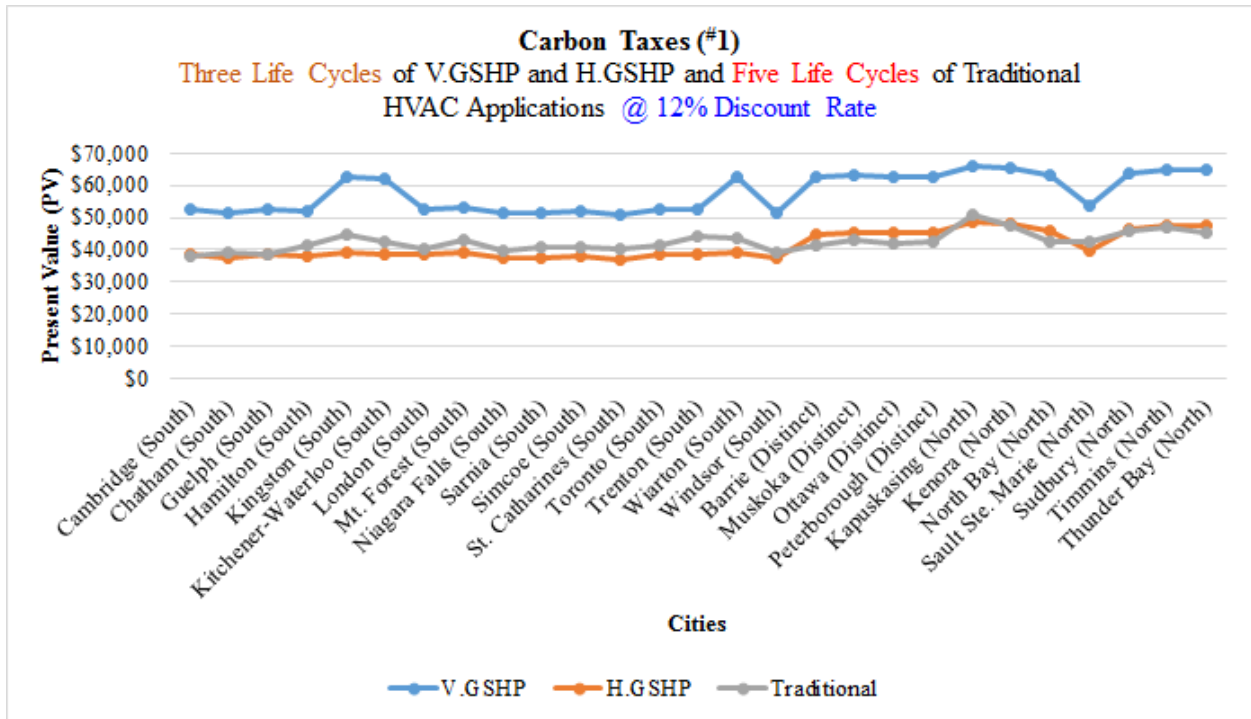

Table E1-1.68: Economic Variation of HVAC technologies for carbon taxes scenario (average construction type) at a discount rate of 12% (three life cycles of V.GSHP and H.GSHP and five life cycles of Traditional HVAC Applications for a 60 year project lifespan)

FIT – (#2)

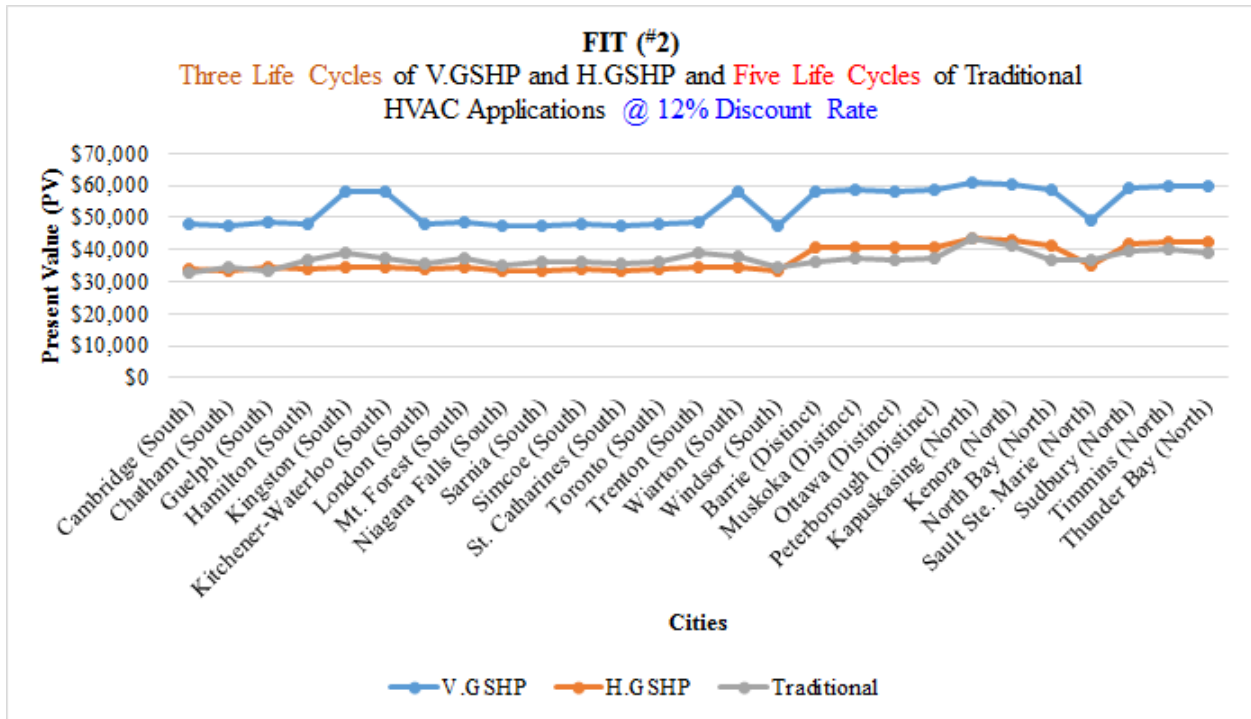

Table E1-1.69: Economic Variation of HVAC technologies for feed-in tariff scenario (average construction type) at a discount rate of 12% (three life cycles of V.GSHP and H.GSHP and five life cycles of Traditional HVAC Applications for a 60 year project lifespan)

Rebates – (#3)

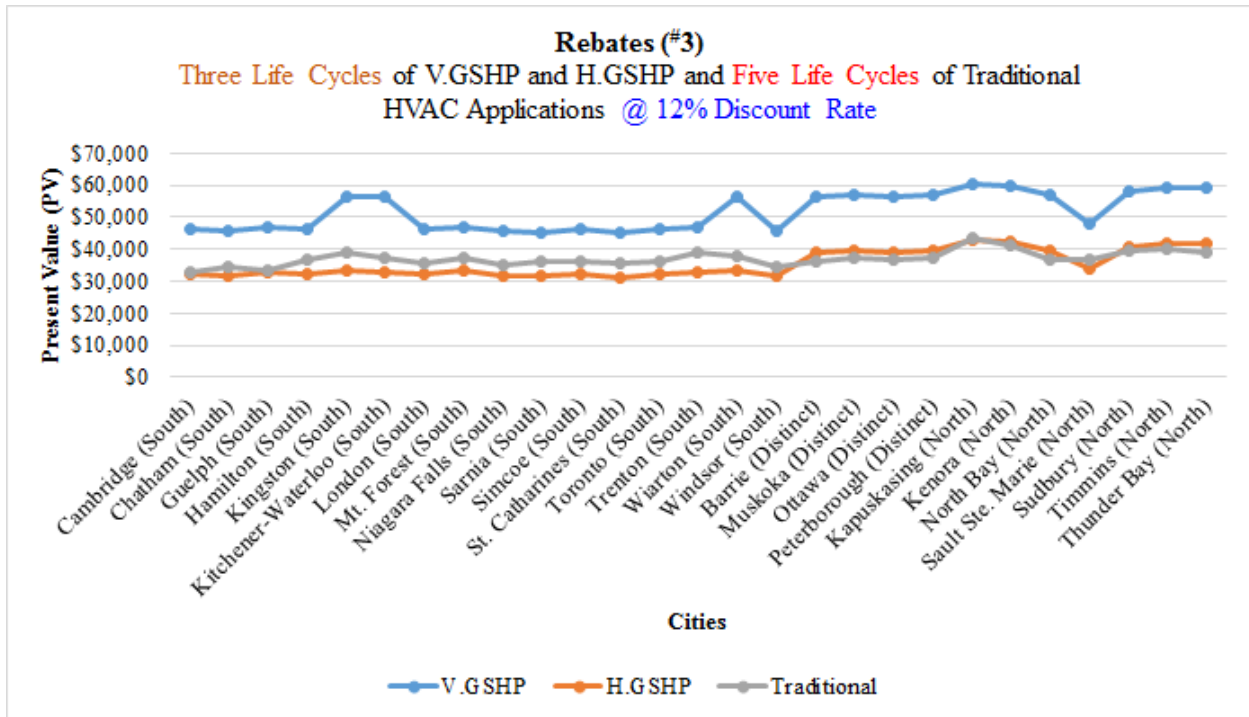

Table E1-1.70: Economic Variation of HVAC technologies for rebates scenario (average construction type) at a discount rate of 12% (three life cycles of V.GSHP and H.GSHP and five life cycles of Traditional HVAC Applications for a 60 year project lifespan)

FIT + Rebates – (#4)

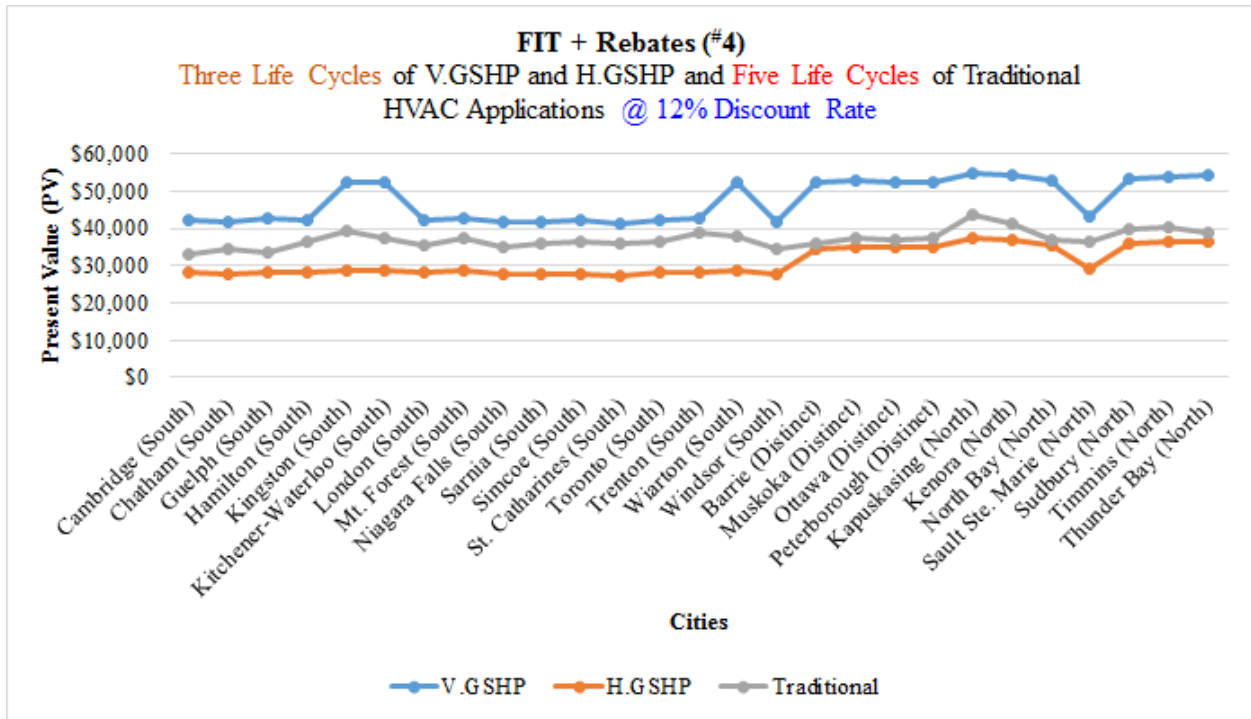

Table E1-1.71: Economic Variation of HVAC technologies for feed-in tariff + rebates scenario (average construction type) at a discount rate of 12% (three life cycles of V.GSHP and H.GSHP and five life cycles of Traditional HVAC Applications for a 60 year project lifespan)

(FIT + Rebates) + Carbon Taxes – (#5)

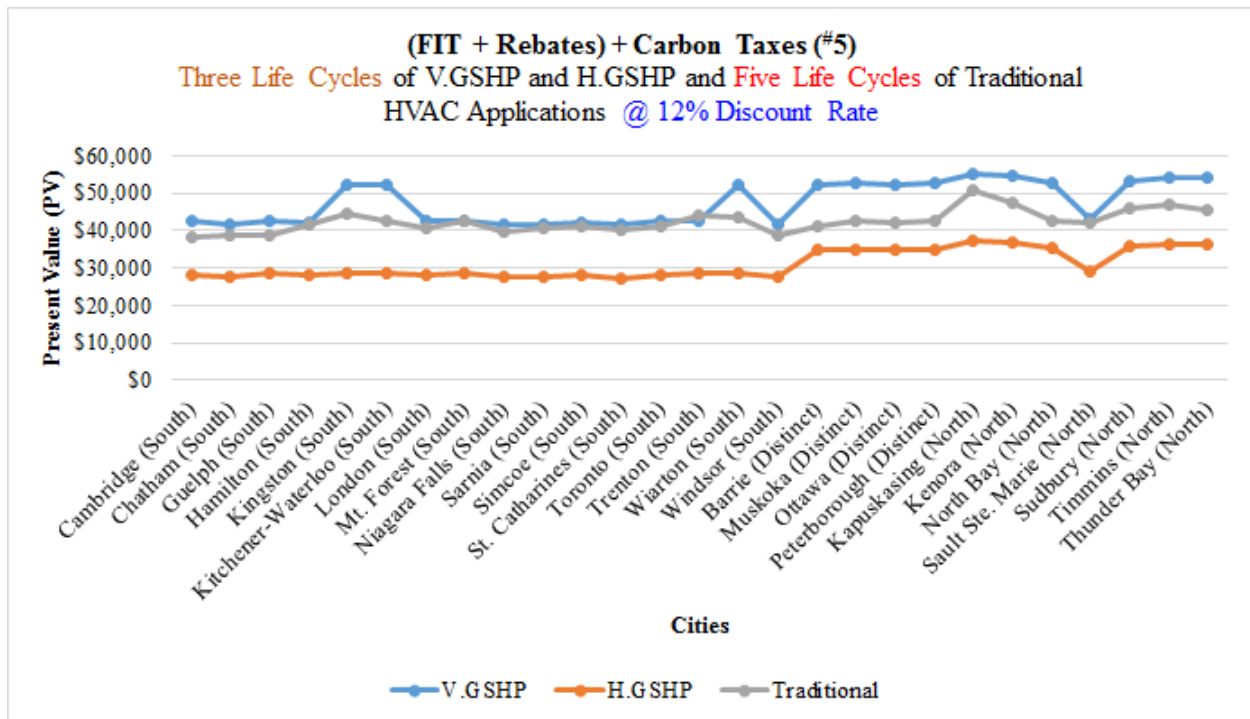

Table E1-1.72: Economic Variation of HVAC technologies for feed-in tariff + rebates + carbon tax scenario (average construction type) at a discount rate of 12% (three life cycles of V.GSHP and H.GSHP and five life cycles of Traditional HVAC Applications for a 60 year project lifespan)

Appendix E2 – Economic Variation of HVAC Technologies for Different Scenarios Based on Present Value at Various Discount Factors – **Improved Construction Type**

1. **Two Life Cycles** of V.GSHP and H.GSHP and **Five Life Cycles** of Traditional HVAC Applications @ **5% Discount Rate**

Base Case Scenario

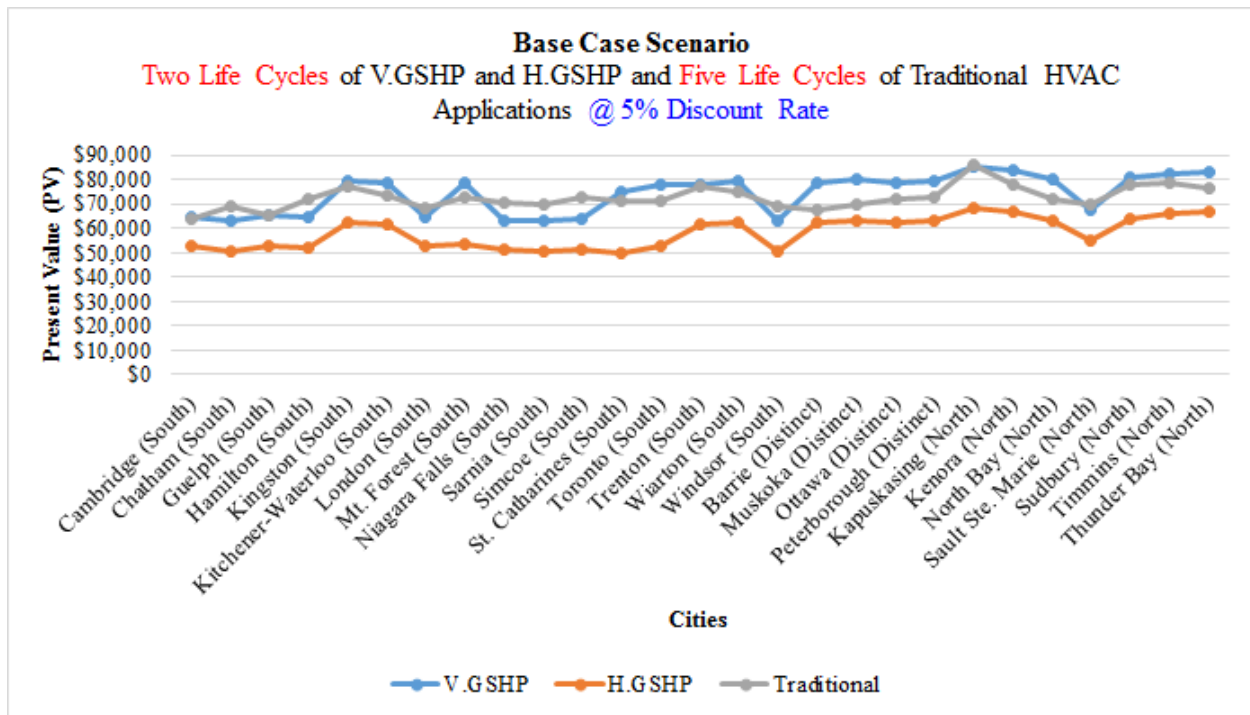

Table E2-1.1: Economic Variation of HVAC technologies for base case scenario (improved construction type) at a discount rate of 5% (two life cycles of V.GSHP and H.GSHP and five life cycles of Traditional HVAC Applications for a 60 year project lifespan)

Carbon Taxes – (#1)

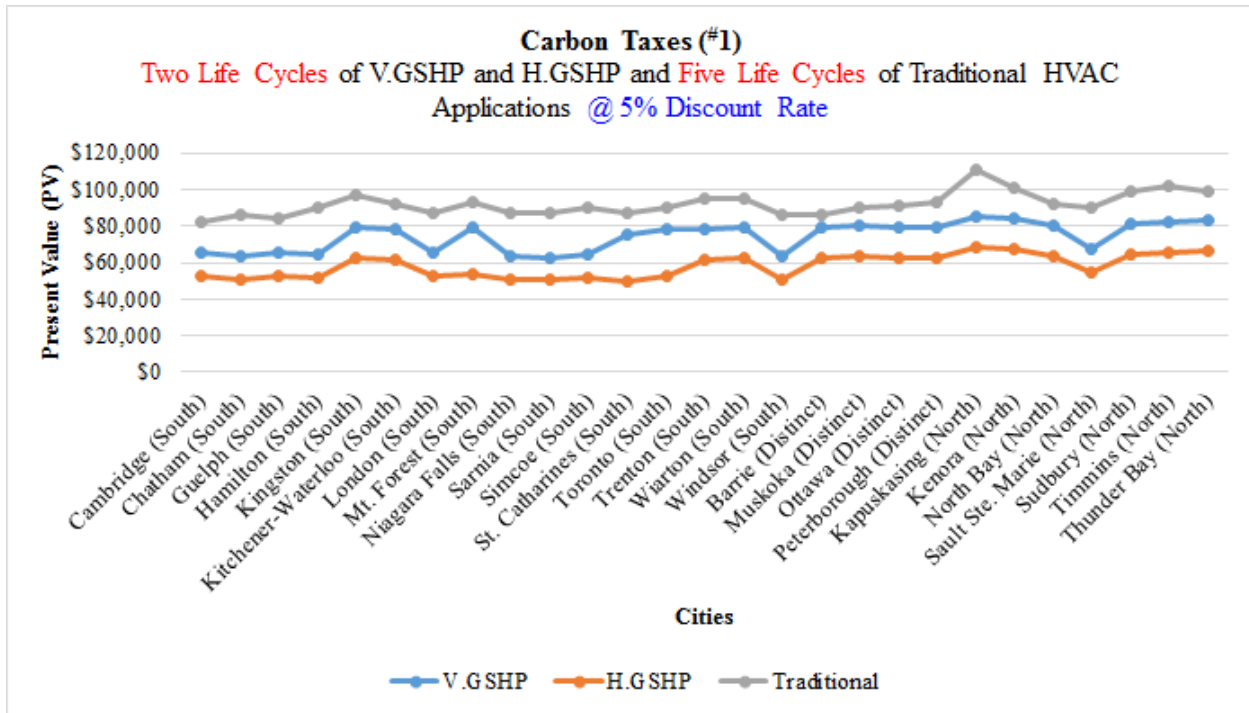

Table E2-1.2: Economic Variation of HVAC technologies for carbon taxes scenario (improved construction type) at a discount rate of 5% (two life cycles of V.GSHP and H.GSHP and five life cycles of Traditional HVAC Applications for a 60 year project lifespan)

FIT – (#2)

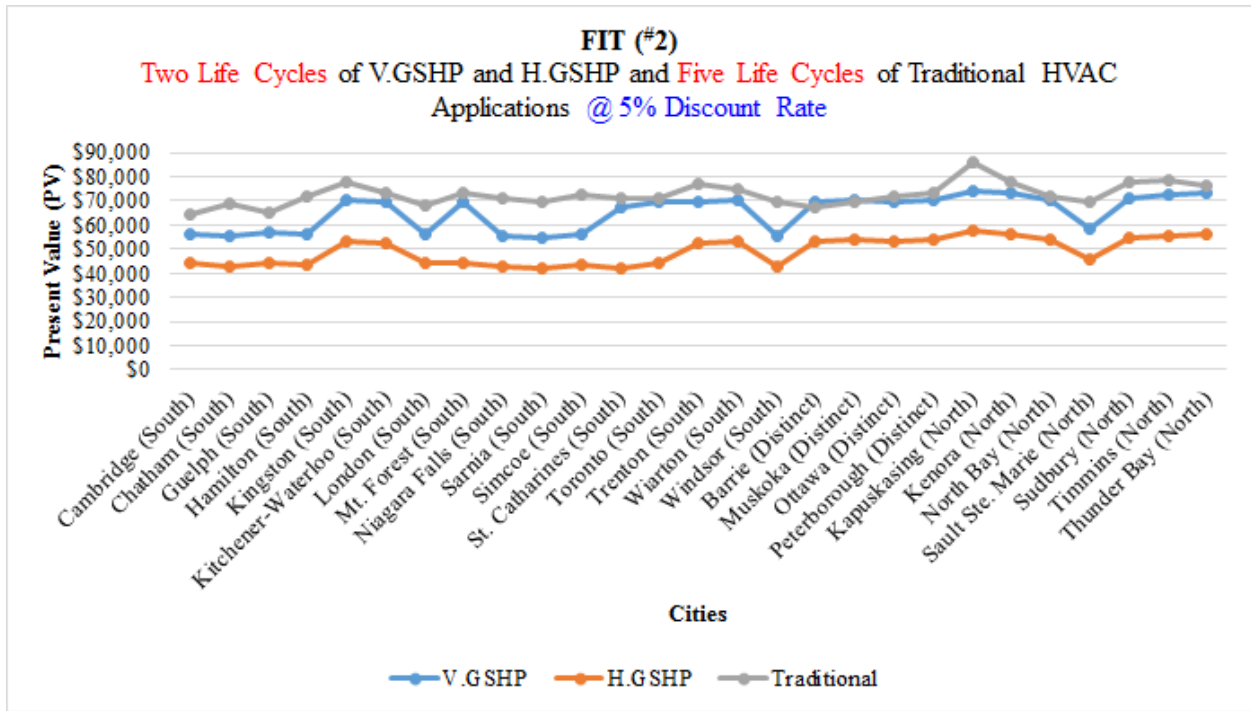

Table E2-1.3: Economic Variation of HVAC technologies for feed-in tariff scenario (improved construction type) at a discount rate of 5% (two life cycles of V.GSHP and H.GSHP and five life cycles of Traditional HVAC Applications for a 60 year project lifespan)

Rebates – (#3)

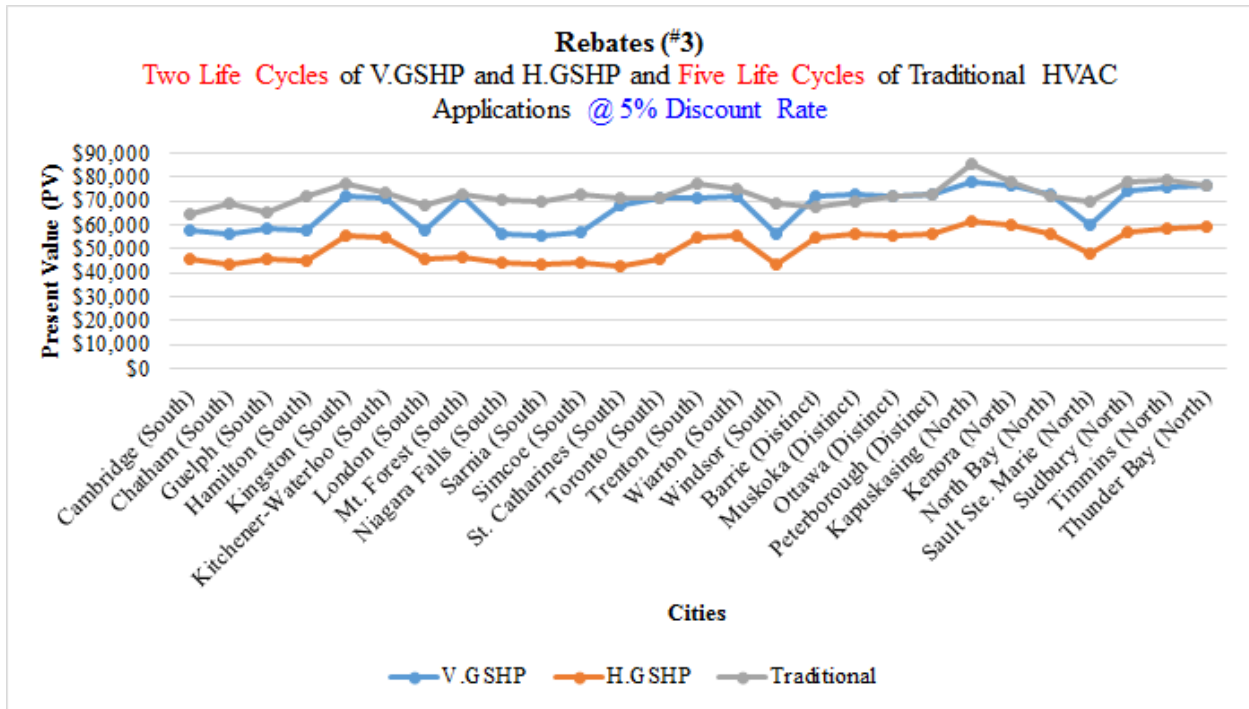

Table E2-1.4: Economic Variation of HVAC technologies for rebates scenario (improved construction type) at a discount rate of 5% (two life cycles of V.GSHP and H.GSHP and five life cycles of Traditional HVAC Applications for a 60 year project lifespan)

FIT + Rebates – (#4)

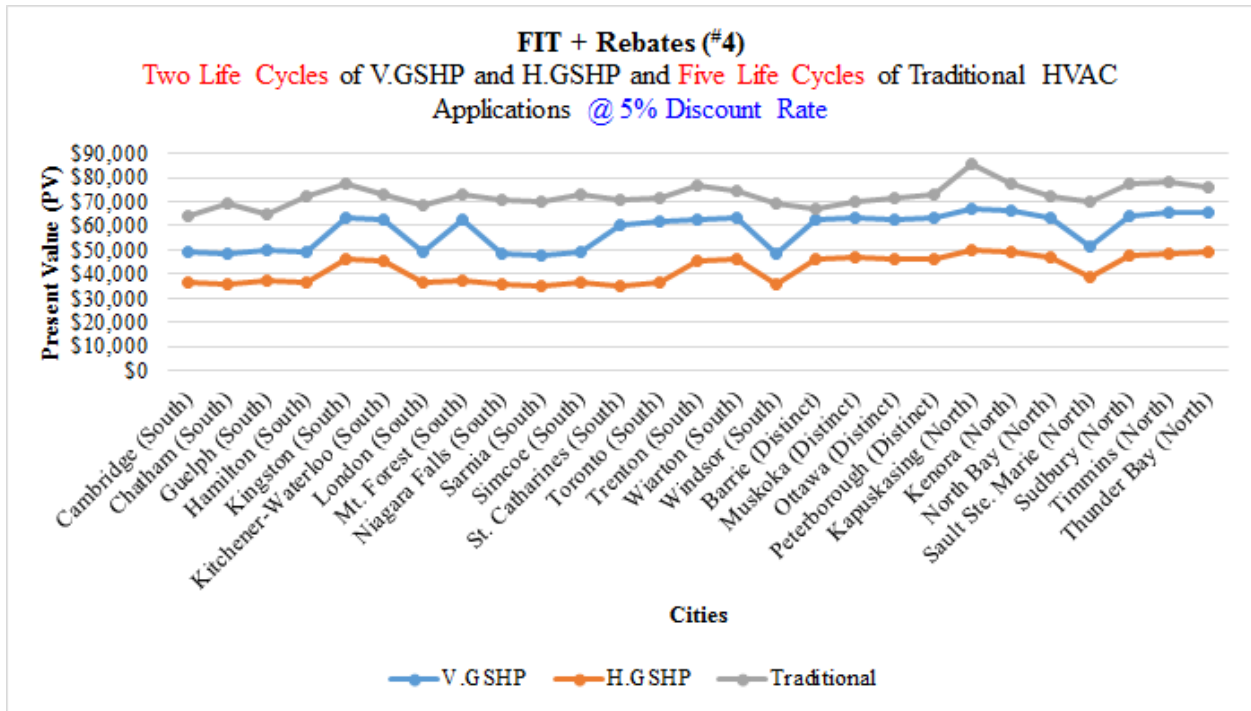

Table E2-1.5: Economic Variation of HVAC technologies for feed-in tariff + rebates scenario (improved construction type) at a discount rate of 5% (two life cycles of V.GSHP and H.GSHP and five life cycles of Traditional HVAC Applications for a 60 year project lifespan)

(FIT + Rebates) + Carbon Taxes – (#5)

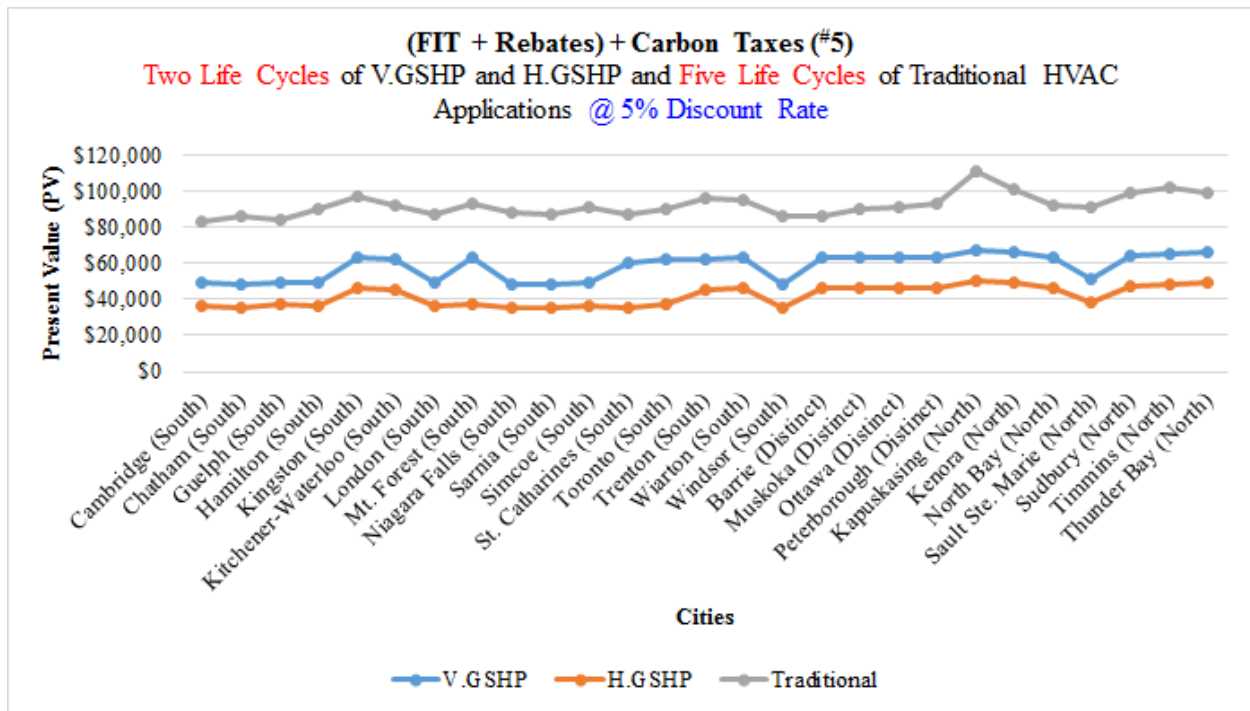

Table E2-1.6: Economic Variation of HVAC technologies for feed-in tariff + rebates + carbon tax scenario (improved construction type) at a discount rate of 5% (two life cycles of V.GSHP and H.GSHP and five life cycles of Traditional HVAC Applications for a 60 year project lifespan)

2. Two Life Cycles of V.GSHP and H.GSHP and Five Life Cycles of Traditional HVAC Applications @ 7% Discount Rate

Base Case Scenario

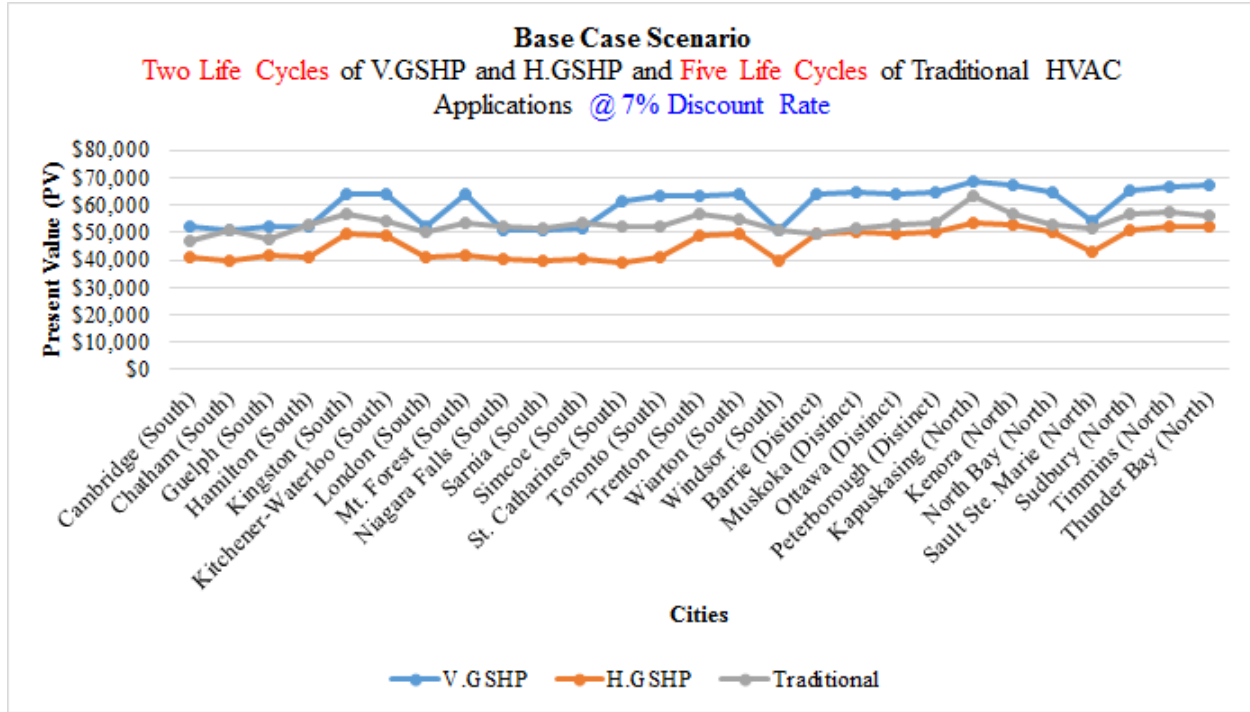

Table E2-1.7: Economic Variation of HVAC technologies for base case scenario (improved construction type) at a discount rate of 7% (two life cycles of V.GSHP and H.GSHP and five life cycles of Traditional HVAC Applications for a 60 year project lifespan)

Carbon Taxes – (#1)

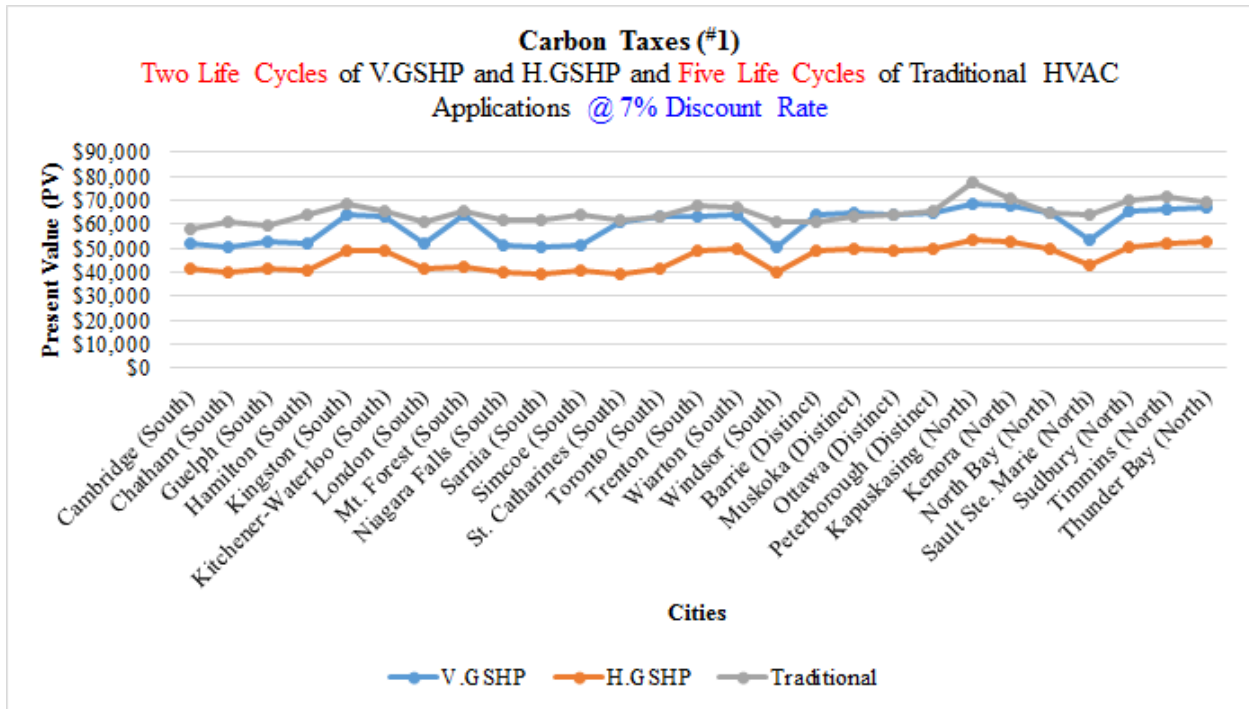

Table E2-1.8: Economic Variation of HVAC technologies for carbon taxes scenario (improved construction type) at a discount rate of 7% (two life cycles of V.GSHP and H.GSHP and five life cycles of Traditional HVAC Applications for a 60 year project lifespan)

FIT – (#2)

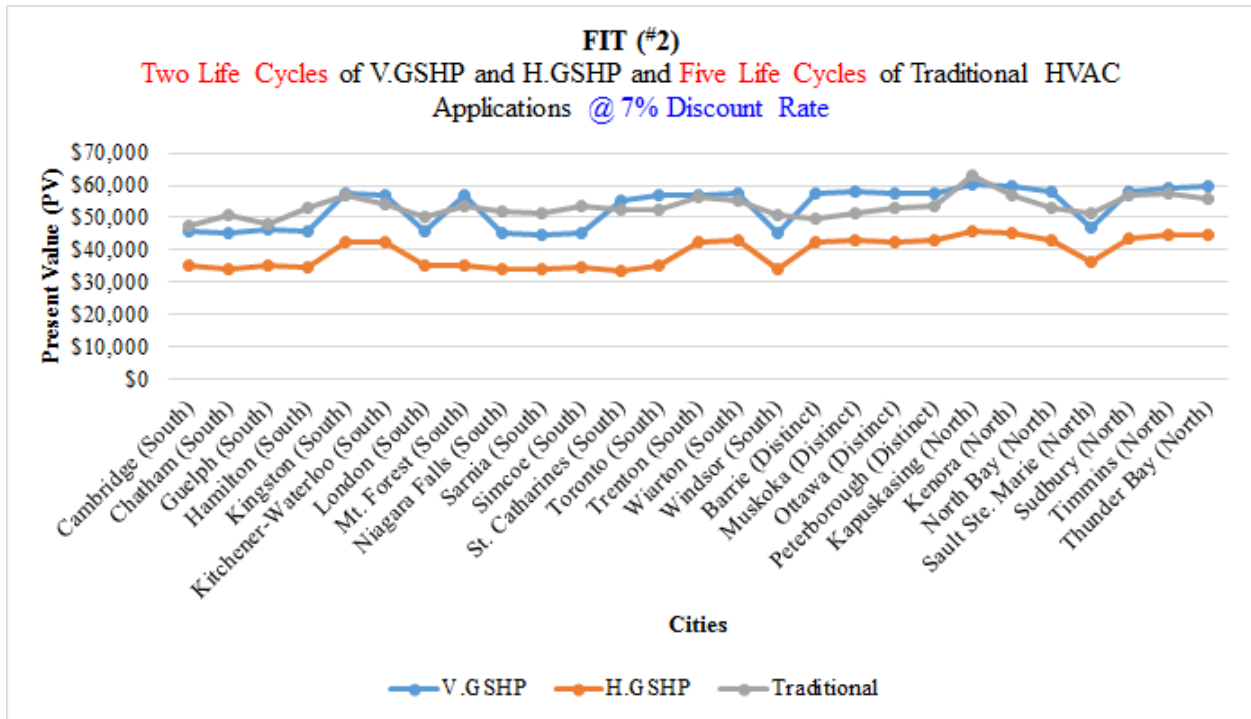

Table E2-1.9: Economic Variation of HVAC technologies for feed-in tariff scenario (improved construction type) at a discount rate of 7% (two life cycles of V.GSHP and H.GSHP and five life cycles of Traditional HVAC Applications for a 60 year project lifespan)

Rebates – (#3)

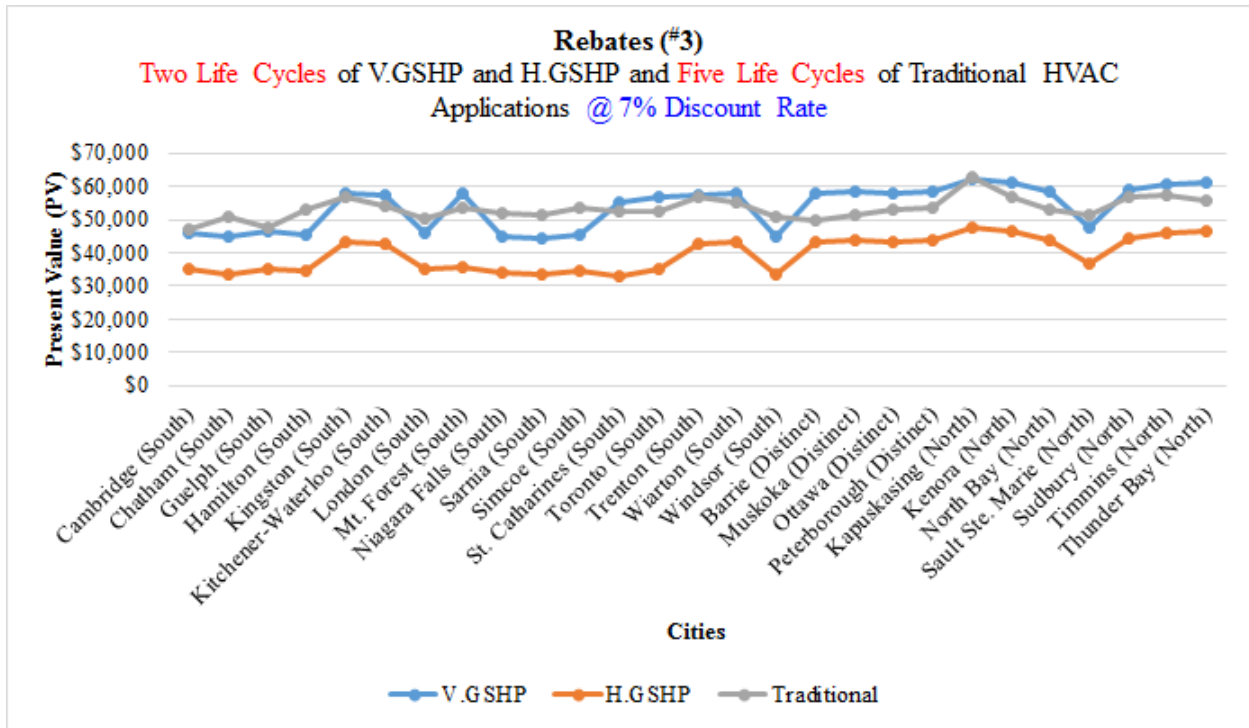

Table E2-1.10: Economic Variation of HVAC technologies for rebates scenario (improved construction type) at a discount rate of 7% (two life cycles of V.GSHP and H.GSHP and five life cycles of Traditional HVAC Applications for a 60 year project lifespan)

FIT + Rebates – (#4)

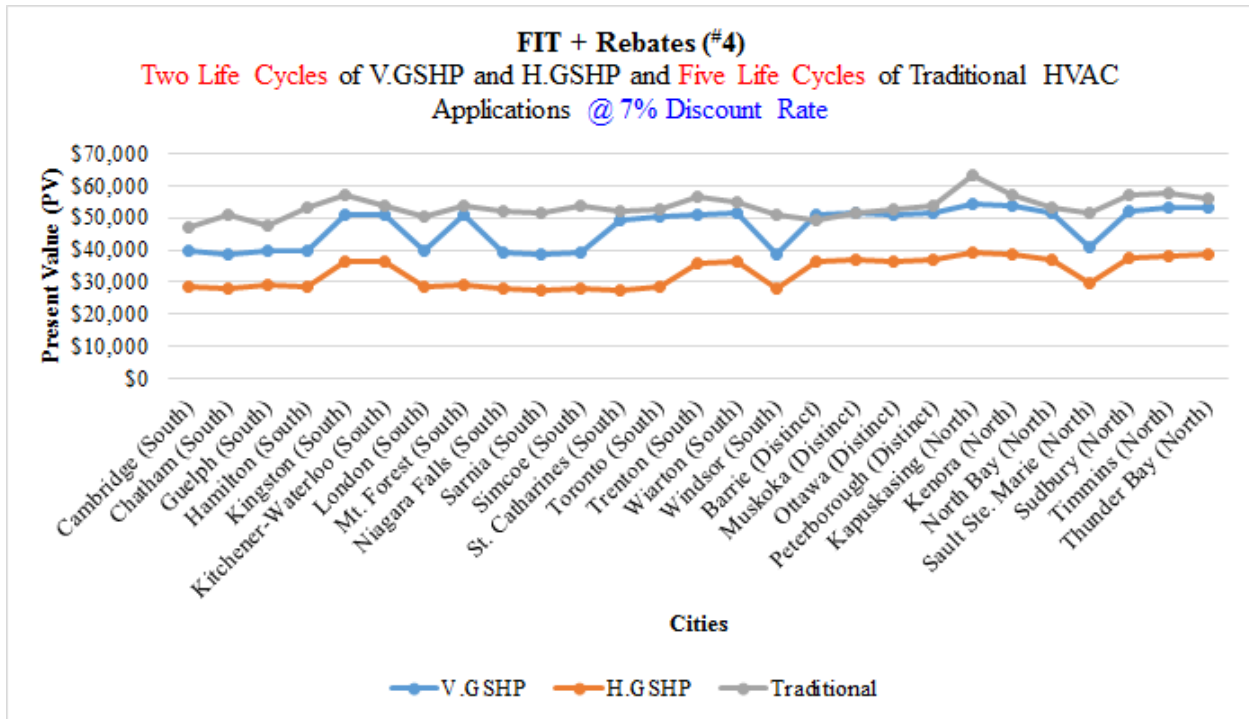

Table E2-1.11: Economic Variation of HVAC technologies for feed-in tariff + rebates scenario (improved construction type) at a discount rate of 7% (two life cycles of V.GSHP and H.GSHP and five life cycles of Traditional HVAC Applications for a 60 year project lifespan)

(FIT + Rebates) + Carbon Taxes – (#5)

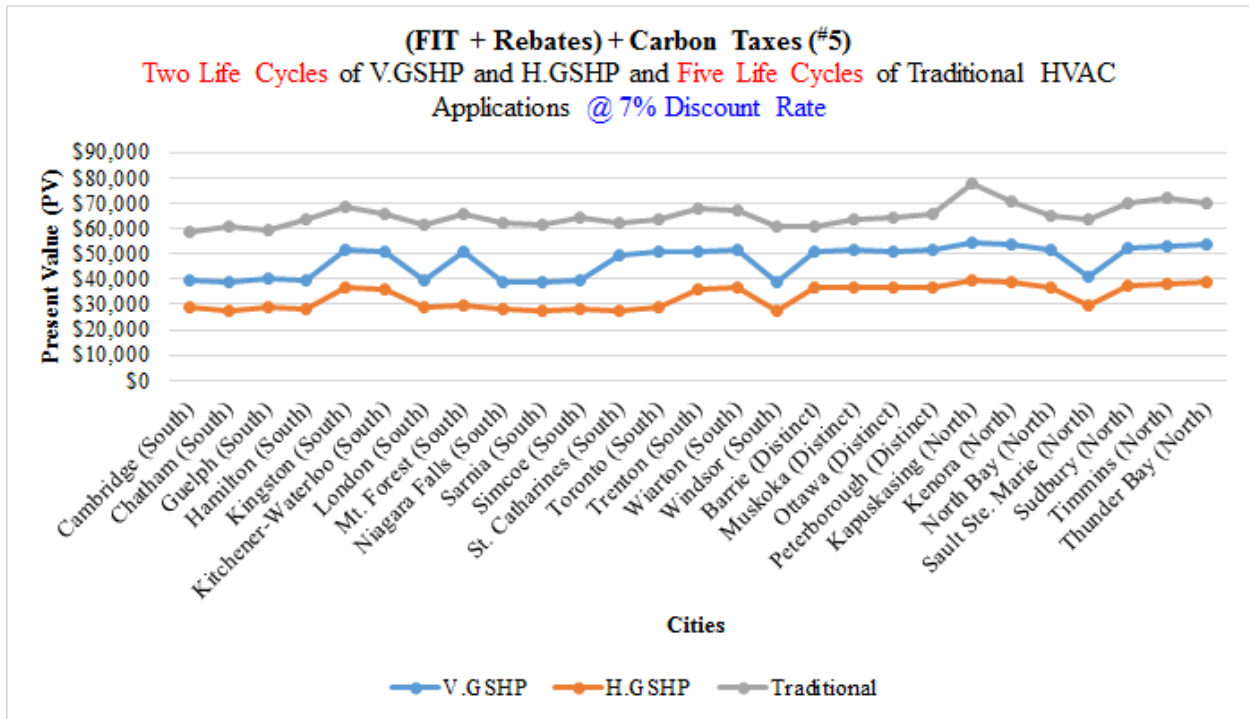

Table E2-1.12: Economic Variation of HVAC technologies for feed-in tariff + rebates + carbon tax scenario (improved construction type) at a discount rate of 7% (two life cycles of V.GSHP and H.GSHP and five life cycles of Traditional HVAC Applications for a 60 year project lifespan)

3. Two Life Cycles of V.GSHP and H.GSHP and Five Life Cycles of Traditional HVAC Applications @ 7.5% Discount Rate

Base Case Scenario

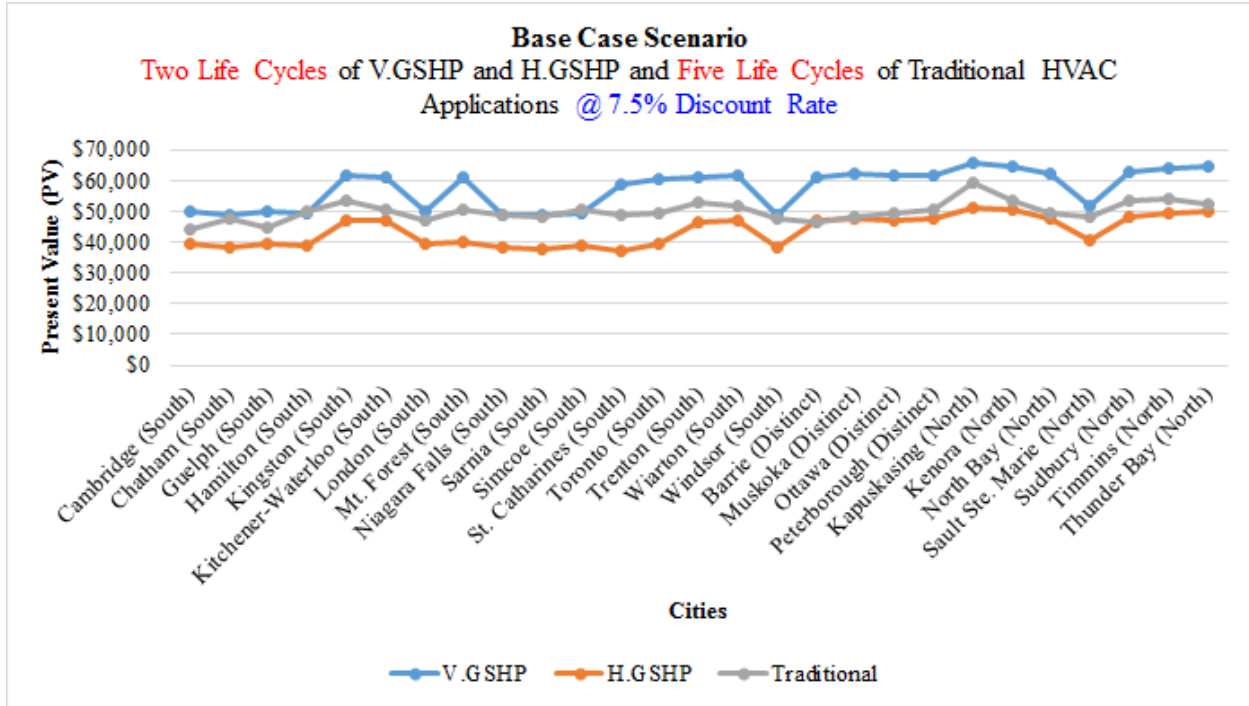

Table E2-1.13: Economic Variation of HVAC technologies for base case scenario (improved construction type) at a discount rate of 7.5% (two life cycles of V.GSHP and H.GSHP and five life cycles of Traditional HVAC Applications for a 60 year project lifespan)

Carbon Taxes – (#1)

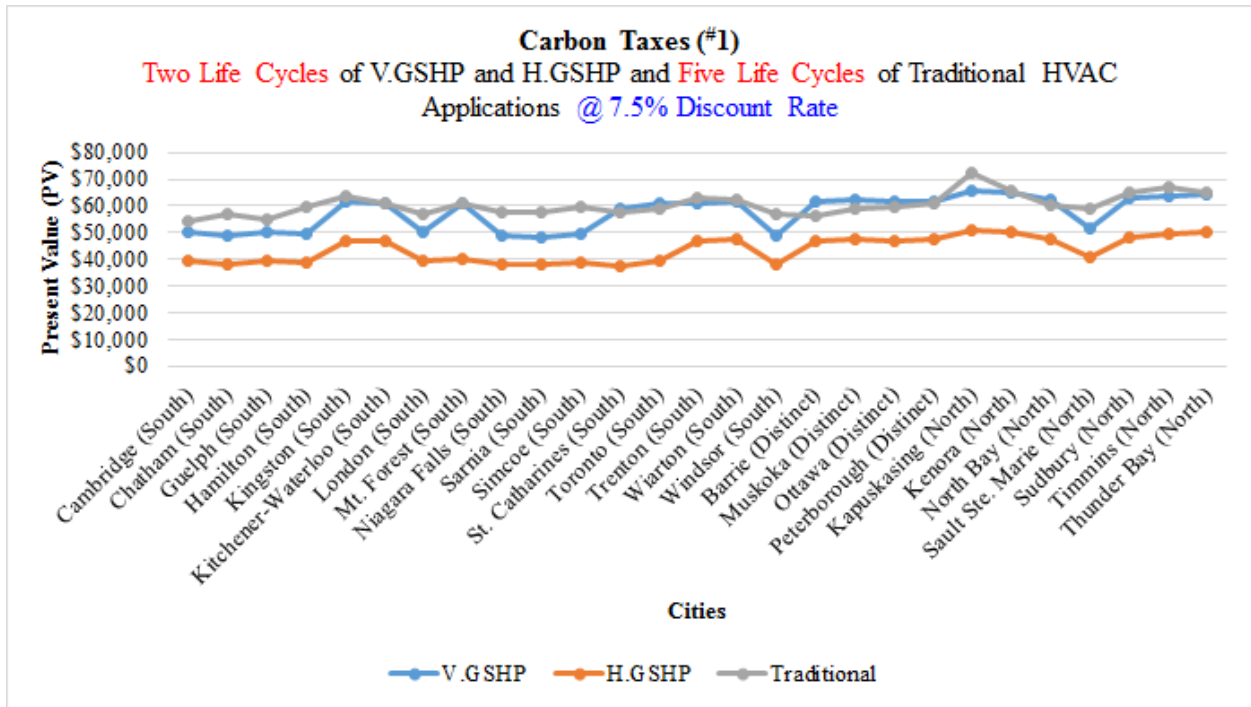

Table E2-1.14: Economic Variation of HVAC technologies for carbon taxes scenario (improved construction type) at a discount rate of 7.5% (two life cycles of V.GSHP and H.GSHP and five life cycles of Traditional HVAC Applications for a 60 year project lifespan)

FIT – (#2)

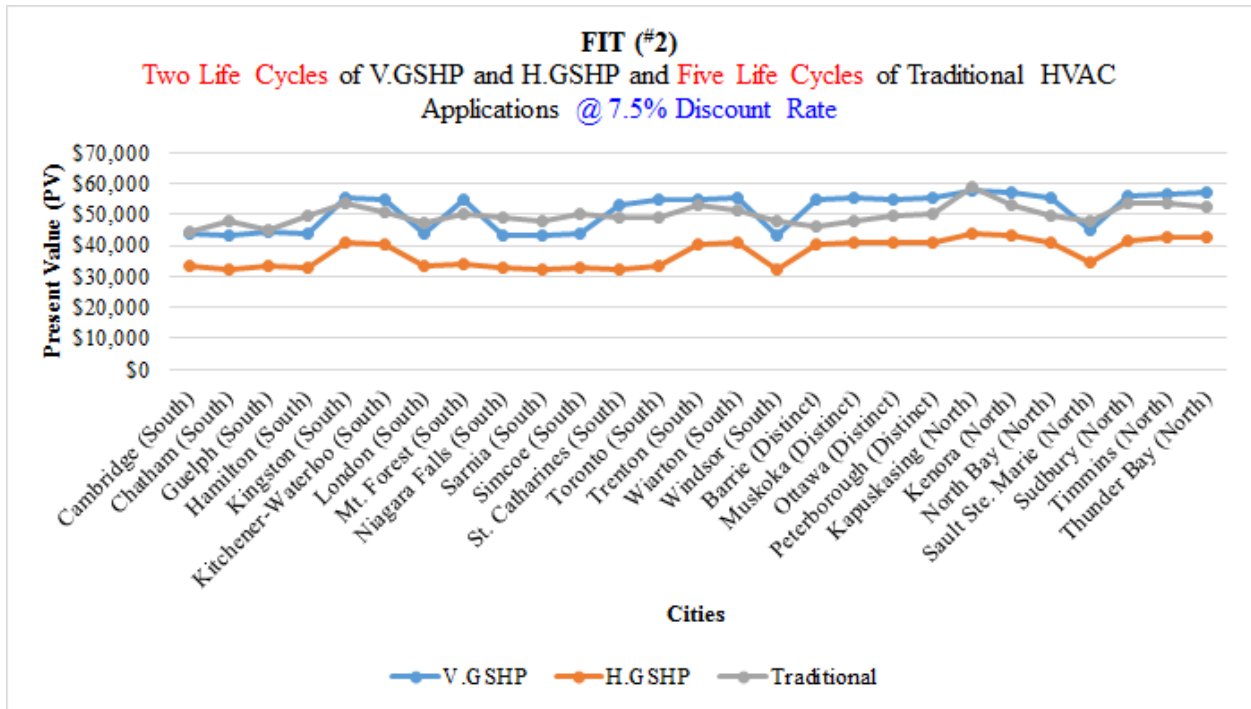

Table E2-1.15: Economic Variation of HVAC technologies for feed-in tariff scenario (improved construction type) at a discount rate of 7.5% (two life cycles of V.GSHP and H.GSHP and five life cycles of Traditional HVAC Applications for a 60 year project lifespan)

Rebates – (#3)

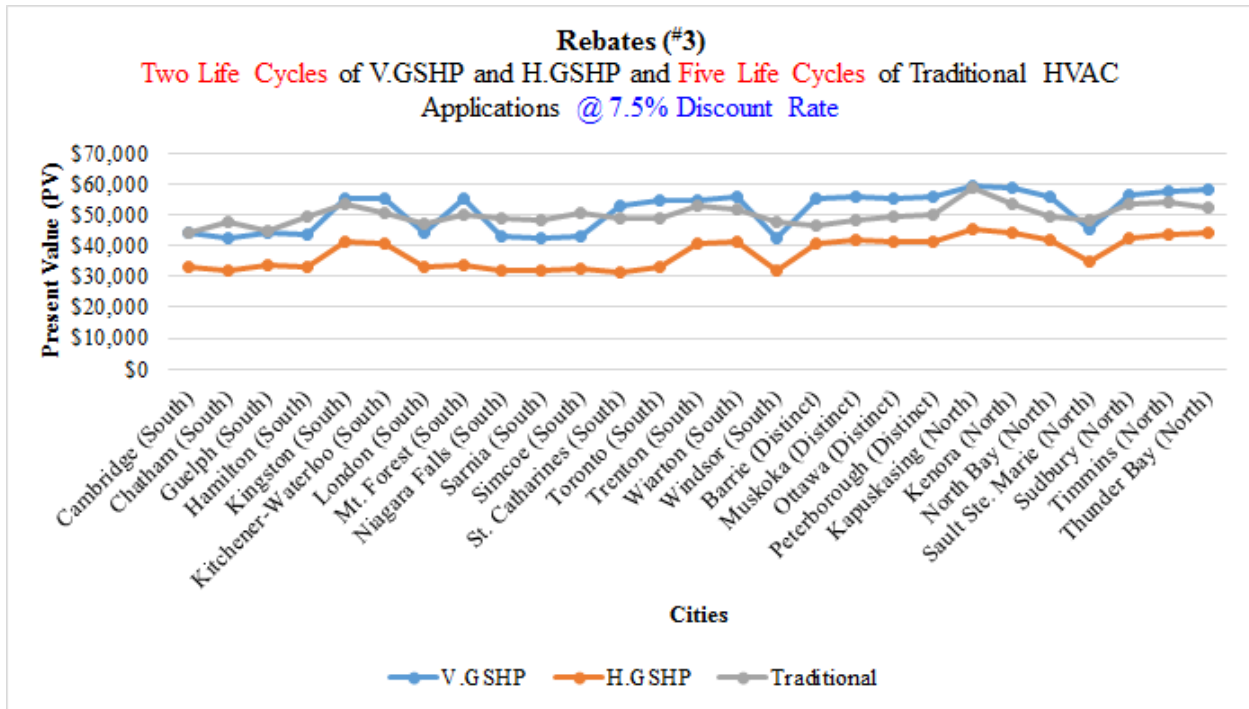

Table E2-1.16: Economic Variation of HVAC technologies for rebates scenario (improved construction type) at a discount rate of 7.5% (two life cycles of V.GSHP and H.GSHP and five life cycles of Traditional HVAC Applications for a 60 year project lifespan)

FIT + Rebates – (#4)

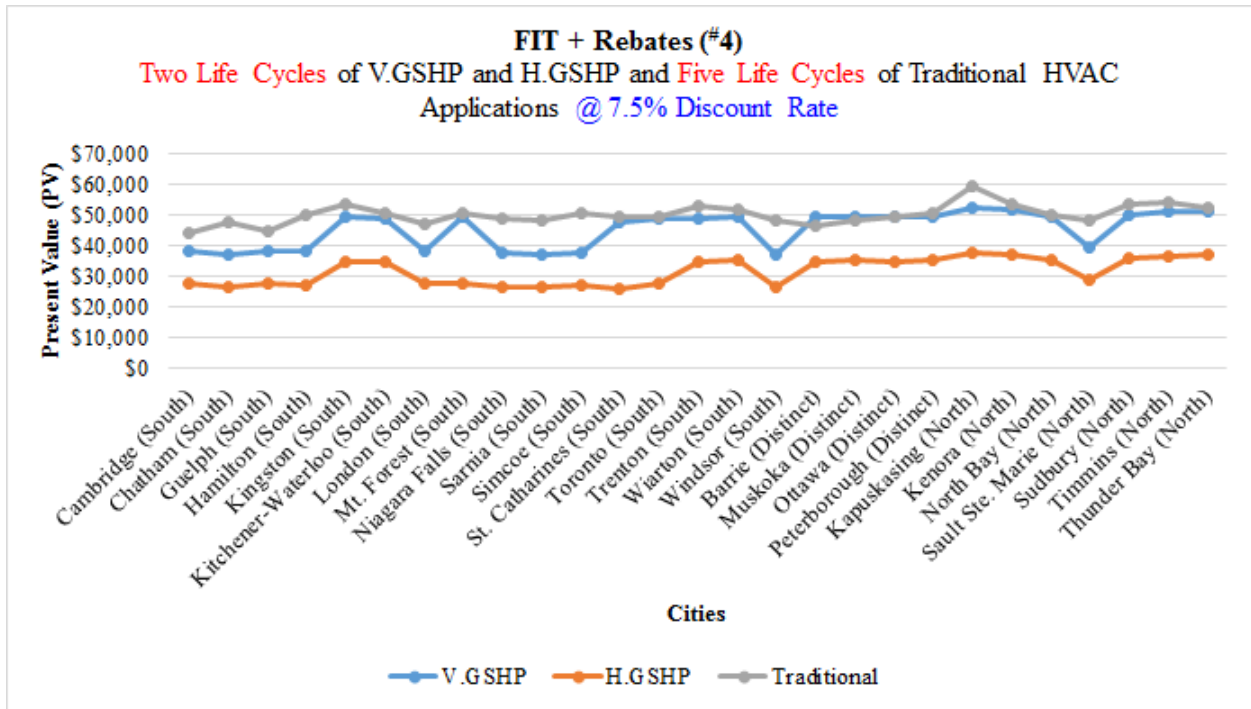

Table E2-1.17: Economic Variation of HVAC technologies for feed-in tariff + rebates scenario (improved construction type) at a discount rate of 7.5% (two life cycles of V.GSHP and H.GSHP and five life cycles of Traditional HVAC Applications for a 60 year project lifespan)

(FIT + Rebates) + Carbon Taxes – (#5)

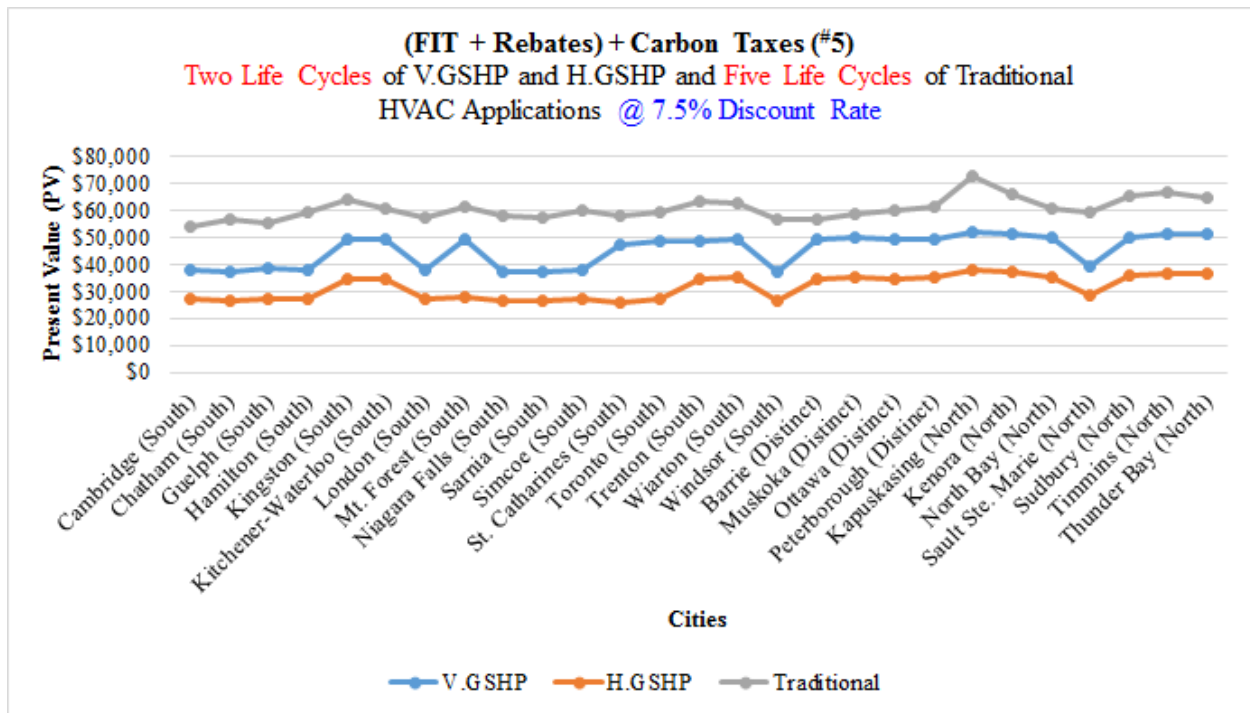

Table E2-1.18: Economic Variation of HVAC technologies for feed-in tariff + rebates + carbon tax scenario (improved construction type) at a discount rate of 7.5% (two life cycles of V.GSHP and H.GSHP and five life cycles of Traditional HVAC Applications for a 60 year project lifespan)

4. Two Life Cycles of V.GSHP and H.GSHP and Five Life Cycles of Traditional HVAC Applications @ 8.5% Discount Rate

Base Case Scenario

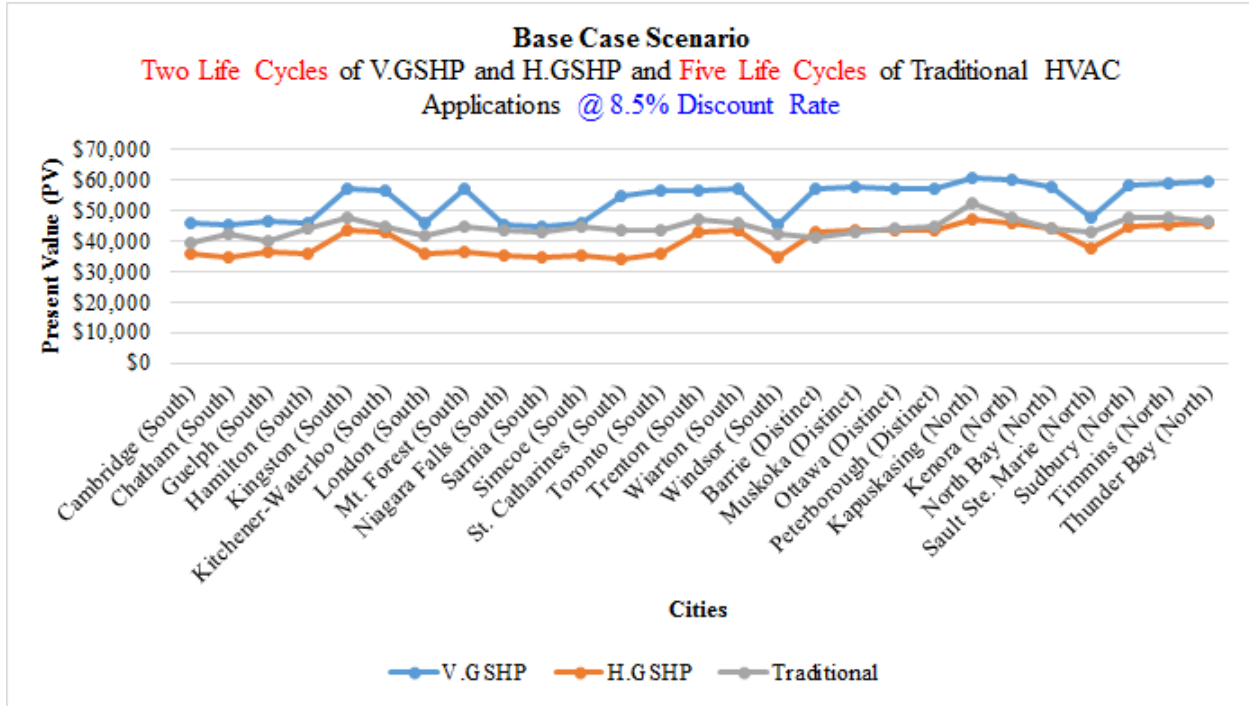

Table E2-1.19: Economic Variation of HVAC technologies for base case scenario (improved construction type) at a discount rate of 8.5% (two life cycles of V.GSHP and H.GSHP and five life cycles of Traditional HVAC Applications for a 60 year project lifespan)

Carbon Taxes – (#1)

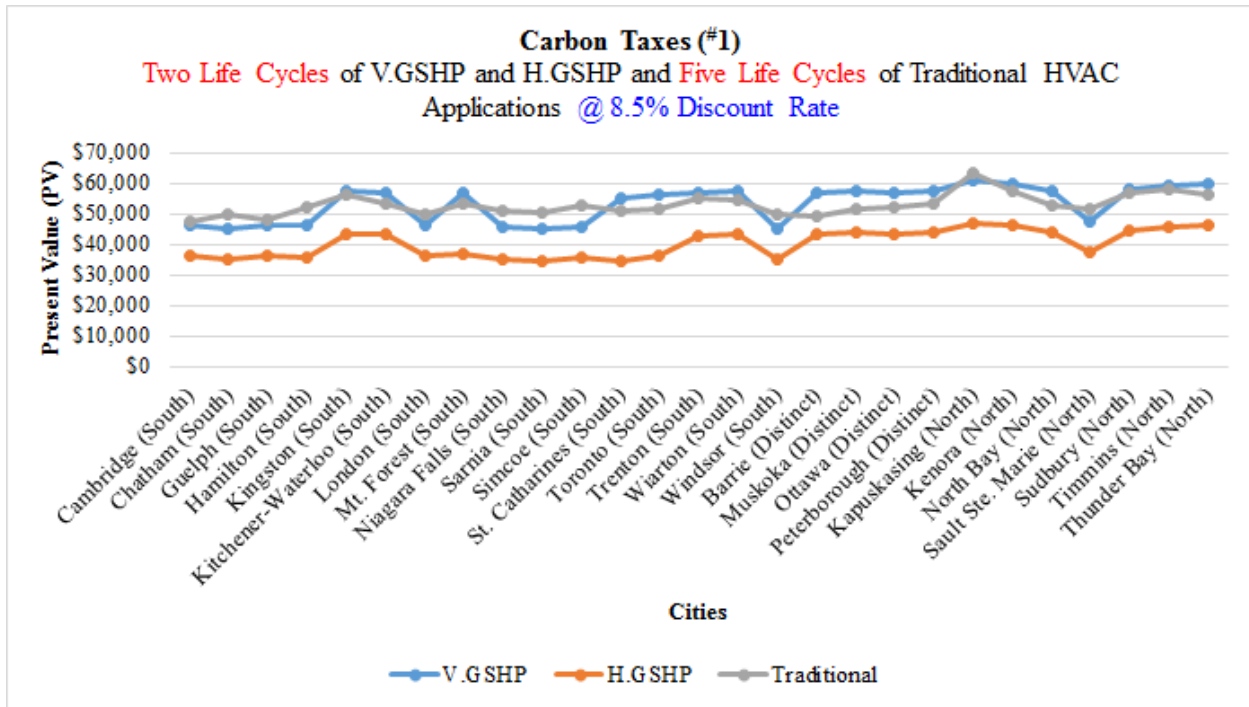

Table E2-1.20: Economic Variation of HVAC technologies for carbon taxes scenario (improved construction type) at a discount rate of 8.5% (two life cycles of V.GSHP and H.GSHP and five life cycles of Traditional HVAC Applications for a 60 year project lifespan)

FIT – (#2)

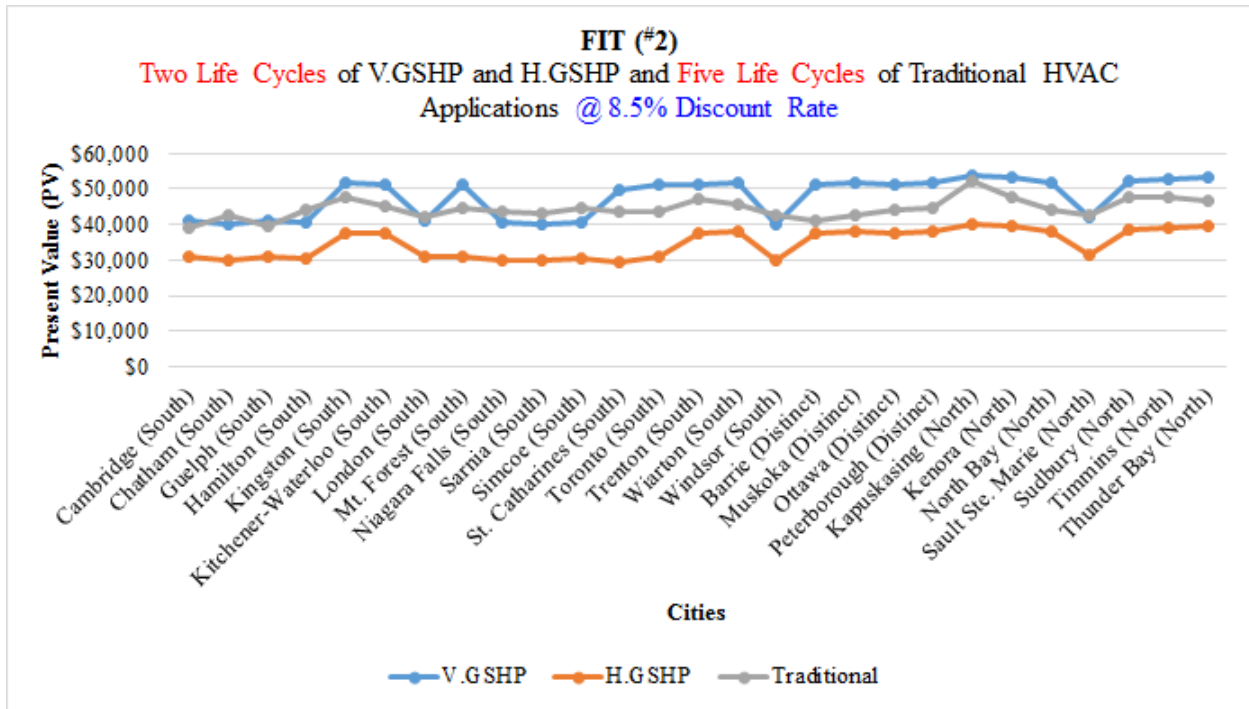

Table E2-1.21: Economic Variation of HVAC technologies for feed-in tariff scenario (improved construction type) at a discount rate of 8.5% (two life cycles of V.GSHP and H.GSHP and five life cycles of Traditional HVAC Applications for a 60 year project lifespan)

Rebates – (#3)

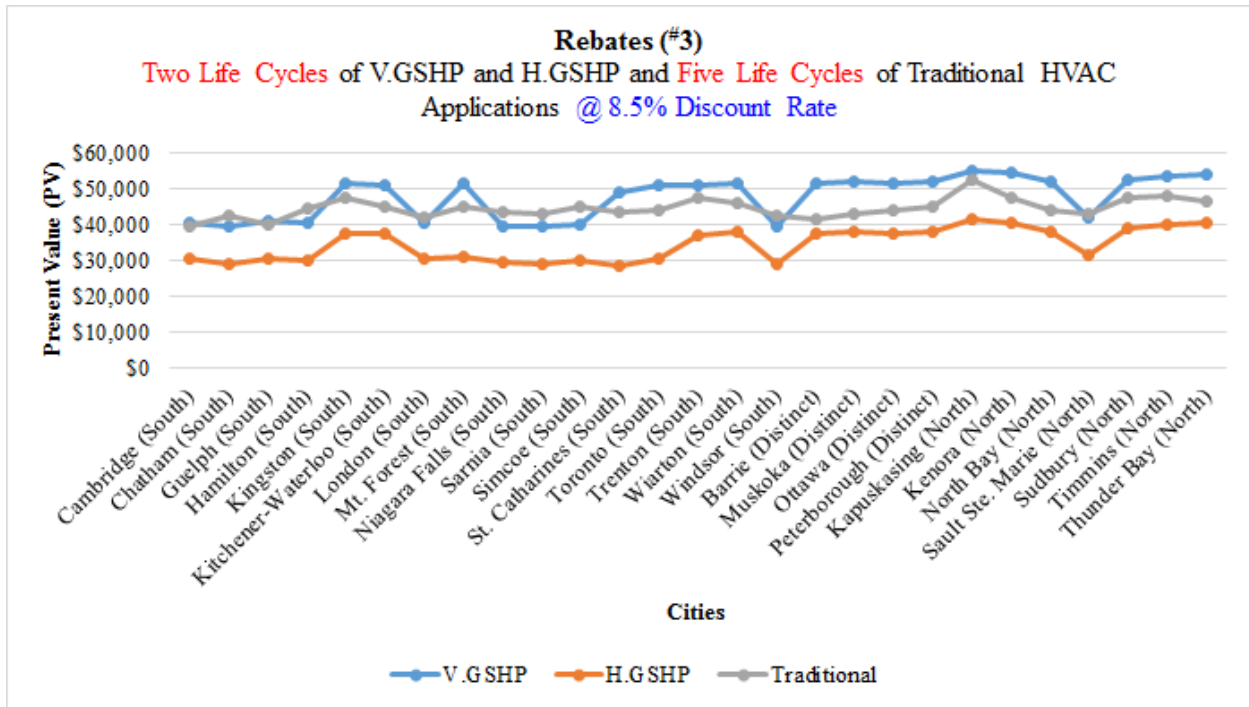

Table E2-1.22: Economic Variation of HVAC technologies for rebates scenario (improved construction type) at a discount rate of 8.5% (two life cycles of V.GSHP and H.GSHP and five life cycles of Traditional HVAC Applications for a 60 year project lifespan)

FIT + Rebates – (#4)

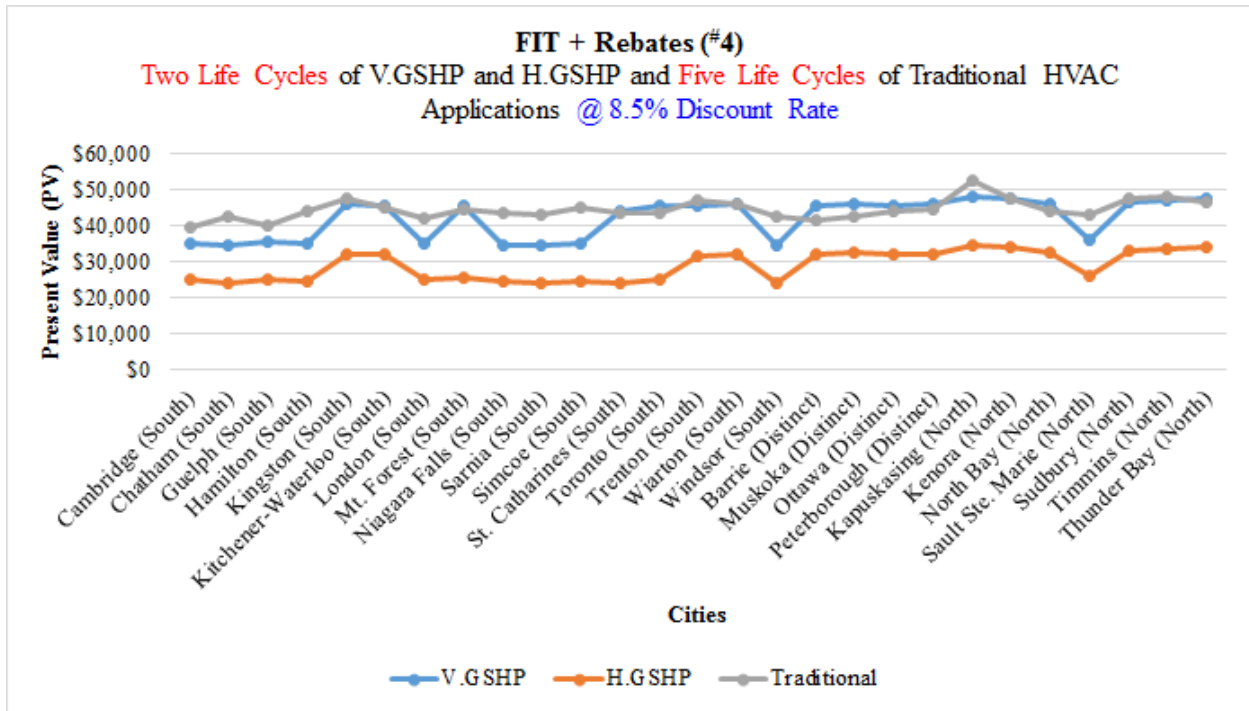

Table E2-1.23: Economic Variation of HVAC technologies for feed-in tariff + rebates scenario (improved construction type) at a discount rate of 8.5% (two life cycles of V.GSHP and H.GSHP and five life cycles of Traditional HVAC Applications for a 60 year project lifespan)

(FIT + Rebates) + Carbon Taxes – (#5)

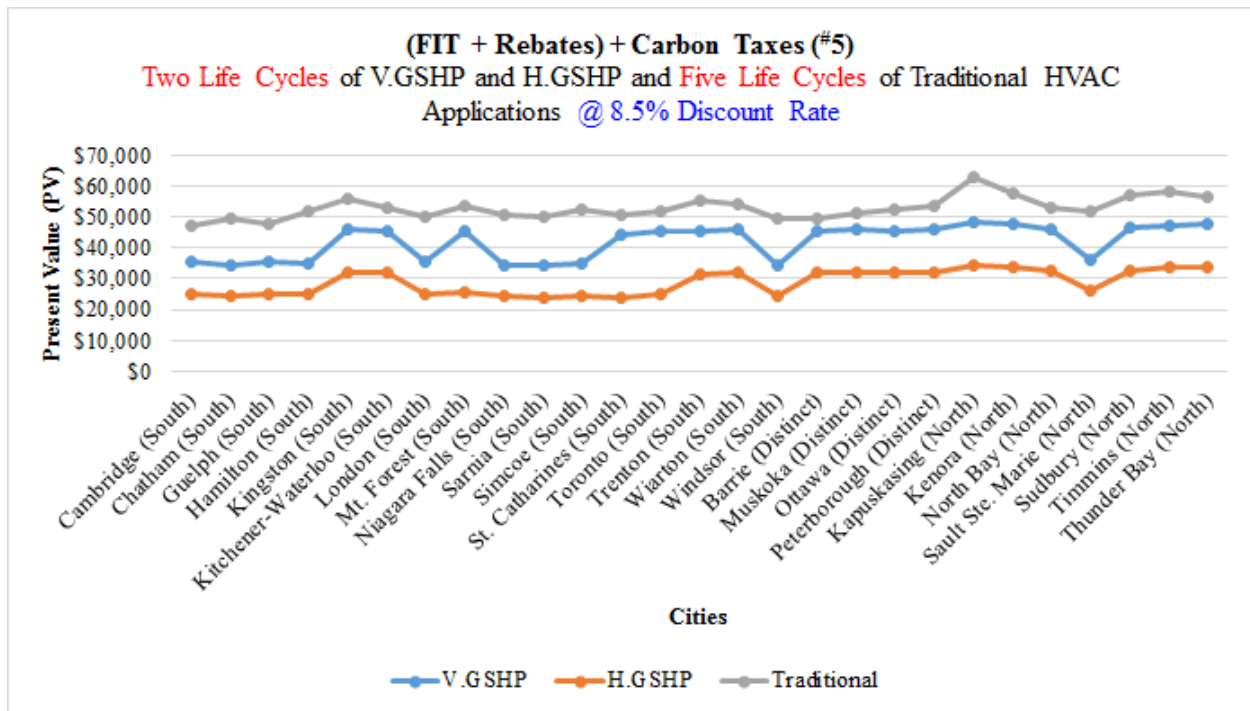

Table E2-1.24: Economic Variation of HVAC technologies for feed-in tariff + rebates + carbon tax scenario (improved construction type) at a discount rate of 8.5% (two life cycles of V.GSHP and H.GSHP and five life cycles of Traditional HVAC Applications for a 60 year project lifespan)

5. Two Life Cycles of V.GSHP and H.GSHP and Five Life Cycles of Traditional HVAC Applications @ 10% Discount Rate

Base Case Scenario

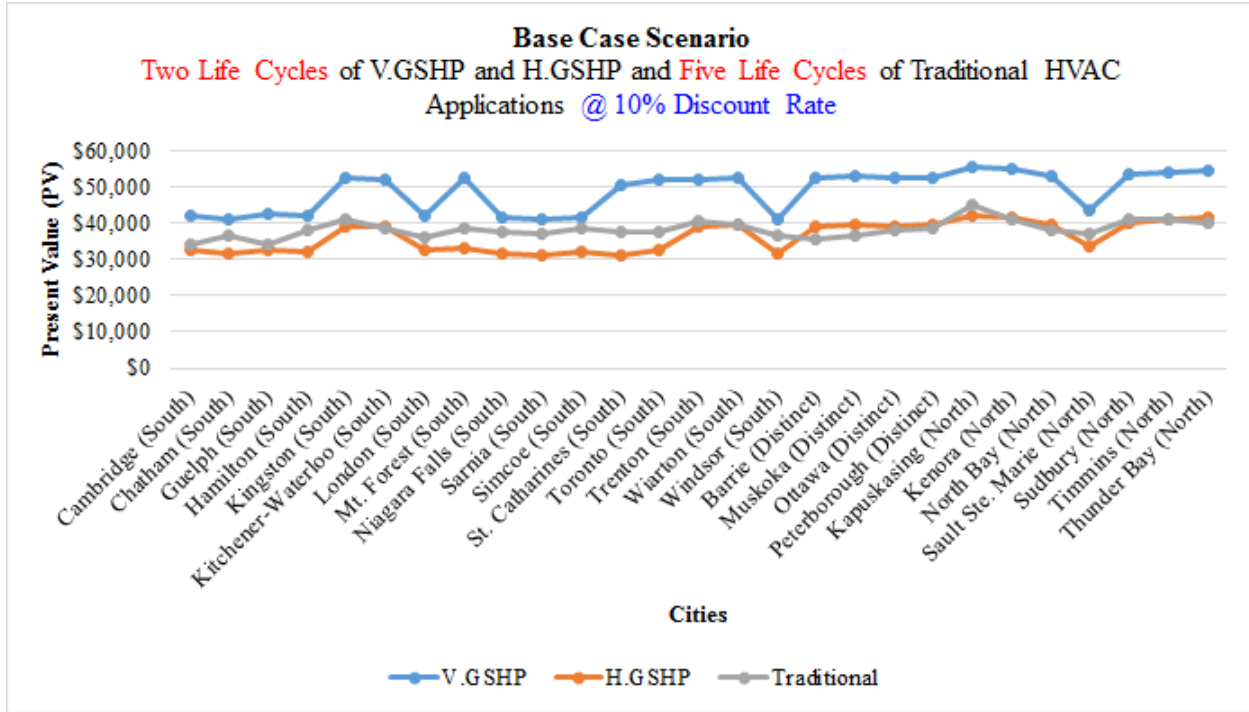

Table E2-1.25: Economic Variation of HVAC technologies for base case scenario (improved construction type) at a discount rate of 10% (two life cycles of V.GSHP and H.GSHP and five life cycles of Traditional HVAC Applications for a 60 year project lifespan)

Carbon Taxes – (#1)

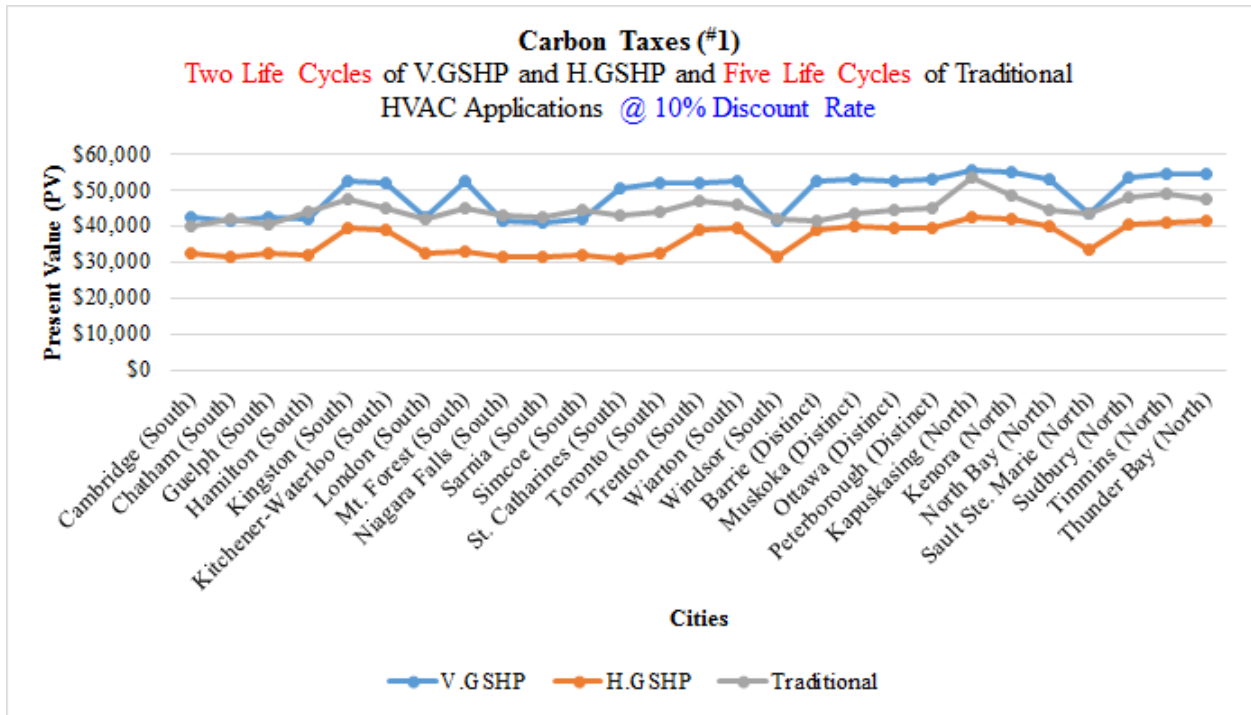

Table E2-1.26: Economic Variation of HVAC technologies for carbon taxes scenario (improved construction type) at a discount rate of 10% (two life cycles of V.GSHP and H.GSHP and five life cycles of Traditional HVAC Applications for a 60 year project lifespan)

FIT – (#2)

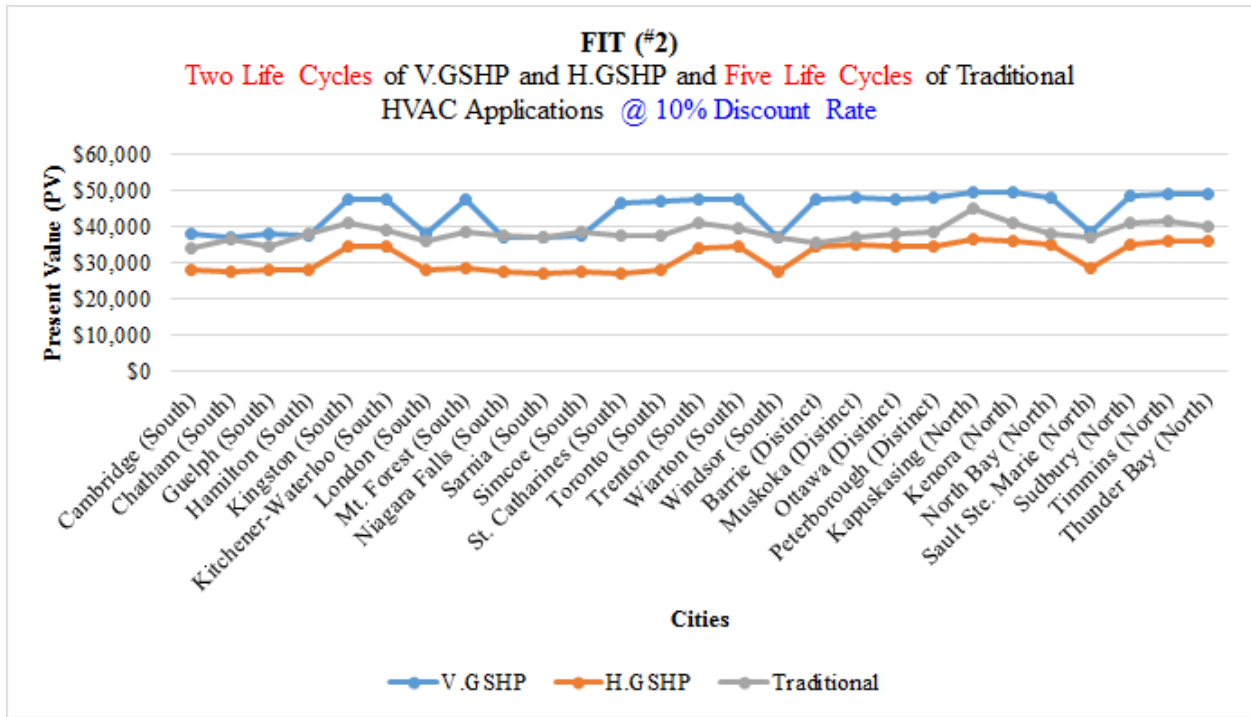

Table E2-1.27: Economic Variation of HVAC technologies for feed-in tariff scenario (improved construction type) at a discount rate of 10% (two life cycles of V.GSHP and H.GSHP and five life cycles of Traditional HVAC Applications for a 60 year project lifespan)

Rebates – (#3)

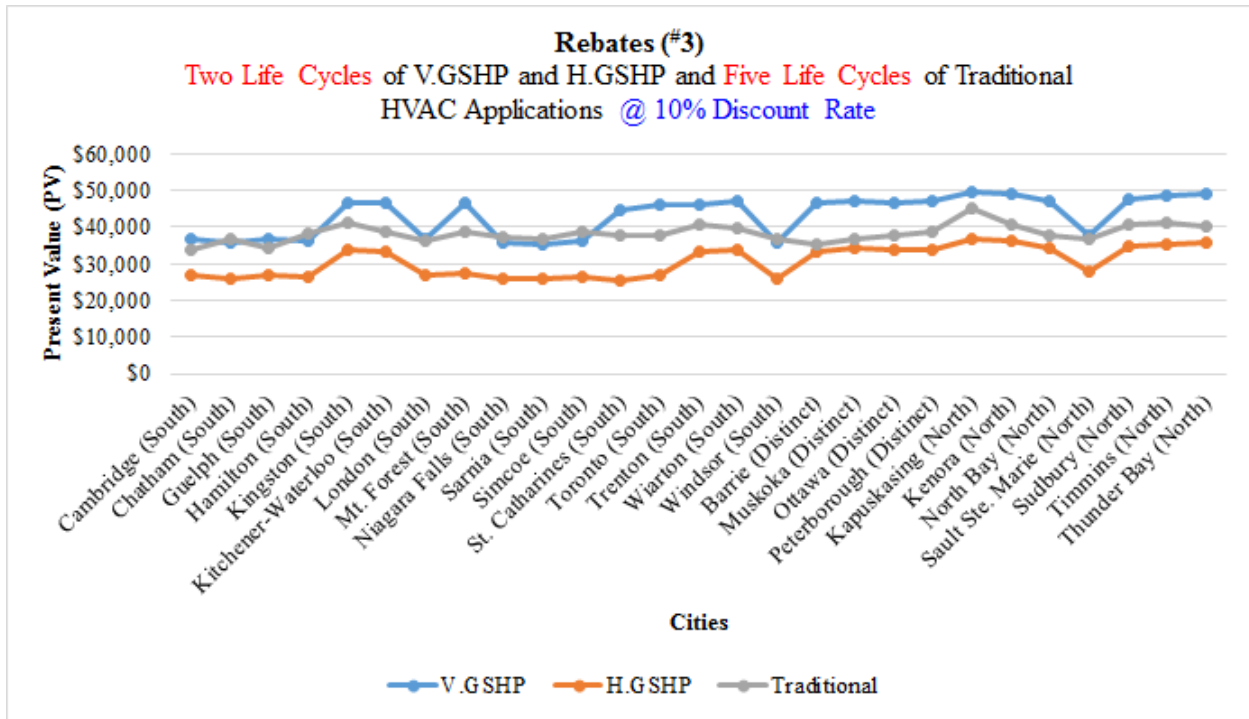

Table E2-1.28: Economic Variation of HVAC technologies for rebates scenario (improved construction type) at a discount rate of 10% (two life cycles of V.GSHP and H.GSHP and five life cycles of Traditional HVAC Applications for a 60 year project lifespan)

FIT + Rebates – (#4)

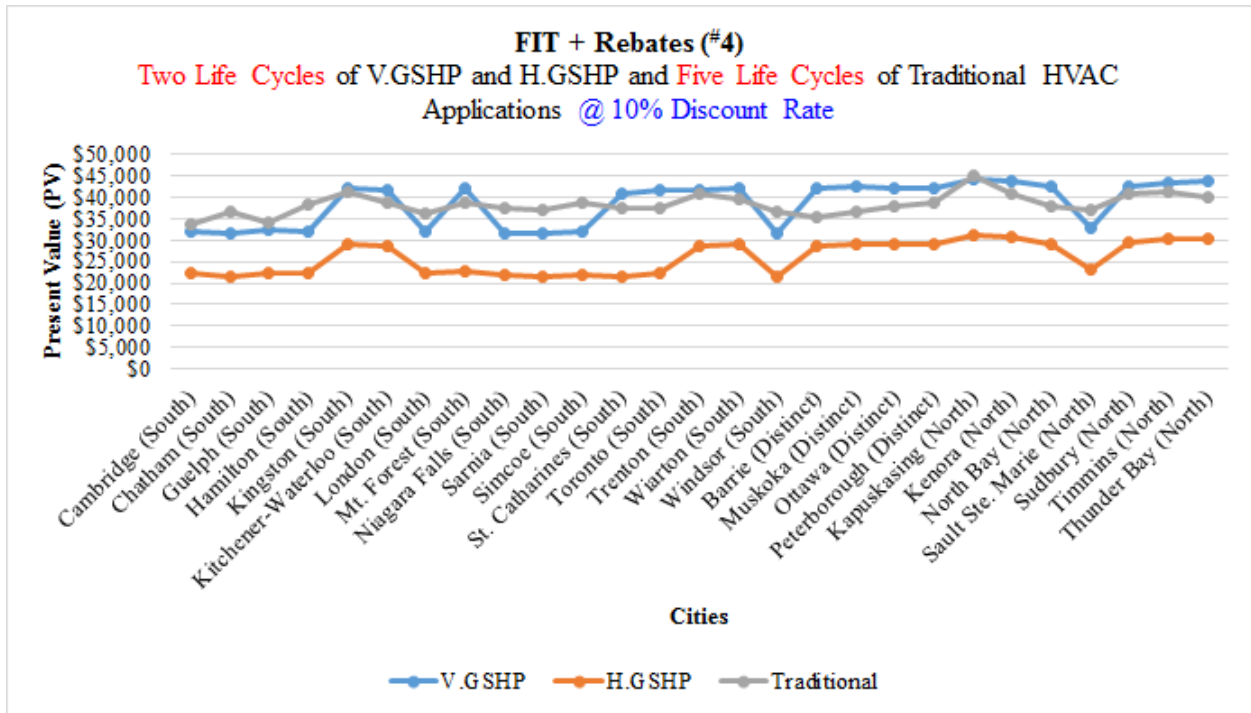

Table E2-1.29: Economic Variation of HVAC technologies for feed-in tariff + rebates scenario (improved construction type) at a discount rate of 10% (two life cycles of V.GSHP and H.GSHP and five life cycles of Traditional HVAC Applications for a 60 year project lifespan)

(FIT + Rebates) + Carbon Taxes – (#5)

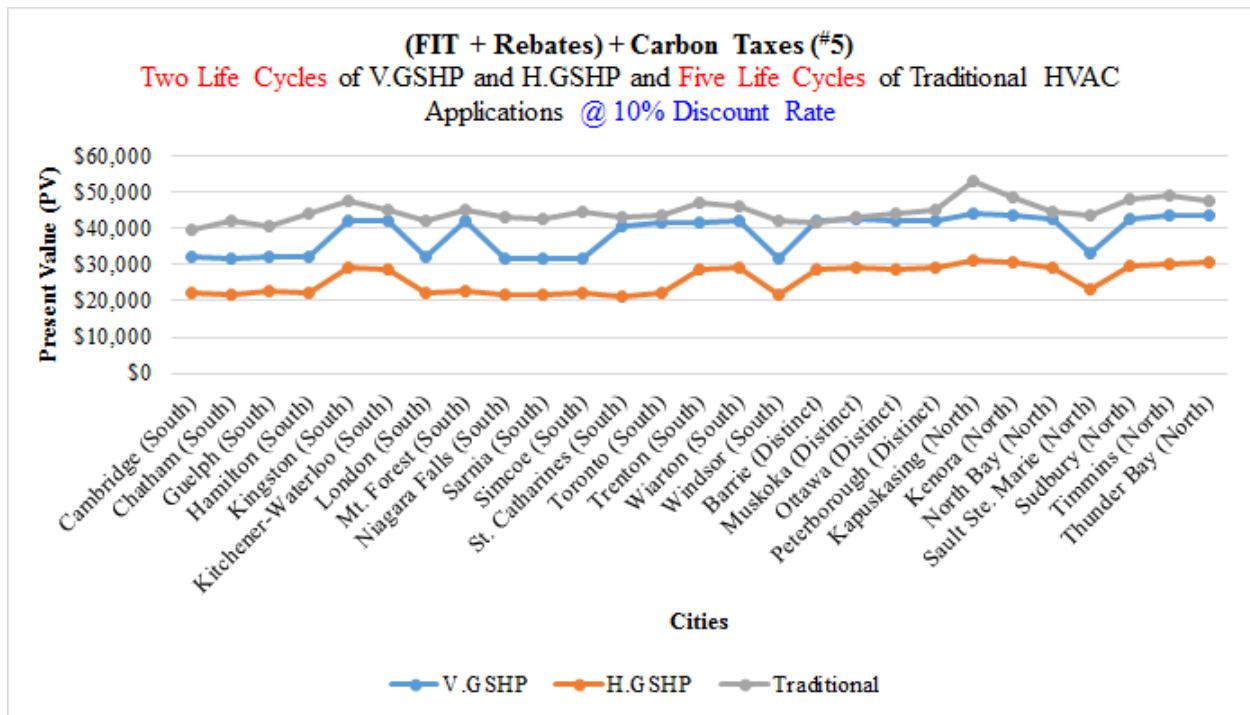

Table E2-1.30: Economic Variation of HVAC technologies for feed-in tariff + rebates + carbon tax scenario (improved construction type) at a discount rate of 10% (two life cycles of V.GSHP and H.GSHP and five life cycles of Traditional HVAC Applications for a 60 year project lifespan)

6. Two Life Cycles of V.GSHP and H.GSHP and Five Life Cycles of Traditional HVAC Applications @ 12% Discount Rate

Base Case Scenario

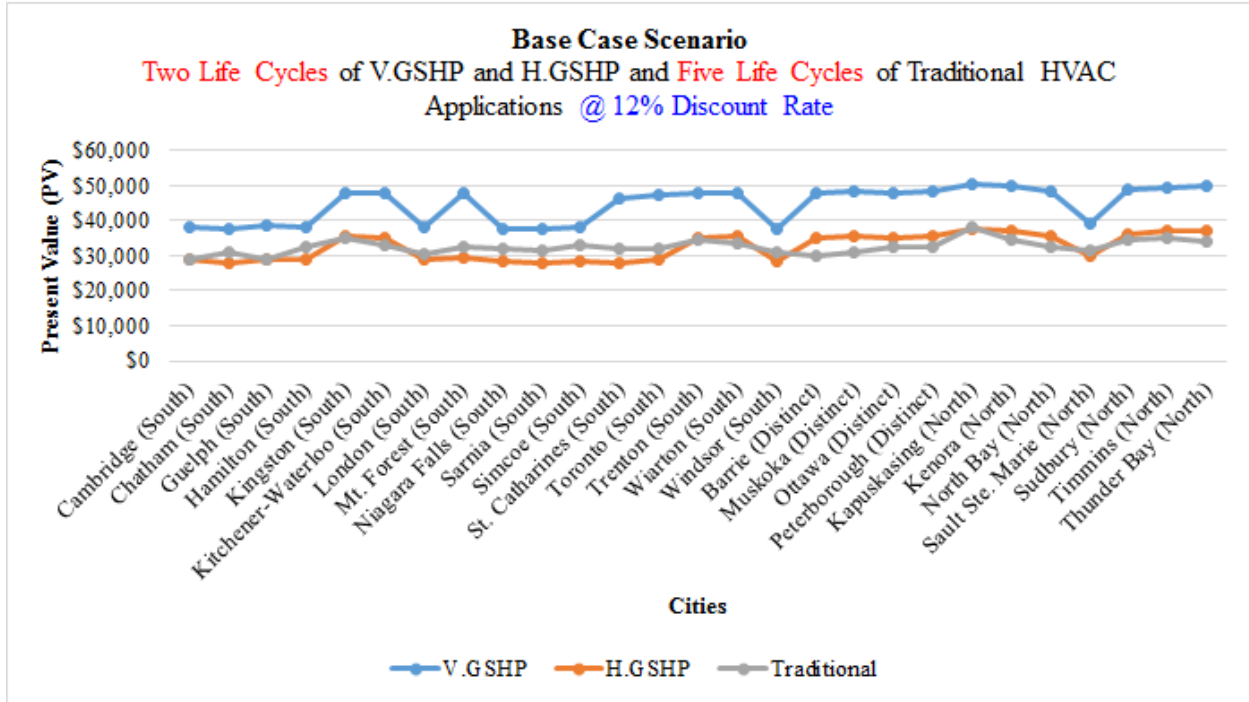

Table E2-1.31: Economic Variation of HVAC technologies for base case scenario (improved construction type) at a discount rate of 12% (two life cycles of V.GSHP and H.GSHP and five life cycles of Traditional HVAC Applications for a 60 year project lifespan)

Carbon Taxes – (#1)

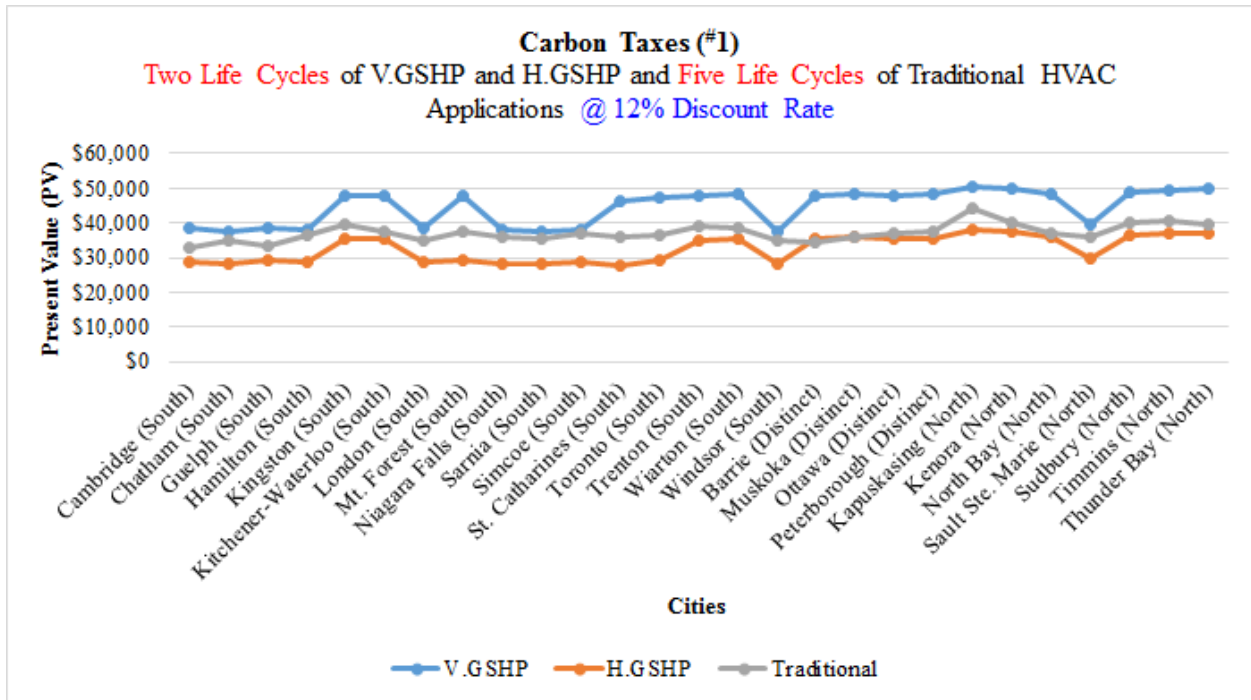

Table E2-1.32: Economic Variation of HVAC technologies for carbon taxes scenario (improved construction type) at a discount rate of 12% (two life cycles of V.GSHP and H.GSHP and five life cycles of Traditional HVAC Applications for a 60 year project lifespan)

FIT – (#2)

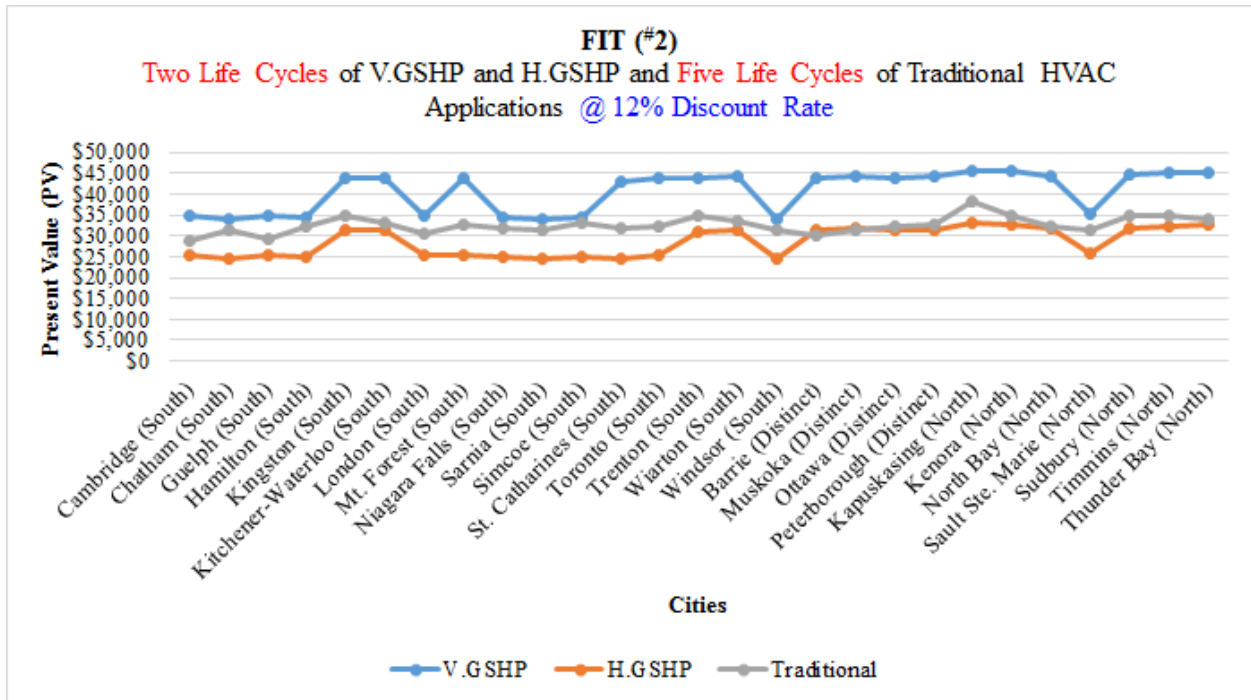

Table E2-1.33: Economic Variation of HVAC technologies for feed-in tariff scenario (improved construction type) at a discount rate of 12% (two life cycles of V.GSHP and H.GSHP and five life cycles of Traditional HVAC Applications for a 60 year project lifespan)

Rebates – (#3)

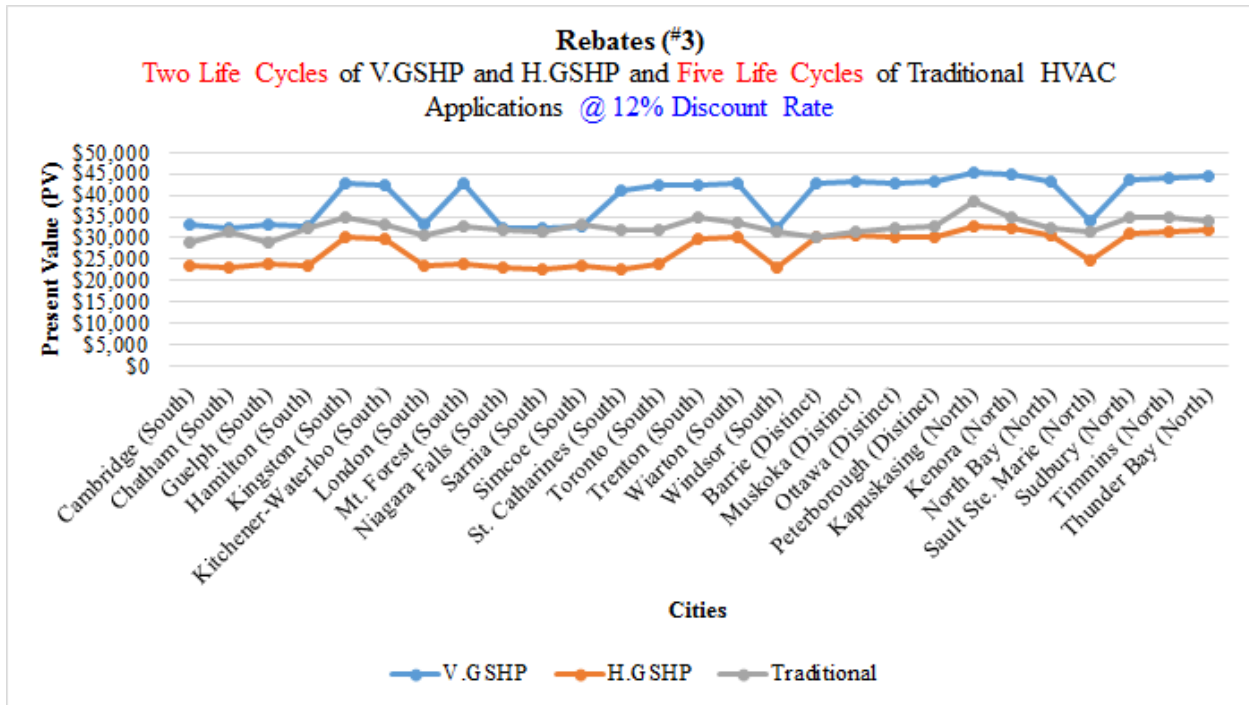

Table E2-1.34: Economic Variation of HVAC technologies for rebates scenario (improved construction type) at a discount rate of 12% (two life cycles of V.GSHP and H.GSHP and five life cycles of Traditional HVAC Applications for a 60 year project lifespan)

FIT + Rebates – (#4)

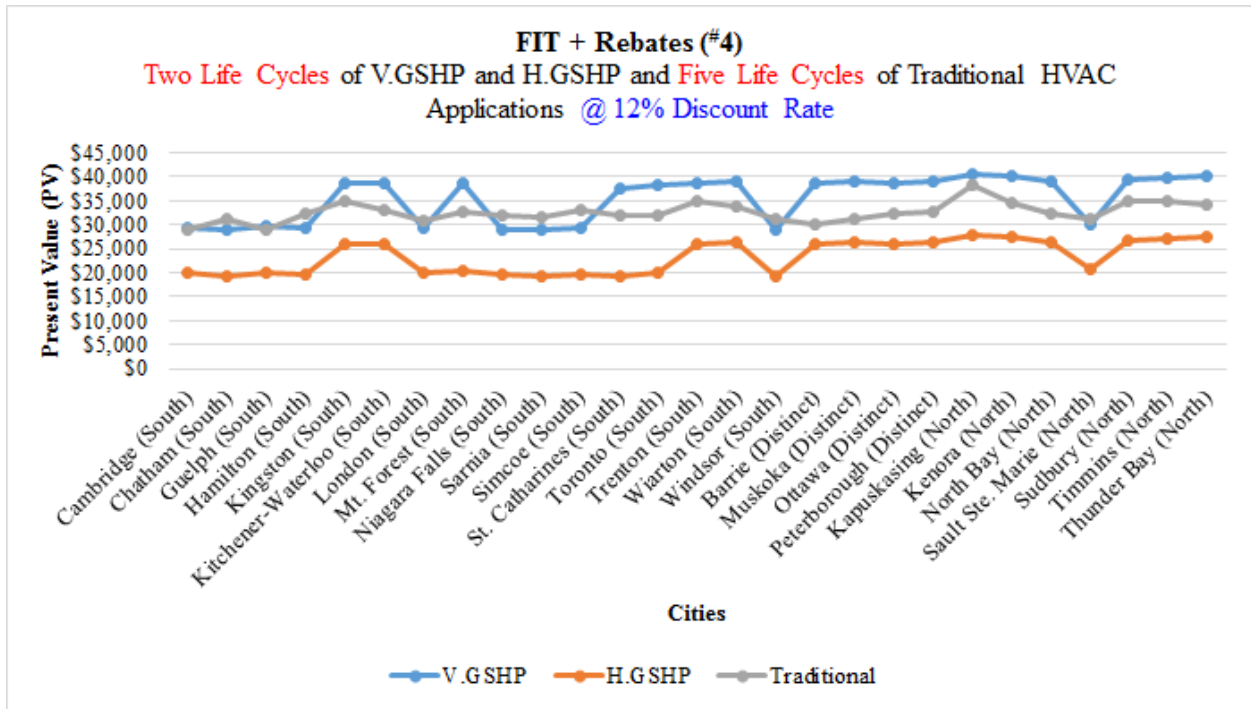

Table E2-1.35: Economic Variation of HVAC technologies for feed-in tariff + rebates scenario (improved construction type) at a discount rate of 12% (two life cycles of V.GSHP and H.GSHP and five life cycles of Traditional HVAC Applications for a 60 year project lifespan)

(FIT + Rebates) + Carbon Taxes – (#5)

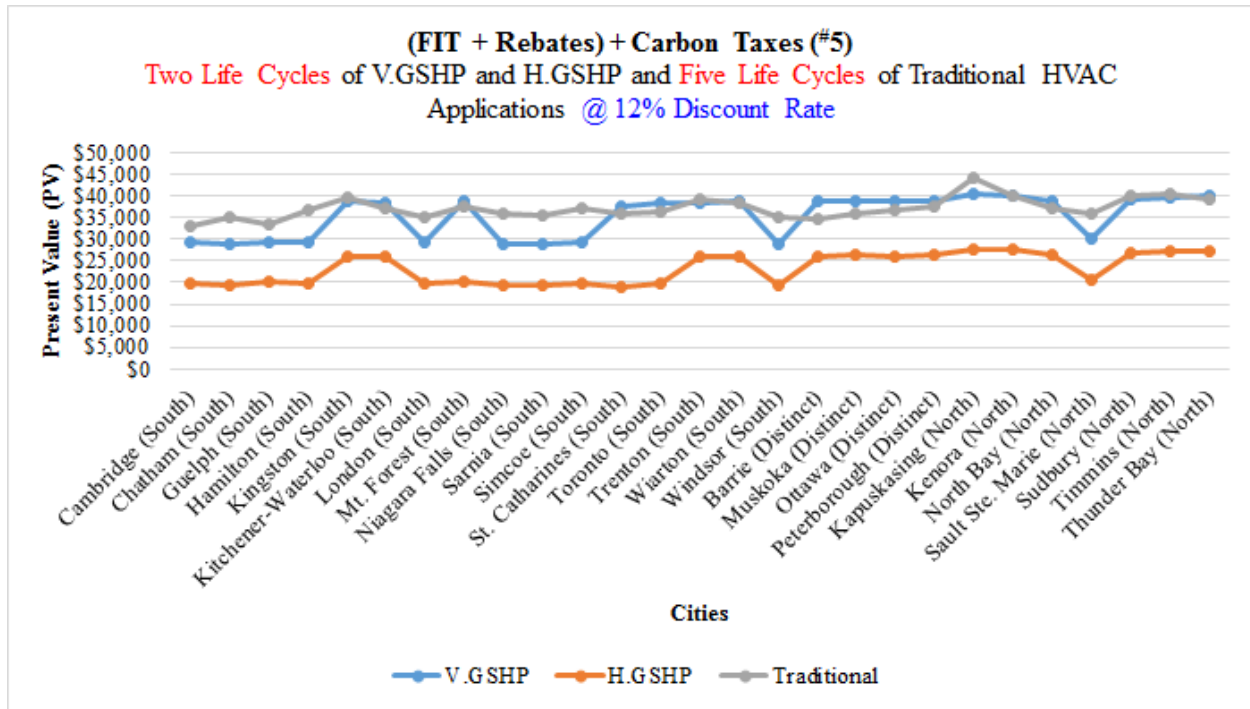

Table E2-1.36: Economic Variation of HVAC technologies for feed-in tariff + rebates + carbon tax scenario (improved construction type) at a discount rate of 12% (two life cycles of V.GSHP and H.GSHP and five life cycles of Traditional HVAC Applications for a 60 year project lifespan)

7. Three Life Cycles of V.GSHP and H.GSHP and Five Life Cycles of Traditional HVAC Applications @ 5% Discount Rate

Base Case Scenario

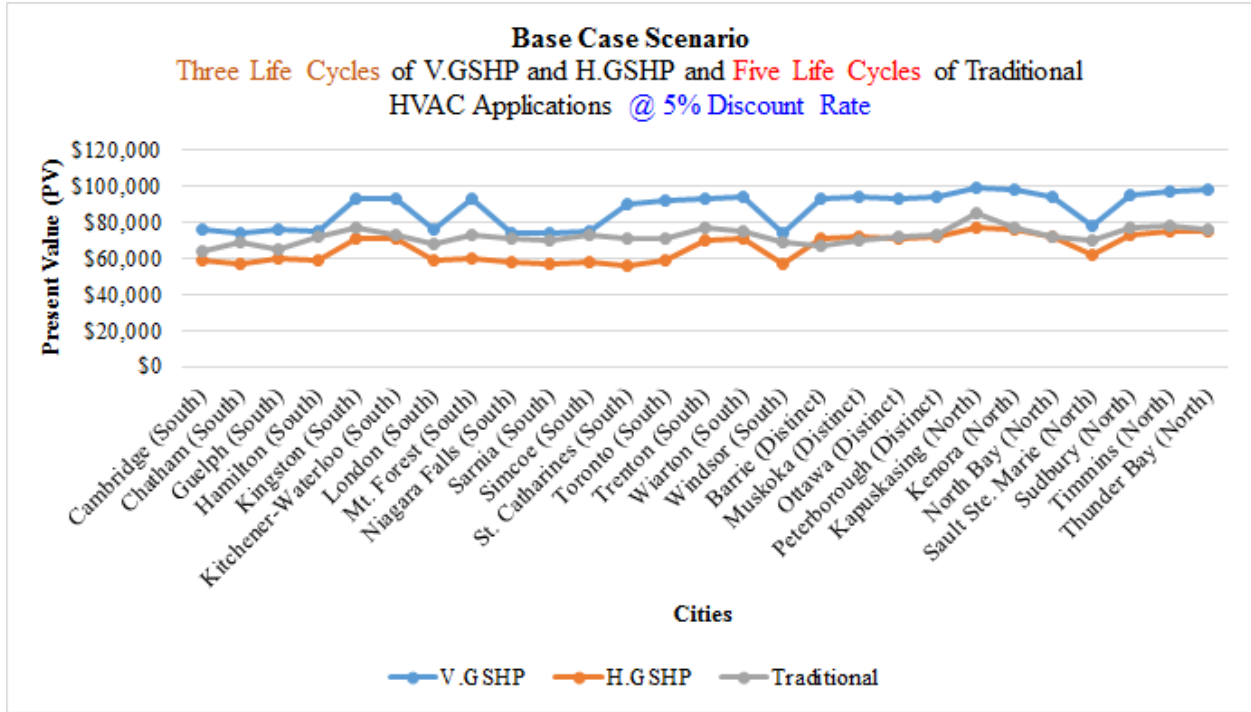

Table E2-1.37: Economic Variation of HVAC technologies for base case scenario (improved construction type) at a discount rate of 5% (three life cycles of V.GSHP and H.GSHP and five life cycles of Traditional HVAC Applications for a 60 year project lifespan)

Carbon Taxes – (#1)

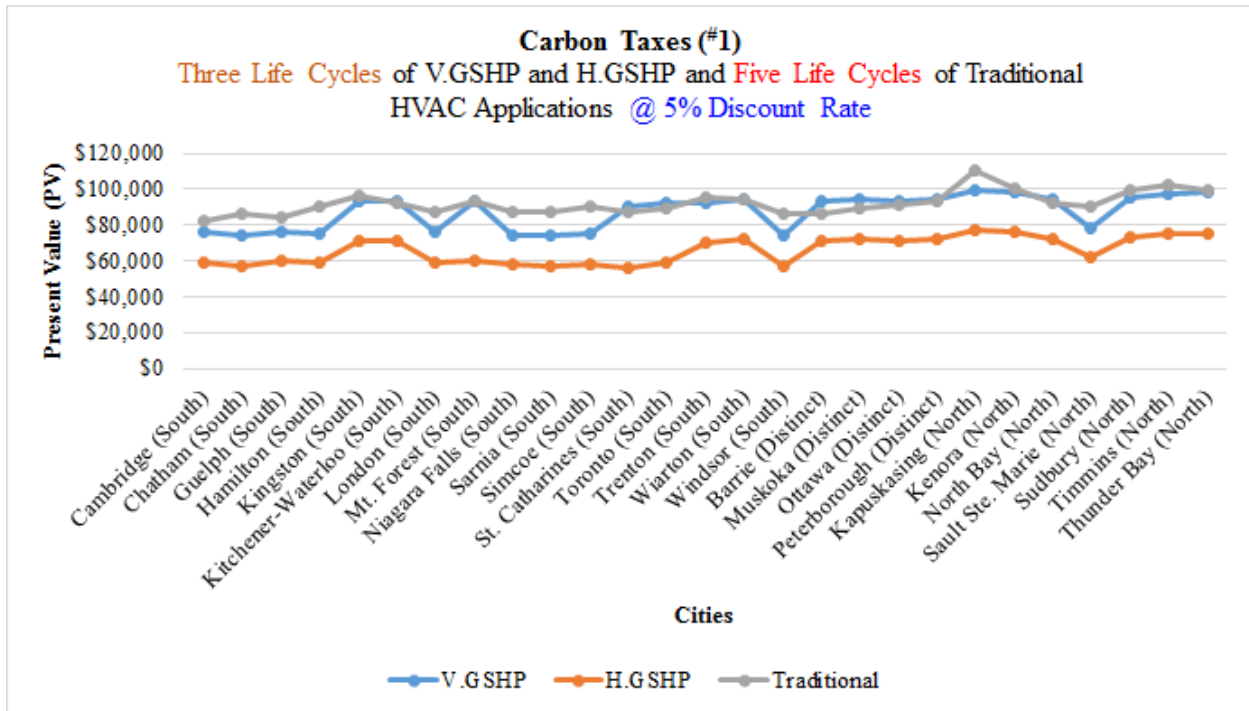

Table E2-1.38: Economic Variation of HVAC technologies for carbon taxes scenario (improved construction type) at a discount rate of 5% (three life cycles of V.GSHP and H.GSHP and five life cycles of Traditional HVAC Applications for a 60 year project lifespan)

FIT – (#2)

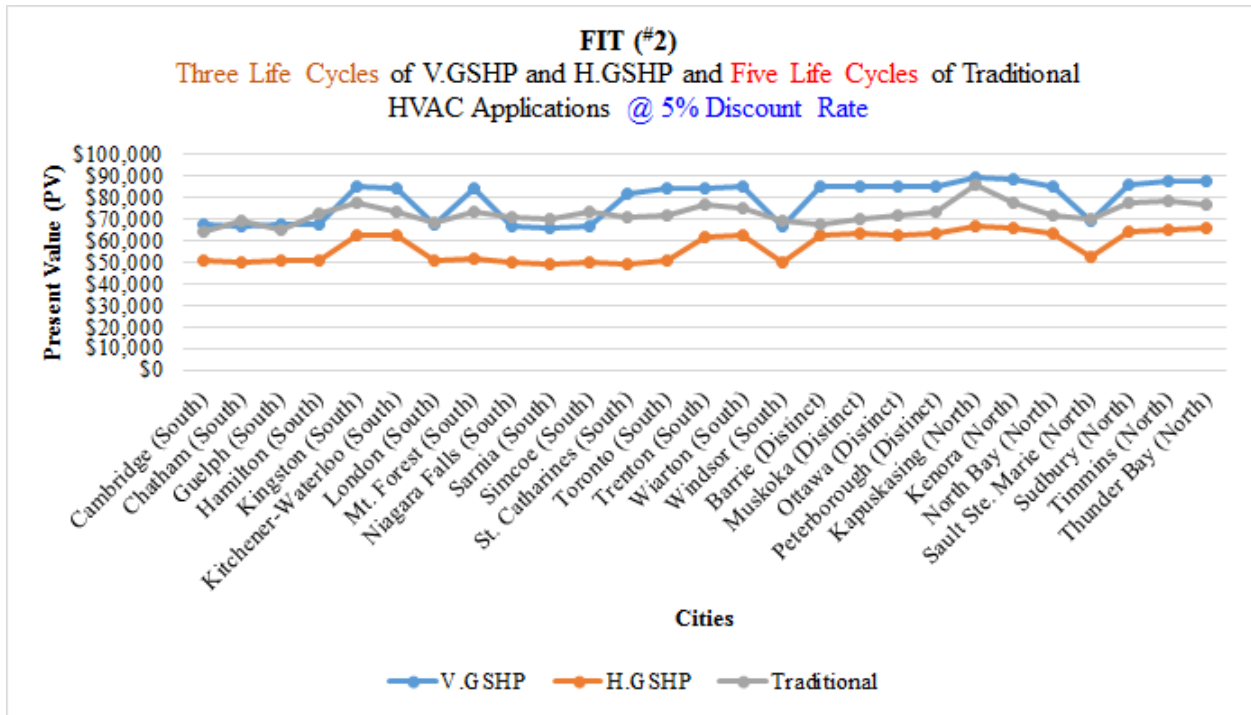

Table E2-1.39: Economic Variation of HVAC technologies for feed-in tariff scenario (improved construction type) at a discount rate of 5% (three life cycles of V.GSHP and H.GSHP and five life cycles of Traditional HVAC Applications for a 60 year project lifespan)

Rebates – (#3)

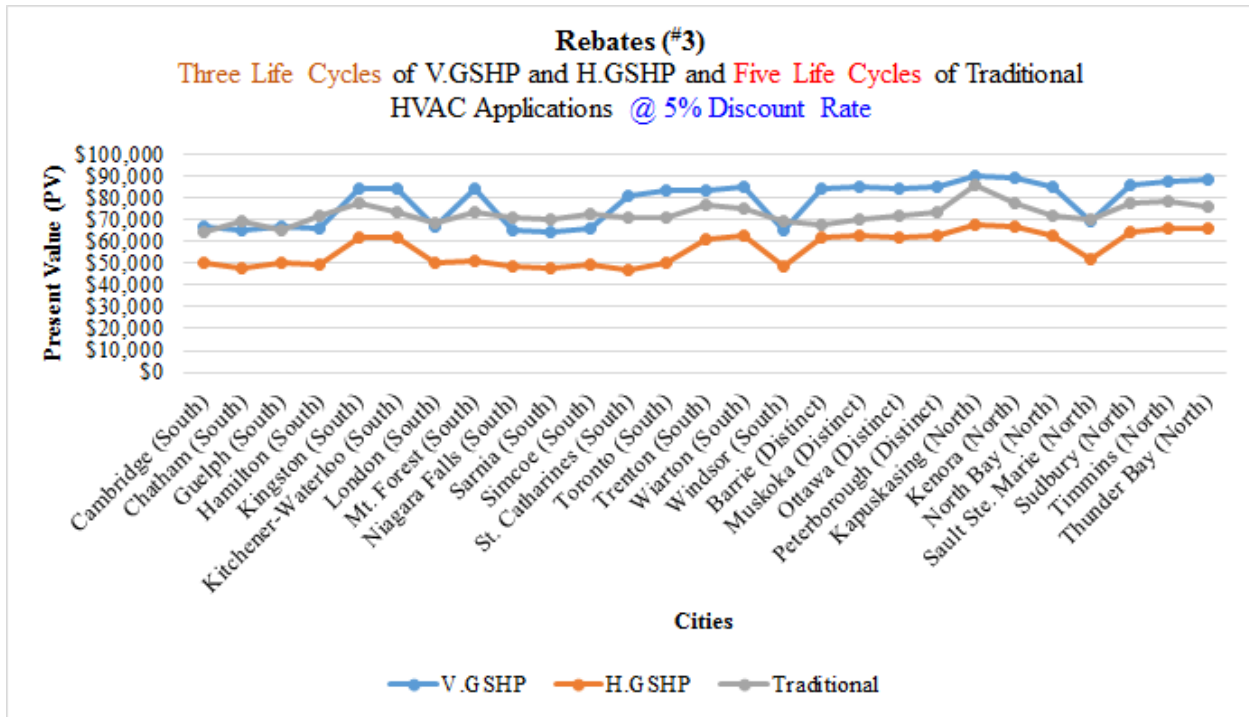

Table E2-1.40: Economic Variation of HVAC technologies for rebates scenario (improved construction type) at a discount rate of 5% (three life cycles of V.GSHP and H.GSHP and five life cycles of Traditional HVAC Applications for a 60 year project lifespan)

FIT + Rebates – (#4)

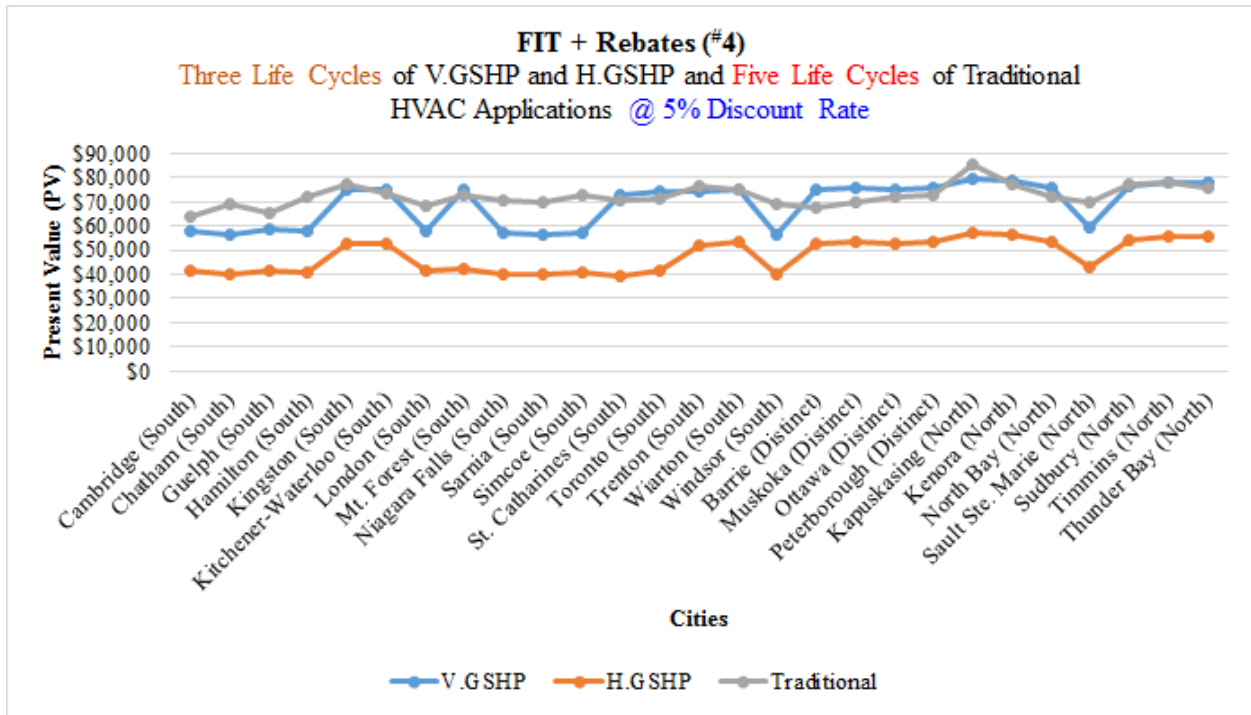

Table E2-1.41: Economic Variation of HVAC technologies for feed-in tariff + rebates scenario (improved construction type) at a discount rate of 5% (three life cycles of V.GSHP and H.GSHP and five life cycles of Traditional HVAC Applications for a 60 year project lifespan)

(FIT + Rebates) + Carbon Taxes – (#5)

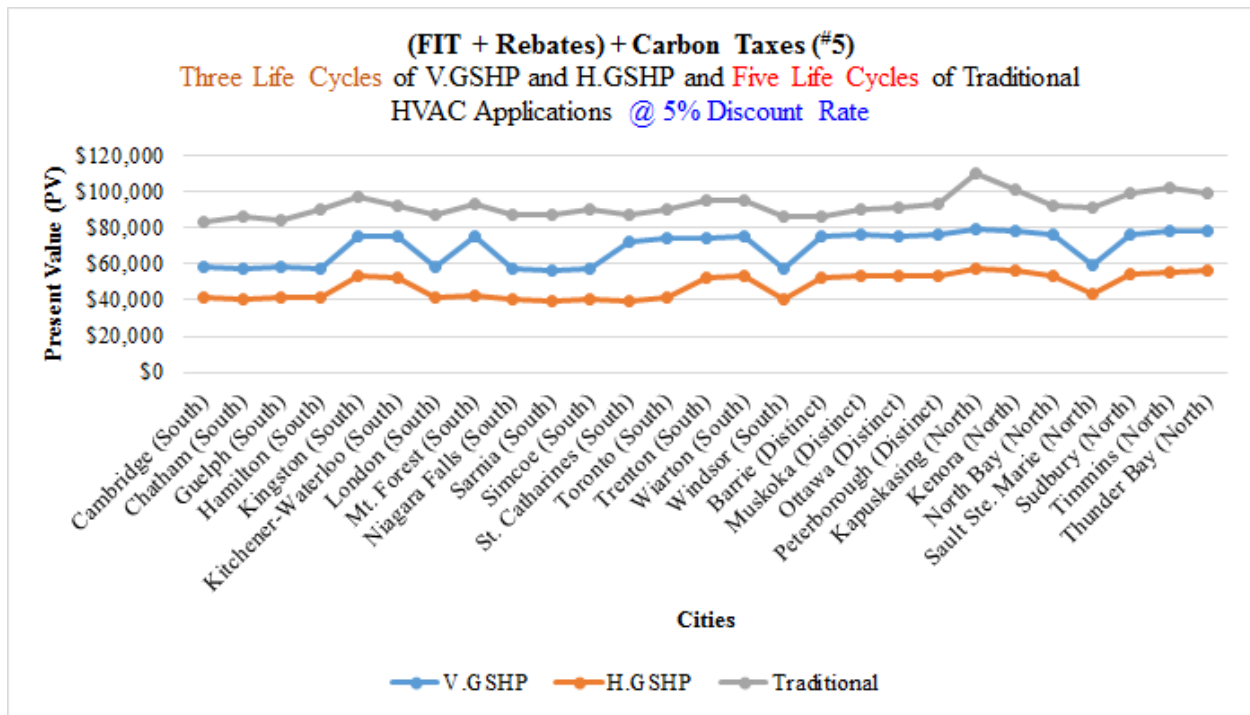

Table E2-1.42: Economic Variation of HVAC technologies for feed-in tariff + rebates + carbon tax scenario (improved construction type) at a discount rate of 5% (three life cycles of V.GSHP and H.GSHP and five life cycles of Traditional HVAC Applications for a 60 year project lifespan)

8. Three Life Cycles of V.GSHP and H.GSHP and Five Life Cycles of Traditional HVAC Applications @ 7% Discount Rate

Base Case Scenario

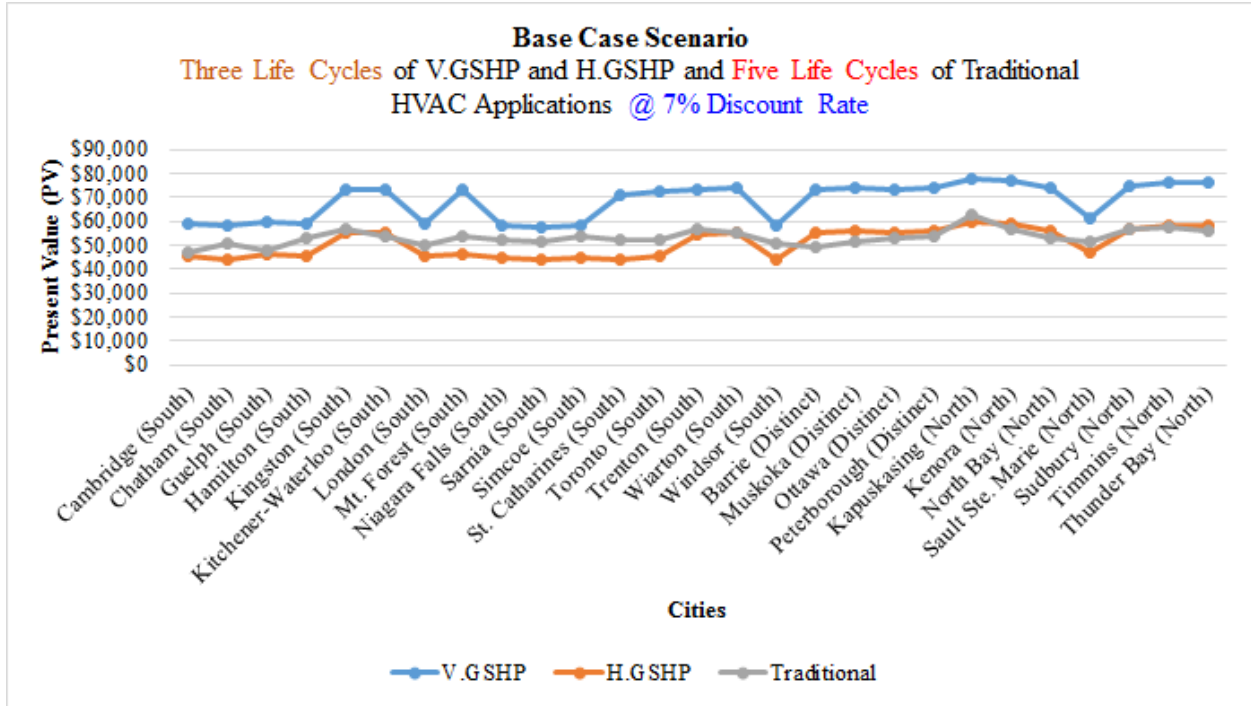

Table E2-1.43: Economic Variation of HVAC technologies for base case scenario (improved construction type) at a discount rate of 7% (three life cycles of V.GSHP and H.GSHP and five life cycles of Traditional HVAC Applications for a 60 year project lifespan)

Carbon Taxes – (#1)

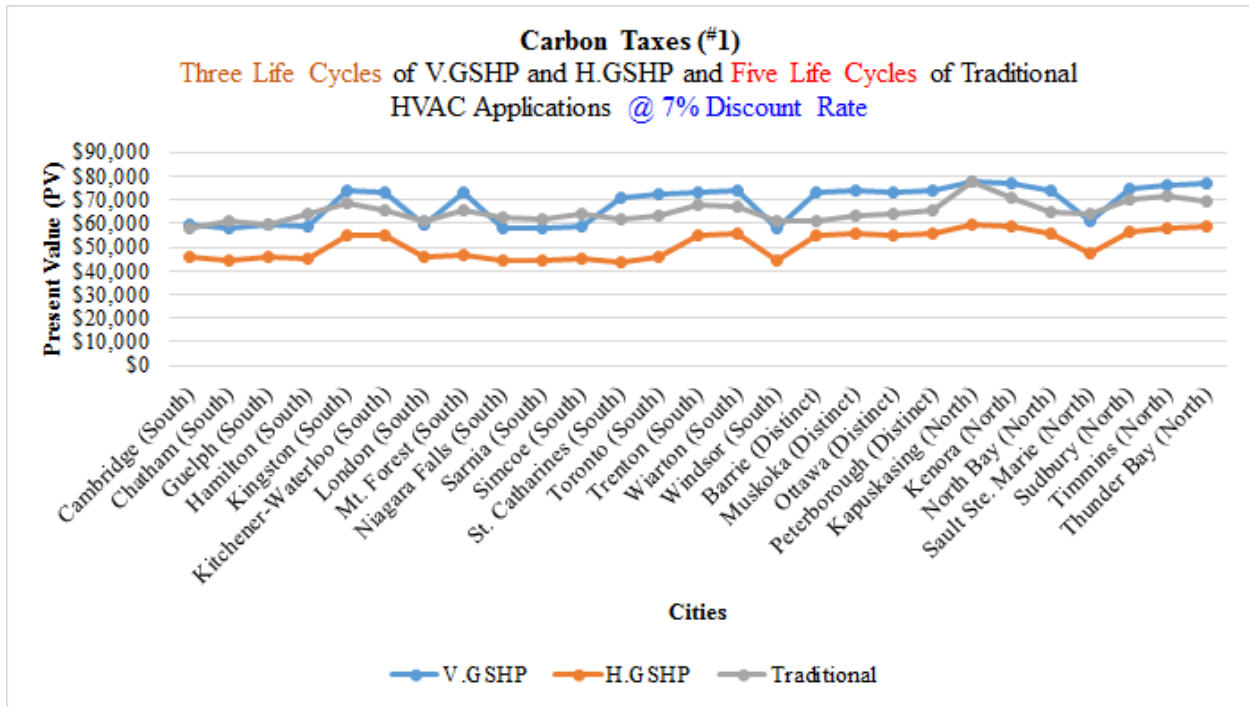

Table E2-1.44: Economic Variation of HVAC technologies for carbon taxes scenario (improved construction type) at a discount rate of 7% (three life cycles of V.GSHP and H.GSHP and five life cycles of Traditional HVAC Applications for a 60 year project lifespan)

FIT – (#2)

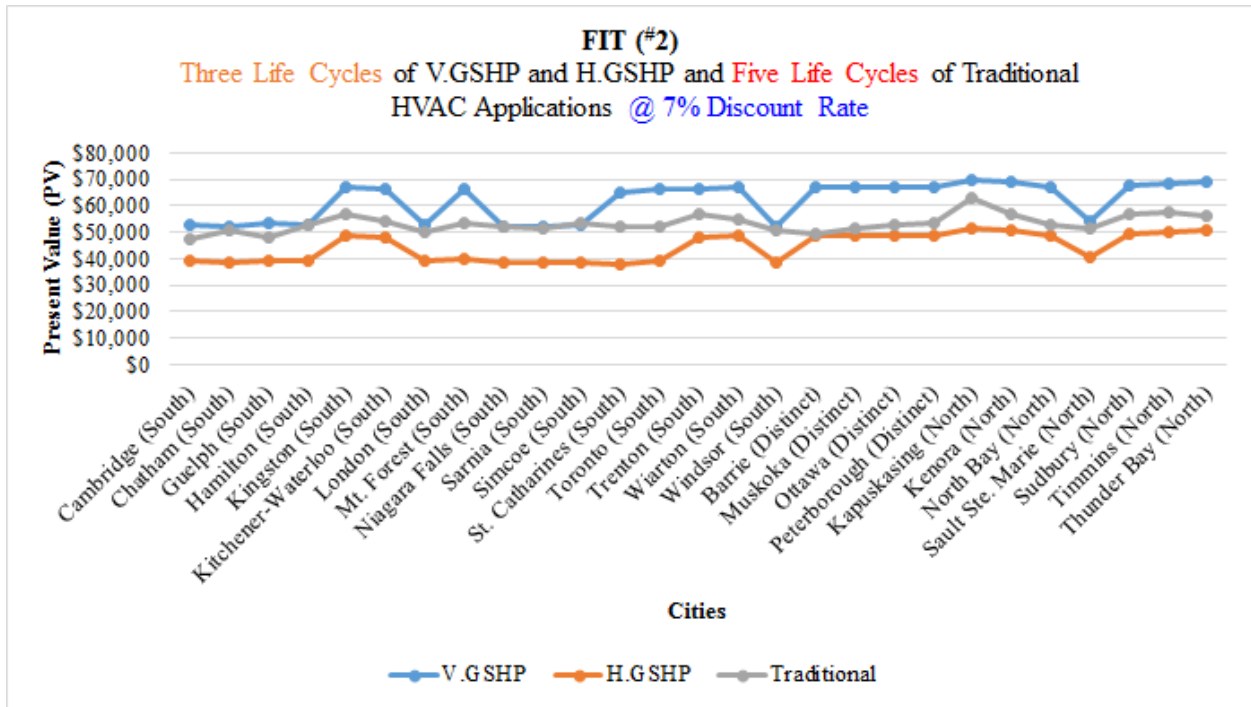

Table E2-1.45: Economic Variation of HVAC technologies for feed-in tariff scenario (improved construction type) at a discount rate of 7% (three life cycles of V.GSHP and H.GSHP and five life cycles of Traditional HVAC Applications for a 60 year project lifespan)

Rebates – (#3)

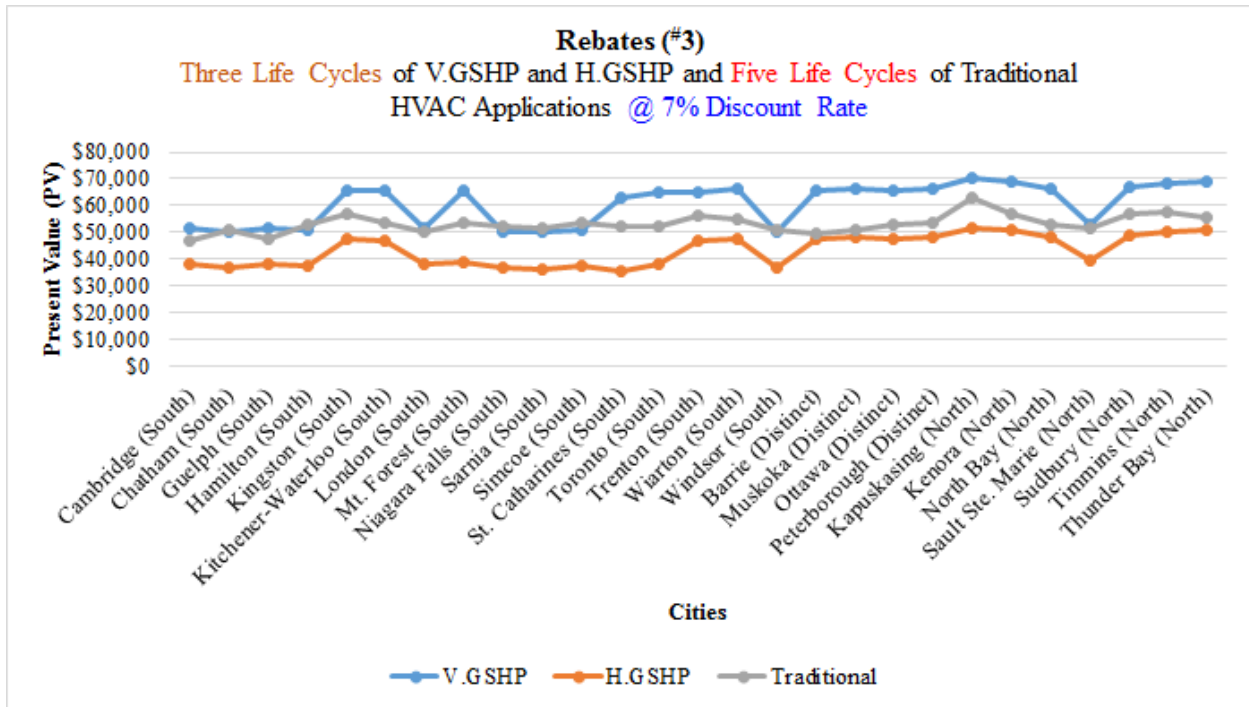

Table E2-1.46: Economic Variation of HVAC technologies for rebates scenario (improved construction type) at a discount rate of 7% (three life cycles of V.GSHP and H.GSHP and five life cycles of Traditional HVAC Applications for a 60 year project lifespan)

FIT + Rebates – (#4)

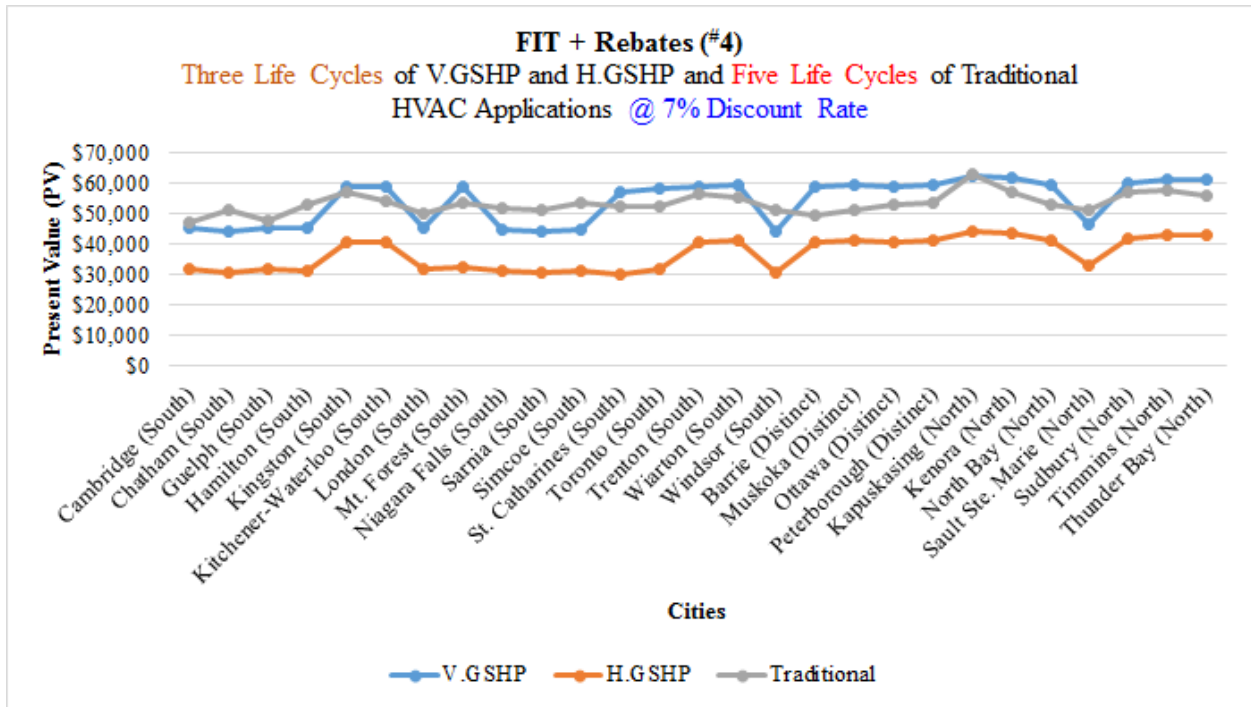

Table E2-1.47: Economic Variation of HVAC technologies for feed-in tariff + rebates scenario (improved construction type) at a discount rate of 7% (three life cycles of V.GSHP and H.GSHP and five life cycles of Traditional HVAC Applications for a 60 year project lifespan)

(FIT + Rebates) + Carbon Taxes – (#5)

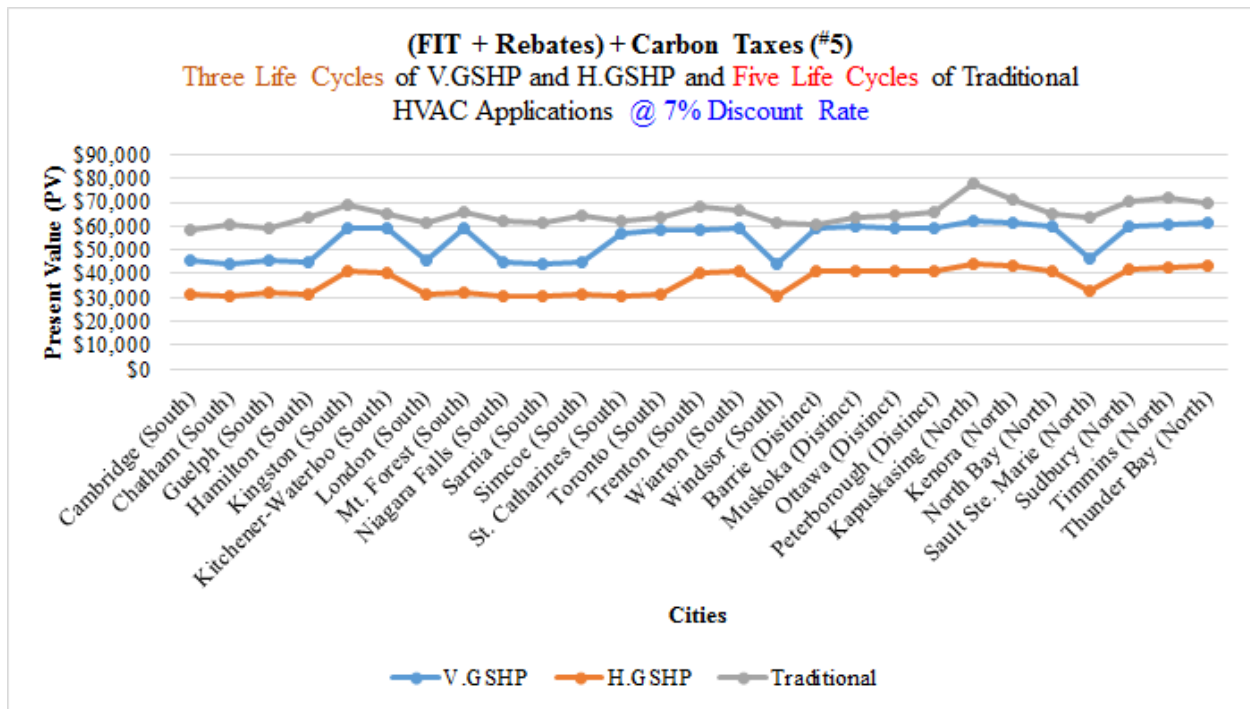

Table E2-1.48: Economic Variation of HVAC technologies for feed-in tariff + rebates + carbon tax scenario (improved construction type) at a discount rate of 7% (three life cycles of V.GSHP and H.GSHP and five life cycles of Traditional HVAC Applications for a 60 year project lifespan)

9. Three Life Cycles of V.GSHP and H.GSHP and Five Life Cycles of Traditional HVAC Applications @ 7.5% Discount Rate

Base Case Scenario

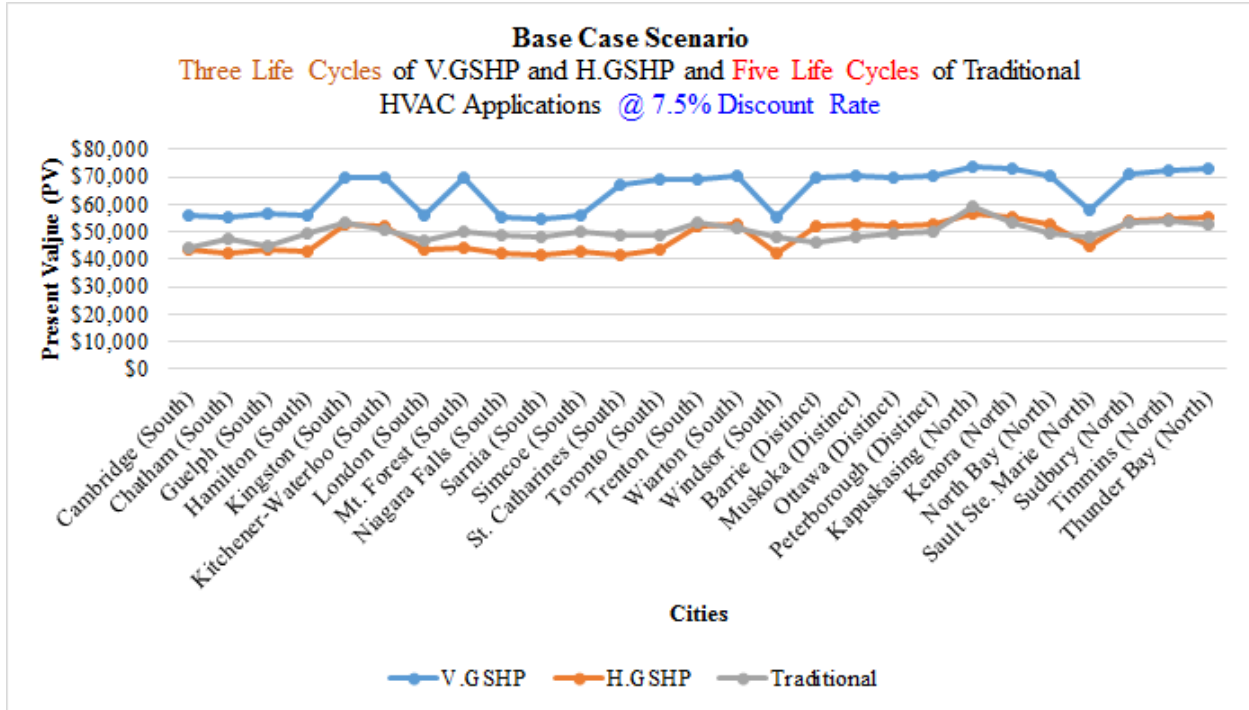

Table E2-1.49: Economic Variation of HVAC technologies for base case scenario (improved construction type) at a discount rate of 7.5% (three life cycles of V.GSHP and H.GSHP and five life cycles of Traditional HVAC Applications for a 60 year project lifespan)

Carbon Taxes – (#1)

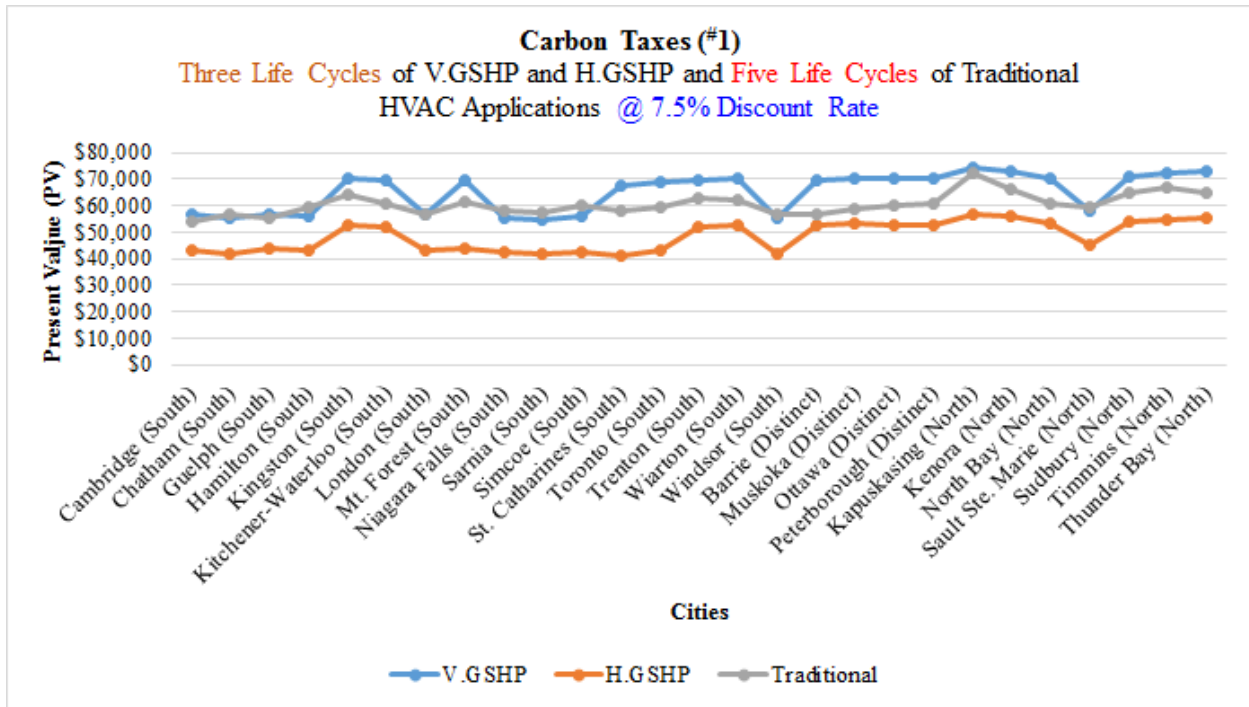

Table E2-1.50: Economic Variation of HVAC technologies for carbon taxes scenario (improved construction type) at a discount rate of 7.5% (three life cycles of V.GSHP and H.GSHP and five life cycles of Traditional HVAC Applications for a 60 year project lifespan)

FIT – (#2)

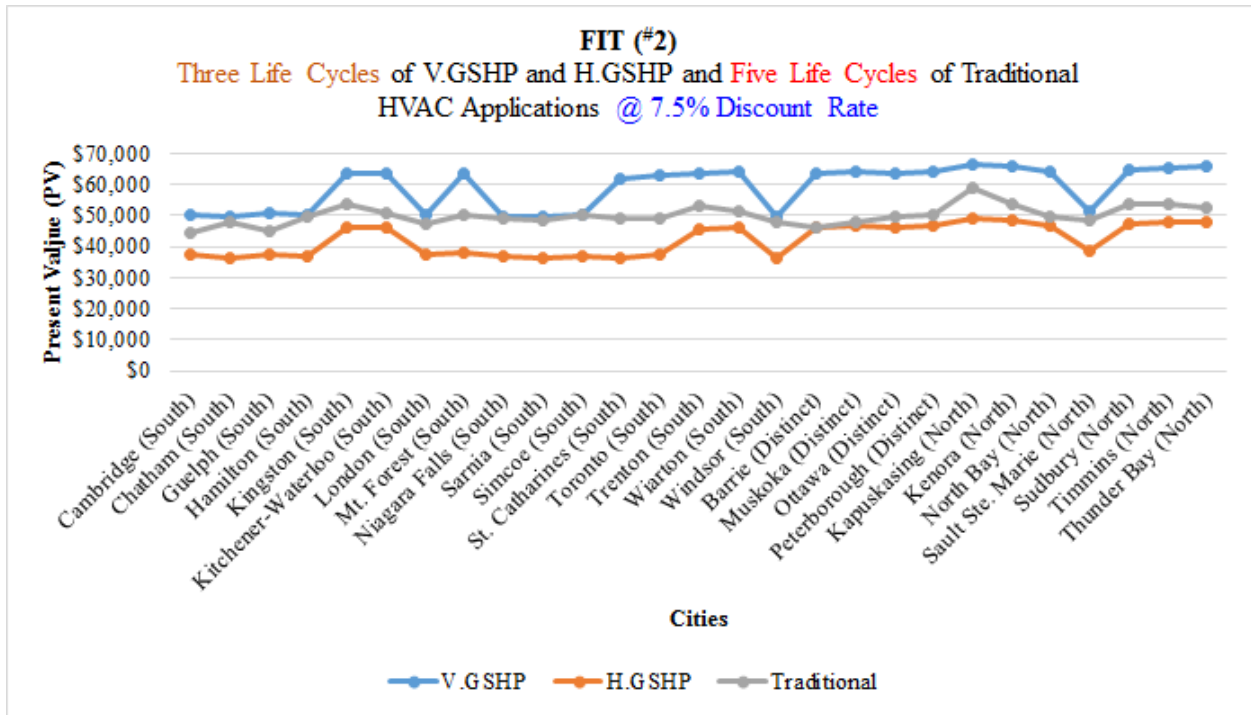

Table E2-1.51: Economic Variation of HVAC technologies for feed-in tariff scenario (improved construction type) at a discount rate of 7.5% (three life cycles of V.GSHP and H.GSHP and five life cycles of Traditional HVAC Applications for a 60 year project lifespan)

Rebates – (#3)

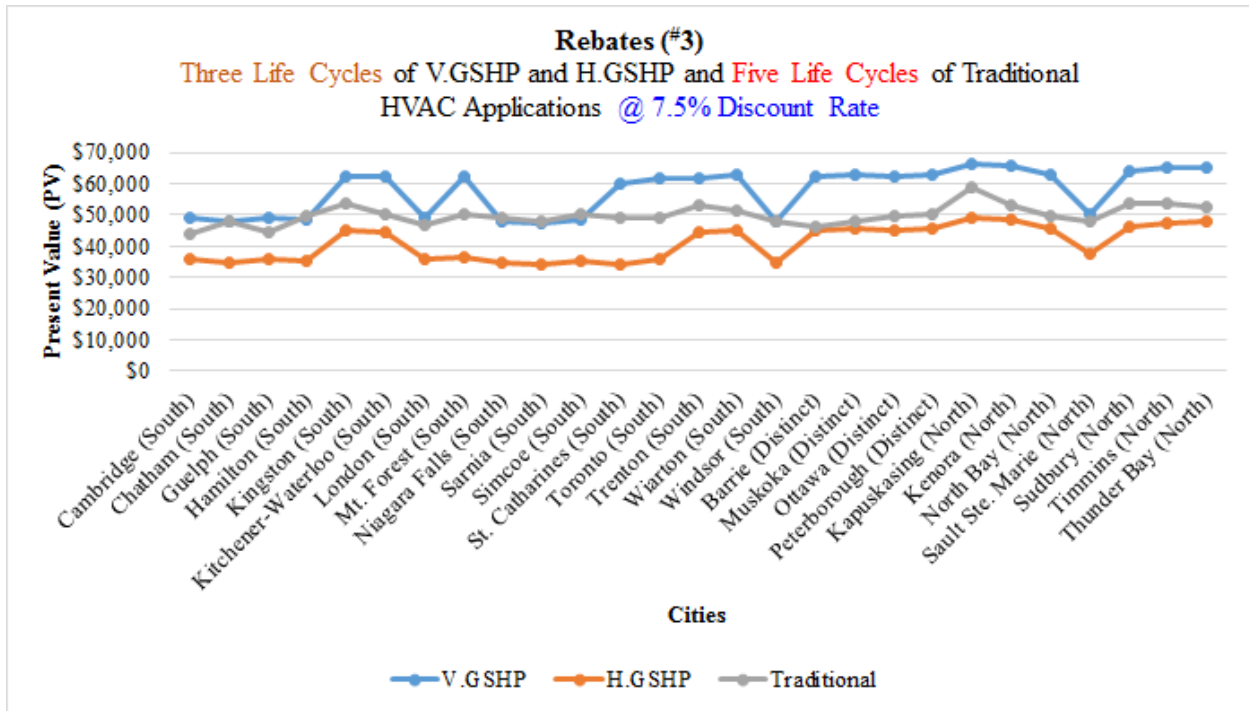

Table E2-1.52: Economic Variation of HVAC technologies for rebates scenario (improved construction type) at a discount rate of 7.5% (three life cycles of V.GSHP and H.GSHP and five life cycles of Traditional HVAC Applications for a 60 year project lifespan)

FIT + Rebates – (#4)

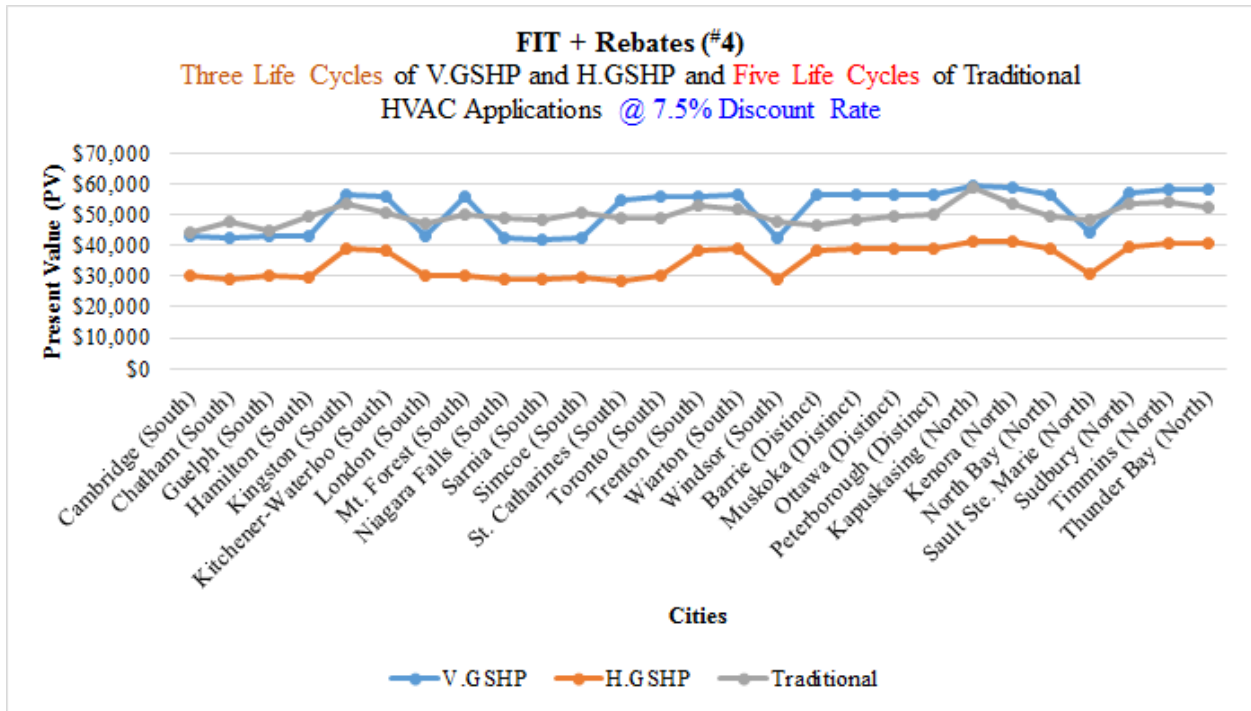

Table E2-1.53: Economic Variation of HVAC technologies for feed-in tariff + rebates scenario (improved construction type) at a discount rate of 7.5% (three life cycles of V.GSHP and H.GSHP and five life cycles of Traditional HVAC Applications for a 60 year project lifespan)

(FIT + Rebates) + Carbon Taxes – (#5)

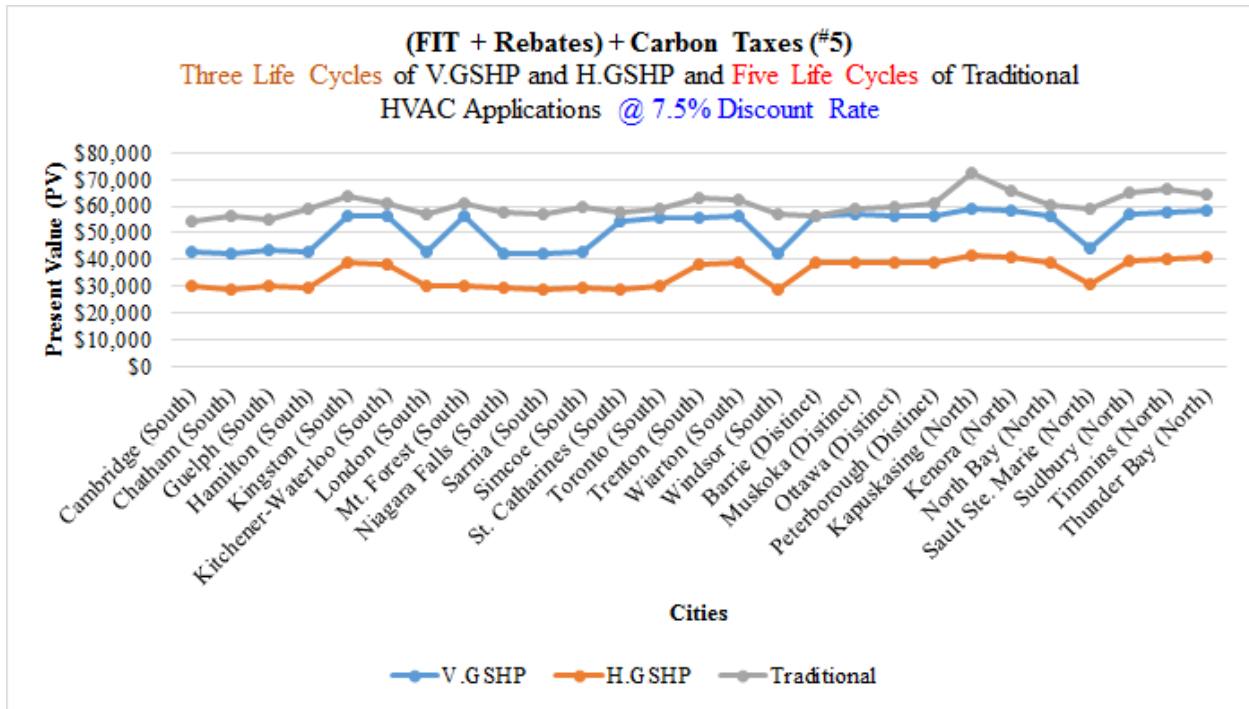

Table E2-1.54: Economic Variation of HVAC technologies for feed-in tariff + rebates + carbon tax scenario (improved construction type) at a discount rate of 7.5% (three life cycles of V.GSHP and H.GSHP and five life cycles of Traditional HVAC Applications for a 60 year project lifespan)

10. Three Life Cycles of V.GSHP and H.GSHP and Five Life Cycles of Traditional HVAC Applications @ 8.5% Discount Rate

Base Case Scenario

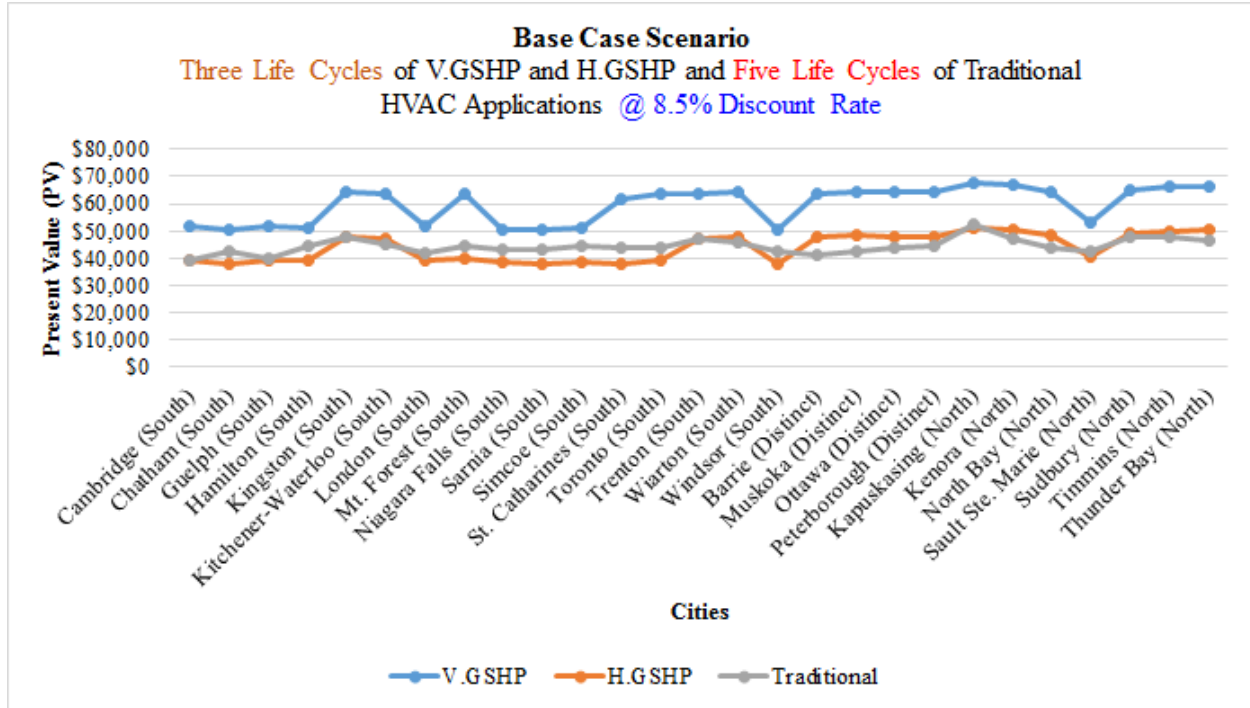

Table E2-1.55: Economic Variation of HVAC technologies for base case scenario (improved construction type) at a discount rate of 8.5% (three life cycles of V.GSHP and H.GSHP and five life cycles of Traditional HVAC Applications for a 60 year project lifespan)

Carbon Taxes – (#1)

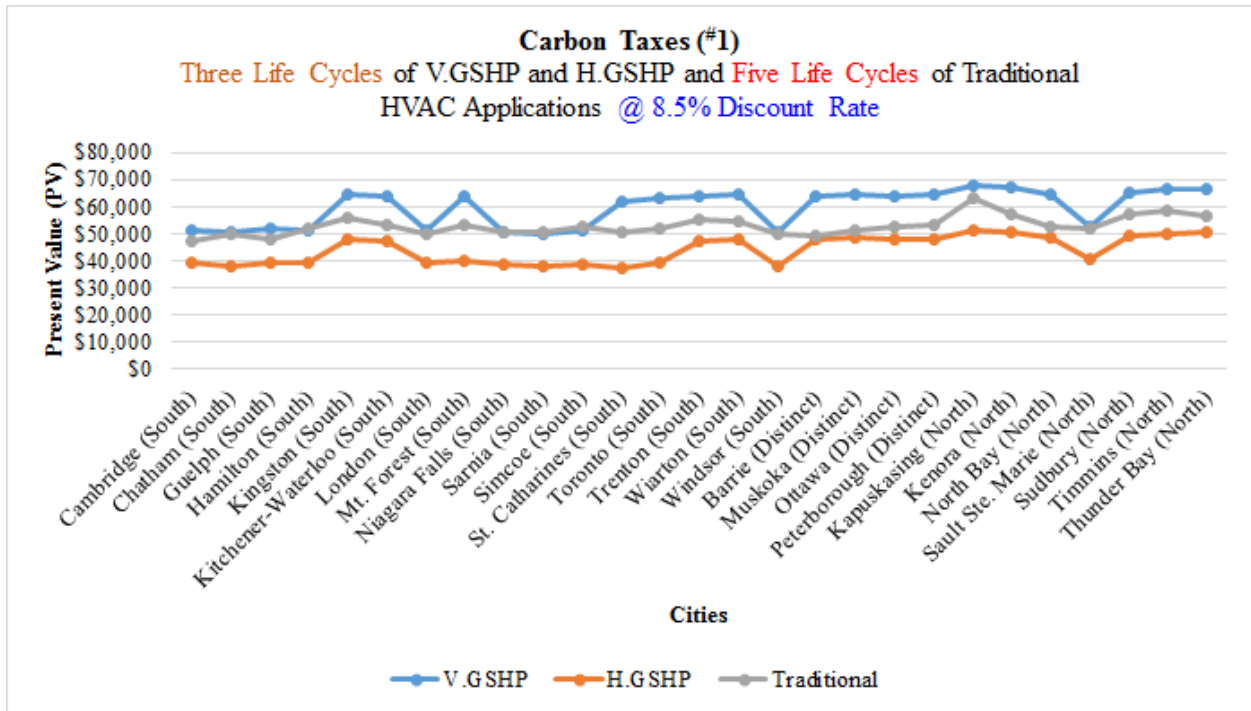

Table E2-1.56: Economic Variation of HVAC technologies for carbon taxes scenario (improved construction type) at a discount rate of 8.5% (three life cycles of V.GSHP and H.GSHP and five life cycles of Traditional HVAC Applications for a 60 year project lifespan)

FIT – (#2)

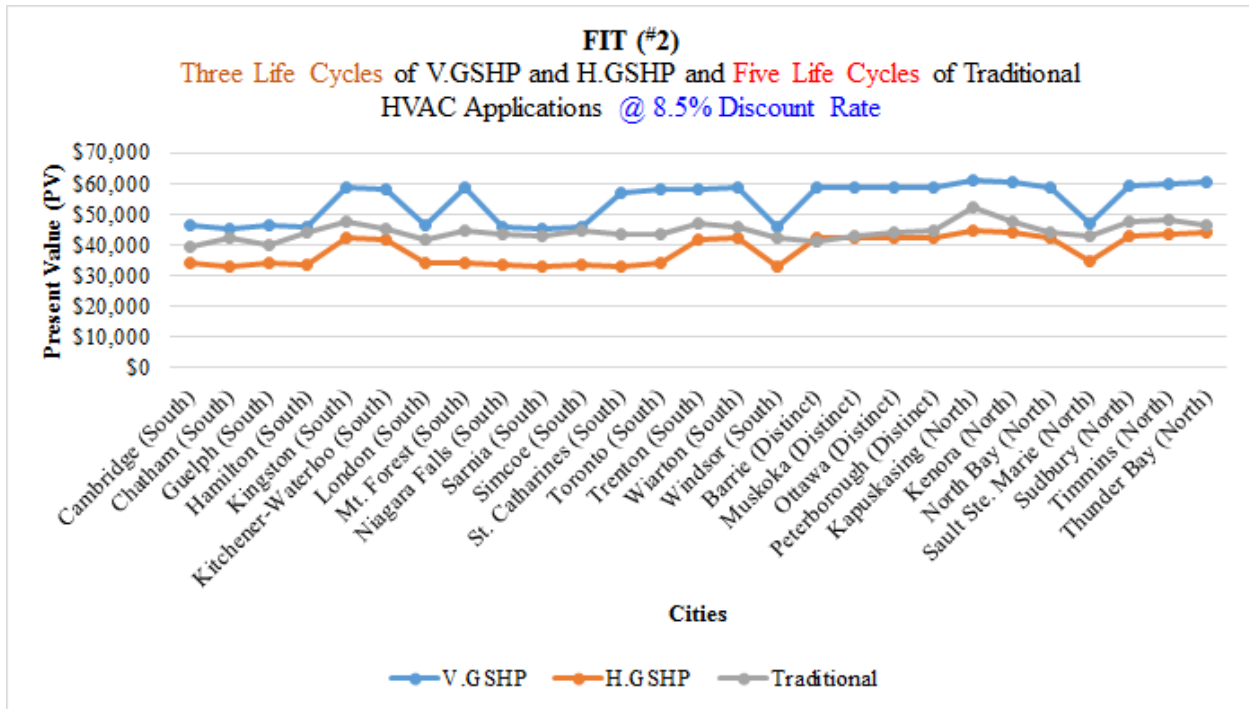

Table E2-1.57: Economic Variation of HVAC technologies for feed-in tariff scenario (improved construction type) at a discount rate of 8.5% (three life cycles of V.GSHP and H.GSHP and five life cycles of Traditional HVAC Applications for a 60 year project lifespan)

Rebates – (#3)

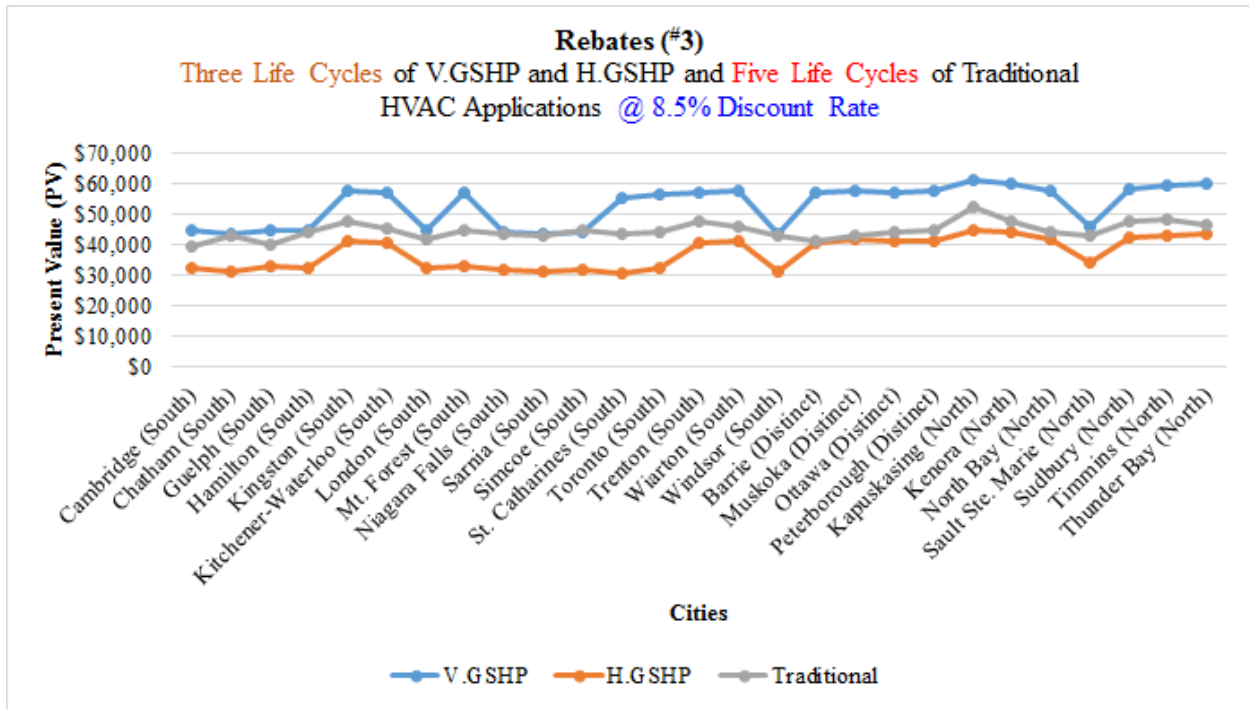

Table E2-1.58: Economic Variation of HVAC technologies for rebates scenario (improved construction type) at a discount rate of 8.5% (three life cycles of V.GSHP and H.GSHP and five life cycles of Traditional HVAC Applications for a 60 year project lifespan)

FIT + Rebates – (#4)

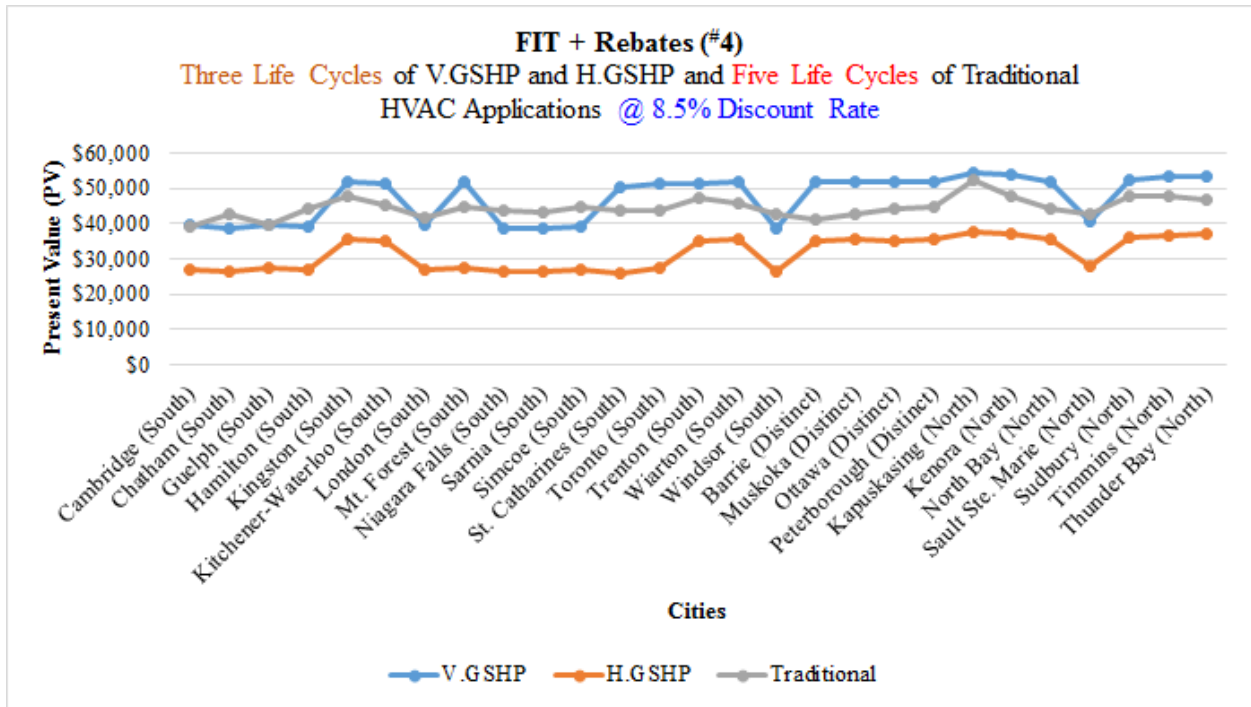

Table E2-1.59: Economic Variation of HVAC technologies for feed-in tariff + rebates scenario (improved construction type) at a discount rate of 8.5% (three life cycles of V.GSHP and H.GSHP and five life cycles of Traditional HVAC Applications for a 60 year project lifespan)

(FIT + Rebates) + Carbon Taxes – (#5)

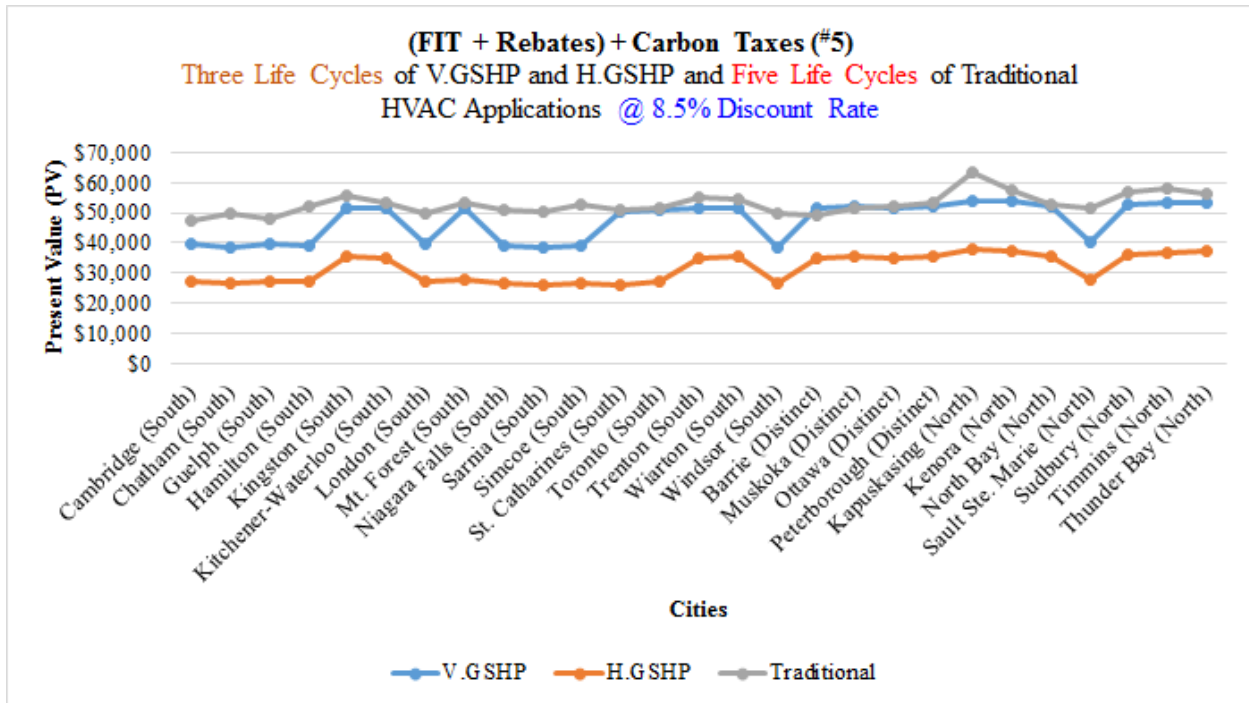

Table E2-1.60: Economic Variation of HVAC technologies for feed-in tariff + rebates + carbon tax scenario (improved construction type) at a discount rate of 8.5% (three life cycles of V.GSHP and H.GSHP and five life cycles of Traditional HVAC Applications for a 60 year project lifespan)

11. Three Life Cycles of V.GSHP and H.GSHP and Five Life Cycles of Traditional HVAC Applications @ 10% Discount Rate

Base Case Scenario

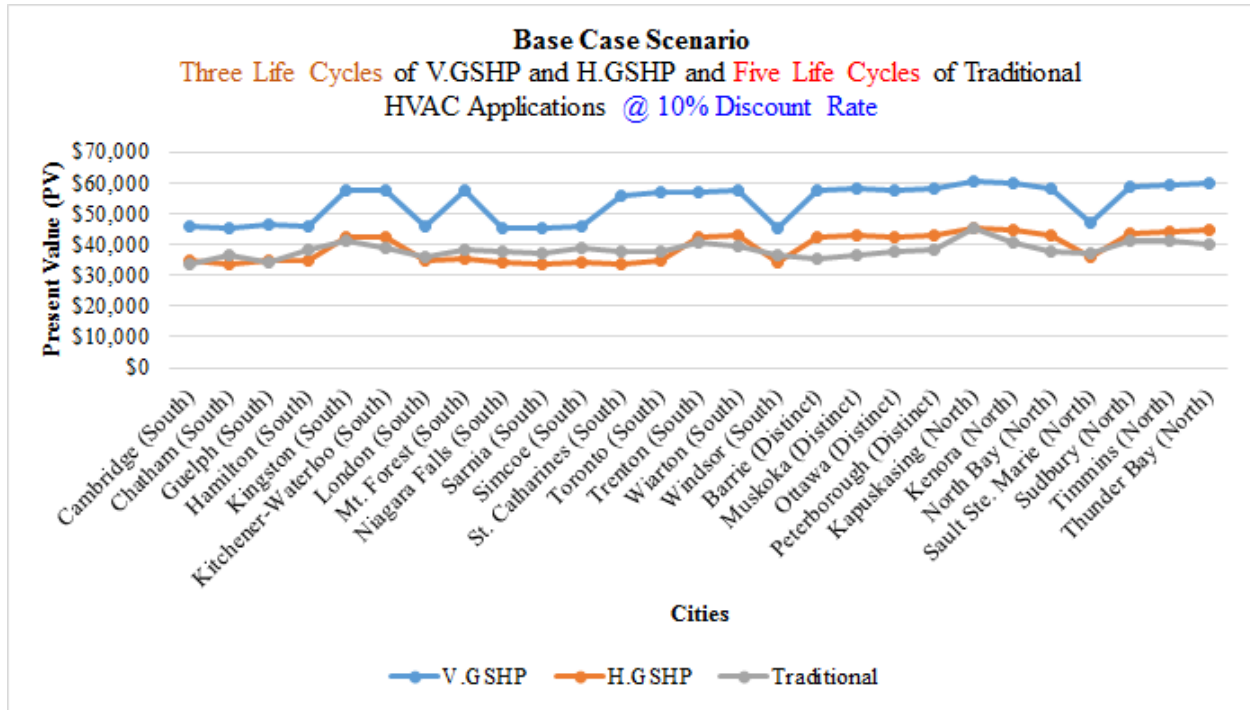

Table E2-1.61: Economic Variation of HVAC technologies for base case scenario (improved construction type) at a discount rate of 10% (three life cycles of V.GSHP and H.GSHP and five life cycles of Traditional HVAC Applications for a 60 year project lifespan)

Carbon Taxes – (#1)

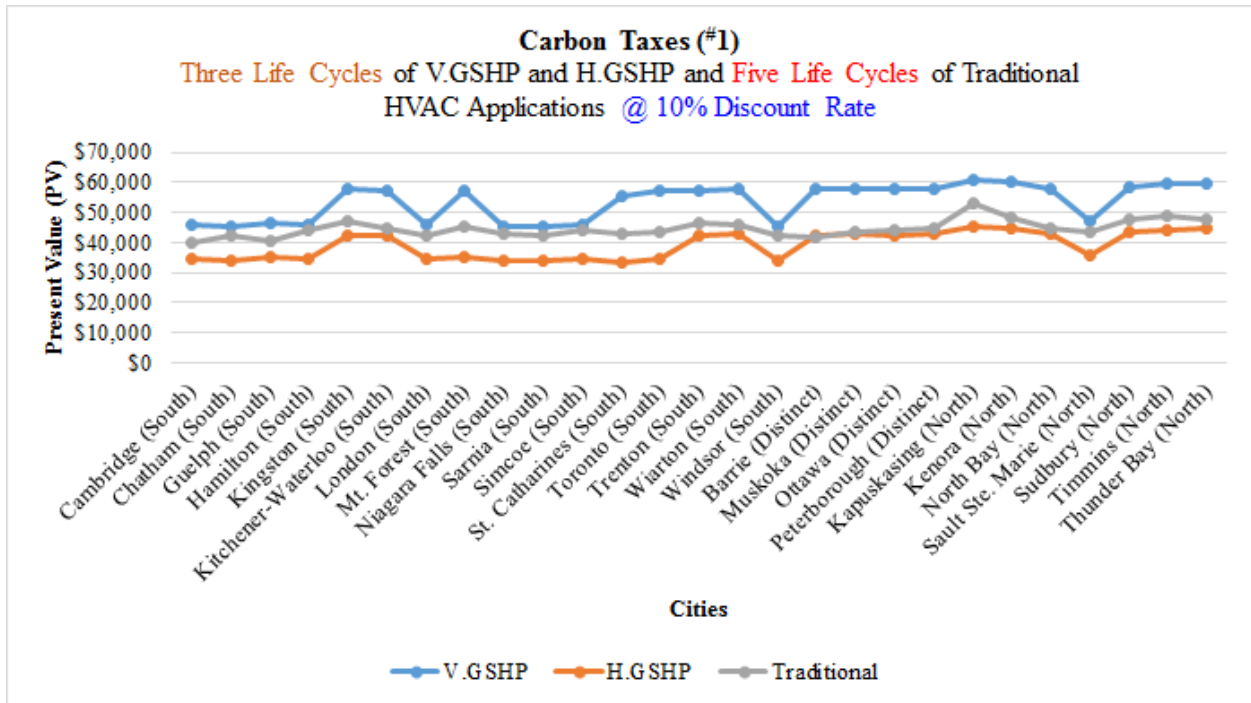

Table E2-1.62: Economic Variation of HVAC technologies for carbon taxes scenario (improved construction type) at a discount rate of 10% (three life cycles of V.GSHP and H.GSHP and five life cycles of Traditional HVAC Applications for a 60 year project lifespan)

FIT – (#2)

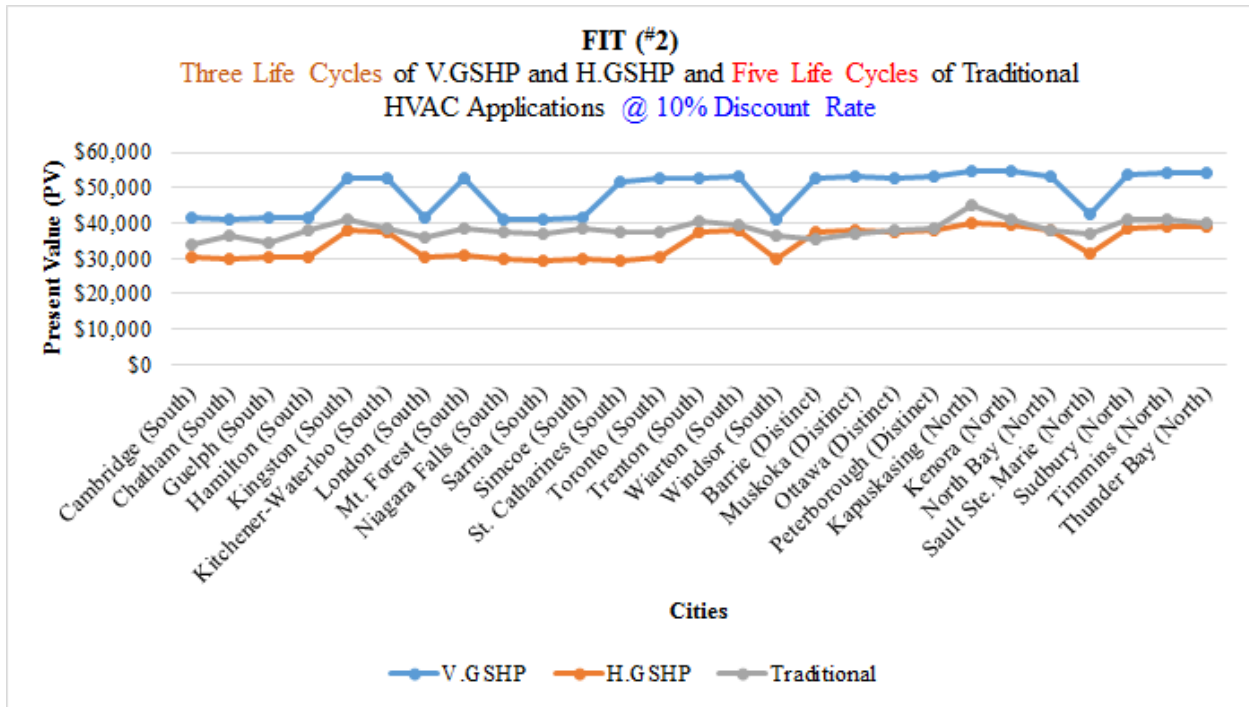

Table E2-1.63: Economic Variation of HVAC technologies for feed-in tariff scenario (improved construction type) at a discount rate of 10% (three life cycles of V.GSHP and H.GSHP and five life cycles of Traditional HVAC Applications for a 60 year project lifespan)

Rebates – (#3)

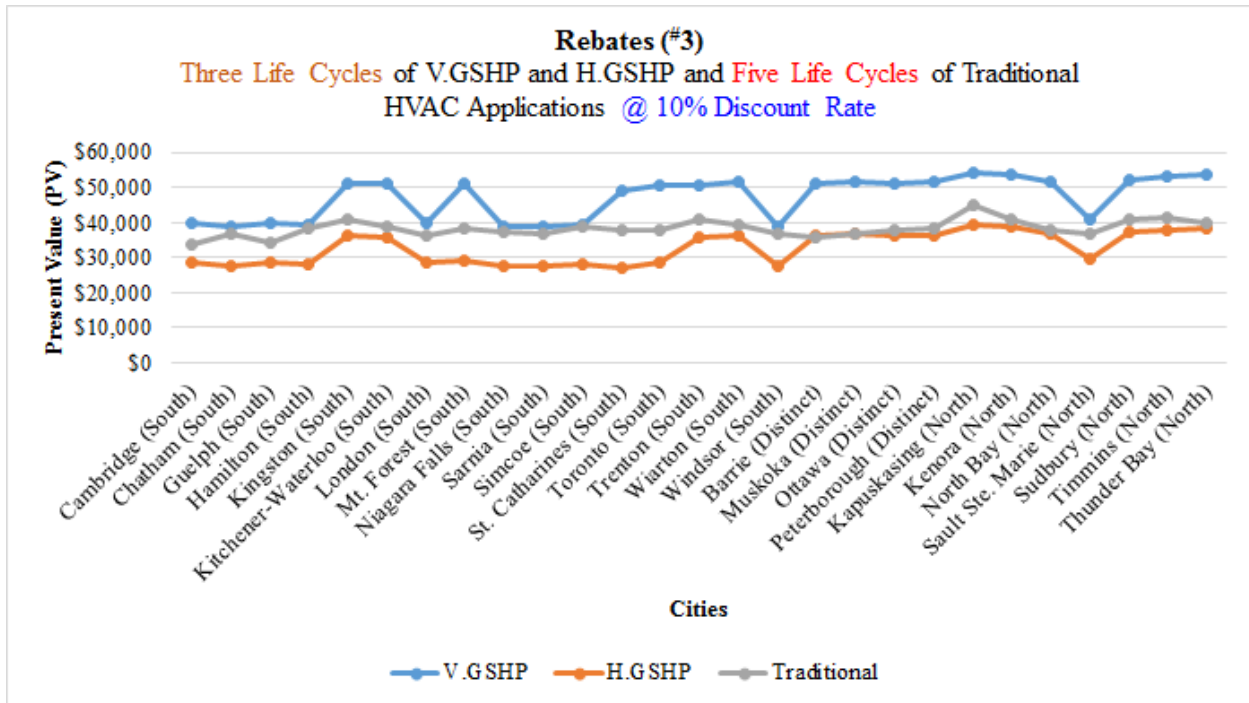

Table E2-1.64: Economic Variation of HVAC technologies for rebates scenario (improved construction type) at a discount rate of 10% (three life cycles of V.GSHP and H.GSHP and five life cycles of Traditional HVAC Applications for a 60 year project lifespan)

FIT + Rebates – (#4)

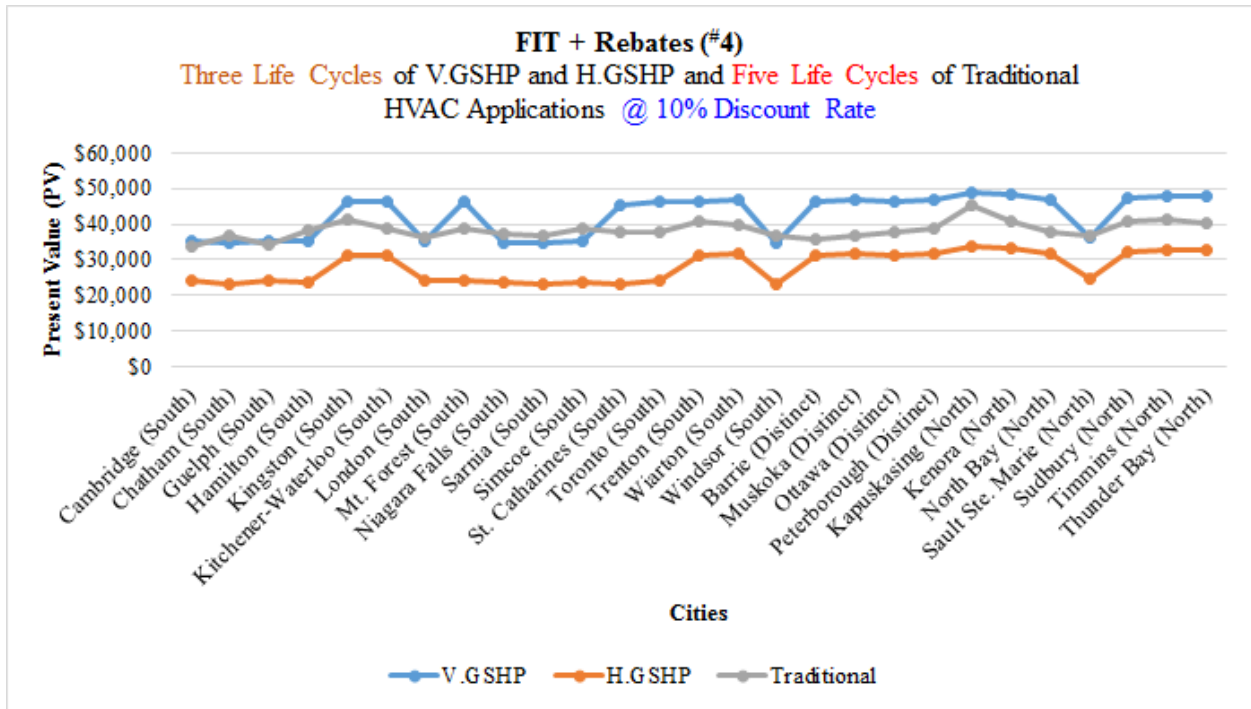

Table E2-1.65: Economic Variation of HVAC technologies for feed-in tariff + rebates scenario (improved construction type) at a discount rate of 10% (three life cycles of V.GSHP and H.GSHP and five life cycles of Traditional HVAC Applications for a 60 year project lifespan)

12. Three Life Cycles of V.GSHP and H.GSHP and Five Life Cycles of Traditional HVAC Applications @ 12% Discount Rate

Base Case Scenario

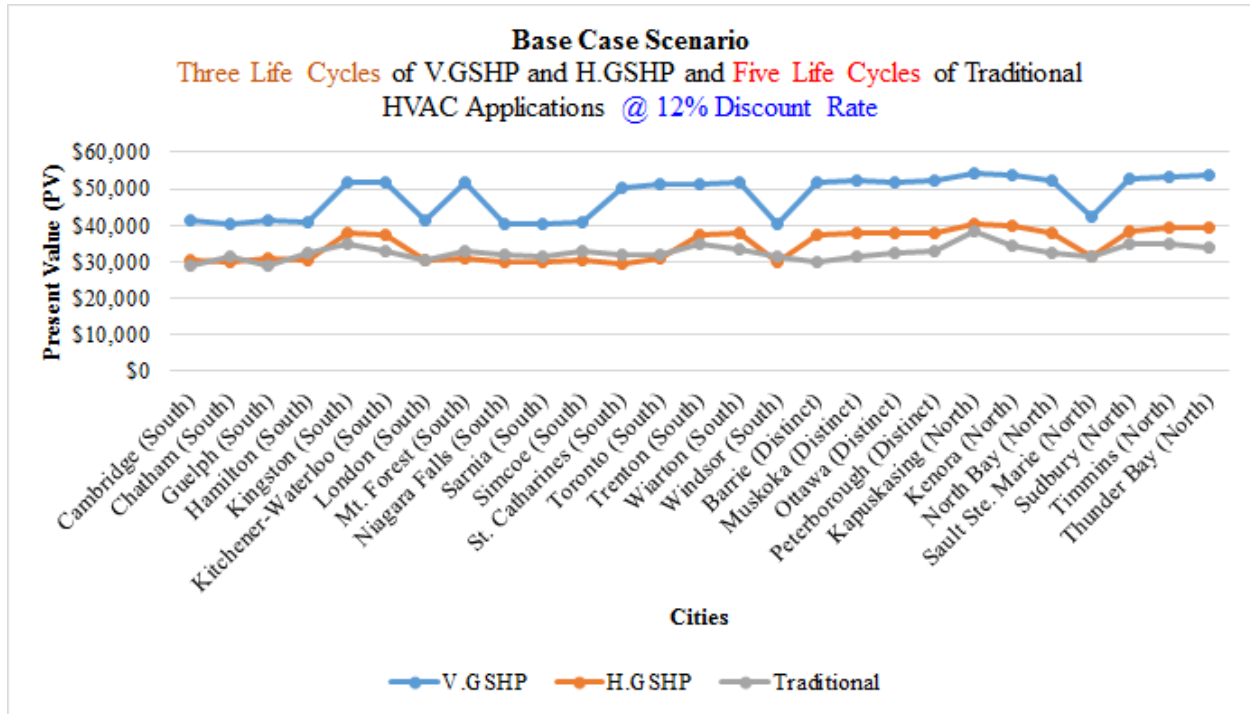

Table E2-1.67: Economic Variation of HVAC technologies for base case scenario (improved construction type) at a discount rate of 12% (three life cycles of V.GSHP and H.GSHP and five life cycles of Traditional HVAC Applications for a 60 year project lifespan)

Carbon Taxes – (#1)

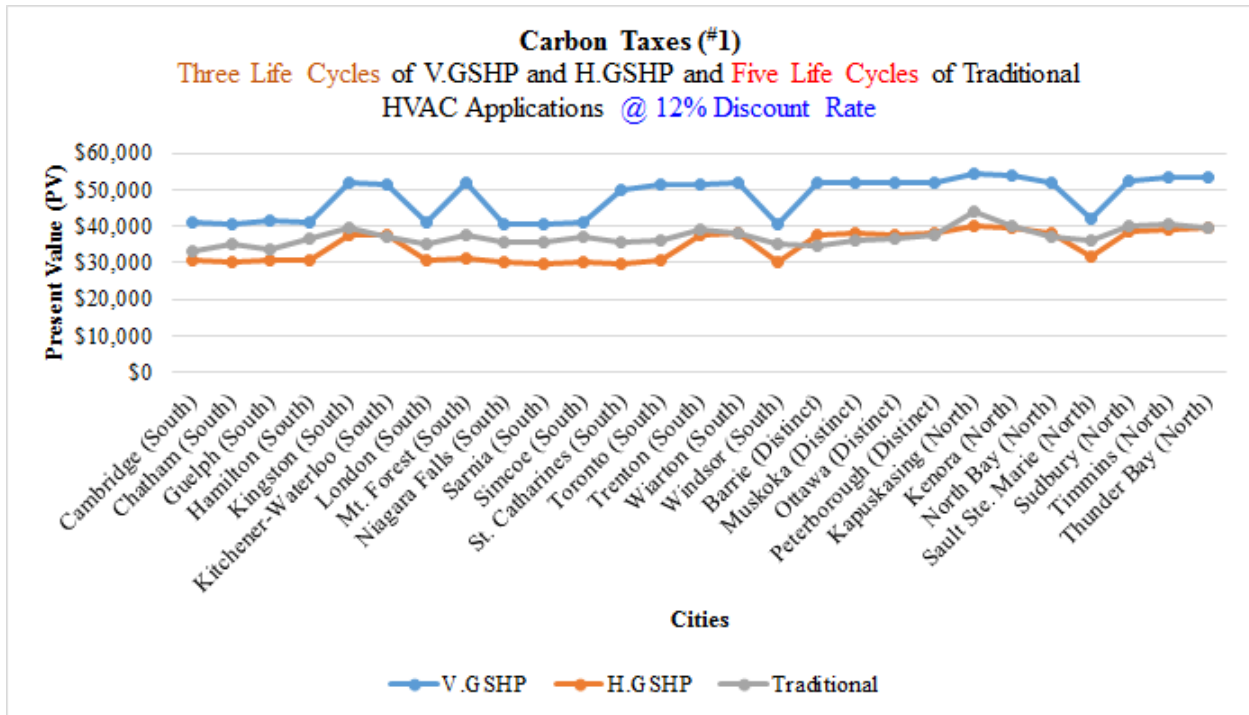

Table E2-1.68: Economic Variation of HVAC technologies for carbon taxes scenario (improved construction type) at a discount rate of 12% (three life cycles of V.GSHP and H.GSHP and five life cycles of Traditional HVAC Applications for a 60 year project lifespan)

FIT – (#2)

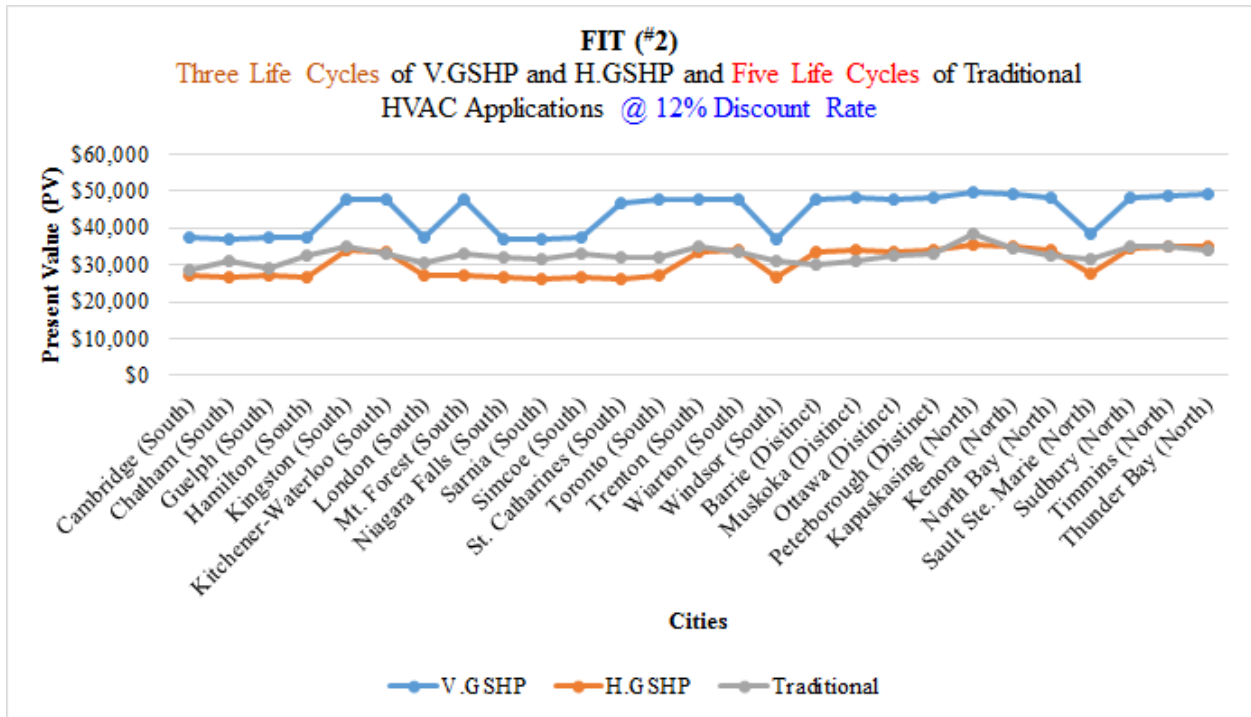

Table E2-1.69: Economic Variation of HVAC technologies for feed-in tariff scenario (improved construction type) at a discount rate of 12% (three life cycles of V.GSHP and H.GSHP and five life cycles of Traditional HVAC Applications for a 60 year project lifespan)

Rebates – (#3)

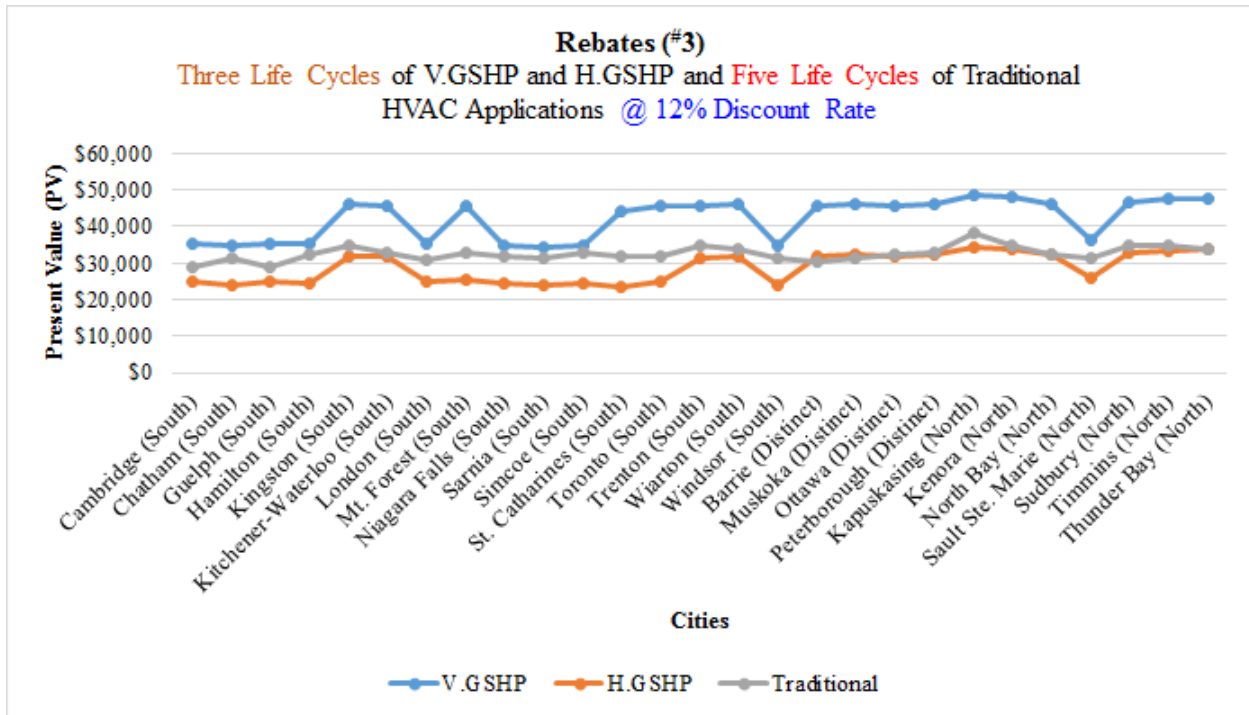

Table E2-1.70: Economic Variation of HVAC technologies for rebates scenario (improved construction type) at a discount rate of 12% (three life cycles of V.GSHP and H.GSHP and five life cycles of Traditional HVAC Applications for a 60 year project lifespan)

FIT + Rebates – (#4)

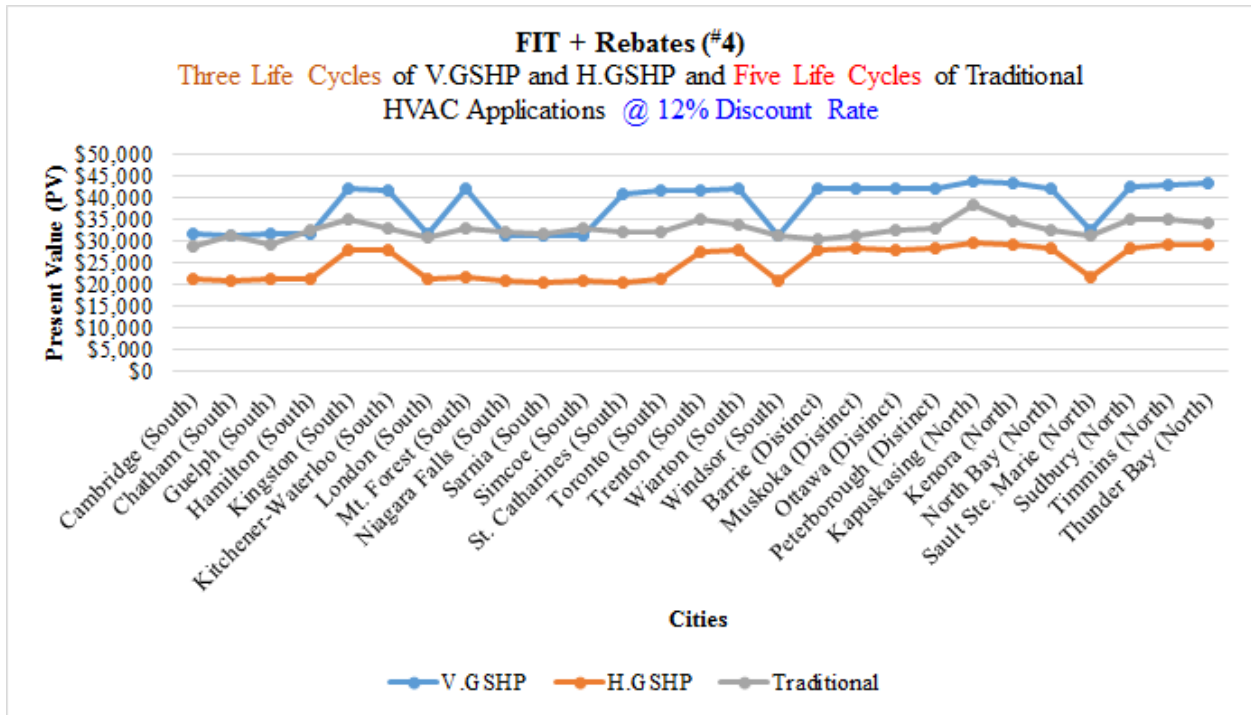

Table E2-1.71: Economic Variation of HVAC technologies for feed-in tariff + rebates scenario (improved construction type) at a discount rate of 12% (three life cycles of V.GSHP and H.GSHP and five life cycles of Traditional HVAC Applications for a 60 year project lifespan)

(FIT + Rebates) + Carbon Taxes – (#5)

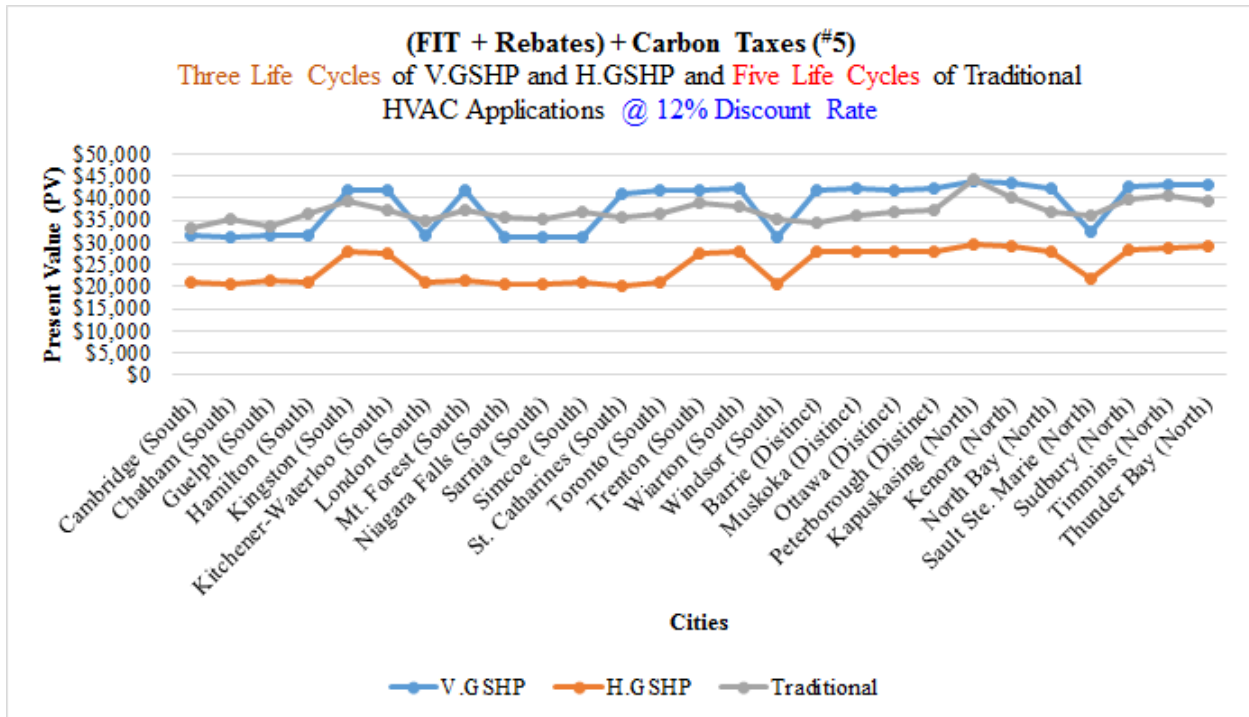

Table E2-1.72: Economic Variation of HVAC technologies for feed-in tariff + rebates + carbon tax scenario (improved construction type) at a discount rate of 12% (three life cycles of V.GSHP and H.GSHP and five life cycles of Traditional HVAC Applications for a 60 year project lifespan)

**Appendix F1 – Rankings of Cities for Different Scenarios Based on Present Value at
Various Discount Factors – Average Construction Type**

**1. Two Life Cycles of V.GSHP and H.GSHP and Five Life Cycles of Traditional HVAC
Applications @ 5% Discount Rate**

Base Case Scenario

Total Present Value										
Base Case Scenario										
#	City	Project Life Span	Discount Rate	V.GSHP	#	City	H.GSHP	#	City	Traditional
1	St. Catharines (South)	60 Years (2 Life Cycles)	5%	\$77,319	1	St. Catharines (South)	\$60,493	1	Cambridge (South)	\$73,410
2	Sarnia (South)	60 Years (2 Life Cycles)	5%	\$78,067	2	Sarnia (South)	\$61,218	2	Guelph (South)	\$74,460
3	Chatham (South)	60 Years (2 Life Cycles)	5%	\$78,254	3	Chatham (South)	\$61,427	3	Chatham (South)	\$76,326
4	Windsor (South)	60 Years (2 Life Cycles)	5%	\$78,289	4	Windsor (South)	\$61,473	4	Windsor (South)	\$76,395
5	Niagara Falls (South)	60 Years (2 Life Cycles)	5%	\$78,605	5	Niagara Falls (South)	\$61,776	5	Niagara Falls (South)	\$77,796
6	Simcoe (South)	60 Years (2 Life Cycles)	5%	\$79,417	6	Simcoe (South)	\$62,607	6	London (South)	\$78,824
7	Hamilton (South)	60 Years (2 Life Cycles)	5%	\$79,978	7	Hamilton (South)	\$63,165	7	St. Catharines (South)	\$79,535
8	Cambridge (South)	60 Years (2 Life Cycles)	5%	\$80,494	8	London (South)	\$63,671	8	Barrie (Distinct)	\$79,861
9	London (South)	60 Years (2 Life Cycles)	5%	\$80,504	9	Cambridge (South)	\$63,687	9	Sarnia (South)	\$80,041
10	Toronto (South)	60 Years (2 Life Cycles)	5%	\$80,526	10	Toronto (South)	\$63,736	10	Simcoe (South)	\$80,339
11	Trenton (South)	60 Years (2 Life Cycles)	5%	\$80,981	11	Trenton (South)	\$64,139	11	Toronto (South)	\$80,545
12	Guelph (South)	60 Years (2 Life Cycles)	5%	\$81,007	12	Guelph (South)	\$64,216	12	Hamilton (South)	\$81,417
13	Mt. Forest (South)	60 Years (2 Life Cycles)	5%	\$82,013	13	Kitchener-Waterloo (South)	\$64,551	13	Sault Ste. Marie (North)	\$81,631
14	Sault Ste. Marie (North)	60 Years (2 Life Cycles)	5%	\$83,602	14	Mt. Forest (South)	\$65,209	14	Ottawa (Distinct)	\$81,922
15	Kitchener-Waterloo (South)	60 Years (2 Life Cycles)	5%	\$92,811	15	Kingston (South)	\$65,222	15	North Bay (North)	\$82,176
16	Barrie (Distinct)	60 Years (2 Life Cycles)	5%	\$93,197	16	Warton (South)	\$65,451	16	Muskoka (Distinct)	\$82,837
17	Kingston (South)	60 Years (2 Life Cycles)	5%	\$93,388	17	Sault Ste. Marie (North)	\$66,847	17	Mt. Forest (South)	\$82,855
18	Ottawa (Distinct)	60 Years (2 Life Cycles)	5%	\$93,633	18	Barrie (Distinct)	\$72,243	18	Kitchener-Waterloo (South)	\$82,867
19	Warton (South)	60 Years (2 Life Cycles)	5%	\$93,671	19	Ottawa (Distinct)	\$72,768	19	Peterborough (Distinct)	\$82,988
20	Peterborough (Distinct)	60 Years (2 Life Cycles)	5%	\$94,345	20	Peterborough (Distinct)	\$73,471	20	Warton (South)	\$84,345
21	Muskoka (Distinct)	60 Years (2 Life Cycles)	5%	\$94,651	21	Muskoka (Distinct)	\$73,703	21	Trenton (South)	\$86,144
22	North Bay (North)	60 Years (2 Life Cycles)	5%	\$94,945	22	North Bay (North)	\$74,135	22	Kingston (South)	\$86,900
23	Sudbury (North)	60 Years (2 Life Cycles)	5%	\$96,547	23	Sudbury (North)	\$75,753	23	Thunder Bay (North)	\$87,296
24	Timmins (North)	60 Years (2 Life Cycles)	5%	\$99,258	24	Timmins (North)	\$78,455	24	Sudbury (North)	\$88,408
25	Thunder Bay (North)	60 Years (2 Life Cycles)	5%	\$99,542	25	Thunder Bay (North)	\$78,687	25	Timmins (North)	\$90,072
26	Kenora (North)	60 Years (2 Life Cycles)	5%	\$100,712	26	Kenora (North)	\$79,790	26	Kenora (North)	\$91,865
27	Kapuskasing (North)	60 Years (2 Life Cycles)	5%	\$102,346	27	Kapuskasing (North)	\$81,447	27	Kapuskasing (North)	\$97,635

Table F1-1.1: Rankings of cities for base case scenario (average construction type) at a discount rate of 5% (two life cycles of V.GSHP and H.GSHP and five life cycles of Traditional HVAC Applications for a 60 year project lifespan)

Carbon Taxes – (#1)

Total Present Value										
Carbon Taxes - (#1)										
#	City	Project Life Span	Discount Rate	V.GSHP	#	City	H.GSHP	#	City	Traditional
1	St. Catharines (South)	60 Years (2 Life Cycles)	5%	\$77,319	1	St. Catharines (South)	\$60,493	1	Cambridge (South)	\$95,355
2	Sarnia (South)	60 Years (2 Life Cycles)	5%	\$78,067	2	Sarnia (South)	\$61,218	2	Chatham (South)	\$95,858
3	Chatham (South)	60 Years (2 Life Cycles)	5%	\$78,254	3	Chatham (South)	\$61,427	3	Windsor (South)	\$95,982
4	Windsor (South)	60 Years (2 Life Cycles)	5%	\$78,289	4	Windsor (South)	\$61,473	4	Guelph (South)	\$97,111
5	Niagara Falls (South)	60 Years (2 Life Cycles)	5%	\$78,605	5	Niagara Falls (South)	\$61,776	5	Niagara Falls (South)	\$97,576
6	Simcoe (South)	60 Years (2 Life Cycles)	5%	\$79,417	6	Simcoe (South)	\$62,607	6	St. Catharines (South)	\$98,790
7	Hamilton (South)	60 Years (2 Life Cycles)	5%	\$79,978	7	Hamilton (South)	\$63,165	7	Sarnia (South)	\$100,116
8	Cambridge (South)	60 Years (2 Life Cycles)	5%	\$80,494	8	London (South)	\$63,671	8	London (South)	\$100,697
9	London (South)	60 Years (2 Life Cycles)	5%	\$80,504	9	Cambridge (South)	\$63,687	9	Simcoe (South)	\$101,145
10	Toronto (South)	60 Years (2 Life Cycles)	5%	\$80,526	10	Toronto (South)	\$63,736	10	Barrie (Distinct)	\$102,404
11	Trenton (South)	60 Years (2 Life Cycles)	5%	\$80,981	11	Trenton (South)	\$64,139	11	Toronto (South)	\$102,539
12	Guelph (South)	60 Years (2 Life Cycles)	5%	\$81,007	12	Guelph (South)	\$64,216	12	Hamilton (South)	\$102,765
13	Mt. Forest (South)	60 Years (2 Life Cycles)	5%	\$82,013	13	Kitchener-Waterloo (South)	\$64,551	13	Ottawa (Distinct)	\$105,043
14	Sault Ste. Marie (North)	60 Years (2 Life Cycles)	5%	\$83,602	14	Mt. Forest (South)	\$65,209	14	Kitchener-Waterloo (South)	\$105,560
15	Kitchener-Waterloo (South)	60 Years (2 Life Cycles)	5%	\$92,811	15	Kingston (South)	\$65,222	15	Sault Ste. Marie (North)	\$106,544
16	Barrie (Distinct)	60 Years (2 Life Cycles)	5%	\$93,197	16	Warton (South)	\$65,451	16	North Bay (North)	\$106,594
17	Kingston (South)	60 Years (2 Life Cycles)	5%	\$93,388	17	Sault Ste. Marie (North)	\$66,847	17	Peterborough (Distinct)	\$106,767
18	Ottawa (Distinct)	60 Years (2 Life Cycles)	5%	\$93,633	18	Barrie (Distinct)	\$72,243	18	Muskoka (Distinct)	\$107,075
19	Warton (South)	60 Years (2 Life Cycles)	5%	\$93,671	19	Ottawa (Distinct)	\$72,768	19	Mt. Forest (South)	\$107,110
20	Peterborough (Distinct)	60 Years (2 Life Cycles)	5%	\$94,345	20	Peterborough (Distinct)	\$73,471	20	Warton (South)	\$107,913
21	Muskoka (Distinct)	60 Years (2 Life Cycles)	5%	\$94,651	21	Muskoka (Distinct)	\$73,703	21	Trenton (South)	\$108,288
22	North Bay (North)	60 Years (2 Life Cycles)	5%	\$94,945	22	North Bay (North)	\$74,135	22	Kingston (South)	\$109,702
23	Sudbury (North)	60 Years (2 Life Cycles)	5%	\$96,547	23	Sudbury (North)	\$75,753	23	Sudbury (North)	\$114,714
24	Timmins (North)	60 Years (2 Life Cycles)	5%	\$99,258	24	Timmins (North)	\$78,455	24	Thunder Bay (North)	\$115,117
25	Thunder Bay (North)	60 Years (2 Life Cycles)	5%	\$99,542	25	Thunder Bay (North)	\$78,687	25	Timmins (North)	\$119,244
26	Kenora (North)	60 Years (2 Life Cycles)	5%	\$100,712	26	Kenora (North)	\$79,790	26	Kenora (North)	\$120,089
27	Kapuskasing (North)	60 Years (2 Life Cycles)	5%	\$102,346	27	Kapuskasing (North)	\$81,447	27	Kapuskasing (North)	\$127,857

Table F1-1.2: Rankings of cities for carbon taxes scenario (average construction type) at a discount rate of 5% (two life cycles of V.GSHP and H.GSHP and five life cycles of Traditional HVAC Applications for a 60 year project lifespan)

FIT – (#2)

Total Present Value										
FIT - (#2)										
#	City	Project Life Span	Discount Rate	V.GSHP	#	City	H.GSHP	#	City	Traditional
1	St. Catharines (South)	60 Years (2 Life Cycles)	5%	\$68,791	1	St. Catharines (South)	\$51,905	1	Cambridge (South)	\$73,410
2	Sarnia (South)	60 Years (2 Life Cycles)	5%	\$69,319	2	Sarnia (South)	\$52,418	2	Guelph (South)	\$74,460
3	Chatham (South)	60 Years (2 Life Cycles)	5%	\$69,452	3	Chatham (South)	\$52,566	3	Chatham (South)	\$76,326
4	Windsor (South)	60 Years (2 Life Cycles)	5%	\$69,477	4	Windsor (South)	\$52,598	4	Windsor (South)	\$76,395
5	Niagara Falls (South)	60 Years (2 Life Cycles)	5%	\$69,700	5	Niagara Falls (South)	\$52,812	5	Niagara Falls (South)	\$77,796
6	Simcoe (South)	60 Years (2 Life Cycles)	5%	\$70,274	6	Simcoe (South)	\$53,399	6	London (South)	\$78,824
7	Hamilton (South)	60 Years (2 Life Cycles)	5%	\$70,670	7	Hamilton (South)	\$53,793	7	St. Catharines (South)	\$79,535
8	Cambridge (South)	60 Years (2 Life Cycles)	5%	\$71,034	8	London (South)	\$54,151	8	Barrie (Distinct)	\$79,861
9	London (South)	60 Years (2 Life Cycles)	5%	\$71,041	9	Cambridge (South)	\$54,162	9	Sarnia (South)	\$80,041
10	Toronto (South)	60 Years (2 Life Cycles)	5%	\$71,057	10	Toronto (South)	\$54,196	10	Simcoe (South)	\$80,339
11	Trenton (South)	60 Years (2 Life Cycles)	5%	\$71,378	11	Trenton (South)	\$54,481	11	Toronto (South)	\$80,545
12	Guelph (South)	60 Years (2 Life Cycles)	5%	\$71,396	12	Guelph (South)	\$54,536	12	Hamilton (South)	\$81,417
13	Mt. Forest (South)	60 Years (2 Life Cycles)	5%	\$72,107	13	Kitchener-Waterloo (South)	\$54,772	13	Sault Ste. Marie (North)	\$81,631
14	Sault Ste. Marie (North)	60 Years (2 Life Cycles)	5%	\$73,230	14	Mt. Forest (South)	\$55,237	14	Ottawa (Distinct)	\$81,922
15	Kitchener-Waterloo (South)	60 Years (2 Life Cycles)	5%	\$83,278	15	Kingston (South)	\$55,246	15	North Bay (North)	\$82,176
16	Barrie (Distinct)	60 Years (2 Life Cycles)	5%	\$83,551	16	Warton (South)	\$55,408	16	Muskoka (Distinct)	\$82,837
17	Kingston (South)	60 Years (2 Life Cycles)	5%	\$83,685	17	Sault Ste. Marie (North)	\$56,394	17	Mt. Forest (South)	\$82,855
18	Ottawa (Distinct)	60 Years (2 Life Cycles)	5%	\$83,858	18	Barrie (Distinct)	\$62,499	18	Kitchener-Waterloo (South)	\$82,867
19	Warton (South)	60 Years (2 Life Cycles)	5%	\$83,886	19	Ottawa (Distinct)	\$62,870	19	Peterborough (Distinct)	\$82,988
20	Peterborough (Distinct)	60 Years (2 Life Cycles)	5%	\$84,362	20	Peterborough (Distinct)	\$63,367	20	Warton (South)	\$84,345
21	Muskoka (Distinct)	60 Years (2 Life Cycles)	5%	\$84,578	21	Muskoka (Distinct)	\$63,531	21	Trenton (South)	\$86,144
22	North Bay (North)	60 Years (2 Life Cycles)	5%	\$84,785	22	North Bay (North)	\$63,836	22	Kingston (South)	\$86,900
23	Sudbury (North)	60 Years (2 Life Cycles)	5%	\$85,917	23	Sudbury (North)	\$64,979	23	Thunder Bay (North)	\$87,296
24	Timmins (North)	60 Years (2 Life Cycles)	5%	\$87,832	24	Timmins (North)	\$66,887	24	Sudbury (North)	\$88,408
25	Thunder Bay (North)	60 Years (2 Life Cycles)	5%	\$88,033	25	Thunder Bay (North)	\$67,051	25	Timmins (North)	\$90,072
26	Kenora (North)	60 Years (2 Life Cycles)	5%	\$88,859	26	Kenora (North)	\$67,830	26	Kenora (North)	\$91,865
27	Kapuskasing (North)	60 Years (2 Life Cycles)	5%	\$90,014	27	Kapuskasing (North)	\$69,001	27	Kapuskasing (North)	\$97,635

Table F1-1.3: Rankings of cities for feed-in tariff scenario (average construction type) at a discount rate of 5% (two life cycles of V.GSHP and H.GSHP and five life cycles of Traditional HVAC Applications for a 60 year project lifespan)

Rebates – (#3)

Total Present Value										
Rebates - (#3)										
#	City	Project Life Span	Discount Rate	V.GSHP	#	City	H.GSHP	#	City	Traditional
1	St. Catharines (South)	60 Years (2 Life Cycles)	5%	\$70,223	1	St. Catharines (South)	\$53,397	1	Cambridge (South)	\$73,410
2	Sarnia (South)	60 Years (2 Life Cycles)	5%	\$70,971	2	Sarnia (South)	\$54,122	2	Guelph (South)	\$74,460
3	Chatham (South)	60 Years (2 Life Cycles)	5%	\$71,158	3	Chatham (South)	\$54,332	3	Chatham (South)	\$76,326
4	Windsor (South)	60 Years (2 Life Cycles)	5%	\$71,194	4	Windsor (South)	\$54,377	4	Windsor (South)	\$76,395
5	Niagara Falls (South)	60 Years (2 Life Cycles)	5%	\$71,509	5	Niagara Falls (South)	\$54,680	5	Niagara Falls (South)	\$77,796
6	Simcoe (South)	60 Years (2 Life Cycles)	5%	\$72,322	6	Simcoe (South)	\$55,512	6	London (South)	\$78,824
7	Hamilton (South)	60 Years (2 Life Cycles)	5%	\$72,883	7	Hamilton (South)	\$56,069	7	St. Catharines (South)	\$79,535
8	Cambridge (South)	60 Years (2 Life Cycles)	5%	\$73,399	8	London (South)	\$56,576	8	Barrie (Distinct)	\$79,861
9	London (South)	60 Years (2 Life Cycles)	5%	\$73,408	9	Cambridge (South)	\$56,592	9	Sarnia (South)	\$80,041
10	Toronto (South)	60 Years (2 Life Cycles)	5%	\$73,431	10	Toronto (South)	\$56,640	10	Simcoe (South)	\$80,339
11	Trenton (South)	60 Years (2 Life Cycles)	5%	\$73,885	11	Trenton (South)	\$57,043	11	Toronto (South)	\$80,545
12	Guelph (South)	60 Years (2 Life Cycles)	5%	\$73,911	12	Guelph (South)	\$57,120	12	Hamilton (South)	\$81,417
13	Mt. Forest (South)	60 Years (2 Life Cycles)	5%	\$74,917	13	Kitchener-Waterloo (South)	\$57,456	13	Sault Ste. Marie (North)	\$81,631
14	Sault Ste. Marie (North)	60 Years (2 Life Cycles)	5%	\$76,506	14	Mt. Forest (South)	\$58,113	14	Ottawa (Distinct)	\$81,922
15	Kitchener-Waterloo (South)	60 Years (2 Life Cycles)	5%	\$85,715	15	Kingston (South)	\$58,126	15	North Bay (North)	\$82,176
16	Barrie (Distinct)	60 Years (2 Life Cycles)	5%	\$86,102	16	Warton (South)	\$58,355	16	Muskoka (Distinct)	\$82,837
17	Kingston (South)	60 Years (2 Life Cycles)	5%	\$86,292	17	Sault Ste. Marie (North)	\$59,751	17	Mt. Forest (South)	\$82,855
18	Ottawa (Distinct)	60 Years (2 Life Cycles)	5%	\$86,537	18	Barrie (Distinct)	\$65,147	18	Kitchener-Waterloo (South)	\$82,867
19	Warton (South)	60 Years (2 Life Cycles)	5%	\$86,576	19	Ottawa (Distinct)	\$65,673	19	Peterborough (Distinct)	\$82,988
20	Peterborough (Distinct)	60 Years (2 Life Cycles)	5%	\$87,250	20	Peterborough (Distinct)	\$66,376	20	Warton (South)	\$84,345
21	Muskoka (Distinct)	60 Years (2 Life Cycles)	5%	\$87,556	21	Muskoka (Distinct)	\$66,608	21	Trenton (South)	\$86,144
22	North Bay (North)	60 Years (2 Life Cycles)	5%	\$87,849	22	North Bay (North)	\$67,040	22	Kingston (South)	\$86,900
23	Sudbury (North)	60 Years (2 Life Cycles)	5%	\$89,451	23	Sudbury (North)	\$68,658	23	Thunder Bay (North)	\$87,296
24	Timmins (North)	60 Years (2 Life Cycles)	5%	\$92,163	24	Timmins (North)	\$71,359	24	Sudbury (North)	\$88,408
25	Thunder Bay (North)	60 Years (2 Life Cycles)	5%	\$92,446	25	Thunder Bay (North)	\$71,592	25	Timmins (North)	\$90,072
26	Kenora (North)	60 Years (2 Life Cycles)	5%	\$93,616	26	Kenora (North)	\$72,694	26	Kenora (North)	\$91,865
27	Kapuskasing (North)	60 Years (2 Life Cycles)	5%	\$95,251	27	Kapuskasing (North)	\$74,351	27	Kapuskasing (North)	\$97,635

Table F1-1.4: Rankings of cities for rebates scenario (average construction type) at a discount rate of 5% (two life cycles of V.GSHP and H.GSHP and five life cycles of Traditional HVAC Applications for a 60 year project lifespan)

FIT + Rebates – (#4)

Total Present Value										
(FIT+Rebates) - (#4)										
#	City	Project Life Span	Discount Rate	V.GSHP	#	City	H.GSHP	#	City	Traditional
1	St. Catharines (South)	60 Years (2 Life Cycles)	5%	\$61,696	1	St. Catharines (South)	\$44,810	1	Cambridge (South)	\$73,410
2	Sarnia (South)	60 Years (2 Life Cycles)	5%	\$62,224	2	Sarnia (South)	\$45,322	2	Guelph (South)	\$74,460
3	Chatham (South)	60 Years (2 Life Cycles)	5%	\$62,356	3	Chatham (South)	\$45,470	3	Chatham (South)	\$76,326
4	Windsor (South)	60 Years (2 Life Cycles)	5%	\$62,381	4	Windsor (South)	\$45,502	4	Windsor (South)	\$76,395
5	Niagara Falls (South)	60 Years (2 Life Cycles)	5%	\$62,604	5	Niagara Falls (South)	\$45,716	5	Niagara Falls (South)	\$77,796
6	Simcoe (South)	60 Years (2 Life Cycles)	5%	\$63,178	6	Simcoe (South)	\$46,304	6	London (South)	\$78,824
7	Hamilton (South)	60 Years (2 Life Cycles)	5%	\$63,574	7	Hamilton (South)	\$46,698	7	St. Catharines (South)	\$79,535
8	Cambridge (South)	60 Years (2 Life Cycles)	5%	\$63,939	8	London (South)	\$47,055	8	Barrie (Distinct)	\$79,861
9	London (South)	60 Years (2 Life Cycles)	5%	\$63,946	9	Cambridge (South)	\$47,067	9	Sarnia (South)	\$80,041
10	Toronto (South)	60 Years (2 Life Cycles)	5%	\$63,961	10	Toronto (South)	\$47,101	10	Simcoe (South)	\$80,339
11	Trenton (South)	60 Years (2 Life Cycles)	5%	\$64,283	11	Trenton (South)	\$47,385	11	Toronto (South)	\$80,545
12	Guelph (South)	60 Years (2 Life Cycles)	5%	\$64,301	12	Guelph (South)	\$47,440	12	Hamilton (South)	\$81,417
13	Mt. Forest (South)	60 Years (2 Life Cycles)	5%	\$65,011	13	Kitchener-Waterloo (South)	\$47,677	13	Sault Ste. Marie (North)	\$81,631
14	Sault Ste. Marie (North)	60 Years (2 Life Cycles)	5%	\$66,134	14	Mt. Forest (South)	\$48,141	14	Ottawa (Distinct)	\$81,922
15	Kitchener-Waterloo (South)	60 Years (2 Life Cycles)	5%	\$76,182	15	Kingston (South)	\$48,150	15	North Bay (North)	\$82,176
16	Barrie (Distinct)	60 Years (2 Life Cycles)	5%	\$76,456	16	Warton (South)	\$48,312	16	Muskoka (Distinct)	\$82,837
17	Kingston (South)	60 Years (2 Life Cycles)	5%	\$76,590	17	Sault Ste. Marie (North)	\$49,298	17	Mt. Forest (South)	\$82,855
18	Ottawa (Distinct)	60 Years (2 Life Cycles)	5%	\$76,763	18	Barrie (Distinct)	\$55,403	18	Kitchener-Waterloo (South)	\$82,867
19	Warton (South)	60 Years (2 Life Cycles)	5%	\$76,790	19	Ottawa (Distinct)	\$55,775	19	Peterborough (Distinct)	\$82,988
20	Peterborough (Distinct)	60 Years (2 Life Cycles)	5%	\$77,266	20	Peterborough (Distinct)	\$56,271	20	Warton (South)	\$84,345
21	Muskoka (Distinct)	60 Years (2 Life Cycles)	5%	\$77,483	21	Muskoka (Distinct)	\$56,435	21	Trenton (South)	\$86,144
22	North Bay (North)	60 Years (2 Life Cycles)	5%	\$77,690	22	North Bay (North)	\$56,740	22	Kingston (South)	\$86,900
23	Sudbury (North)	60 Years (2 Life Cycles)	5%	\$78,822	23	Sudbury (North)	\$57,883	23	Thunder Bay (North)	\$87,296
24	Timmins (North)	60 Years (2 Life Cycles)	5%	\$80,737	24	Timmins (North)	\$59,792	24	Sudbury (North)	\$88,408
25	Thunder Bay (North)	60 Years (2 Life Cycles)	5%	\$80,937	25	Thunder Bay (North)	\$59,956	25	Timmins (North)	\$90,072
26	Kenora (North)	60 Years (2 Life Cycles)	5%	\$81,764	26	Kenora (North)	\$60,735	26	Kenora (North)	\$91,865
27	Kapuskasing (North)	60 Years (2 Life Cycles)	5%	\$82,918	27	Kapuskasing (North)	\$61,905	27	Kapuskasing (North)	\$97,635

Table F1-1.5: Rankings of cities for feed-in tariff + rebates scenario (average construction type) at a discount rate of 5% (two life cycles of V.GSHP and H.GSHP and five life cycles of Traditional HVAC Applications for a 60 year project lifespan)

(FIT + Rebates) + Carbon Taxes – (#5)

Total Present Value										
(FIT+Rebates) + Carbon Taxes - (#5)										
#	City	Project Life Span	Discount Rate	V.GSHP	#	City	H.GSHP	#	City	Traditional
1	St. Catharines (South)	60 Years (2 Life Cycles)	5%	\$61,696	1	St. Catharines (South)	\$44,810	1	Cambridge (South)	\$95,355
2	Sarnia (South)	60 Years (2 Life Cycles)	5%	\$62,224	2	Sarnia (South)	\$45,322	2	Chatham (South)	\$95,858
3	Chatham (South)	60 Years (2 Life Cycles)	5%	\$62,356	3	Chatham (South)	\$45,470	3	Windsor (South)	\$95,982
4	Windsor (South)	60 Years (2 Life Cycles)	5%	\$62,381	4	Windsor (South)	\$45,502	4	Guelph (South)	\$97,111
5	Niagara Falls (South)	60 Years (2 Life Cycles)	5%	\$62,604	5	Niagara Falls (South)	\$45,716	5	Niagara Falls (South)	\$97,576
6	Simcoe (South)	60 Years (2 Life Cycles)	5%	\$63,178	6	Simcoe (South)	\$46,304	6	St. Catharines (South)	\$98,790
7	Hamilton (South)	60 Years (2 Life Cycles)	5%	\$63,574	7	Hamilton (South)	\$46,698	7	Sarnia (South)	\$100,116
8	Cambridge (South)	60 Years (2 Life Cycles)	5%	\$63,939	8	London (South)	\$47,055	8	London (South)	\$100,697
9	London (South)	60 Years (2 Life Cycles)	5%	\$63,946	9	Cambridge (South)	\$47,067	9	Simcoe (South)	\$101,145
10	Toronto (South)	60 Years (2 Life Cycles)	5%	\$63,961	10	Toronto (South)	\$47,101	10	Barrie (Distinct)	\$102,404
11	Trenton (South)	60 Years (2 Life Cycles)	5%	\$64,283	11	Trenton (South)	\$47,385	11	Toronto (South)	\$102,539
12	Guelph (South)	60 Years (2 Life Cycles)	5%	\$64,301	12	Guelph (South)	\$47,440	12	Hamilton (South)	\$102,765
13	Mt. Forest (South)	60 Years (2 Life Cycles)	5%	\$65,011	13	Kitchener-Waterloo (South)	\$47,677	13	Ottawa (Distinct)	\$105,043
14	Sault Ste. Marie (North)	60 Years (2 Life Cycles)	5%	\$66,134	14	Mt. Forest (South)	\$48,141	14	Kitchener-Waterloo (South)	\$105,560
15	Kitchener-Waterloo (South)	60 Years (2 Life Cycles)	5%	\$76,182	15	Kingston (South)	\$48,150	15	Sault Ste. Marie (North)	\$106,544
16	Barrie (Distinct)	60 Years (2 Life Cycles)	5%	\$76,456	16	Warton (South)	\$48,312	16	North Bay (North)	\$106,594
17	Kingston (South)	60 Years (2 Life Cycles)	5%	\$76,590	17	Sault Ste. Marie (North)	\$49,298	17	Peterborough (Distinct)	\$106,767
18	Ottawa (Distinct)	60 Years (2 Life Cycles)	5%	\$76,763	18	Barrie (Distinct)	\$55,403	18	Muskoka (Distinct)	\$107,075
19	Warton (South)	60 Years (2 Life Cycles)	5%	\$76,790	19	Ottawa (Distinct)	\$55,775	19	Mt. Forest (South)	\$107,110
20	Peterborough (Distinct)	60 Years (2 Life Cycles)	5%	\$77,266	20	Peterborough (Distinct)	\$56,271	20	Warton (South)	\$107,913
21	Muskoka (Distinct)	60 Years (2 Life Cycles)	5%	\$77,483	21	Muskoka (Distinct)	\$56,435	21	Trenton (South)	\$108,288
22	North Bay (North)	60 Years (2 Life Cycles)	5%	\$77,690	22	North Bay (North)	\$56,740	22	Kingston (South)	\$109,702
23	Sudbury (North)	60 Years (2 Life Cycles)	5%	\$78,822	23	Sudbury (North)	\$57,883	23	Sudbury (North)	\$114,714
24	Timmins (North)	60 Years (2 Life Cycles)	5%	\$80,737	24	Timmins (North)	\$59,792	24	Thunder Bay (North)	\$115,117
25	Thunder Bay (North)	60 Years (2 Life Cycles)	5%	\$80,937	25	Thunder Bay (North)	\$59,956	25	Timmins (North)	\$119,244
26	Kenora (North)	60 Years (2 Life Cycles)	5%	\$81,764	26	Kenora (North)	\$60,735	26	Kenora (North)	\$120,089
27	Kapuskasing (North)	60 Years (2 Life Cycles)	5%	\$82,918	27	Kapuskasing (North)	\$61,905	27	Kapuskasing (North)	\$127,857

Table F1-1.6: Rankings of cities for feed-in tariff + rebates + carbon tax scenario (average construction type) at a discount rate of 5% (two life cycles of V.GSHP and H.GSHP and five life cycles of Traditional HVAC Applications for a 60 year project lifespan)

2. Two Life Cycles of V.GSHP and H.GSHP and Five Life Cycles of Traditional HVAC Applications @ 7% Discount Rate

Base Case Scenario

Total Present Value										
Base Case Scenario										
#	City	Project Life Span	Discount Rate	V.GSHP	#	City	H.GSHP	#	City	Traditional
1	St. Catharines (South)	60 Years (2 Life Cycles)	7%	\$62,797	1	St. Catharines (South)	\$48,090	1	Cambridge (South)	\$53,985
2	Sarnia (South)	60 Years (2 Life Cycles)	7%	\$63,343	2	Sarnia (South)	\$48,620	2	Guelph (South)	\$54,741
3	Chatham (South)	60 Years (2 Life Cycles)	7%	\$63,480	3	Chatham (South)	\$48,772	3	Chatham (South)	\$56,197
4	Windsor (South)	60 Years (2 Life Cycles)	7%	\$63,506	4	Windsor (South)	\$48,805	4	Windsor (South)	\$56,246
5	Niagara Falls (South)	60 Years (2 Life Cycles)	7%	\$63,736	5	Niagara Falls (South)	\$49,027	5	Niagara Falls (South)	\$57,267
6	Simcoe (South)	60 Years (2 Life Cycles)	7%	\$64,329	6	Simcoe (South)	\$49,634	6	London (South)	\$57,988
7	Hamilton (South)	60 Years (2 Life Cycles)	7%	\$64,738	7	Hamilton (South)	\$50,041	7	St. Catharines (South)	\$58,593
8	Cambridge (South)	60 Years (2 Life Cycles)	7%	\$65,115	8	London (South)	\$50,410	8	Barrie (Distinct)	\$58,786
9	London (South)	60 Years (2 Life Cycles)	7%	\$65,122	9	Cambridge (South)	\$50,422	9	Sarnia (South)	\$58,951
10	Toronto (South)	60 Years (2 Life Cycles)	7%	\$65,138	10	Toronto (South)	\$50,457	10	Simcoe (South)	\$59,159
11	Trenton (South)	60 Years (2 Life Cycles)	7%	\$65,470	11	Trenton (South)	\$50,751	11	Toronto (South)	\$59,293
12	Guelph (South)	60 Years (2 Life Cycles)	7%	\$65,489	12	Guelph (South)	\$50,807	12	Hamilton (South)	\$59,938
13	Mt. Forest (South)	60 Years (2 Life Cycles)	7%	\$66,223	13	Kitchener-Waterloo (South)	\$51,052	13	Sault Ste. Marie (North)	\$59,995
14	Sault Ste. Marie (North)	60 Years (2 Life Cycles)	7%	\$67,383	14	Mt. Forest (South)	\$51,532	14	Ottawa (Distinct)	\$60,282
15	Kitchener-Waterloo (South)	60 Years (2 Life Cycles)	7%	\$75,696	15	Kingston (South)	\$51,541	15	North Bay (North)	\$60,449
16	Barrie (Distinct)	60 Years (2 Life Cycles)	7%	\$75,978	16	Warton (South)	\$51,709	16	Muskoka (Distinct)	\$60,935
17	Kingston (South)	60 Years (2 Life Cycles)	7%	\$76,117	17	Sault Ste. Marie (North)	\$52,727	17	Mt. Forest (South)	\$60,947
18	Ottawa (Distinct)	60 Years (2 Life Cycles)	7%	\$76,296	18	Barrie (Distinct)	\$57,651	18	Kitchener-Waterloo (South)	\$60,977
19	Warton (South)	60 Years (2 Life Cycles)	7%	\$76,324	19	Ottawa (Distinct)	\$58,035	19	Peterborough (Distinct)	\$61,051
20	Peterborough (Distinct)	60 Years (2 Life Cycles)	7%	\$76,816	20	Peterborough (Distinct)	\$58,548	20	Warton (South)	\$62,095
21	Muskoka (Distinct)	60 Years (2 Life Cycles)	7%	\$77,039	21	Muskoka (Distinct)	\$58,717	21	Trenton (South)	\$63,478
22	North Bay (North)	60 Years (2 Life Cycles)	7%	\$77,253	22	North Bay (North)	\$59,032	22	Kingston (South)	\$64,021
23	Sudbury (North)	60 Years (2 Life Cycles)	7%	\$78,423	23	Sudbury (North)	\$60,213	23	Thunder Bay (North)	\$64,140
24	Timmins (North)	60 Years (2 Life Cycles)	7%	\$80,401	24	Timmins (North)	\$62,185	24	Sudbury (North)	\$65,022
25	Thunder Bay (North)	60 Years (2 Life Cycles)	7%	\$80,608	25	Thunder Bay (North)	\$62,354	25	Timmins (North)	\$66,147
26	Kenora (North)	60 Years (2 Life Cycles)	7%	\$81,462	26	Kenora (North)	\$63,159	26	Kenora (North)	\$67,519
27	Kapuskasing (North)	60 Years (2 Life Cycles)	7%	\$82,655	27	Kapuskasing (North)	\$64,368	27	Kapuskasing (North)	\$71,753

Table F1-1.7: Rankings of cities for base case scenario (average construction type) at a discount rate of 7% (two life cycles of V.GSHP and H.GSHP and five life cycles of Traditional HVAC Applications for a 60 year project lifespan)

Carbon Taxes – (#1)

Total Present Value										
Carbon Taxes - (#1)										
#	City	Project Life Span	Discount Rate	V.GSHP	#	City	H.GSHP	#	City	Traditional
1	St. Catharines (South)	60 Years (2 Life Cycles)	7%	\$62,797	1	St. Catharines (South)	\$48,090	1	Cambridge (South)	\$67,142
2	Sarnia (South)	60 Years (2 Life Cycles)	7%	\$63,343	2	Sarnia (South)	\$48,620	2	Chatham (South)	\$67,907
3	Chatham (South)	60 Years (2 Life Cycles)	7%	\$63,480	3	Chatham (South)	\$48,772	3	Windsor (South)	\$67,989
4	Windsor (South)	60 Years (2 Life Cycles)	7%	\$63,506	4	Windsor (South)	\$48,805	4	Guelph (South)	\$68,321
5	Niagara Falls (South)	60 Years (2 Life Cycles)	7%	\$63,736	5	Niagara Falls (South)	\$49,027	5	Niagara Falls (South)	\$69,125
6	Simcoe (South)	60 Years (2 Life Cycles)	7%	\$64,329	6	Simcoe (South)	\$49,634	6	St. Catharines (South)	\$70,137
7	Hamilton (South)	60 Years (2 Life Cycles)	7%	\$64,738	7	Hamilton (South)	\$50,041	7	Sarnia (South)	\$70,987
8	Cambridge (South)	60 Years (2 Life Cycles)	7%	\$65,115	8	London (South)	\$50,410	8	London (South)	\$71,101
9	London (South)	60 Years (2 Life Cycles)	7%	\$65,122	9	Cambridge (South)	\$50,422	9	Simcoe (South)	\$71,632
10	Toronto (South)	60 Years (2 Life Cycles)	7%	\$65,138	10	Toronto (South)	\$50,457	10	Barrie (Distinct)	\$72,301
11	Trenton (South)	60 Years (2 Life Cycles)	7%	\$65,470	11	Trenton (South)	\$50,751	11	Toronto (South)	\$72,479
12	Guelph (South)	60 Years (2 Life Cycles)	7%	\$65,489	12	Guelph (South)	\$50,807	12	Hamilton (South)	\$72,737
13	Mt. Forest (South)	60 Years (2 Life Cycles)	7%	\$66,223	13	Kitchener-Waterloo (South)	\$51,052	13	Ottawa (Distinct)	\$74,144
14	Sault Ste. Marie (North)	60 Years (2 Life Cycles)	7%	\$67,383	14	Mt. Forest (South)	\$51,532	14	Kitchener-Waterloo (South)	\$74,583
15	Kitchener-Waterloo (South)	60 Years (2 Life Cycles)	7%	\$75,696	15	Kingston (South)	\$51,541	15	Sault Ste. Marie (North)	\$74,931
16	Barrie (Distinct)	60 Years (2 Life Cycles)	7%	\$75,978	16	Warton (South)	\$51,709	16	North Bay (North)	\$75,089
17	Kingston (South)	60 Years (2 Life Cycles)	7%	\$76,117	17	Sault Ste. Marie (North)	\$52,727	17	Peterborough (Distinct)	\$75,307
18	Ottawa (Distinct)	60 Years (2 Life Cycles)	7%	\$76,296	18	Barrie (Distinct)	\$57,651	18	Muskoka (Distinct)	\$75,466
19	Warton (South)	60 Years (2 Life Cycles)	7%	\$76,324	19	Ottawa (Distinct)	\$58,035	19	Mt. Forest (South)	\$75,489
20	Peterborough (Distinct)	60 Years (2 Life Cycles)	7%	\$76,816	20	Peterborough (Distinct)	\$58,548	20	Warton (South)	\$76,225
21	Muskoka (Distinct)	60 Years (2 Life Cycles)	7%	\$77,039	21	Muskoka (Distinct)	\$58,717	21	Trenton (South)	\$76,754
22	North Bay (North)	60 Years (2 Life Cycles)	7%	\$77,253	22	North Bay (North)	\$59,032	22	Kingston (South)	\$77,691
23	Sudbury (North)	60 Years (2 Life Cycles)	7%	\$78,423	23	Sudbury (North)	\$60,213	23	Sudbury (North)	\$80,794
24	Timmins (North)	60 Years (2 Life Cycles)	7%	\$80,401	24	Timmins (North)	\$62,185	24	Thunder Bay (North)	\$80,819
25	Thunder Bay (North)	60 Years (2 Life Cycles)	7%	\$80,608	25	Thunder Bay (North)	\$62,354	25	Timmins (North)	\$83,637
26	Kenora (North)	60 Years (2 Life Cycles)	7%	\$81,462	26	Kenora (North)	\$63,159	26	Kenora (North)	\$84,441
27	Kapuskasing (North)	60 Years (2 Life Cycles)	7%	\$82,655	27	Kapuskasing (North)	\$64,368	27	Kapuskasing (North)	\$89,872

Table F1-1.8: Rankings of cities for carbon taxes scenario (average construction type) at a discount rate of 7% (two life cycles of V.GSHP and H.GSHP and five life cycles of Traditional HVAC Applications for a 60 year project lifespan)

FIT – (#2)

Total Present Value										
FIT - (#2)										
#	City	Project Life Span	Discount Rate	V.GSHP	#	City	H.GSHP	#	City	Traditional
1	St. Catharines (South)	60 Years (2 Life Cycles)	7%	\$56,473	1	St. Catharines (South)	\$41,721	1	Cambridge (South)	\$53,985
2	Sarnia (South)	60 Years (2 Life Cycles)	7%	\$56,856	2	Sarnia (South)	\$42,093	2	Guelph (South)	\$54,741
3	Chatham (South)	60 Years (2 Life Cycles)	7%	\$56,951	3	Chatham (South)	\$42,200	3	Chatham (South)	\$56,197
4	Windsor (South)	60 Years (2 Life Cycles)	7%	\$56,970	4	Windsor (South)	\$42,223	4	Windsor (South)	\$56,246
5	Niagara Falls (South)	60 Years (2 Life Cycles)	7%	\$57,131	5	Niagara Falls (South)	\$42,378	5	Niagara Falls (South)	\$57,267
6	Simcoe (South)	60 Years (2 Life Cycles)	7%	\$57,547	6	Simcoe (South)	\$42,804	6	London (South)	\$57,988
7	Hamilton (South)	60 Years (2 Life Cycles)	7%	\$57,835	7	Hamilton (South)	\$43,090	7	St. Catharines (South)	\$58,593
8	Cambridge (South)	60 Years (2 Life Cycles)	7%	\$58,099	8	London (South)	\$43,349	8	Barrie (Distinct)	\$58,786
9	London (South)	60 Years (2 Life Cycles)	7%	\$58,104	9	Cambridge (South)	\$43,357	9	Sarnia (South)	\$58,951
10	Toronto (South)	60 Years (2 Life Cycles)	7%	\$58,115	10	Toronto (South)	\$43,382	10	Simcoe (South)	\$59,159
11	Trenton (South)	60 Years (2 Life Cycles)	7%	\$58,348	11	Trenton (South)	\$43,588	11	Toronto (South)	\$59,293
12	Guelph (South)	60 Years (2 Life Cycles)	7%	\$58,361	12	Guelph (South)	\$43,628	12	Hamilton (South)	\$59,938
13	Mt. Forest (South)	60 Years (2 Life Cycles)	7%	\$58,876	13	Kitchener-Waterloo (South)	\$43,800	13	Sault Ste. Marie (North)	\$59,995
14	Sault Ste. Marie (North)	60 Years (2 Life Cycles)	7%	\$59,690	14	Mt. Forest (South)	\$44,136	14	Ottawa (Distinct)	\$60,282
15	Kitchener-Waterloo (South)	60 Years (2 Life Cycles)	7%	\$68,626	15	Kingston (South)	\$44,143	15	North Bay (North)	\$60,449
16	Barrie (Distinct)	60 Years (2 Life Cycles)	7%	\$68,824	16	Warton (South)	\$44,260	16	Muskoka (Distinct)	\$60,935
17	Kingston (South)	60 Years (2 Life Cycles)	7%	\$68,921	17	Sault Ste. Marie (North)	\$44,975	17	Mt. Forest (South)	\$60,947
18	Ottawa (Distinct)	60 Years (2 Life Cycles)	7%	\$69,047	18	Barrie (Distinct)	\$50,425	18	Kitchener-Waterloo (South)	\$60,977
19	Warton (South)	60 Years (2 Life Cycles)	7%	\$69,067	19	Ottawa (Distinct)	\$50,694	19	Peterborough (Distinct)	\$61,051
20	Peterborough (Distinct)	60 Years (2 Life Cycles)	7%	\$69,412	20	Peterborough (Distinct)	\$51,054	20	Warton (South)	\$62,095
21	Muskoka (Distinct)	60 Years (2 Life Cycles)	7%	\$69,568	21	Muskoka (Distinct)	\$51,172	21	Trenton (South)	\$63,478
22	North Bay (North)	60 Years (2 Life Cycles)	7%	\$69,719	22	North Bay (North)	\$51,394	22	Kingston (South)	\$64,021
23	Sudbury (North)	60 Years (2 Life Cycles)	7%	\$70,539	23	Sudbury (North)	\$52,222	23	Thunder Bay (North)	\$64,140
24	Timmins (North)	60 Years (2 Life Cycles)	7%	\$71,927	24	Timmins (North)	\$53,605	24	Sudbury (North)	\$65,022
25	Thunder Bay (North)	60 Years (2 Life Cycles)	7%	\$72,072	25	Thunder Bay (North)	\$53,724	25	Timmins (North)	\$66,147
26	Kenora (North)	60 Years (2 Life Cycles)	7%	\$72,672	26	Kenora (North)	\$54,289	26	Kenora (North)	\$67,519
27	Kapuskasing (North)	60 Years (2 Life Cycles)	7%	\$73,509	27	Kapuskasing (North)	\$55,137	27	Kapuskasing (North)	\$71,753

Table F1-1.9: Rankings of cities for feed-in tariff scenario (average construction type) at a discount rate of 7% (two life cycles of V.GSHP and H.GSHP and five life cycles of Traditional HVAC Applications for a 60 year project lifespan)

Rebates – (#3)

Total Present Value										
Rebates - (#3)										
#	City	Project Life Span	Discount Rate	V.GSHP	#	City	H.GSHP	#	City	Traditional
1	St. Catharines (South)	60 Years (2 Life Cycles)	7%	\$56,608	1	St. Catharines (South)	\$41,900	1	Cambridge (South)	\$53,985
2	Sarnia (South)	60 Years (2 Life Cycles)	7%	\$57,153	2	Sarnia (South)	\$42,430	2	Guelph (South)	\$54,741
3	Chatham (South)	60 Years (2 Life Cycles)	7%	\$57,290	3	Chatham (South)	\$42,583	3	Chatham (South)	\$56,197
4	Windsor (South)	60 Years (2 Life Cycles)	7%	\$57,316	4	Windsor (South)	\$42,616	4	Windsor (South)	\$56,246
5	Niagara Falls (South)	60 Years (2 Life Cycles)	7%	\$57,546	5	Niagara Falls (South)	\$42,837	5	Niagara Falls (South)	\$57,267
6	Simcoe (South)	60 Years (2 Life Cycles)	7%	\$58,139	6	Simcoe (South)	\$43,444	6	London (South)	\$57,988
7	Hamilton (South)	60 Years (2 Life Cycles)	7%	\$58,549	7	Hamilton (South)	\$43,851	7	St. Catharines (South)	\$58,593
8	Cambridge (South)	60 Years (2 Life Cycles)	7%	\$58,925	8	London (South)	\$44,220	8	Barrie (Distinct)	\$58,786
9	London (South)	60 Years (2 Life Cycles)	7%	\$58,932	9	Cambridge (South)	\$44,232	9	Sarnia (South)	\$58,951
10	Toronto (South)	60 Years (2 Life Cycles)	7%	\$58,949	10	Toronto (South)	\$44,267	10	Simcoe (South)	\$59,159
11	Trenton (South)	60 Years (2 Life Cycles)	7%	\$59,280	11	Trenton (South)	\$44,561	11	Toronto (South)	\$59,293
12	Guelph (South)	60 Years (2 Life Cycles)	7%	\$59,299	12	Guelph (South)	\$44,618	12	Hamilton (South)	\$59,938
13	Mt. Forest (South)	60 Years (2 Life Cycles)	7%	\$60,033	13	Kitchener-Waterloo (South)	\$44,862	13	Sault Ste. Marie (North)	\$59,995
14	Sault Ste. Marie (North)	60 Years (2 Life Cycles)	7%	\$61,193	14	Mt. Forest (South)	\$45,342	14	Ottawa (Distinct)	\$60,282
15	Kitchener-Waterloo (South)	60 Years (2 Life Cycles)	7%	\$69,506	15	Kingston (South)	\$45,352	15	North Bay (North)	\$60,449
16	Barrie (Distinct)	60 Years (2 Life Cycles)	7%	\$69,789	16	Warton (South)	\$45,519	16	Muskoka (Distinct)	\$60,935
17	Kingston (South)	60 Years (2 Life Cycles)	7%	\$69,927	17	Sault Ste. Marie (North)	\$46,537	17	Mt. Forest (South)	\$60,947
18	Ottawa (Distinct)	60 Years (2 Life Cycles)	7%	\$70,106	18	Barrie (Distinct)	\$51,462	18	Kitchener-Waterloo (South)	\$60,977
19	Warton (South)	60 Years (2 Life Cycles)	7%	\$70,134	19	Ottawa (Distinct)	\$51,845	19	Peterborough (Distinct)	\$61,051
20	Peterborough (Distinct)	60 Years (2 Life Cycles)	7%	\$70,626	20	Peterborough (Distinct)	\$52,358	20	Warton (South)	\$62,095
21	Muskoka (Distinct)	60 Years (2 Life Cycles)	7%	\$70,850	21	Muskoka (Distinct)	\$52,527	21	Trenton (South)	\$63,478
22	North Bay (North)	60 Years (2 Life Cycles)	7%	\$71,064	22	North Bay (North)	\$52,843	22	Kingston (South)	\$64,021
23	Sudbury (North)	60 Years (2 Life Cycles)	7%	\$72,233	23	Sudbury (North)	\$54,024	23	Thunder Bay (North)	\$64,140
24	Timmins (North)	60 Years (2 Life Cycles)	7%	\$74,211	24	Timmins (North)	\$55,995	24	Sudbury (North)	\$65,022
25	Thunder Bay (North)	60 Years (2 Life Cycles)	7%	\$74,418	25	Thunder Bay (North)	\$56,164	25	Timmins (North)	\$66,147
26	Kenora (North)	60 Years (2 Life Cycles)	7%	\$75,272	26	Kenora (North)	\$56,969	26	Kenora (North)	\$67,519
27	Kapuskasing (North)	60 Years (2 Life Cycles)	7%	\$76,465	27	Kapuskasing (North)	\$58,178	27	Kapuskasing (North)	\$71,753

Table F1-1.10: Rankings of cities for rebates scenario (average construction type) at a discount rate of 7% (two life cycles of V.GSHP and H.GSHP and five life cycles of Traditional HVAC Applications for a 60 year project lifespan)

FIT + Rebates – (#4)

Total Present Value										
(FIT+Rebates) - (#4)										
#	City	Project Life Span	Discount Rate	V.GSHP	#	City	H.GSHP	#	City	Traditional
1	St. Catharines (South)	60 Years (2 Life Cycles)	7%	\$50,283	1	St. Catharines (South)	\$35,532	1	Cambridge (South)	\$53,985
2	Sarnia (South)	60 Years (2 Life Cycles)	7%	\$50,666	2	Sarnia (South)	\$35,903	2	Guelph (South)	\$54,741
3	Chatham (South)	60 Years (2 Life Cycles)	7%	\$50,762	3	Chatham (South)	\$36,010	3	Chatham (South)	\$56,197
4	Windsor (South)	60 Years (2 Life Cycles)	7%	\$50,780	4	Windsor (South)	\$36,033	4	Windsor (South)	\$56,246
5	Niagara Falls (South)	60 Years (2 Life Cycles)	7%	\$50,942	5	Niagara Falls (South)	\$36,189	5	Niagara Falls (South)	\$57,267
6	Simcoe (South)	60 Years (2 Life Cycles)	7%	\$51,358	6	Simcoe (South)	\$36,614	6	London (South)	\$57,988
7	Hamilton (South)	60 Years (2 Life Cycles)	7%	\$51,645	7	Hamilton (South)	\$36,900	7	St. Catharines (South)	\$58,593
8	Cambridge (South)	60 Years (2 Life Cycles)	7%	\$51,909	8	London (South)	\$37,159	8	Barrie (Distinct)	\$58,786
9	London (South)	60 Years (2 Life Cycles)	7%	\$51,914	9	Cambridge (South)	\$37,167	9	Sarnia (South)	\$58,951
10	Toronto (South)	60 Years (2 Life Cycles)	7%	\$51,925	10	Toronto (South)	\$37,192	10	Simcoe (South)	\$59,159
11	Trenton (South)	60 Years (2 Life Cycles)	7%	\$52,158	11	Trenton (South)	\$37,398	11	Toronto (South)	\$59,293
12	Guelph (South)	60 Years (2 Life Cycles)	7%	\$52,171	12	Guelph (South)	\$37,438	12	Hamilton (South)	\$59,938
13	Mt. Forest (South)	60 Years (2 Life Cycles)	7%	\$52,686	13	Kitchener-Waterloo (South)	\$37,610	13	Sault Ste. Marie (North)	\$59,995
14	Sault Ste. Marie (North)	60 Years (2 Life Cycles)	7%	\$53,500	14	Mt. Forest (South)	\$37,946	14	Ottawa (Distinct)	\$60,282
15	Kitchener-Waterloo (South)	60 Years (2 Life Cycles)	7%	\$62,436	15	Kingston (South)	\$37,953	15	North Bay (North)	\$60,449
16	Barrie (Distinct)	60 Years (2 Life Cycles)	7%	\$62,634	16	Warton (South)	\$38,070	16	Muskoka (Distinct)	\$60,935
17	Kingston (South)	60 Years (2 Life Cycles)	7%	\$62,732	17	Sault Ste. Marie (North)	\$38,785	17	Mt. Forest (South)	\$60,947
18	Ottawa (Distinct)	60 Years (2 Life Cycles)	7%	\$62,857	18	Barrie (Distinct)	\$44,235	18	Kitchener-Waterloo (South)	\$60,977
19	Warton (South)	60 Years (2 Life Cycles)	7%	\$62,877	19	Ottawa (Distinct)	\$44,504	19	Peterborough (Distinct)	\$61,051
20	Peterborough (Distinct)	60 Years (2 Life Cycles)	7%	\$63,222	20	Peterborough (Distinct)	\$44,864	20	Warton (South)	\$62,095
21	Muskoka (Distinct)	60 Years (2 Life Cycles)	7%	\$63,379	21	Muskoka (Distinct)	\$44,983	21	Trenton (South)	\$63,478
22	North Bay (North)	60 Years (2 Life Cycles)	7%	\$63,529	22	North Bay (North)	\$45,204	22	Kingston (South)	\$64,021
23	Sudbury (North)	60 Years (2 Life Cycles)	7%	\$64,349	23	Sudbury (North)	\$46,032	23	Thunder Bay (North)	\$64,140
24	Timmins (North)	60 Years (2 Life Cycles)	7%	\$65,737	24	Timmins (North)	\$47,416	24	Sudbury (North)	\$65,022
25	Thunder Bay (North)	60 Years (2 Life Cycles)	7%	\$65,883	25	Thunder Bay (North)	\$47,535	25	Timmins (North)	\$66,147
26	Kenora (North)	60 Years (2 Life Cycles)	7%	\$66,482	26	Kenora (North)	\$48,099	26	Kenora (North)	\$67,519
27	Kapuskasing (North)	60 Years (2 Life Cycles)	7%	\$67,319	27	Kapuskasing (North)	\$48,948	27	Kapuskasing (North)	\$71,753

Table F1-1.11: Rankings of cities for feed-in tariff + rebates scenario (average construction type) at a discount rate of 7% (two life cycles of V.GSHP and H.GSHP and five life cycles of Traditional HVAC Applications for a 60 year project lifespan)

(FIT + Rebates) + Carbon Taxes – (#5)

Total Present Value										
(FIT+Rebates) + Carbon Taxes - (#5)										
#	City	Project Life Span	Discount Rate	V.GSHP	#	City	H.GSHP	#	City	Traditional
1	St. Catharines (South)	60 Years (2 Life Cycles)	7%	\$50,283	1	St. Catharines (South)	\$35,532	1	Cambridge (South)	\$67,142
2	Sarnia (South)	60 Years (2 Life Cycles)	7%	\$50,666	2	Sarnia (South)	\$35,903	2	Chatham (South)	\$67,907
3	Chatham (South)	60 Years (2 Life Cycles)	7%	\$50,762	3	Chatham (South)	\$36,010	3	Windsor (South)	\$67,989
4	Windsor (South)	60 Years (2 Life Cycles)	7%	\$50,780	4	Windsor (South)	\$36,033	4	Guelph (South)	\$68,321
5	Niagara Falls (South)	60 Years (2 Life Cycles)	7%	\$50,942	5	Niagara Falls (South)	\$36,189	5	Niagara Falls (South)	\$69,125
6	Simcoe (South)	60 Years (2 Life Cycles)	7%	\$51,358	6	Simcoe (South)	\$36,614	6	St. Catharines (South)	\$70,137
7	Hamilton (South)	60 Years (2 Life Cycles)	7%	\$51,645	7	Hamilton (South)	\$36,900	7	Sarnia (South)	\$70,987
8	Cambridge (South)	60 Years (2 Life Cycles)	7%	\$51,909	8	London (South)	\$37,159	8	London (South)	\$71,101
9	London (South)	60 Years (2 Life Cycles)	7%	\$51,914	9	Cambridge (South)	\$37,167	9	Simcoe (South)	\$71,632
10	Toronto (South)	60 Years (2 Life Cycles)	7%	\$51,925	10	Toronto (South)	\$37,192	10	Barrie (Distinct)	\$72,301
11	Trenton (South)	60 Years (2 Life Cycles)	7%	\$52,158	11	Trenton (South)	\$37,398	11	Toronto (South)	\$72,479
12	Guelph (South)	60 Years (2 Life Cycles)	7%	\$52,171	12	Guelph (South)	\$37,438	12	Hamilton (South)	\$72,737
13	Mt. Forest (South)	60 Years (2 Life Cycles)	7%	\$52,686	13	Kitchener-Waterloo (South)	\$37,610	13	Ottawa (Distinct)	\$74,144
14	Sault Ste. Marie (North)	60 Years (2 Life Cycles)	7%	\$53,500	14	Mt. Forest (South)	\$37,946	14	Kitchener-Waterloo (South)	\$74,583
15	Kitchener-Waterloo (South)	60 Years (2 Life Cycles)	7%	\$62,436	15	Kingston (South)	\$37,953	15	Sault Ste. Marie (North)	\$74,931
16	Barrie (Distinct)	60 Years (2 Life Cycles)	7%	\$62,634	16	Warton (South)	\$38,070	16	North Bay (North)	\$75,089
17	Kingston (South)	60 Years (2 Life Cycles)	7%	\$62,732	17	Sault Ste. Marie (North)	\$38,785	17	Peterborough (Distinct)	\$75,307
18	Ottawa (Distinct)	60 Years (2 Life Cycles)	7%	\$62,857	18	Barrie (Distinct)	\$44,235	18	Muskoka (Distinct)	\$75,466
19	Warton (South)	60 Years (2 Life Cycles)	7%	\$62,877	19	Ottawa (Distinct)	\$44,504	19	Mt. Forest (South)	\$75,489
20	Peterborough (Distinct)	60 Years (2 Life Cycles)	7%	\$63,222	20	Peterborough (Distinct)	\$44,864	20	Warton (South)	\$76,225
21	Muskoka (Distinct)	60 Years (2 Life Cycles)	7%	\$63,379	21	Muskoka (Distinct)	\$44,983	21	Trenton (South)	\$76,754
22	North Bay (North)	60 Years (2 Life Cycles)	7%	\$63,529	22	North Bay (North)	\$45,204	22	Kingston (South)	\$77,691
23	Sudbury (North)	60 Years (2 Life Cycles)	7%	\$64,349	23	Sudbury (North)	\$46,032	23	Sudbury (North)	\$80,794
24	Timmins (North)	60 Years (2 Life Cycles)	7%	\$65,737	24	Timmins (North)	\$47,416	24	Thunder Bay (North)	\$80,819
25	Thunder Bay (North)	60 Years (2 Life Cycles)	7%	\$65,883	25	Thunder Bay (North)	\$47,535	25	Timmins (North)	\$83,637
26	Kenora (North)	60 Years (2 Life Cycles)	7%	\$66,482	26	Kenora (North)	\$48,099	26	Kenora (North)	\$84,441
27	Kapuskasing (North)	60 Years (2 Life Cycles)	7%	\$67,319	27	Kapuskasing (North)	\$48,948	27	Kapuskasing (North)	\$89,872

Table F1-1.12: Rankings of cities for feed-in tariff + rebates + carbon tax scenario (average construction type) at a discount rate of 7% (two life cycles of V.GSHP and H.GSHP and five life cycles of Traditional HVAC Applications for a 60 year project lifespan)

3. Two Life Cycles of V.GSHP and H.GSHP and Five Life Cycles of Traditional HVAC Applications @ 7.5% Discount Rate

Base Case Scenario

Total Present Value										
Base Case Scenario										
#	City	Project Life Span	Discount Rate	V.GSHP	#	City	H.GSHP	#	City	Traditional
1	St. Catharines (South)	60 Years (2 Life Cycles)	7.5%	\$60,260	1	St. Catharines (South)	\$45,916	1	Cambridge (South)	\$50,600
2	Sarnia (South)	60 Years (2 Life Cycles)	7.5%	\$60,770	2	Sarnia (South)	\$46,411	2	Guelph (South)	\$51,305
3	Chatham (South)	60 Years (2 Life Cycles)	7.5%	\$60,898	3	Chatham (South)	\$46,553	3	Chatham (South)	\$52,688
4	Windsor (South)	60 Years (2 Life Cycles)	7.5%	\$60,922	4	Windsor (South)	\$46,584	4	Windsor (South)	\$52,734
5	Niagara Falls (South)	60 Years (2 Life Cycles)	7.5%	\$61,137	5	Niagara Falls (South)	\$46,791	5	Niagara Falls (South)	\$53,687
6	Simcoe (South)	60 Years (2 Life Cycles)	7.5%	\$61,691	6	Simcoe (South)	\$47,358	6	London (South)	\$54,355
7	Hamilton (South)	60 Years (2 Life Cycles)	7.5%	\$62,074	7	Hamilton (South)	\$47,738	7	St. Catharines (South)	\$54,943
8	Cambridge (South)	60 Years (2 Life Cycles)	7.5%	\$62,425	8	London (South)	\$48,083	8	Barrie (Distinct)	\$55,115
9	London (South)	60 Years (2 Life Cycles)	7.5%	\$62,432	9	Cambridge (South)	\$48,094	9	Sarnia (South)	\$55,275
10	Toronto (South)	60 Years (2 Life Cycles)	7.5%	\$62,447	10	Toronto (South)	\$48,127	10	Simcoe (South)	\$55,468
11	Trenton (South)	60 Years (2 Life Cycles)	7.5%	\$62,757	11	Trenton (South)	\$48,402	11	Toronto (South)	\$55,590
12	Guelph (South)	60 Years (2 Life Cycles)	7.5%	\$62,775	12	Guelph (South)	\$48,455	12	Hamilton (South)	\$56,194
13	Mt. Forest (South)	60 Years (2 Life Cycles)	7.5%	\$63,460	13	Kitchener-Waterloo (South)	\$48,683	13	Sault Ste. Marie (North)	\$56,222
14	Sault Ste. Marie (North)	60 Years (2 Life Cycles)	7.5%	\$64,544	14	Mt. Forest (South)	\$49,131	14	Ottawa (Distinct)	\$56,511
15	Kitchener-Waterloo (South)	60 Years (2 Life Cycles)	7.5%	\$72,709	15	Kingston (South)	\$49,140	15	North Bay (North)	\$56,664
16	Barrie (Distinct)	60 Years (2 Life Cycles)	7.5%	\$72,973	16	Warton (South)	\$49,296	16	Muskoka (Distinct)	\$57,118
17	Kingston (South)	60 Years (2 Life Cycles)	7.5%	\$73,102	17	Sault Ste. Marie (North)	\$50,248	17	Mt. Forest (South)	\$57,129
18	Ottawa (Distinct)	60 Years (2 Life Cycles)	7.5%	\$73,269	18	Barrie (Distinct)	\$55,096	18	Kitchener-Waterloo (South)	\$57,161
19	Warton (South)	60 Years (2 Life Cycles)	7.5%	\$73,296	19	Ottawa (Distinct)	\$55,454	19	Peterborough (Distinct)	\$57,227
20	Peterborough (Distinct)	60 Years (2 Life Cycles)	7.5%	\$73,755	20	Peterborough (Distinct)	\$55,933	20	Warton (South)	\$58,218
21	Muskoka (Distinct)	60 Years (2 Life Cycles)	7.5%	\$73,964	21	Muskoka (Distinct)	\$56,091	21	Trenton (South)	\$59,530
22	North Bay (North)	60 Years (2 Life Cycles)	7.5%	\$74,164	22	North Bay (North)	\$56,386	22	Kingston (South)	\$60,035
23	Sudbury (North)	60 Years (2 Life Cycles)	7.5%	\$75,256	23	Sudbury (North)	\$57,489	23	Thunder Bay (North)	\$60,102
24	Timmins (North)	60 Years (2 Life Cycles)	7.5%	\$77,105	24	Timmins (North)	\$59,331	24	Sudbury (North)	\$60,946
25	Thunder Bay (North)	60 Years (2 Life Cycles)	7.5%	\$77,298	25	Thunder Bay (North)	\$59,489	25	Timmins (North)	\$61,974
26	Kenora (North)	60 Years (2 Life Cycles)	7.5%	\$78,096	26	Kenora (North)	\$60,241	26	Kenora (North)	\$63,273
27	Kapuskasing (North)	60 Years (2 Life Cycles)	7.5%	\$79,210	27	Kapuskasing (North)	\$61,370	27	Kapuskasing (North)	\$67,240

Table F1-1.13: Rankings of cities for base case scenario (average construction type) at a discount rate of 7.5% (two life cycles of V.GSHP and H.GSHP and five life cycles of Traditional HVAC Applications for a 60 year project lifespan)

Carbon Taxes – (#1)

Total Present Value										
Carbon Taxes - (#1)										
#	City	Project Life Span	Discount Rate	V.GSHP	#	City	H.GSHP	#	City	Traditional
1	St. Catharines (South)	60 Years (2 Life Cycles)	7.5%	\$60,260	1	St. Catharines (South)	\$45,916	1	Cambridge (South)	\$62,333
2	Sarnia (South)	60 Years (2 Life Cycles)	7.5%	\$60,770	2	Sarnia (South)	\$46,411	2	Chatham (South)	\$63,131
3	Chatham (South)	60 Years (2 Life Cycles)	7.5%	\$60,898	3	Chatham (South)	\$46,553	3	Windsor (South)	\$63,206
4	Windsor (South)	60 Years (2 Life Cycles)	7.5%	\$60,922	4	Windsor (South)	\$46,584	4	Guelph (South)	\$63,415
5	Niagara Falls (South)	60 Years (2 Life Cycles)	7.5%	\$61,137	5	Niagara Falls (South)	\$46,791	5	Niagara Falls (South)	\$64,262
6	Simcoe (South)	60 Years (2 Life Cycles)	7.5%	\$61,691	6	Simcoe (South)	\$47,358	6	St. Catharines (South)	\$65,238
7	Hamilton (South)	60 Years (2 Life Cycles)	7.5%	\$62,074	7	Hamilton (South)	\$47,738	7	Sarnia (South)	\$66,009
8	Cambridge (South)	60 Years (2 Life Cycles)	7.5%	\$62,425	8	London (South)	\$48,083	8	London (South)	\$66,049
9	London (South)	60 Years (2 Life Cycles)	7.5%	\$62,432	9	Cambridge (South)	\$48,094	9	Simcoe (South)	\$66,591
10	Toronto (South)	60 Years (2 Life Cycles)	7.5%	\$62,447	10	Toronto (South)	\$48,127	10	Barrie (Distinct)	\$67,167
11	Trenton (South)	60 Years (2 Life Cycles)	7.5%	\$62,757	11	Trenton (South)	\$48,402	11	Toronto (South)	\$67,348
12	Guelph (South)	60 Years (2 Life Cycles)	7.5%	\$62,775	12	Guelph (South)	\$48,455	12	Hamilton (South)	\$67,607
13	Mt. Forest (South)	60 Years (2 Life Cycles)	7.5%	\$63,460	13	Kitchener-Waterloo (South)	\$48,683	13	Ottawa (Distinct)	\$68,872
14	Sault Ste. Marie (North)	60 Years (2 Life Cycles)	7.5%	\$64,544	14	Mt. Forest (South)	\$49,131	14	Kitchener-Waterloo (South)	\$69,294
15	Kitchener-Waterloo (South)	60 Years (2 Life Cycles)	7.5%	\$72,709	15	Kingston (South)	\$49,140	15	Sault Ste. Marie (North)	\$69,542
16	Barrie (Distinct)	60 Years (2 Life Cycles)	7.5%	\$72,973	16	Warton (South)	\$49,296	16	North Bay (North)	\$69,719
17	Kingston (South)	60 Years (2 Life Cycles)	7.5%	\$73,102	17	Sault Ste. Marie (North)	\$50,248	17	Peterborough (Distinct)	\$69,940
18	Ottawa (Distinct)	60 Years (2 Life Cycles)	7.5%	\$73,269	18	Barrie (Distinct)	\$55,096	18	Muskoka (Distinct)	\$70,076
19	Warton (South)	60 Years (2 Life Cycles)	7.5%	\$73,296	19	Ottawa (Distinct)	\$55,454	19	Mt. Forest (South)	\$70,097
20	Peterborough (Distinct)	60 Years (2 Life Cycles)	7.5%	\$73,755	20	Peterborough (Distinct)	\$55,933	20	Warton (South)	\$70,819
21	Muskoka (Distinct)	60 Years (2 Life Cycles)	7.5%	\$73,964	21	Muskoka (Distinct)	\$56,091	21	Trenton (South)	\$71,369
22	North Bay (North)	60 Years (2 Life Cycles)	7.5%	\$74,164	22	North Bay (North)	\$56,386	22	Kingston (South)	\$72,226
23	Sudbury (North)	60 Years (2 Life Cycles)	7.5%	\$75,256	23	Sudbury (North)	\$57,489	23	Thunder Bay (North)	\$74,976
24	Timmins (North)	60 Years (2 Life Cycles)	7.5%	\$77,105	24	Timmins (North)	\$59,331	24	Sudbury (North)	\$75,011
25	Thunder Bay (North)	60 Years (2 Life Cycles)	7.5%	\$77,298	25	Thunder Bay (North)	\$59,489	25	Timmins (North)	\$77,571
26	Kenora (North)	60 Years (2 Life Cycles)	7.5%	\$78,096	26	Kenora (North)	\$60,241	26	Kenora (North)	\$78,364
27	Kapuskasing (North)	60 Years (2 Life Cycles)	7.5%	\$79,210	27	Kapuskasing (North)	\$61,370	27	Kapuskasing (North)	\$83,397

Table F1-1.14: Rankings of cities for carbon taxes scenario (average construction type) at a discount rate of 7.5% (two life cycles of V.GSHP and H.GSHP and five life cycles of Traditional HVAC Applications for a 60 year project lifespan)

FIT – (#2)

Total Present Value										
FIT - (#2)										
#	City	Project Life Span	Discount Rate	V.GSHP	#	City	H.GSHP	#	City	Traditional
1	St. Catharines (South)	60 Years (2 Life Cycles)	7.5%	\$54,332	1	St. Catharines (South)	\$39,946	1	Cambridge (South)	\$50,600
2	Sarnia (South)	60 Years (2 Life Cycles)	7.5%	\$54,689	2	Sarnia (South)	\$40,293	2	Guelph (South)	\$51,305
3	Chatham (South)	60 Years (2 Life Cycles)	7.5%	\$54,779	3	Chatham (South)	\$40,393	3	Chatham (South)	\$52,688
4	Windsor (South)	60 Years (2 Life Cycles)	7.5%	\$54,796	4	Windsor (South)	\$40,414	4	Windsor (South)	\$52,734
5	Niagara Falls (South)	60 Years (2 Life Cycles)	7.5%	\$54,946	5	Niagara Falls (South)	\$40,559	5	Niagara Falls (South)	\$53,687
6	Simcoe (South)	60 Years (2 Life Cycles)	7.5%	\$55,334	6	Simcoe (South)	\$40,956	6	London (South)	\$54,355
7	Hamilton (South)	60 Years (2 Life Cycles)	7.5%	\$55,602	7	Hamilton (South)	\$41,223	7	St. Catharines (South)	\$54,943
8	Cambridge (South)	60 Years (2 Life Cycles)	7.5%	\$55,849	8	London (South)	\$41,465	8	Barrie (Distinct)	\$55,115
9	London (South)	60 Years (2 Life Cycles)	7.5%	\$55,853	9	Cambridge (South)	\$41,472	9	Sarnia (South)	\$55,275
10	Toronto (South)	60 Years (2 Life Cycles)	7.5%	\$55,864	10	Toronto (South)	\$41,495	10	Simcoe (South)	\$55,468
11	Trenton (South)	60 Years (2 Life Cycles)	7.5%	\$56,081	11	Trenton (South)	\$41,688	11	Toronto (South)	\$55,590
12	Guelph (South)	60 Years (2 Life Cycles)	7.5%	\$56,094	12	Guelph (South)	\$41,725	12	Hamilton (South)	\$56,194
13	Mt. Forest (South)	60 Years (2 Life Cycles)	7.5%	\$56,574	13	Kitchener-Waterloo (South)	\$41,885	13	Sault Ste. Marie (North)	\$56,222
14	Sault Ste. Marie (North)	60 Years (2 Life Cycles)	7.5%	\$57,333	14	Mt. Forest (South)	\$42,199	14	Ottawa (Distinct)	\$56,511
15	Kitchener-Waterloo (South)	60 Years (2 Life Cycles)	7.5%	\$66,082	15	Kingston (South)	\$42,205	15	North Bay (North)	\$56,664
16	Barrie (Distinct)	60 Years (2 Life Cycles)	7.5%	\$66,267	16	Warton (South)	\$42,315	16	Muskoka (Distinct)	\$57,118
17	Kingston (South)	60 Years (2 Life Cycles)	7.5%	\$66,357	17	Sault Ste. Marie (North)	\$42,981	17	Mt. Forest (South)	\$57,129
18	Ottawa (Distinct)	60 Years (2 Life Cycles)	7.5%	\$66,474	18	Barrie (Distinct)	\$48,322	18	Kitchener-Waterloo (South)	\$57,161
19	Warton (South)	60 Years (2 Life Cycles)	7.5%	\$66,493	19	Ottawa (Distinct)	\$48,573	19	Peterborough (Distinct)	\$57,227
20	Peterborough (Distinct)	60 Years (2 Life Cycles)	7.5%	\$66,815	20	Peterborough (Distinct)	\$48,908	20	Warton (South)	\$58,218
21	Muskoka (Distinct)	60 Years (2 Life Cycles)	7.5%	\$66,961	21	Muskoka (Distinct)	\$49,019	21	Trenton (South)	\$59,530
22	North Bay (North)	60 Years (2 Life Cycles)	7.5%	\$67,101	22	North Bay (North)	\$49,226	22	Kingston (South)	\$60,035
23	Sudbury (North)	60 Years (2 Life Cycles)	7.5%	\$67,866	23	Sudbury (North)	\$49,999	23	Thunder Bay (North)	\$60,102
24	Timmins (North)	60 Years (2 Life Cycles)	7.5%	\$69,162	24	Timmins (North)	\$51,289	24	Sudbury (North)	\$60,946
25	Thunder Bay (North)	60 Years (2 Life Cycles)	7.5%	\$69,297	25	Thunder Bay (North)	\$51,400	25	Timmins (North)	\$61,974
26	Kenora (North)	60 Years (2 Life Cycles)	7.5%	\$69,856	26	Kenora (North)	\$51,927	26	Kenora (North)	\$63,273
27	Kapuskasing (North)	60 Years (2 Life Cycles)	7.5%	\$70,637	27	Kapuskasing (North)	\$52,718	27	Kapuskasing (North)	\$67,240

Table F1-1.15: Rankings of cities for feed-in tariff scenario (average construction type) at a discount rate of 7.5% (two life cycles of V.GSHP and H.GSHP and five life cycles of Traditional HVAC Applications for a 60 year project lifespan)

Rebates – (#3)

Total Present Value										
Rebates - (#3)										
#	City	Project Life Span	Discount Rate	V.GSHP	#	City	H.GSHP	#	City	Traditional
1	St. Catharines (South)	60 Years (2 Life Cycles)	7.5%	\$54,226	1	St. Catharines (South)	\$39,882	1	Cambridge (South)	\$50,600
2	Sarnia (South)	60 Years (2 Life Cycles)	7.5%	\$54,736	2	Sarnia (South)	\$40,376	2	Guelph (South)	\$51,305
3	Chatham (South)	60 Years (2 Life Cycles)	7.5%	\$54,863	3	Chatham (South)	\$40,519	3	Chatham (South)	\$52,688
4	Windsor (South)	60 Years (2 Life Cycles)	7.5%	\$54,887	4	Windsor (South)	\$40,550	4	Windsor (South)	\$52,734
5	Niagara Falls (South)	60 Years (2 Life Cycles)	7.5%	\$55,103	5	Niagara Falls (South)	\$40,756	5	Niagara Falls (South)	\$53,687
6	Simcoe (South)	60 Years (2 Life Cycles)	7.5%	\$55,657	6	Simcoe (South)	\$41,323	6	London (South)	\$54,355
7	Hamilton (South)	60 Years (2 Life Cycles)	7.5%	\$56,039	7	Hamilton (South)	\$41,704	7	St. Catharines (South)	\$54,943
8	Cambridge (South)	60 Years (2 Life Cycles)	7.5%	\$56,391	8	London (South)	\$42,049	8	Barrie (Distinct)	\$55,115
9	London (South)	60 Years (2 Life Cycles)	7.5%	\$56,397	9	Cambridge (South)	\$42,060	9	Sarnia (South)	\$55,275
10	Toronto (South)	60 Years (2 Life Cycles)	7.5%	\$56,413	10	Toronto (South)	\$42,093	10	Simcoe (South)	\$55,468
11	Trenton (South)	60 Years (2 Life Cycles)	7.5%	\$56,723	11	Trenton (South)	\$42,367	11	Toronto (South)	\$55,590
12	Guelph (South)	60 Years (2 Life Cycles)	7.5%	\$56,740	12	Guelph (South)	\$42,420	12	Hamilton (South)	\$56,194
13	Mt. Forest (South)	60 Years (2 Life Cycles)	7.5%	\$57,426	13	Kitchener-Waterloo (South)	\$42,649	13	Sault Ste. Marie (North)	\$56,222
14	Sault Ste. Marie (North)	60 Years (2 Life Cycles)	7.5%	\$58,509	14	Mt. Forest (South)	\$43,097	14	Ottawa (Distinct)	\$56,511
15	Kitchener-Waterloo (South)	60 Years (2 Life Cycles)	7.5%	\$66,674	15	Kingston (South)	\$43,106	15	North Bay (North)	\$56,664
16	Barrie (Distinct)	60 Years (2 Life Cycles)	7.5%	\$66,938	16	Warton (South)	\$43,262	16	Muskoka (Distinct)	\$57,118
17	Kingston (South)	60 Years (2 Life Cycles)	7.5%	\$67,068	17	Sault Ste. Marie (North)	\$44,214	17	Mt. Forest (South)	\$57,129
18	Ottawa (Distinct)	60 Years (2 Life Cycles)	7.5%	\$67,235	18	Barrie (Distinct)	\$49,061	18	Kitchener-Waterloo (South)	\$57,161
19	Warton (South)	60 Years (2 Life Cycles)	7.5%	\$67,261	19	Ottawa (Distinct)	\$49,419	19	Peterborough (Distinct)	\$57,227
20	Peterborough (Distinct)	60 Years (2 Life Cycles)	7.5%	\$67,721	20	Peterborough (Distinct)	\$49,898	20	Warton (South)	\$58,218
21	Muskoka (Distinct)	60 Years (2 Life Cycles)	7.5%	\$67,929	21	Muskoka (Distinct)	\$50,057	21	Trenton (South)	\$59,530
22	North Bay (North)	60 Years (2 Life Cycles)	7.5%	\$68,129	22	North Bay (North)	\$50,351	22	Kingston (South)	\$60,035
23	Sudbury (North)	60 Years (2 Life Cycles)	7.5%	\$69,222	23	Sudbury (North)	\$51,454	23	Thunder Bay (North)	\$60,102
24	Timmins (North)	60 Years (2 Life Cycles)	7.5%	\$71,070	24	Timmins (North)	\$53,296	24	Sudbury (North)	\$60,946
25	Thunder Bay (North)	60 Years (2 Life Cycles)	7.5%	\$71,263	25	Thunder Bay (North)	\$53,455	25	Timmins (North)	\$61,974
26	Kenora (North)	60 Years (2 Life Cycles)	7.5%	\$72,061	26	Kenora (North)	\$54,206	26	Kenora (North)	\$63,273
27	Kapuskasing (North)	60 Years (2 Life Cycles)	7.5%	\$73,176	27	Kapuskasing (North)	\$55,336	27	Kapuskasing (North)	\$67,240

Table F1-1.16: Rankings of cities for rebates scenario (average construction type) at a discount rate of 7.5% (two life cycles of V.GSHP and H.GSHP and five life cycles of Traditional HVAC Applications for a 60 year project lifespan)

FIT + Rebates – (#4)

Total Present Value										
(FIT+Rebates) - (#4)										
#	City	Project Life Span	Discount Rate	V.GSHP	#	City	H.GSHP	#	City	Traditional
1	St. Catharines (South)	60 Years (2 Life Cycles)	7.5%	\$48,298	1	St. Catharines (South)	\$33,912	1	Cambridge (South)	\$50,600
2	Sarnia (South)	60 Years (2 Life Cycles)	7.5%	\$48,655	2	Sarnia (South)	\$34,258	2	Guelph (South)	\$51,305
3	Chatham (South)	60 Years (2 Life Cycles)	7.5%	\$48,744	3	Chatham (South)	\$34,358	3	Chatham (South)	\$52,688
4	Windsor (South)	60 Years (2 Life Cycles)	7.5%	\$48,761	4	Windsor (South)	\$34,380	4	Windsor (South)	\$52,734
5	Niagara Falls (South)	60 Years (2 Life Cycles)	7.5%	\$48,912	5	Niagara Falls (South)	\$34,525	5	Niagara Falls (South)	\$53,687
6	Simcoe (South)	60 Years (2 Life Cycles)	7.5%	\$49,300	6	Simcoe (South)	\$34,922	6	London (South)	\$54,355
7	Hamilton (South)	60 Years (2 Life Cycles)	7.5%	\$49,568	7	Hamilton (South)	\$35,188	7	St. Catharines (South)	\$54,943
8	Cambridge (South)	60 Years (2 Life Cycles)	7.5%	\$49,814	8	London (South)	\$35,430	8	Barrie (Distinct)	\$55,115
9	London (South)	60 Years (2 Life Cycles)	7.5%	\$49,819	9	Cambridge (South)	\$35,438	9	Sarnia (South)	\$55,275
10	Toronto (South)	60 Years (2 Life Cycles)	7.5%	\$49,830	10	Toronto (South)	\$35,461	10	Simcoe (South)	\$55,468
11	Trenton (South)	60 Years (2 Life Cycles)	7.5%	\$50,047	11	Trenton (South)	\$35,653	11	Toronto (South)	\$55,590
12	Guelph (South)	60 Years (2 Life Cycles)	7.5%	\$50,059	12	Guelph (South)	\$35,690	12	Hamilton (South)	\$56,194
13	Mt. Forest (South)	60 Years (2 Life Cycles)	7.5%	\$50,540	13	Kitchener-Waterloo (South)	\$35,851	13	Sault Ste. Marie (North)	\$56,222
14	Sault Ste. Marie (North)	60 Years (2 Life Cycles)	7.5%	\$51,299	14	Mt. Forest (South)	\$36,165	14	Ottawa (Distinct)	\$56,511
15	Kitchener-Waterloo (South)	60 Years (2 Life Cycles)	7.5%	\$60,047	15	Kingston (South)	\$36,171	15	North Bay (North)	\$56,664
16	Barrie (Distinct)	60 Years (2 Life Cycles)	7.5%	\$60,232	16	Warton (South)	\$36,280	16	Muskoka (Distinct)	\$57,118
17	Kingston (South)	60 Years (2 Life Cycles)	7.5%	\$60,323	17	Sault Ste. Marie (North)	\$36,947	17	Mt. Forest (South)	\$57,129
18	Ottawa (Distinct)	60 Years (2 Life Cycles)	7.5%	\$60,440	18	Barrie (Distinct)	\$42,287	18	Kitchener-Waterloo (South)	\$57,161
19	Warton (South)	60 Years (2 Life Cycles)	7.5%	\$60,458	19	Ottawa (Distinct)	\$42,538	19	Peterborough (Distinct)	\$57,227
20	Peterborough (Distinct)	60 Years (2 Life Cycles)	7.5%	\$60,780	20	Peterborough (Distinct)	\$42,874	20	Warton (South)	\$58,218
21	Muskoka (Distinct)	60 Years (2 Life Cycles)	7.5%	\$60,927	21	Muskoka (Distinct)	\$42,985	21	Trenton (South)	\$59,530
22	North Bay (North)	60 Years (2 Life Cycles)	7.5%	\$61,067	22	North Bay (North)	\$43,191	22	Kingston (South)	\$60,035
23	Sudbury (North)	60 Years (2 Life Cycles)	7.5%	\$61,832	23	Sudbury (North)	\$43,964	23	Thunder Bay (North)	\$60,102
24	Timmins (North)	60 Years (2 Life Cycles)	7.5%	\$63,127	24	Timmins (North)	\$45,255	24	Sudbury (North)	\$60,946
25	Thunder Bay (North)	60 Years (2 Life Cycles)	7.5%	\$63,263	25	Thunder Bay (North)	\$45,365	25	Timmins (North)	\$61,974
26	Kenora (North)	60 Years (2 Life Cycles)	7.5%	\$63,822	26	Kenora (North)	\$45,892	26	Kenora (North)	\$63,273
27	Kapuskasing (North)	60 Years (2 Life Cycles)	7.5%	\$64,602	27	Kapuskasing (North)	\$46,684	27	Kapuskasing (North)	\$67,240

Table F1-1.17: Rankings of cities for feed-in tariff + rebates scenario (average construction type) at a discount rate of 7.5% (two life cycles of V.GSHP and H.GSHP and five life cycles of Traditional HVAC Applications for a 60 year project lifespan)

(FIT + Rebates) + Carbon Taxes – (#5)

Total Present Value										
(FIT+Rebates) + Carbon Taxes - (#5)										
#	City	Project Life Span	Discount Rate	V.GSHP	#	City	H.GSHP	#	City	Traditional
1	St. Catharines (South)	60 Years (2 Life Cycles)	7.5%	\$48,298	1	St. Catharines (South)	\$33,912	1	Cambridge (South)	\$62,333
2	Sarnia (South)	60 Years (2 Life Cycles)	7.5%	\$48,655	2	Sarnia (South)	\$34,258	2	Chatham (South)	\$63,131
3	Chatham (South)	60 Years (2 Life Cycles)	7.5%	\$48,744	3	Chatham (South)	\$34,358	3	Windsor (South)	\$63,206
4	Windsor (South)	60 Years (2 Life Cycles)	7.5%	\$48,761	4	Windsor (South)	\$34,380	4	Guelph (South)	\$63,415
5	Niagara Falls (South)	60 Years (2 Life Cycles)	7.5%	\$48,912	5	Niagara Falls (South)	\$34,525	5	Niagara Falls (South)	\$64,262
6	Simcoe (South)	60 Years (2 Life Cycles)	7.5%	\$49,300	6	Simcoe (South)	\$34,922	6	St. Catharines (South)	\$65,238
7	Hamilton (South)	60 Years (2 Life Cycles)	7.5%	\$49,568	7	Hamilton (South)	\$35,188	7	Sarnia (South)	\$66,009
8	Cambridge (South)	60 Years (2 Life Cycles)	7.5%	\$49,814	8	London (South)	\$35,430	8	London (South)	\$66,049
9	London (South)	60 Years (2 Life Cycles)	7.5%	\$49,819	9	Cambridge (South)	\$35,438	9	Simcoe (South)	\$66,591
10	Toronto (South)	60 Years (2 Life Cycles)	7.5%	\$49,830	10	Toronto (South)	\$35,461	10	Barrie (Distinct)	\$67,167
11	Trenton (South)	60 Years (2 Life Cycles)	7.5%	\$50,047	11	Trenton (South)	\$35,653	11	Toronto (South)	\$67,348
12	Guelph (South)	60 Years (2 Life Cycles)	7.5%	\$50,059	12	Guelph (South)	\$35,690	12	Hamilton (South)	\$67,607
13	Mt. Forest (South)	60 Years (2 Life Cycles)	7.5%	\$50,540	13	Kitchener-Waterloo (South)	\$35,851	13	Ottawa (Distinct)	\$68,872
14	Sault Ste. Marie (North)	60 Years (2 Life Cycles)	7.5%	\$51,299	14	Mt. Forest (South)	\$36,165	14	Kitchener-Waterloo (South)	\$69,294
15	Kitchener-Waterloo (South)	60 Years (2 Life Cycles)	7.5%	\$60,047	15	Kingston (South)	\$36,171	15	Sault Ste. Marie (North)	\$69,542
16	Barrie (Distinct)	60 Years (2 Life Cycles)	7.5%	\$60,232	16	Warton (South)	\$36,280	16	North Bay (North)	\$69,719
17	Kingston (South)	60 Years (2 Life Cycles)	7.5%	\$60,323	17	Sault Ste. Marie (North)	\$36,947	17	Peterborough (Distinct)	\$69,940
18	Ottawa (Distinct)	60 Years (2 Life Cycles)	7.5%	\$60,440	18	Barrie (Distinct)	\$42,287	18	Muskoka (Distinct)	\$70,076
19	Warton (South)	60 Years (2 Life Cycles)	7.5%	\$60,458	19	Ottawa (Distinct)	\$42,538	19	Mt. Forest (South)	\$70,097
20	Peterborough (Distinct)	60 Years (2 Life Cycles)	7.5%	\$60,780	20	Peterborough (Distinct)	\$42,874	20	Warton (South)	\$70,819
21	Muskoka (Distinct)	60 Years (2 Life Cycles)	7.5%	\$60,927	21	Muskoka (Distinct)	\$42,985	21	Trenton (South)	\$71,369
22	North Bay (North)	60 Years (2 Life Cycles)	7.5%	\$61,067	22	North Bay (North)	\$43,191	22	Kingston (South)	\$72,226
23	Sudbury (North)	60 Years (2 Life Cycles)	7.5%	\$61,832	23	Sudbury (North)	\$43,964	23	Thunder Bay (North)	\$74,976
24	Timmins (North)	60 Years (2 Life Cycles)	7.5%	\$63,127	24	Timmins (North)	\$45,255	24	Sudbury (North)	\$75,011
25	Thunder Bay (North)	60 Years (2 Life Cycles)	7.5%	\$63,263	25	Thunder Bay (North)	\$45,365	25	Timmins (North)	\$77,571
26	Kenora (North)	60 Years (2 Life Cycles)	7.5%	\$63,822	26	Kenora (North)	\$45,892	26	Kenora (North)	\$78,364
27	Kapuskasing (North)	60 Years (2 Life Cycles)	7.5%	\$64,602	27	Kapuskasing (North)	\$46,684	27	Kapuskasing (North)	\$83,397

Table F1-1.18: Rankings of cities for feed-in tariff + rebates + carbon tax scenario (average construction type) at a discount rate of 7.5% (two life cycles of V.GSHP and H.GSHP and five life cycles of Traditional HVAC Applications for a 60 year project lifespan)

4. Two Life Cycles of V.GSHP and H.GSHP and Five Life Cycles of Traditional HVAC Applications @ 8.5% Discount Rate

Base Case Scenario

Total Present Value										
Base Case Scenario										
#	City	Project Life Span	Discount Rate	V.GSHP	#	City	H.GSHP	#	City	Traditional
1	St. Catharines (South)	60 Years (2 Life Cycles)	8.5%	\$56,076	1	St. Catharines (South)	\$42,317	1	Cambridge (South)	\$44,996
2	Sarnia (South)	60 Years (2 Life Cycles)	8.5%	\$56,525	2	Sarnia (South)	\$42,753	2	Guelph (South)	\$45,615
3	Chatham (South)	60 Years (2 Life Cycles)	8.5%	\$56,638	3	Chatham (South)	\$42,879	3	Chatham (South)	\$46,879
4	Windsor (South)	60 Years (2 Life Cycles)	8.5%	\$56,659	4	Windsor (South)	\$42,906	4	Windsor (South)	\$46,919
5	Niagara Falls (South)	60 Years (2 Life Cycles)	8.5%	\$56,849	5	Niagara Falls (South)	\$43,089	5	Niagara Falls (South)	\$47,758
6	Simcoe (South)	60 Years (2 Life Cycles)	8.5%	\$57,338	6	Simcoe (South)	\$43,589	6	London (South)	\$48,339
7	Hamilton (South)	60 Years (2 Life Cycles)	8.5%	\$57,675	7	Hamilton (South)	\$43,924	7	St. Catharines (South)	\$48,900
8	Cambridge (South)	60 Years (2 Life Cycles)	8.5%	\$57,985	8	London (South)	\$44,229	8	Barrie (Distinct)	\$49,037
9	London (South)	60 Years (2 Life Cycles)	8.5%	\$57,991	9	Cambridge (South)	\$44,238	9	Sarnia (South)	\$49,189
10	Toronto (South)	60 Years (2 Life Cycles)	8.5%	\$58,005	10	Toronto (South)	\$44,267	10	Simcoe (South)	\$49,356
11	Trenton (South)	60 Years (2 Life Cycles)	8.5%	\$58,278	11	Trenton (South)	\$44,510	11	Toronto (South)	\$49,458
12	Guelph (South)	60 Years (2 Life Cycles)	8.5%	\$58,293	12	Guelph (South)	\$44,556	12	Hamilton (South)	\$49,994
13	Mt. Forest (South)	60 Years (2 Life Cycles)	8.5%	\$58,898	13	Kitchener-Waterloo (South)	\$44,758	13	Sault Ste. Marie (North)	\$49,974
14	Sault Ste. Marie (North)	60 Years (2 Life Cycles)	8.5%	\$59,854	14	Mt. Forest (South)	\$45,153	14	Ottawa (Distinct)	\$50,266
15	Kitchener-Waterloo (South)	60 Years (2 Life Cycles)	8.5%	\$67,786	15	Kingston (South)	\$45,161	15	North Bay (North)	\$50,396
16	Barrie (Distinct)	60 Years (2 Life Cycles)	8.5%	\$68,019	16	Warton (South)	\$45,299	16	Muskoka (Distinct)	\$50,797
17	Kingston (South)	60 Years (2 Life Cycles)	8.5%	\$68,133	17	Sault Ste. Marie (North)	\$46,138	17	Mt. Forest (South)	\$50,807
18	Ottawa (Distinct)	60 Years (2 Life Cycles)	8.5%	\$68,281	18	Barrie (Distinct)	\$50,868	18	Kitchener-Waterloo (South)	\$50,842
19	Warton (South)	60 Years (2 Life Cycles)	8.5%	\$68,304	19	Ottawa (Distinct)	\$51,184	19	Peterborough (Distinct)	\$50,895
20	Peterborough (Distinct)	60 Years (2 Life Cycles)	8.5%	\$68,709	20	Peterborough (Distinct)	\$51,607	20	Warton (South)	\$51,801
21	Muskoka (Distinct)	60 Years (2 Life Cycles)	8.5%	\$68,893	21	Muskoka (Distinct)	\$51,746	21	Trenton (South)	\$52,995
22	North Bay (North)	60 Years (2 Life Cycles)	8.5%	\$69,070	22	North Bay (North)	\$52,006	22	Kingston (South)	\$53,438
23	Sudbury (North)	60 Years (2 Life Cycles)	8.5%	\$70,033	23	Sudbury (North)	\$52,979	23	Thunder Bay (North)	\$53,415
24	Timmins (North)	60 Years (2 Life Cycles)	8.5%	\$71,664	24	Timmins (North)	\$54,604	24	Sudbury (North)	\$54,196
25	Thunder Bay (North)	60 Years (2 Life Cycles)	8.5%	\$71,834	25	Thunder Bay (North)	\$54,743	25	Timmins (North)	\$55,060
26	Kenora (North)	60 Years (2 Life Cycles)	8.5%	\$72,538	26	Kenora (North)	\$55,406	26	Kenora (North)	\$56,241
27	Kapuskasing (North)	60 Years (2 Life Cycles)	8.5%	\$73,521	27	Kapuskasing (North)	\$56,403	27	Kapuskasing (North)	\$59,762

Table F1-1.19: Rankings of cities for base case scenario (average construction type) at a discount rate of 8.5% (two life cycles of V.GSHP and H.GSHP and five life cycles of Traditional HVAC Applications for a 60 year project lifespan)

Carbon Taxes – (#1)

Total Present Value										
Carbon Taxes - (#1)										
#	City	Project Life Span	Discount Rate	V.GSHP	#	City	H.GSHP	#	City	Traditional
1	St. Catharines (South)	60 Years (2 Life Cycles)	8.5%	\$56,076	1	St. Catharines (South)	\$42,317	1	Cambridge (South)	\$54,463
2	Sarnia (South)	60 Years (2 Life Cycles)	8.5%	\$56,525	2	Sarnia (South)	\$42,753	2	Chatham (South)	\$55,304
3	Chatham (South)	60 Years (2 Life Cycles)	8.5%	\$56,638	3	Chatham (South)	\$42,879	3	Windsor (South)	\$55,368
4	Windsor (South)	60 Years (2 Life Cycles)	8.5%	\$56,659	4	Windsor (South)	\$42,906	4	Guelph (South)	\$55,386
5	Niagara Falls (South)	60 Years (2 Life Cycles)	8.5%	\$56,849	5	Niagara Falls (South)	\$43,089	5	Niagara Falls (South)	\$56,291
6	Simcoe (South)	60 Years (2 Life Cycles)	8.5%	\$57,338	6	Simcoe (South)	\$43,589	6	St. Catharines (South)	\$57,206
7	Hamilton (South)	60 Years (2 Life Cycles)	8.5%	\$57,675	7	Hamilton (South)	\$43,924	7	London (South)	\$57,775
8	Cambridge (South)	60 Years (2 Life Cycles)	8.5%	\$57,985	8	London (South)	\$44,229	8	Sarnia (South)	\$57,849
9	London (South)	60 Years (2 Life Cycles)	8.5%	\$57,991	9	Cambridge (South)	\$44,238	9	Simcoe (South)	\$58,330
10	Toronto (South)	60 Years (2 Life Cycles)	8.5%	\$58,005	10	Toronto (South)	\$44,267	10	Barrie (Distinct)	\$58,761
11	Trenton (South)	60 Years (2 Life Cycles)	8.5%	\$58,278	11	Trenton (South)	\$44,510	11	Toronto (South)	\$58,946
12	Guelph (South)	60 Years (2 Life Cycles)	8.5%	\$58,293	12	Guelph (South)	\$44,556	12	Hamilton (South)	\$59,203
13	Mt. Forest (South)	60 Years (2 Life Cycles)	8.5%	\$58,898	13	Kitchener-Waterloo (South)	\$44,758	13	Ottawa (Distinct)	\$60,240
14	Sault Ste. Marie (North)	60 Years (2 Life Cycles)	8.5%	\$59,854	14	Mt. Forest (South)	\$45,153	14	Kitchener-Waterloo (South)	\$60,631
15	Kitchener-Waterloo (South)	60 Years (2 Life Cycles)	8.5%	\$67,786	15	Kingston (South)	\$45,161	15	Sault Ste. Marie (North)	\$60,721
16	Barrie (Distinct)	60 Years (2 Life Cycles)	8.5%	\$68,019	16	Warton (South)	\$45,299	16	North Bay (North)	\$60,929
17	Kingston (South)	60 Years (2 Life Cycles)	8.5%	\$68,133	17	Sault Ste. Marie (North)	\$46,138	17	Peterborough (Distinct)	\$61,153
18	Ottawa (Distinct)	60 Years (2 Life Cycles)	8.5%	\$68,281	18	Barrie (Distinct)	\$50,868	18	Muskoka (Distinct)	\$61,252
19	Warton (South)	60 Years (2 Life Cycles)	8.5%	\$68,304	19	Ottawa (Distinct)	\$51,184	19	Mt. Forest (South)	\$61,270
20	Peterborough (Distinct)	60 Years (2 Life Cycles)	8.5%	\$68,709	20	Peterborough (Distinct)	\$51,607	20	Warton (South)	\$61,968
21	Muskoka (Distinct)	60 Years (2 Life Cycles)	8.5%	\$68,893	21	Muskoka (Distinct)	\$51,746	21	Trenton (South)	\$62,547
22	North Bay (North)	60 Years (2 Life Cycles)	8.5%	\$69,070	22	North Bay (North)	\$52,006	22	Kingston (South)	\$63,274
23	Sudbury (North)	60 Years (2 Life Cycles)	8.5%	\$70,033	23	Sudbury (North)	\$52,979	23	Thunder Bay (North)	\$65,416
24	Timmins (North)	60 Years (2 Life Cycles)	8.5%	\$71,664	24	Timmins (North)	\$54,604	24	Sudbury (North)	\$65,544
25	Thunder Bay (North)	60 Years (2 Life Cycles)	8.5%	\$71,834	25	Thunder Bay (North)	\$54,743	25	Timmins (North)	\$67,644
26	Kenora (North)	60 Years (2 Life Cycles)	8.5%	\$72,538	26	Kenora (North)	\$55,406	26	Kenora (North)	\$68,417
27	Kapuskasing (North)	60 Years (2 Life Cycles)	8.5%	\$73,521	27	Kapuskasing (North)	\$56,403	27	Kapuskasing (North)	\$72,799

Table F1-1.20: Rankings of cities for carbon taxes scenario (average construction type) at a discount rate of 8.5% (two life cycles of V.GSHP and H.GSHP and five life cycles of Traditional HVAC Applications for a 60 year project lifespan)

FIT – (#2)

Total Present Value										
FIT - (#2)										
#	City	Project Life Span	Discount Rate	V.GSHP	#	City	H.GSHP	#	City	Traditional
1	St. Catharines (South)	60 Years (2 Life Cycles)	8.5%	\$50,815	1	St. Catharines (South)	\$37,020	1	Cambridge (South)	\$44,996
2	Sarnia (South)	60 Years (2 Life Cycles)	8.5%	\$51,130	2	Sarnia (South)	\$37,325	2	Guelph (South)	\$45,615
3	Chatham (South)	60 Years (2 Life Cycles)	8.5%	\$51,208	3	Chatham (South)	\$37,413	3	Chatham (South)	\$46,879
4	Windsor (South)	60 Years (2 Life Cycles)	8.5%	\$51,223	4	Windsor (South)	\$37,432	4	Windsor (South)	\$46,919
5	Niagara Falls (South)	60 Years (2 Life Cycles)	8.5%	\$51,356	5	Niagara Falls (South)	\$37,559	5	Niagara Falls (South)	\$47,758
6	Simcoe (South)	60 Years (2 Life Cycles)	8.5%	\$51,697	6	Simcoe (South)	\$37,909	6	London (South)	\$48,339
7	Hamilton (South)	60 Years (2 Life Cycles)	8.5%	\$51,933	7	Hamilton (South)	\$38,143	7	St. Catharines (South)	\$48,900
8	Cambridge (South)	60 Years (2 Life Cycles)	8.5%	\$52,150	8	London (South)	\$38,356	8	Barrie (Distinct)	\$49,037
9	London (South)	60 Years (2 Life Cycles)	8.5%	\$52,154	9	Cambridge (South)	\$38,363	9	Sarnia (South)	\$49,189
10	Toronto (South)	60 Years (2 Life Cycles)	8.5%	\$52,163	10	Toronto (South)	\$38,383	10	Simcoe (South)	\$49,356
11	Trenton (South)	60 Years (2 Life Cycles)	8.5%	\$52,354	11	Trenton (South)	\$38,552	11	Toronto (South)	\$49,458
12	Guelph (South)	60 Years (2 Life Cycles)	8.5%	\$52,365	12	Guelph (South)	\$38,585	12	Hamilton (South)	\$49,994
13	Mt. Forest (South)	60 Years (2 Life Cycles)	8.5%	\$52,788	13	Kitchener-Waterloo (South)	\$38,726	13	Sault Ste. Marie (North)	\$49,974
14	Sault Ste. Marie (North)	60 Years (2 Life Cycles)	8.5%	\$53,456	14	Mt. Forest (South)	\$39,002	14	Ottawa (Distinct)	\$50,266
15	Kitchener-Waterloo (South)	60 Years (2 Life Cycles)	8.5%	\$61,906	15	Kingston (South)	\$39,008	15	North Bay (North)	\$50,396
16	Barrie (Distinct)	60 Years (2 Life Cycles)	8.5%	\$62,069	16	Warton (South)	\$39,104	16	Muskoka (Distinct)	\$50,797
17	Kingston (South)	60 Years (2 Life Cycles)	8.5%	\$62,149	17	Sault Ste. Marie (North)	\$39,690	17	Mt. Forest (South)	\$50,807
18	Ottawa (Distinct)	60 Years (2 Life Cycles)	8.5%	\$62,252	18	Barrie (Distinct)	\$44,857	18	Kitchener-Waterloo (South)	\$50,842
19	Warton (South)	60 Years (2 Life Cycles)	8.5%	\$62,268	19	Ottawa (Distinct)	\$45,078	19	Peterborough (Distinct)	\$50,895
20	Peterborough (Distinct)	60 Years (2 Life Cycles)	8.5%	\$62,551	20	Peterborough (Distinct)	\$45,374	20	Warton (South)	\$51,801
21	Muskoka (Distinct)	60 Years (2 Life Cycles)	8.5%	\$62,680	21	Muskoka (Distinct)	\$45,471	21	Trenton (South)	\$52,995
22	North Bay (North)	60 Years (2 Life Cycles)	8.5%	\$62,803	22	North Bay (North)	\$45,653	22	Kingston (South)	\$53,438
23	Sudbury (North)	60 Years (2 Life Cycles)	8.5%	\$63,476	23	Sudbury (North)	\$46,333	23	Thunder Bay (North)	\$53,415
24	Timmins (North)	60 Years (2 Life Cycles)	8.5%	\$64,616	24	Timmins (North)	\$47,468	24	Sudbury (North)	\$54,196
25	Thunder Bay (North)	60 Years (2 Life Cycles)	8.5%	\$64,735	25	Thunder Bay (North)	\$47,566	25	Timmins (North)	\$55,060
26	Kenora (North)	60 Years (2 Life Cycles)	8.5%	\$65,227	26	Kenora (North)	\$48,029	26	Kenora (North)	\$56,241
27	Kapuskasing (North)	60 Years (2 Life Cycles)	8.5%	\$65,914	27	Kapuskasing (North)	\$48,726	27	Kapuskasing (North)	\$59,762

Table F1-1.21: Rankings of cities for feed-in tariff scenario (average construction type) at a discount rate of 8.5% (two life cycles of V.GSHP and H.GSHP and five life cycles of Traditional HVAC Applications for a 60 year project lifespan)

Rebates – (#3)

Total Present Value										
Rebates - (#3)										
#	City	Project Life Span	Discount Rate	V.GSHP	#	City	H.GSHP	#	City	Traditional
1	St. Catharines (South)	60 Years (2 Life Cycles)	8.5%	\$50,292	1	St. Catharines (South)	\$36,534	1	Cambridge (South)	\$44,996
2	Sarnia (South)	60 Years (2 Life Cycles)	8.5%	\$50,742	2	Sarnia (South)	\$36,970	2	Guelph (South)	\$45,615
3	Chatham (South)	60 Years (2 Life Cycles)	8.5%	\$50,854	3	Chatham (South)	\$37,096	3	Chatham (South)	\$46,879
4	Windsor (South)	60 Years (2 Life Cycles)	8.5%	\$50,875	4	Windsor (South)	\$37,123	4	Windsor (South)	\$46,919
5	Niagara Falls (South)	60 Years (2 Life Cycles)	8.5%	\$51,065	5	Niagara Falls (South)	\$37,305	5	Niagara Falls (South)	\$47,758
6	Simcoe (South)	60 Years (2 Life Cycles)	8.5%	\$51,554	6	Simcoe (South)	\$37,805	6	London (South)	\$48,339
7	Hamilton (South)	60 Years (2 Life Cycles)	8.5%	\$51,891	7	Hamilton (South)	\$38,141	7	St. Catharines (South)	\$48,900
8	Cambridge (South)	60 Years (2 Life Cycles)	8.5%	\$52,202	8	London (South)	\$38,445	8	Barrie (Distinct)	\$49,037
9	London (South)	60 Years (2 Life Cycles)	8.5%	\$52,207	9	Cambridge (South)	\$38,455	9	Sarnia (South)	\$49,189
10	Toronto (South)	60 Years (2 Life Cycles)	8.5%	\$52,221	10	Toronto (South)	\$38,484	10	Simcoe (South)	\$49,356
11	Trenton (South)	60 Years (2 Life Cycles)	8.5%	\$52,494	11	Trenton (South)	\$38,726	11	Toronto (South)	\$49,458
12	Guelph (South)	60 Years (2 Life Cycles)	8.5%	\$52,510	12	Guelph (South)	\$38,773	12	Hamilton (South)	\$49,994
13	Mt. Forest (South)	60 Years (2 Life Cycles)	8.5%	\$53,115	13	Kitchener-Waterloo (South)	\$38,974	13	Sault Ste. Marie (North)	\$49,974
14	Sault Ste. Marie (North)	60 Years (2 Life Cycles)	8.5%	\$54,070	14	Mt. Forest (South)	\$39,370	14	Ottawa (Distinct)	\$50,266
15	Kitchener-Waterloo (South)	60 Years (2 Life Cycles)	8.5%	\$62,003	15	Kingston (South)	\$39,378	15	North Bay (North)	\$50,396
16	Barrie (Distinct)	60 Years (2 Life Cycles)	8.5%	\$62,235	16	Warton (South)	\$39,515	16	Muskoka (Distinct)	\$50,797
17	Kingston (South)	60 Years (2 Life Cycles)	8.5%	\$62,350	17	Sault Ste. Marie (North)	\$40,355	17	Mt. Forest (South)	\$50,807
18	Ottawa (Distinct)	60 Years (2 Life Cycles)	8.5%	\$62,497	18	Barrie (Distinct)	\$45,084	18	Kitchener-Waterloo (South)	\$50,842
19	Warton (South)	60 Years (2 Life Cycles)	8.5%	\$62,520	19	Ottawa (Distinct)	\$45,400	19	Peterborough (Distinct)	\$50,895
20	Peterborough (Distinct)	60 Years (2 Life Cycles)	8.5%	\$62,926	20	Peterborough (Distinct)	\$45,823	20	Warton (South)	\$51,801
21	Muskoka (Distinct)	60 Years (2 Life Cycles)	8.5%	\$63,110	21	Muskoka (Distinct)	\$45,963	21	Trenton (South)	\$52,995
22	North Bay (North)	60 Years (2 Life Cycles)	8.5%	\$63,286	22	North Bay (North)	\$46,222	22	Kingston (South)	\$53,438
23	Sudbury (North)	60 Years (2 Life Cycles)	8.5%	\$64,250	23	Sudbury (North)	\$47,196	23	Thunder Bay (North)	\$53,415
24	Timmins (North)	60 Years (2 Life Cycles)	8.5%	\$65,880	24	Timmins (North)	\$48,820	24	Sudbury (North)	\$54,196
25	Thunder Bay (North)	60 Years (2 Life Cycles)	8.5%	\$66,051	25	Thunder Bay (North)	\$48,960	25	Timmins (North)	\$55,060
26	Kenora (North)	60 Years (2 Life Cycles)	8.5%	\$66,755	26	Kenora (North)	\$49,623	26	Kenora (North)	\$56,241
27	Kapuskasing (North)	60 Years (2 Life Cycles)	8.5%	\$67,737	27	Kapuskasing (North)	\$50,619	27	Kapuskasing (North)	\$59,762

Table F1-1.22: Rankings of cities for rebates scenario (average construction type) at a discount rate of 8.5% (two life cycles of V.GSHP and H.GSHP and five life cycles of Traditional HVAC Applications for a 60 year project lifespan)

FIT + Rebates – (#4)

Total Present Value										
(FIT+Rebates) - (#4)										
#	City	Project Life Span	Discount Rate	V.GSHP	#	City	H.GSHP	#	City	Traditional
1	St. Catharines (South)	60 Years (2 Life Cycles)	8.5%	\$45,032	1	St. Catharines (South)	\$31,236	1	Cambridge (South)	\$44,996
2	Sarnia (South)	60 Years (2 Life Cycles)	8.5%	\$45,346	2	Sarnia (South)	\$31,541	2	Guelph (South)	\$45,615
3	Chatham (South)	60 Years (2 Life Cycles)	8.5%	\$45,425	3	Chatham (South)	\$31,629	3	Chatham (South)	\$46,879
4	Windsor (South)	60 Years (2 Life Cycles)	8.5%	\$45,439	4	Windsor (South)	\$31,648	4	Windsor (South)	\$46,919
5	Niagara Falls (South)	60 Years (2 Life Cycles)	8.5%	\$45,572	5	Niagara Falls (South)	\$31,776	5	Niagara Falls (South)	\$47,758
6	Simcoe (South)	60 Years (2 Life Cycles)	8.5%	\$45,914	6	Simcoe (South)	\$32,125	6	London (South)	\$48,339
7	Hamilton (South)	60 Years (2 Life Cycles)	8.5%	\$46,149	7	Hamilton (South)	\$32,360	7	St. Catharines (South)	\$48,900
8	Cambridge (South)	60 Years (2 Life Cycles)	8.5%	\$46,366	8	London (South)	\$32,572	8	Barrie (Distinct)	\$49,037
9	London (South)	60 Years (2 Life Cycles)	8.5%	\$46,370	9	Cambridge (South)	\$32,579	9	Sarnia (South)	\$49,189
10	Toronto (South)	60 Years (2 Life Cycles)	8.5%	\$46,380	10	Toronto (South)	\$32,599	10	Simcoe (South)	\$49,356
11	Trenton (South)	60 Years (2 Life Cycles)	8.5%	\$46,571	11	Trenton (South)	\$32,769	11	Toronto (South)	\$49,458
12	Guelph (South)	60 Years (2 Life Cycles)	8.5%	\$46,582	12	Guelph (South)	\$32,801	12	Hamilton (South)	\$49,994
13	Mt. Forest (South)	60 Years (2 Life Cycles)	8.5%	\$47,004	13	Kitchener-Waterloo (South)	\$32,942	13	Sault Ste. Marie (North)	\$49,974
14	Sault Ste. Marie (North)	60 Years (2 Life Cycles)	8.5%	\$47,672	14	Mt. Forest (South)	\$33,219	14	Ottawa (Distinct)	\$50,266
15	Kitchener-Waterloo (South)	60 Years (2 Life Cycles)	8.5%	\$56,122	15	Kingston (South)	\$33,224	15	North Bay (North)	\$50,396
16	Barrie (Distinct)	60 Years (2 Life Cycles)	8.5%	\$56,285	16	Warton (South)	\$33,320	16	Muskoka (Distinct)	\$50,797
17	Kingston (South)	60 Years (2 Life Cycles)	8.5%	\$56,365	17	Sault Ste. Marie (North)	\$33,907	17	Mt. Forest (South)	\$50,807
18	Ottawa (Distinct)	60 Years (2 Life Cycles)	8.5%	\$56,468	18	Barrie (Distinct)	\$39,074	18	Kitchener-Waterloo (South)	\$50,842
19	Warton (South)	60 Years (2 Life Cycles)	8.5%	\$56,484	19	Ottawa (Distinct)	\$39,295	19	Peterborough (Distinct)	\$50,895
20	Peterborough (Distinct)	60 Years (2 Life Cycles)	8.5%	\$56,767	20	Peterborough (Distinct)	\$39,590	20	Warton (South)	\$51,801
21	Muskoka (Distinct)	60 Years (2 Life Cycles)	8.5%	\$56,896	21	Muskoka (Distinct)	\$39,688	21	Trenton (South)	\$52,995
22	North Bay (North)	60 Years (2 Life Cycles)	8.5%	\$57,019	22	North Bay (North)	\$39,869	22	Kingston (South)	\$53,438
23	Sudbury (North)	60 Years (2 Life Cycles)	8.5%	\$57,693	23	Sudbury (North)	\$40,549	23	Thunder Bay (North)	\$53,415
24	Timmins (North)	60 Years (2 Life Cycles)	8.5%	\$58,832	24	Timmins (North)	\$41,685	24	Sudbury (North)	\$54,196
25	Thunder Bay (North)	60 Years (2 Life Cycles)	8.5%	\$58,951	25	Thunder Bay (North)	\$41,782	25	Timmins (North)	\$55,060
26	Kenora (North)	60 Years (2 Life Cycles)	8.5%	\$59,443	26	Kenora (North)	\$42,246	26	Kenora (North)	\$56,241
27	Kapuskasing (North)	60 Years (2 Life Cycles)	8.5%	\$60,130	27	Kapuskasing (North)	\$42,942	27	Kapuskasing (North)	\$59,762

Table F1-1.23: Rankings of cities for feed-in tariff + rebates scenario (average construction type) at a discount rate of 8.5% (two life cycles of V.GSHP and H.GSHP and five life cycles of Traditional HVAC Applications for a 60 year project lifespan)

(FIT + Rebates) + Carbon Taxes – (#5)

Total Present Value										
(FIT+Rebates) + Carbon Taxes - (#5)										
#	City	Project Life Span	Discount Rate	V.GSHP	#	City	H.GSHP	#	City	Traditional
1	St. Catharines (South)	60 Years (2 Life Cycles)	8.5%	\$45,032	1	St. Catharines (South)	\$31,236	1	Cambridge (South)	\$54,463
2	Sarnia (South)	60 Years (2 Life Cycles)	8.5%	\$45,346	2	Sarnia (South)	\$31,541	2	Chatham (South)	\$55,304
3	Chatham (South)	60 Years (2 Life Cycles)	8.5%	\$45,425	3	Chatham (South)	\$31,629	3	Windsor (South)	\$55,368
4	Windsor (South)	60 Years (2 Life Cycles)	8.5%	\$45,439	4	Windsor (South)	\$31,648	4	Guelph (South)	\$55,386
5	Niagara Falls (South)	60 Years (2 Life Cycles)	8.5%	\$45,572	5	Niagara Falls (South)	\$31,776	5	Niagara Falls (South)	\$56,291
6	Simcoe (South)	60 Years (2 Life Cycles)	8.5%	\$45,914	6	Simcoe (South)	\$32,125	6	St. Catharines (South)	\$57,206
7	Hamilton (South)	60 Years (2 Life Cycles)	8.5%	\$46,149	7	Hamilton (South)	\$32,360	7	London (South)	\$57,775
8	Cambridge (South)	60 Years (2 Life Cycles)	8.5%	\$46,366	8	London (South)	\$32,572	8	Sarnia (South)	\$57,849
9	London (South)	60 Years (2 Life Cycles)	8.5%	\$46,370	9	Cambridge (South)	\$32,579	9	Simcoe (South)	\$58,330
10	Toronto (South)	60 Years (2 Life Cycles)	8.5%	\$46,380	10	Toronto (South)	\$32,599	10	Barrie (Distinct)	\$58,761
11	Trenton (South)	60 Years (2 Life Cycles)	8.5%	\$46,571	11	Trenton (South)	\$32,769	11	Toronto (South)	\$58,946
12	Guelph (South)	60 Years (2 Life Cycles)	8.5%	\$46,582	12	Guelph (South)	\$32,801	12	Hamilton (South)	\$59,203
13	Mt. Forest (South)	60 Years (2 Life Cycles)	8.5%	\$47,004	13	Kitchener-Waterloo (South)	\$32,942	13	Ottawa (Distinct)	\$60,240
14	Sault Ste. Marie (North)	60 Years (2 Life Cycles)	8.5%	\$47,672	14	Mt. Forest (South)	\$33,219	14	Kitchener-Waterloo (South)	\$60,631
15	Kitchener-Waterloo (South)	60 Years (2 Life Cycles)	8.5%	\$56,122	15	Kingston (South)	\$33,224	15	Sault Ste. Marie (North)	\$60,721
16	Barrie (Distinct)	60 Years (2 Life Cycles)	8.5%	\$56,285	16	Warton (South)	\$33,320	16	North Bay (North)	\$60,929
17	Kingston (South)	60 Years (2 Life Cycles)	8.5%	\$56,365	17	Sault Ste. Marie (North)	\$33,907	17	Peterborough (Distinct)	\$61,153
18	Ottawa (Distinct)	60 Years (2 Life Cycles)	8.5%	\$56,468	18	Barrie (Distinct)	\$39,074	18	Muskoka (Distinct)	\$61,252
19	Warton (South)	60 Years (2 Life Cycles)	8.5%	\$56,484	19	Ottawa (Distinct)	\$39,295	19	Mt. Forest (South)	\$61,270
20	Peterborough (Distinct)	60 Years (2 Life Cycles)	8.5%	\$56,767	20	Peterborough (Distinct)	\$39,590	20	Warton (South)	\$61,968
21	Muskoka (Distinct)	60 Years (2 Life Cycles)	8.5%	\$56,896	21	Muskoka (Distinct)	\$39,688	21	Trenton (South)	\$62,547
22	North Bay (North)	60 Years (2 Life Cycles)	8.5%	\$57,019	22	North Bay (North)	\$39,869	22	Kingston (South)	\$63,274
23	Sudbury (North)	60 Years (2 Life Cycles)	8.5%	\$57,693	23	Sudbury (North)	\$40,549	23	Thunder Bay (North)	\$65,416
24	Timmins (North)	60 Years (2 Life Cycles)	8.5%	\$58,832	24	Timmins (North)	\$41,685	24	Sudbury (North)	\$65,544
25	Thunder Bay (North)	60 Years (2 Life Cycles)	8.5%	\$58,951	25	Thunder Bay (North)	\$41,782	25	Timmins (North)	\$67,644
26	Kenora (North)	60 Years (2 Life Cycles)	8.5%	\$59,443	26	Kenora (North)	\$42,246	26	Kenora (North)	\$68,417
27	Kapuskasing (North)	60 Years (2 Life Cycles)	8.5%	\$60,130	27	Kapuskasing (North)	\$42,942	27	Kapuskasing (North)	\$72,799

Table F1-1.24: Rankings of cities for feed-in tariff + rebates + carbon tax scenario (average construction type) at a discount rate of 8.5% (two life cycles of V.GSHP and H.GSHP and five life cycles of Traditional HVAC Applications for a 60 year project lifespan)

5. Two Life Cycles of V.GSHP and H.GSHP and Five Life Cycles of Traditional HVAC Applications @ 10% Discount Rate

Base Case Scenario

Total Present Value										
Base Case Scenario										
#	City	Project Life Span	Discount Rate	V.GSHP	#	City	H.GSHP	#	City	Traditional
1	St. Catharines (South)	60 Years (2 Life Cycles)	10%	\$51,447	1	St. Catharines (South)	\$38,305	1	Cambridge (South)	\$38,721
2	Sarnia (South)	60 Years (2 Life Cycles)	10%	\$51,828	2	Sarnia (South)	\$38,674	2	Guelph (South)	\$39,242
3	Chatham (South)	60 Years (2 Life Cycles)	10%	\$51,923	3	Chatham (South)	\$38,781	3	Chatham (South)	\$40,372
4	Windsor (South)	60 Years (2 Life Cycles)	10%	\$51,941	4	Windsor (South)	\$38,804	4	Windsor (South)	\$40,406
5	Niagara Falls (South)	60 Years (2 Life Cycles)	10%	\$52,102	5	Niagara Falls (South)	\$38,959	5	Niagara Falls (South)	\$41,117
6	Simcoe (South)	60 Years (2 Life Cycles)	10%	\$52,516	6	Simcoe (South)	\$39,382	6	London (South)	\$41,600
7	Hamilton (South)	60 Years (2 Life Cycles)	10%	\$52,802	7	Hamilton (South)	\$39,666	7	St. Catharines (South)	\$42,132
8	Cambridge (South)	60 Years (2 Life Cycles)	10%	\$53,065	8	London (South)	\$39,924	8	Barrie (Distinct)	\$42,234
9	London (South)	60 Years (2 Life Cycles)	10%	\$53,070	9	Cambridge (South)	\$39,933	9	Sarnia (South)	\$42,374
10	Toronto (South)	60 Years (2 Life Cycles)	10%	\$53,081	10	Toronto (South)	\$39,957	10	Simcoe (South)	\$42,512
11	Trenton (South)	60 Years (2 Life Cycles)	10%	\$53,313	11	Trenton (South)	\$40,163	11	Toronto (South)	\$42,594
12	Guelph (South)	60 Years (2 Life Cycles)	10%	\$53,326	12	Guelph (South)	\$40,202	12	Hamilton (South)	\$43,050
13	Mt. Forest (South)	60 Years (2 Life Cycles)	10%	\$53,839	13	Kitchener-Waterloo (South)	\$40,373	13	Sault Ste. Marie (North)	\$42,972
14	Sault Ste. Marie (North)	60 Years (2 Life Cycles)	10%	\$54,648	14	Mt. Forest (South)	\$40,708	14	Ottawa (Distinct)	\$43,273
15	Kitchener-Waterloo (South)	60 Years (2 Life Cycles)	10%	\$62,353	15	Kingston (South)	\$40,715	15	North Bay (North)	\$43,378
16	Barrie (Distinct)	60 Years (2 Life Cycles)	10%	\$62,550	16	Warton (South)	\$40,831	16	Muskoka (Distinct)	\$43,718
17	Kingston (South)	60 Years (2 Life Cycles)	10%	\$62,647	17	Sault Ste. Marie (North)	\$41,542	17	Mt. Forest (South)	\$43,727
18	Ottawa (Distinct)	60 Years (2 Life Cycles)	10%	\$62,772	18	Barrie (Distinct)	\$46,162	18	Kitchener-Waterloo (South)	\$43,763
19	Warton (South)	60 Years (2 Life Cycles)	10%	\$62,792	19	Ottawa (Distinct)	\$46,430	19	Peterborough (Distinct)	\$43,804
20	Peterborough (Distinct)	60 Years (2 Life Cycles)	10%	\$63,135	20	Peterborough (Distinct)	\$46,788	20	Warton (South)	\$44,618
21	Muskoka (Distinct)	60 Years (2 Life Cycles)	10%	\$63,291	21	Muskoka (Distinct)	\$46,906	21	Trenton (South)	\$45,681
22	North Bay (North)	60 Years (2 Life Cycles)	10%	\$63,441	22	North Bay (North)	\$47,127	22	Kingston (South)	\$46,054
23	Sudbury (North)	60 Years (2 Life Cycles)	10%	\$64,257	23	Sudbury (North)	\$47,951	23	Thunder Bay (North)	\$45,921
24	Timmins (North)	60 Years (2 Life Cycles)	10%	\$65,638	24	Timmins (North)	\$49,328	24	Sudbury (North)	\$46,635
25	Thunder Bay (North)	60 Years (2 Life Cycles)	10%	\$65,783	25	Thunder Bay (North)	\$49,446	25	Timmins (North)	\$47,310
26	Kenora (North)	60 Years (2 Life Cycles)	10%	\$66,379	26	Kenora (North)	\$50,008	26	Kenora (North)	\$48,360
27	Kapuskasing (North)	60 Years (2 Life Cycles)	10%	\$67,212	27	Kapuskasing (North)	\$50,852	27	Kapuskasing (North)	\$51,381

Table F1-1.25: Rankings of cities for base case scenario (average construction type) at a discount rate of 10% (two life cycles of V.GSHP and H.GSHP and five life cycles of Traditional HVAC Applications for a 60 year project lifespan)

Carbon Taxes – (#1)

Total Present Value										
Carbon Taxes - (#1)										
#	City	Project Life Span	Discount Rate	V.GSHP	#	City	H.GSHP	#	City	Traditional
1	St. Catharines (South)	60 Years (2 Life Cycles)	10%	\$51,447	1	St. Catharines (South)	\$38,305	1	Cambridge (South)	\$45,811
2	Sarnia (South)	60 Years (2 Life Cycles)	10%	\$51,828	2	Sarnia (South)	\$38,674	2	Guelph (South)	\$46,560
3	Chatham (South)	60 Years (2 Life Cycles)	10%	\$51,923	3	Chatham (South)	\$38,781	3	Chatham (South)	\$46,683
4	Windsor (South)	60 Years (2 Life Cycles)	10%	\$51,941	4	Windsor (South)	\$38,804	4	Windsor (South)	\$46,734
5	Niagara Falls (South)	60 Years (2 Life Cycles)	10%	\$52,102	5	Niagara Falls (South)	\$38,959	5	Niagara Falls (South)	\$47,507
6	Simcoe (South)	60 Years (2 Life Cycles)	10%	\$52,516	6	Simcoe (South)	\$39,382	6	St. Catharines (South)	\$48,352
7	Hamilton (South)	60 Years (2 Life Cycles)	10%	\$52,802	7	Hamilton (South)	\$39,666	7	London (South)	\$48,666
8	Cambridge (South)	60 Years (2 Life Cycles)	10%	\$53,065	8	London (South)	\$39,924	8	Sarnia (South)	\$48,859
9	London (South)	60 Years (2 Life Cycles)	10%	\$53,070	9	Cambridge (South)	\$39,933	9	Simcoe (South)	\$49,233
10	Toronto (South)	60 Years (2 Life Cycles)	10%	\$53,081	10	Toronto (South)	\$39,957	10	Barrie (Distinct)	\$49,517
11	Trenton (South)	60 Years (2 Life Cycles)	10%	\$53,313	11	Trenton (South)	\$40,163	11	Toronto (South)	\$49,699
12	Guelph (South)	60 Years (2 Life Cycles)	10%	\$53,326	12	Guelph (South)	\$40,202	12	Hamilton (South)	\$49,947
13	Mt. Forest (South)	60 Years (2 Life Cycles)	10%	\$53,839	13	Kitchener-Waterloo (South)	\$40,373	13	Ottawa (Distinct)	\$50,743
14	Sault Ste. Marie (North)	60 Years (2 Life Cycles)	10%	\$54,648	14	Mt. Forest (South)	\$40,708	14	Sault Ste. Marie (North)	\$51,020
15	Kitchener-Waterloo (South)	60 Years (2 Life Cycles)	10%	\$62,353	15	Kingston (South)	\$40,715	15	Kitchener-Waterloo (South)	\$51,094
16	Barrie (Distinct)	60 Years (2 Life Cycles)	10%	\$62,550	16	Warton (South)	\$40,831	16	North Bay (North)	\$51,266
17	Kingston (South)	60 Years (2 Life Cycles)	10%	\$62,647	17	Sault Ste. Marie (North)	\$41,542	17	Peterborough (Distinct)	\$51,486
18	Ottawa (Distinct)	60 Years (2 Life Cycles)	10%	\$62,772	18	Barrie (Distinct)	\$46,162	18	Muskoka (Distinct)	\$51,548
19	Warton (South)	60 Years (2 Life Cycles)	10%	\$62,792	19	Ottawa (Distinct)	\$46,430	19	Mt. Forest (South)	\$51,563
20	Peterborough (Distinct)	60 Years (2 Life Cycles)	10%	\$63,135	20	Peterborough (Distinct)	\$46,788	20	Warton (South)	\$52,232
21	Muskoka (Distinct)	60 Years (2 Life Cycles)	10%	\$63,291	21	Muskoka (Distinct)	\$46,906	21	Trenton (South)	\$52,835
22	North Bay (North)	60 Years (2 Life Cycles)	10%	\$63,441	22	North Bay (North)	\$47,127	22	Kingston (South)	\$53,420
23	Sudbury (North)	60 Years (2 Life Cycles)	10%	\$64,257	23	Sudbury (North)	\$47,951	23	Thunder Bay (North)	\$54,909
24	Timmins (North)	60 Years (2 Life Cycles)	10%	\$65,638	24	Timmins (North)	\$49,328	24	Sudbury (North)	\$55,134
25	Thunder Bay (North)	60 Years (2 Life Cycles)	10%	\$65,783	25	Thunder Bay (North)	\$49,446	25	Timmins (North)	\$56,734
26	Kenora (North)	60 Years (2 Life Cycles)	10%	\$66,379	26	Kenora (North)	\$50,008	26	Kenora (North)	\$57,478
27	Kapuskasing (North)	60 Years (2 Life Cycles)	10%	\$67,212	27	Kapuskasing (North)	\$50,852	27	Kapuskasing (North)	\$61,144

Table F1-1.26: Rankings of cities for carbon taxes scenario (average construction type) at a discount rate of 10% (two life cycles of V.GSHP and H.GSHP and five life cycles of Traditional HVAC Applications for a 60 year project lifespan)

FIT – (#2)

Total Present Value										
FIT - (#2)										
#	City	Project Life Span	Discount Rate	V.GSHP	#	City	H.GSHP	#	City	Traditional
1	St. Catharines (South)	60 Years (2 Life Cycles)	10%	\$46,957	1	St. Catharines (South)	\$33,783	1	Cambridge (South)	\$38,721
2	Sarnia (South)	60 Years (2 Life Cycles)	10%	\$47,222	2	Sarnia (South)	\$34,041	2	Guelph (South)	\$39,242
3	Chatham (South)	60 Years (2 Life Cycles)	10%	\$47,289	3	Chatham (South)	\$34,115	3	Chatham (South)	\$40,372
4	Windsor (South)	60 Years (2 Life Cycles)	10%	\$47,301	4	Windsor (South)	\$34,131	4	Windsor (South)	\$40,406
5	Niagara Falls (South)	60 Years (2 Life Cycles)	10%	\$47,413	5	Niagara Falls (South)	\$34,239	5	Niagara Falls (South)	\$41,117
6	Simcoe (South)	60 Years (2 Life Cycles)	10%	\$47,702	6	Simcoe (South)	\$34,534	6	London (South)	\$41,600
7	Hamilton (South)	60 Years (2 Life Cycles)	10%	\$47,901	7	Hamilton (South)	\$34,732	7	St. Catharines (South)	\$42,132
8	Cambridge (South)	60 Years (2 Life Cycles)	10%	\$48,084	8	London (South)	\$34,911	8	Barrie (Distinct)	\$42,234
9	London (South)	60 Years (2 Life Cycles)	10%	\$48,087	9	Cambridge (South)	\$34,917	9	Sarnia (South)	\$42,374
10	Toronto (South)	60 Years (2 Life Cycles)	10%	\$48,095	10	Toronto (South)	\$34,934	10	Simcoe (South)	\$42,512
11	Trenton (South)	60 Years (2 Life Cycles)	10%	\$48,257	11	Trenton (South)	\$35,077	11	Toronto (South)	\$42,594
12	Guelph (South)	60 Years (2 Life Cycles)	10%	\$48,266	12	Guelph (South)	\$35,105	12	Hamilton (South)	\$43,050
13	Mt. Forest (South)	60 Years (2 Life Cycles)	10%	\$48,623	13	Kitchener-Waterloo (South)	\$35,224	13	Sault Ste. Marie (North)	\$42,972
14	Sault Ste. Marie (North)	60 Years (2 Life Cycles)	10%	\$49,187	14	Mt. Forest (South)	\$35,457	14	Ottawa (Distinct)	\$43,273
15	Kitchener-Waterloo (South)	60 Years (2 Life Cycles)	10%	\$57,334	15	Kingston (South)	\$35,462	15	North Bay (North)	\$43,378
16	Barrie (Distinct)	60 Years (2 Life Cycles)	10%	\$57,471	16	Warton (South)	\$35,543	16	Muskoka (Distinct)	\$43,718
17	Kingston (South)	60 Years (2 Life Cycles)	10%	\$57,538	17	Sault Ste. Marie (North)	\$36,039	17	Mt. Forest (South)	\$43,727
18	Ottawa (Distinct)	60 Years (2 Life Cycles)	10%	\$57,625	18	Barrie (Distinct)	\$41,032	18	Kitchener-Waterloo (South)	\$43,763
19	Warton (South)	60 Years (2 Life Cycles)	10%	\$57,639	19	Ottawa (Distinct)	\$41,218	19	Peterborough (Distinct)	\$43,804
20	Peterborough (Distinct)	60 Years (2 Life Cycles)	10%	\$57,878	20	Peterborough (Distinct)	\$41,468	20	Warton (South)	\$44,618
21	Muskoka (Distinct)	60 Years (2 Life Cycles)	10%	\$57,987	21	Muskoka (Distinct)	\$41,550	21	Trenton (South)	\$45,681
22	North Bay (North)	60 Years (2 Life Cycles)	10%	\$58,091	22	North Bay (North)	\$41,703	22	Kingston (South)	\$46,054
23	Sudbury (North)	60 Years (2 Life Cycles)	10%	\$58,660	23	Sudbury (North)	\$42,278	23	Thunder Bay (North)	\$45,921
24	Timmins (North)	60 Years (2 Life Cycles)	10%	\$59,622	24	Timmins (North)	\$43,237	24	Sudbury (North)	\$46,635
25	Thunder Bay (North)	60 Years (2 Life Cycles)	10%	\$59,723	25	Thunder Bay (North)	\$43,319	25	Timmins (North)	\$47,310
26	Kenora (North)	60 Years (2 Life Cycles)	10%	\$60,138	26	Kenora (North)	\$43,710	26	Kenora (North)	\$48,360
27	Kapuskasing (North)	60 Years (2 Life Cycles)	10%	\$60,718	27	Kapuskasing (North)	\$44,299	27	Kapuskasing (North)	\$51,381

Table F1-1.27: Rankings of cities for feed-in tariff scenario (average construction type) at a discount rate of 10% (two life cycles of V.GSHP and H.GSHP and five life cycles of Traditional HVAC Applications for a 60 year project lifespan)

Rebates – (#3)

Total Present Value										
Rebates - (#3)										
#	City	Project Life Span	Discount Rate	V.GSHP	#	City	H.GSHP	#	City	Traditional
1	St. Catharines (South)	60 Years (2 Life Cycles)	10%	\$45,928	1	St. Catharines (South)	\$32,786	1	Cambridge (South)	\$38,721
2	Sarnia (South)	60 Years (2 Life Cycles)	10%	\$46,309	2	Sarnia (South)	\$33,155	2	Guelph (South)	\$39,242
3	Chatham (South)	60 Years (2 Life Cycles)	10%	\$46,404	3	Chatham (South)	\$33,262	3	Chatham (South)	\$40,372
4	Windsor (South)	60 Years (2 Life Cycles)	10%	\$46,422	4	Windsor (South)	\$33,285	4	Windsor (South)	\$40,406
5	Niagara Falls (South)	60 Years (2 Life Cycles)	10%	\$46,583	5	Niagara Falls (South)	\$33,439	5	Niagara Falls (South)	\$41,117
6	Simcoe (South)	60 Years (2 Life Cycles)	10%	\$46,997	6	Simcoe (South)	\$33,863	6	London (South)	\$41,600
7	Hamilton (South)	60 Years (2 Life Cycles)	10%	\$47,283	7	Hamilton (South)	\$34,147	7	St. Catharines (South)	\$42,132
8	Cambridge (South)	60 Years (2 Life Cycles)	10%	\$47,546	8	London (South)	\$34,405	8	Barrie (Distinct)	\$42,234
9	London (South)	60 Years (2 Life Cycles)	10%	\$47,551	9	Cambridge (South)	\$34,414	9	Sarnia (South)	\$42,374
10	Toronto (South)	60 Years (2 Life Cycles)	10%	\$47,562	10	Toronto (South)	\$34,438	10	Simcoe (South)	\$42,512
11	Trenton (South)	60 Years (2 Life Cycles)	10%	\$47,794	11	Trenton (South)	\$34,644	11	Toronto (South)	\$42,594
12	Guelph (South)	60 Years (2 Life Cycles)	10%	\$47,807	12	Guelph (South)	\$34,683	12	Hamilton (South)	\$43,050
13	Mt. Forest (South)	60 Years (2 Life Cycles)	10%	\$48,320	13	Kitchener-Waterloo (South)	\$34,854	13	Sault Ste. Marie (North)	\$42,972
14	Sault Ste. Marie (North)	60 Years (2 Life Cycles)	10%	\$49,129	14	Mt. Forest (South)	\$35,189	14	Ottawa (Distinct)	\$43,273
15	Kitchener-Waterloo (South)	60 Years (2 Life Cycles)	10%	\$56,834	15	Kingston (South)	\$35,195	15	North Bay (North)	\$43,378
16	Barrie (Distinct)	60 Years (2 Life Cycles)	10%	\$57,031	16	Warton (South)	\$35,312	16	Muskoka (Distinct)	\$43,718
17	Kingston (South)	60 Years (2 Life Cycles)	10%	\$57,128	17	Sault Ste. Marie (North)	\$36,023	17	Mt. Forest (South)	\$43,727
18	Ottawa (Distinct)	60 Years (2 Life Cycles)	10%	\$57,253	18	Barrie (Distinct)	\$40,643	18	Kitchener-Waterloo (South)	\$43,763
19	Warton (South)	60 Years (2 Life Cycles)	10%	\$57,273	19	Ottawa (Distinct)	\$40,911	19	Peterborough (Distinct)	\$43,804
20	Peterborough (Distinct)	60 Years (2 Life Cycles)	10%	\$57,616	20	Peterborough (Distinct)	\$41,269	20	Warton (South)	\$44,618
21	Muskoka (Distinct)	60 Years (2 Life Cycles)	10%	\$57,772	21	Muskoka (Distinct)	\$41,387	21	Trenton (South)	\$45,681
22	North Bay (North)	60 Years (2 Life Cycles)	10%	\$57,921	22	North Bay (North)	\$41,608	22	Kingston (South)	\$46,054
23	Sudbury (North)	60 Years (2 Life Cycles)	10%	\$58,738	23	Sudbury (North)	\$42,432	23	Thunder Bay (North)	\$45,921
24	Timmins (North)	60 Years (2 Life Cycles)	10%	\$60,119	24	Timmins (North)	\$43,809	24	Sudbury (North)	\$46,635
25	Thunder Bay (North)	60 Years (2 Life Cycles)	10%	\$60,264	25	Thunder Bay (North)	\$43,927	25	Timmins (North)	\$47,310
26	Kenora (North)	60 Years (2 Life Cycles)	10%	\$60,860	26	Kenora (North)	\$44,489	26	Kenora (North)	\$48,360
27	Kapuskasing (North)	60 Years (2 Life Cycles)	10%	\$61,693	27	Kapuskasing (North)	\$45,333	27	Kapuskasing (North)	\$51,381

Table F1-1.28: Rankings of cities for rebates scenario (average construction type) at a discount rate of 10% (two life cycles of V.GSHP and H.GSHP and five life cycles of Traditional HVAC Applications for a 60 year project lifespan)

FIT + Rebates – (#4)

Total Present Value										
(FIT+Rebates) - (#4)										
#	City	Project Life Span	Discount Rate	V.GSHP	#	City	H.GSHP	#	City	Traditional
1	St. Catharines (South)	60 Years (2 Life Cycles)	10%	\$41,438	1	St. Catharines (South)	\$28,264	1	Cambridge (South)	\$38,721
2	Sarnia (South)	60 Years (2 Life Cycles)	10%	\$41,703	2	Sarnia (South)	\$28,522	2	Guelph (South)	\$39,242
3	Chatham (South)	60 Years (2 Life Cycles)	10%	\$41,770	3	Chatham (South)	\$28,596	3	Chatham (South)	\$40,372
4	Windsor (South)	60 Years (2 Life Cycles)	10%	\$41,782	4	Windsor (South)	\$28,612	4	Windsor (South)	\$40,406
5	Niagara Falls (South)	60 Years (2 Life Cycles)	10%	\$41,894	5	Niagara Falls (South)	\$28,720	5	Niagara Falls (South)	\$41,117
6	Simcoe (South)	60 Years (2 Life Cycles)	10%	\$42,183	6	Simcoe (South)	\$29,015	6	London (South)	\$41,600
7	Hamilton (South)	60 Years (2 Life Cycles)	10%	\$42,382	7	Hamilton (South)	\$29,213	7	St. Catharines (South)	\$42,132
8	Cambridge (South)	60 Years (2 Life Cycles)	10%	\$42,565	8	London (South)	\$29,392	8	Barrie (Distinct)	\$42,234
9	London (South)	60 Years (2 Life Cycles)	10%	\$42,568	9	Cambridge (South)	\$29,398	9	Sarnia (South)	\$42,374
10	Toronto (South)	60 Years (2 Life Cycles)	10%	\$42,576	10	Toronto (South)	\$29,415	10	Simcoe (South)	\$42,512
11	Trenton (South)	60 Years (2 Life Cycles)	10%	\$42,738	11	Trenton (South)	\$29,558	11	Toronto (South)	\$42,594
12	Guelph (South)	60 Years (2 Life Cycles)	10%	\$42,747	12	Guelph (South)	\$29,586	12	Hamilton (South)	\$43,050
13	Mt. Forest (South)	60 Years (2 Life Cycles)	10%	\$43,104	13	Kitchener-Waterloo (South)	\$29,705	13	Sault Ste. Marie (North)	\$42,972
14	Sault Ste. Marie (North)	60 Years (2 Life Cycles)	10%	\$43,668	14	Mt. Forest (South)	\$29,938	14	Ottawa (Distinct)	\$43,273
15	Kitchener-Waterloo (South)	60 Years (2 Life Cycles)	10%	\$51,815	15	Kingston (South)	\$29,943	15	North Bay (North)	\$43,378
16	Barrie (Distinct)	60 Years (2 Life Cycles)	10%	\$51,952	16	Warton (South)	\$30,024	16	Muskoka (Distinct)	\$43,718
17	Kingston (South)	60 Years (2 Life Cycles)	10%	\$52,019	17	Sault Ste. Marie (North)	\$30,520	17	Mt. Forest (South)	\$43,727
18	Ottawa (Distinct)	60 Years (2 Life Cycles)	10%	\$52,106	18	Barrie (Distinct)	\$35,513	18	Kitchener-Waterloo (South)	\$43,763
19	Warton (South)	60 Years (2 Life Cycles)	10%	\$52,120	19	Ottawa (Distinct)	\$35,699	19	Peterborough (Distinct)	\$43,804
20	Peterborough (Distinct)	60 Years (2 Life Cycles)	10%	\$52,359	20	Peterborough (Distinct)	\$35,949	20	Warton (South)	\$44,618
21	Muskoka (Distinct)	60 Years (2 Life Cycles)	10%	\$52,468	21	Muskoka (Distinct)	\$36,031	21	Trenton (South)	\$45,681
22	North Bay (North)	60 Years (2 Life Cycles)	10%	\$52,572	22	North Bay (North)	\$36,184	22	Kingston (South)	\$46,054
23	Sudbury (North)	60 Years (2 Life Cycles)	10%	\$53,141	23	Sudbury (North)	\$36,759	23	Thunder Bay (North)	\$45,921
24	Timmins (North)	60 Years (2 Life Cycles)	10%	\$54,103	24	Timmins (North)	\$37,718	24	Sudbury (North)	\$46,635
25	Thunder Bay (North)	60 Years (2 Life Cycles)	10%	\$54,204	25	Thunder Bay (North)	\$37,800	25	Timmins (North)	\$47,310
26	Kenora (North)	60 Years (2 Life Cycles)	10%	\$54,619	26	Kenora (North)	\$38,191	26	Kenora (North)	\$48,360
27	Kapuskasing (North)	60 Years (2 Life Cycles)	10%	\$55,199	27	Kapuskasing (North)	\$38,780	27	Kapuskasing (North)	\$51,381

Table F1-1.29: Rankings of cities for feed-in tariff + rebates scenario (average construction type) at a discount rate of 10% (two life cycles of V.GSHP and H.GSHP and five life cycles of Traditional HVAC Applications for a 60 year project lifespan)

(FIT + Rebates) + Carbon Taxes – (#5)

Total Present Value										
(FIT+Rebates) + Carbon Taxes - (#5)										
#	City	Project Life Span	Discount Rate	V.GSHP	#	City	H.GSHP	#	City	Traditional
1	St. Catharines (South)	60 Years (2 Life Cycles)	10%	\$41,438	1	St. Catharines (South)	\$28,264	1	Cambridge (South)	\$45,811
2	Sarnia (South)	60 Years (2 Life Cycles)	10%	\$41,703	2	Sarnia (South)	\$28,522	2	Guelph (South)	\$46,560
3	Chatham (South)	60 Years (2 Life Cycles)	10%	\$41,770	3	Chatham (South)	\$28,596	3	Chatham (South)	\$46,683
4	Windsor (South)	60 Years (2 Life Cycles)	10%	\$41,782	4	Windsor (South)	\$28,612	4	Windsor (South)	\$46,734
5	Niagara Falls (South)	60 Years (2 Life Cycles)	10%	\$41,894	5	Niagara Falls (South)	\$28,720	5	Niagara Falls (South)	\$47,507
6	Simcoe (South)	60 Years (2 Life Cycles)	10%	\$42,183	6	Simcoe (South)	\$29,015	6	St. Catharines (South)	\$48,352
7	Hamilton (South)	60 Years (2 Life Cycles)	10%	\$42,382	7	Hamilton (South)	\$29,213	7	London (South)	\$48,666
8	Cambridge (South)	60 Years (2 Life Cycles)	10%	\$42,565	8	London (South)	\$29,392	8	Sarnia (South)	\$48,859
9	London (South)	60 Years (2 Life Cycles)	10%	\$42,568	9	Cambridge (South)	\$29,398	9	Simcoe (South)	\$49,233
10	Toronto (South)	60 Years (2 Life Cycles)	10%	\$42,576	10	Toronto (South)	\$29,415	10	Barrie (Distinct)	\$49,517
11	Trenton (South)	60 Years (2 Life Cycles)	10%	\$42,738	11	Trenton (South)	\$29,558	11	Toronto (South)	\$49,699
12	Guelph (South)	60 Years (2 Life Cycles)	10%	\$42,747	12	Guelph (South)	\$29,586	12	Hamilton (South)	\$49,947
13	Mt. Forest (South)	60 Years (2 Life Cycles)	10%	\$43,104	13	Kitchener-Waterloo (South)	\$29,705	13	Ottawa (Distinct)	\$50,743
14	Sault Ste. Marie (North)	60 Years (2 Life Cycles)	10%	\$43,668	14	Mt. Forest (South)	\$29,938	14	Sault Ste. Marie (North)	\$51,020
15	Kitchener-Waterloo (South)	60 Years (2 Life Cycles)	10%	\$51,815	15	Kingston (South)	\$29,943	15	Kitchener-Waterloo (South)	\$51,094
16	Barrie (Distinct)	60 Years (2 Life Cycles)	10%	\$51,952	16	Warton (South)	\$30,024	16	North Bay (North)	\$51,266
17	Kingston (South)	60 Years (2 Life Cycles)	10%	\$52,019	17	Sault Ste. Marie (North)	\$30,520	17	Peterborough (Distinct)	\$51,486
18	Ottawa (Distinct)	60 Years (2 Life Cycles)	10%	\$52,106	18	Barrie (Distinct)	\$35,513	18	Muskoka (Distinct)	\$51,548
19	Warton (South)	60 Years (2 Life Cycles)	10%	\$52,120	19	Ottawa (Distinct)	\$35,699	19	Mt. Forest (South)	\$51,563
20	Peterborough (Distinct)	60 Years (2 Life Cycles)	10%	\$52,359	20	Peterborough (Distinct)	\$35,949	20	Warton (South)	\$52,232
21	Muskoka (Distinct)	60 Years (2 Life Cycles)	10%	\$52,468	21	Muskoka (Distinct)	\$36,031	21	Trenton (South)	\$52,835
22	North Bay (North)	60 Years (2 Life Cycles)	10%	\$52,572	22	North Bay (North)	\$36,184	22	Kingston (South)	\$53,420
23	Sudbury (North)	60 Years (2 Life Cycles)	10%	\$53,141	23	Sudbury (North)	\$36,759	23	Thunder Bay (North)	\$54,909
24	Timmins (North)	60 Years (2 Life Cycles)	10%	\$54,103	24	Timmins (North)	\$37,718	24	Sudbury (North)	\$55,134
25	Thunder Bay (North)	60 Years (2 Life Cycles)	10%	\$54,204	25	Thunder Bay (North)	\$37,800	25	Timmins (North)	\$56,734
26	Kenora (North)	60 Years (2 Life Cycles)	10%	\$54,619	26	Kenora (North)	\$38,191	26	Kenora (North)	\$57,478
27	Kapuskasing (North)	60 Years (2 Life Cycles)	10%	\$55,199	27	Kapuskasing (North)	\$38,780	27	Kapuskasing (North)	\$61,144

Table F1-1.30: Rankings of cities for feed-in tariff + rebates + carbon tax scenario (average construction type) at a discount rate of 10% (two life cycles of V.GSHP and H.GSHP and five life cycles of Traditional HVAC Applications for a 60 year project lifespan)

6. Two Life Cycles of V.GSHP and H.GSHP and Five Life Cycles of Traditional HVAC Applications @ 12% Discount Rate

Base Case Scenario

Total Present Value										
Base Case Scenario										
#	City	Project Life Span	Discount Rate	V.GSHP	#	City	H.GSHP	#	City	Traditional
1	St. Catharines (South)	60 Years (2 Life Cycles)	12%	\$47,281	1	St. Catharines (South)	\$34,641	1	Cambridge (South)	\$32,921
2	Sarnia (South)	60 Years (2 Life Cycles)	12%	\$47,597	2	Sarnia (South)	\$34,948	2	Guelph (South)	\$33,350
3	Chatham (South)	60 Years (2 Life Cycles)	12%	\$47,676	3	Chatham (South)	\$35,036	3	Chatham (South)	\$34,358
4	Windsor (South)	60 Years (2 Life Cycles)	12%	\$47,691	4	Windsor (South)	\$35,055	4	Windsor (South)	\$34,386
5	Niagara Falls (South)	60 Years (2 Life Cycles)	12%	\$47,824	5	Niagara Falls (South)	\$35,183	5	Niagara Falls (South)	\$34,974
6	Simcoe (South)	60 Years (2 Life Cycles)	12%	\$48,167	6	Simcoe (South)	\$35,534	6	London (South)	\$35,367
7	Hamilton (South)	60 Years (2 Life Cycles)	12%	\$48,404	7	Hamilton (South)	\$35,770	7	St. Catharines (South)	\$35,877
8	Cambridge (South)	60 Years (2 Life Cycles)	12%	\$48,622	8	London (South)	\$35,984	8	Barrie (Distinct)	\$35,950
9	London (South)	60 Years (2 Life Cycles)	12%	\$48,626	9	Cambridge (South)	\$35,990	9	Sarnia (South)	\$36,075
10	Toronto (South)	60 Years (2 Life Cycles)	12%	\$48,636	10	Toronto (South)	\$36,011	10	Simcoe (South)	\$36,186
11	Trenton (South)	60 Years (2 Life Cycles)	12%	\$48,828	11	Trenton (South)	\$36,181	11	Toronto (South)	\$36,250
12	Guelph (South)	60 Years (2 Life Cycles)	12%	\$48,838	12	Guelph (South)	\$36,214	12	Hamilton (South)	\$36,631
13	Mt. Forest (South)	60 Years (2 Life Cycles)	12%	\$49,263	13	Kitchener-Waterloo (South)	\$36,355	13	Sault Ste. Marie (North)	\$36,493
14	Sault Ste. Marie (North)	60 Years (2 Life Cycles)	12%	\$49,934	14	Mt. Forest (South)	\$36,633	14	Ottawa (Distinct)	\$36,809
15	Kitchener-Waterloo (South)	60 Years (2 Life Cycles)	12%	\$57,481	15	Kingston (South)	\$36,638	15	North Bay (North)	\$36,891
16	Barrie (Distinct)	60 Years (2 Life Cycles)	12%	\$57,644	16	Warton (South)	\$36,735	16	Muskoka (Distinct)	\$37,174
17	Kingston (South)	60 Years (2 Life Cycles)	12%	\$57,724	17	Sault Ste. Marie (North)	\$37,325	17	Mt. Forest (South)	\$37,181
18	Ottawa (Distinct)	60 Years (2 Life Cycles)	12%	\$57,828	18	Barrie (Distinct)	\$41,878	18	Kitchener-Waterloo (South)	\$37,217
19	Warton (South)	60 Years (2 Life Cycles)	12%	\$57,844	19	Ottawa (Distinct)	\$42,099	19	Peterborough (Distinct)	\$37,246
20	Peterborough (Distinct)	60 Years (2 Life Cycles)	12%	\$58,129	20	Peterborough (Distinct)	\$42,396	20	Warton (South)	\$37,982
21	Muskoka (Distinct)	60 Years (2 Life Cycles)	12%	\$58,258	21	Muskoka (Distinct)	\$42,494	21	Trenton (South)	\$38,928
22	North Bay (North)	60 Years (2 Life Cycles)	12%	\$58,382	22	North Bay (North)	\$42,677	22	Kingston (South)	\$39,235
23	Sudbury (North)	60 Years (2 Life Cycles)	12%	\$59,059	23	Sudbury (North)	\$43,360	23	Thunder Bay (North)	\$38,986
24	Timmins (North)	60 Years (2 Life Cycles)	12%	\$60,203	24	Timmins (North)	\$44,501	24	Sudbury (North)	\$39,644
25	Thunder Bay (North)	60 Years (2 Life Cycles)	12%	\$60,323	25	Thunder Bay (North)	\$44,599	25	Timmins (North)	\$40,132
26	Kenora (North)	60 Years (2 Life Cycles)	12%	\$60,817	26	Kenora (North)	\$45,064	26	Kenora (North)	\$41,066
27	Kapuskasing (North)	60 Years (2 Life Cycles)	12%	\$61,508	27	Kapuskasing (North)	\$45,764	27	Kapuskasing (North)	\$43,622

Table F1-1.31: Rankings of cities for base case scenario (average construction type) at a discount rate of 12% (two life cycles of V.GSHP and H.GSHP and five life cycles of Traditional HVAC Applications for a 60 year project lifespan)

Carbon Taxes – (#1)

Total Present Value										
Carbon Taxes - (#1)										
#	City	Project Life Span	Discount Rate	V.GSHP	#	City	H.GSHP	#	City	Traditional
1	St. Catharines (South)	60 Years (2 Life Cycles)	12%	\$47,281	1	St. Catharines (South)	\$34,641	1	Cambridge (South)	\$38,000
2	Sarnia (South)	60 Years (2 Life Cycles)	12%	\$47,597	2	Sarnia (South)	\$34,948	2	Guelph (South)	\$38,593
3	Chatham (South)	60 Years (2 Life Cycles)	12%	\$47,676	3	Chatham (South)	\$35,036	3	Chatham (South)	\$38,879
4	Windsor (South)	60 Years (2 Life Cycles)	12%	\$47,691	4	Windsor (South)	\$35,055	4	Windsor (South)	\$38,919
5	Niagara Falls (South)	60 Years (2 Life Cycles)	12%	\$47,824	5	Niagara Falls (South)	\$35,183	5	Niagara Falls (South)	\$39,552
6	Simcoe (South)	60 Years (2 Life Cycles)	12%	\$48,167	6	Simcoe (South)	\$35,534	6	St. Catharines (South)	\$40,334
7	Hamilton (South)	60 Years (2 Life Cycles)	12%	\$48,404	7	Hamilton (South)	\$35,770	7	London (South)	\$40,429
8	Cambridge (South)	60 Years (2 Life Cycles)	12%	\$48,622	8	London (South)	\$35,984	8	Sarnia (South)	\$40,721
9	London (South)	60 Years (2 Life Cycles)	12%	\$48,626	9	Cambridge (South)	\$35,990	9	Simcoe (South)	\$41,002
10	Toronto (South)	60 Years (2 Life Cycles)	12%	\$48,636	10	Toronto (South)	\$36,011	10	Barrie (Distinct)	\$41,168
11	Trenton (South)	60 Years (2 Life Cycles)	12%	\$48,828	11	Trenton (South)	\$36,181	11	Toronto (South)	\$41,340
12	Guelph (South)	60 Years (2 Life Cycles)	12%	\$48,838	12	Guelph (South)	\$36,214	12	Hamilton (South)	\$41,572
13	Mt. Forest (South)	60 Years (2 Life Cycles)	12%	\$49,263	13	Kitchener-Waterloo (South)	\$36,355	13	Ottawa (Distinct)	\$42,161
14	Sault Ste. Marie (North)	60 Years (2 Life Cycles)	12%	\$49,934	14	Mt. Forest (South)	\$36,633	14	Sault Ste. Marie (North)	\$42,259
15	Kitchener-Waterloo (South)	60 Years (2 Life Cycles)	12%	\$57,481	15	Kingston (South)	\$36,638	15	Kitchener-Waterloo (South)	\$42,469
16	Barrie (Distinct)	60 Years (2 Life Cycles)	12%	\$57,644	16	Warton (South)	\$36,735	16	North Bay (North)	\$42,542
17	Kingston (South)	60 Years (2 Life Cycles)	12%	\$57,724	17	Sault Ste. Marie (North)	\$37,325	17	Peterborough (Distinct)	\$42,750
18	Ottawa (Distinct)	60 Years (2 Life Cycles)	12%	\$57,828	18	Barrie (Distinct)	\$41,878	18	Muskoka (Distinct)	\$42,784
19	Warton (South)	60 Years (2 Life Cycles)	12%	\$57,844	19	Ottawa (Distinct)	\$42,099	19	Mt. Forest (South)	\$42,795
20	Peterborough (Distinct)	60 Years (2 Life Cycles)	12%	\$58,129	20	Peterborough (Distinct)	\$42,396	20	Warton (South)	\$43,437
21	Muskoka (Distinct)	60 Years (2 Life Cycles)	12%	\$58,258	21	Muskoka (Distinct)	\$42,494	21	Trenton (South)	\$44,053
22	North Bay (North)	60 Years (2 Life Cycles)	12%	\$58,382	22	North Bay (North)	\$42,677	22	Kingston (South)	\$44,512
23	Sudbury (North)	60 Years (2 Life Cycles)	12%	\$59,059	23	Sudbury (North)	\$43,360	23	Thunder Bay (North)	\$45,425
24	Timmins (North)	60 Years (2 Life Cycles)	12%	\$60,203	24	Timmins (North)	\$44,501	24	Sudbury (North)	\$45,732
25	Thunder Bay (North)	60 Years (2 Life Cycles)	12%	\$60,323	25	Thunder Bay (North)	\$44,599	25	Timmins (North)	\$46,884
26	Kenora (North)	60 Years (2 Life Cycles)	12%	\$60,817	26	Kenora (North)	\$45,064	26	Kenora (North)	\$47,599
27	Kapuskasing (North)	60 Years (2 Life Cycles)	12%	\$61,508	27	Kapuskasing (North)	\$45,764	27	Kapuskasing (North)	\$50,617

Table F1-1.32: Rankings of cities for carbon taxes scenario (average construction type) at a discount rate of 12% (two life cycles of V.GSHP and H.GSHP and five life cycles of Traditional HVAC Applications for a 60 year project lifespan)

FIT – (#2)

Total Present Value										
FIT - (#2)										
#	City	Project Life Span	Discount Rate	V.GSHP	#	City	H.GSHP	#	City	Traditional
1	St. Catharines (South)	60 Years (2 Life Cycles)	12%	\$43,531	1	St. Catharines (South)	\$30,865	1	Cambridge (South)	\$32,921
2	Sarnia (South)	60 Years (2 Life Cycles)	12%	\$43,750	2	Sarnia (South)	\$31,078	2	Guelph (South)	\$33,350
3	Chatham (South)	60 Years (2 Life Cycles)	12%	\$43,805	3	Chatham (South)	\$31,139	3	Chatham (South)	\$34,358
4	Windsor (South)	60 Years (2 Life Cycles)	12%	\$43,816	4	Windsor (South)	\$31,153	4	Windsor (South)	\$34,386
5	Niagara Falls (South)	60 Years (2 Life Cycles)	12%	\$43,908	5	Niagara Falls (South)	\$31,241	5	Niagara Falls (South)	\$34,974
6	Simcoe (South)	60 Years (2 Life Cycles)	12%	\$44,146	6	Simcoe (South)	\$31,485	6	London (South)	\$35,367
7	Hamilton (South)	60 Years (2 Life Cycles)	12%	\$44,311	7	Hamilton (South)	\$31,649	7	St. Catharines (South)	\$35,877
8	Cambridge (South)	60 Years (2 Life Cycles)	12%	\$44,462	8	London (South)	\$31,797	8	Barrie (Distinct)	\$35,950
9	London (South)	60 Years (2 Life Cycles)	12%	\$44,465	9	Cambridge (South)	\$31,802	9	Sarnia (South)	\$36,075
10	Toronto (South)	60 Years (2 Life Cycles)	12%	\$44,472	10	Toronto (South)	\$31,816	10	Simcoe (South)	\$36,186
11	Trenton (South)	60 Years (2 Life Cycles)	12%	\$44,605	11	Trenton (South)	\$31,934	11	Toronto (South)	\$36,250
12	Guelph (South)	60 Years (2 Life Cycles)	12%	\$44,612	12	Guelph (South)	\$31,957	12	Hamilton (South)	\$36,631
13	Mt. Forest (South)	60 Years (2 Life Cycles)	12%	\$44,907	13	Kitchener-Waterloo (South)	\$32,055	13	Sault Ste. Marie (North)	\$36,493
14	Sault Ste. Marie (North)	60 Years (2 Life Cycles)	12%	\$45,373	14	Mt. Forest (South)	\$32,248	14	Ottawa (Distinct)	\$36,809
15	Kitchener-Waterloo (South)	60 Years (2 Life Cycles)	12%	\$53,289	15	Kingston (South)	\$32,252	15	North Bay (North)	\$36,891
16	Barrie (Distinct)	60 Years (2 Life Cycles)	12%	\$53,402	16	Warton (South)	\$32,319	16	Muskoka (Distinct)	\$37,174
17	Kingston (South)	60 Years (2 Life Cycles)	12%	\$53,458	17	Sault Ste. Marie (North)	\$32,728	17	Mt. Forest (South)	\$37,181
18	Ottawa (Distinct)	60 Years (2 Life Cycles)	12%	\$53,530	18	Barrie (Distinct)	\$37,593	18	Kitchener-Waterloo (South)	\$37,217
19	Warton (South)	60 Years (2 Life Cycles)	12%	\$53,541	19	Ottawa (Distinct)	\$37,747	19	Peterborough (Distinct)	\$37,246
20	Peterborough (Distinct)	60 Years (2 Life Cycles)	12%	\$53,739	20	Peterborough (Distinct)	\$37,953	20	Warton (South)	\$37,982
21	Muskoka (Distinct)	60 Years (2 Life Cycles)	12%	\$53,828	21	Muskoka (Distinct)	\$38,021	21	Trenton (South)	\$38,928
22	North Bay (North)	60 Years (2 Life Cycles)	12%	\$53,914	22	North Bay (North)	\$38,147	22	Kingston (South)	\$39,235
23	Sudbury (North)	60 Years (2 Life Cycles)	12%	\$54,384	23	Sudbury (North)	\$38,622	23	Thunder Bay (North)	\$38,986
24	Timmins (North)	60 Years (2 Life Cycles)	12%	\$55,179	24	Timmins (North)	\$39,414	24	Sudbury (North)	\$39,644
25	Thunder Bay (North)	60 Years (2 Life Cycles)	12%	\$55,262	25	Thunder Bay (North)	\$39,482	25	Timmins (North)	\$40,132
26	Kenora (North)	60 Years (2 Life Cycles)	12%	\$55,605	26	Kenora (North)	\$39,805	26	Kenora (North)	\$41,066
27	Kapuskasing (North)	60 Years (2 Life Cycles)	12%	\$56,084	27	Kapuskasing (North)	\$40,291	27	Kapuskasing (North)	\$43,622

Table F1-1.33: Rankings of cities for feed-in tariff scenario (average construction type) at a discount rate of 12% (two life cycles of V.GSHP and H.GSHP and five life cycles of Traditional HVAC Applications for a 60 year project lifespan)

Rebates – (#3)

Total Present Value										
Rebates - (#3)										
#	City	Project Life Span	Discount Rate	V.GSHP	#	City	H.GSHP	#	City	Traditional
1	St. Catharines (South)	60 Years (2 Life Cycles)	12%	\$41,979	1	St. Catharines (South)	\$29,339	1	Cambridge (South)	\$32,921
2	Sarnia (South)	60 Years (2 Life Cycles)	12%	\$42,295	2	Sarnia (South)	\$29,645	2	Guelph (South)	\$33,350
3	Chatham (South)	60 Years (2 Life Cycles)	12%	\$42,374	3	Chatham (South)	\$29,734	3	Chatham (South)	\$34,358
4	Windsor (South)	60 Years (2 Life Cycles)	12%	\$42,389	4	Windsor (South)	\$29,753	4	Windsor (South)	\$34,386
5	Niagara Falls (South)	60 Years (2 Life Cycles)	12%	\$42,522	5	Niagara Falls (South)	\$29,881	5	Niagara Falls (South)	\$34,974
6	Simcoe (South)	60 Years (2 Life Cycles)	12%	\$42,865	6	Simcoe (South)	\$30,232	6	London (South)	\$35,367
7	Hamilton (South)	60 Years (2 Life Cycles)	12%	\$43,102	7	Hamilton (South)	\$30,468	7	St. Catharines (South)	\$35,877
8	Cambridge (South)	60 Years (2 Life Cycles)	12%	\$43,320	8	London (South)	\$30,681	8	Barrie (Distinct)	\$35,950
9	London (South)	60 Years (2 Life Cycles)	12%	\$43,324	9	Cambridge (South)	\$30,688	9	Sarnia (South)	\$36,075
10	Toronto (South)	60 Years (2 Life Cycles)	12%	\$43,333	10	Toronto (South)	\$30,709	10	Simcoe (South)	\$36,186
11	Trenton (South)	60 Years (2 Life Cycles)	12%	\$43,525	11	Trenton (South)	\$30,879	11	Toronto (South)	\$36,250
12	Guelph (South)	60 Years (2 Life Cycles)	12%	\$43,536	12	Guelph (South)	\$30,911	12	Hamilton (South)	\$36,631
13	Mt. Forest (South)	60 Years (2 Life Cycles)	12%	\$43,961	13	Kitchener-Waterloo (South)	\$31,053	13	Sault Ste. Marie (North)	\$36,493
14	Sault Ste. Marie (North)	60 Years (2 Life Cycles)	12%	\$44,632	14	Mt. Forest (South)	\$31,331	14	Ottawa (Distinct)	\$36,809
15	Kitchener-Waterloo (South)	60 Years (2 Life Cycles)	12%	\$52,179	15	Kingston (South)	\$31,336	15	North Bay (North)	\$36,891
16	Barrie (Distinct)	60 Years (2 Life Cycles)	12%	\$52,342	16	Warton (South)	\$31,433	16	Muskoka (Distinct)	\$37,174
17	Kingston (South)	60 Years (2 Life Cycles)	12%	\$52,422	17	Sault Ste. Marie (North)	\$32,022	17	Mt. Forest (South)	\$37,181
18	Ottawa (Distinct)	60 Years (2 Life Cycles)	12%	\$52,526	18	Barrie (Distinct)	\$36,575	18	Kitchener-Waterloo (South)	\$37,217
19	Warton (South)	60 Years (2 Life Cycles)	12%	\$52,542	19	Ottawa (Distinct)	\$36,797	19	Peterborough (Distinct)	\$37,246
20	Peterborough (Distinct)	60 Years (2 Life Cycles)	12%	\$52,827	20	Peterborough (Distinct)	\$37,094	20	Warton (South)	\$37,982
21	Muskoka (Distinct)	60 Years (2 Life Cycles)	12%	\$52,956	21	Muskoka (Distinct)	\$37,192	21	Trenton (South)	\$38,928
22	North Bay (North)	60 Years (2 Life Cycles)	12%	\$53,080	22	North Bay (North)	\$37,374	22	Kingston (South)	\$39,235
23	Sudbury (North)	60 Years (2 Life Cycles)	12%	\$53,756	23	Sudbury (North)	\$38,058	23	Thunder Bay (North)	\$38,986
24	Timmins (North)	60 Years (2 Life Cycles)	12%	\$54,901	24	Timmins (North)	\$39,198	24	Sudbury (North)	\$39,644
25	Thunder Bay (North)	60 Years (2 Life Cycles)	12%	\$55,021	25	Thunder Bay (North)	\$39,296	25	Timmins (North)	\$40,132
26	Kenora (North)	60 Years (2 Life Cycles)	12%	\$55,515	26	Kenora (North)	\$39,762	26	Kenora (North)	\$41,066
27	Kapuskasing (North)	60 Years (2 Life Cycles)	12%	\$56,205	27	Kapuskasing (North)	\$40,462	27	Kapuskasing (North)	\$43,622

Table F1-1.34: Rankings of cities for rebates scenario (average construction type) at a discount rate of 12% (two life cycles of V.GSHP and H.GSHP and five life cycles of Traditional HVAC Applications for a 60 year project lifespan)

FIT + Rebates – (#4)

Total Present Value										
(FIT+Rebates) - (#4)										
#	City	Project Life Span	Discount Rate	V.GSHP	#	City	H.GSHP	#	City	Traditional
1	St. Catharines (South)	60 Years (2 Life Cycles)	12%	\$38,229	1	St. Catharines (South)	\$25,563	1	Cambridge (South)	\$32,921
2	Sarnia (South)	60 Years (2 Life Cycles)	12%	\$38,448	2	Sarnia (South)	\$25,776	2	Guelph (South)	\$33,350
3	Chatham (South)	60 Years (2 Life Cycles)	12%	\$38,503	3	Chatham (South)	\$25,837	3	Chatham (South)	\$34,358
4	Windsor (South)	60 Years (2 Life Cycles)	12%	\$38,513	4	Windsor (South)	\$25,850	4	Windsor (South)	\$34,386
5	Niagara Falls (South)	60 Years (2 Life Cycles)	12%	\$38,606	5	Niagara Falls (South)	\$25,939	5	Niagara Falls (South)	\$34,974
6	Simcoe (South)	60 Years (2 Life Cycles)	12%	\$38,844	6	Simcoe (South)	\$26,183	6	London (South)	\$35,367
7	Hamilton (South)	60 Years (2 Life Cycles)	12%	\$39,009	7	Hamilton (South)	\$26,346	7	St. Catharines (South)	\$35,877
8	Cambridge (South)	60 Years (2 Life Cycles)	12%	\$39,160	8	London (South)	\$26,495	8	Barrie (Distinct)	\$35,950
9	London (South)	60 Years (2 Life Cycles)	12%	\$39,163	9	Cambridge (South)	\$26,499	9	Sarnia (South)	\$36,075
10	Toronto (South)	60 Years (2 Life Cycles)	12%	\$39,169	10	Toronto (South)	\$26,514	10	Simcoe (South)	\$36,186
11	Trenton (South)	60 Years (2 Life Cycles)	12%	\$39,303	11	Trenton (South)	\$26,632	11	Toronto (South)	\$36,250
12	Guelph (South)	60 Years (2 Life Cycles)	12%	\$39,310	12	Guelph (South)	\$26,654	12	Hamilton (South)	\$36,631
13	Mt. Forest (South)	60 Years (2 Life Cycles)	12%	\$39,605	13	Kitchener-Waterloo (South)	\$26,753	13	Sault Ste. Marie (North)	\$36,493
14	Sault Ste. Marie (North)	60 Years (2 Life Cycles)	12%	\$40,071	14	Mt. Forest (South)	\$26,946	14	Ottawa (Distinct)	\$36,809
15	Kitchener-Waterloo (South)	60 Years (2 Life Cycles)	12%	\$47,987	15	Kingston (South)	\$26,949	15	North Bay (North)	\$36,891
16	Barrie (Distinct)	60 Years (2 Life Cycles)	12%	\$48,100	16	Warton (South)	\$27,016	16	Muskoka (Distinct)	\$37,174
17	Kingston (South)	60 Years (2 Life Cycles)	12%	\$48,156	17	Sault Ste. Marie (North)	\$27,426	17	Mt. Forest (South)	\$37,181
18	Ottawa (Distinct)	60 Years (2 Life Cycles)	12%	\$48,228	18	Barrie (Distinct)	\$32,290	18	Kitchener-Waterloo (South)	\$37,217
19	Warton (South)	60 Years (2 Life Cycles)	12%	\$48,239	19	Ottawa (Distinct)	\$32,444	19	Peterborough (Distinct)	\$37,246
20	Peterborough (Distinct)	60 Years (2 Life Cycles)	12%	\$48,436	20	Peterborough (Distinct)	\$32,650	20	Warton (South)	\$37,982
21	Muskoka (Distinct)	60 Years (2 Life Cycles)	12%	\$48,526	21	Muskoka (Distinct)	\$32,719	21	Trenton (South)	\$38,928
22	North Bay (North)	60 Years (2 Life Cycles)	12%	\$48,612	22	North Bay (North)	\$32,845	22	Kingston (South)	\$39,235
23	Sudbury (North)	60 Years (2 Life Cycles)	12%	\$49,082	23	Sudbury (North)	\$33,320	23	Thunder Bay (North)	\$38,986
24	Timmins (North)	60 Years (2 Life Cycles)	12%	\$49,877	24	Timmins (North)	\$34,112	24	Sudbury (North)	\$39,644
25	Thunder Bay (North)	60 Years (2 Life Cycles)	12%	\$49,960	25	Thunder Bay (North)	\$34,180	25	Timmins (North)	\$40,132
26	Kenora (North)	60 Years (2 Life Cycles)	12%	\$50,303	26	Kenora (North)	\$34,503	26	Kenora (North)	\$41,066
27	Kapuskasing (North)	60 Years (2 Life Cycles)	12%	\$50,782	27	Kapuskasing (North)	\$34,989	27	Kapuskasing (North)	\$43,622

Table F1-1.35: Rankings of cities for feed-in tariff + rebates scenario (average construction type) at a discount rate of 12% (two life cycles of V.GSHP and H.GSHP and five life cycles of Traditional HVAC Applications for a 60 year project lifespan)

(FIT + Rebates) + Carbon Taxes – (#5)

Total Present Value										
(FIT+Rebates) + Carbon Taxes - (#5)										
#	City	Project Life Span	Discount Rate	V.GSHP	#	City	H.GSHP	#	City	Traditional
1	St. Catharines (South)	60 Years (2 Life Cycles)	12%	\$38,229	1	St. Catharines (South)	\$25,563	1	Cambridge (South)	\$38,000
2	Sarnia (South)	60 Years (2 Life Cycles)	12%	\$38,448	2	Sarnia (South)	\$25,776	2	Guelph (South)	\$38,593
3	Chatham (South)	60 Years (2 Life Cycles)	12%	\$38,503	3	Chatham (South)	\$25,837	3	Chatham (South)	\$38,879
4	Windsor (South)	60 Years (2 Life Cycles)	12%	\$38,513	4	Windsor (South)	\$25,850	4	Windsor (South)	\$38,919
5	Niagara Falls (South)	60 Years (2 Life Cycles)	12%	\$38,606	5	Niagara Falls (South)	\$25,939	5	Niagara Falls (South)	\$39,552
6	Simcoe (South)	60 Years (2 Life Cycles)	12%	\$38,844	6	Simcoe (South)	\$26,183	6	St. Catharines (South)	\$40,334
7	Hamilton (South)	60 Years (2 Life Cycles)	12%	\$39,009	7	Hamilton (South)	\$26,346	7	London (South)	\$40,429
8	Cambridge (South)	60 Years (2 Life Cycles)	12%	\$39,160	8	London (South)	\$26,495	8	Sarnia (South)	\$40,721
9	London (South)	60 Years (2 Life Cycles)	12%	\$39,163	9	Cambridge (South)	\$26,499	9	Simcoe (South)	\$41,002
10	Toronto (South)	60 Years (2 Life Cycles)	12%	\$39,169	10	Toronto (South)	\$26,514	10	Barrie (Distinct)	\$41,168
11	Trenton (South)	60 Years (2 Life Cycles)	12%	\$39,303	11	Trenton (South)	\$26,632	11	Toronto (South)	\$41,340
12	Guelph (South)	60 Years (2 Life Cycles)	12%	\$39,310	12	Guelph (South)	\$26,654	12	Hamilton (South)	\$41,572
13	Mt. Forest (South)	60 Years (2 Life Cycles)	12%	\$39,605	13	Kitchener-Waterloo (South)	\$26,753	13	Ottawa (Distinct)	\$42,161
14	Sault Ste. Marie (North)	60 Years (2 Life Cycles)	12%	\$40,071	14	Mt. Forest (South)	\$26,946	14	Sault Ste. Marie (North)	\$42,259
15	Kitchener-Waterloo (South)	60 Years (2 Life Cycles)	12%	\$47,987	15	Kingston (South)	\$26,949	15	Kitchener-Waterloo (South)	\$42,469
16	Barrie (Distinct)	60 Years (2 Life Cycles)	12%	\$48,100	16	Warton (South)	\$27,016	16	North Bay (North)	\$42,542
17	Kingston (South)	60 Years (2 Life Cycles)	12%	\$48,156	17	Sault Ste. Marie (North)	\$27,426	17	Peterborough (Distinct)	\$42,750
18	Ottawa (Distinct)	60 Years (2 Life Cycles)	12%	\$48,228	18	Barrie (Distinct)	\$32,290	18	Muskoka (Distinct)	\$42,784
19	Warton (South)	60 Years (2 Life Cycles)	12%	\$48,239	19	Ottawa (Distinct)	\$32,444	19	Mt. Forest (South)	\$42,795
20	Peterborough (Distinct)	60 Years (2 Life Cycles)	12%	\$48,436	20	Peterborough (Distinct)	\$32,650	20	Warton (South)	\$43,437
21	Muskoka (Distinct)	60 Years (2 Life Cycles)	12%	\$48,526	21	Muskoka (Distinct)	\$32,719	21	Trenton (South)	\$44,053
22	North Bay (North)	60 Years (2 Life Cycles)	12%	\$48,612	22	North Bay (North)	\$32,845	22	Kingston (South)	\$44,512
23	Sudbury (North)	60 Years (2 Life Cycles)	12%	\$49,082	23	Sudbury (North)	\$33,320	23	Thunder Bay (North)	\$45,425
24	Timmins (North)	60 Years (2 Life Cycles)	12%	\$49,877	24	Timmins (North)	\$34,112	24	Sudbury (North)	\$45,732
25	Thunder Bay (North)	60 Years (2 Life Cycles)	12%	\$49,960	25	Thunder Bay (North)	\$34,180	25	Timmins (North)	\$46,884
26	Kenora (North)	60 Years (2 Life Cycles)	12%	\$50,303	26	Kenora (North)	\$34,503	26	Kenora (North)	\$47,599
27	Kapuskasing (North)	60 Years (2 Life Cycles)	12%	\$50,782	27	Kapuskasing (North)	\$34,989	27	Kapuskasing (North)	\$50,617

Table F1-1.36: Rankings of cities for feed-in tariff + rebates + carbon tax scenario (average construction type) at a discount rate of 12% (two life cycles of V.GSHP and H.GSHP and five life cycles of Traditional HVAC Applications for a 60 year project lifespan)

7. Three Life Cycles of V.GSHP and H.GSHP and Five Life Cycles of Traditional HVAC Applications @ 5% Discount Rate

Base Case Scenario

Total Present Value										
Base Case Scenario										
#	City	Project Life Span	Discount Rate	V.GSHP	#	City	H.GSHP	#	City	Traditional
1	St. Catharines (South)	60 Years (3 Life Cycles)	5%	\$91,901	1	St. Catharines (South)	\$69,620	1	Cambridge (South)	\$73,410
2	Sarnia (South)	60 Years (3 Life Cycles)	5%	\$92,649	2	Sarnia (South)	\$70,346	2	Guelph (South)	\$74,460
3	Chatham (South)	60 Years (3 Life Cycles)	5%	\$92,836	3	Chatham (South)	\$70,555	3	Chatham (South)	\$76,326
4	Windsor (South)	60 Years (3 Life Cycles)	5%	\$92,872	4	Windsor (South)	\$70,600	4	Windsor (South)	\$76,395
5	Niagara Falls (South)	60 Years (3 Life Cycles)	5%	\$93,188	5	Niagara Falls (South)	\$70,903	5	Niagara Falls (South)	\$77,796
6	Simcoe (South)	60 Years (3 Life Cycles)	5%	\$94,000	6	Simcoe (South)	\$71,735	6	London (South)	\$78,824
7	Hamilton (South)	60 Years (3 Life Cycles)	5%	\$94,561	7	Hamilton (South)	\$72,293	7	St. Catharines (South)	\$79,535
8	Cambridge (South)	60 Years (3 Life Cycles)	5%	\$95,077	8	London (South)	\$72,799	8	Barrie (Distinct)	\$79,861
9	London (South)	60 Years (3 Life Cycles)	5%	\$95,086	9	Cambridge (South)	\$72,815	9	Sarnia (South)	\$80,041
10	Toronto (South)	60 Years (3 Life Cycles)	5%	\$95,109	10	Toronto (South)	\$72,863	10	Simcoe (South)	\$80,339
11	Trenton (South)	60 Years (3 Life Cycles)	5%	\$95,564	11	Trenton (South)	\$73,266	11	Toronto (South)	\$80,545
12	Guelph (South)	60 Years (3 Life Cycles)	5%	\$95,589	12	Guelph (South)	\$73,344	12	Hamilton (South)	\$81,417
13	Mt. Forest (South)	60 Years (3 Life Cycles)	5%	\$96,595	13	Kitchener-Waterloo (South)	\$73,679	13	Sault Ste. Marie (North)	\$81,631
14	Sault Ste. Marie (North)	60 Years (3 Life Cycles)	5%	\$98,184	14	Mt. Forest (South)	\$74,337	14	Ottawa (Distinct)	\$81,922
15	Kitchener-Waterloo (South)	60 Years (3 Life Cycles)	5%	\$111,039	15	Kingston (South)	\$74,350	15	North Bay (North)	\$82,176
16	Barrie (Distinct)	60 Years (3 Life Cycles)	5%	\$111,426	16	Warton (South)	\$74,578	16	Muskoka (Distinct)	\$82,837
17	Kingston (South)	60 Years (3 Life Cycles)	5%	\$111,616	17	Sault Ste. Marie (North)	\$75,974	17	Mt. Forest (South)	\$82,855
18	Ottawa (Distinct)	60 Years (3 Life Cycles)	5%	\$111,861	18	Barrie (Distinct)	\$83,653	18	Kitchener-Waterloo (South)	\$82,867
19	Warton (South)	60 Years (3 Life Cycles)	5%	\$111,900	19	Ottawa (Distinct)	\$84,178	19	Peterborough (Distinct)	\$82,988
20	Peterborough (Distinct)	60 Years (3 Life Cycles)	5%	\$112,573	20	Peterborough (Distinct)	\$84,881	20	Warton (South)	\$84,345
21	Muskoka (Distinct)	60 Years (3 Life Cycles)	5%	\$112,880	21	Muskoka (Distinct)	\$85,113	21	Trenton (South)	\$86,144
22	North Bay (North)	60 Years (3 Life Cycles)	5%	\$113,173	22	North Bay (North)	\$85,545	22	Kingston (South)	\$86,900
23	Sudbury (North)	60 Years (3 Life Cycles)	5%	\$114,775	23	Sudbury (North)	\$87,163	23	Thunder Bay (North)	\$87,296
24	Timmins (North)	60 Years (3 Life Cycles)	5%	\$117,486	24	Timmins (North)	\$89,865	24	Sudbury (North)	\$88,408
25	Thunder Bay (North)	60 Years (3 Life Cycles)	5%	\$117,770	25	Thunder Bay (North)	\$90,097	25	Timmins (North)	\$90,072
26	Kenora (North)	60 Years (3 Life Cycles)	5%	\$118,940	26	Kenora (North)	\$91,199	26	Kenora (North)	\$91,865
27	Kapuskasing (North)	60 Years (3 Life Cycles)	5%	\$120,575	27	Kapuskasing (North)	\$92,856	27	Kapuskasing (North)	\$97,635

Table F1-1.37: Rankings of cities for base case scenario (average construction type) at a discount rate of 5% (three life cycles of V.GSHP and H.GSHP and five life cycles of Traditional HVAC Applications for a 60 year project lifespan)

Carbon Taxes – (#1)

Total Present Value										
Carbon Taxes - (#1)										
#	City	Project Life Span	Discount Rate	V.GSHP	#	City	H.GSHP	#	City	Traditional
1	St. Catharines (South)	60 Years (3 Life Cycles)	5%	\$91,901	1	St. Catharines (South)	\$69,620	1	Cambridge (South)	\$95,355
2	Sarnia (South)	60 Years (3 Life Cycles)	5%	\$92,649	2	Sarnia (South)	\$70,346	2	Chatham (South)	\$95,858
3	Chatham (South)	60 Years (3 Life Cycles)	5%	\$92,836	3	Chatham (South)	\$70,555	3	Windsor (South)	\$95,982
4	Windsor (South)	60 Years (3 Life Cycles)	5%	\$92,872	4	Windsor (South)	\$70,600	4	Guelph (South)	\$97,111
5	Niagara Falls (South)	60 Years (3 Life Cycles)	5%	\$93,188	5	Niagara Falls (South)	\$70,903	5	Niagara Falls (South)	\$97,576
6	Simcoe (South)	60 Years (3 Life Cycles)	5%	\$94,000	6	Simcoe (South)	\$71,735	6	St. Catharines (South)	\$98,790
7	Hamilton (South)	60 Years (3 Life Cycles)	5%	\$94,561	7	Hamilton (South)	\$72,293	7	Sarnia (South)	\$100,116
8	Cambridge (South)	60 Years (3 Life Cycles)	5%	\$95,077	8	London (South)	\$72,799	8	London (South)	\$100,697
9	London (South)	60 Years (3 Life Cycles)	5%	\$95,086	9	Cambridge (South)	\$72,815	9	Simcoe (South)	\$101,145
10	Toronto (South)	60 Years (3 Life Cycles)	5%	\$95,109	10	Toronto (South)	\$72,863	10	Barrie (Distinct)	\$102,404
11	Trenton (South)	60 Years (3 Life Cycles)	5%	\$95,564	11	Trenton (South)	\$73,266	11	Toronto (South)	\$102,539
12	Guelph (South)	60 Years (3 Life Cycles)	5%	\$95,589	12	Guelph (South)	\$73,344	12	Hamilton (South)	\$102,765
13	Mt. Forest (South)	60 Years (3 Life Cycles)	5%	\$96,595	13	Kitchener-Waterloo (South)	\$73,679	13	Ottawa (Distinct)	\$105,043
14	Sault Ste. Marie (North)	60 Years (3 Life Cycles)	5%	\$98,184	14	Mt. Forest (South)	\$74,337	14	Kitchener-Waterloo (South)	\$105,560
15	Kitchener-Waterloo (South)	60 Years (3 Life Cycles)	5%	\$111,039	15	Kingston (South)	\$74,350	15	Sault Ste. Marie (North)	\$106,544
16	Barrie (Distinct)	60 Years (3 Life Cycles)	5%	\$111,426	16	Warton (South)	\$74,578	16	North Bay (North)	\$106,594
17	Kingston (South)	60 Years (3 Life Cycles)	5%	\$111,616	17	Sault Ste. Marie (North)	\$75,974	17	Peterborough (Distinct)	\$106,767
18	Ottawa (Distinct)	60 Years (3 Life Cycles)	5%	\$111,861	18	Barrie (Distinct)	\$83,653	18	Muskoka (Distinct)	\$107,075
19	Warton (South)	60 Years (3 Life Cycles)	5%	\$111,900	19	Ottawa (Distinct)	\$84,178	19	Mt. Forest (South)	\$107,110
20	Peterborough (Distinct)	60 Years (3 Life Cycles)	5%	\$112,573	20	Peterborough (Distinct)	\$84,881	20	Warton (South)	\$107,913
21	Muskoka (Distinct)	60 Years (3 Life Cycles)	5%	\$112,880	21	Muskoka (Distinct)	\$85,113	21	Trenton (South)	\$108,288
22	North Bay (North)	60 Years (3 Life Cycles)	5%	\$113,173	22	North Bay (North)	\$85,545	22	Kingston (South)	\$109,702
23	Sudbury (North)	60 Years (3 Life Cycles)	5%	\$114,775	23	Sudbury (North)	\$87,163	23	Sudbury (North)	\$114,714
24	Timmins (North)	60 Years (3 Life Cycles)	5%	\$117,486	24	Timmins (North)	\$89,865	24	Thunder Bay (North)	\$115,117
25	Thunder Bay (North)	60 Years (3 Life Cycles)	5%	\$117,770	25	Thunder Bay (North)	\$90,097	25	Timmins (North)	\$119,244
26	Kenora (North)	60 Years (3 Life Cycles)	5%	\$118,940	26	Kenora (North)	\$91,199	26	Kenora (North)	\$120,089
27	Kapuskasing (North)	60 Years (3 Life Cycles)	5%	\$120,575	27	Kapuskasing (North)	\$92,856	27	Kapuskasing (North)	\$127,857

Table F1-1.38: Rankings of cities for carbon taxes scenario (average construction type) at a discount rate of 5% (three life cycles of V.GSHP and H.GSHP and five life cycles of Traditional HVAC Applications for a 60 year project lifespan)

FIT – (#2)

Total Present Value										
FIT - (#2)										
#	City	Project Life Span	Discount Rate	V.GSHP	#	City	H.GSHP	#	City	Traditional
1	St. Catharines (South)	60 Years (3 Life Cycles)	5%	\$83,374	1	St. Catharines (South)	\$61,033	1	Cambridge (South)	\$73,410
2	Sarnia (South)	60 Years (3 Life Cycles)	5%	\$83,902	2	Sarnia (South)	\$61,545	2	Guelph (South)	\$74,460
3	Chatham (South)	60 Years (3 Life Cycles)	5%	\$84,034	3	Chatham (South)	\$61,693	3	Chatham (South)	\$76,326
4	Windsor (South)	60 Years (3 Life Cycles)	5%	\$84,059	4	Windsor (South)	\$61,725	4	Windsor (South)	\$76,395
5	Niagara Falls (South)	60 Years (3 Life Cycles)	5%	\$84,282	5	Niagara Falls (South)	\$61,939	5	Niagara Falls (South)	\$77,796
6	Simcoe (South)	60 Years (3 Life Cycles)	5%	\$84,856	6	Simcoe (South)	\$62,527	6	London (South)	\$78,824
7	Hamilton (South)	60 Years (3 Life Cycles)	5%	\$85,253	7	Hamilton (South)	\$62,921	7	St. Catharines (South)	\$79,535
8	Cambridge (South)	60 Years (3 Life Cycles)	5%	\$85,617	8	London (South)	\$63,278	8	Barrie (Distinct)	\$79,861
9	London (South)	60 Years (3 Life Cycles)	5%	\$85,624	9	Cambridge (South)	\$63,290	9	Sarnia (South)	\$80,041
10	Toronto (South)	60 Years (3 Life Cycles)	5%	\$85,640	10	Toronto (South)	\$63,324	10	Simcoe (South)	\$80,339
11	Trenton (South)	60 Years (3 Life Cycles)	5%	\$85,961	11	Trenton (South)	\$63,609	11	Toronto (South)	\$80,545
12	Guelph (South)	60 Years (3 Life Cycles)	5%	\$85,979	12	Guelph (South)	\$63,663	12	Hamilton (South)	\$81,417
13	Mt. Forest (South)	60 Years (3 Life Cycles)	5%	\$86,689	13	Kitchener-Waterloo (South)	\$63,900	13	Sault Ste. Marie (North)	\$81,631
14	Sault Ste. Marie (North)	60 Years (3 Life Cycles)	5%	\$87,812	14	Mt. Forest (South)	\$64,365	14	Ottawa (Distinct)	\$81,922
15	Kitchener-Waterloo (South)	60 Years (3 Life Cycles)	5%	\$101,506	15	Kingston (South)	\$64,374	15	North Bay (North)	\$82,176
16	Barrie (Distinct)	60 Years (3 Life Cycles)	5%	\$101,779	16	Warton (South)	\$64,536	16	Muskoka (Distinct)	\$82,837
17	Kingston (South)	60 Years (3 Life Cycles)	5%	\$101,914	17	Sault Ste. Marie (North)	\$65,522	17	Mt. Forest (South)	\$82,855
18	Ottawa (Distinct)	60 Years (3 Life Cycles)	5%	\$102,087	18	Barrie (Distinct)	\$73,909	18	Kitchener-Waterloo (South)	\$82,867
19	Warton (South)	60 Years (3 Life Cycles)	5%	\$102,114	19	Ottawa (Distinct)	\$74,280	19	Peterborough (Distinct)	\$82,988
20	Peterborough (Distinct)	60 Years (3 Life Cycles)	5%	\$102,590	20	Peterborough (Distinct)	\$74,776	20	Warton (South)	\$84,345
21	Muskoka (Distinct)	60 Years (3 Life Cycles)	5%	\$102,806	21	Muskoka (Distinct)	\$74,940	21	Trenton (South)	\$86,144
22	North Bay (North)	60 Years (3 Life Cycles)	5%	\$103,014	22	North Bay (North)	\$75,246	22	Kingston (South)	\$86,900
23	Sudbury (North)	60 Years (3 Life Cycles)	5%	\$104,145	23	Sudbury (North)	\$76,389	23	Thunder Bay (North)	\$87,296
24	Timmins (North)	60 Years (3 Life Cycles)	5%	\$106,061	24	Timmins (North)	\$78,297	24	Sudbury (North)	\$88,408
25	Thunder Bay (North)	60 Years (3 Life Cycles)	5%	\$106,261	25	Thunder Bay (North)	\$78,461	25	Timmins (North)	\$90,072
26	Kenora (North)	60 Years (3 Life Cycles)	5%	\$107,088	26	Kenora (North)	\$79,240	26	Kenora (North)	\$91,865
27	Kapuskasing (North)	60 Years (3 Life Cycles)	5%	\$108,242	27	Kapuskasing (North)	\$80,410	27	Kapuskasing (North)	\$97,635

Table F1-1.39: Rankings of cities for feed-in tariff scenario (average construction type) at a discount rate of 5% (three life cycles of V.GSHP and H.GSHP and five life cycles of Traditional HVAC Applications for a 60 year project lifespan)

Rebates – (#3)

Total Present Value										
Rebates - (#3)										
#	City	Project Life Span	Discount Rate	V.GSHP	#	City	H.GSHP	#	City	Traditional
1	St. Catharines (South)	60 Years (3 Life Cycles)	5%	\$82,533	1	St. Catharines (South)	\$60,252	1	Cambridge (South)	\$73,410
2	Sarnia (South)	60 Years (3 Life Cycles)	5%	\$83,281	2	Sarnia (South)	\$60,977	2	Guelph (South)	\$74,460
3	Chatham (South)	60 Years (3 Life Cycles)	5%	\$83,468	3	Chatham (South)	\$61,187	3	Chatham (South)	\$76,326
4	Windsor (South)	60 Years (3 Life Cycles)	5%	\$83,503	4	Windsor (South)	\$61,232	4	Windsor (South)	\$76,395
5	Niagara Falls (South)	60 Years (3 Life Cycles)	5%	\$83,819	5	Niagara Falls (South)	\$61,535	5	Niagara Falls (South)	\$77,796
6	Simcoe (South)	60 Years (3 Life Cycles)	5%	\$84,632	6	Simcoe (South)	\$62,367	6	London (South)	\$78,824
7	Hamilton (South)	60 Years (3 Life Cycles)	5%	\$85,193	7	Hamilton (South)	\$62,924	7	St. Catharines (South)	\$79,535
8	Cambridge (South)	60 Years (3 Life Cycles)	5%	\$85,708	8	London (South)	\$63,431	8	Barrie (Distinct)	\$79,861
9	London (South)	60 Years (3 Life Cycles)	5%	\$85,718	9	Cambridge (South)	\$63,447	9	Sarnia (South)	\$80,041
10	Toronto (South)	60 Years (3 Life Cycles)	5%	\$85,741	10	Toronto (South)	\$63,495	10	Simcoe (South)	\$80,339
11	Trenton (South)	60 Years (3 Life Cycles)	5%	\$86,195	11	Trenton (South)	\$63,898	11	Toronto (South)	\$80,545
12	Guelph (South)	60 Years (3 Life Cycles)	5%	\$86,221	12	Guelph (South)	\$63,975	12	Hamilton (South)	\$81,417
13	Mt. Forest (South)	60 Years (3 Life Cycles)	5%	\$87,227	13	Kitchener-Waterloo (South)	\$64,311	13	Sault Ste. Marie (North)	\$81,631
14	Sault Ste. Marie (North)	60 Years (3 Life Cycles)	5%	\$88,816	14	Mt. Forest (South)	\$64,968	14	Ottawa (Distinct)	\$81,922
15	Kitchener-Waterloo (South)	60 Years (3 Life Cycles)	5%	\$101,671	15	Kingston (South)	\$64,981	15	North Bay (North)	\$82,176
16	Barrie (Distinct)	60 Years (3 Life Cycles)	5%	\$102,057	16	Warton (South)	\$65,210	16	Muskoka (Distinct)	\$82,837
17	Kingston (South)	60 Years (3 Life Cycles)	5%	\$102,248	17	Sault Ste. Marie (North)	\$66,606	17	Mt. Forest (South)	\$82,855
18	Ottawa (Distinct)	60 Years (3 Life Cycles)	5%	\$102,493	18	Barrie (Distinct)	\$74,284	18	Kitchener-Waterloo (South)	\$82,867
19	Warton (South)	60 Years (3 Life Cycles)	5%	\$102,531	19	Ottawa (Distinct)	\$74,810	19	Peterborough (Distinct)	\$82,988
20	Peterborough (Distinct)	60 Years (3 Life Cycles)	5%	\$103,205	20	Peterborough (Distinct)	\$75,512	20	Warton (South)	\$84,345
21	Muskoka (Distinct)	60 Years (3 Life Cycles)	5%	\$103,511	21	Muskoka (Distinct)	\$75,745	21	Trenton (South)	\$86,144
22	North Bay (North)	60 Years (3 Life Cycles)	5%	\$103,805	22	North Bay (North)	\$76,177	22	Kingston (South)	\$86,900
23	Sudbury (North)	60 Years (3 Life Cycles)	5%	\$105,407	23	Sudbury (North)	\$77,795	23	Thunder Bay (North)	\$87,296
24	Timmins (North)	60 Years (3 Life Cycles)	5%	\$108,118	24	Timmins (North)	\$80,496	24	Sudbury (North)	\$88,408
25	Thunder Bay (North)	60 Years (3 Life Cycles)	5%	\$108,402	25	Thunder Bay (North)	\$80,728	25	Timmins (North)	\$90,072
26	Kenora (North)	60 Years (3 Life Cycles)	5%	\$109,572	26	Kenora (North)	\$81,831	26	Kenora (North)	\$91,865
27	Kapuskasing (North)	60 Years (3 Life Cycles)	5%	\$111,206	27	Kapuskasing (North)	\$83,488	27	Kapuskasing (North)	\$97,635

Table F1-1.40: Rankings of cities for rebates scenario (average construction type) at a discount rate of 5% (three life cycles of V.GSHP and H.GSHP and five life cycles of Traditional HVAC Applications for a 60 year project lifespan)

FIT + Rebates – (#4)

Total Present Value										
(FIT+Rebates) - (#4)										
#	City	Project Life Span	Discount Rate	V.GSHP	#	City	H.GSHP	#	City	Traditional
1	St. Catharines (South)	60 Years (3 Life Cycles)	5%	\$74,005	1	St. Catharines (South)	\$51,665	1	Cambridge (South)	\$73,410
2	Sarnia (South)	60 Years (3 Life Cycles)	5%	\$74,534	2	Sarnia (South)	\$52,177	2	Guelph (South)	\$74,460
3	Chatham (South)	60 Years (3 Life Cycles)	5%	\$74,666	3	Chatham (South)	\$52,325	3	Chatham (South)	\$76,326
4	Windsor (South)	60 Years (3 Life Cycles)	5%	\$74,691	4	Windsor (South)	\$52,357	4	Windsor (South)	\$76,395
5	Niagara Falls (South)	60 Years (3 Life Cycles)	5%	\$74,914	5	Niagara Falls (South)	\$52,571	5	Niagara Falls (South)	\$77,796
6	Simcoe (South)	60 Years (3 Life Cycles)	5%	\$75,488	6	Simcoe (South)	\$53,159	6	London (South)	\$78,824
7	Hamilton (South)	60 Years (3 Life Cycles)	5%	\$75,884	7	Hamilton (South)	\$53,553	7	St. Catharines (South)	\$79,535
8	Cambridge (South)	60 Years (3 Life Cycles)	5%	\$76,248	8	London (South)	\$53,910	8	Barrie (Distinct)	\$79,861
9	London (South)	60 Years (3 Life Cycles)	5%	\$76,255	9	Cambridge (South)	\$53,921	9	Sarnia (South)	\$80,041
10	Toronto (South)	60 Years (3 Life Cycles)	5%	\$76,271	10	Toronto (South)	\$53,956	10	Simcoe (South)	\$80,339
11	Trenton (South)	60 Years (3 Life Cycles)	5%	\$76,592	11	Trenton (South)	\$54,240	11	Toronto (South)	\$80,545
12	Guelph (South)	60 Years (3 Life Cycles)	5%	\$76,611	12	Guelph (South)	\$54,295	12	Hamilton (South)	\$81,417
13	Mt. Forest (South)	60 Years (3 Life Cycles)	5%	\$77,321	13	Kitchener-Waterloo (South)	\$54,532	13	Sault Ste. Marie (North)	\$81,631
14	Sault Ste. Marie (North)	60 Years (3 Life Cycles)	5%	\$78,444	14	Mt. Forest (South)	\$54,996	14	Ottawa (Distinct)	\$81,922
15	Kitchener-Waterloo (South)	60 Years (3 Life Cycles)	5%	\$92,138	15	Kingston (South)	\$55,005	15	North Bay (North)	\$82,176
16	Barrie (Distinct)	60 Years (3 Life Cycles)	5%	\$92,411	16	Warton (South)	\$55,167	16	Muskoka (Distinct)	\$82,837
17	Kingston (South)	60 Years (3 Life Cycles)	5%	\$92,545	17	Sault Ste. Marie (North)	\$56,153	17	Mt. Forest (South)	\$82,855
18	Ottawa (Distinct)	60 Years (3 Life Cycles)	5%	\$92,718	18	Barrie (Distinct)	\$64,540	18	Kitchener-Waterloo (South)	\$82,867
19	Warton (South)	60 Years (3 Life Cycles)	5%	\$92,746	19	Ottawa (Distinct)	\$64,912	19	Peterborough (Distinct)	\$82,988
20	Peterborough (Distinct)	60 Years (3 Life Cycles)	5%	\$93,222	20	Peterborough (Distinct)	\$65,408	20	Warton (South)	\$84,345
21	Muskoka (Distinct)	60 Years (3 Life Cycles)	5%	\$93,438	21	Muskoka (Distinct)	\$65,572	21	Trenton (South)	\$86,144
22	North Bay (North)	60 Years (3 Life Cycles)	5%	\$93,645	22	North Bay (North)	\$65,877	22	Kingston (South)	\$86,900
23	Sudbury (North)	60 Years (3 Life Cycles)	5%	\$94,777	23	Sudbury (North)	\$67,020	23	Thunder Bay (North)	\$87,296
24	Timmins (North)	60 Years (3 Life Cycles)	5%	\$96,692	24	Timmins (North)	\$68,929	24	Sudbury (North)	\$88,408
25	Thunder Bay (North)	60 Years (3 Life Cycles)	5%	\$96,893	25	Thunder Bay (North)	\$69,093	25	Timmins (North)	\$90,072
26	Kenora (North)	60 Years (3 Life Cycles)	5%	\$97,719	26	Kenora (North)	\$69,871	26	Kenora (North)	\$91,865
27	Kapuskasing (North)	60 Years (3 Life Cycles)	5%	\$98,874	27	Kapuskasing (North)	\$71,042	27	Kapuskasing (North)	\$97,635

Table F1-1.41: Rankings of cities for feed-in tariff + rebates scenario (average construction type) at a discount rate of 5% (three life cycles of V.GSHP and H.GSHP and five life cycles of Traditional HVAC Applications for a 60 year project lifespan)

(FIT + Rebates) + Carbon Taxes – (#5)

Total Present Value										
(FIT+Rebates) + Carbon Taxes - (#5)										
#	City	Project Life Span	Discount Rate	V.GSHP	#	City	H.GSHP	#	City	Traditional
1	St. Catharines (South)	60 Years (3 Life Cycles)	5%	\$74,005	1	St. Catharines (South)	\$51,665	1	Cambridge (South)	\$95,355
2	Sarnia (South)	60 Years (3 Life Cycles)	5%	\$74,534	2	Sarnia (South)	\$52,177	2	Chatham (South)	\$95,858
3	Chatham (South)	60 Years (3 Life Cycles)	5%	\$74,666	3	Chatham (South)	\$52,325	3	Windsor (South)	\$95,982
4	Windsor (South)	60 Years (3 Life Cycles)	5%	\$74,691	4	Windsor (South)	\$52,357	4	Guelph (South)	\$97,111
5	Niagara Falls (South)	60 Years (3 Life Cycles)	5%	\$74,914	5	Niagara Falls (South)	\$52,571	5	Niagara Falls (South)	\$97,576
6	Simcoe (South)	60 Years (3 Life Cycles)	5%	\$75,488	6	Simcoe (South)	\$53,159	6	St. Catharines (South)	\$98,790
7	Hamilton (South)	60 Years (3 Life Cycles)	5%	\$75,884	7	Hamilton (South)	\$53,553	7	Sarnia (South)	\$100,116
8	Cambridge (South)	60 Years (3 Life Cycles)	5%	\$76,248	8	London (South)	\$53,910	8	London (South)	\$100,697
9	London (South)	60 Years (3 Life Cycles)	5%	\$76,255	9	Cambridge (South)	\$53,921	9	Simcoe (South)	\$101,145
10	Toronto (South)	60 Years (3 Life Cycles)	5%	\$76,271	10	Toronto (South)	\$53,956	10	Barrie (Distinct)	\$102,404
11	Trenton (South)	60 Years (3 Life Cycles)	5%	\$76,592	11	Trenton (South)	\$54,240	11	Toronto (South)	\$102,539
12	Guelph (South)	60 Years (3 Life Cycles)	5%	\$76,611	12	Guelph (South)	\$54,295	12	Hamilton (South)	\$102,765
13	Mt. Forest (South)	60 Years (3 Life Cycles)	5%	\$77,321	13	Kitchener-Waterloo (South)	\$54,532	13	Ottawa (Distinct)	\$105,043
14	Sault Ste. Marie (North)	60 Years (3 Life Cycles)	5%	\$78,444	14	Mt. Forest (South)	\$54,996	14	Kitchener-Waterloo (South)	\$105,560
15	Kitchener-Waterloo (South)	60 Years (3 Life Cycles)	5%	\$92,138	15	Kingston (South)	\$55,005	15	Sault Ste. Marie (North)	\$106,544
16	Barrie (Distinct)	60 Years (3 Life Cycles)	5%	\$92,411	16	Warton (South)	\$55,167	16	North Bay (North)	\$106,594
17	Kingston (South)	60 Years (3 Life Cycles)	5%	\$92,545	17	Sault Ste. Marie (North)	\$56,153	17	Peterborough (Distinct)	\$106,767
18	Ottawa (Distinct)	60 Years (3 Life Cycles)	5%	\$92,718	18	Barrie (Distinct)	\$64,540	18	Muskoka (Distinct)	\$107,075
19	Warton (South)	60 Years (3 Life Cycles)	5%	\$92,746	19	Ottawa (Distinct)	\$64,912	19	Mt. Forest (South)	\$107,110
20	Peterborough (Distinct)	60 Years (3 Life Cycles)	5%	\$93,222	20	Peterborough (Distinct)	\$65,408	20	Warton (South)	\$107,913
21	Muskoka (Distinct)	60 Years (3 Life Cycles)	5%	\$93,438	21	Muskoka (Distinct)	\$65,572	21	Trenton (South)	\$108,288
22	North Bay (North)	60 Years (3 Life Cycles)	5%	\$93,645	22	North Bay (North)	\$65,877	22	Kingston (South)	\$109,702
23	Sudbury (North)	60 Years (3 Life Cycles)	5%	\$94,777	23	Sudbury (North)	\$67,020	23	Sudbury (North)	\$114,714
24	Timmins (North)	60 Years (3 Life Cycles)	5%	\$96,692	24	Timmins (North)	\$68,929	24	Thunder Bay (North)	\$115,117
25	Thunder Bay (North)	60 Years (3 Life Cycles)	5%	\$96,893	25	Thunder Bay (North)	\$69,093	25	Timmins (North)	\$119,244
26	Kenora (North)	60 Years (3 Life Cycles)	5%	\$97,719	26	Kenora (North)	\$69,871	26	Kenora (North)	\$120,089
27	Kapuskasing (North)	60 Years (3 Life Cycles)	5%	\$98,874	27	Kapuskasing (North)	\$71,042	27	Kapuskasing (North)	\$127,857

Table F1-1.42: Rankings of cities for feed-in tariff + rebates + carbon tax scenario (average construction type) at a discount rate of 5% (three life cycles of V.GSHP and H.GSHP and five life cycles of Traditional HVAC Applications for a 60 year project lifespan)

8. Three Life Cycles of V.GSHP and H.GSHP and Five Life Cycles of Traditional HVAC Applications @ 7% Discount Rate

Base Case Scenario

Total Present Value										
Base Case Scenario										
#	City	Project Life Span	Discount Rate	V.GSHP	#	City	H.GSHP	#	City	Traditional
1	St. Catharines (South)	60 Years (3 Life Cycles)	7%	\$72,213	1	St. Catharines (South)	\$53,984	1	Cambridge (South)	\$53,985
2	Sarnia (South)	60 Years (3 Life Cycles)	7%	\$72,759	2	Sarnia (South)	\$54,513	2	Guelph (South)	\$54,741
3	Chatham (South)	60 Years (3 Life Cycles)	7%	\$72,895	3	Chatham (South)	\$54,666	3	Chatham (South)	\$56,197
4	Windsor (South)	60 Years (3 Life Cycles)	7%	\$72,921	4	Windsor (South)	\$54,699	4	Windsor (South)	\$56,246
5	Niagara Falls (South)	60 Years (3 Life Cycles)	7%	\$73,152	5	Niagara Falls (South)	\$54,920	5	Niagara Falls (South)	\$57,267
6	Simcoe (South)	60 Years (3 Life Cycles)	7%	\$73,744	6	Simcoe (South)	\$55,527	6	London (South)	\$57,988
7	Hamilton (South)	60 Years (3 Life Cycles)	7%	\$74,154	7	Hamilton (South)	\$55,934	7	St. Catharines (South)	\$58,593
8	Cambridge (South)	60 Years (3 Life Cycles)	7%	\$74,530	8	London (South)	\$56,303	8	Barrie (Distinct)	\$58,786
9	London (South)	60 Years (3 Life Cycles)	7%	\$74,537	9	Cambridge (South)	\$56,315	9	Sarnia (South)	\$58,951
10	Toronto (South)	60 Years (3 Life Cycles)	7%	\$74,554	10	Toronto (South)	\$56,350	10	Simcoe (South)	\$59,159
11	Trenton (South)	60 Years (3 Life Cycles)	7%	\$74,885	11	Trenton (South)	\$56,644	11	Toronto (South)	\$59,293
12	Guelph (South)	60 Years (3 Life Cycles)	7%	\$74,904	12	Guelph (South)	\$56,701	12	Hamilton (South)	\$59,938
13	Mt. Forest (South)	60 Years (3 Life Cycles)	7%	\$75,638	13	Kitchener-Waterloo (South)	\$56,946	13	Sault Ste. Marie (North)	\$59,995
14	Sault Ste. Marie (North)	60 Years (3 Life Cycles)	7%	\$76,798	14	Mt. Forest (South)	\$57,426	14	Ottawa (Distinct)	\$60,282
15	Kitchener-Waterloo (South)	60 Years (3 Life Cycles)	7%	\$87,465	15	Kingston (South)	\$57,435	15	North Bay (North)	\$60,449
16	Barrie (Distinct)	60 Years (3 Life Cycles)	7%	\$87,748	16	Warton (South)	\$57,602	16	Muskoka (Distinct)	\$60,935
17	Kingston (South)	60 Years (3 Life Cycles)	7%	\$87,886	17	Sault Ste. Marie (North)	\$58,621	17	Mt. Forest (South)	\$60,947
18	Ottawa (Distinct)	60 Years (3 Life Cycles)	7%	\$88,065	18	Barrie (Distinct)	\$65,018	18	Kitchener-Waterloo (South)	\$60,977
19	Warton (South)	60 Years (3 Life Cycles)	7%	\$88,093	19	Ottawa (Distinct)	\$65,402	19	Peterborough (Distinct)	\$61,051
20	Peterborough (Distinct)	60 Years (3 Life Cycles)	7%	\$88,585	20	Peterborough (Distinct)	\$65,914	20	Warton (South)	\$62,095
21	Muskoka (Distinct)	60 Years (3 Life Cycles)	7%	\$88,809	21	Muskoka (Distinct)	\$66,084	21	Trenton (South)	\$63,478
22	North Bay (North)	60 Years (3 Life Cycles)	7%	\$89,023	22	North Bay (North)	\$66,399	22	Kingston (South)	\$64,021
23	Sudbury (North)	60 Years (3 Life Cycles)	7%	\$90,192	23	Sudbury (North)	\$67,580	23	Thunder Bay (North)	\$64,140
24	Timmins (North)	60 Years (3 Life Cycles)	7%	\$92,170	24	Timmins (North)	\$69,552	24	Sudbury (North)	\$65,022
25	Thunder Bay (North)	60 Years (3 Life Cycles)	7%	\$92,378	25	Thunder Bay (North)	\$69,721	25	Timmins (North)	\$66,147
26	Kenora (North)	60 Years (3 Life Cycles)	7%	\$93,232	26	Kenora (North)	\$70,526	26	Kenora (North)	\$67,519
27	Kapuskasing (North)	60 Years (3 Life Cycles)	7%	\$94,424	27	Kapuskasing (North)	\$71,735	27	Kapuskasing (North)	\$71,753

Table F1-1.43: Rankings of cities for base case scenario (average construction type) at a discount rate of 7% (three life cycles of V.GSHP and H.GSHP and five life cycles of Traditional HVAC Applications for a 60 year project lifespan)

Carbon Taxes – (#1)

Total Present Value										
Carbon Taxes - (#1)										
#	City	Project Life Span	Discount Rate	V.GSHP	#	City	H.GSHP	#	City	Traditional
1	St. Catharines (South)	60 Years (3 Life Cycles)	7%	\$72,213	1	St. Catharines (South)	\$53,984	1	Cambridge (South)	\$67,142
2	Sarnia (South)	60 Years (3 Life Cycles)	7%	\$72,759	2	Sarnia (South)	\$54,513	2	Chatham (South)	\$67,907
3	Chatham (South)	60 Years (3 Life Cycles)	7%	\$72,895	3	Chatham (South)	\$54,666	3	Windsor (South)	\$67,989
4	Windsor (South)	60 Years (3 Life Cycles)	7%	\$72,921	4	Windsor (South)	\$54,699	4	Guelph (South)	\$68,321
5	Niagara Falls (South)	60 Years (3 Life Cycles)	7%	\$73,152	5	Niagara Falls (South)	\$54,920	5	Niagara Falls (South)	\$69,125
6	Simcoe (South)	60 Years (3 Life Cycles)	7%	\$73,744	6	Simcoe (South)	\$55,527	6	St. Catharines (South)	\$70,137
7	Hamilton (South)	60 Years (3 Life Cycles)	7%	\$74,154	7	Hamilton (South)	\$55,934	7	Sarnia (South)	\$70,987
8	Cambridge (South)	60 Years (3 Life Cycles)	7%	\$74,530	8	London (South)	\$56,303	8	London (South)	\$71,101
9	London (South)	60 Years (3 Life Cycles)	7%	\$74,537	9	Cambridge (South)	\$56,315	9	Simcoe (South)	\$71,632
10	Toronto (South)	60 Years (3 Life Cycles)	7%	\$74,554	10	Toronto (South)	\$56,350	10	Barrie (Distinct)	\$72,301
11	Trenton (South)	60 Years (3 Life Cycles)	7%	\$74,885	11	Trenton (South)	\$56,644	11	Toronto (South)	\$72,479
12	Guelph (South)	60 Years (3 Life Cycles)	7%	\$74,904	12	Guelph (South)	\$56,701	12	Hamilton (South)	\$72,737
13	Mt. Forest (South)	60 Years (3 Life Cycles)	7%	\$75,638	13	Kitchener-Waterloo (South)	\$56,946	13	Ottawa (Distinct)	\$74,144
14	Sault Ste. Marie (North)	60 Years (3 Life Cycles)	7%	\$76,798	14	Mt. Forest (South)	\$57,426	14	Kitchener-Waterloo (South)	\$74,583
15	Kitchener-Waterloo (South)	60 Years (3 Life Cycles)	7%	\$87,465	15	Kingston (South)	\$57,435	15	Sault Ste. Marie (North)	\$74,931
16	Barrie (Distinct)	60 Years (3 Life Cycles)	7%	\$87,748	16	Warton (South)	\$57,602	16	North Bay (North)	\$75,089
17	Kingston (South)	60 Years (3 Life Cycles)	7%	\$87,886	17	Sault Ste. Marie (North)	\$58,621	17	Peterborough (Distinct)	\$75,307
18	Ottawa (Distinct)	60 Years (3 Life Cycles)	7%	\$88,065	18	Barrie (Distinct)	\$65,018	18	Muskoka (Distinct)	\$75,466
19	Warton (South)	60 Years (3 Life Cycles)	7%	\$88,093	19	Ottawa (Distinct)	\$65,402	19	Mt. Forest (South)	\$75,489
20	Peterborough (Distinct)	60 Years (3 Life Cycles)	7%	\$88,585	20	Peterborough (Distinct)	\$65,914	20	Warton (South)	\$76,225
21	Muskoka (Distinct)	60 Years (3 Life Cycles)	7%	\$88,809	21	Muskoka (Distinct)	\$66,084	21	Trenton (South)	\$76,754
22	North Bay (North)	60 Years (3 Life Cycles)	7%	\$89,023	22	North Bay (North)	\$66,399	22	Kingston (South)	\$77,691
23	Sudbury (North)	60 Years (3 Life Cycles)	7%	\$90,192	23	Sudbury (North)	\$67,580	23	Sudbury (North)	\$80,794
24	Timmins (North)	60 Years (3 Life Cycles)	7%	\$92,170	24	Timmins (North)	\$69,552	24	Thunder Bay (North)	\$80,819
25	Thunder Bay (North)	60 Years (3 Life Cycles)	7%	\$92,378	25	Thunder Bay (North)	\$69,721	25	Timmins (North)	\$83,637
26	Kenora (North)	60 Years (3 Life Cycles)	7%	\$93,232	26	Kenora (North)	\$70,526	26	Kenora (North)	\$84,441
27	Kapuskasing (North)	60 Years (3 Life Cycles)	7%	\$94,424	27	Kapuskasing (North)	\$71,735	27	Kapuskasing (North)	\$89,872

Table F1-1.44: Rankings of cities for carbon taxes scenario (average construction type) at a discount rate of 7% (three life cycles of V.GSHP and H.GSHP and five life cycles of Traditional HVAC Applications for a 60 year project lifespan)

FIT – (#2)

Total Present Value										
FIT - (#2)										
#	City	Project Life Span	Discount Rate	V.GSHP	#	City	H.GSHP	#	City	Traditional
1	St. Catharines (South)	60 Years (3 Life Cycles)	7%	\$65,888	1	St. Catharines (South)	\$47,615	1	Cambridge (South)	\$53,985
2	Sarnia (South)	60 Years (3 Life Cycles)	7%	\$66,271	2	Sarnia (South)	\$47,986	2	Guelph (South)	\$54,741
3	Chatham (South)	60 Years (3 Life Cycles)	7%	\$66,367	3	Chatham (South)	\$48,093	3	Chatham (South)	\$56,197
4	Windsor (South)	60 Years (3 Life Cycles)	7%	\$66,385	4	Windsor (South)	\$48,117	4	Windsor (South)	\$56,246
5	Niagara Falls (South)	60 Years (3 Life Cycles)	7%	\$66,547	5	Niagara Falls (South)	\$48,272	5	Niagara Falls (South)	\$57,267
6	Simcoe (South)	60 Years (3 Life Cycles)	7%	\$66,963	6	Simcoe (South)	\$48,698	6	London (South)	\$57,988
7	Hamilton (South)	60 Years (3 Life Cycles)	7%	\$67,250	7	Hamilton (South)	\$48,983	7	St. Catharines (South)	\$58,593
8	Cambridge (South)	60 Years (3 Life Cycles)	7%	\$67,514	8	London (South)	\$49,242	8	Barrie (Distinct)	\$58,786
9	London (South)	60 Years (3 Life Cycles)	7%	\$67,519	9	Cambridge (South)	\$49,251	9	Sarnia (South)	\$58,951
10	Toronto (South)	60 Years (3 Life Cycles)	7%	\$67,531	10	Toronto (South)	\$49,275	10	Simcoe (South)	\$59,159
11	Trenton (South)	60 Years (3 Life Cycles)	7%	\$67,763	11	Trenton (South)	\$49,482	11	Toronto (South)	\$59,293
12	Guelph (South)	60 Years (3 Life Cycles)	7%	\$67,777	12	Guelph (South)	\$49,521	12	Hamilton (South)	\$59,938
13	Mt. Forest (South)	60 Years (3 Life Cycles)	7%	\$68,292	13	Kitchener-Waterloo (South)	\$49,693	13	Sault Ste. Marie (North)	\$59,995
14	Sault Ste. Marie (North)	60 Years (3 Life Cycles)	7%	\$69,105	14	Mt. Forest (South)	\$50,030	14	Ottawa (Distinct)	\$60,282
15	Kitchener-Waterloo (South)	60 Years (3 Life Cycles)	7%	\$80,395	15	Kingston (South)	\$50,036	15	North Bay (North)	\$60,449
16	Barrie (Distinct)	60 Years (3 Life Cycles)	7%	\$80,593	16	Warton (South)	\$50,153	16	Muskoka (Distinct)	\$60,935
17	Kingston (South)	60 Years (3 Life Cycles)	7%	\$80,691	17	Sault Ste. Marie (North)	\$50,868	17	Mt. Forest (South)	\$60,947
18	Ottawa (Distinct)	60 Years (3 Life Cycles)	7%	\$80,816	18	Barrie (Distinct)	\$57,791	18	Kitchener-Waterloo (South)	\$60,977
19	Warton (South)	60 Years (3 Life Cycles)	7%	\$80,836	19	Ottawa (Distinct)	\$58,060	19	Peterborough (Distinct)	\$61,051
20	Peterborough (Distinct)	60 Years (3 Life Cycles)	7%	\$81,181	20	Peterborough (Distinct)	\$58,420	20	Warton (South)	\$62,095
21	Muskoka (Distinct)	60 Years (3 Life Cycles)	7%	\$81,338	21	Muskoka (Distinct)	\$58,539	21	Trenton (South)	\$63,478
22	North Bay (North)	60 Years (3 Life Cycles)	7%	\$81,488	22	North Bay (North)	\$58,760	22	Kingston (South)	\$64,021
23	Sudbury (North)	60 Years (3 Life Cycles)	7%	\$82,308	23	Sudbury (North)	\$59,589	23	Thunder Bay (North)	\$64,140
24	Timmins (North)	60 Years (3 Life Cycles)	7%	\$83,696	24	Timmins (North)	\$60,972	24	Sudbury (North)	\$65,022
25	Thunder Bay (North)	60 Years (3 Life Cycles)	7%	\$83,842	25	Thunder Bay (North)	\$61,091	25	Timmins (North)	\$66,147
26	Kenora (North)	60 Years (3 Life Cycles)	7%	\$84,441	26	Kenora (North)	\$61,656	26	Kenora (North)	\$67,519
27	Kapuskasing (North)	60 Years (3 Life Cycles)	7%	\$85,278	27	Kapuskasing (North)	\$62,504	27	Kapuskasing (North)	\$71,753

Table F1-1.45: Rankings of cities for feed-in tariff scenario (average construction type) at a discount rate of 7% (three life cycles of V.GSHP and H.GSHP and five life cycles of Traditional HVAC Applications for a 60 year project lifespan)

Rebates – (#3)

Total Present Value										
Rebates - (#3)										
#	City	Project Life Span	Discount Rate	V.GSHP	#	City	H.GSHP	#	City	Traditional
1	St. Catharines (South)	60 Years (3 Life Cycles)	7%	\$64,556	1	St. Catharines (South)	\$46,326	1	Cambridge (South)	\$53,985
2	Sarnia (South)	60 Years (3 Life Cycles)	7%	\$65,101	2	Sarnia (South)	\$46,856	2	Guelph (South)	\$54,741
3	Chatham (South)	60 Years (3 Life Cycles)	7%	\$65,238	3	Chatham (South)	\$47,009	3	Chatham (South)	\$56,197
4	Windsor (South)	60 Years (3 Life Cycles)	7%	\$65,264	4	Windsor (South)	\$47,042	4	Windsor (South)	\$56,246
5	Niagara Falls (South)	60 Years (3 Life Cycles)	7%	\$65,494	5	Niagara Falls (South)	\$47,263	5	Niagara Falls (South)	\$57,267
6	Simcoe (South)	60 Years (3 Life Cycles)	7%	\$66,087	6	Simcoe (South)	\$47,870	6	London (South)	\$57,988
7	Hamilton (South)	60 Years (3 Life Cycles)	7%	\$66,496	7	Hamilton (South)	\$48,277	7	St. Catharines (South)	\$58,593
8	Cambridge (South)	60 Years (3 Life Cycles)	7%	\$66,873	8	London (South)	\$48,646	8	Barrie (Distinct)	\$58,786
9	London (South)	60 Years (3 Life Cycles)	7%	\$66,880	9	Cambridge (South)	\$48,658	9	Sarnia (South)	\$58,951
10	Toronto (South)	60 Years (3 Life Cycles)	7%	\$66,896	10	Toronto (South)	\$48,693	10	Simcoe (South)	\$59,159
11	Trenton (South)	60 Years (3 Life Cycles)	7%	\$67,228	11	Trenton (South)	\$48,987	11	Toronto (South)	\$59,293
12	Guelph (South)	60 Years (3 Life Cycles)	7%	\$67,247	12	Guelph (South)	\$49,044	12	Hamilton (South)	\$59,938
13	Mt. Forest (South)	60 Years (3 Life Cycles)	7%	\$67,981	13	Kitchener-Waterloo (South)	\$49,288	13	Sault Ste. Marie (North)	\$59,995
14	Sault Ste. Marie (North)	60 Years (3 Life Cycles)	7%	\$69,141	14	Mt. Forest (South)	\$49,768	14	Ottawa (Distinct)	\$60,282
15	Kitchener-Waterloo (South)	60 Years (3 Life Cycles)	7%	\$79,808	15	Kingston (South)	\$49,778	15	North Bay (North)	\$60,449
16	Barrie (Distinct)	60 Years (3 Life Cycles)	7%	\$80,090	16	Warton (South)	\$49,945	16	Muskoka (Distinct)	\$60,935
17	Kingston (South)	60 Years (3 Life Cycles)	7%	\$80,229	17	Sault Ste. Marie (North)	\$50,963	17	Mt. Forest (South)	\$60,947
18	Ottawa (Distinct)	60 Years (3 Life Cycles)	7%	\$80,408	18	Barrie (Distinct)	\$57,361	18	Kitchener-Waterloo (South)	\$60,977
19	Warton (South)	60 Years (3 Life Cycles)	7%	\$80,436	19	Ottawa (Distinct)	\$57,744	19	Peterborough (Distinct)	\$61,051
20	Peterborough (Distinct)	60 Years (3 Life Cycles)	7%	\$80,928	20	Peterborough (Distinct)	\$58,257	20	Warton (South)	\$62,095
21	Muskoka (Distinct)	60 Years (3 Life Cycles)	7%	\$81,151	21	Muskoka (Distinct)	\$58,427	21	Trenton (South)	\$63,478
22	North Bay (North)	60 Years (3 Life Cycles)	7%	\$81,365	22	North Bay (North)	\$58,742	22	Kingston (South)	\$64,021
23	Sudbury (North)	60 Years (3 Life Cycles)	7%	\$82,535	23	Sudbury (North)	\$59,923	23	Thunder Bay (North)	\$64,140
24	Timmins (North)	60 Years (3 Life Cycles)	7%	\$84,513	24	Timmins (North)	\$61,894	24	Sudbury (North)	\$65,022
25	Thunder Bay (North)	60 Years (3 Life Cycles)	7%	\$84,720	25	Thunder Bay (North)	\$62,064	25	Timmins (North)	\$66,147
26	Kenora (North)	60 Years (3 Life Cycles)	7%	\$85,574	26	Kenora (North)	\$62,868	26	Kenora (North)	\$67,519
27	Kapuskasing (North)	60 Years (3 Life Cycles)	7%	\$86,767	27	Kapuskasing (North)	\$64,078	27	Kapuskasing (North)	\$71,753

Table F1-1.46: Rankings of cities for rebates scenario (average construction type) at a discount rate of 7% (three life cycles of V.GSHP and H.GSHP and five life cycles of Traditional HVAC Applications for a 60 year project lifespan)

FIT + Rebates – (#4)

Total Present Value										
(FIT+Rebates) - (#4)										
#	City	Project Life Span	Discount Rate	V.GSHP	#	City	H.GSHP	#	City	Traditional
1	St. Catharines (South)	60 Years (3 Life Cycles)	7%	\$58,231	1	St. Catharines (South)	\$39,957	1	Cambridge (South)	\$53,985
2	Sarnia (South)	60 Years (3 Life Cycles)	7%	\$58,614	2	Sarnia (South)	\$40,329	2	Guelph (South)	\$54,741
3	Chatham (South)	60 Years (3 Life Cycles)	7%	\$58,710	3	Chatham (South)	\$40,436	3	Chatham (South)	\$56,197
4	Windsor (South)	60 Years (3 Life Cycles)	7%	\$58,728	4	Windsor (South)	\$40,459	4	Windsor (South)	\$56,246
5	Niagara Falls (South)	60 Years (3 Life Cycles)	7%	\$58,890	5	Niagara Falls (South)	\$40,614	5	Niagara Falls (South)	\$57,267
6	Simcoe (South)	60 Years (3 Life Cycles)	7%	\$59,305	6	Simcoe (South)	\$41,040	6	London (South)	\$57,988
7	Hamilton (South)	60 Years (3 Life Cycles)	7%	\$59,593	7	Hamilton (South)	\$41,326	7	St. Catharines (South)	\$58,593
8	Cambridge (South)	60 Years (3 Life Cycles)	7%	\$59,857	8	London (South)	\$41,585	8	Barrie (Distinct)	\$58,786
9	London (South)	60 Years (3 Life Cycles)	7%	\$59,862	9	Cambridge (South)	\$41,593	9	Sarnia (South)	\$58,951
10	Toronto (South)	60 Years (3 Life Cycles)	7%	\$59,873	10	Toronto (South)	\$41,618	10	Simcoe (South)	\$59,159
11	Trenton (South)	60 Years (3 Life Cycles)	7%	\$60,106	11	Trenton (South)	\$41,824	11	Toronto (South)	\$59,293
12	Guelph (South)	60 Years (3 Life Cycles)	7%	\$60,119	12	Guelph (South)	\$41,864	12	Hamilton (South)	\$59,938
13	Mt. Forest (South)	60 Years (3 Life Cycles)	7%	\$60,634	13	Kitchener-Waterloo (South)	\$42,036	13	Sault Ste. Marie (North)	\$59,995
14	Sault Ste. Marie (North)	60 Years (3 Life Cycles)	7%	\$61,448	14	Mt. Forest (South)	\$42,372	14	Ottawa (Distinct)	\$60,282
15	Kitchener-Waterloo (South)	60 Years (3 Life Cycles)	7%	\$72,738	15	Kingston (South)	\$42,379	15	North Bay (North)	\$60,449
16	Barrie (Distinct)	60 Years (3 Life Cycles)	7%	\$72,936	16	Warton (South)	\$42,496	16	Muskoka (Distinct)	\$60,935
17	Kingston (South)	60 Years (3 Life Cycles)	7%	\$73,033	17	Sault Ste. Marie (North)	\$43,211	17	Mt. Forest (South)	\$60,947
18	Ottawa (Distinct)	60 Years (3 Life Cycles)	7%	\$73,159	18	Barrie (Distinct)	\$50,134	18	Kitchener-Waterloo (South)	\$60,977
19	Warton (South)	60 Years (3 Life Cycles)	7%	\$73,179	19	Ottawa (Distinct)	\$50,403	19	Peterborough (Distinct)	\$61,051
20	Peterborough (Distinct)	60 Years (3 Life Cycles)	7%	\$73,524	20	Peterborough (Distinct)	\$50,763	20	Warton (South)	\$62,095
21	Muskoka (Distinct)	60 Years (3 Life Cycles)	7%	\$73,680	21	Muskoka (Distinct)	\$50,882	21	Trenton (South)	\$63,478
22	North Bay (North)	60 Years (3 Life Cycles)	7%	\$73,831	22	North Bay (North)	\$51,103	22	Kingston (South)	\$64,021
23	Sudbury (North)	60 Years (3 Life Cycles)	7%	\$74,651	23	Sudbury (North)	\$51,932	23	Thunder Bay (North)	\$64,140
24	Timmins (North)	60 Years (3 Life Cycles)	7%	\$76,039	24	Timmins (North)	\$53,315	24	Sudbury (North)	\$65,022
25	Thunder Bay (North)	60 Years (3 Life Cycles)	7%	\$76,184	25	Thunder Bay (North)	\$53,434	25	Timmins (North)	\$66,147
26	Kenora (North)	60 Years (3 Life Cycles)	7%	\$76,784	26	Kenora (North)	\$53,998	26	Kenora (North)	\$67,519
27	Kapuskasing (North)	60 Years (3 Life Cycles)	7%	\$77,621	27	Kapuskasing (North)	\$54,847	27	Kapuskasing (North)	\$71,753

Table F1-1.47: Rankings of cities for feed-in tariff + rebates scenario (average construction type) at a discount rate of 7% (three life cycles of V.GSHP and H.GSHP and five life cycles of Traditional HVAC Applications for a 60 year project lifespan)

(FIT + Rebates) + Carbon Taxes – (#5)

Total Present Value										
(FIT+Rebates) + Carbon Taxes - (#5)										
#	City	Project Life Span	Discount Rate	V.GSHP	#	City	H.GSHP	#	City	Traditional
1	St. Catharines (South)	60 Years (3 Life Cycles)	7%	\$58,231	1	St. Catharines (South)	\$39,957	1	Cambridge (South)	\$67,142
2	Sarnia (South)	60 Years (3 Life Cycles)	7%	\$58,614	2	Sarnia (South)	\$40,329	2	Chatham (South)	\$67,907
3	Chatham (South)	60 Years (3 Life Cycles)	7%	\$58,710	3	Chatham (South)	\$40,436	3	Windsor (South)	\$67,989
4	Windsor (South)	60 Years (3 Life Cycles)	7%	\$58,728	4	Windsor (South)	\$40,459	4	Guelph (South)	\$68,321
5	Niagara Falls (South)	60 Years (3 Life Cycles)	7%	\$58,890	5	Niagara Falls (South)	\$40,614	5	Niagara Falls (South)	\$69,125
6	Simcoe (South)	60 Years (3 Life Cycles)	7%	\$59,305	6	Simcoe (South)	\$41,040	6	St. Catharines (South)	\$70,137
7	Hamilton (South)	60 Years (3 Life Cycles)	7%	\$59,593	7	Hamilton (South)	\$41,326	7	Sarnia (South)	\$70,987
8	Cambridge (South)	60 Years (3 Life Cycles)	7%	\$59,857	8	London (South)	\$41,585	8	London (South)	\$71,101
9	London (South)	60 Years (3 Life Cycles)	7%	\$59,862	9	Cambridge (South)	\$41,593	9	Simcoe (South)	\$71,632
10	Toronto (South)	60 Years (3 Life Cycles)	7%	\$59,873	10	Toronto (South)	\$41,618	10	Barrie (Distinct)	\$72,301
11	Trenton (South)	60 Years (3 Life Cycles)	7%	\$60,106	11	Trenton (South)	\$41,824	11	Toronto (South)	\$72,479
12	Guelph (South)	60 Years (3 Life Cycles)	7%	\$60,119	12	Guelph (South)	\$41,864	12	Hamilton (South)	\$72,737
13	Mt. Forest (South)	60 Years (3 Life Cycles)	7%	\$60,634	13	Kitchener-Waterloo (South)	\$42,036	13	Ottawa (Distinct)	\$74,144
14	Sault Ste. Marie (North)	60 Years (3 Life Cycles)	7%	\$61,448	14	Mt. Forest (South)	\$42,372	14	Kitchener-Waterloo (South)	\$74,583
15	Kitchener-Waterloo (South)	60 Years (3 Life Cycles)	7%	\$72,738	15	Kingston (South)	\$42,379	15	Sault Ste. Marie (North)	\$74,931
16	Barrie (Distinct)	60 Years (3 Life Cycles)	7%	\$72,936	16	Warton (South)	\$42,496	16	North Bay (North)	\$75,089
17	Kingston (South)	60 Years (3 Life Cycles)	7%	\$73,033	17	Sault Ste. Marie (North)	\$43,211	17	Peterborough (Distinct)	\$75,307
18	Ottawa (Distinct)	60 Years (3 Life Cycles)	7%	\$73,159	18	Barrie (Distinct)	\$50,134	18	Muskoka (Distinct)	\$75,466
19	Warton (South)	60 Years (3 Life Cycles)	7%	\$73,179	19	Ottawa (Distinct)	\$50,403	19	Mt. Forest (South)	\$75,489
20	Peterborough (Distinct)	60 Years (3 Life Cycles)	7%	\$73,524	20	Peterborough (Distinct)	\$50,763	20	Warton (South)	\$76,225
21	Muskoka (Distinct)	60 Years (3 Life Cycles)	7%	\$73,680	21	Muskoka (Distinct)	\$50,882	21	Trenton (South)	\$76,754
22	North Bay (North)	60 Years (3 Life Cycles)	7%	\$73,831	22	North Bay (North)	\$51,103	22	Kingston (South)	\$77,691
23	Sudbury (North)	60 Years (3 Life Cycles)	7%	\$74,651	23	Sudbury (North)	\$51,932	23	Sudbury (North)	\$80,794
24	Timmins (North)	60 Years (3 Life Cycles)	7%	\$76,039	24	Timmins (North)	\$53,315	24	Thunder Bay (North)	\$80,819
25	Thunder Bay (North)	60 Years (3 Life Cycles)	7%	\$76,184	25	Thunder Bay (North)	\$53,434	25	Timmins (North)	\$83,637
26	Kenora (North)	60 Years (3 Life Cycles)	7%	\$76,784	26	Kenora (North)	\$53,998	26	Kenora (North)	\$84,441
27	Kapuskasing (North)	60 Years (3 Life Cycles)	7%	\$77,621	27	Kapuskasing (North)	\$54,847	27	Kapuskasing (North)	\$89,872

Table F1-1.48: Rankings of cities for feed-in tariff + rebates + carbon tax scenario (average construction type) at a discount rate of 7% (three life cycles of V.GSHP and H.GSHP and five life cycles of Traditional HVAC Applications for a 60 year project lifespan)

9. Three Life Cycles of V.GSHP and H.GSHP and Five Life Cycles of Traditional HVAC Applications @ 7.5% Discount Rate

Base Case Scenario

Total Present Value										
Base Case Scenario										
#	City	Project Life Span	Discount Rate	V.GSHP	#	City	H.GSHP	#	City	Traditional
1	St. Catharines (South)	60 Years (3 Life Cycles)	7.5%	\$68,771	1	St. Catharines (South)	\$51,243	1	Cambridge (South)	\$50,600
2	Sarnia (South)	60 Years (3 Life Cycles)	7.5%	\$69,281	2	Sarnia (South)	\$51,737	2	Guelph (South)	\$51,305
3	Chatham (South)	60 Years (3 Life Cycles)	7.5%	\$69,408	3	Chatham (South)	\$51,880	3	Chatham (South)	\$52,688
4	Windsor (South)	60 Years (3 Life Cycles)	7.5%	\$69,432	4	Windsor (South)	\$51,911	4	Windsor (South)	\$52,734
5	Niagara Falls (South)	60 Years (3 Life Cycles)	7.5%	\$69,648	5	Niagara Falls (South)	\$52,118	5	Niagara Falls (South)	\$53,687
6	Simcoe (South)	60 Years (3 Life Cycles)	7.5%	\$70,201	6	Simcoe (South)	\$52,685	6	London (South)	\$54,355
7	Hamilton (South)	60 Years (3 Life Cycles)	7.5%	\$70,584	7	Hamilton (South)	\$53,065	7	St. Catharines (South)	\$54,943
8	Cambridge (South)	60 Years (3 Life Cycles)	7.5%	\$70,936	8	London (South)	\$53,410	8	Barrie (Distinct)	\$55,115
9	London (South)	60 Years (3 Life Cycles)	7.5%	\$70,942	9	Cambridge (South)	\$53,421	9	Sarnia (South)	\$55,275
10	Toronto (South)	60 Years (3 Life Cycles)	7.5%	\$70,957	10	Toronto (South)	\$53,454	10	Simcoe (South)	\$55,468
11	Trenton (South)	60 Years (3 Life Cycles)	7.5%	\$71,267	11	Trenton (South)	\$53,729	11	Toronto (South)	\$55,590
12	Guelph (South)	60 Years (3 Life Cycles)	7.5%	\$71,285	12	Guelph (South)	\$53,781	12	Hamilton (South)	\$56,194
13	Mt. Forest (South)	60 Years (3 Life Cycles)	7.5%	\$71,971	13	Kitchener-Waterloo (South)	\$54,010	13	Sault Ste. Marie (North)	\$56,222
14	Sault Ste. Marie (North)	60 Years (3 Life Cycles)	7.5%	\$73,054	14	Mt. Forest (South)	\$54,458	14	Ottawa (Distinct)	\$56,511
15	Kitchener-Waterloo (South)	60 Years (3 Life Cycles)	7.5%	\$83,347	15	Kingston (South)	\$54,467	15	North Bay (North)	\$56,664
16	Barrie (Distinct)	60 Years (3 Life Cycles)	7.5%	\$83,610	16	Warton (South)	\$54,623	16	Muskoka (Distinct)	\$57,118
17	Kingston (South)	60 Years (3 Life Cycles)	7.5%	\$83,740	17	Sault Ste. Marie (North)	\$55,575	17	Mt. Forest (South)	\$57,129
18	Ottawa (Distinct)	60 Years (3 Life Cycles)	7.5%	\$83,907	18	Barrie (Distinct)	\$61,754	18	Kitchener-Waterloo (South)	\$57,161
19	Warton (South)	60 Years (3 Life Cycles)	7.5%	\$83,934	19	Ottawa (Distinct)	\$62,112	19	Peterborough (Distinct)	\$57,227
20	Peterborough (Distinct)	60 Years (3 Life Cycles)	7.5%	\$84,393	20	Peterborough (Distinct)	\$62,592	20	Warton (South)	\$58,218
21	Muskoka (Distinct)	60 Years (3 Life Cycles)	7.5%	\$84,602	21	Muskoka (Distinct)	\$62,750	21	Trenton (South)	\$59,530
22	North Bay (North)	60 Years (3 Life Cycles)	7.5%	\$84,802	22	North Bay (North)	\$63,044	22	Kingston (South)	\$60,035
23	Sudbury (North)	60 Years (3 Life Cycles)	7.5%	\$85,894	23	Sudbury (North)	\$64,148	23	Thunder Bay (North)	\$60,102
24	Timmins (North)	60 Years (3 Life Cycles)	7.5%	\$87,742	24	Timmins (North)	\$65,989	24	Sudbury (North)	\$60,946
25	Thunder Bay (North)	60 Years (3 Life Cycles)	7.5%	\$87,936	25	Thunder Bay (North)	\$66,148	25	Timmins (North)	\$61,974
26	Kenora (North)	60 Years (3 Life Cycles)	7.5%	\$88,734	26	Kenora (North)	\$66,899	26	Kenora (North)	\$63,273
27	Kapuskasing (North)	60 Years (3 Life Cycles)	7.5%	\$89,848	27	Kapuskasing (North)	\$68,029	27	Kapuskasing (North)	\$67,240

Table F1-1.49: Rankings of cities for base case scenario (average construction type) at a discount rate of 7.5% (three life cycles of V.GSHP and H.GSHP and five life cycles of Traditional HVAC Applications for a 60 year project lifespan)

Carbon Taxes – (#1)

Total Present Value										
Carbon Taxes - (#1)										
#	City	Project Life Span	Discount Rate	V.GSHP	#	City	H.GSHP	#	City	Traditional
1	St. Catharines (South)	60 Years (3 Life Cycles)	7.5%	\$68,771	1	St. Catharines (South)	\$51,243	1	Cambridge (South)	\$62,333
2	Sarnia (South)	60 Years (3 Life Cycles)	7.5%	\$69,281	2	Sarnia (South)	\$51,737	2	Chatham (South)	\$63,131
3	Chatham (South)	60 Years (3 Life Cycles)	7.5%	\$69,408	3	Chatham (South)	\$51,880	3	Windsor (South)	\$63,206
4	Windsor (South)	60 Years (3 Life Cycles)	7.5%	\$69,432	4	Windsor (South)	\$51,911	4	Guelph (South)	\$63,415
5	Niagara Falls (South)	60 Years (3 Life Cycles)	7.5%	\$69,648	5	Niagara Falls (South)	\$52,118	5	Niagara Falls (South)	\$64,262
6	Simcoe (South)	60 Years (3 Life Cycles)	7.5%	\$70,201	6	Simcoe (South)	\$52,685	6	St. Catharines (South)	\$65,238
7	Hamilton (South)	60 Years (3 Life Cycles)	7.5%	\$70,584	7	Hamilton (South)	\$53,065	7	Sarnia (South)	\$66,009
8	Cambridge (South)	60 Years (3 Life Cycles)	7.5%	\$70,936	8	London (South)	\$53,410	8	London (South)	\$66,049
9	London (South)	60 Years (3 Life Cycles)	7.5%	\$70,942	9	Cambridge (South)	\$53,421	9	Simcoe (South)	\$66,591
10	Toronto (South)	60 Years (3 Life Cycles)	7.5%	\$70,957	10	Toronto (South)	\$53,454	10	Barrie (Distinct)	\$67,167
11	Trenton (South)	60 Years (3 Life Cycles)	7.5%	\$71,267	11	Trenton (South)	\$53,729	11	Toronto (South)	\$67,348
12	Guelph (South)	60 Years (3 Life Cycles)	7.5%	\$71,285	12	Guelph (South)	\$53,781	12	Hamilton (South)	\$67,607
13	Mt. Forest (South)	60 Years (3 Life Cycles)	7.5%	\$71,971	13	Kitchener-Waterloo (South)	\$54,010	13	Ottawa (Distinct)	\$68,872
14	Sault Ste. Marie (North)	60 Years (3 Life Cycles)	7.5%	\$73,054	14	Mt. Forest (South)	\$54,458	14	Kitchener-Waterloo (South)	\$69,294
15	Kitchener-Waterloo (South)	60 Years (3 Life Cycles)	7.5%	\$83,347	15	Kingston (South)	\$54,467	15	Sault Ste. Marie (North)	\$69,542
16	Barrie (Distinct)	60 Years (3 Life Cycles)	7.5%	\$83,610	16	Warton (South)	\$54,623	16	North Bay (North)	\$69,719
17	Kingston (South)	60 Years (3 Life Cycles)	7.5%	\$83,740	17	Sault Ste. Marie (North)	\$55,575	17	Peterborough (Distinct)	\$69,940
18	Ottawa (Distinct)	60 Years (3 Life Cycles)	7.5%	\$83,907	18	Barrie (Distinct)	\$61,754	18	Muskoka (Distinct)	\$70,076
19	Warton (South)	60 Years (3 Life Cycles)	7.5%	\$83,934	19	Ottawa (Distinct)	\$62,112	19	Mt. Forest (South)	\$70,097
20	Peterborough (Distinct)	60 Years (3 Life Cycles)	7.5%	\$84,393	20	Peterborough (Distinct)	\$62,592	20	Warton (South)	\$70,819
21	Muskoka (Distinct)	60 Years (3 Life Cycles)	7.5%	\$84,602	21	Muskoka (Distinct)	\$62,750	21	Trenton (South)	\$71,369
22	North Bay (North)	60 Years (3 Life Cycles)	7.5%	\$84,802	22	North Bay (North)	\$63,044	22	Kingston (South)	\$72,226
23	Sudbury (North)	60 Years (3 Life Cycles)	7.5%	\$85,894	23	Sudbury (North)	\$64,148	23	Thunder Bay (North)	\$74,976
24	Timmins (North)	60 Years (3 Life Cycles)	7.5%	\$87,742	24	Timmins (North)	\$65,989	24	Sudbury (North)	\$75,011
25	Thunder Bay (North)	60 Years (3 Life Cycles)	7.5%	\$87,936	25	Thunder Bay (North)	\$66,148	25	Timmins (North)	\$77,571
26	Kenora (North)	60 Years (3 Life Cycles)	7.5%	\$88,734	26	Kenora (North)	\$66,899	26	Kenora (North)	\$78,364
27	Kapuskasing (North)	60 Years (3 Life Cycles)	7.5%	\$89,848	27	Kapuskasing (North)	\$68,029	27	Kapuskasing (North)	\$83,397

Table F1-1.50: Rankings of cities for carbon taxes scenario (average construction type) at a discount rate of 7.5% (three life cycles of V.GSHP and H.GSHP and five life cycles of Traditional HVAC Applications for a 60 year project lifespan)

FIT – (#2)

Total Present Value										
FIT - (#2)										
#	City	Project Life Span	Discount Rate	V.GSHP	#	City	H.GSHP	#	City	Traditional
1	St. Catharines (South)	60 Years (3 Life Cycles)	7.5%	\$62,842	1	St. Catharines (South)	\$45,273	1	Cambridge (South)	\$50,600
2	Sarnia (South)	60 Years (3 Life Cycles)	7.5%	\$63,200	2	Sarnia (South)	\$45,620	2	Guelph (South)	\$51,305
3	Chatham (South)	60 Years (3 Life Cycles)	7.5%	\$63,289	3	Chatham (South)	\$45,720	3	Chatham (South)	\$52,688
4	Windsor (South)	60 Years (3 Life Cycles)	7.5%	\$63,306	4	Windsor (South)	\$45,741	4	Windsor (South)	\$52,734
5	Niagara Falls (South)	60 Years (3 Life Cycles)	7.5%	\$63,457	5	Niagara Falls (South)	\$45,886	5	Niagara Falls (South)	\$53,687
6	Simcoe (South)	60 Years (3 Life Cycles)	7.5%	\$63,845	6	Simcoe (South)	\$46,283	6	London (South)	\$54,355
7	Hamilton (South)	60 Years (3 Life Cycles)	7.5%	\$64,113	7	Hamilton (South)	\$46,550	7	St. Catharines (South)	\$54,943
8	Cambridge (South)	60 Years (3 Life Cycles)	7.5%	\$64,359	8	London (South)	\$46,791	8	Barrie (Distinct)	\$55,115
9	London (South)	60 Years (3 Life Cycles)	7.5%	\$64,364	9	Cambridge (South)	\$46,799	9	Sarnia (South)	\$55,275
10	Toronto (South)	60 Years (3 Life Cycles)	7.5%	\$64,374	10	Toronto (South)	\$46,822	10	Simcoe (South)	\$55,468
11	Trenton (South)	60 Years (3 Life Cycles)	7.5%	\$64,592	11	Trenton (South)	\$47,015	11	Toronto (South)	\$55,590
12	Guelph (South)	60 Years (3 Life Cycles)	7.5%	\$64,604	12	Guelph (South)	\$47,052	12	Hamilton (South)	\$56,194
13	Mt. Forest (South)	60 Years (3 Life Cycles)	7.5%	\$65,084	13	Kitchener-Waterloo (South)	\$47,212	13	Sault Ste. Marie (North)	\$56,222
14	Sault Ste. Marie (North)	60 Years (3 Life Cycles)	7.5%	\$65,844	14	Mt. Forest (South)	\$47,526	14	Ottawa (Distinct)	\$56,511
15	Kitchener-Waterloo (South)	60 Years (3 Life Cycles)	7.5%	\$76,720	15	Kingston (South)	\$47,532	15	North Bay (North)	\$56,664
16	Barrie (Distinct)	60 Years (3 Life Cycles)	7.5%	\$76,904	16	Warton (South)	\$47,642	16	Muskoka (Distinct)	\$57,118
17	Kingston (South)	60 Years (3 Life Cycles)	7.5%	\$76,995	17	Sault Ste. Marie (North)	\$48,308	17	Mt. Forest (South)	\$57,129
18	Ottawa (Distinct)	60 Years (3 Life Cycles)	7.5%	\$77,112	18	Barrie (Distinct)	\$54,980	18	Kitchener-Waterloo (South)	\$57,161
19	Warton (South)	60 Years (3 Life Cycles)	7.5%	\$77,131	19	Ottawa (Distinct)	\$55,231	19	Peterborough (Distinct)	\$57,227
20	Peterborough (Distinct)	60 Years (3 Life Cycles)	7.5%	\$77,453	20	Peterborough (Distinct)	\$55,567	20	Warton (South)	\$58,218
21	Muskoka (Distinct)	60 Years (3 Life Cycles)	7.5%	\$77,599	21	Muskoka (Distinct)	\$55,678	21	Trenton (South)	\$59,530
22	North Bay (North)	60 Years (3 Life Cycles)	7.5%	\$77,739	22	North Bay (North)	\$55,884	22	Kingston (South)	\$60,035
23	Sudbury (North)	60 Years (3 Life Cycles)	7.5%	\$78,504	23	Sudbury (North)	\$56,657	23	Thunder Bay (North)	\$60,102
24	Timmins (North)	60 Years (3 Life Cycles)	7.5%	\$79,799	24	Timmins (North)	\$57,948	24	Sudbury (North)	\$60,946
25	Thunder Bay (North)	60 Years (3 Life Cycles)	7.5%	\$79,935	25	Thunder Bay (North)	\$58,059	25	Timmins (North)	\$61,974
26	Kenora (North)	60 Years (3 Life Cycles)	7.5%	\$80,494	26	Kenora (North)	\$58,585	26	Kenora (North)	\$63,273
27	Kapuskasing (North)	60 Years (3 Life Cycles)	7.5%	\$81,275	27	Kapuskasing (North)	\$59,377	27	Kapuskasing (North)	\$67,240

Table F1-1.51: Rankings of cities for feed-in tariff scenario (average construction type) at a discount rate of 7.5% (three life cycles of V.GSHP and H.GSHP and five life cycles of Traditional HVAC Applications for a 60 year project lifespan)

Rebates – (#3)

Total Present Value										
Rebates - (#3)										
#	City	Project Life Span	Discount Rate	V.GSHP	#	City	H.GSHP	#	City	Traditional
1	St. Catharines (South)	60 Years (3 Life Cycles)	7.5%	\$61,410	1	St. Catharines (South)	\$43,882	1	Cambridge (South)	\$50,600
2	Sarnia (South)	60 Years (3 Life Cycles)	7.5%	\$61,920	2	Sarnia (South)	\$44,377	2	Guelph (South)	\$51,305
3	Chatham (South)	60 Years (3 Life Cycles)	7.5%	\$62,047	3	Chatham (South)	\$44,519	3	Chatham (South)	\$52,688
4	Windsor (South)	60 Years (3 Life Cycles)	7.5%	\$62,071	4	Windsor (South)	\$44,550	4	Windsor (South)	\$52,734
5	Niagara Falls (South)	60 Years (3 Life Cycles)	7.5%	\$62,287	5	Niagara Falls (South)	\$44,757	5	Niagara Falls (South)	\$53,687
6	Simcoe (South)	60 Years (3 Life Cycles)	7.5%	\$62,841	6	Simcoe (South)	\$45,324	6	London (South)	\$54,355
7	Hamilton (South)	60 Years (3 Life Cycles)	7.5%	\$63,223	7	Hamilton (South)	\$45,704	7	St. Catharines (South)	\$54,943
8	Cambridge (South)	60 Years (3 Life Cycles)	7.5%	\$63,575	8	London (South)	\$46,049	8	Barrie (Distinct)	\$55,115
9	London (South)	60 Years (3 Life Cycles)	7.5%	\$63,581	9	Cambridge (South)	\$46,060	9	Sarnia (South)	\$55,275
10	Toronto (South)	60 Years (3 Life Cycles)	7.5%	\$63,597	10	Toronto (South)	\$46,093	10	Simcoe (South)	\$55,468
11	Trenton (South)	60 Years (3 Life Cycles)	7.5%	\$63,906	11	Trenton (South)	\$46,368	11	Toronto (South)	\$55,590
12	Guelph (South)	60 Years (3 Life Cycles)	7.5%	\$63,924	12	Guelph (South)	\$46,421	12	Hamilton (South)	\$56,194
13	Mt. Forest (South)	60 Years (3 Life Cycles)	7.5%	\$64,610	13	Kitchener-Waterloo (South)	\$46,649	13	Sault Ste. Marie (North)	\$56,222
14	Sault Ste. Marie (North)	60 Years (3 Life Cycles)	7.5%	\$65,693	14	Mt. Forest (South)	\$47,097	14	Ottawa (Distinct)	\$56,511
15	Kitchener-Waterloo (South)	60 Years (3 Life Cycles)	7.5%	\$75,986	15	Kingston (South)	\$47,106	15	North Bay (North)	\$56,664
16	Barrie (Distinct)	60 Years (3 Life Cycles)	7.5%	\$76,250	16	Warton (South)	\$47,262	16	Muskoka (Distinct)	\$57,118
17	Kingston (South)	60 Years (3 Life Cycles)	7.5%	\$76,379	17	Sault Ste. Marie (North)	\$48,214	17	Mt. Forest (South)	\$57,129
18	Ottawa (Distinct)	60 Years (3 Life Cycles)	7.5%	\$76,546	18	Barrie (Distinct)	\$54,393	18	Kitchener-Waterloo (South)	\$57,161
19	Warton (South)	60 Years (3 Life Cycles)	7.5%	\$76,573	19	Ottawa (Distinct)	\$54,751	19	Peterborough (Distinct)	\$57,227
20	Peterborough (Distinct)	60 Years (3 Life Cycles)	7.5%	\$77,032	20	Peterborough (Distinct)	\$55,231	20	Warton (South)	\$58,218
21	Muskoka (Distinct)	60 Years (3 Life Cycles)	7.5%	\$77,241	21	Muskoka (Distinct)	\$55,389	21	Trenton (South)	\$59,530
22	North Bay (North)	60 Years (3 Life Cycles)	7.5%	\$77,441	22	North Bay (North)	\$55,683	22	Kingston (South)	\$60,035
23	Sudbury (North)	60 Years (3 Life Cycles)	7.5%	\$78,533	23	Sudbury (North)	\$56,787	23	Thunder Bay (North)	\$60,102
24	Timmins (North)	60 Years (3 Life Cycles)	7.5%	\$80,382	24	Timmins (North)	\$58,629	24	Sudbury (North)	\$60,946
25	Thunder Bay (North)	60 Years (3 Life Cycles)	7.5%	\$80,575	25	Thunder Bay (North)	\$58,787	25	Timmins (North)	\$61,974
26	Kenora (North)	60 Years (3 Life Cycles)	7.5%	\$81,373	26	Kenora (North)	\$59,538	26	Kenora (North)	\$63,273
27	Kapuskasing (North)	60 Years (3 Life Cycles)	7.5%	\$82,487	27	Kapuskasing (North)	\$60,668	27	Kapuskasing (North)	\$67,240

Table F1-1.52: Rankings of cities for rebates scenario (average construction type) at a discount rate of 7.5% (three life cycles of V.GSHP and H.GSHP and five life cycles of Traditional HVAC Applications for a 60 year project lifespan)

FIT + Rebates – (#4)

Total Present Value										
(FIT+Rebates) - (#4)										
#	City	Project Life Span	Discount Rate	V.GSHP	#	City	H.GSHP	#	City	Traditional
1	St. Catharines (South)	60 Years (3 Life Cycles)	7.5%	\$55,481	1	St. Catharines (South)	\$37,912	1	Cambridge (South)	\$50,600
2	Sarnia (South)	60 Years (3 Life Cycles)	7.5%	\$55,839	2	Sarnia (South)	\$38,259	2	Guelph (South)	\$51,305
3	Chatham (South)	60 Years (3 Life Cycles)	7.5%	\$55,928	3	Chatham (South)	\$38,359	3	Chatham (South)	\$52,688
4	Windsor (South)	60 Years (3 Life Cycles)	7.5%	\$55,945	4	Windsor (South)	\$38,380	4	Windsor (South)	\$52,734
5	Niagara Falls (South)	60 Years (3 Life Cycles)	7.5%	\$56,096	5	Niagara Falls (South)	\$38,525	5	Niagara Falls (South)	\$53,687
6	Simcoe (South)	60 Years (3 Life Cycles)	7.5%	\$56,484	6	Simcoe (South)	\$38,922	6	London (South)	\$54,355
7	Hamilton (South)	60 Years (3 Life Cycles)	7.5%	\$56,752	7	Hamilton (South)	\$39,189	7	St. Catharines (South)	\$54,943
8	Cambridge (South)	60 Years (3 Life Cycles)	7.5%	\$56,998	8	London (South)	\$39,431	8	Barrie (Distinct)	\$55,115
9	London (South)	60 Years (3 Life Cycles)	7.5%	\$57,003	9	Cambridge (South)	\$39,438	9	Sarnia (South)	\$55,275
10	Toronto (South)	60 Years (3 Life Cycles)	7.5%	\$57,014	10	Toronto (South)	\$39,461	10	Simcoe (South)	\$55,468
11	Trenton (South)	60 Years (3 Life Cycles)	7.5%	\$57,231	11	Trenton (South)	\$39,654	11	Toronto (South)	\$55,590
12	Guelph (South)	60 Years (3 Life Cycles)	7.5%	\$57,243	12	Guelph (South)	\$39,691	12	Hamilton (South)	\$56,194
13	Mt. Forest (South)	60 Years (3 Life Cycles)	7.5%	\$57,723	13	Kitchener-Waterloo (South)	\$39,851	13	Sault Ste. Marie (North)	\$56,222
14	Sault Ste. Marie (North)	60 Years (3 Life Cycles)	7.5%	\$58,483	14	Mt. Forest (South)	\$40,165	14	Ottawa (Distinct)	\$56,511
15	Kitchener-Waterloo (South)	60 Years (3 Life Cycles)	7.5%	\$69,359	15	Kingston (South)	\$40,171	15	North Bay (North)	\$56,664
16	Barrie (Distinct)	60 Years (3 Life Cycles)	7.5%	\$69,544	16	Warton (South)	\$40,281	16	Muskoka (Distinct)	\$57,118
17	Kingston (South)	60 Years (3 Life Cycles)	7.5%	\$69,634	17	Sault Ste. Marie (North)	\$40,947	17	Mt. Forest (South)	\$57,129
18	Ottawa (Distinct)	60 Years (3 Life Cycles)	7.5%	\$69,751	18	Barrie (Distinct)	\$47,619	18	Kitchener-Waterloo (South)	\$57,161
19	Warton (South)	60 Years (3 Life Cycles)	7.5%	\$69,770	19	Ottawa (Distinct)	\$47,870	19	Peterborough (Distinct)	\$57,227
20	Peterborough (Distinct)	60 Years (3 Life Cycles)	7.5%	\$70,092	20	Peterborough (Distinct)	\$48,206	20	Warton (South)	\$58,218
21	Muskoka (Distinct)	60 Years (3 Life Cycles)	7.5%	\$70,238	21	Muskoka (Distinct)	\$48,317	21	Trenton (South)	\$59,530
22	North Bay (North)	60 Years (3 Life Cycles)	7.5%	\$70,378	22	North Bay (North)	\$48,523	22	Kingston (South)	\$60,035
23	Sudbury (North)	60 Years (3 Life Cycles)	7.5%	\$71,143	23	Sudbury (North)	\$49,296	23	Thunder Bay (North)	\$60,102
24	Timmins (North)	60 Years (3 Life Cycles)	7.5%	\$72,439	24	Timmins (North)	\$50,587	24	Sudbury (North)	\$60,946
25	Thunder Bay (North)	60 Years (3 Life Cycles)	7.5%	\$72,574	25	Thunder Bay (North)	\$50,698	25	Timmins (North)	\$61,974
26	Kenora (North)	60 Years (3 Life Cycles)	7.5%	\$73,133	26	Kenora (North)	\$51,224	26	Kenora (North)	\$63,273
27	Kapuskasing (North)	60 Years (3 Life Cycles)	7.5%	\$73,914	27	Kapuskasing (North)	\$52,016	27	Kapuskasing (North)	\$67,240

Table F1-1.53: Rankings of cities for feed-in tariff + rebates scenario (average construction type) at a discount rate of 7.5% (three life cycles of V.GSHP and H.GSHP and five life cycles of Traditional HVAC Applications for a 60 year project lifespan)

(FIT + Rebates) + Carbon Taxes – (#5)

Total Present Value										
(FIT+Rebates) + Carbon Taxes - (#5)										
#	City	Project Life Span	Discount Rate	V.GSHP	#	City	H.GSHP	#	City	Traditional
1	St. Catharines (South)	60 Years (3 Life Cycles)	7.5%	\$55,481	1	St. Catharines (South)	\$37,912	1	Cambridge (South)	\$62,333
2	Sarnia (South)	60 Years (3 Life Cycles)	7.5%	\$55,839	2	Sarnia (South)	\$38,259	2	Chatham (South)	\$63,131
3	Chatham (South)	60 Years (3 Life Cycles)	7.5%	\$55,928	3	Chatham (South)	\$38,359	3	Windsor (South)	\$63,206
4	Windsor (South)	60 Years (3 Life Cycles)	7.5%	\$55,945	4	Windsor (South)	\$38,380	4	Guelph (South)	\$63,415
5	Niagara Falls (South)	60 Years (3 Life Cycles)	7.5%	\$56,096	5	Niagara Falls (South)	\$38,525	5	Niagara Falls (South)	\$64,262
6	Simcoe (South)	60 Years (3 Life Cycles)	7.5%	\$56,484	6	Simcoe (South)	\$38,922	6	St. Catharines (South)	\$65,238
7	Hamilton (South)	60 Years (3 Life Cycles)	7.5%	\$56,752	7	Hamilton (South)	\$39,189	7	Sarnia (South)	\$66,009
8	Cambridge (South)	60 Years (3 Life Cycles)	7.5%	\$56,998	8	London (South)	\$39,431	8	London (South)	\$66,049
9	London (South)	60 Years (3 Life Cycles)	7.5%	\$57,003	9	Cambridge (South)	\$39,438	9	Simcoe (South)	\$66,591
10	Toronto (South)	60 Years (3 Life Cycles)	7.5%	\$57,014	10	Toronto (South)	\$39,461	10	Barrie (Distinct)	\$67,167
11	Trenton (South)	60 Years (3 Life Cycles)	7.5%	\$57,231	11	Trenton (South)	\$39,654	11	Toronto (South)	\$67,348
12	Guelph (South)	60 Years (3 Life Cycles)	7.5%	\$57,243	12	Guelph (South)	\$39,691	12	Hamilton (South)	\$67,607
13	Mt. Forest (South)	60 Years (3 Life Cycles)	7.5%	\$57,723	13	Kitchener-Waterloo (South)	\$39,851	13	Ottawa (Distinct)	\$68,872
14	Sault Ste. Marie (North)	60 Years (3 Life Cycles)	7.5%	\$58,483	14	Mt. Forest (South)	\$40,165	14	Kitchener-Waterloo (South)	\$69,294
15	Kitchener-Waterloo (South)	60 Years (3 Life Cycles)	7.5%	\$69,359	15	Kingston (South)	\$40,171	15	Sault Ste. Marie (North)	\$69,542
16	Barrie (Distinct)	60 Years (3 Life Cycles)	7.5%	\$69,544	16	Warton (South)	\$40,281	16	North Bay (North)	\$69,719
17	Kingston (South)	60 Years (3 Life Cycles)	7.5%	\$69,634	17	Sault Ste. Marie (North)	\$40,947	17	Peterborough (Distinct)	\$69,940
18	Ottawa (Distinct)	60 Years (3 Life Cycles)	7.5%	\$69,751	18	Barrie (Distinct)	\$47,619	18	Muskoka (Distinct)	\$70,076
19	Warton (South)	60 Years (3 Life Cycles)	7.5%	\$69,770	19	Ottawa (Distinct)	\$47,870	19	Mt. Forest (South)	\$70,097
20	Peterborough (Distinct)	60 Years (3 Life Cycles)	7.5%	\$70,092	20	Peterborough (Distinct)	\$48,206	20	Warton (South)	\$70,819
21	Muskoka (Distinct)	60 Years (3 Life Cycles)	7.5%	\$70,238	21	Muskoka (Distinct)	\$48,317	21	Trenton (South)	\$71,369
22	North Bay (North)	60 Years (3 Life Cycles)	7.5%	\$70,378	22	North Bay (North)	\$48,523	22	Kingston (South)	\$72,226
23	Sudbury (North)	60 Years (3 Life Cycles)	7.5%	\$71,143	23	Sudbury (North)	\$49,296	23	Thunder Bay (North)	\$74,976
24	Timmins (North)	60 Years (3 Life Cycles)	7.5%	\$72,439	24	Timmins (North)	\$50,587	24	Sudbury (North)	\$75,011
25	Thunder Bay (North)	60 Years (3 Life Cycles)	7.5%	\$72,574	25	Thunder Bay (North)	\$50,698	25	Timmins (North)	\$77,571
26	Kenora (North)	60 Years (3 Life Cycles)	7.5%	\$73,133	26	Kenora (North)	\$51,224	26	Kenora (North)	\$78,364
27	Kapuskasing (North)	60 Years (3 Life Cycles)	7.5%	\$73,914	27	Kapuskasing (North)	\$52,016	27	Kapuskasing (North)	\$83,397

Table F1-1.54: Rankings of cities for feed-in tariff + rebates + carbon tax scenario (average construction type) at a discount rate of 7.5% (three life cycles of V.GSHP and H.GSHP and five life cycles of Traditional HVAC Applications for a 60 year project lifespan)

10. Three Life Cycles of V.GSHP and H.GSHP and Five Life Cycles of Traditional HVAC Applications @ 8.5% Discount Rate

Base Case Scenario

Total Present Value										
Base Case Scenario										
#	City	Project Life Span	Discount Rate	V.GSHP	#	City	H.GSHP	#	City	Traditional
1	St. Catharines (South)	60 Years (3 Life Cycles)	8.5%	\$63,083	1	St. Catharines (South)	\$46,704	1	Cambridge (South)	\$44,996
2	Sarnia (South)	60 Years (3 Life Cycles)	8.5%	\$63,533	2	Sarnia (South)	\$47,140	2	Guelph (South)	\$45,615
3	Chatham (South)	60 Years (3 Life Cycles)	8.5%	\$63,646	3	Chatham (South)	\$47,266	3	Chatham (South)	\$46,879
4	Windsor (South)	60 Years (3 Life Cycles)	8.5%	\$63,667	4	Windsor (South)	\$47,293	4	Windsor (South)	\$46,919
5	Niagara Falls (South)	60 Years (3 Life Cycles)	8.5%	\$63,857	5	Niagara Falls (South)	\$47,475	5	Niagara Falls (South)	\$47,758
6	Simcoe (South)	60 Years (3 Life Cycles)	8.5%	\$64,346	6	Simcoe (South)	\$47,975	6	London (South)	\$48,339
7	Hamilton (South)	60 Years (3 Life Cycles)	8.5%	\$64,683	7	Hamilton (South)	\$48,311	7	St. Catharines (South)	\$48,900
8	Cambridge (South)	60 Years (3 Life Cycles)	8.5%	\$64,993	8	London (South)	\$48,615	8	Barrie (Distinct)	\$49,037
9	London (South)	60 Years (3 Life Cycles)	8.5%	\$64,999	9	Cambridge (South)	\$48,625	9	Sarnia (South)	\$49,189
10	Toronto (South)	60 Years (3 Life Cycles)	8.5%	\$65,012	10	Toronto (South)	\$48,654	10	Simcoe (South)	\$49,356
11	Trenton (South)	60 Years (3 Life Cycles)	8.5%	\$65,286	11	Trenton (South)	\$48,896	11	Toronto (South)	\$49,458
12	Guelph (South)	60 Years (3 Life Cycles)	8.5%	\$65,301	12	Guelph (South)	\$48,943	12	Hamilton (South)	\$49,994
13	Mt. Forest (South)	60 Years (3 Life Cycles)	8.5%	\$65,906	13	Kitchener-Waterloo (South)	\$49,144	13	Sault Ste. Marie (North)	\$49,974
14	Sault Ste. Marie (North)	60 Years (3 Life Cycles)	8.5%	\$66,862	14	Mt. Forest (South)	\$49,540	14	Ottawa (Distinct)	\$50,266
15	Kitchener-Waterloo (South)	60 Years (3 Life Cycles)	8.5%	\$76,546	15	Kingston (South)	\$49,548	15	North Bay (North)	\$50,396
16	Barrie (Distinct)	60 Years (3 Life Cycles)	8.5%	\$76,779	16	Warton (South)	\$49,685	16	Muskoka (Distinct)	\$50,797
17	Kingston (South)	60 Years (3 Life Cycles)	8.5%	\$76,893	17	Sault Ste. Marie (North)	\$50,525	17	Mt. Forest (South)	\$50,807
18	Ottawa (Distinct)	60 Years (3 Life Cycles)	8.5%	\$77,041	18	Barrie (Distinct)	\$56,351	18	Kitchener-Waterloo (South)	\$50,842
19	Warton (South)	60 Years (3 Life Cycles)	8.5%	\$77,064	19	Ottawa (Distinct)	\$56,667	19	Peterborough (Distinct)	\$50,895
20	Peterborough (Distinct)	60 Years (3 Life Cycles)	8.5%	\$77,469	20	Peterborough (Distinct)	\$57,090	20	Warton (South)	\$51,801
21	Muskoka (Distinct)	60 Years (3 Life Cycles)	8.5%	\$77,653	21	Muskoka (Distinct)	\$57,229	21	Trenton (South)	\$52,995
22	North Bay (North)	60 Years (3 Life Cycles)	8.5%	\$77,830	22	North Bay (North)	\$57,489	22	Kingston (South)	\$53,438
23	Sudbury (North)	60 Years (3 Life Cycles)	8.5%	\$78,793	23	Sudbury (North)	\$58,462	23	Thunder Bay (North)	\$53,415
24	Timmins (North)	60 Years (3 Life Cycles)	8.5%	\$80,424	24	Timmins (North)	\$60,087	24	Sudbury (North)	\$54,196
25	Thunder Bay (North)	60 Years (3 Life Cycles)	8.5%	\$80,594	25	Thunder Bay (North)	\$60,227	25	Timmins (North)	\$55,060
26	Kenora (North)	60 Years (3 Life Cycles)	8.5%	\$81,298	26	Kenora (North)	\$60,890	26	Kenora (North)	\$56,241
27	Kapuskasing (North)	60 Years (3 Life Cycles)	8.5%	\$82,281	27	Kapuskasing (North)	\$61,886	27	Kapuskasing (North)	\$59,762

Table F1-1.55: Rankings of cities for base case scenario (average construction type) at a discount rate of 8.5% (three life cycles of V.GSHP and H.GSHP and five life cycles of Traditional HVAC Applications for a 60 year project lifespan)

Carbon Taxes – (#1)

Total Present Value										
Carbon Taxes - (#1)										
#	City	Project Life Span	Discount Rate	V.GSHP	#	City	H.GSHP	#	City	Traditional
1	St. Catharines (South)	60 Years (3 Life Cycles)	8.5%	\$63,083	1	St. Catharines (South)	\$46,704	1	Cambridge (South)	\$54,463
2	Sarnia (South)	60 Years (3 Life Cycles)	8.5%	\$63,533	2	Sarnia (South)	\$47,140	2	Chatham (South)	\$55,304
3	Chatham (South)	60 Years (3 Life Cycles)	8.5%	\$63,646	3	Chatham (South)	\$47,266	3	Windsor (South)	\$55,368
4	Windsor (South)	60 Years (3 Life Cycles)	8.5%	\$63,667	4	Windsor (South)	\$47,293	4	Guelph (South)	\$55,386
5	Niagara Falls (South)	60 Years (3 Life Cycles)	8.5%	\$63,857	5	Niagara Falls (South)	\$47,475	5	Niagara Falls (South)	\$56,291
6	Simcoe (South)	60 Years (3 Life Cycles)	8.5%	\$64,346	6	Simcoe (South)	\$47,975	6	St. Catharines (South)	\$57,206
7	Hamilton (South)	60 Years (3 Life Cycles)	8.5%	\$64,683	7	Hamilton (South)	\$48,311	7	London (South)	\$57,775
8	Cambridge (South)	60 Years (3 Life Cycles)	8.5%	\$64,993	8	London (South)	\$48,615	8	Sarnia (South)	\$57,849
9	London (South)	60 Years (3 Life Cycles)	8.5%	\$64,999	9	Cambridge (South)	\$48,625	9	Simcoe (South)	\$58,330
10	Toronto (South)	60 Years (3 Life Cycles)	8.5%	\$65,012	10	Toronto (South)	\$48,654	10	Barrie (Distinct)	\$58,761
11	Trenton (South)	60 Years (3 Life Cycles)	8.5%	\$65,286	11	Trenton (South)	\$48,896	11	Toronto (South)	\$58,946
12	Guelph (South)	60 Years (3 Life Cycles)	8.5%	\$65,301	12	Guelph (South)	\$48,943	12	Hamilton (South)	\$59,203
13	Mt. Forest (South)	60 Years (3 Life Cycles)	8.5%	\$65,906	13	Kitchener-Waterloo (South)	\$49,144	13	Ottawa (Distinct)	\$60,240
14	Sault Ste. Marie (North)	60 Years (3 Life Cycles)	8.5%	\$66,862	14	Mt. Forest (South)	\$49,540	14	Kitchener-Waterloo (South)	\$60,631
15	Kitchener-Waterloo (South)	60 Years (3 Life Cycles)	8.5%	\$76,546	15	Kingston (South)	\$49,548	15	Sault Ste. Marie (North)	\$60,721
16	Barrie (Distinct)	60 Years (3 Life Cycles)	8.5%	\$76,779	16	Warton (South)	\$49,685	16	North Bay (North)	\$60,929
17	Kingston (South)	60 Years (3 Life Cycles)	8.5%	\$76,893	17	Sault Ste. Marie (North)	\$50,525	17	Peterborough (Distinct)	\$61,153
18	Ottawa (Distinct)	60 Years (3 Life Cycles)	8.5%	\$77,041	18	Barrie (Distinct)	\$56,351	18	Muskoka (Distinct)	\$61,252
19	Warton (South)	60 Years (3 Life Cycles)	8.5%	\$77,064	19	Ottawa (Distinct)	\$56,667	19	Mt. Forest (South)	\$61,270
20	Peterborough (Distinct)	60 Years (3 Life Cycles)	8.5%	\$77,469	20	Peterborough (Distinct)	\$57,090	20	Warton (South)	\$61,968
21	Muskoka (Distinct)	60 Years (3 Life Cycles)	8.5%	\$77,653	21	Muskoka (Distinct)	\$57,229	21	Trenton (South)	\$62,547
22	North Bay (North)	60 Years (3 Life Cycles)	8.5%	\$77,830	22	North Bay (North)	\$57,489	22	Kingston (South)	\$63,274
23	Sudbury (North)	60 Years (3 Life Cycles)	8.5%	\$78,793	23	Sudbury (North)	\$58,462	23	Thunder Bay (North)	\$65,416
24	Timmins (North)	60 Years (3 Life Cycles)	8.5%	\$80,424	24	Timmins (North)	\$60,087	24	Sudbury (North)	\$65,544
25	Thunder Bay (North)	60 Years (3 Life Cycles)	8.5%	\$80,594	25	Thunder Bay (North)	\$60,227	25	Timmins (North)	\$67,644
26	Kenora (North)	60 Years (3 Life Cycles)	8.5%	\$81,298	26	Kenora (North)	\$60,890	26	Kenora (North)	\$68,417
27	Kapuskasing (North)	60 Years (3 Life Cycles)	8.5%	\$82,281	27	Kapuskasing (North)	\$61,886	27	Kapuskasing (North)	\$72,799

Table F1-1.56: Rankings of cities for carbon taxes scenario (average construction type) at a discount rate of 8.5% (three life cycles of V.GSHP and H.GSHP and five life cycles of Traditional HVAC Applications for a 60 year project lifespan)

FIT – (#2)

Total Present Value										
FIT - (#2)										
#	City	Project Life Span	Discount Rate	V.GSHP	#	City	H.GSHP	#	City	Traditional
1	St. Catharines (South)	60 Years (3 Life Cycles)	8.5%	\$57,823	1	St. Catharines (South)	\$41,406	1	Cambridge (South)	\$44,996
2	Sarnia (South)	60 Years (3 Life Cycles)	8.5%	\$58,137	2	Sarnia (South)	\$41,711	2	Guelph (South)	\$45,615
3	Chatham (South)	60 Years (3 Life Cycles)	8.5%	\$58,216	3	Chatham (South)	\$41,799	3	Chatham (South)	\$46,879
4	Windsor (South)	60 Years (3 Life Cycles)	8.5%	\$58,231	4	Windsor (South)	\$41,818	4	Windsor (South)	\$46,919
5	Niagara Falls (South)	60 Years (3 Life Cycles)	8.5%	\$58,364	5	Niagara Falls (South)	\$41,946	5	Niagara Falls (South)	\$47,758
6	Simcoe (South)	60 Years (3 Life Cycles)	8.5%	\$58,705	6	Simcoe (South)	\$42,295	6	London (South)	\$48,339
7	Hamilton (South)	60 Years (3 Life Cycles)	8.5%	\$58,941	7	Hamilton (South)	\$42,530	7	St. Catharines (South)	\$48,900
8	Cambridge (South)	60 Years (3 Life Cycles)	8.5%	\$59,158	8	London (South)	\$42,742	8	Barrie (Distinct)	\$49,037
9	London (South)	60 Years (3 Life Cycles)	8.5%	\$59,162	9	Cambridge (South)	\$42,749	9	Sarnia (South)	\$49,189
10	Toronto (South)	60 Years (3 Life Cycles)	8.5%	\$59,171	10	Toronto (South)	\$42,769	10	Simcoe (South)	\$49,356
11	Trenton (South)	60 Years (3 Life Cycles)	8.5%	\$59,362	11	Trenton (South)	\$42,939	11	Toronto (South)	\$49,458
12	Guelph (South)	60 Years (3 Life Cycles)	8.5%	\$59,373	12	Guelph (South)	\$42,971	12	Hamilton (South)	\$49,994
13	Mt. Forest (South)	60 Years (3 Life Cycles)	8.5%	\$59,796	13	Kitchener-Waterloo (South)	\$43,112	13	Sault Ste. Marie (North)	\$49,974
14	Sault Ste. Marie (North)	60 Years (3 Life Cycles)	8.5%	\$60,464	14	Mt. Forest (South)	\$43,389	14	Ottawa (Distinct)	\$50,266
15	Kitchener-Waterloo (South)	60 Years (3 Life Cycles)	8.5%	\$70,666	15	Kingston (South)	\$43,394	15	North Bay (North)	\$50,396
16	Barrie (Distinct)	60 Years (3 Life Cycles)	8.5%	\$70,829	16	Warton (South)	\$43,490	16	Muskoka (Distinct)	\$50,797
17	Kingston (South)	60 Years (3 Life Cycles)	8.5%	\$70,909	17	Sault Ste. Marie (North)	\$44,077	17	Mt. Forest (South)	\$50,807
18	Ottawa (Distinct)	60 Years (3 Life Cycles)	8.5%	\$71,011	18	Barrie (Distinct)	\$50,341	18	Kitchener-Waterloo (South)	\$50,842
19	Warton (South)	60 Years (3 Life Cycles)	8.5%	\$71,028	19	Ottawa (Distinct)	\$50,561	19	Peterborough (Distinct)	\$50,895
20	Peterborough (Distinct)	60 Years (3 Life Cycles)	8.5%	\$71,311	20	Peterborough (Distinct)	\$50,857	20	Warton (South)	\$51,801
21	Muskoka (Distinct)	60 Years (3 Life Cycles)	8.5%	\$71,440	21	Muskoka (Distinct)	\$50,954	21	Trenton (South)	\$52,995
22	North Bay (North)	60 Years (3 Life Cycles)	8.5%	\$71,563	22	North Bay (North)	\$51,136	22	Kingston (South)	\$53,438
23	Sudbury (North)	60 Years (3 Life Cycles)	8.5%	\$72,236	23	Sudbury (North)	\$51,816	23	Thunder Bay (North)	\$53,415
24	Timmins (North)	60 Years (3 Life Cycles)	8.5%	\$73,376	24	Timmins (North)	\$52,951	24	Sudbury (North)	\$54,196
25	Thunder Bay (North)	60 Years (3 Life Cycles)	8.5%	\$73,495	25	Thunder Bay (North)	\$53,049	25	Timmins (North)	\$55,060
26	Kenora (North)	60 Years (3 Life Cycles)	8.5%	\$73,987	26	Kenora (North)	\$53,512	26	Kenora (North)	\$56,241
27	Kapuskasing (North)	60 Years (3 Life Cycles)	8.5%	\$74,674	27	Kapuskasing (North)	\$54,209	27	Kapuskasing (North)	\$59,762

Table F1-1.57: Rankings of cities for feed-in tariff scenario (average construction type) at a discount rate of 8.5% (three life cycles of V.GSHP and H.GSHP and five life cycles of Traditional HVAC Applications for a 60 year project lifespan)

Rebates – (#3)

Total Present Value										
Rebates - (#3)										
#	City	Project Life Span	Discount Rate	V.GSHP	#	City	H.GSHP	#	City	Traditional
1	St. Catharines (South)	60 Years (3 Life Cycles)	8.5%	\$56,208	1	St. Catharines (South)	\$39,828	1	Cambridge (South)	\$44,996
2	Sarnia (South)	60 Years (3 Life Cycles)	8.5%	\$56,657	2	Sarnia (South)	\$40,264	2	Guelph (South)	\$45,615
3	Chatham (South)	60 Years (3 Life Cycles)	8.5%	\$56,770	3	Chatham (South)	\$40,390	3	Chatham (South)	\$46,879
4	Windsor (South)	60 Years (3 Life Cycles)	8.5%	\$56,791	4	Windsor (South)	\$40,417	4	Windsor (South)	\$46,919
5	Niagara Falls (South)	60 Years (3 Life Cycles)	8.5%	\$56,981	5	Niagara Falls (South)	\$40,599	5	Niagara Falls (South)	\$47,758
6	Simcoe (South)	60 Years (3 Life Cycles)	8.5%	\$57,470	6	Simcoe (South)	\$41,100	6	London (South)	\$48,339
7	Hamilton (South)	60 Years (3 Life Cycles)	8.5%	\$57,807	7	Hamilton (South)	\$41,435	7	St. Catharines (South)	\$48,900
8	Cambridge (South)	60 Years (3 Life Cycles)	8.5%	\$58,117	8	London (South)	\$41,739	8	Barrie (Distinct)	\$49,037
9	London (South)	60 Years (3 Life Cycles)	8.5%	\$58,123	9	Cambridge (South)	\$41,749	9	Sarnia (South)	\$49,189
10	Toronto (South)	60 Years (3 Life Cycles)	8.5%	\$58,137	10	Toronto (South)	\$41,778	10	Simcoe (South)	\$49,356
11	Trenton (South)	60 Years (3 Life Cycles)	8.5%	\$58,410	11	Trenton (South)	\$42,020	11	Toronto (South)	\$49,458
12	Guelph (South)	60 Years (3 Life Cycles)	8.5%	\$58,425	12	Guelph (South)	\$42,067	12	Hamilton (South)	\$49,994
13	Mt. Forest (South)	60 Years (3 Life Cycles)	8.5%	\$59,030	13	Kitchener-Waterloo (South)	\$42,269	13	Sault Ste. Marie (North)	\$49,974
14	Sault Ste. Marie (North)	60 Years (3 Life Cycles)	8.5%	\$59,986	14	Mt. Forest (South)	\$42,664	14	Ottawa (Distinct)	\$50,266
15	Kitchener-Waterloo (South)	60 Years (3 Life Cycles)	8.5%	\$69,671	15	Kingston (South)	\$42,672	15	North Bay (North)	\$50,396
16	Barrie (Distinct)	60 Years (3 Life Cycles)	8.5%	\$69,903	16	Warton (South)	\$42,809	16	Muskoka (Distinct)	\$50,797
17	Kingston (South)	60 Years (3 Life Cycles)	8.5%	\$70,018	17	Sault Ste. Marie (North)	\$43,649	17	Mt. Forest (South)	\$50,807
18	Ottawa (Distinct)	60 Years (3 Life Cycles)	8.5%	\$70,165	18	Barrie (Distinct)	\$49,475	18	Kitchener-Waterloo (South)	\$50,842
19	Warton (South)	60 Years (3 Life Cycles)	8.5%	\$70,188	19	Ottawa (Distinct)	\$49,791	19	Peterborough (Distinct)	\$50,895
20	Peterborough (Distinct)	60 Years (3 Life Cycles)	8.5%	\$70,593	20	Peterborough (Distinct)	\$50,214	20	Warton (South)	\$51,801
21	Muskoka (Distinct)	60 Years (3 Life Cycles)	8.5%	\$70,778	21	Muskoka (Distinct)	\$50,354	21	Trenton (South)	\$52,995
22	North Bay (North)	60 Years (3 Life Cycles)	8.5%	\$70,954	22	North Bay (North)	\$50,613	22	Kingston (South)	\$53,438
23	Sudbury (North)	60 Years (3 Life Cycles)	8.5%	\$71,917	23	Sudbury (North)	\$51,587	23	Thunder Bay (North)	\$53,415
24	Timmins (North)	60 Years (3 Life Cycles)	8.5%	\$73,548	24	Timmins (North)	\$53,211	24	Sudbury (North)	\$54,196
25	Thunder Bay (North)	60 Years (3 Life Cycles)	8.5%	\$73,718	25	Thunder Bay (North)	\$53,351	25	Timmins (North)	\$55,060
26	Kenora (North)	60 Years (3 Life Cycles)	8.5%	\$74,422	26	Kenora (North)	\$54,014	26	Kenora (North)	\$56,241
27	Kapuskasing (North)	60 Years (3 Life Cycles)	8.5%	\$75,405	27	Kapuskasing (North)	\$55,010	27	Kapuskasing (North)	\$59,762

Table F1-1.58: Rankings of cities for rebates scenario (average construction type) at a discount rate of 8.5% (three life cycles of V.GSHP and H.GSHP and five life cycles of Traditional HVAC Applications for a 60 year project lifespan)

FIT + Rebates – (#4)

Total Present Value										
(FIT+Rebates) - (#4)										
#	City	Project Life Span	Discount Rate	V.GSHP	#	City	H.GSHP	#	City	Traditional
1	St. Catharines (South)	60 Years (3 Life Cycles)	8.5%	\$50,947	1	St. Catharines (South)	\$34,531	1	Cambridge (South)	\$44,996
2	Sarnia (South)	60 Years (3 Life Cycles)	8.5%	\$51,262	2	Sarnia (South)	\$34,835	2	Guelph (South)	\$45,615
3	Chatham (South)	60 Years (3 Life Cycles)	8.5%	\$51,340	3	Chatham (South)	\$34,924	3	Chatham (South)	\$46,879
4	Windsor (South)	60 Years (3 Life Cycles)	8.5%	\$51,355	4	Windsor (South)	\$34,943	4	Windsor (South)	\$46,919
5	Niagara Falls (South)	60 Years (3 Life Cycles)	8.5%	\$51,488	5	Niagara Falls (South)	\$35,070	5	Niagara Falls (South)	\$47,758
6	Simcoe (South)	60 Years (3 Life Cycles)	8.5%	\$51,829	6	Simcoe (South)	\$35,419	6	London (South)	\$48,339
7	Hamilton (South)	60 Years (3 Life Cycles)	8.5%	\$52,065	7	Hamilton (South)	\$35,654	7	St. Catharines (South)	\$48,900
8	Cambridge (South)	60 Years (3 Life Cycles)	8.5%	\$52,282	8	London (South)	\$35,867	8	Barrie (Distinct)	\$49,037
9	London (South)	60 Years (3 Life Cycles)	8.5%	\$52,286	9	Cambridge (South)	\$35,873	9	Sarnia (South)	\$49,189
10	Toronto (South)	60 Years (3 Life Cycles)	8.5%	\$52,295	10	Toronto (South)	\$35,894	10	Simcoe (South)	\$49,356
11	Trenton (South)	60 Years (3 Life Cycles)	8.5%	\$52,486	11	Trenton (South)	\$36,063	11	Toronto (South)	\$49,458
12	Guelph (South)	60 Years (3 Life Cycles)	8.5%	\$52,497	12	Guelph (South)	\$36,095	12	Hamilton (South)	\$49,994
13	Mt. Forest (South)	60 Years (3 Life Cycles)	8.5%	\$52,920	13	Kitchener-Waterloo (South)	\$36,236	13	Sault Ste. Marie (North)	\$49,974
14	Sault Ste. Marie (North)	60 Years (3 Life Cycles)	8.5%	\$53,588	14	Mt. Forest (South)	\$36,513	14	Ottawa (Distinct)	\$50,266
15	Kitchener-Waterloo (South)	60 Years (3 Life Cycles)	8.5%	\$63,790	15	Kingston (South)	\$36,518	15	North Bay (North)	\$50,396
16	Barrie (Distinct)	60 Years (3 Life Cycles)	8.5%	\$63,953	16	Warton (South)	\$36,614	16	Muskoka (Distinct)	\$50,797
17	Kingston (South)	60 Years (3 Life Cycles)	8.5%	\$64,033	17	Sault Ste. Marie (North)	\$37,201	17	Mt. Forest (South)	\$50,807
18	Ottawa (Distinct)	60 Years (3 Life Cycles)	8.5%	\$64,136	18	Barrie (Distinct)	\$43,465	18	Kitchener-Waterloo (South)	\$50,842
19	Warton (South)	60 Years (3 Life Cycles)	8.5%	\$64,152	19	Ottawa (Distinct)	\$43,686	19	Peterborough (Distinct)	\$50,895
20	Peterborough (Distinct)	60 Years (3 Life Cycles)	8.5%	\$64,435	20	Peterborough (Distinct)	\$43,981	20	Warton (South)	\$51,801
21	Muskoka (Distinct)	60 Years (3 Life Cycles)	8.5%	\$64,564	21	Muskoka (Distinct)	\$44,079	21	Trenton (South)	\$52,995
22	North Bay (North)	60 Years (3 Life Cycles)	8.5%	\$64,687	22	North Bay (North)	\$44,260	22	Kingston (South)	\$53,438
23	Sudbury (North)	60 Years (3 Life Cycles)	8.5%	\$65,360	23	Sudbury (North)	\$44,940	23	Thunder Bay (North)	\$53,415
24	Timmins (North)	60 Years (3 Life Cycles)	8.5%	\$66,500	24	Timmins (North)	\$46,076	24	Sudbury (North)	\$54,196
25	Thunder Bay (North)	60 Years (3 Life Cycles)	8.5%	\$66,619	25	Thunder Bay (North)	\$46,173	25	Timmins (North)	\$55,060
26	Kenora (North)	60 Years (3 Life Cycles)	8.5%	\$67,111	26	Kenora (North)	\$46,636	26	Kenora (North)	\$56,241
27	Kapuskasing (North)	60 Years (3 Life Cycles)	8.5%	\$67,798	27	Kapuskasing (North)	\$47,333	27	Kapuskasing (North)	\$59,762

Table F1-1.59: Rankings of cities for feed-in tariff + rebates scenario (average construction type) at a discount rate of 8.5% (three life cycles of V.GSHP and H.GSHP and five life cycles of Traditional HVAC Applications for a 60 year project lifespan)

(FIT + Rebates) + Carbon Taxes – (#5)

Total Present Value										
(FIT+Rebates) + Carbon Taxes - (#5)										
#	City	Project Life Span	Discount Rate	V.GSHP	#	City	H.GSHP	#	City	Traditional
1	St. Catharines (South)	60 Years (3 Life Cycles)	8.5%	\$50,947	1	St. Catharines (South)	\$34,531	1	Cambridge (South)	\$54,463
2	Sarnia (South)	60 Years (3 Life Cycles)	8.5%	\$51,262	2	Sarnia (South)	\$34,835	2	Chatham (South)	\$55,304
3	Chatham (South)	60 Years (3 Life Cycles)	8.5%	\$51,340	3	Chatham (South)	\$34,924	3	Windsor (South)	\$55,368
4	Windsor (South)	60 Years (3 Life Cycles)	8.5%	\$51,355	4	Windsor (South)	\$34,943	4	Guelph (South)	\$55,386
5	Niagara Falls (South)	60 Years (3 Life Cycles)	8.5%	\$51,488	5	Niagara Falls (South)	\$35,070	5	Niagara Falls (South)	\$56,291
6	Simcoe (South)	60 Years (3 Life Cycles)	8.5%	\$51,829	6	Simcoe (South)	\$35,419	6	St. Catharines (South)	\$57,206
7	Hamilton (South)	60 Years (3 Life Cycles)	8.5%	\$52,065	7	Hamilton (South)	\$35,654	7	London (South)	\$57,775
8	Cambridge (South)	60 Years (3 Life Cycles)	8.5%	\$52,282	8	London (South)	\$35,867	8	Sarnia (South)	\$57,849
9	London (South)	60 Years (3 Life Cycles)	8.5%	\$52,286	9	Cambridge (South)	\$35,873	9	Simcoe (South)	\$58,330
10	Toronto (South)	60 Years (3 Life Cycles)	8.5%	\$52,295	10	Toronto (South)	\$35,894	10	Barrie (Distinct)	\$58,761
11	Trenton (South)	60 Years (3 Life Cycles)	8.5%	\$52,486	11	Trenton (South)	\$36,063	11	Toronto (South)	\$58,946
12	Guelph (South)	60 Years (3 Life Cycles)	8.5%	\$52,497	12	Guelph (South)	\$36,095	12	Hamilton (South)	\$59,203
13	Mt. Forest (South)	60 Years (3 Life Cycles)	8.5%	\$52,920	13	Kitchener-Waterloo (South)	\$36,236	13	Ottawa (Distinct)	\$60,240
14	Sault Ste. Marie (North)	60 Years (3 Life Cycles)	8.5%	\$53,588	14	Mt. Forest (South)	\$36,513	14	Kitchener-Waterloo (South)	\$60,631
15	Kitchener-Waterloo (South)	60 Years (3 Life Cycles)	8.5%	\$63,790	15	Kingston (South)	\$36,518	15	Sault Ste. Marie (North)	\$60,721
16	Barrie (Distinct)	60 Years (3 Life Cycles)	8.5%	\$63,953	16	Warton (South)	\$36,614	16	North Bay (North)	\$60,929
17	Kingston (South)	60 Years (3 Life Cycles)	8.5%	\$64,033	17	Sault Ste. Marie (North)	\$37,201	17	Peterborough (Distinct)	\$61,153
18	Ottawa (Distinct)	60 Years (3 Life Cycles)	8.5%	\$64,136	18	Barrie (Distinct)	\$43,465	18	Muskoka (Distinct)	\$61,252
19	Warton (South)	60 Years (3 Life Cycles)	8.5%	\$64,152	19	Ottawa (Distinct)	\$43,686	19	Mt. Forest (South)	\$61,270
20	Peterborough (Distinct)	60 Years (3 Life Cycles)	8.5%	\$64,435	20	Peterborough (Distinct)	\$43,981	20	Warton (South)	\$61,968
21	Muskoka (Distinct)	60 Years (3 Life Cycles)	8.5%	\$64,564	21	Muskoka (Distinct)	\$44,079	21	Trenton (South)	\$62,547
22	North Bay (North)	60 Years (3 Life Cycles)	8.5%	\$64,687	22	North Bay (North)	\$44,260	22	Kingston (South)	\$63,274
23	Sudbury (North)	60 Years (3 Life Cycles)	8.5%	\$65,360	23	Sudbury (North)	\$44,940	23	Thunder Bay (North)	\$65,416
24	Timmins (North)	60 Years (3 Life Cycles)	8.5%	\$66,500	24	Timmins (North)	\$46,076	24	Sudbury (North)	\$65,544
25	Thunder Bay (North)	60 Years (3 Life Cycles)	8.5%	\$66,619	25	Thunder Bay (North)	\$46,173	25	Timmins (North)	\$67,644
26	Kenora (North)	60 Years (3 Life Cycles)	8.5%	\$67,111	26	Kenora (North)	\$46,636	26	Kenora (North)	\$68,417
27	Kapuskasing (North)	60 Years (3 Life Cycles)	8.5%	\$67,798	27	Kapuskasing (North)	\$47,333	27	Kapuskasing (North)	\$72,799

Table F1-1.60: Rankings of cities for feed-in tariff + rebates + carbon tax scenario (average construction type) at a discount rate of 8.5% (three life cycles of V.GSHP and H.GSHP and five life cycles of Traditional HVAC Applications for a 60 year project lifespan)

11. Three Life Cycles of V.GSHP and H.GSHP and Five Life Cycles of Traditional HVAC Applications @ 10% Discount Rate

Base Case Scenario

Total Present Value										
Base Case Scenario										
#	City	Project Life Span	Discount Rate	V.GSHP	#	City	H.GSHP	#	City	Traditional
1	St. Catharines (South)	60 Years (3 Life Cycles)	10%	\$56,768	1	St. Catharines (South)	\$41,635	1	Cambridge (South)	\$38,721
2	Sarnia (South)	60 Years (3 Life Cycles)	10%	\$57,149	2	Sarnia (South)	\$42,005	2	Guelph (South)	\$39,242
3	Chatham (South)	60 Years (3 Life Cycles)	10%	\$57,244	3	Chatham (South)	\$42,112	3	Chatham (South)	\$40,372
4	Windsor (South)	60 Years (3 Life Cycles)	10%	\$57,262	4	Windsor (South)	\$42,135	4	Windsor (South)	\$40,406
5	Niagara Falls (South)	60 Years (3 Life Cycles)	10%	\$57,423	5	Niagara Falls (South)	\$42,289	5	Niagara Falls (South)	\$41,117
6	Simcoe (South)	60 Years (3 Life Cycles)	10%	\$57,837	6	Simcoe (South)	\$42,713	6	London (South)	\$41,600
7	Hamilton (South)	60 Years (3 Life Cycles)	10%	\$58,123	7	Hamilton (South)	\$42,997	7	St. Catharines (South)	\$42,132
8	Cambridge (South)	60 Years (3 Life Cycles)	10%	\$58,386	8	London (South)	\$43,255	8	Barrie (Distinct)	\$42,234
9	London (South)	60 Years (3 Life Cycles)	10%	\$58,391	9	Cambridge (South)	\$43,263	9	Sarnia (South)	\$42,374
10	Toronto (South)	60 Years (3 Life Cycles)	10%	\$58,402	10	Toronto (South)	\$43,288	10	Simcoe (South)	\$42,512
11	Trenton (South)	60 Years (3 Life Cycles)	10%	\$58,634	11	Trenton (South)	\$43,493	11	Toronto (South)	\$42,594
12	Guelph (South)	60 Years (3 Life Cycles)	10%	\$58,647	12	Guelph (South)	\$43,532	12	Hamilton (South)	\$43,050
13	Mt. Forest (South)	60 Years (3 Life Cycles)	10%	\$59,159	13	Kitchener-Waterloo (South)	\$43,703	13	Sault Ste. Marie (North)	\$42,972
14	Sault Ste. Marie (North)	60 Years (3 Life Cycles)	10%	\$59,969	14	Mt. Forest (South)	\$44,038	14	Ottawa (Distinct)	\$43,273
15	Kitchener-Waterloo (South)	60 Years (3 Life Cycles)	10%	\$69,004	15	Kingston (South)	\$44,045	15	North Bay (North)	\$43,378
16	Barrie (Distinct)	60 Years (3 Life Cycles)	10%	\$69,201	16	Warton (South)	\$44,162	16	Muskoka (Distinct)	\$43,718
17	Kingston (South)	60 Years (3 Life Cycles)	10%	\$69,298	17	Sault Ste. Marie (North)	\$44,873	17	Mt. Forest (South)	\$43,727
18	Ottawa (Distinct)	60 Years (3 Life Cycles)	10%	\$69,423	18	Barrie (Distinct)	\$50,325	18	Kitchener-Waterloo (South)	\$43,763
19	Warton (South)	60 Years (3 Life Cycles)	10%	\$69,443	19	Ottawa (Distinct)	\$50,593	19	Peterborough (Distinct)	\$43,804
20	Peterborough (Distinct)	60 Years (3 Life Cycles)	10%	\$69,786	20	Peterborough (Distinct)	\$50,951	20	Warton (South)	\$44,618
21	Muskoka (Distinct)	60 Years (3 Life Cycles)	10%	\$69,942	21	Muskoka (Distinct)	\$51,069	21	Trenton (South)	\$45,681
22	North Bay (North)	60 Years (3 Life Cycles)	10%	\$70,091	22	North Bay (North)	\$51,290	22	Kingston (South)	\$46,054
23	Sudbury (North)	60 Years (3 Life Cycles)	10%	\$70,908	23	Sudbury (North)	\$52,114	23	Thunder Bay (North)	\$45,921
24	Timmins (North)	60 Years (3 Life Cycles)	10%	\$72,289	24	Timmins (North)	\$53,491	24	Sudbury (North)	\$46,635
25	Thunder Bay (North)	60 Years (3 Life Cycles)	10%	\$72,434	25	Thunder Bay (North)	\$53,609	25	Timmins (North)	\$47,310
26	Kenora (North)	60 Years (3 Life Cycles)	10%	\$73,030	26	Kenora (North)	\$54,171	26	Kenora (North)	\$48,360
27	Kapuskasing (North)	60 Years (3 Life Cycles)	10%	\$73,863	27	Kapuskasing (North)	\$55,015	27	Kapuskasing (North)	\$51,381

Table F1-1.61: Rankings of cities for base case scenario (average construction type) at a discount rate of 10% (three life cycles of V.GSHP and H.GSHP and five life cycles of Traditional HVAC Applications for a 60 year project lifespan)

Carbon Taxes – (#1)

Total Present Value										
Carbon Taxes - (#1)										
#	City	Project Life Span	Discount Rate	V.GSHP	#	City	H.GSHP	#	City	Traditional
1	St. Catharines (South)	60 Years (3 Life Cycles)	10%	\$56,768	1	St. Catharines (South)	\$41,635	1	Cambridge (South)	\$45,811
2	Sarnia (South)	60 Years (3 Life Cycles)	10%	\$57,149	2	Sarnia (South)	\$42,005	2	Guelph (South)	\$46,560
3	Chatham (South)	60 Years (3 Life Cycles)	10%	\$57,244	3	Chatham (South)	\$42,112	3	Chatham (South)	\$46,683
4	Windsor (South)	60 Years (3 Life Cycles)	10%	\$57,262	4	Windsor (South)	\$42,135	4	Windsor (South)	\$46,734
5	Niagara Falls (South)	60 Years (3 Life Cycles)	10%	\$57,423	5	Niagara Falls (South)	\$42,289	5	Niagara Falls (South)	\$47,507
6	Simcoe (South)	60 Years (3 Life Cycles)	10%	\$57,837	6	Simcoe (South)	\$42,713	6	St. Catharines (South)	\$48,352
7	Hamilton (South)	60 Years (3 Life Cycles)	10%	\$58,123	7	Hamilton (South)	\$42,997	7	London (South)	\$48,666
8	Cambridge (South)	60 Years (3 Life Cycles)	10%	\$58,386	8	London (South)	\$43,255	8	Sarnia (South)	\$48,859
9	London (South)	60 Years (3 Life Cycles)	10%	\$58,391	9	Cambridge (South)	\$43,263	9	Simcoe (South)	\$49,233
10	Toronto (South)	60 Years (3 Life Cycles)	10%	\$58,402	10	Toronto (South)	\$43,288	10	Barrie (Distinct)	\$49,517
11	Trenton (South)	60 Years (3 Life Cycles)	10%	\$58,634	11	Trenton (South)	\$43,493	11	Toronto (South)	\$49,699
12	Guelph (South)	60 Years (3 Life Cycles)	10%	\$58,647	12	Guelph (South)	\$43,532	12	Hamilton (South)	\$49,947
13	Mt. Forest (South)	60 Years (3 Life Cycles)	10%	\$59,159	13	Kitchener-Waterloo (South)	\$43,703	13	Ottawa (Distinct)	\$50,743
14	Sault Ste. Marie (North)	60 Years (3 Life Cycles)	10%	\$59,969	14	Mt. Forest (South)	\$44,038	14	Sault Ste. Marie (North)	\$51,020
15	Kitchener-Waterloo (South)	60 Years (3 Life Cycles)	10%	\$69,004	15	Kingston (South)	\$44,045	15	Kitchener-Waterloo (South)	\$51,094
16	Barrie (Distinct)	60 Years (3 Life Cycles)	10%	\$69,201	16	Warton (South)	\$44,162	16	North Bay (North)	\$51,266
17	Kingston (South)	60 Years (3 Life Cycles)	10%	\$69,298	17	Sault Ste. Marie (North)	\$44,873	17	Peterborough (Distinct)	\$51,486
18	Ottawa (Distinct)	60 Years (3 Life Cycles)	10%	\$69,423	18	Barrie (Distinct)	\$50,325	18	Muskoka (Distinct)	\$51,548
19	Warton (South)	60 Years (3 Life Cycles)	10%	\$69,443	19	Ottawa (Distinct)	\$50,593	19	Mt. Forest (South)	\$51,563
20	Peterborough (Distinct)	60 Years (3 Life Cycles)	10%	\$69,786	20	Peterborough (Distinct)	\$50,951	20	Warton (South)	\$52,232
21	Muskoka (Distinct)	60 Years (3 Life Cycles)	10%	\$69,942	21	Muskoka (Distinct)	\$51,069	21	Trenton (South)	\$52,835
22	North Bay (North)	60 Years (3 Life Cycles)	10%	\$70,091	22	North Bay (North)	\$51,290	22	Kingston (South)	\$53,420
23	Sudbury (North)	60 Years (3 Life Cycles)	10%	\$70,908	23	Sudbury (North)	\$52,114	23	Thunder Bay (North)	\$54,909
24	Timmins (North)	60 Years (3 Life Cycles)	10%	\$72,289	24	Timmins (North)	\$53,491	24	Sudbury (North)	\$55,134
25	Thunder Bay (North)	60 Years (3 Life Cycles)	10%	\$72,434	25	Thunder Bay (North)	\$53,609	25	Timmins (North)	\$56,734
26	Kenora (North)	60 Years (3 Life Cycles)	10%	\$73,030	26	Kenora (North)	\$54,171	26	Kenora (North)	\$57,478
27	Kapuskasing (North)	60 Years (3 Life Cycles)	10%	\$73,863	27	Kapuskasing (North)	\$55,015	27	Kapuskasing (North)	\$61,144

Table F1-1.62: Rankings of cities for carbon taxes scenario (average construction type) at a discount rate of 10% (three life cycles of V.GSHP and H.GSHP and five life cycles of Traditional HVAC Applications for a 60 year project lifespan)

FIT – (#2)

Total Present Value										
FIT - (#2)										
#	City	Project Life Span	Discount Rate	V.GSHP	#	City	H.GSHP	#	City	Traditional
1	St. Catharines (South)	60 Years (3 Life Cycles)	10%	\$52,277	1	St. Catharines (South)	\$37,114	1	Cambridge (South)	\$38,721
2	Sarnia (South)	60 Years (3 Life Cycles)	10%	\$52,543	2	Sarnia (South)	\$37,371	2	Guelph (South)	\$39,242
3	Chatham (South)	60 Years (3 Life Cycles)	10%	\$52,609	3	Chatham (South)	\$37,445	3	Chatham (South)	\$40,372
4	Windsor (South)	60 Years (3 Life Cycles)	10%	\$52,622	4	Windsor (South)	\$37,461	4	Windsor (South)	\$40,406
5	Niagara Falls (South)	60 Years (3 Life Cycles)	10%	\$52,734	5	Niagara Falls (South)	\$37,569	5	Niagara Falls (South)	\$41,117
6	Simcoe (South)	60 Years (3 Life Cycles)	10%	\$53,022	6	Simcoe (South)	\$37,864	6	London (South)	\$41,600
7	Hamilton (South)	60 Years (3 Life Cycles)	10%	\$53,221	7	Hamilton (South)	\$38,062	7	St. Catharines (South)	\$42,132
8	Cambridge (South)	60 Years (3 Life Cycles)	10%	\$53,405	8	London (South)	\$38,242	8	Barrie (Distinct)	\$42,234
9	London (South)	60 Years (3 Life Cycles)	10%	\$53,408	9	Cambridge (South)	\$38,248	9	Sarnia (South)	\$42,374
10	Toronto (South)	60 Years (3 Life Cycles)	10%	\$53,416	10	Toronto (South)	\$38,265	10	Simcoe (South)	\$42,512
11	Trenton (South)	60 Years (3 Life Cycles)	10%	\$53,577	11	Trenton (South)	\$38,408	11	Toronto (South)	\$42,594
12	Guelph (South)	60 Years (3 Life Cycles)	10%	\$53,586	12	Guelph (South)	\$38,435	12	Hamilton (South)	\$43,050
13	Mt. Forest (South)	60 Years (3 Life Cycles)	10%	\$53,943	13	Kitchener-Waterloo (South)	\$38,554	13	Sault Ste. Marie (North)	\$42,972
14	Sault Ste. Marie (North)	60 Years (3 Life Cycles)	10%	\$54,508	14	Mt. Forest (South)	\$38,788	14	Ottawa (Distinct)	\$43,273
15	Kitchener-Waterloo (South)	60 Years (3 Life Cycles)	10%	\$63,984	15	Kingston (South)	\$38,792	15	North Bay (North)	\$43,378
16	Barrie (Distinct)	60 Years (3 Life Cycles)	10%	\$64,122	16	Warton (South)	\$38,873	16	Muskoka (Distinct)	\$43,718
17	Kingston (South)	60 Years (3 Life Cycles)	10%	\$64,189	17	Sault Ste. Marie (North)	\$39,369	17	Mt. Forest (South)	\$43,727
18	Ottawa (Distinct)	60 Years (3 Life Cycles)	10%	\$64,276	18	Barrie (Distinct)	\$45,195	18	Kitchener-Waterloo (South)	\$43,763
19	Warton (South)	60 Years (3 Life Cycles)	10%	\$64,290	19	Ottawa (Distinct)	\$45,381	19	Peterborough (Distinct)	\$43,804
20	Peterborough (Distinct)	60 Years (3 Life Cycles)	10%	\$64,529	20	Peterborough (Distinct)	\$45,631	20	Warton (South)	\$44,618
21	Muskoka (Distinct)	60 Years (3 Life Cycles)	10%	\$64,638	21	Muskoka (Distinct)	\$45,713	21	Trenton (South)	\$45,681
22	North Bay (North)	60 Years (3 Life Cycles)	10%	\$64,742	22	North Bay (North)	\$45,866	22	Kingston (South)	\$46,054
23	Sudbury (North)	60 Years (3 Life Cycles)	10%	\$65,311	23	Sudbury (North)	\$46,441	23	Thunder Bay (North)	\$45,921
24	Timmins (North)	60 Years (3 Life Cycles)	10%	\$66,273	24	Timmins (North)	\$47,400	24	Sudbury (North)	\$46,635
25	Thunder Bay (North)	60 Years (3 Life Cycles)	10%	\$66,374	25	Thunder Bay (North)	\$47,482	25	Timmins (North)	\$47,310
26	Kenora (North)	60 Years (3 Life Cycles)	10%	\$66,789	26	Kenora (North)	\$47,873	26	Kenora (North)	\$48,360
27	Kapuskasing (North)	60 Years (3 Life Cycles)	10%	\$67,369	27	Kapuskasing (North)	\$48,462	27	Kapuskasing (North)	\$51,381

Table F1-1.63: Rankings of cities for feed-in tariff scenario (average construction type) at a discount rate of 10% (three life cycles of V.GSHP and H.GSHP and five life cycles of Traditional HVAC Applications for a 60 year project lifespan)

Rebates – (#3)

Total Present Value										
Rebates - (#3)										
#	City	Project Life Span	Discount Rate	V.GSHP	#	City	H.GSHP	#	City	Traditional
1	St. Catharines (South)	60 Years (3 Life Cycles)	10%	\$50,419	1	St. Catharines (South)	\$35,287	1	Cambridge (South)	\$38,721
2	Sarnia (South)	60 Years (3 Life Cycles)	10%	\$50,800	2	Sarnia (South)	\$35,656	2	Guelph (South)	\$39,242
3	Chatham (South)	60 Years (3 Life Cycles)	10%	\$50,896	3	Chatham (South)	\$35,763	3	Chatham (South)	\$40,372
4	Windsor (South)	60 Years (3 Life Cycles)	10%	\$50,914	4	Windsor (South)	\$35,786	4	Windsor (South)	\$40,406
5	Niagara Falls (South)	60 Years (3 Life Cycles)	10%	\$51,075	5	Niagara Falls (South)	\$35,941	5	Niagara Falls (South)	\$41,117
6	Simcoe (South)	60 Years (3 Life Cycles)	10%	\$51,489	6	Simcoe (South)	\$36,364	6	London (South)	\$41,600
7	Hamilton (South)	60 Years (3 Life Cycles)	10%	\$51,774	7	Hamilton (South)	\$36,649	7	St. Catharines (South)	\$42,132
8	Cambridge (South)	60 Years (3 Life Cycles)	10%	\$52,037	8	London (South)	\$36,906	8	Barrie (Distinct)	\$42,234
9	London (South)	60 Years (3 Life Cycles)	10%	\$52,042	9	Cambridge (South)	\$36,915	9	Sarnia (South)	\$42,374
10	Toronto (South)	60 Years (3 Life Cycles)	10%	\$52,054	10	Toronto (South)	\$36,939	10	Simcoe (South)	\$42,512
11	Trenton (South)	60 Years (3 Life Cycles)	10%	\$52,285	11	Trenton (South)	\$37,145	11	Toronto (South)	\$42,594
12	Guelph (South)	60 Years (3 Life Cycles)	10%	\$52,298	12	Guelph (South)	\$37,184	12	Hamilton (South)	\$43,050
13	Mt. Forest (South)	60 Years (3 Life Cycles)	10%	\$52,811	13	Kitchener-Waterloo (South)	\$37,355	13	Sault Ste. Marie (North)	\$42,972
14	Sault Ste. Marie (North)	60 Years (3 Life Cycles)	10%	\$53,621	14	Mt. Forest (South)	\$37,690	14	Ottawa (Distinct)	\$43,273
15	Kitchener-Waterloo (South)	60 Years (3 Life Cycles)	10%	\$62,656	15	Kingston (South)	\$37,697	15	North Bay (North)	\$43,378
16	Barrie (Distinct)	60 Years (3 Life Cycles)	10%	\$62,853	16	Warton (South)	\$37,813	16	Muskoka (Distinct)	\$43,718
17	Kingston (South)	60 Years (3 Life Cycles)	10%	\$62,950	17	Sault Ste. Marie (North)	\$38,524	17	Mt. Forest (South)	\$43,727
18	Ottawa (Distinct)	60 Years (3 Life Cycles)	10%	\$63,074	18	Barrie (Distinct)	\$43,977	18	Kitchener-Waterloo (South)	\$43,763
19	Warton (South)	60 Years (3 Life Cycles)	10%	\$63,094	19	Ottawa (Distinct)	\$44,245	19	Peterborough (Distinct)	\$43,804
20	Peterborough (Distinct)	60 Years (3 Life Cycles)	10%	\$63,438	20	Peterborough (Distinct)	\$44,603	20	Warton (South)	\$44,618
21	Muskoka (Distinct)	60 Years (3 Life Cycles)	10%	\$63,594	21	Muskoka (Distinct)	\$44,721	21	Trenton (South)	\$45,681
22	North Bay (North)	60 Years (3 Life Cycles)	10%	\$63,743	22	North Bay (North)	\$44,941	22	Kingston (South)	\$46,054
23	Sudbury (North)	60 Years (3 Life Cycles)	10%	\$64,559	23	Sudbury (North)	\$45,766	23	Thunder Bay (North)	\$45,921
24	Timmins (North)	60 Years (3 Life Cycles)	10%	\$65,941	24	Timmins (North)	\$47,142	24	Sudbury (North)	\$46,635
25	Thunder Bay (North)	60 Years (3 Life Cycles)	10%	\$66,085	25	Thunder Bay (North)	\$47,261	25	Timmins (North)	\$47,310
26	Kenora (North)	60 Years (3 Life Cycles)	10%	\$66,682	26	Kenora (North)	\$47,822	26	Kenora (North)	\$48,360
27	Kapuskasing (North)	60 Years (3 Life Cycles)	10%	\$67,515	27	Kapuskasing (North)	\$48,667	27	Kapuskasing (North)	\$51,381

Table F1-1.64: Rankings of cities for rebates scenario (average construction type) at a discount rate of 10% (three life cycles of V.GSHP and H.GSHP and five life cycles of Traditional HVAC Applications for a 60 year project lifespan)

FIT + Rebates – (#4)

Total Present Value										
(FIT+Rebates) - (#4)										
#	City	Project Life Span	Discount Rate	V.GSHP	#	City	H.GSHP	#	City	Traditional
1	St. Catharines (South)	60 Years (3 Life Cycles)	10%	\$45,929	1	St. Catharines (South)	\$30,765	1	Cambridge (South)	\$38,721
2	Sarnia (South)	60 Years (3 Life Cycles)	10%	\$46,195	2	Sarnia (South)	\$31,023	2	Guelph (South)	\$39,242
3	Chatham (South)	60 Years (3 Life Cycles)	10%	\$46,261	3	Chatham (South)	\$31,097	3	Chatham (South)	\$40,372
4	Windsor (South)	60 Years (3 Life Cycles)	10%	\$46,274	4	Windsor (South)	\$31,113	4	Windsor (South)	\$40,406
5	Niagara Falls (South)	60 Years (3 Life Cycles)	10%	\$46,386	5	Niagara Falls (South)	\$31,221	5	Niagara Falls (South)	\$41,117
6	Simcoe (South)	60 Years (3 Life Cycles)	10%	\$46,674	6	Simcoe (South)	\$31,516	6	London (South)	\$41,600
7	Hamilton (South)	60 Years (3 Life Cycles)	10%	\$46,873	7	Hamilton (South)	\$31,714	7	St. Catharines (South)	\$42,132
8	Cambridge (South)	60 Years (3 Life Cycles)	10%	\$47,056	8	London (South)	\$31,893	8	Barrie (Distinct)	\$42,234
9	London (South)	60 Years (3 Life Cycles)	10%	\$47,060	9	Cambridge (South)	\$31,899	9	Sarnia (South)	\$42,374
10	Toronto (South)	60 Years (3 Life Cycles)	10%	\$47,068	10	Toronto (South)	\$31,916	10	Simcoe (South)	\$42,512
11	Trenton (South)	60 Years (3 Life Cycles)	10%	\$47,229	11	Trenton (South)	\$32,059	11	Toronto (South)	\$42,594
12	Guelph (South)	60 Years (3 Life Cycles)	10%	\$47,238	12	Guelph (South)	\$32,087	12	Hamilton (South)	\$43,050
13	Mt. Forest (South)	60 Years (3 Life Cycles)	10%	\$47,595	13	Kitchener-Waterloo (South)	\$32,206	13	Sault Ste. Marie (North)	\$42,972
14	Sault Ste. Marie (North)	60 Years (3 Life Cycles)	10%	\$48,159	14	Mt. Forest (South)	\$32,439	14	Ottawa (Distinct)	\$43,273
15	Kitchener-Waterloo (South)	60 Years (3 Life Cycles)	10%	\$57,636	15	Kingston (South)	\$32,444	15	North Bay (North)	\$43,378
16	Barrie (Distinct)	60 Years (3 Life Cycles)	10%	\$57,773	16	Warton (South)	\$32,525	16	Muskoka (Distinct)	\$43,718
17	Kingston (South)	60 Years (3 Life Cycles)	10%	\$57,841	17	Sault Ste. Marie (North)	\$33,021	17	Mt. Forest (South)	\$43,727
18	Ottawa (Distinct)	60 Years (3 Life Cycles)	10%	\$57,928	18	Barrie (Distinct)	\$38,846	18	Kitchener-Waterloo (South)	\$43,763
19	Warton (South)	60 Years (3 Life Cycles)	10%	\$57,942	19	Ottawa (Distinct)	\$39,033	19	Peterborough (Distinct)	\$43,804
20	Peterborough (Distinct)	60 Years (3 Life Cycles)	10%	\$58,181	20	Peterborough (Distinct)	\$39,282	20	Warton (South)	\$44,618
21	Muskoka (Distinct)	60 Years (3 Life Cycles)	10%	\$58,290	21	Muskoka (Distinct)	\$39,365	21	Trenton (South)	\$45,681
22	North Bay (North)	60 Years (3 Life Cycles)	10%	\$58,394	22	North Bay (North)	\$39,518	22	Kingston (South)	\$46,054
23	Sudbury (North)	60 Years (3 Life Cycles)	10%	\$58,962	23	Sudbury (North)	\$40,093	23	Thunder Bay (North)	\$45,921
24	Timmins (North)	60 Years (3 Life Cycles)	10%	\$59,925	24	Timmins (North)	\$41,051	24	Sudbury (North)	\$46,635
25	Thunder Bay (North)	60 Years (3 Life Cycles)	10%	\$60,025	25	Thunder Bay (North)	\$41,134	25	Timmins (North)	\$47,310
26	Kenora (North)	60 Years (3 Life Cycles)	10%	\$60,441	26	Kenora (North)	\$41,525	26	Kenora (North)	\$48,360
27	Kapuskasing (North)	60 Years (3 Life Cycles)	10%	\$61,021	27	Kapuskasing (North)	\$42,113	27	Kapuskasing (North)	\$51,381

Table F1-1.65: Rankings of cities for feed-in tariff + rebates scenario (average construction type) at a discount rate of 10% (three life cycles of V.GSHP and H.GSHP and five life cycles of Traditional HVAC Applications for a 60 year project lifespan)

(FIT + Rebates) + Carbon Taxes – (#5)

Total Present Value										
(FIT+Rebates) + Carbon Taxes - (#5)										
#	City	Project Life Span	Discount Rate	V.GSHP	#	City	H.GSHP	#	City	Traditional
1	St. Catharines (South)	60 Years (3 Life Cycles)	10%	\$45,929	1	St. Catharines (South)	\$30,765	1	Cambridge (South)	\$45,811
2	Sarnia (South)	60 Years (3 Life Cycles)	10%	\$46,195	2	Sarnia (South)	\$31,023	2	Guelph (South)	\$46,560
3	Chatham (South)	60 Years (3 Life Cycles)	10%	\$46,261	3	Chatham (South)	\$31,097	3	Chatham (South)	\$46,683
4	Windsor (South)	60 Years (3 Life Cycles)	10%	\$46,274	4	Windsor (South)	\$31,113	4	Windsor (South)	\$46,734
5	Niagara Falls (South)	60 Years (3 Life Cycles)	10%	\$46,386	5	Niagara Falls (South)	\$31,221	5	Niagara Falls (South)	\$47,507
6	Simcoe (South)	60 Years (3 Life Cycles)	10%	\$46,674	6	Simcoe (South)	\$31,516	6	St. Catharines (South)	\$48,352
7	Hamilton (South)	60 Years (3 Life Cycles)	10%	\$46,873	7	Hamilton (South)	\$31,714	7	London (South)	\$48,666
8	Cambridge (South)	60 Years (3 Life Cycles)	10%	\$47,056	8	London (South)	\$31,893	8	Sarnia (South)	\$48,859
9	London (South)	60 Years (3 Life Cycles)	10%	\$47,060	9	Cambridge (South)	\$31,899	9	Simcoe (South)	\$49,233
10	Toronto (South)	60 Years (3 Life Cycles)	10%	\$47,068	10	Toronto (South)	\$31,916	10	Barrie (Distinct)	\$49,517
11	Trenton (South)	60 Years (3 Life Cycles)	10%	\$47,229	11	Trenton (South)	\$32,059	11	Toronto (South)	\$49,699
12	Guelph (South)	60 Years (3 Life Cycles)	10%	\$47,238	12	Guelph (South)	\$32,087	12	Hamilton (South)	\$49,947
13	Mt. Forest (South)	60 Years (3 Life Cycles)	10%	\$47,595	13	Kitchener-Waterloo (South)	\$32,206	13	Ottawa (Distinct)	\$50,743
14	Sault Ste. Marie (North)	60 Years (3 Life Cycles)	10%	\$48,159	14	Mt. Forest (South)	\$32,439	14	Sault Ste. Marie (North)	\$51,020
15	Kitchener-Waterloo (South)	60 Years (3 Life Cycles)	10%	\$57,636	15	Kingston (South)	\$32,444	15	Kitchener-Waterloo (South)	\$51,094
16	Barrie (Distinct)	60 Years (3 Life Cycles)	10%	\$57,773	16	Warton (South)	\$32,525	16	North Bay (North)	\$51,266
17	Kingston (South)	60 Years (3 Life Cycles)	10%	\$57,841	17	Sault Ste. Marie (North)	\$33,021	17	Peterborough (Distinct)	\$51,486
18	Ottawa (Distinct)	60 Years (3 Life Cycles)	10%	\$57,928	18	Barrie (Distinct)	\$38,846	18	Muskoka (Distinct)	\$51,548
19	Warton (South)	60 Years (3 Life Cycles)	10%	\$57,942	19	Ottawa (Distinct)	\$39,033	19	Mt. Forest (South)	\$51,563
20	Peterborough (Distinct)	60 Years (3 Life Cycles)	10%	\$58,181	20	Peterborough (Distinct)	\$39,282	20	Warton (South)	\$52,232
21	Muskoka (Distinct)	60 Years (3 Life Cycles)	10%	\$58,290	21	Muskoka (Distinct)	\$39,365	21	Trenton (South)	\$52,835
22	North Bay (North)	60 Years (3 Life Cycles)	10%	\$58,394	22	North Bay (North)	\$39,518	22	Kingston (South)	\$53,420
23	Sudbury (North)	60 Years (3 Life Cycles)	10%	\$58,962	23	Sudbury (North)	\$40,093	23	Thunder Bay (North)	\$54,909
24	Timmins (North)	60 Years (3 Life Cycles)	10%	\$59,925	24	Timmins (North)	\$41,051	24	Sudbury (North)	\$55,134
25	Thunder Bay (North)	60 Years (3 Life Cycles)	10%	\$60,025	25	Thunder Bay (North)	\$41,134	25	Timmins (North)	\$56,734
26	Kenora (North)	60 Years (3 Life Cycles)	10%	\$60,441	26	Kenora (North)	\$41,525	26	Kenora (North)	\$57,478
27	Kapuskasing (North)	60 Years (3 Life Cycles)	10%	\$61,021	27	Kapuskasing (North)	\$42,113	27	Kapuskasing (North)	\$61,144

Table F1-1.66: Rankings of cities for feed-in tariff + rebates + carbon tax scenario (average construction type) at a discount rate of 10% (three life cycles of V.GSHP and H.GSHP and five life cycles of Traditional HVAC Applications for a 60 year project lifespan)

12. Three Life Cycles of V.GSHP and H.GSHP and Five Life Cycles of Traditional HVAC Applications @ 12% Discount Rate

Base Case Scenario

Total Present Value										
Base Case Scenario										
#	City	Project Life Span	Discount Rate	V.GSHP	#	City	H.GSHP	#	City	Traditional
1	St. Catharines (South)	60 Years (3 Life Cycles)	12%	\$51,045	1	St. Catharines (South)	\$36,997	1	Cambridge (South)	\$32,921
2	Sarnia (South)	60 Years (3 Life Cycles)	12%	\$51,360	2	Sarnia (South)	\$37,303	2	Guelph (South)	\$33,350
3	Chatham (South)	60 Years (3 Life Cycles)	12%	\$51,439	3	Chatham (South)	\$37,392	3	Chatham (South)	\$34,358
4	Windsor (South)	60 Years (3 Life Cycles)	12%	\$51,454	4	Windsor (South)	\$37,411	4	Windsor (South)	\$34,386
5	Niagara Falls (South)	60 Years (3 Life Cycles)	12%	\$51,588	5	Niagara Falls (South)	\$37,539	5	Niagara Falls (South)	\$34,974
6	Simcoe (South)	60 Years (3 Life Cycles)	12%	\$51,931	6	Simcoe (South)	\$37,890	6	London (South)	\$35,367
7	Hamilton (South)	60 Years (3 Life Cycles)	12%	\$52,168	7	Hamilton (South)	\$38,126	7	St. Catharines (South)	\$35,877
8	Cambridge (South)	60 Years (3 Life Cycles)	12%	\$52,385	8	London (South)	\$38,339	8	Barrie (Distinct)	\$35,950
9	London (South)	60 Years (3 Life Cycles)	12%	\$52,390	9	Cambridge (South)	\$38,346	9	Sarnia (South)	\$36,075
10	Toronto (South)	60 Years (3 Life Cycles)	12%	\$52,399	10	Toronto (South)	\$38,367	10	Simcoe (South)	\$36,186
11	Trenton (South)	60 Years (3 Life Cycles)	12%	\$52,591	11	Trenton (South)	\$38,537	11	Toronto (South)	\$36,250
12	Guelph (South)	60 Years (3 Life Cycles)	12%	\$52,602	12	Guelph (South)	\$38,569	12	Hamilton (South)	\$36,631
13	Mt. Forest (South)	60 Years (3 Life Cycles)	12%	\$53,027	13	Kitchener-Waterloo (South)	\$38,711	13	Sault Ste. Marie (North)	\$36,493
14	Sault Ste. Marie (North)	60 Years (3 Life Cycles)	12%	\$53,698	14	Mt. Forest (South)	\$38,989	14	Ottawa (Distinct)	\$36,809
15	Kitchener-Waterloo (South)	60 Years (3 Life Cycles)	12%	\$62,185	15	Kingston (South)	\$38,994	15	North Bay (North)	\$36,891
16	Barrie (Distinct)	60 Years (3 Life Cycles)	12%	\$62,348	16	Warton (South)	\$39,091	16	Muskoka (Distinct)	\$37,174
17	Kingston (South)	60 Years (3 Life Cycles)	12%	\$62,429	17	Sault Ste. Marie (North)	\$39,680	17	Mt. Forest (South)	\$37,181
18	Ottawa (Distinct)	60 Years (3 Life Cycles)	12%	\$62,532	18	Barrie (Distinct)	\$44,822	18	Kitchener-Waterloo (South)	\$37,217
19	Warton (South)	60 Years (3 Life Cycles)	12%	\$62,549	19	Ottawa (Distinct)	\$45,044	19	Peterborough (Distinct)	\$37,246
20	Peterborough (Distinct)	60 Years (3 Life Cycles)	12%	\$62,833	20	Peterborough (Distinct)	\$45,341	20	Warton (South)	\$37,982
21	Muskoka (Distinct)	60 Years (3 Life Cycles)	12%	\$62,962	21	Muskoka (Distinct)	\$45,439	21	Trenton (South)	\$38,928
22	North Bay (North)	60 Years (3 Life Cycles)	12%	\$63,086	22	North Bay (North)	\$45,621	22	Kingston (South)	\$39,235
23	Sudbury (North)	60 Years (3 Life Cycles)	12%	\$63,763	23	Sudbury (North)	\$46,305	23	Thunder Bay (North)	\$38,986
24	Timmins (North)	60 Years (3 Life Cycles)	12%	\$64,908	24	Timmins (North)	\$47,445	24	Sudbury (North)	\$39,644
25	Thunder Bay (North)	60 Years (3 Life Cycles)	12%	\$65,027	25	Thunder Bay (North)	\$47,543	25	Timmins (North)	\$40,132
26	Kenora (North)	60 Years (3 Life Cycles)	12%	\$65,522	26	Kenora (North)	\$48,009	26	Kenora (North)	\$41,066
27	Kapuskasing (North)	60 Years (3 Life Cycles)	12%	\$66,212	27	Kapuskasing (North)	\$48,709	27	Kapuskasing (North)	\$43,622

Table F1-1.67: Rankings of cities for base case scenario (average construction type) at a discount rate of 12% (three life cycles of V.GSHP and H.GSHP and five life cycles of Traditional HVAC Applications for a 60 year project lifespan)

Carbon Taxes – (#1)

Total Present Value										
Carbon Taxes - (#1)										
#	City	Project Life Span	Discount Rate	V.GSHP	#	City	H.GSHP	#	City	Traditional
1	St. Catharines (South)	60 Years (3 Life Cycles)	12%	\$51,045	1	St. Catharines (South)	\$36,997	1	Cambridge (South)	\$38,000
2	Sarnia (South)	60 Years (3 Life Cycles)	12%	\$51,360	2	Sarnia (South)	\$37,303	2	Guelph (South)	\$38,593
3	Chatham (South)	60 Years (3 Life Cycles)	12%	\$51,439	3	Chatham (South)	\$37,392	3	Chatham (South)	\$38,879
4	Windsor (South)	60 Years (3 Life Cycles)	12%	\$51,454	4	Windsor (South)	\$37,411	4	Windsor (South)	\$38,919
5	Niagara Falls (South)	60 Years (3 Life Cycles)	12%	\$51,588	5	Niagara Falls (South)	\$37,539	5	Niagara Falls (South)	\$39,552
6	Simcoe (South)	60 Years (3 Life Cycles)	12%	\$51,931	6	Simcoe (South)	\$37,890	6	St. Catharines (South)	\$40,334
7	Hamilton (South)	60 Years (3 Life Cycles)	12%	\$52,168	7	Hamilton (South)	\$38,126	7	London (South)	\$40,429
8	Cambridge (South)	60 Years (3 Life Cycles)	12%	\$52,385	8	London (South)	\$38,339	8	Sarnia (South)	\$40,721
9	London (South)	60 Years (3 Life Cycles)	12%	\$52,390	9	Cambridge (South)	\$38,346	9	Simcoe (South)	\$41,002
10	Toronto (South)	60 Years (3 Life Cycles)	12%	\$52,399	10	Toronto (South)	\$38,367	10	Barrie (Distinct)	\$41,168
11	Trenton (South)	60 Years (3 Life Cycles)	12%	\$52,591	11	Trenton (South)	\$38,537	11	Toronto (South)	\$41,340
12	Guelph (South)	60 Years (3 Life Cycles)	12%	\$52,602	12	Guelph (South)	\$38,569	12	Hamilton (South)	\$41,572
13	Mt. Forest (South)	60 Years (3 Life Cycles)	12%	\$53,027	13	Kitchener-Waterloo (South)	\$38,711	13	Ottawa (Distinct)	\$42,161
14	Sault Ste. Marie (North)	60 Years (3 Life Cycles)	12%	\$53,698	14	Mt. Forest (South)	\$38,989	14	Sault Ste. Marie (North)	\$42,259
15	Kitchener-Waterloo (South)	60 Years (3 Life Cycles)	12%	\$62,185	15	Kingston (South)	\$38,994	15	Kitchener-Waterloo (South)	\$42,469
16	Barrie (Distinct)	60 Years (3 Life Cycles)	12%	\$62,348	16	Warton (South)	\$39,091	16	North Bay (North)	\$42,542
17	Kingston (South)	60 Years (3 Life Cycles)	12%	\$62,429	17	Sault Ste. Marie (North)	\$39,680	17	Peterborough (Distinct)	\$42,750
18	Ottawa (Distinct)	60 Years (3 Life Cycles)	12%	\$62,532	18	Barrie (Distinct)	\$44,822	18	Muskoka (Distinct)	\$42,784
19	Warton (South)	60 Years (3 Life Cycles)	12%	\$62,549	19	Ottawa (Distinct)	\$45,044	19	Mt. Forest (South)	\$42,795
20	Peterborough (Distinct)	60 Years (3 Life Cycles)	12%	\$62,833	20	Peterborough (Distinct)	\$45,341	20	Warton (South)	\$43,437
21	Muskoka (Distinct)	60 Years (3 Life Cycles)	12%	\$62,962	21	Muskoka (Distinct)	\$45,439	21	Trenton (South)	\$44,053
22	North Bay (North)	60 Years (3 Life Cycles)	12%	\$63,086	22	North Bay (North)	\$45,621	22	Kingston (South)	\$44,512
23	Sudbury (North)	60 Years (3 Life Cycles)	12%	\$63,763	23	Sudbury (North)	\$46,305	23	Thunder Bay (North)	\$45,425
24	Timmins (North)	60 Years (3 Life Cycles)	12%	\$64,908	24	Timmins (North)	\$47,445	24	Sudbury (North)	\$45,732
25	Thunder Bay (North)	60 Years (3 Life Cycles)	12%	\$65,027	25	Thunder Bay (North)	\$47,543	25	Timmins (North)	\$46,884
26	Kenora (North)	60 Years (3 Life Cycles)	12%	\$65,522	26	Kenora (North)	\$48,009	26	Kenora (North)	\$47,599
27	Kapuskasing (North)	60 Years (3 Life Cycles)	12%	\$66,212	27	Kapuskasing (North)	\$48,709	27	Kapuskasing (North)	\$50,617

Table F1-1.68: Rankings of cities for carbon taxes scenario (average construction type) at a discount rate of 12% (three life cycles of V.GSHP and H.GSHP and five life cycles of Traditional HVAC Applications for a 60 year project lifespan)

FIT – (#2)

Total Present Value										
FIT - (#2)										
#	City	Project Life Span	Discount Rate	V.GSHP	#	City	H.GSHP	#	City	Traditional
1	St. Catharines (South)	60 Years (3 Life Cycles)	12%	\$47,295	1	St. Catharines (South)	\$33,221	1	Cambridge (South)	\$32,921
2	Sarnia (South)	60 Years (3 Life Cycles)	12%	\$47,514	2	Sarnia (South)	\$33,433	2	Guelph (South)	\$33,350
3	Chatham (South)	60 Years (3 Life Cycles)	12%	\$47,569	3	Chatham (South)	\$33,495	3	Chatham (South)	\$34,358
4	Windsor (South)	60 Years (3 Life Cycles)	12%	\$47,579	4	Windsor (South)	\$33,508	4	Windsor (South)	\$34,386
5	Niagara Falls (South)	60 Years (3 Life Cycles)	12%	\$47,672	5	Niagara Falls (South)	\$33,597	5	Niagara Falls (South)	\$34,974
6	Simcoe (South)	60 Years (3 Life Cycles)	12%	\$47,910	6	Simcoe (South)	\$33,841	6	London (South)	\$35,367
7	Hamilton (South)	60 Years (3 Life Cycles)	12%	\$48,074	7	Hamilton (South)	\$34,004	7	St. Catharines (South)	\$35,877
8	Cambridge (South)	60 Years (3 Life Cycles)	12%	\$48,225	8	London (South)	\$34,153	8	Barrie (Distinct)	\$35,950
9	London (South)	60 Years (3 Life Cycles)	12%	\$48,228	9	Cambridge (South)	\$34,157	9	Sarnia (South)	\$36,075
10	Toronto (South)	60 Years (3 Life Cycles)	12%	\$48,235	10	Toronto (South)	\$34,172	10	Simcoe (South)	\$36,186
11	Trenton (South)	60 Years (3 Life Cycles)	12%	\$48,368	11	Trenton (South)	\$34,290	11	Toronto (South)	\$36,250
12	Guelph (South)	60 Years (3 Life Cycles)	12%	\$48,376	12	Guelph (South)	\$34,312	12	Hamilton (South)	\$36,631
13	Mt. Forest (South)	60 Years (3 Life Cycles)	12%	\$48,671	13	Kitchener-Waterloo (South)	\$34,411	13	Sault Ste. Marie (North)	\$36,493
14	Sault Ste. Marie (North)	60 Years (3 Life Cycles)	12%	\$49,137	14	Mt. Forest (South)	\$34,604	14	Ottawa (Distinct)	\$36,809
15	Kitchener-Waterloo (South)	60 Years (3 Life Cycles)	12%	\$57,993	15	Kingston (South)	\$34,607	15	North Bay (North)	\$36,891
16	Barrie (Distinct)	60 Years (3 Life Cycles)	12%	\$58,107	16	Warton (South)	\$34,674	16	Muskoka (Distinct)	\$37,174
17	Kingston (South)	60 Years (3 Life Cycles)	12%	\$58,162	17	Sault Ste. Marie (North)	\$35,084	17	Mt. Forest (South)	\$37,181
18	Ottawa (Distinct)	60 Years (3 Life Cycles)	12%	\$58,234	18	Barrie (Distinct)	\$40,537	18	Kitchener-Waterloo (South)	\$37,217
19	Warton (South)	60 Years (3 Life Cycles)	12%	\$58,245	19	Ottawa (Distinct)	\$40,691	19	Peterborough (Distinct)	\$37,246
20	Peterborough (Distinct)	60 Years (3 Life Cycles)	12%	\$58,443	20	Peterborough (Distinct)	\$40,897	20	Warton (South)	\$37,982
21	Muskoka (Distinct)	60 Years (3 Life Cycles)	12%	\$58,533	21	Muskoka (Distinct)	\$40,965	21	Trenton (South)	\$38,928
22	North Bay (North)	60 Years (3 Life Cycles)	12%	\$58,619	22	North Bay (North)	\$41,092	22	Kingston (South)	\$39,235
23	Sudbury (North)	60 Years (3 Life Cycles)	12%	\$59,088	23	Sudbury (North)	\$41,566	23	Thunder Bay (North)	\$38,986
24	Timmins (North)	60 Years (3 Life Cycles)	12%	\$59,883	24	Timmins (North)	\$42,358	24	Sudbury (North)	\$39,644
25	Thunder Bay (North)	60 Years (3 Life Cycles)	12%	\$59,966	25	Thunder Bay (North)	\$42,427	25	Timmins (North)	\$40,132
26	Kenora (North)	60 Years (3 Life Cycles)	12%	\$60,310	26	Kenora (North)	\$42,750	26	Kenora (North)	\$41,066
27	Kapuskasing (North)	60 Years (3 Life Cycles)	12%	\$60,789	27	Kapuskasing (North)	\$43,236	27	Kapuskasing (North)	\$43,622

Table F1-1.69: Rankings of cities for feed-in tariff scenario (average construction type) at a discount rate of 12% (three life cycles of V.GSHP and H.GSHP and five life cycles of Traditional HVAC Applications for a 60 year project lifespan)

Rebates – (#3)

Total Present Value										
Rebates - (#3)										
#	City	Project Life Span	Discount Rate	V.GSHP	#	City	H.GSHP	#	City	Traditional
1	St. Catharines (South)	60 Years (3 Life Cycles)	12%	\$45,156	1	St. Catharines (South)	\$31,108	1	Cambridge (South)	\$32,921
2	Sarnia (South)	60 Years (3 Life Cycles)	12%	\$45,472	2	Sarnia (South)	\$31,414	2	Guelph (South)	\$33,350
3	Chatham (South)	60 Years (3 Life Cycles)	12%	\$45,550	3	Chatham (South)	\$31,503	3	Chatham (South)	\$34,358
4	Windsor (South)	60 Years (3 Life Cycles)	12%	\$45,565	4	Windsor (South)	\$31,522	4	Windsor (South)	\$34,386
5	Niagara Falls (South)	60 Years (3 Life Cycles)	12%	\$45,699	5	Niagara Falls (South)	\$31,650	5	Niagara Falls (South)	\$34,974
6	Simcoe (South)	60 Years (3 Life Cycles)	12%	\$46,042	6	Simcoe (South)	\$32,001	6	London (South)	\$35,367
7	Hamilton (South)	60 Years (3 Life Cycles)	12%	\$46,279	7	Hamilton (South)	\$32,237	7	St. Catharines (South)	\$35,877
8	Cambridge (South)	60 Years (3 Life Cycles)	12%	\$46,497	8	London (South)	\$32,450	8	Barrie (Distinct)	\$35,950
9	London (South)	60 Years (3 Life Cycles)	12%	\$46,501	9	Cambridge (South)	\$32,457	9	Sarnia (South)	\$36,075
10	Toronto (South)	60 Years (3 Life Cycles)	12%	\$46,510	10	Toronto (South)	\$32,478	10	Simcoe (South)	\$36,186
11	Trenton (South)	60 Years (3 Life Cycles)	12%	\$46,702	11	Trenton (South)	\$32,648	11	Toronto (South)	\$36,250
12	Guelph (South)	60 Years (3 Life Cycles)	12%	\$46,713	12	Guelph (South)	\$32,680	12	Hamilton (South)	\$36,631
13	Mt. Forest (South)	60 Years (3 Life Cycles)	12%	\$47,138	13	Kitchener-Waterloo (South)	\$32,822	13	Sault Ste. Marie (North)	\$36,493
14	Sault Ste. Marie (North)	60 Years (3 Life Cycles)	12%	\$47,809	14	Mt. Forest (South)	\$33,100	14	Ottawa (Distinct)	\$36,809
15	Kitchener-Waterloo (South)	60 Years (3 Life Cycles)	12%	\$56,296	15	Kingston (South)	\$33,105	15	North Bay (North)	\$36,891
16	Barrie (Distinct)	60 Years (3 Life Cycles)	12%	\$56,460	16	Warton (South)	\$33,202	16	Muskoka (Distinct)	\$37,174
17	Kingston (South)	60 Years (3 Life Cycles)	12%	\$56,540	17	Sault Ste. Marie (North)	\$33,791	17	Mt. Forest (South)	\$37,181
18	Ottawa (Distinct)	60 Years (3 Life Cycles)	12%	\$56,643	18	Barrie (Distinct)	\$38,933	18	Kitchener-Waterloo (South)	\$37,217
19	Warton (South)	60 Years (3 Life Cycles)	12%	\$56,660	19	Ottawa (Distinct)	\$39,155	19	Peterborough (Distinct)	\$37,246
20	Peterborough (Distinct)	60 Years (3 Life Cycles)	12%	\$56,944	20	Peterborough (Distinct)	\$39,452	20	Warton (South)	\$37,982
21	Muskoka (Distinct)	60 Years (3 Life Cycles)	12%	\$57,074	21	Muskoka (Distinct)	\$39,550	21	Trenton (South)	\$38,928
22	North Bay (North)	60 Years (3 Life Cycles)	12%	\$57,197	22	North Bay (North)	\$39,732	22	Kingston (South)	\$39,235
23	Sudbury (North)	60 Years (3 Life Cycles)	12%	\$57,874	23	Sudbury (North)	\$40,416	23	Thunder Bay (North)	\$38,986
24	Timmins (North)	60 Years (3 Life Cycles)	12%	\$59,019	24	Timmins (North)	\$41,556	24	Sudbury (North)	\$39,644
25	Thunder Bay (North)	60 Years (3 Life Cycles)	12%	\$59,139	25	Thunder Bay (North)	\$41,654	25	Timmins (North)	\$40,132
26	Kenora (North)	60 Years (3 Life Cycles)	12%	\$59,633	26	Kenora (North)	\$42,120	26	Kenora (North)	\$41,066
27	Kapuskasing (North)	60 Years (3 Life Cycles)	12%	\$60,323	27	Kapuskasing (North)	\$42,820	27	Kapuskasing (North)	\$43,622

Table F1-1.70: Rankings of cities for rebates scenario (average construction type) at a discount rate of 12% (three life cycles of V.GSHP and H.GSHP and five life cycles of Traditional HVAC Applications for a 60 year project lifespan)

FIT + Rebates – (#4)

Total Present Value										
(FIT+Rebates) - (#4)										
#	City	Project Life Span	Discount Rate	V.GSHP	#	City	H.GSHP	#	City	Traditional
1	St. Catharines (South)	60 Years (3 Life Cycles)	12%	\$41,406	1	St. Catharines (South)	\$27,332	1	Cambridge (South)	\$32,921
2	Sarnia (South)	60 Years (3 Life Cycles)	12%	\$41,625	2	Sarnia (South)	\$27,545	2	Guelph (South)	\$33,350
3	Chatham (South)	60 Years (3 Life Cycles)	12%	\$41,680	3	Chatham (South)	\$27,606	3	Chatham (South)	\$34,358
4	Windsor (South)	60 Years (3 Life Cycles)	12%	\$41,690	4	Windsor (South)	\$27,619	4	Windsor (South)	\$34,386
5	Niagara Falls (South)	60 Years (3 Life Cycles)	12%	\$41,783	5	Niagara Falls (South)	\$27,708	5	Niagara Falls (South)	\$34,974
6	Simcoe (South)	60 Years (3 Life Cycles)	12%	\$42,021	6	Simcoe (South)	\$27,952	6	London (South)	\$35,367
7	Hamilton (South)	60 Years (3 Life Cycles)	12%	\$42,185	7	Hamilton (South)	\$28,115	7	St. Catharines (South)	\$35,877
8	Cambridge (South)	60 Years (3 Life Cycles)	12%	\$42,337	8	London (South)	\$28,264	8	Barrie (Distinct)	\$35,950
9	London (South)	60 Years (3 Life Cycles)	12%	\$42,339	9	Cambridge (South)	\$28,269	9	Sarnia (South)	\$36,075
10	Toronto (South)	60 Years (3 Life Cycles)	12%	\$42,346	10	Toronto (South)	\$28,283	10	Simcoe (South)	\$36,186
11	Trenton (South)	60 Years (3 Life Cycles)	12%	\$42,479	11	Trenton (South)	\$28,401	11	Toronto (South)	\$36,250
12	Guelph (South)	60 Years (3 Life Cycles)	12%	\$42,487	12	Guelph (South)	\$28,424	12	Hamilton (South)	\$36,631
13	Mt. Forest (South)	60 Years (3 Life Cycles)	12%	\$42,782	13	Kitchener-Waterloo (South)	\$28,522	13	Sault Ste. Marie (North)	\$36,493
14	Sault Ste. Marie (North)	60 Years (3 Life Cycles)	12%	\$43,248	14	Mt. Forest (South)	\$28,715	14	Ottawa (Distinct)	\$36,809
15	Kitchener-Waterloo (South)	60 Years (3 Life Cycles)	12%	\$52,104	15	Kingston (South)	\$28,718	15	North Bay (North)	\$36,891
16	Barrie (Distinct)	60 Years (3 Life Cycles)	12%	\$52,218	16	Warton (South)	\$28,786	16	Muskoka (Distinct)	\$37,174
17	Kingston (South)	60 Years (3 Life Cycles)	12%	\$52,273	17	Sault Ste. Marie (North)	\$29,195	17	Mt. Forest (South)	\$37,181
18	Ottawa (Distinct)	60 Years (3 Life Cycles)	12%	\$52,345	18	Barrie (Distinct)	\$34,648	18	Kitchener-Waterloo (South)	\$37,217
19	Warton (South)	60 Years (3 Life Cycles)	12%	\$52,357	19	Ottawa (Distinct)	\$34,802	19	Peterborough (Distinct)	\$37,246
20	Peterborough (Distinct)	60 Years (3 Life Cycles)	12%	\$52,554	20	Peterborough (Distinct)	\$35,008	20	Warton (South)	\$37,982
21	Muskoka (Distinct)	60 Years (3 Life Cycles)	12%	\$52,644	21	Muskoka (Distinct)	\$35,077	21	Trenton (South)	\$38,928
22	North Bay (North)	60 Years (3 Life Cycles)	12%	\$52,730	22	North Bay (North)	\$35,203	22	Kingston (South)	\$39,235
23	Sudbury (North)	60 Years (3 Life Cycles)	12%	\$53,200	23	Sudbury (North)	\$35,678	23	Thunder Bay (North)	\$38,986
24	Timmins (North)	60 Years (3 Life Cycles)	12%	\$53,994	24	Timmins (North)	\$36,470	24	Sudbury (North)	\$39,644
25	Thunder Bay (North)	60 Years (3 Life Cycles)	12%	\$54,078	25	Thunder Bay (North)	\$36,538	25	Timmins (North)	\$40,132
26	Kenora (North)	60 Years (3 Life Cycles)	12%	\$54,421	26	Kenora (North)	\$36,861	26	Kenora (North)	\$41,066
27	Kapuskasing (North)	60 Years (3 Life Cycles)	12%	\$54,900	27	Kapuskasing (North)	\$37,347	27	Kapuskasing (North)	\$43,622

Table F1-1.71: Rankings of cities for feed-in tariff + rebates scenario (average construction type) at a discount rate of 12% (three life cycles of V.GSHP and H.GSHP and five life cycles of Traditional HVAC Applications for a 60 year project lifespan)

(FIT + Rebates) + Carbon Taxes – (#5)

Total Present Value										
(FIT+Rebates) + Carbon Taxes - (#5)										
#	City	Project Life Span	Discount Rate	V.GSHP	#	City	H.GSHP	#	City	Traditional
1	St. Catharines (South)	60 Years (3 Life Cycles)	12%	\$41,406	1	St. Catharines (South)	\$27,332	1	Cambridge (South)	\$38,000
2	Sarnia (South)	60 Years (3 Life Cycles)	12%	\$41,625	2	Sarnia (South)	\$27,545	2	Guelph (South)	\$38,593
3	Chatham (South)	60 Years (3 Life Cycles)	12%	\$41,680	3	Chatham (South)	\$27,606	3	Chatham (South)	\$38,879
4	Windsor (South)	60 Years (3 Life Cycles)	12%	\$41,690	4	Windsor (South)	\$27,619	4	Windsor (South)	\$38,919
5	Niagara Falls (South)	60 Years (3 Life Cycles)	12%	\$41,783	5	Niagara Falls (South)	\$27,708	5	Niagara Falls (South)	\$39,552
6	Simcoe (South)	60 Years (3 Life Cycles)	12%	\$42,021	6	Simcoe (South)	\$27,952	6	St. Catharines (South)	\$40,334
7	Hamilton (South)	60 Years (3 Life Cycles)	12%	\$42,185	7	Hamilton (South)	\$28,115	7	London (South)	\$40,429
8	Cambridge (South)	60 Years (3 Life Cycles)	12%	\$42,337	8	London (South)	\$28,264	8	Sarnia (South)	\$40,721
9	London (South)	60 Years (3 Life Cycles)	12%	\$42,339	9	Cambridge (South)	\$28,269	9	Simcoe (South)	\$41,002
10	Toronto (South)	60 Years (3 Life Cycles)	12%	\$42,346	10	Toronto (South)	\$28,283	10	Barrie (Distinct)	\$41,168
11	Trenton (South)	60 Years (3 Life Cycles)	12%	\$42,479	11	Trenton (South)	\$28,401	11	Toronto (South)	\$41,340
12	Guelph (South)	60 Years (3 Life Cycles)	12%	\$42,487	12	Guelph (South)	\$28,424	12	Hamilton (South)	\$41,572
13	Mt. Forest (South)	60 Years (3 Life Cycles)	12%	\$42,782	13	Kitchener-Waterloo (South)	\$28,522	13	Ottawa (Distinct)	\$42,161
14	Sault Ste. Marie (North)	60 Years (3 Life Cycles)	12%	\$43,248	14	Mt. Forest (South)	\$28,715	14	Sault Ste. Marie (North)	\$42,259
15	Kitchener-Waterloo (South)	60 Years (3 Life Cycles)	12%	\$52,104	15	Kingston (South)	\$28,718	15	Kitchener-Waterloo (South)	\$42,469
16	Barrie (Distinct)	60 Years (3 Life Cycles)	12%	\$52,218	16	Warton (South)	\$28,786	16	North Bay (North)	\$42,542
17	Kingston (South)	60 Years (3 Life Cycles)	12%	\$52,273	17	Sault Ste. Marie (North)	\$29,195	17	Peterborough (Distinct)	\$42,750
18	Ottawa (Distinct)	60 Years (3 Life Cycles)	12%	\$52,345	18	Barrie (Distinct)	\$34,648	18	Muskoka (Distinct)	\$42,784
19	Warton (South)	60 Years (3 Life Cycles)	12%	\$52,357	19	Ottawa (Distinct)	\$34,802	19	Mt. Forest (South)	\$42,795
20	Peterborough (Distinct)	60 Years (3 Life Cycles)	12%	\$52,554	20	Peterborough (Distinct)	\$35,008	20	Warton (South)	\$43,437
21	Muskoka (Distinct)	60 Years (3 Life Cycles)	12%	\$52,644	21	Muskoka (Distinct)	\$35,077	21	Trenton (South)	\$44,053
22	North Bay (North)	60 Years (3 Life Cycles)	12%	\$52,730	22	North Bay (North)	\$35,203	22	Kingston (South)	\$44,512
23	Sudbury (North)	60 Years (3 Life Cycles)	12%	\$53,200	23	Sudbury (North)	\$35,678	23	Thunder Bay (North)	\$45,425
24	Timmins (North)	60 Years (3 Life Cycles)	12%	\$53,994	24	Timmins (North)	\$36,470	24	Sudbury (North)	\$45,732
25	Thunder Bay (North)	60 Years (3 Life Cycles)	12%	\$54,078	25	Thunder Bay (North)	\$36,538	25	Timmins (North)	\$46,884
26	Kenora (North)	60 Years (3 Life Cycles)	12%	\$54,421	26	Kenora (North)	\$36,861	26	Kenora (North)	\$47,599
27	Kapuskasing (North)	60 Years (3 Life Cycles)	12%	\$54,900	27	Kapuskasing (North)	\$37,347	27	Kapuskasing (North)	\$50,617

Table F1-1.72: Rankings of cities for feed-in tariff + rebates + carbon tax scenario (average construction type) at a discount rate of 12% (three life cycles of V.GSHP and H.GSHP and five life cycles of Traditional HVAC Applications for a 60 year project lifespan)

**Appendix F2 – Rankings of Cities for Different Scenarios Based on Present Value at
Various Discount Factors – Improved Construction Type**

1. Two Life Cycles of V.GSHP and H.GSHP and Five Life Cycles of Traditional HVAC Applications @ 5% Discount Rate

Base Case Scenario

Total Present Value										
Base Case Scenario										
#	City	Project Life Span	Discount Rate	V.GSHP	#	City	H.GSHP	#	City	Traditional
1	Sarnia (South)	60 Years (2 Life Cycles)	5%	\$62,823	1	St. Catharines (South)	\$49,645	1	Cambridge (South)	\$64,147
2	Chatham (South)	60 Years (2 Life Cycles)	5%	\$63,129	2	Sarnia (South)	\$50,241	2	Guelph (South)	\$65,014
3	Windsor (South)	60 Years (2 Life Cycles)	5%	\$63,152	3	Chatham (South)	\$50,586	3	Barrie (Distinct)	\$67,268
4	Niagara Falls (South)	60 Years (2 Life Cycles)	5%	\$63,490	4	Windsor (South)	\$50,622	4	London (South)	\$68,258
5	Simcoe (South)	60 Years (2 Life Cycles)	5%	\$64,055	5	Niagara Falls (South)	\$50,957	5	Chatham (South)	\$69,170
6	Hamilton (South)	60 Years (2 Life Cycles)	5%	\$64,483	6	Simcoe (South)	\$51,521	6	Windsor (South)	\$69,226
7	Cambridge (South)	60 Years (2 Life Cycles)	5%	\$64,960	7	Hamilton (South)	\$51,950	7	Muskoka (Distinct)	\$69,707
8	London (South)	60 Years (2 Life Cycles)	5%	\$64,967	8	London (South)	\$52,408	8	Sarnia (South)	\$69,792
9	Guelph (South)	60 Years (2 Life Cycles)	5%	\$65,321	9	Cambridge (South)	\$52,427	9	Sault Ste. Marie (North)	\$69,921
10	Sault Ste. Marie (North)	60 Years (2 Life Cycles)	5%	\$67,236	10	Toronto (South)	\$52,462	10	Niagara Falls (South)	\$70,716
11	St. Catharines (South)	60 Years (2 Life Cycles)	5%	\$75,210	11	Guelph (South)	\$52,788	11	St. Catharines (South)	\$70,967
12	Toronto (South)	60 Years (2 Life Cycles)	5%	\$77,934	12	Mt. Forest (South)	\$53,426	12	Toronto (South)	\$71,183
13	Trenton (South)	60 Years (2 Life Cycles)	5%	\$78,221	13	Sault Ste. Marie (North)	\$54,748	13	Ottawa (Distinct)	\$71,833
14	Kitchener-Waterloo (South)	60 Years (2 Life Cycles)	5%	\$78,537	14	Trenton (South)	\$61,408	14	North Bay (North)	\$71,891
15	Mt. Forest (South)	60 Years (2 Life Cycles)	5%	\$78,757	15	Kitchener-Waterloo (South)	\$61,753	15	Hamilton (South)	\$72,055
16	Barrie (Distinct)	60 Years (2 Life Cycles)	5%	\$78,863	16	Barrie (Distinct)	\$62,033	16	Simcoe (South)	\$72,880
17	Ottawa (Distinct)	60 Years (2 Life Cycles)	5%	\$78,950	17	Ottawa (Distinct)	\$62,162	17	Peterborough (Distinct)	\$72,966
18	Kingston (South)	60 Years (2 Life Cycles)	5%	\$79,085	18	Kingston (South)	\$62,301	18	Mt. Forest (South)	\$72,977
19	Warton (South)	60 Years (2 Life Cycles)	5%	\$79,330	19	Warton (South)	\$62,511	19	Kitchener-Waterloo (South)	\$73,273
20	Peterborough (Distinct)	60 Years (2 Life Cycles)	5%	\$79,717	20	Peterborough (Distinct)	\$62,930	20	Warton (South)	\$74,750
21	North Bay (North)	60 Years (2 Life Cycles)	5%	\$79,888	21	Muskoka (Distinct)	\$63,068	21	Thunder Bay (North)	\$76,130
22	Muskoka (Distinct)	60 Years (2 Life Cycles)	5%	\$79,898	22	North Bay (North)	\$63,142	22	Trenton (South)	\$76,803
23	Sudbury (North)	60 Years (2 Life Cycles)	5%	\$80,907	23	Sudbury (North)	\$64,171	23	Kingston (South)	\$77,445
24	Timmins (North)	60 Years (2 Life Cycles)	5%	\$82,606	24	Timmins (North)	\$65,873	24	Sudbury (North)	\$77,563
25	Thunder Bay (North)	60 Years (2 Life Cycles)	5%	\$83,289	25	Thunder Bay (North)	\$66,521	25	Kenora (North)	\$77,586
26	Kenora (North)	60 Years (2 Life Cycles)	5%	\$83,818	26	Kenora (North)	\$67,008	26	Timmins (North)	\$78,336
27	Kapuskasing (North)	60 Years (2 Life Cycles)	5%	\$84,975	27	Kapuskasing (North)	\$68,175	27	Kapuskasing (North)	\$85,695

Table F2-1.1: Rankings of cities for base case scenario (improved construction type) at a discount rate of 5% (two life cycles of V.GSHP and H.GSHP and five life cycles of Traditional HVAC Applications for a 60 year project lifespan)

Carbon Taxes – (#1)

Total Present Value										
Carbon Taxes - (#1)										
#	City	Project Life Span	Discount Rate	V.GSHP	#	City	H.GSHP	#	City	Traditional
1	Sarnia (South)	60 Years (2 Life Cycles)	5%	\$62,823	1	St. Catharines (South)	\$49,645	1	Cambridge (South)	\$82,660
2	Chatham (South)	60 Years (2 Life Cycles)	5%	\$63,129	2	Sarnia (South)	\$50,241	2	Guelph (South)	\$84,076
3	Windsor (South)	60 Years (2 Life Cycles)	5%	\$63,152	3	Chatham (South)	\$50,586	3	Chatham (South)	\$85,813
4	Niagara Falls (South)	60 Years (2 Life Cycles)	5%	\$63,490	4	Windsor (South)	\$50,622	4	Windsor (South)	\$85,911
5	Simcoe (South)	60 Years (2 Life Cycles)	5%	\$64,055	5	Niagara Falls (South)	\$50,957	5	Barrie (Distinct)	\$86,022
6	Hamilton (South)	60 Years (2 Life Cycles)	5%	\$64,483	6	Simcoe (South)	\$51,521	6	London (South)	\$86,771
7	Cambridge (South)	60 Years (2 Life Cycles)	5%	\$64,960	7	Hamilton (South)	\$51,950	7	Sarnia (South)	\$86,791
8	London (South)	60 Years (2 Life Cycles)	5%	\$64,967	8	London (South)	\$52,408	8	St. Catharines (South)	\$87,260
9	Guelph (South)	60 Years (2 Life Cycles)	5%	\$65,321	9	Cambridge (South)	\$52,427	9	Niagara Falls (South)	\$87,552
10	Sault Ste. Marie (North)	60 Years (2 Life Cycles)	5%	\$67,236	10	Toronto (South)	\$52,462	10	Toronto (South)	\$89,732
11	St. Catharines (South)	60 Years (2 Life Cycles)	5%	\$75,210	11	Guelph (South)	\$52,788	11	Muskoka (Distinct)	\$89,770
12	Toronto (South)	60 Years (2 Life Cycles)	5%	\$77,934	12	Mt. Forest (South)	\$53,426	12	Hamilton (South)	\$90,098
13	Trenton (South)	60 Years (2 Life Cycles)	5%	\$78,221	13	Sault Ste. Marie (North)	\$54,748	13	Simcoe (South)	\$90,524
14	Kitchener-Waterloo (South)	60 Years (2 Life Cycles)	5%	\$78,537	14	Trenton (South)	\$61,408	14	Sault Ste. Marie (North)	\$90,563
15	Mt. Forest (South)	60 Years (2 Life Cycles)	5%	\$78,757	15	Kitchener-Waterloo (South)	\$61,753	15	Ottawa (Distinct)	\$91,015
16	Barrie (Distinct)	60 Years (2 Life Cycles)	5%	\$78,863	16	Barrie (Distinct)	\$62,033	16	North Bay (North)	\$92,081
17	Ottawa (Distinct)	60 Years (2 Life Cycles)	5%	\$78,950	17	Ottawa (Distinct)	\$62,162	17	Kitchener-Waterloo (South)	\$92,377
18	Kingston (South)	60 Years (2 Life Cycles)	5%	\$79,085	18	Kingston (South)	\$62,301	18	Peterborough (Distinct)	\$92,963
19	Warton (South)	60 Years (2 Life Cycles)	5%	\$79,330	19	Warton (South)	\$62,511	19	Mt. Forest (South)	\$93,276
20	Peterborough (Distinct)	60 Years (2 Life Cycles)	5%	\$79,717	20	Peterborough (Distinct)	\$62,930	20	Warton (South)	\$94,554
21	North Bay (North)	60 Years (2 Life Cycles)	5%	\$79,888	21	Muskoka (Distinct)	\$63,068	21	Trenton (South)	\$95,472
22	Muskoka (Distinct)	60 Years (2 Life Cycles)	5%	\$79,898	22	North Bay (North)	\$63,142	22	Kingston (South)	\$96,658
23	Sudbury (North)	60 Years (2 Life Cycles)	5%	\$80,907	23	Sudbury (North)	\$64,171	23	Thunder Bay (North)	\$98,992
24	Timmins (North)	60 Years (2 Life Cycles)	5%	\$82,606	24	Timmins (North)	\$65,873	24	Sudbury (North)	\$99,200
25	Thunder Bay (North)	60 Years (2 Life Cycles)	5%	\$83,289	25	Thunder Bay (North)	\$66,521	25	Kenora (North)	\$100,750
26	Kenora (North)	60 Years (2 Life Cycles)	5%	\$83,818	26	Kenora (North)	\$67,008	26	Timmins (North)	\$102,145
27	Kapuskasing (North)	60 Years (2 Life Cycles)	5%	\$84,975	27	Kapuskasing (North)	\$68,175	27	Kapuskasing (North)	\$110,379

Table F2-1.2: Rankings of cities for carbon taxes scenario (improved construction type) at a discount rate of 5% (two life cycles of V.GSHP and H.GSHP and five life cycles of Traditional HVAC Applications for a 60 year project lifespan)

FIT – (#2)

Total Present Value										
FIT - (#2)										
#	City	Project Life Span	Discount Rate	V.GSHP	#	City	H.GSHP	#	City	Traditional
1	Sarnia (South)	60 Years (2 Life Cycles)	5%	\$55,008	1	St. Catharines (South)	\$41,949	1	Cambridge (South)	\$64,147
2	Chatham (South)	60 Years (2 Life Cycles)	5%	\$55,224	2	Sarnia (South)	\$42,370	2	Guelph (South)	\$65,014
3	Windsor (South)	60 Years (2 Life Cycles)	5%	\$55,240	3	Chatham (South)	\$42,614	3	Barrie (Distinct)	\$67,268
4	Niagara Falls (South)	60 Years (2 Life Cycles)	5%	\$55,479	4	Windsor (South)	\$42,639	4	London (South)	\$68,258
5	Simcoe (South)	60 Years (2 Life Cycles)	5%	\$55,878	5	Niagara Falls (South)	\$42,876	5	Chatham (South)	\$69,170
6	Hamilton (South)	60 Years (2 Life Cycles)	5%	\$56,181	6	Simcoe (South)	\$43,275	6	Windsor (South)	\$69,226
7	Cambridge (South)	60 Years (2 Life Cycles)	5%	\$56,518	7	Hamilton (South)	\$43,577	7	Muskoka (Distinct)	\$69,707
8	London (South)	60 Years (2 Life Cycles)	5%	\$56,522	8	London (South)	\$43,901	8	Sarnia (South)	\$69,792
9	Guelph (South)	60 Years (2 Life Cycles)	5%	\$56,773	9	Cambridge (South)	\$43,914	9	Sault Ste. Marie (North)	\$69,921
10	Sault Ste. Marie (North)	60 Years (2 Life Cycles)	5%	\$58,126	10	Toronto (South)	\$43,940	10	Niagara Falls (South)	\$70,716
11	St. Catharines (South)	60 Years (2 Life Cycles)	5%	\$67,302	11	Guelph (South)	\$44,170	11	St. Catharines (South)	\$70,967
12	Toronto (South)	60 Years (2 Life Cycles)	5%	\$69,226	12	Mt. Forest (South)	\$44,620	12	Toronto (South)	\$71,183
13	Trenton (South)	60 Years (2 Life Cycles)	5%	\$69,429	13	Sault Ste. Marie (North)	\$45,554	13	Ottawa (Distinct)	\$71,833
14	Kitchener-Waterloo (South)	60 Years (2 Life Cycles)	5%	\$69,652	14	Trenton (South)	\$52,552	14	North Bay (North)	\$71,891
15	Mt. Forest (South)	60 Years (2 Life Cycles)	5%	\$69,807	15	Kitchener-Waterloo (South)	\$52,796	15	Hamilton (South)	\$72,055
16	Barrie (Distinct)	60 Years (2 Life Cycles)	5%	\$69,882	16	Barrie (Distinct)	\$52,994	16	Simcoe (South)	\$72,880
17	Ottawa (Distinct)	60 Years (2 Life Cycles)	5%	\$69,943	17	Ottawa (Distinct)	\$53,085	17	Peterborough (Distinct)	\$72,966
18	Kingston (South)	60 Years (2 Life Cycles)	5%	\$70,039	18	Kingston (South)	\$53,183	18	Mt. Forest (South)	\$72,977
19	Warton (South)	60 Years (2 Life Cycles)	5%	\$70,212	19	Warton (South)	\$53,331	19	Kitchener-Waterloo (South)	\$73,273
20	Peterborough (Distinct)	60 Years (2 Life Cycles)	5%	\$70,485	20	Peterborough (Distinct)	\$53,627	20	Warton (South)	\$74,750
21	North Bay (North)	60 Years (2 Life Cycles)	5%	\$70,606	21	Muskoka (Distinct)	\$53,725	21	Thunder Bay (North)	\$76,130
22	Muskoka (Distinct)	60 Years (2 Life Cycles)	5%	\$70,613	22	North Bay (North)	\$53,777	22	Trenton (South)	\$76,803
23	Sudbury (North)	60 Years (2 Life Cycles)	5%	\$71,326	23	Sudbury (North)	\$54,504	23	Kingston (South)	\$77,445
24	Timmins (North)	60 Years (2 Life Cycles)	5%	\$72,526	24	Timmins (North)	\$55,706	24	Sudbury (North)	\$77,563
25	Thunder Bay (North)	60 Years (2 Life Cycles)	5%	\$73,009	25	Thunder Bay (North)	\$56,164	25	Kenora (North)	\$77,586
26	Kenora (North)	60 Years (2 Life Cycles)	5%	\$73,382	26	Kenora (North)	\$56,508	26	Timmins (North)	\$78,336
27	Kapuskasing (North)	60 Years (2 Life Cycles)	5%	\$74,200	27	Kapuskasing (North)	\$57,332	27	Kapuskasing (North)	\$85,695

Table F2-1.3: Rankings of cities for feed-in tariff scenario (improved construction type) at a discount rate of 5% (two life cycles of V.GSHP and H.GSHP and five life cycles of Traditional HVAC Applications for a 60 year project lifespan)

Rebates – (#3)

Total Present Value										
Rebates - (#3)										
#	City	Project Life Span	Discount Rate	V.GSHP	#	City	H.GSHP	#	City	Traditional
1	Sarnia (South)	60 Years (2 Life Cycles)	5%	\$55,728	1	St. Catharines (South)	\$42,549	1	Cambridge (South)	\$64,147
2	Chatham (South)	60 Years (2 Life Cycles)	5%	\$56,034	2	Sarnia (South)	\$43,146	2	Guelph (South)	\$65,014
3	Windsor (South)	60 Years (2 Life Cycles)	5%	\$56,056	3	Chatham (South)	\$43,491	3	Barrie (Distinct)	\$67,268
4	Niagara Falls (South)	60 Years (2 Life Cycles)	5%	\$56,395	4	Windsor (South)	\$43,526	4	London (South)	\$68,258
5	Simcoe (South)	60 Years (2 Life Cycles)	5%	\$56,959	5	Niagara Falls (South)	\$43,861	5	Chatham (South)	\$69,170
6	Hamilton (South)	60 Years (2 Life Cycles)	5%	\$57,388	6	Simcoe (South)	\$44,426	6	Windsor (South)	\$69,226
7	Cambridge (South)	60 Years (2 Life Cycles)	5%	\$57,865	7	Hamilton (South)	\$44,854	7	Muskoka (Distinct)	\$69,707
8	London (South)	60 Years (2 Life Cycles)	5%	\$57,871	8	London (South)	\$45,312	8	Sarnia (South)	\$69,792
9	Guelph (South)	60 Years (2 Life Cycles)	5%	\$58,226	9	Cambridge (South)	\$45,331	9	Sault Ste. Marie (North)	\$69,921
10	Sault Ste. Marie (North)	60 Years (2 Life Cycles)	5%	\$60,141	10	Toronto (South)	\$45,367	10	Niagara Falls (South)	\$70,716
11	St. Catharines (South)	60 Years (2 Life Cycles)	5%	\$68,115	11	Guelph (South)	\$45,693	11	St. Catharines (South)	\$70,967
12	Toronto (South)	60 Years (2 Life Cycles)	5%	\$70,839	12	Mt. Forest (South)	\$46,331	12	Toronto (South)	\$71,183
13	Trenton (South)	60 Years (2 Life Cycles)	5%	\$71,126	13	Sault Ste. Marie (North)	\$47,653	13	Ottawa (Distinct)	\$71,833
14	Kitchener-Waterloo (South)	60 Years (2 Life Cycles)	5%	\$71,442	14	Trenton (South)	\$54,313	14	North Bay (North)	\$71,891
15	Mt. Forest (South)	60 Years (2 Life Cycles)	5%	\$71,661	15	Kitchener-Waterloo (South)	\$54,657	15	Hamilton (South)	\$72,055
16	Barrie (Distinct)	60 Years (2 Life Cycles)	5%	\$71,767	16	Barrie (Distinct)	\$54,938	16	Simcoe (South)	\$72,880
17	Ottawa (Distinct)	60 Years (2 Life Cycles)	5%	\$71,854	17	Ottawa (Distinct)	\$55,067	17	Peterborough (Distinct)	\$72,966
18	Kingston (South)	60 Years (2 Life Cycles)	5%	\$71,990	18	Kingston (South)	\$55,206	18	Mt. Forest (South)	\$72,977
19	Warton (South)	60 Years (2 Life Cycles)	5%	\$72,235	19	Warton (South)	\$55,415	19	Kitchener-Waterloo (South)	\$73,273
20	Peterborough (Distinct)	60 Years (2 Life Cycles)	5%	\$72,622	20	Peterborough (Distinct)	\$55,834	20	Warton (South)	\$74,750
21	North Bay (North)	60 Years (2 Life Cycles)	5%	\$72,793	21	Muskoka (Distinct)	\$55,973	21	Thunder Bay (North)	\$76,130
22	Muskoka (Distinct)	60 Years (2 Life Cycles)	5%	\$72,802	22	North Bay (North)	\$56,047	22	Trenton (South)	\$76,803
23	Sudbury (North)	60 Years (2 Life Cycles)	5%	\$73,811	23	Sudbury (North)	\$57,075	23	Kingston (South)	\$77,445
24	Timmins (North)	60 Years (2 Life Cycles)	5%	\$75,510	24	Timmins (North)	\$58,777	24	Sudbury (North)	\$77,563
25	Thunder Bay (North)	60 Years (2 Life Cycles)	5%	\$76,194	25	Thunder Bay (North)	\$59,425	25	Kenora (North)	\$77,586
26	Kenora (North)	60 Years (2 Life Cycles)	5%	\$76,722	26	Kenora (North)	\$59,912	26	Timmins (North)	\$78,336
27	Kapuskasing (North)	60 Years (2 Life Cycles)	5%	\$77,880	27	Kapuskasing (North)	\$61,079	27	Kapuskasing (North)	\$85,695

Table F2-1.4: Rankings of cities for rebates scenario (improved construction type) at a discount rate of 5% (two life cycles of V.GSHP and H.GSHP and five life cycles of Traditional HVAC Applications for a 60 year project lifespan)

FIT + Rebates – (#4)

Total Present Value										
(FIT+Rebates) - (#4)										
#	City	Project Life Span	Discount Rate	V.GSHP	#	City	H.GSHP	#	City	Traditional
1	Sarnia (South)	60 Years (2 Life Cycles)	5%	\$47,913	1	St. Catharines (South)	\$34,854	1	Cambridge (South)	\$64,147
2	Chatham (South)	60 Years (2 Life Cycles)	5%	\$48,129	2	Sarnia (South)	\$35,275	2	Guelph (South)	\$65,014
3	Windsor (South)	60 Years (2 Life Cycles)	5%	\$48,145	3	Chatham (South)	\$35,519	3	Barrie (Distinct)	\$67,268
4	Niagara Falls (South)	60 Years (2 Life Cycles)	5%	\$48,384	4	Windsor (South)	\$35,544	4	London (South)	\$68,258
5	Simcoe (South)	60 Years (2 Life Cycles)	5%	\$48,782	5	Niagara Falls (South)	\$35,781	5	Chatham (South)	\$69,170
6	Hamilton (South)	60 Years (2 Life Cycles)	5%	\$49,085	6	Simcoe (South)	\$36,179	6	Windsor (South)	\$69,226
7	Cambridge (South)	60 Years (2 Life Cycles)	5%	\$49,422	7	Hamilton (South)	\$36,482	7	Muskoka (Distinct)	\$69,707
8	London (South)	60 Years (2 Life Cycles)	5%	\$49,427	8	London (South)	\$36,805	8	Sarnia (South)	\$69,792
9	Guelph (South)	60 Years (2 Life Cycles)	5%	\$49,677	9	Cambridge (South)	\$36,819	9	Sault Ste. Marie (North)	\$69,921
10	Sault Ste. Marie (North)	60 Years (2 Life Cycles)	5%	\$51,030	10	Toronto (South)	\$36,844	10	Niagara Falls (South)	\$70,716
11	St. Catharines (South)	60 Years (2 Life Cycles)	5%	\$60,206	11	Guelph (South)	\$37,074	11	St. Catharines (South)	\$70,967
12	Toronto (South)	60 Years (2 Life Cycles)	5%	\$62,131	12	Mt. Forest (South)	\$37,525	12	Toronto (South)	\$71,183
13	Trenton (South)	60 Years (2 Life Cycles)	5%	\$62,333	13	Sault Ste. Marie (North)	\$38,459	13	Ottawa (Distinct)	\$71,833
14	Kitchener-Waterloo (South)	60 Years (2 Life Cycles)	5%	\$62,556	14	Trenton (South)	\$45,456	14	North Bay (North)	\$71,891
15	Mt. Forest (South)	60 Years (2 Life Cycles)	5%	\$62,711	15	Kitchener-Waterloo (South)	\$45,700	15	Hamilton (South)	\$72,055
16	Barrie (Distinct)	60 Years (2 Life Cycles)	5%	\$62,786	16	Barrie (Distinct)	\$45,898	16	Simcoe (South)	\$72,880
17	Ottawa (Distinct)	60 Years (2 Life Cycles)	5%	\$62,848	17	Ottawa (Distinct)	\$45,989	17	Peterborough (Distinct)	\$72,966
18	Kingston (South)	60 Years (2 Life Cycles)	5%	\$62,944	18	Kingston (South)	\$46,087	18	Mt. Forest (South)	\$72,977
19	Warton (South)	60 Years (2 Life Cycles)	5%	\$63,117	19	Warton (South)	\$46,235	19	Kitchener-Waterloo (South)	\$73,273
20	Peterborough (Distinct)	60 Years (2 Life Cycles)	5%	\$63,390	20	Peterborough (Distinct)	\$46,531	20	Warton (South)	\$74,750
21	North Bay (North)	60 Years (2 Life Cycles)	5%	\$63,511	21	Muskoka (Distinct)	\$46,629	21	Thunder Bay (North)	\$76,130
22	Muskoka (Distinct)	60 Years (2 Life Cycles)	5%	\$63,517	22	North Bay (North)	\$46,682	22	Trenton (South)	\$76,803
23	Sudbury (North)	60 Years (2 Life Cycles)	5%	\$64,230	23	Sudbury (North)	\$47,408	23	Kingston (South)	\$77,445
24	Timmins (North)	60 Years (2 Life Cycles)	5%	\$65,430	24	Timmins (North)	\$48,611	24	Sudbury (North)	\$77,563
25	Thunder Bay (North)	60 Years (2 Life Cycles)	5%	\$65,913	25	Thunder Bay (North)	\$49,068	25	Kenora (North)	\$77,586
26	Kenora (North)	60 Years (2 Life Cycles)	5%	\$66,287	26	Kenora (North)	\$49,412	26	Timmins (North)	\$78,336
27	Kapuskasing (North)	60 Years (2 Life Cycles)	5%	\$67,104	27	Kapuskasing (North)	\$50,236	27	Kapuskasing (North)	\$85,695

Table F2-1.5: Rankings of cities for feed-in tariff + rebates scenario (improved construction type) at a discount rate of 5% (two life cycles of V.GSHP and H.GSHP and five life cycles of Traditional HVAC Applications for a 60 year project lifespan)

(FIT + Rebates) + Carbon Taxes – (#5)

Total Present Value										
(FIT+Rebates) + Carbon Taxes - (#5)										
#	City	Project Life Span	Discount Rate	V.GSHP	#	City	H.GSHP	#	City	Traditional
1	Sarnia (South)	60 Years (2 Life Cycles)	5%	\$47,913	1	St. Catharines (South)	\$34,854	1	Cambridge (South)	\$82,660
2	Chatham (South)	60 Years (2 Life Cycles)	5%	\$48,129	2	Sarnia (South)	\$35,275	2	Guelph (South)	\$84,076
3	Windsor (South)	60 Years (2 Life Cycles)	5%	\$48,145	3	Chatham (South)	\$35,519	3	Chatham (South)	\$85,813
4	Niagara Falls (South)	60 Years (2 Life Cycles)	5%	\$48,384	4	Windsor (South)	\$35,544	4	Windsor (South)	\$85,911
5	Simcoe (South)	60 Years (2 Life Cycles)	5%	\$48,782	5	Niagara Falls (South)	\$35,781	5	Barrie (Distinct)	\$86,022
6	Hamilton (South)	60 Years (2 Life Cycles)	5%	\$49,085	6	Simcoe (South)	\$36,179	6	London (South)	\$86,771
7	Cambridge (South)	60 Years (2 Life Cycles)	5%	\$49,422	7	Hamilton (South)	\$36,482	7	Sarnia (South)	\$86,791
8	London (South)	60 Years (2 Life Cycles)	5%	\$49,427	8	London (South)	\$36,805	8	St. Catharines (South)	\$87,260
9	Guelph (South)	60 Years (2 Life Cycles)	5%	\$49,677	9	Cambridge (South)	\$36,819	9	Niagara Falls (South)	\$87,552
10	Sault Ste. Marie (North)	60 Years (2 Life Cycles)	5%	\$51,030	10	Toronto (South)	\$36,844	10	Toronto (South)	\$89,732
11	St. Catharines (South)	60 Years (2 Life Cycles)	5%	\$60,206	11	Guelph (South)	\$37,074	11	Muskoka (Distinct)	\$89,770
12	Toronto (South)	60 Years (2 Life Cycles)	5%	\$62,131	12	Mt. Forest (South)	\$37,525	12	Hamilton (South)	\$90,098
13	Trenton (South)	60 Years (2 Life Cycles)	5%	\$62,333	13	Sault Ste. Marie (North)	\$38,459	13	Simcoe (South)	\$90,524
14	Kitchener-Waterloo (South)	60 Years (2 Life Cycles)	5%	\$62,556	14	Trenton (South)	\$45,456	14	Sault Ste. Marie (North)	\$90,563
15	Mt. Forest (South)	60 Years (2 Life Cycles)	5%	\$62,711	15	Kitchener-Waterloo (South)	\$45,700	15	Ottawa (Distinct)	\$91,015
16	Barrie (Distinct)	60 Years (2 Life Cycles)	5%	\$62,786	16	Barrie (Distinct)	\$45,898	16	North Bay (North)	\$92,081
17	Ottawa (Distinct)	60 Years (2 Life Cycles)	5%	\$62,848	17	Ottawa (Distinct)	\$45,989	17	Kitchener-Waterloo (South)	\$92,377
18	Kingston (South)	60 Years (2 Life Cycles)	5%	\$62,944	18	Kingston (South)	\$46,087	18	Peterborough (Distinct)	\$92,963
19	Warton (South)	60 Years (2 Life Cycles)	5%	\$63,117	19	Warton (South)	\$46,235	19	Mt. Forest (South)	\$93,276
20	Peterborough (Distinct)	60 Years (2 Life Cycles)	5%	\$63,390	20	Peterborough (Distinct)	\$46,531	20	Warton (South)	\$94,554
21	North Bay (North)	60 Years (2 Life Cycles)	5%	\$63,511	21	Muskoka (Distinct)	\$46,629	21	Trenton (South)	\$95,472
22	Muskoka (Distinct)	60 Years (2 Life Cycles)	5%	\$63,517	22	North Bay (North)	\$46,682	22	Kingston (South)	\$96,658
23	Sudbury (North)	60 Years (2 Life Cycles)	5%	\$64,230	23	Sudbury (North)	\$47,408	23	Thunder Bay (North)	\$98,992
24	Timmins (North)	60 Years (2 Life Cycles)	5%	\$65,430	24	Timmins (North)	\$48,611	24	Sudbury (North)	\$99,200
25	Thunder Bay (North)	60 Years (2 Life Cycles)	5%	\$65,913	25	Thunder Bay (North)	\$49,068	25	Kenora (North)	\$100,750
26	Kenora (North)	60 Years (2 Life Cycles)	5%	\$66,287	26	Kenora (North)	\$49,412	26	Timmins (North)	\$102,145
27	Kapuskasing (North)	60 Years (2 Life Cycles)	5%	\$67,104	27	Kapuskasing (North)	\$50,236	27	Kapuskasing (North)	\$110,379

Table F2-1.6: Rankings of cities for feed-in tariff + rebates + carbon tax scenario (improved construction type) at a discount rate of 5% (two life cycles of V.GSHP and H.GSHP and five life cycles of Traditional HVAC Applications for a 60 year project lifespan)

2. Two Life Cycles of V.GSHP and H.GSHP and Five Life Cycles of Traditional HVAC Applications @ 7% Discount Rate

Base Case Scenario

Total Present Value										
Base Case Scenario										
#	City	Project Life Span	Discount Rate	V.GSHP	#	City	H.GSHP	#	City	Traditional
1	Sarnia (South)	60 Years (2 Life Cycles)	7%	\$50,626	1	St. Catharines (South)	\$39,188	1	Cambridge (South)	\$47,171
2	Chatham (South)	60 Years (2 Life Cycles)	7%	\$50,849	2	Sarnia (South)	\$39,623	2	Guelph (South)	\$47,796
3	Windsor (South)	60 Years (2 Life Cycles)	7%	\$50,866	3	Chatham (South)	\$39,875	3	Barrie (Distinct)	\$49,495
4	Niagara Falls (South)	60 Years (2 Life Cycles)	7%	\$51,113	4	Windsor (South)	\$39,901	4	London (South)	\$50,222
5	Simcoe (South)	60 Years (2 Life Cycles)	7%	\$51,525	5	Niagara Falls (South)	\$40,145	5	Chatham (South)	\$50,963
6	Hamilton (South)	60 Years (2 Life Cycles)	7%	\$51,837	6	Simcoe (South)	\$40,557	6	Windsor (South)	\$51,004
7	Cambridge (South)	60 Years (2 Life Cycles)	7%	\$52,186	7	Hamilton (South)	\$40,870	7	Muskoka (Distinct)	\$51,258
8	London (South)	60 Years (2 Life Cycles)	7%	\$52,190	8	London (South)	\$41,204	8	Sarnia (South)	\$51,412
9	Guelph (South)	60 Years (2 Life Cycles)	7%	\$52,449	9	Cambridge (South)	\$41,218	9	Sault Ste. Marie (North)	\$51,406
10	Sault Ste. Marie (North)	60 Years (2 Life Cycles)	7%	\$53,847	10	Toronto (South)	\$41,244	10	Niagara Falls (South)	\$52,089
11	St. Catharines (South)	60 Years (2 Life Cycles)	7%	\$61,259	11	Guelph (South)	\$41,482	11	St. Catharines (South)	\$52,280
12	Toronto (South)	60 Years (2 Life Cycles)	7%	\$63,247	12	Mt. Forest (South)	\$41,947	12	Toronto (South)	\$52,406
13	Trenton (South)	60 Years (2 Life Cycles)	7%	\$63,456	13	Sault Ste. Marie (North)	\$42,912	13	Ottawa (Distinct)	\$52,872
14	Kitchener-Waterloo (South)	60 Years (2 Life Cycles)	7%	\$63,687	14	Trenton (South)	\$48,758	14	North Bay (North)	\$52,901
15	Mt. Forest (South)	60 Years (2 Life Cycles)	7%	\$63,847	15	Kitchener-Waterloo (South)	\$49,010	15	Hamilton (South)	\$53,050
16	Barrie (Distinct)	60 Years (2 Life Cycles)	7%	\$63,924	16	Barrie (Distinct)	\$49,215	16	Simcoe (South)	\$53,708
17	Ottawa (Distinct)	60 Years (2 Life Cycles)	7%	\$63,988	17	Ottawa (Distinct)	\$49,309	17	Peterborough (Distinct)	\$53,687
18	Kingston (South)	60 Years (2 Life Cycles)	7%	\$64,087	18	Kingston (South)	\$49,410	18	Mt. Forest (South)	\$53,692
19	Warton (South)	60 Years (2 Life Cycles)	7%	\$64,265	19	Warton (South)	\$49,563	19	Kitchener-Waterloo (South)	\$53,924
20	Peterborough (Distinct)	60 Years (2 Life Cycles)	7%	\$64,548	20	Peterborough (Distinct)	\$49,869	20	Warton (South)	\$55,043
21	North Bay (North)	60 Years (2 Life Cycles)	7%	\$64,672	21	Muskoka (Distinct)	\$49,970	21	Thunder Bay (North)	\$55,958
22	Muskoka (Distinct)	60 Years (2 Life Cycles)	7%	\$64,680	22	North Bay (North)	\$50,024	22	Trenton (South)	\$56,607
23	Sudbury (North)	60 Years (2 Life Cycles)	7%	\$65,416	23	Sudbury (North)	\$50,775	23	Kingston (South)	\$57,068
24	Timmins (North)	60 Years (2 Life Cycles)	7%	\$66,656	24	Timmins (North)	\$52,017	24	Sudbury (North)	\$57,070
25	Thunder Bay (North)	60 Years (2 Life Cycles)	7%	\$67,154	25	Thunder Bay (North)	\$52,490	25	Kenora (North)	\$57,016
26	Kenora (North)	60 Years (2 Life Cycles)	7%	\$67,540	26	Kenora (North)	\$52,845	26	Timmins (North)	\$57,554
27	Kapuskasing (North)	60 Years (2 Life Cycles)	7%	\$68,385	27	Kapuskasing (North)	\$53,696	27	Kapuskasing (North)	\$63,014

Table F2-1.7: Rankings of cities for base case scenario (improved construction type) at a discount rate of 7% (two life cycles of V.GSHP and H.GSHP and five life cycles of Traditional HVAC Applications for a 60 year project lifespan)

Carbon Taxes – (#1)

Total Present Value										
Carbon Taxes - (#1)										
#	City	Project Life Span	Discount Rate	V.GSHP	#	City	H.GSHP	#	City	Traditional
1	Sarnia (South)	60 Years (2 Life Cycles)	7%	\$50,626	1	St. Catharines (South)	\$39,188	1	Cambridge (South)	\$58,270
2	Chatham (South)	60 Years (2 Life Cycles)	7%	\$50,849	2	Sarnia (South)	\$39,623	2	Guelph (South)	\$59,224
3	Windsor (South)	60 Years (2 Life Cycles)	7%	\$50,866	3	Chatham (South)	\$39,875	3	Barrie (Distinct)	\$60,739
4	Niagara Falls (South)	60 Years (2 Life Cycles)	7%	\$51,113	4	Windsor (South)	\$39,901	4	Chatham (South)	\$60,941
5	Simcoe (South)	60 Years (2 Life Cycles)	7%	\$51,525	5	Niagara Falls (South)	\$40,145	5	Windsor (South)	\$61,007
6	Hamilton (South)	60 Years (2 Life Cycles)	7%	\$51,837	6	Simcoe (South)	\$40,557	6	London (South)	\$61,321
7	Cambridge (South)	60 Years (2 Life Cycles)	7%	\$52,186	7	Hamilton (South)	\$40,870	7	Sarnia (South)	\$61,604
8	London (South)	60 Years (2 Life Cycles)	7%	\$52,190	8	London (South)	\$41,204	8	St. Catharines (South)	\$62,048
9	Guelph (South)	60 Years (2 Life Cycles)	7%	\$52,449	9	Cambridge (South)	\$41,218	9	Niagara Falls (South)	\$62,183
10	Sault Ste. Marie (North)	60 Years (2 Life Cycles)	7%	\$53,847	10	Toronto (South)	\$41,244	10	Muskoka (Distinct)	\$63,286
11	St. Catharines (South)	60 Years (2 Life Cycles)	7%	\$61,259	11	Guelph (South)	\$41,482	11	Toronto (South)	\$63,527
12	Toronto (South)	60 Years (2 Life Cycles)	7%	\$63,247	12	Mt. Forest (South)	\$41,947	12	Sault Ste. Marie (North)	\$63,781
13	Trenton (South)	60 Years (2 Life Cycles)	7%	\$63,456	13	Sault Ste. Marie (North)	\$42,912	13	Hamilton (South)	\$63,867
14	Kitchener-Waterloo (South)	60 Years (2 Life Cycles)	7%	\$63,687	14	Trenton (South)	\$48,758	14	Simcoe (South)	\$64,286
15	Mt. Forest (South)	60 Years (2 Life Cycles)	7%	\$63,847	15	Kitchener-Waterloo (South)	\$49,010	15	Ottawa (Distinct)	\$64,372
16	Barrie (Distinct)	60 Years (2 Life Cycles)	7%	\$63,924	16	Barrie (Distinct)	\$49,215	16	North Bay (North)	\$65,005
17	Ottawa (Distinct)	60 Years (2 Life Cycles)	7%	\$63,988	17	Ottawa (Distinct)	\$49,309	17	Kitchener-Waterloo (South)	\$65,377
18	Kingston (South)	60 Years (2 Life Cycles)	7%	\$64,087	18	Kingston (South)	\$49,410	18	Peterborough (Distinct)	\$65,676
19	Warton (South)	60 Years (2 Life Cycles)	7%	\$64,265	19	Warton (South)	\$49,563	19	Mt. Forest (South)	\$65,861
20	Peterborough (Distinct)	60 Years (2 Life Cycles)	7%	\$64,548	20	Peterborough (Distinct)	\$49,869	20	Warton (South)	\$66,916
21	North Bay (North)	60 Years (2 Life Cycles)	7%	\$64,672	21	Muskoka (Distinct)	\$49,970	21	Trenton (South)	\$67,800
22	Muskoka (Distinct)	60 Years (2 Life Cycles)	7%	\$64,680	22	North Bay (North)	\$50,024	22	Kingston (South)	\$68,587
23	Sudbury (North)	60 Years (2 Life Cycles)	7%	\$65,416	23	Sudbury (North)	\$50,775	23	Thunder Bay (North)	\$69,664
24	Timmins (North)	60 Years (2 Life Cycles)	7%	\$66,656	24	Timmins (North)	\$52,017	24	Sudbury (North)	\$70,043
25	Thunder Bay (North)	60 Years (2 Life Cycles)	7%	\$67,154	25	Thunder Bay (North)	\$52,490	25	Kenora (North)	\$70,903
26	Kenora (North)	60 Years (2 Life Cycles)	7%	\$67,540	26	Kenora (North)	\$52,845	26	Timmins (North)	\$71,829
27	Kapuskasing (North)	60 Years (2 Life Cycles)	7%	\$68,385	27	Kapuskasing (North)	\$53,696	27	Kapuskasing (North)	\$77,813

Table F2-1.8: Rankings of cities for carbon taxes scenario (improved construction type) at a discount rate of 7% (two life cycles of V.GSHP and H.GSHP and five life cycles of Traditional HVAC Applications for a 60 year project lifespan)

FIT – (#2)

Total Present Value										
FIT - (#2)										
#	City	Project Life Span	Discount Rate	V.GSHP	#	City	H.GSHP	#	City	Traditional
1	Sarnia (South)	60 Years (2 Life Cycles)	7%	\$44,830	1	St. Catharines (South)	\$33,480	1	Cambridge (South)	\$47,171
2	Chatham (South)	60 Years (2 Life Cycles)	7%	\$44,987	2	Sarnia (South)	\$33,786	2	Guelph (South)	\$47,796
3	Windsor (South)	60 Years (2 Life Cycles)	7%	\$44,998	3	Chatham (South)	\$33,962	3	Barrie (Distinct)	\$49,495
4	Niagara Falls (South)	60 Years (2 Life Cycles)	7%	\$45,171	4	Windsor (South)	\$33,980	4	London (South)	\$50,222
5	Simcoe (South)	60 Years (2 Life Cycles)	7%	\$45,460	5	Niagara Falls (South)	\$34,152	5	Chatham (South)	\$50,963
6	Hamilton (South)	60 Years (2 Life Cycles)	7%	\$45,680	6	Simcoe (South)	\$34,441	6	Windsor (South)	\$51,004
7	Cambridge (South)	60 Years (2 Life Cycles)	7%	\$45,924	7	Hamilton (South)	\$34,660	7	Muskoka (Distinct)	\$51,258
8	London (South)	60 Years (2 Life Cycles)	7%	\$45,927	8	London (South)	\$34,895	8	Sarnia (South)	\$51,412
9	Guelph (South)	60 Years (2 Life Cycles)	7%	\$46,109	9	Cambridge (South)	\$34,905	9	Sault Ste. Marie (North)	\$51,406
10	Sault Ste. Marie (North)	60 Years (2 Life Cycles)	7%	\$47,090	10	Toronto (South)	\$34,923	10	Niagara Falls (South)	\$52,089
11	St. Catharines (South)	60 Years (2 Life Cycles)	7%	\$55,393	11	Guelph (South)	\$35,090	11	St. Catharines (South)	\$52,280
12	Toronto (South)	60 Years (2 Life Cycles)	7%	\$56,788	12	Mt. Forest (South)	\$35,416	12	Toronto (South)	\$52,406
13	Trenton (South)	60 Years (2 Life Cycles)	7%	\$56,935	13	Sault Ste. Marie (North)	\$36,093	13	Ottawa (Distinct)	\$52,872
14	Kitchener-Waterloo (South)	60 Years (2 Life Cycles)	7%	\$57,097	14	Trenton (South)	\$42,190	14	North Bay (North)	\$52,901
15	Mt. Forest (South)	60 Years (2 Life Cycles)	7%	\$57,209	15	Kitchener-Waterloo (South)	\$42,367	15	Hamilton (South)	\$53,050
16	Barrie (Distinct)	60 Years (2 Life Cycles)	7%	\$57,263	16	Barrie (Distinct)	\$42,510	16	Simcoe (South)	\$53,708
17	Ottawa (Distinct)	60 Years (2 Life Cycles)	7%	\$57,308	17	Ottawa (Distinct)	\$42,576	17	Peterborough (Distinct)	\$53,687
18	Kingston (South)	60 Years (2 Life Cycles)	7%	\$57,377	18	Kingston (South)	\$42,647	18	Mt. Forest (South)	\$53,692
19	Warton (South)	60 Years (2 Life Cycles)	7%	\$57,503	19	Warton (South)	\$42,755	19	Kitchener-Waterloo (South)	\$53,924
20	Peterborough (Distinct)	60 Years (2 Life Cycles)	7%	\$57,701	20	Peterborough (Distinct)	\$42,969	20	Warton (South)	\$55,043
21	North Bay (North)	60 Years (2 Life Cycles)	7%	\$57,788	21	Muskoka (Distinct)	\$43,040	21	Thunder Bay (North)	\$55,958
22	Muskoka (Distinct)	60 Years (2 Life Cycles)	7%	\$57,793	22	North Bay (North)	\$43,078	22	Trenton (South)	\$56,607
23	Sudbury (North)	60 Years (2 Life Cycles)	7%	\$58,310	23	Sudbury (North)	\$43,605	23	Kingston (South)	\$57,068
24	Timmins (North)	60 Years (2 Life Cycles)	7%	\$59,180	24	Timmins (North)	\$44,476	24	Sudbury (North)	\$57,070
25	Thunder Bay (North)	60 Years (2 Life Cycles)	7%	\$59,530	25	Thunder Bay (North)	\$44,808	25	Kenora (North)	\$57,016
26	Kenora (North)	60 Years (2 Life Cycles)	7%	\$59,801	26	Kenora (North)	\$45,057	26	Timmins (North)	\$57,554
27	Kapuskasing (North)	60 Years (2 Life Cycles)	7%	\$60,393	27	Kapuskasing (North)	\$45,655	27	Kapuskasing (North)	\$63,014

Table F2-1.9: Rankings of cities for feed-in tariff scenario (improved construction type) at a discount rate of 7% (two life cycles of V.GSHP and H.GSHP and five life cycles of Traditional HVAC Applications for a 60 year project lifespan)

Rebates – (#3)

Total Present Value										
Rebates - (#3)										
#	City	Project Life Span	Discount Rate	V.GSHP	#	City	H.GSHP	#	City	Traditional
1	Sarnia (South)	60 Years (2 Life Cycles)	7%	\$44,436	1	St. Catharines (South)	\$32,998	1	Cambridge (South)	\$47,171
2	Chatham (South)	60 Years (2 Life Cycles)	7%	\$44,660	2	Sarnia (South)	\$33,433	2	Guelph (South)	\$47,796
3	Windsor (South)	60 Years (2 Life Cycles)	7%	\$44,676	3	Chatham (South)	\$33,685	3	Barrie (Distinct)	\$49,495
4	Niagara Falls (South)	60 Years (2 Life Cycles)	7%	\$44,923	4	Windsor (South)	\$33,711	4	London (South)	\$50,222
5	Simcoe (South)	60 Years (2 Life Cycles)	7%	\$45,335	5	Niagara Falls (South)	\$33,956	5	Chatham (South)	\$50,963
6	Hamilton (South)	60 Years (2 Life Cycles)	7%	\$45,648	6	Simcoe (South)	\$34,367	6	Windsor (South)	\$51,004
7	Cambridge (South)	60 Years (2 Life Cycles)	7%	\$45,996	7	Hamilton (South)	\$34,680	7	Muskoka (Distinct)	\$51,258
8	London (South)	60 Years (2 Life Cycles)	7%	\$46,001	8	London (South)	\$35,014	8	Sarnia (South)	\$51,412
9	Guelph (South)	60 Years (2 Life Cycles)	7%	\$46,259	9	Cambridge (South)	\$35,028	9	Sault Ste. Marie (North)	\$51,406
10	Sault Ste. Marie (North)	60 Years (2 Life Cycles)	7%	\$47,657	10	Toronto (South)	\$35,054	10	Niagara Falls (South)	\$52,089
11	St. Catharines (South)	60 Years (2 Life Cycles)	7%	\$55,069	11	Guelph (South)	\$35,292	11	St. Catharines (South)	\$52,280
12	Toronto (South)	60 Years (2 Life Cycles)	7%	\$57,057	12	Mt. Forest (South)	\$35,758	12	Toronto (South)	\$52,406
13	Trenton (South)	60 Years (2 Life Cycles)	7%	\$57,266	13	Sault Ste. Marie (North)	\$36,722	13	Ottawa (Distinct)	\$52,872
14	Kitchener-Waterloo (South)	60 Years (2 Life Cycles)	7%	\$57,497	14	Trenton (South)	\$42,569	14	North Bay (North)	\$52,901
15	Mt. Forest (South)	60 Years (2 Life Cycles)	7%	\$57,657	15	Kitchener-Waterloo (South)	\$42,820	15	Hamilton (South)	\$53,050
16	Barrie (Distinct)	60 Years (2 Life Cycles)	7%	\$57,735	16	Barrie (Distinct)	\$43,025	16	Simcoe (South)	\$53,708
17	Ottawa (Distinct)	60 Years (2 Life Cycles)	7%	\$57,798	17	Ottawa (Distinct)	\$43,119	17	Peterborough (Distinct)	\$53,687
18	Kingston (South)	60 Years (2 Life Cycles)	7%	\$57,897	18	Kingston (South)	\$43,220	18	Mt. Forest (South)	\$53,692
19	Warton (South)	60 Years (2 Life Cycles)	7%	\$58,076	19	Warton (South)	\$43,373	19	Kitchener-Waterloo (South)	\$53,924
20	Peterborough (Distinct)	60 Years (2 Life Cycles)	7%	\$58,358	20	Peterborough (Distinct)	\$43,679	20	Warton (South)	\$55,043
21	North Bay (North)	60 Years (2 Life Cycles)	7%	\$58,483	21	Muskoka (Distinct)	\$43,780	21	Thunder Bay (North)	\$55,958
22	Muskoka (Distinct)	60 Years (2 Life Cycles)	7%	\$58,490	22	North Bay (North)	\$43,834	22	Trenton (South)	\$56,607
23	Sudbury (North)	60 Years (2 Life Cycles)	7%	\$59,226	23	Sudbury (North)	\$44,585	23	Kingston (South)	\$57,068
24	Timmins (North)	60 Years (2 Life Cycles)	7%	\$60,466	24	Timmins (North)	\$45,827	24	Sudbury (North)	\$57,070
25	Thunder Bay (North)	60 Years (2 Life Cycles)	7%	\$60,965	25	Thunder Bay (North)	\$46,300	25	Kenora (North)	\$57,016
26	Kenora (North)	60 Years (2 Life Cycles)	7%	\$61,351	26	Kenora (North)	\$46,655	26	Timmins (North)	\$57,554
27	Kapuskasing (North)	60 Years (2 Life Cycles)	7%	\$62,195	27	Kapuskasing (North)	\$47,507	27	Kapuskasing (North)	\$63,014

Table F2-1.10: Rankings of cities for rebates scenario (improved construction type) at a discount rate of 7% (two life cycles of V.GSHP and H.GSHP and five life cycles of Traditional HVAC Applications for a 60 year project lifespan)

FIT + Rebates – (#4)

Total Present Value										
(FIT+Rebates) - (#4)										
#	City	Project Life Span	Discount Rate	V.GSHP	#	City	H.GSHP	#	City	Traditional
1	Sarnia (South)	60 Years (2 Life Cycles)	7%	\$38,640	1	St. Catharines (South)	\$27,290	1	Cambridge (South)	\$47,171
2	Chatham (South)	60 Years (2 Life Cycles)	7%	\$38,797	2	Sarnia (South)	\$27,596	2	Guelph (South)	\$47,796
3	Windsor (South)	60 Years (2 Life Cycles)	7%	\$38,808	3	Chatham (South)	\$27,772	3	Barrie (Distinct)	\$49,495
4	Niagara Falls (South)	60 Years (2 Life Cycles)	7%	\$38,982	4	Windsor (South)	\$27,791	4	London (South)	\$50,222
5	Simcoe (South)	60 Years (2 Life Cycles)	7%	\$39,271	5	Niagara Falls (South)	\$27,962	5	Chatham (South)	\$50,963
6	Hamilton (South)	60 Years (2 Life Cycles)	7%	\$39,490	6	Simcoe (South)	\$28,251	6	Windsor (South)	\$51,004
7	Cambridge (South)	60 Years (2 Life Cycles)	7%	\$39,734	7	Hamilton (South)	\$28,471	7	Muskoka (Distinct)	\$51,258
8	London (South)	60 Years (2 Life Cycles)	7%	\$39,738	8	London (South)	\$28,705	8	Sarnia (South)	\$51,412
9	Guelph (South)	60 Years (2 Life Cycles)	7%	\$39,919	9	Cambridge (South)	\$28,715	9	Sault Ste. Marie (North)	\$51,406
10	Sault Ste. Marie (North)	60 Years (2 Life Cycles)	7%	\$40,900	10	Toronto (South)	\$28,733	10	Niagara Falls (South)	\$52,089
11	St. Catharines (South)	60 Years (2 Life Cycles)	7%	\$49,203	11	Guelph (South)	\$28,900	11	St. Catharines (South)	\$52,280
12	Toronto (South)	60 Years (2 Life Cycles)	7%	\$50,598	12	Mt. Forest (South)	\$29,227	12	Toronto (South)	\$52,406
13	Trenton (South)	60 Years (2 Life Cycles)	7%	\$50,745	13	Sault Ste. Marie (North)	\$29,903	13	Ottawa (Distinct)	\$52,872
14	Kitchener-Waterloo (South)	60 Years (2 Life Cycles)	7%	\$50,907	14	Trenton (South)	\$36,000	14	North Bay (North)	\$52,901
15	Mt. Forest (South)	60 Years (2 Life Cycles)	7%	\$51,019	15	Kitchener-Waterloo (South)	\$36,177	15	Hamilton (South)	\$53,050
16	Barrie (Distinct)	60 Years (2 Life Cycles)	7%	\$51,074	16	Barrie (Distinct)	\$36,321	16	Simcoe (South)	\$53,708
17	Ottawa (Distinct)	60 Years (2 Life Cycles)	7%	\$51,118	17	Ottawa (Distinct)	\$36,387	17	Peterborough (Distinct)	\$53,687
18	Kingston (South)	60 Years (2 Life Cycles)	7%	\$51,188	18	Kingston (South)	\$36,458	18	Mt. Forest (South)	\$53,692
19	Warton (South)	60 Years (2 Life Cycles)	7%	\$51,313	19	Warton (South)	\$36,565	19	Kitchener-Waterloo (South)	\$53,924
20	Peterborough (Distinct)	60 Years (2 Life Cycles)	7%	\$51,511	20	Peterborough (Distinct)	\$36,779	20	Warton (South)	\$55,043
21	North Bay (North)	60 Years (2 Life Cycles)	7%	\$51,599	21	Muskoka (Distinct)	\$36,850	21	Thunder Bay (North)	\$55,958
22	Muskoka (Distinct)	60 Years (2 Life Cycles)	7%	\$51,604	22	North Bay (North)	\$36,888	22	Trenton (South)	\$56,607
23	Sudbury (North)	60 Years (2 Life Cycles)	7%	\$52,120	23	Sudbury (North)	\$37,415	23	Kingston (South)	\$57,068
24	Timmins (North)	60 Years (2 Life Cycles)	7%	\$52,990	24	Timmins (North)	\$38,287	24	Sudbury (North)	\$57,070
25	Thunder Bay (North)	60 Years (2 Life Cycles)	7%	\$53,340	25	Thunder Bay (North)	\$38,618	25	Kenora (North)	\$57,016
26	Kenora (North)	60 Years (2 Life Cycles)	7%	\$53,611	26	Kenora (North)	\$38,868	26	Timmins (North)	\$57,554
27	Kapuskasing (North)	60 Years (2 Life Cycles)	7%	\$54,203	27	Kapuskasing (North)	\$39,465	27	Kapuskasing (North)	\$63,014

Table F2-1.11: Rankings of cities for feed-in tariff + rebates scenario (improved construction type) at a discount rate of 7% (two life cycles of V.GSHP and H.GSHP and five life cycles of Traditional HVAC Applications for a 60 year project lifespan)

(FIT + Rebates) + Carbon Taxes – (#5)

Total Present Value										
(FIT+Rebates) + Carbon Taxes - (#5)										
#	City	Project Life Span	Discount Rate	V.GSHP	#	City	H.GSHP	#	City	Traditional
1	Sarnia (South)	60 Years (2 Life Cycles)	7%	\$38,640	1	St. Catharines (South)	\$27,290	1	Cambridge (South)	\$58,270
2	Chatham (South)	60 Years (2 Life Cycles)	7%	\$38,797	2	Sarnia (South)	\$27,596	2	Guelph (South)	\$59,224
3	Windsor (South)	60 Years (2 Life Cycles)	7%	\$38,808	3	Chatham (South)	\$27,772	3	Barrie (Distinct)	\$60,739
4	Niagara Falls (South)	60 Years (2 Life Cycles)	7%	\$38,982	4	Windsor (South)	\$27,791	4	Chatham (South)	\$60,941
5	Simcoe (South)	60 Years (2 Life Cycles)	7%	\$39,271	5	Niagara Falls (South)	\$27,962	5	Windsor (South)	\$61,007
6	Hamilton (South)	60 Years (2 Life Cycles)	7%	\$39,490	6	Simcoe (South)	\$28,251	6	London (South)	\$61,321
7	Cambridge (South)	60 Years (2 Life Cycles)	7%	\$39,734	7	Hamilton (South)	\$28,471	7	Sarnia (South)	\$61,604
8	London (South)	60 Years (2 Life Cycles)	7%	\$39,738	8	London (South)	\$28,705	8	St. Catharines (South)	\$62,048
9	Guelph (South)	60 Years (2 Life Cycles)	7%	\$39,919	9	Cambridge (South)	\$28,715	9	Niagara Falls (South)	\$62,183
10	Sault Ste. Marie (North)	60 Years (2 Life Cycles)	7%	\$40,900	10	Toronto (South)	\$28,733	10	Muskoka (Distinct)	\$63,286
11	St. Catharines (South)	60 Years (2 Life Cycles)	7%	\$49,203	11	Guelph (South)	\$28,900	11	Toronto (South)	\$63,527
12	Toronto (South)	60 Years (2 Life Cycles)	7%	\$50,598	12	Mt. Forest (South)	\$29,227	12	Sault Ste. Marie (North)	\$63,781
13	Trenton (South)	60 Years (2 Life Cycles)	7%	\$50,745	13	Sault Ste. Marie (North)	\$29,903	13	Hamilton (South)	\$63,867
14	Kitchener-Waterloo (South)	60 Years (2 Life Cycles)	7%	\$50,907	14	Trenton (South)	\$36,000	14	Simcoe (South)	\$64,286
15	Mt. Forest (South)	60 Years (2 Life Cycles)	7%	\$51,019	15	Kitchener-Waterloo (South)	\$36,177	15	Ottawa (Distinct)	\$64,372
16	Barrie (Distinct)	60 Years (2 Life Cycles)	7%	\$51,074	16	Barrie (Distinct)	\$36,321	16	North Bay (North)	\$65,005
17	Ottawa (Distinct)	60 Years (2 Life Cycles)	7%	\$51,118	17	Ottawa (Distinct)	\$36,387	17	Kitchener-Waterloo (South)	\$65,377
18	Kingston (South)	60 Years (2 Life Cycles)	7%	\$51,188	18	Kingston (South)	\$36,458	18	Peterborough (Distinct)	\$65,676
19	Warton (South)	60 Years (2 Life Cycles)	7%	\$51,313	19	Warton (South)	\$36,565	19	Mt. Forest (South)	\$65,861
20	Peterborough (Distinct)	60 Years (2 Life Cycles)	7%	\$51,511	20	Peterborough (Distinct)	\$36,779	20	Warton (South)	\$66,916
21	North Bay (North)	60 Years (2 Life Cycles)	7%	\$51,599	21	Muskoka (Distinct)	\$36,850	21	Trenton (South)	\$67,800
22	Muskoka (Distinct)	60 Years (2 Life Cycles)	7%	\$51,604	22	North Bay (North)	\$36,888	22	Kingston (South)	\$68,587
23	Sudbury (North)	60 Years (2 Life Cycles)	7%	\$52,120	23	Sudbury (North)	\$37,415	23	Thunder Bay (North)	\$69,664
24	Timmins (North)	60 Years (2 Life Cycles)	7%	\$52,990	24	Timmins (North)	\$38,287	24	Sudbury (North)	\$70,043
25	Thunder Bay (North)	60 Years (2 Life Cycles)	7%	\$53,340	25	Thunder Bay (North)	\$38,618	25	Kenora (North)	\$70,903
26	Kenora (North)	60 Years (2 Life Cycles)	7%	\$53,611	26	Kenora (North)	\$38,868	26	Timmins (North)	\$71,829
27	Kapuskasing (North)	60 Years (2 Life Cycles)	7%	\$54,203	27	Kapuskasing (North)	\$39,465	27	Kapuskasing (North)	\$77,813

Table F2-1.12: Rankings of cities for feed-in tariff + rebates + carbon tax scenario (improved construction type) at a discount rate of 7% (two life cycles of V.GSHP and H.GSHP and five life cycles of Traditional HVAC Applications for a 60 year project lifespan)

3. Two Life Cycles of V.GSHP and H.GSHP and Five Life Cycles of Traditional HVAC Applications @ 7.5% Discount Rate

Base Case Scenario

Total Present Value										
Base Case Scenario										
#	City	Project Life Span	Discount Rate	V.GSHP	#	City	H.GSHP	#	City	Traditional
1	Sarnia (South)	60 Years (2 Life Cycles)	7.5%	\$48,491	1	St. Catharines (South)	\$37,352	1	Cambridge (South)	\$44,213
2	Chatham (South)	60 Years (2 Life Cycles)	7.5%	\$48,700	2	Sarnia (South)	\$37,759	2	Guelph (South)	\$44,795
3	Windsor (South)	60 Years (2 Life Cycles)	7.5%	\$48,715	3	Chatham (South)	\$37,994	3	Barrie (Distinct)	\$46,399
4	Niagara Falls (South)	60 Years (2 Life Cycles)	7.5%	\$48,946	4	Windsor (South)	\$38,018	4	London (South)	\$47,078
5	Simcoe (South)	60 Years (2 Life Cycles)	7.5%	\$49,330	5	Niagara Falls (South)	\$38,246	5	Chatham (South)	\$47,791
6	Hamilton (South)	60 Years (2 Life Cycles)	7.5%	\$49,623	6	Simcoe (South)	\$38,631	6	Windsor (South)	\$47,829
7	Cambridge (South)	60 Years (2 Life Cycles)	7.5%	\$49,948	7	Hamilton (South)	\$38,923	7	Muskoka (Distinct)	\$48,042
8	London (South)	60 Years (2 Life Cycles)	7.5%	\$49,952	8	London (South)	\$39,235	8	Sarnia (South)	\$48,210
9	Guelph (South)	60 Years (2 Life Cycles)	7.5%	\$50,194	9	Cambridge (South)	\$39,249	9	Sault Ste. Marie (North)	\$48,179
10	Sault Ste. Marie (North)	60 Years (2 Life Cycles)	7.5%	\$51,500	10	Toronto (South)	\$39,273	10	Niagara Falls (South)	\$48,843
11	St. Catharines (South)	60 Years (2 Life Cycles)	7.5%	\$58,823	11	Guelph (South)	\$39,495	11	St. Catharines (South)	\$49,022
12	Toronto (South)	60 Years (2 Life Cycles)	7.5%	\$60,680	12	Mt. Forest (South)	\$39,930	12	Toronto (South)	\$49,134
13	Trenton (South)	60 Years (2 Life Cycles)	7.5%	\$60,876	13	Sault Ste. Marie (North)	\$40,831	13	Ottawa (Distinct)	\$49,568
14	Kitchener-Waterloo (South)	60 Years (2 Life Cycles)	7.5%	\$61,091	14	Trenton (South)	\$46,540	14	North Bay (North)	\$49,592
15	Mt. Forest (South)	60 Years (2 Life Cycles)	7.5%	\$61,241	15	Kitchener-Waterloo (South)	\$46,775	15	Hamilton (South)	\$49,737
16	Barrie (Distinct)	60 Years (2 Life Cycles)	7.5%	\$61,313	16	Barrie (Distinct)	\$46,967	16	Simcoe (South)	\$50,368
17	Ottawa (Distinct)	60 Years (2 Life Cycles)	7.5%	\$61,372	17	Ottawa (Distinct)	\$47,055	17	Peterborough (Distinct)	\$50,327
18	Kingston (South)	60 Years (2 Life Cycles)	7.5%	\$61,465	18	Kingston (South)	\$47,149	18	Mt. Forest (South)	\$50,331
19	Warton (South)	60 Years (2 Life Cycles)	7.5%	\$61,632	19	Warton (South)	\$47,292	19	Kitchener-Waterloo (South)	\$50,550
20	Peterborough (Distinct)	60 Years (2 Life Cycles)	7.5%	\$61,896	20	Peterborough (Distinct)	\$47,578	20	Warton (South)	\$51,609
21	North Bay (North)	60 Years (2 Life Cycles)	7.5%	\$62,012	21	Muskoka (Distinct)	\$47,672	21	Thunder Bay (North)	\$52,441
22	Muskoka (Distinct)	60 Years (2 Life Cycles)	7.5%	\$62,019	22	North Bay (North)	\$47,723	22	Trenton (South)	\$53,089
23	Sudbury (North)	60 Years (2 Life Cycles)	7.5%	\$62,707	23	Sudbury (North)	\$48,424	23	Kingston (South)	\$53,519
24	Timmins (North)	60 Years (2 Life Cycles)	7.5%	\$63,865	24	Timmins (North)	\$49,584	24	Sudbury (North)	\$53,499
25	Thunder Bay (North)	60 Years (2 Life Cycles)	7.5%	\$64,331	25	Thunder Bay (North)	\$50,026	25	Kenora (North)	\$53,428
26	Kenora (North)	60 Years (2 Life Cycles)	7.5%	\$64,691	26	Kenora (North)	\$50,358	26	Timmins (North)	\$53,930
27	Kapuskasing (North)	60 Years (2 Life Cycles)	7.5%	\$65,480	27	Kapuskasing (North)	\$51,154	27	Kapuskasing (North)	\$59,059

Table F2-1.13: Rankings of cities for base case scenario (improved construction type) at a discount rate of 7.5% (two life cycles of V.GSHP and H.GSHP and five life cycles of Traditional HVAC Applications for a 60 year project lifespan)

Carbon Taxes – (#1)

Total Present Value										
Carbon Taxes - (#1)										
#	City	Project Life Span	Discount Rate	V.GSHP	#	City	H.GSHP	#	City	Traditional
1	Sarnia (South)	60 Years (2 Life Cycles)	7.5%	\$48,491	1	St. Catharines (South)	\$37,352	1	Cambridge (South)	\$54,110
2	Chatham (South)	60 Years (2 Life Cycles)	7.5%	\$48,700	2	Sarnia (South)	\$37,759	2	Guelph (South)	\$54,986
3	Windsor (South)	60 Years (2 Life Cycles)	7.5%	\$48,715	3	Chatham (South)	\$37,994	3	Barrie (Distinct)	\$56,426
4	Niagara Falls (South)	60 Years (2 Life Cycles)	7.5%	\$48,946	4	Windsor (South)	\$38,018	4	Chatham (South)	\$56,689
5	Simcoe (South)	60 Years (2 Life Cycles)	7.5%	\$49,330	5	Niagara Falls (South)	\$38,246	5	Windsor (South)	\$56,749
6	Hamilton (South)	60 Years (2 Life Cycles)	7.5%	\$49,623	6	Simcoe (South)	\$38,631	6	London (South)	\$56,976
7	Cambridge (South)	60 Years (2 Life Cycles)	7.5%	\$49,948	7	Hamilton (South)	\$38,923	7	Sarnia (South)	\$57,298
8	London (South)	60 Years (2 Life Cycles)	7.5%	\$49,952	8	London (South)	\$39,235	8	St. Catharines (South)	\$57,733
9	Guelph (South)	60 Years (2 Life Cycles)	7.5%	\$50,194	9	Cambridge (South)	\$39,249	9	Niagara Falls (South)	\$57,844
10	Sault Ste. Marie (North)	60 Years (2 Life Cycles)	7.5%	\$51,500	10	Toronto (South)	\$39,273	10	Muskoka (Distinct)	\$58,769
11	St. Catharines (South)	60 Years (2 Life Cycles)	7.5%	\$58,823	11	Guelph (South)	\$39,495	11	Toronto (South)	\$59,051
12	Toronto (South)	60 Years (2 Life Cycles)	7.5%	\$60,680	12	Mt. Forest (South)	\$39,930	12	Sault Ste. Marie (North)	\$59,215
13	Trenton (South)	60 Years (2 Life Cycles)	7.5%	\$60,876	13	Sault Ste. Marie (North)	\$40,831	13	Hamilton (South)	\$59,383
14	Kitchener-Waterloo (South)	60 Years (2 Life Cycles)	7.5%	\$61,091	14	Trenton (South)	\$46,540	14	Simcoe (South)	\$59,801
15	Mt. Forest (South)	60 Years (2 Life Cycles)	7.5%	\$61,241	15	Kitchener-Waterloo (South)	\$46,775	15	Ottawa (Distinct)	\$59,823
16	Barrie (Distinct)	60 Years (2 Life Cycles)	7.5%	\$61,313	16	Barrie (Distinct)	\$46,967	16	North Bay (North)	\$60,386
17	Ottawa (Distinct)	60 Years (2 Life Cycles)	7.5%	\$61,372	17	Ottawa (Distinct)	\$47,055	17	Kitchener-Waterloo (South)	\$60,764
18	Kingston (South)	60 Years (2 Life Cycles)	7.5%	\$61,465	18	Kingston (South)	\$47,149	18	Peterborough (Distinct)	\$61,018
19	Warton (South)	60 Years (2 Life Cycles)	7.5%	\$61,632	19	Warton (South)	\$47,292	19	Mt. Forest (South)	\$61,183
20	Peterborough (Distinct)	60 Years (2 Life Cycles)	7.5%	\$61,896	20	Peterborough (Distinct)	\$47,578	20	Warton (South)	\$62,197
21	North Bay (North)	60 Years (2 Life Cycles)	7.5%	\$62,012	21	Muskoka (Distinct)	\$47,672	21	Trenton (South)	\$63,071
22	Muskoka (Distinct)	60 Years (2 Life Cycles)	7.5%	\$62,019	22	North Bay (North)	\$47,723	22	Kingston (South)	\$63,791
23	Sudbury (North)	60 Years (2 Life Cycles)	7.5%	\$62,707	23	Sudbury (North)	\$48,424	23	Thunder Bay (North)	\$64,664
24	Timmins (North)	60 Years (2 Life Cycles)	7.5%	\$63,865	24	Timmins (North)	\$49,584	24	Sudbury (North)	\$65,067
25	Thunder Bay (North)	60 Years (2 Life Cycles)	7.5%	\$64,331	25	Thunder Bay (North)	\$50,026	25	Kenora (North)	\$65,813
26	Kenora (North)	60 Years (2 Life Cycles)	7.5%	\$64,691	26	Kenora (North)	\$50,358	26	Timmins (North)	\$66,659
27	Kapuskasing (North)	60 Years (2 Life Cycles)	7.5%	\$65,480	27	Kapuskasing (North)	\$51,154	27	Kapuskasing (North)	\$72,256

Table F2-1.14: Rankings of cities for carbon taxes scenario (improved construction type) at a discount rate of 7.5% (two life cycles of V.GSHP and H.GSHP and five life cycles of Traditional HVAC Applications for a 60 year project lifespan)

FIT – (#2)

Total Present Value										
FIT - (#2)										
#	City	Project Life Span	Discount Rate	V.GSHP	#	City	H.GSHP	#	City	Traditional
1	Sarnia (South)	60 Years (2 Life Cycles)	7.5%	\$43,058	1	St. Catharines (South)	\$32,002	1	Cambridge (South)	\$44,213
2	Chatham (South)	60 Years (2 Life Cycles)	7.5%	\$43,204	2	Sarnia (South)	\$32,287	2	Guelph (South)	\$44,795
3	Windsor (South)	60 Years (2 Life Cycles)	7.5%	\$43,215	3	Chatham (South)	\$32,452	3	Barrie (Distinct)	\$46,399
4	Niagara Falls (South)	60 Years (2 Life Cycles)	7.5%	\$43,377	4	Windsor (South)	\$32,469	4	London (South)	\$47,078
5	Simcoe (South)	60 Years (2 Life Cycles)	7.5%	\$43,646	5	Niagara Falls (South)	\$32,629	5	Chatham (South)	\$47,791
6	Hamilton (South)	60 Years (2 Life Cycles)	7.5%	\$43,851	6	Simcoe (South)	\$32,898	6	Windsor (South)	\$47,829
7	Cambridge (South)	60 Years (2 Life Cycles)	7.5%	\$44,079	7	Hamilton (South)	\$33,103	7	Muskoka (Distinct)	\$48,042
8	London (South)	60 Years (2 Life Cycles)	7.5%	\$44,082	8	London (South)	\$33,322	8	Sarnia (South)	\$48,210
9	Guelph (South)	60 Years (2 Life Cycles)	7.5%	\$44,251	9	Cambridge (South)	\$33,331	9	Sault Ste. Marie (North)	\$48,179
10	Sault Ste. Marie (North)	60 Years (2 Life Cycles)	7.5%	\$45,166	10	Toronto (South)	\$33,348	10	Niagara Falls (South)	\$48,843
11	St. Catharines (South)	60 Years (2 Life Cycles)	7.5%	\$53,325	11	Guelph (South)	\$33,503	11	St. Catharines (South)	\$49,022
12	Toronto (South)	60 Years (2 Life Cycles)	7.5%	\$54,626	12	Mt. Forest (South)	\$33,808	12	Toronto (South)	\$49,134
13	Trenton (South)	60 Years (2 Life Cycles)	7.5%	\$54,763	13	Sault Ste. Marie (North)	\$34,440	13	Ottawa (Distinct)	\$49,568
14	Kitchener-Waterloo (South)	60 Years (2 Life Cycles)	7.5%	\$54,914	14	Trenton (South)	\$40,384	14	North Bay (North)	\$49,592
15	Mt. Forest (South)	60 Years (2 Life Cycles)	7.5%	\$55,019	15	Kitchener-Waterloo (South)	\$40,548	15	Hamilton (South)	\$49,737
16	Barrie (Distinct)	60 Years (2 Life Cycles)	7.5%	\$55,070	16	Barrie (Distinct)	\$40,682	16	Simcoe (South)	\$50,368
17	Ottawa (Distinct)	60 Years (2 Life Cycles)	7.5%	\$55,111	17	Ottawa (Distinct)	\$40,744	17	Peterborough (Distinct)	\$50,327
18	Kingston (South)	60 Years (2 Life Cycles)	7.5%	\$55,176	18	Kingston (South)	\$40,810	18	Mt. Forest (South)	\$50,331
19	Warton (South)	60 Years (2 Life Cycles)	7.5%	\$55,293	19	Warton (South)	\$40,910	19	Kitchener-Waterloo (South)	\$50,550
20	Peterborough (Distinct)	60 Years (2 Life Cycles)	7.5%	\$55,478	20	Peterborough (Distinct)	\$41,110	20	Warton (South)	\$51,609
21	North Bay (North)	60 Years (2 Life Cycles)	7.5%	\$55,559	21	Muskoka (Distinct)	\$41,177	21	Thunder Bay (North)	\$52,441
22	Muskoka (Distinct)	60 Years (2 Life Cycles)	7.5%	\$55,564	22	North Bay (North)	\$41,212	22	Trenton (South)	\$53,089
23	Sudbury (North)	60 Years (2 Life Cycles)	7.5%	\$56,046	23	Sudbury (North)	\$41,703	23	Kingston (South)	\$53,519
24	Timmins (North)	60 Years (2 Life Cycles)	7.5%	\$56,857	24	Timmins (North)	\$42,516	24	Sudbury (North)	\$53,499
25	Thunder Bay (North)	60 Years (2 Life Cycles)	7.5%	\$57,184	25	Thunder Bay (North)	\$42,826	25	Kenora (North)	\$53,428
26	Kenora (North)	60 Years (2 Life Cycles)	7.5%	\$57,436	26	Kenora (North)	\$43,058	26	Timmins (North)	\$53,930
27	Kapuskasing (North)	60 Years (2 Life Cycles)	7.5%	\$57,989	27	Kapuskasing (North)	\$43,616	27	Kapuskasing (North)	\$59,059

Table F2-1.15: Rankings of cities for feed-in tariff scenario (improved construction type) at a discount rate of 7.5% (two life cycles of V.GSHP and H.GSHP and five life cycles of Traditional HVAC Applications for a 60 year project lifespan)

Rebates – (#3)

Total Present Value										
Rebates - (#3)										
#	City	Project Life Span	Discount Rate	V.GSHP	#	City	H.GSHP	#	City	Traditional
1	Sarnia (South)	60 Years (2 Life Cycles)	7.5%	\$42,456	1	St. Catharines (South)	\$31,317	1	Cambridge (South)	\$44,213
2	Chatham (South)	60 Years (2 Life Cycles)	7.5%	\$42,665	2	Sarnia (South)	\$31,724	2	Guelph (South)	\$44,795
3	Windsor (South)	60 Years (2 Life Cycles)	7.5%	\$42,681	3	Chatham (South)	\$31,959	3	Barrie (Distinct)	\$46,399
4	Niagara Falls (South)	60 Years (2 Life Cycles)	7.5%	\$42,911	4	Windsor (South)	\$31,983	4	London (South)	\$47,078
5	Simcoe (South)	60 Years (2 Life Cycles)	7.5%	\$43,296	5	Niagara Falls (South)	\$32,212	5	Chatham (South)	\$47,791
6	Hamilton (South)	60 Years (2 Life Cycles)	7.5%	\$43,588	6	Simcoe (South)	\$32,597	6	Windsor (South)	\$47,829
7	Cambridge (South)	60 Years (2 Life Cycles)	7.5%	\$43,914	7	Hamilton (South)	\$32,889	7	Muskoka (Distinct)	\$48,042
8	London (South)	60 Years (2 Life Cycles)	7.5%	\$43,918	8	London (South)	\$33,201	8	Sarnia (South)	\$48,210
9	Guelph (South)	60 Years (2 Life Cycles)	7.5%	\$44,160	9	Cambridge (South)	\$33,214	9	Sault Ste. Marie (North)	\$48,179
10	Sault Ste. Marie (North)	60 Years (2 Life Cycles)	7.5%	\$45,465	10	Toronto (South)	\$33,238	10	Niagara Falls (South)	\$48,843
11	St. Catharines (South)	60 Years (2 Life Cycles)	7.5%	\$52,788	11	Guelph (South)	\$33,460	11	St. Catharines (South)	\$49,022
12	Toronto (South)	60 Years (2 Life Cycles)	7.5%	\$54,646	12	Mt. Forest (South)	\$33,896	12	Toronto (South)	\$49,134
13	Trenton (South)	60 Years (2 Life Cycles)	7.5%	\$54,841	13	Sault Ste. Marie (North)	\$34,797	13	Ottawa (Distinct)	\$49,568
14	Kitchener-Waterloo (South)	60 Years (2 Life Cycles)	7.5%	\$55,057	14	Trenton (South)	\$40,506	14	North Bay (North)	\$49,592
15	Mt. Forest (South)	60 Years (2 Life Cycles)	7.5%	\$55,206	15	Kitchener-Waterloo (South)	\$40,741	15	Hamilton (South)	\$49,737
16	Barrie (Distinct)	60 Years (2 Life Cycles)	7.5%	\$55,279	16	Barrie (Distinct)	\$40,932	16	Simcoe (South)	\$50,368
17	Ottawa (Distinct)	60 Years (2 Life Cycles)	7.5%	\$55,338	17	Ottawa (Distinct)	\$41,020	17	Peterborough (Distinct)	\$50,327
18	Kingston (South)	60 Years (2 Life Cycles)	7.5%	\$55,430	18	Kingston (South)	\$41,115	18	Mt. Forest (South)	\$50,331
19	Warton (South)	60 Years (2 Life Cycles)	7.5%	\$55,597	19	Warton (South)	\$41,257	19	Kitchener-Waterloo (South)	\$50,550
20	Peterborough (Distinct)	60 Years (2 Life Cycles)	7.5%	\$55,861	20	Peterborough (Distinct)	\$41,543	20	Warton (South)	\$51,609
21	North Bay (North)	60 Years (2 Life Cycles)	7.5%	\$55,978	21	Muskoka (Distinct)	\$41,638	21	Thunder Bay (North)	\$52,441
22	Muskoka (Distinct)	60 Years (2 Life Cycles)	7.5%	\$55,984	22	North Bay (North)	\$41,688	22	Trenton (South)	\$53,089
23	Sudbury (North)	60 Years (2 Life Cycles)	7.5%	\$56,672	23	Sudbury (North)	\$42,389	23	Kingston (South)	\$53,519
24	Timmins (North)	60 Years (2 Life Cycles)	7.5%	\$57,830	24	Timmins (North)	\$43,550	24	Sudbury (North)	\$53,499
25	Thunder Bay (North)	60 Years (2 Life Cycles)	7.5%	\$58,296	25	Thunder Bay (North)	\$43,992	25	Kenora (North)	\$53,428
26	Kenora (North)	60 Years (2 Life Cycles)	7.5%	\$58,657	26	Kenora (North)	\$44,323	26	Timmins (North)	\$53,930
27	Kapuskasing (North)	60 Years (2 Life Cycles)	7.5%	\$59,446	27	Kapuskasing (North)	\$45,119	27	Kapuskasing (North)	\$59,059

Table F2-1.16: Rankings of cities for rebates scenario (improved construction type) at a discount rate of 7.5% (two life cycles of V.GSHP and H.GSHP and five life cycles of Traditional HVAC Applications for a 60 year project lifespan)

FIT + Rebates – (#4)

Total Present Value										
(FIT+Rebates) - (#4)										
#	City	Project Life Span	Discount Rate	V.GSHP	#	City	H.GSHP	#	City	Traditional
1	Sarnia (South)	60 Years (2 Life Cycles)	7.5%	\$37,024	1	St. Catharines (South)	\$25,967	1	Cambridge (South)	\$44,213
2	Chatham (South)	60 Years (2 Life Cycles)	7.5%	\$37,170	2	Sarnia (South)	\$26,252	2	Guelph (South)	\$44,795
3	Windsor (South)	60 Years (2 Life Cycles)	7.5%	\$37,181	3	Chatham (South)	\$26,417	3	Barrie (Distinct)	\$46,399
4	Niagara Falls (South)	60 Years (2 Life Cycles)	7.5%	\$37,342	4	Windsor (South)	\$26,434	4	London (South)	\$47,078
5	Simcoe (South)	60 Years (2 Life Cycles)	7.5%	\$37,612	5	Niagara Falls (South)	\$26,594	5	Chatham (South)	\$47,791
6	Hamilton (South)	60 Years (2 Life Cycles)	7.5%	\$37,817	6	Simcoe (South)	\$26,864	6	Windsor (South)	\$47,829
7	Cambridge (South)	60 Years (2 Life Cycles)	7.5%	\$38,045	7	Hamilton (South)	\$27,069	7	Muskoka (Distinct)	\$48,042
8	London (South)	60 Years (2 Life Cycles)	7.5%	\$38,048	8	London (South)	\$27,287	8	Sarnia (South)	\$48,210
9	Guelph (South)	60 Years (2 Life Cycles)	7.5%	\$38,217	9	Cambridge (South)	\$27,296	9	Sault Ste. Marie (North)	\$48,179
10	Sault Ste. Marie (North)	60 Years (2 Life Cycles)	7.5%	\$39,132	10	Toronto (South)	\$27,313	10	Niagara Falls (South)	\$48,843
11	St. Catharines (South)	60 Years (2 Life Cycles)	7.5%	\$47,290	11	Guelph (South)	\$27,469	11	St. Catharines (South)	\$49,022
12	Toronto (South)	60 Years (2 Life Cycles)	7.5%	\$48,592	12	Mt. Forest (South)	\$27,774	12	Toronto (South)	\$49,134
13	Trenton (South)	60 Years (2 Life Cycles)	7.5%	\$48,729	13	Sault Ste. Marie (North)	\$28,405	13	Ottawa (Distinct)	\$49,568
14	Kitchener-Waterloo (South)	60 Years (2 Life Cycles)	7.5%	\$48,880	14	Trenton (South)	\$34,349	14	North Bay (North)	\$49,592
15	Mt. Forest (South)	60 Years (2 Life Cycles)	7.5%	\$48,984	15	Kitchener-Waterloo (South)	\$34,514	15	Hamilton (South)	\$49,737
16	Barrie (Distinct)	60 Years (2 Life Cycles)	7.5%	\$49,035	16	Barrie (Distinct)	\$34,648	16	Simcoe (South)	\$50,368
17	Ottawa (Distinct)	60 Years (2 Life Cycles)	7.5%	\$49,077	17	Ottawa (Distinct)	\$34,709	17	Peterborough (Distinct)	\$50,327
18	Kingston (South)	60 Years (2 Life Cycles)	7.5%	\$49,141	18	Kingston (South)	\$34,776	18	Mt. Forest (South)	\$50,331
19	Warton (South)	60 Years (2 Life Cycles)	7.5%	\$49,258	19	Warton (South)	\$34,876	19	Kitchener-Waterloo (South)	\$50,550
20	Peterborough (Distinct)	60 Years (2 Life Cycles)	7.5%	\$49,443	20	Peterborough (Distinct)	\$35,076	20	Warton (South)	\$51,609
21	North Bay (North)	60 Years (2 Life Cycles)	7.5%	\$49,525	21	Muskoka (Distinct)	\$35,142	21	Thunder Bay (North)	\$52,441
22	Muskoka (Distinct)	60 Years (2 Life Cycles)	7.5%	\$49,529	22	North Bay (North)	\$35,178	22	Trenton (South)	\$53,089
23	Sudbury (North)	60 Years (2 Life Cycles)	7.5%	\$50,011	23	Sudbury (North)	\$35,669	23	Kingston (South)	\$53,519
24	Timmins (North)	60 Years (2 Life Cycles)	7.5%	\$50,823	24	Timmins (North)	\$36,482	24	Sudbury (North)	\$53,499
25	Thunder Bay (North)	60 Years (2 Life Cycles)	7.5%	\$51,149	25	Thunder Bay (North)	\$36,791	25	Kenora (North)	\$53,428
26	Kenora (North)	60 Years (2 Life Cycles)	7.5%	\$51,402	26	Kenora (North)	\$37,024	26	Timmins (North)	\$53,930
27	Kapuskasing (North)	60 Years (2 Life Cycles)	7.5%	\$51,955	27	Kapuskasing (North)	\$37,581	27	Kapuskasing (North)	\$59,059

Table F2-1.17: Rankings of cities for feed-in tariff + rebates scenario (improved construction type) at a discount rate of 7.5% (two life cycles of V.GSHP and H.GSHP and five life cycles of Traditional HVAC Applications for a 60 year project lifespan)

(FIT + Rebates) + Carbon Taxes – (#5)

Total Present Value										
(FIT+Rebates) + Carbon Taxes - (#5)										
#	City	Project Life Span	Discount Rate	V.GSHP	#	City	H.GSHP	#	City	Traditional
1	Sarnia (South)	60 Years (2 Life Cycles)	7.5%	\$37,024	1	St. Catharines (South)	\$25,967	1	Cambridge (South)	\$54,110
2	Chatham (South)	60 Years (2 Life Cycles)	7.5%	\$37,170	2	Sarnia (South)	\$26,252	2	Guelph (South)	\$54,986
3	Windsor (South)	60 Years (2 Life Cycles)	7.5%	\$37,181	3	Chatham (South)	\$26,417	3	Barrie (Distinct)	\$56,426
4	Niagara Falls (South)	60 Years (2 Life Cycles)	7.5%	\$37,342	4	Windsor (South)	\$26,434	4	Chatham (South)	\$56,689
5	Simcoe (South)	60 Years (2 Life Cycles)	7.5%	\$37,612	5	Niagara Falls (South)	\$26,594	5	Windsor (South)	\$56,749
6	Hamilton (South)	60 Years (2 Life Cycles)	7.5%	\$37,817	6	Simcoe (South)	\$26,864	6	London (South)	\$56,976
7	Cambridge (South)	60 Years (2 Life Cycles)	7.5%	\$38,045	7	Hamilton (South)	\$27,069	7	Sarnia (South)	\$57,298
8	London (South)	60 Years (2 Life Cycles)	7.5%	\$38,048	8	London (South)	\$27,287	8	St. Catharines (South)	\$57,733
9	Guelph (South)	60 Years (2 Life Cycles)	7.5%	\$38,217	9	Cambridge (South)	\$27,296	9	Niagara Falls (South)	\$57,844
10	Sault Ste. Marie (North)	60 Years (2 Life Cycles)	7.5%	\$39,132	10	Toronto (South)	\$27,313	10	Muskoka (Distinct)	\$58,769
11	St. Catharines (South)	60 Years (2 Life Cycles)	7.5%	\$47,290	11	Guelph (South)	\$27,469	11	Toronto (South)	\$59,051
12	Toronto (South)	60 Years (2 Life Cycles)	7.5%	\$48,592	12	Mt. Forest (South)	\$27,774	12	Sault Ste. Marie (North)	\$59,215
13	Trenton (South)	60 Years (2 Life Cycles)	7.5%	\$48,729	13	Sault Ste. Marie (North)	\$28,405	13	Hamilton (South)	\$59,383
14	Kitchener-Waterloo (South)	60 Years (2 Life Cycles)	7.5%	\$48,880	14	Trenton (South)	\$34,349	14	Simcoe (South)	\$59,801
15	Mt. Forest (South)	60 Years (2 Life Cycles)	7.5%	\$48,984	15	Kitchener-Waterloo (South)	\$34,514	15	Ottawa (Distinct)	\$59,823
16	Barrie (Distinct)	60 Years (2 Life Cycles)	7.5%	\$49,035	16	Barrie (Distinct)	\$34,648	16	North Bay (North)	\$60,386
17	Ottawa (Distinct)	60 Years (2 Life Cycles)	7.5%	\$49,077	17	Ottawa (Distinct)	\$34,709	17	Kitchener-Waterloo (South)	\$60,764
18	Kingston (South)	60 Years (2 Life Cycles)	7.5%	\$49,141	18	Kingston (South)	\$34,776	18	Peterborough (Distinct)	\$61,018
19	Warton (South)	60 Years (2 Life Cycles)	7.5%	\$49,258	19	Warton (South)	\$34,876	19	Mt. Forest (South)	\$61,183
20	Peterborough (Distinct)	60 Years (2 Life Cycles)	7.5%	\$49,443	20	Peterborough (Distinct)	\$35,076	20	Warton (South)	\$62,197
21	North Bay (North)	60 Years (2 Life Cycles)	7.5%	\$49,525	21	Muskoka (Distinct)	\$35,142	21	Trenton (South)	\$63,071
22	Muskoka (Distinct)	60 Years (2 Life Cycles)	7.5%	\$49,529	22	North Bay (North)	\$35,178	22	Kingston (South)	\$63,791
23	Sudbury (North)	60 Years (2 Life Cycles)	7.5%	\$50,011	23	Sudbury (North)	\$35,669	23	Thunder Bay (North)	\$64,664
24	Timmins (North)	60 Years (2 Life Cycles)	7.5%	\$50,823	24	Timmins (North)	\$36,482	24	Sudbury (North)	\$65,067
25	Thunder Bay (North)	60 Years (2 Life Cycles)	7.5%	\$51,149	25	Thunder Bay (North)	\$36,791	25	Kenora (North)	\$65,813
26	Kenora (North)	60 Years (2 Life Cycles)	7.5%	\$51,402	26	Kenora (North)	\$37,024	26	Timmins (North)	\$66,659
27	Kapuskasing (North)	60 Years (2 Life Cycles)	7.5%	\$51,955	27	Kapuskasing (North)	\$37,581	27	Kapuskasing (North)	\$72,256

Table F2-1.18: Rankings of cities for feed-in tariff + rebates + carbon tax scenario (improved construction type) at a discount rate of 7.5% (two life cycles of V.GSHP and H.GSHP and five life cycles of Traditional HVAC Applications for a 60 year project lifespan)

4. Two Life Cycles of V.GSHP and H.GSHP and Five Life Cycles of Traditional HVAC Applications @ 8.5% Discount Rate

Base Case Scenario

Total Present Value										
Base Case Scenario										
#	City	Project Life Span	Discount Rate	V.GSHP	#	City	H.GSHP	#	City	Traditional
1	Sarnia (South)	60 Years (2 Life Cycles)	8.5%	\$44,964	1	St. Catharines (South)	\$34,309	1	Cambridge (South)	\$39,315
2	Chatham (South)	60 Years (2 Life Cycles)	8.5%	\$45,148	2	Sarnia (South)	\$34,668	2	Guelph (South)	\$39,826
3	Windsor (South)	60 Years (2 Life Cycles)	8.5%	\$45,161	3	Chatham (South)	\$34,875	3	Barrie (Distinct)	\$41,273
4	Niagara Falls (South)	60 Years (2 Life Cycles)	8.5%	\$45,365	4	Windsor (South)	\$34,896	4	London (South)	\$41,873
5	Simcoe (South)	60 Years (2 Life Cycles)	8.5%	\$45,704	5	Niagara Falls (South)	\$35,098	5	Chatham (South)	\$42,540
6	Hamilton (South)	60 Years (2 Life Cycles)	8.5%	\$45,962	6	Simcoe (South)	\$35,437	6	Windsor (South)	\$42,573
7	Cambridge (South)	60 Years (2 Life Cycles)	8.5%	\$46,249	7	Hamilton (South)	\$35,695	7	Muskoka (Distinct)	\$42,717
8	London (South)	60 Years (2 Life Cycles)	8.5%	\$46,253	8	London (South)	\$35,970	8	Sarnia (South)	\$42,908
9	Guelph (South)	60 Years (2 Life Cycles)	8.5%	\$46,466	9	Cambridge (South)	\$35,982	9	Sault Ste. Marie (North)	\$42,835
10	Sault Ste. Marie (North)	60 Years (2 Life Cycles)	8.5%	\$47,618	10	Toronto (South)	\$36,003	10	Niagara Falls (South)	\$43,467
11	St. Catharines (South)	60 Years (2 Life Cycles)	8.5%	\$54,808	11	Guelph (South)	\$36,199	11	St. Catharines (South)	\$43,627
12	Toronto (South)	60 Years (2 Life Cycles)	8.5%	\$56,446	12	Mt. Forest (South)	\$36,583	12	Toronto (South)	\$43,717
13	Trenton (South)	60 Years (2 Life Cycles)	8.5%	\$56,618	13	Sault Ste. Marie (North)	\$37,378	13	Ottawa (Distinct)	\$44,097
14	Kitchener-Waterloo (South)	60 Years (2 Life Cycles)	8.5%	\$56,808	14	Trenton (South)	\$42,868	14	North Bay (North)	\$44,114
15	Mt. Forest (South)	60 Years (2 Life Cycles)	8.5%	\$56,940	15	Kitchener-Waterloo (South)	\$43,075	15	Hamilton (South)	\$44,251
16	Barrie (Distinct)	60 Years (2 Life Cycles)	8.5%	\$57,004	16	Barrie (Distinct)	\$43,244	16	Simcoe (South)	\$44,840
17	Ottawa (Distinct)	60 Years (2 Life Cycles)	8.5%	\$57,057	17	Ottawa (Distinct)	\$43,321	17	Peterborough (Distinct)	\$44,764
18	Kingston (South)	60 Years (2 Life Cycles)	8.5%	\$57,138	18	Kingston (South)	\$43,405	18	Mt. Forest (South)	\$44,765
19	Warton (South)	60 Years (2 Life Cycles)	8.5%	\$57,285	19	Warton (South)	\$43,531	19	Kitchener-Waterloo (South)	\$44,964
20	Peterborough (Distinct)	60 Years (2 Life Cycles)	8.5%	\$57,518	20	Peterborough (Distinct)	\$43,783	20	Warton (South)	\$45,926
21	North Bay (North)	60 Years (2 Life Cycles)	8.5%	\$57,621	21	Muskoka (Distinct)	\$43,866	21	Thunder Bay (North)	\$46,616
22	Muskoka (Distinct)	60 Years (2 Life Cycles)	8.5%	\$57,626	22	North Bay (North)	\$43,911	22	Trenton (South)	\$47,266
23	Sudbury (North)	60 Years (2 Life Cycles)	8.5%	\$58,233	23	Sudbury (North)	\$44,529	23	Kingston (South)	\$47,643
24	Timmins (North)	60 Years (2 Life Cycles)	8.5%	\$59,255	24	Timmins (North)	\$45,553	24	Sudbury (North)	\$47,585
25	Thunder Bay (North)	60 Years (2 Life Cycles)	8.5%	\$59,666	25	Thunder Bay (North)	\$45,942	25	Kenora (North)	\$47,486
26	Kenora (North)	60 Years (2 Life Cycles)	8.5%	\$59,984	26	Kenora (North)	\$46,235	26	Timmins (North)	\$47,925
27	Kapuskasing (North)	60 Years (2 Life Cycles)	8.5%	\$60,680	27	Kapuskasing (North)	\$46,937	27	Kapuskasing (North)	\$52,507

Table F2-1.19: Rankings of cities for base case scenario (improved construction type) at a discount rate of 8.5% (two life cycles of V.GSHP and H.GSHP and five life cycles of Traditional HVAC Applications for a 60 year project lifespan)

Carbon Taxes – (#1)

Total Present Value										
Carbon Taxes - (#1)										
#	City	Project Life Span	Discount Rate	V.GSHP	#	City	H.GSHP	#	City	Traditional
1	Sarnia (South)	60 Years (2 Life Cycles)	8.5%	\$44,964	1	St. Catharines (South)	\$34,309	1	Cambridge (South)	\$47,301
2	Chatham (South)	60 Years (2 Life Cycles)	8.5%	\$45,148	2	Sarnia (South)	\$34,668	2	Guelph (South)	\$48,049
3	Windsor (South)	60 Years (2 Life Cycles)	8.5%	\$45,161	3	Chatham (South)	\$34,875	3	Barrie (Distinct)	\$49,363
4	Niagara Falls (South)	60 Years (2 Life Cycles)	8.5%	\$45,365	4	Windsor (South)	\$34,896	4	Chatham (South)	\$49,720
5	Simcoe (South)	60 Years (2 Life Cycles)	8.5%	\$45,704	5	Niagara Falls (South)	\$35,098	5	Windsor (South)	\$49,771
6	Hamilton (South)	60 Years (2 Life Cycles)	8.5%	\$45,962	6	Simcoe (South)	\$35,437	6	London (South)	\$49,859
7	Cambridge (South)	60 Years (2 Life Cycles)	8.5%	\$46,249	7	Hamilton (South)	\$35,695	7	Sarnia (South)	\$50,241
8	London (South)	60 Years (2 Life Cycles)	8.5%	\$46,253	8	London (South)	\$35,970	8	St. Catharines (South)	\$50,656
9	Guelph (South)	60 Years (2 Life Cycles)	8.5%	\$46,466	9	Cambridge (South)	\$35,982	9	Niagara Falls (South)	\$50,730
10	Sault Ste. Marie (North)	60 Years (2 Life Cycles)	8.5%	\$47,618	10	Toronto (South)	\$36,003	10	Muskoka (Distinct)	\$51,372
11	St. Catharines (South)	60 Years (2 Life Cycles)	8.5%	\$54,808	11	Guelph (South)	\$36,199	11	Toronto (South)	\$51,719
12	Toronto (South)	60 Years (2 Life Cycles)	8.5%	\$56,446	12	Mt. Forest (South)	\$36,583	12	Sault Ste. Marie (North)	\$51,739
13	Trenton (South)	60 Years (2 Life Cycles)	8.5%	\$56,618	13	Sault Ste. Marie (North)	\$37,378	13	Hamilton (South)	\$52,034
14	Kitchener-Waterloo (South)	60 Years (2 Life Cycles)	8.5%	\$56,808	14	Trenton (South)	\$42,868	14	Ottawa (Distinct)	\$52,372
15	Mt. Forest (South)	60 Years (2 Life Cycles)	8.5%	\$56,940	15	Kitchener-Waterloo (South)	\$43,075	15	Simcoe (South)	\$52,451
16	Barrie (Distinct)	60 Years (2 Life Cycles)	8.5%	\$57,004	16	Barrie (Distinct)	\$43,244	16	North Bay (North)	\$52,823
17	Ottawa (Distinct)	60 Years (2 Life Cycles)	8.5%	\$57,057	17	Ottawa (Distinct)	\$43,321	17	Kitchener-Waterloo (South)	\$53,205
18	Kingston (South)	60 Years (2 Life Cycles)	8.5%	\$57,138	18	Kingston (South)	\$43,405	18	Peterborough (Distinct)	\$53,390
19	Warton (South)	60 Years (2 Life Cycles)	8.5%	\$57,285	19	Warton (South)	\$43,531	19	Mt. Forest (South)	\$53,521
20	Peterborough (Distinct)	60 Years (2 Life Cycles)	8.5%	\$57,518	20	Peterborough (Distinct)	\$43,783	20	Warton (South)	\$54,469
21	North Bay (North)	60 Years (2 Life Cycles)	8.5%	\$57,621	21	Muskoka (Distinct)	\$43,866	21	Trenton (South)	\$55,320
22	Muskoka (Distinct)	60 Years (2 Life Cycles)	8.5%	\$57,626	22	North Bay (North)	\$43,911	22	Kingston (South)	\$55,931
23	Sudbury (North)	60 Years (2 Life Cycles)	8.5%	\$58,233	23	Sudbury (North)	\$44,529	23	Thunder Bay (North)	\$56,478
24	Timmins (North)	60 Years (2 Life Cycles)	8.5%	\$59,255	24	Timmins (North)	\$45,553	24	Sudbury (North)	\$56,919
25	Thunder Bay (North)	60 Years (2 Life Cycles)	8.5%	\$59,666	25	Thunder Bay (North)	\$45,942	25	Kenora (North)	\$57,478
26	Kenora (North)	60 Years (2 Life Cycles)	8.5%	\$59,984	26	Kenora (North)	\$46,235	26	Timmins (North)	\$58,196
27	Kapuskasing (North)	60 Years (2 Life Cycles)	8.5%	\$60,680	27	Kapuskasing (North)	\$46,937	27	Kapuskasing (North)	\$63,155

Table F2-1.20: Rankings of cities for carbon taxes scenario (improved construction type) at a discount rate of 8.5% (two life cycles of V.GSHP and H.GSHP and five life cycles of Traditional HVAC Applications for a 60 year project lifespan)

FIT – (#2)

Total Present Value										
FIT - (#2)										
#	City	Project Life Span	Discount Rate	V.GSHP	#	City	H.GSHP	#	City	Traditional
1	Sarnia (South)	60 Years (2 Life Cycles)	8.5%	\$40,143	1	St. Catharines (South)	\$29,562	1	Cambridge (South)	\$39,315
2	Chatham (South)	60 Years (2 Life Cycles)	8.5%	\$40,272	2	Sarnia (South)	\$29,812	2	Guelph (South)	\$39,826
3	Windsor (South)	60 Years (2 Life Cycles)	8.5%	\$40,281	3	Chatham (South)	\$29,957	3	Barrie (Distinct)	\$41,273
4	Niagara Falls (South)	60 Years (2 Life Cycles)	8.5%	\$40,423	4	Windsor (South)	\$29,972	4	London (South)	\$41,873
5	Simcoe (South)	60 Years (2 Life Cycles)	8.5%	\$40,661	5	Niagara Falls (South)	\$30,113	5	Chatham (South)	\$42,540
6	Hamilton (South)	60 Years (2 Life Cycles)	8.5%	\$40,841	6	Simcoe (South)	\$30,350	6	Windsor (South)	\$42,573
7	Cambridge (South)	60 Years (2 Life Cycles)	8.5%	\$41,041	7	Hamilton (South)	\$30,531	7	Muskoka (Distinct)	\$42,717
8	London (South)	60 Years (2 Life Cycles)	8.5%	\$41,044	8	London (South)	\$30,723	8	Sarnia (South)	\$42,908
9	Guelph (South)	60 Years (2 Life Cycles)	8.5%	\$41,193	9	Cambridge (South)	\$30,731	9	Sault Ste. Marie (North)	\$42,835
10	Sault Ste. Marie (North)	60 Years (2 Life Cycles)	8.5%	\$41,998	10	Toronto (South)	\$30,746	10	Niagara Falls (South)	\$43,467
11	St. Catharines (South)	60 Years (2 Life Cycles)	8.5%	\$49,929	11	Guelph (South)	\$30,883	11	St. Catharines (South)	\$43,627
12	Toronto (South)	60 Years (2 Life Cycles)	8.5%	\$51,074	12	Mt. Forest (South)	\$31,151	12	Toronto (South)	\$43,717
13	Trenton (South)	60 Years (2 Life Cycles)	8.5%	\$51,195	13	Sault Ste. Marie (North)	\$31,707	13	Ottawa (Distinct)	\$44,097
14	Kitchener-Waterloo (South)	60 Years (2 Life Cycles)	8.5%	\$51,327	14	Trenton (South)	\$37,405	14	North Bay (North)	\$44,114
15	Mt. Forest (South)	60 Years (2 Life Cycles)	8.5%	\$51,419	15	Kitchener-Waterloo (South)	\$37,550	15	Hamilton (South)	\$44,251
16	Barrie (Distinct)	60 Years (2 Life Cycles)	8.5%	\$51,464	16	Barrie (Distinct)	\$37,668	16	Simcoe (South)	\$44,840
17	Ottawa (Distinct)	60 Years (2 Life Cycles)	8.5%	\$51,501	17	Ottawa (Distinct)	\$37,722	17	Peterborough (Distinct)	\$44,764
18	Kingston (South)	60 Years (2 Life Cycles)	8.5%	\$51,558	18	Kingston (South)	\$37,780	18	Mt. Forest (South)	\$44,765
19	Warton (South)	60 Years (2 Life Cycles)	8.5%	\$51,661	19	Warton (South)	\$37,868	19	Kitchener-Waterloo (South)	\$44,964
20	Peterborough (Distinct)	60 Years (2 Life Cycles)	8.5%	\$51,823	20	Peterborough (Distinct)	\$38,044	20	Warton (South)	\$45,926
21	North Bay (North)	60 Years (2 Life Cycles)	8.5%	\$51,895	21	Muskoka (Distinct)	\$38,102	21	Thunder Bay (North)	\$46,616
22	Muskoka (Distinct)	60 Years (2 Life Cycles)	8.5%	\$51,899	22	North Bay (North)	\$38,134	22	Trenton (South)	\$47,266
23	Sudbury (North)	60 Years (2 Life Cycles)	8.5%	\$52,323	23	Sudbury (North)	\$38,566	23	Kingston (South)	\$47,643
24	Timmins (North)	60 Years (2 Life Cycles)	8.5%	\$53,037	24	Timmins (North)	\$39,281	24	Sudbury (North)	\$47,585
25	Thunder Bay (North)	60 Years (2 Life Cycles)	8.5%	\$53,324	25	Thunder Bay (North)	\$39,554	25	Kenora (North)	\$47,486
26	Kenora (North)	60 Years (2 Life Cycles)	8.5%	\$53,547	26	Kenora (North)	\$39,758	26	Timmins (North)	\$47,925
27	Kapuskasing (North)	60 Years (2 Life Cycles)	8.5%	\$54,033	27	Kapuskasing (North)	\$40,249	27	Kapuskasing (North)	\$52,507

Table F2-1.21: Rankings of cities for feed-in tariff scenario (improved construction type) at a discount rate of 8.5% (two life cycles of V.GSHP and H.GSHP and five life cycles of Traditional HVAC Applications for a 60 year project lifespan)

Rebates – (#3)

Total Present Value										
Rebates - (#3)										
#	City	Project Life Span	Discount Rate	V.GSHP	#	City	H.GSHP	#	City	Traditional
1	Sarnia (South)	60 Years (2 Life Cycles)	8.5%	\$39,180	1	St. Catharines (South)	\$28,525	1	Cambridge (South)	\$39,315
2	Chatham (South)	60 Years (2 Life Cycles)	8.5%	\$39,364	2	Sarnia (South)	\$28,884	2	Guelph (South)	\$39,826
3	Windsor (South)	60 Years (2 Life Cycles)	8.5%	\$39,378	3	Chatham (South)	\$29,091	3	Barrie (Distinct)	\$41,273
4	Niagara Falls (South)	60 Years (2 Life Cycles)	8.5%	\$39,581	4	Windsor (South)	\$29,113	4	London (South)	\$41,873
5	Simcoe (South)	60 Years (2 Life Cycles)	8.5%	\$39,921	5	Niagara Falls (South)	\$29,314	5	Chatham (South)	\$42,540
6	Hamilton (South)	60 Years (2 Life Cycles)	8.5%	\$40,179	6	Simcoe (South)	\$29,654	6	Windsor (South)	\$42,573
7	Cambridge (South)	60 Years (2 Life Cycles)	8.5%	\$40,465	7	Hamilton (South)	\$29,912	7	Muskoka (Distinct)	\$42,717
8	London (South)	60 Years (2 Life Cycles)	8.5%	\$40,469	8	London (South)	\$30,187	8	Sarnia (South)	\$42,908
9	Guelph (South)	60 Years (2 Life Cycles)	8.5%	\$40,683	9	Cambridge (South)	\$30,198	9	Sault Ste. Marie (North)	\$42,835
10	Sault Ste. Marie (North)	60 Years (2 Life Cycles)	8.5%	\$41,834	10	Toronto (South)	\$30,220	10	Niagara Falls (South)	\$43,467
11	St. Catharines (South)	60 Years (2 Life Cycles)	8.5%	\$49,024	11	Guelph (South)	\$30,416	11	St. Catharines (South)	\$43,627
12	Toronto (South)	60 Years (2 Life Cycles)	8.5%	\$50,662	12	Mt. Forest (South)	\$30,799	12	Toronto (South)	\$43,717
13	Trenton (South)	60 Years (2 Life Cycles)	8.5%	\$50,835	13	Sault Ste. Marie (North)	\$31,594	13	Ottawa (Distinct)	\$44,097
14	Kitchener-Waterloo (South)	60 Years (2 Life Cycles)	8.5%	\$51,025	14	Trenton (South)	\$37,084	14	North Bay (North)	\$44,114
15	Mt. Forest (South)	60 Years (2 Life Cycles)	8.5%	\$51,157	15	Kitchener-Waterloo (South)	\$37,292	15	Hamilton (South)	\$44,251
16	Barrie (Distinct)	60 Years (2 Life Cycles)	8.5%	\$51,221	16	Barrie (Distinct)	\$37,460	16	Simcoe (South)	\$44,840
17	Ottawa (Distinct)	60 Years (2 Life Cycles)	8.5%	\$51,273	17	Ottawa (Distinct)	\$37,538	17	Peterborough (Distinct)	\$44,764
18	Kingston (South)	60 Years (2 Life Cycles)	8.5%	\$51,354	18	Kingston (South)	\$37,621	18	Mt. Forest (South)	\$44,765
19	Warton (South)	60 Years (2 Life Cycles)	8.5%	\$51,502	19	Warton (South)	\$37,747	19	Kitchener-Waterloo (South)	\$44,964
20	Peterborough (Distinct)	60 Years (2 Life Cycles)	8.5%	\$51,734	20	Peterborough (Distinct)	\$37,999	20	Warton (South)	\$45,926
21	North Bay (North)	60 Years (2 Life Cycles)	8.5%	\$51,837	21	Muskoka (Distinct)	\$38,082	21	Thunder Bay (North)	\$46,616
22	Muskoka (Distinct)	60 Years (2 Life Cycles)	8.5%	\$51,843	22	North Bay (North)	\$38,127	22	Trenton (South)	\$47,266
23	Sudbury (North)	60 Years (2 Life Cycles)	8.5%	\$52,450	23	Sudbury (North)	\$38,746	23	Kingston (South)	\$47,643
24	Timmins (North)	60 Years (2 Life Cycles)	8.5%	\$53,471	24	Timmins (North)	\$39,769	24	Sudbury (North)	\$47,585
25	Thunder Bay (North)	60 Years (2 Life Cycles)	8.5%	\$53,882	25	Thunder Bay (North)	\$40,159	25	Kenora (North)	\$47,486
26	Kenora (North)	60 Years (2 Life Cycles)	8.5%	\$54,200	26	Kenora (North)	\$40,452	26	Timmins (North)	\$47,925
27	Kapuskasing (North)	60 Years (2 Life Cycles)	8.5%	\$54,896	27	Kapuskasing (North)	\$41,153	27	Kapuskasing (North)	\$52,507

Table F2-1.22: Rankings of cities for rebates scenario (improved construction type) at a discount rate of 8.5% (two life cycles of V.GSHP and H.GSHP and five life cycles of Traditional HVAC Applications for a 60 year project lifespan)

FIT + Rebates – (#4)

Total Present Value										
(FIT+Rebates) - (#4)										
#	City	Project Life Span	Discount Rate	V.GSHP	#	City	H.GSHP	#	City	Traditional
1	Sarnia (South)	60 Years (2 Life Cycles)	8.5%	\$34,359	1	St. Catharines (South)	\$23,778	1	Cambridge (South)	\$39,315
2	Chatham (South)	60 Years (2 Life Cycles)	8.5%	\$34,488	2	Sarnia (South)	\$24,029	2	Guelph (South)	\$39,826
3	Windsor (South)	60 Years (2 Life Cycles)	8.5%	\$34,498	3	Chatham (South)	\$24,174	3	Barrie (Distinct)	\$41,273
4	Niagara Falls (South)	60 Years (2 Life Cycles)	8.5%	\$34,640	4	Windsor (South)	\$24,189	4	London (South)	\$41,873
5	Simcoe (South)	60 Years (2 Life Cycles)	8.5%	\$34,877	5	Niagara Falls (South)	\$24,330	5	Chatham (South)	\$42,540
6	Hamilton (South)	60 Years (2 Life Cycles)	8.5%	\$35,057	6	Simcoe (South)	\$24,567	6	Windsor (South)	\$42,573
7	Cambridge (South)	60 Years (2 Life Cycles)	8.5%	\$35,258	7	Hamilton (South)	\$24,747	7	Muskoka (Distinct)	\$42,717
8	London (South)	60 Years (2 Life Cycles)	8.5%	\$35,260	8	London (South)	\$24,939	8	Sarnia (South)	\$42,908
9	Guelph (South)	60 Years (2 Life Cycles)	8.5%	\$35,409	9	Cambridge (South)	\$24,947	9	Sault Ste. Marie (North)	\$42,835
10	Sault Ste. Marie (North)	60 Years (2 Life Cycles)	8.5%	\$36,214	10	Toronto (South)	\$24,962	10	Niagara Falls (South)	\$43,467
11	St. Catharines (South)	60 Years (2 Life Cycles)	8.5%	\$44,146	11	Guelph (South)	\$25,099	11	St. Catharines (South)	\$43,627
12	Toronto (South)	60 Years (2 Life Cycles)	8.5%	\$45,290	12	Mt. Forest (South)	\$25,367	12	Toronto (South)	\$43,717
13	Trenton (South)	60 Years (2 Life Cycles)	8.5%	\$45,411	13	Sault Ste. Marie (North)	\$25,923	13	Ottawa (Distinct)	\$44,097
14	Kitchener-Waterloo (South)	60 Years (2 Life Cycles)	8.5%	\$45,544	14	Trenton (South)	\$31,621	14	North Bay (North)	\$44,114
15	Mt. Forest (South)	60 Years (2 Life Cycles)	8.5%	\$45,636	15	Kitchener-Waterloo (South)	\$31,766	15	Hamilton (South)	\$44,251
16	Barrie (Distinct)	60 Years (2 Life Cycles)	8.5%	\$45,681	16	Barrie (Distinct)	\$31,884	16	Simcoe (South)	\$44,840
17	Ottawa (Distinct)	60 Years (2 Life Cycles)	8.5%	\$45,717	17	Ottawa (Distinct)	\$31,938	17	Peterborough (Distinct)	\$44,764
18	Kingston (South)	60 Years (2 Life Cycles)	8.5%	\$45,774	18	Kingston (South)	\$31,996	18	Mt. Forest (South)	\$44,765
19	Warton (South)	60 Years (2 Life Cycles)	8.5%	\$45,877	19	Warton (South)	\$32,085	19	Kitchener-Waterloo (South)	\$44,964
20	Peterborough (Distinct)	60 Years (2 Life Cycles)	8.5%	\$46,040	20	Peterborough (Distinct)	\$32,261	20	Warton (South)	\$45,926
21	North Bay (North)	60 Years (2 Life Cycles)	8.5%	\$46,111	21	Muskoka (Distinct)	\$32,319	21	Thunder Bay (North)	\$46,616
22	Muskoka (Distinct)	60 Years (2 Life Cycles)	8.5%	\$46,115	22	North Bay (North)	\$32,350	22	Trenton (South)	\$47,266
23	Sudbury (North)	60 Years (2 Life Cycles)	8.5%	\$46,540	23	Sudbury (North)	\$32,782	23	Kingston (South)	\$47,643
24	Timmins (North)	60 Years (2 Life Cycles)	8.5%	\$47,254	24	Timmins (North)	\$33,498	24	Sudbury (North)	\$47,585
25	Thunder Bay (North)	60 Years (2 Life Cycles)	8.5%	\$47,541	25	Thunder Bay (North)	\$33,770	25	Kenora (North)	\$47,486
26	Kenora (North)	60 Years (2 Life Cycles)	8.5%	\$47,763	26	Kenora (North)	\$33,975	26	Timmins (North)	\$47,925
27	Kapuskasing (North)	60 Years (2 Life Cycles)	8.5%	\$48,249	27	Kapuskasing (North)	\$34,465	27	Kapuskasing (North)	\$52,507

Table F2-1.23: Rankings of cities for feed-in tariff + rebates scenario (improved construction type) at a discount rate of 8.5% (two life cycles of V.GSHP and H.GSHP and five life cycles of Traditional HVAC Applications for a 60 year project lifespan)

(FIT + Rebates) + Carbon Taxes – (#5)

Total Present Value										
(FIT+Rebates) + Carbon Taxes - (#5)										
#	City	Project Life Span	Discount Rate	V.GSHP	#	City	H.GSHP	#	City	Traditional
1	Sarnia (South)	60 Years (2 Life Cycles)	8.5%	\$34,359	1	St. Catharines (South)	\$23,778	1	Cambridge (South)	\$47,301
2	Chatham (South)	60 Years (2 Life Cycles)	8.5%	\$34,488	2	Sarnia (South)	\$24,029	2	Guelph (South)	\$48,049
3	Windsor (South)	60 Years (2 Life Cycles)	8.5%	\$34,498	3	Chatham (South)	\$24,174	3	Barrie (Distinct)	\$49,363
4	Niagara Falls (South)	60 Years (2 Life Cycles)	8.5%	\$34,640	4	Windsor (South)	\$24,189	4	Chatham (South)	\$49,720
5	Simcoe (South)	60 Years (2 Life Cycles)	8.5%	\$34,877	5	Niagara Falls (South)	\$24,330	5	Windsor (South)	\$49,771
6	Hamilton (South)	60 Years (2 Life Cycles)	8.5%	\$35,057	6	Simcoe (South)	\$24,567	6	London (South)	\$49,859
7	Cambridge (South)	60 Years (2 Life Cycles)	8.5%	\$35,258	7	Hamilton (South)	\$24,747	7	Sarnia (South)	\$50,241
8	London (South)	60 Years (2 Life Cycles)	8.5%	\$35,260	8	London (South)	\$24,939	8	St. Catharines (South)	\$50,656
9	Guelph (South)	60 Years (2 Life Cycles)	8.5%	\$35,409	9	Cambridge (South)	\$24,947	9	Niagara Falls (South)	\$50,730
10	Sault Ste. Marie (North)	60 Years (2 Life Cycles)	8.5%	\$36,214	10	Toronto (South)	\$24,962	10	Muskoka (Distinct)	\$51,372
11	St. Catharines (South)	60 Years (2 Life Cycles)	8.5%	\$44,146	11	Guelph (South)	\$25,099	11	Toronto (South)	\$51,719
12	Toronto (South)	60 Years (2 Life Cycles)	8.5%	\$45,290	12	Mt. Forest (South)	\$25,367	12	Sault Ste. Marie (North)	\$51,739
13	Trenton (South)	60 Years (2 Life Cycles)	8.5%	\$45,411	13	Sault Ste. Marie (North)	\$25,923	13	Hamilton (South)	\$52,034
14	Kitchener-Waterloo (South)	60 Years (2 Life Cycles)	8.5%	\$45,544	14	Trenton (South)	\$31,621	14	Ottawa (Distinct)	\$52,372
15	Mt. Forest (South)	60 Years (2 Life Cycles)	8.5%	\$45,636	15	Kitchener-Waterloo (South)	\$31,766	15	Simcoe (South)	\$52,451
16	Barrie (Distinct)	60 Years (2 Life Cycles)	8.5%	\$45,681	16	Barrie (Distinct)	\$31,884	16	North Bay (North)	\$52,823
17	Ottawa (Distinct)	60 Years (2 Life Cycles)	8.5%	\$45,717	17	Ottawa (Distinct)	\$31,938	17	Kitchener-Waterloo (South)	\$53,205
18	Kingston (South)	60 Years (2 Life Cycles)	8.5%	\$45,774	18	Kingston (South)	\$31,996	18	Peterborough (Distinct)	\$53,390
19	Warton (South)	60 Years (2 Life Cycles)	8.5%	\$45,877	19	Warton (South)	\$32,085	19	Mt. Forest (South)	\$53,521
20	Peterborough (Distinct)	60 Years (2 Life Cycles)	8.5%	\$46,040	20	Peterborough (Distinct)	\$32,261	20	Warton (South)	\$54,469
21	North Bay (North)	60 Years (2 Life Cycles)	8.5%	\$46,111	21	Muskoka (Distinct)	\$32,319	21	Trenton (South)	\$55,320
22	Muskoka (Distinct)	60 Years (2 Life Cycles)	8.5%	\$46,115	22	North Bay (North)	\$32,350	22	Kingston (South)	\$55,931
23	Sudbury (North)	60 Years (2 Life Cycles)	8.5%	\$46,540	23	Sudbury (North)	\$32,782	23	Thunder Bay (North)	\$56,478
24	Timmins (North)	60 Years (2 Life Cycles)	8.5%	\$47,254	24	Timmins (North)	\$33,498	24	Sudbury (North)	\$56,919
25	Thunder Bay (North)	60 Years (2 Life Cycles)	8.5%	\$47,541	25	Thunder Bay (North)	\$33,770	25	Kenora (North)	\$57,478
26	Kenora (North)	60 Years (2 Life Cycles)	8.5%	\$47,763	26	Kenora (North)	\$33,975	26	Timmins (North)	\$58,196
27	Kapuskasing (North)	60 Years (2 Life Cycles)	8.5%	\$48,249	27	Kapuskasing (North)	\$34,465	27	Kapuskasing (North)	\$63,155

Table F2-1.24: Rankings of cities for feed-in tariff + rebates + carbon tax scenario (improved construction type) at a discount rate of 8.5% (two life cycles of V.GSHP and H.GSHP and five life cycles of Traditional HVAC Applications for a 60 year project lifespan)

5. Two Life Cycles of V.GSHP and H.GSHP and Five Life Cycles of Traditional HVAC Applications @ 10% Discount Rate

Base Case Scenario

Total Present Value										
Base Case Scenario										
#	City	Project Life Span	Discount Rate	V.GSHP	#	City	H.GSHP	#	City	Traditional
1	Sarnia (South)	60 Years (2 Life Cycles)	10%	\$41,048	1	St. Catharines (South)	\$30,907	1	Cambridge (South)	\$33,830
2	Chatham (South)	60 Years (2 Life Cycles)	10%	\$41,204	2	Sarnia (South)	\$31,211	2	Guelph (South)	\$34,261
3	Windsor (South)	60 Years (2 Life Cycles)	10%	\$41,216	3	Chatham (South)	\$31,387	3	Barrie (Distinct)	\$35,534
4	Niagara Falls (South)	60 Years (2 Life Cycles)	10%	\$41,388	4	Windsor (South)	\$31,405	4	London (South)	\$36,044
5	Simcoe (South)	60 Years (2 Life Cycles)	10%	\$41,676	5	Niagara Falls (South)	\$31,576	5	Chatham (South)	\$36,663
6	Hamilton (South)	60 Years (2 Life Cycles)	10%	\$41,894	6	Simcoe (South)	\$31,863	6	Windsor (South)	\$36,691
7	Cambridge (South)	60 Years (2 Life Cycles)	10%	\$42,137	7	Hamilton (South)	\$32,082	7	Muskoka (Distinct)	\$36,752
8	London (South)	60 Years (2 Life Cycles)	10%	\$42,141	8	London (South)	\$32,315	8	Sarnia (South)	\$36,973
9	Guelph (South)	60 Years (2 Life Cycles)	10%	\$42,321	9	Cambridge (South)	\$32,325	9	Sault Ste. Marie (North)	\$36,850
10	Sault Ste. Marie (North)	60 Years (2 Life Cycles)	10%	\$43,297	10	Toronto (South)	\$32,343	10	Niagara Falls (South)	\$37,447
11	St. Catharines (South)	60 Years (2 Life Cycles)	10%	\$50,373	11	Guelph (South)	\$32,509	11	St. Catharines (South)	\$37,585
12	Toronto (South)	60 Years (2 Life Cycles)	10%	\$51,761	12	Mt. Forest (South)	\$32,834	12	Toronto (South)	\$37,652
13	Trenton (South)	60 Years (2 Life Cycles)	10%	\$51,907	13	Sault Ste. Marie (North)	\$33,507	13	Ottawa (Distinct)	\$37,971
14	Kitchener-Waterloo (South)	60 Years (2 Life Cycles)	10%	\$52,068	14	Trenton (South)	\$38,771	14	North Bay (North)	\$37,981
15	Mt. Forest (South)	60 Years (2 Life Cycles)	10%	\$52,180	15	Kitchener-Waterloo (South)	\$38,947	15	Hamilton (South)	\$38,106
16	Barrie (Distinct)	60 Years (2 Life Cycles)	10%	\$52,234	16	Barrie (Distinct)	\$39,090	16	Simcoe (South)	\$38,653
17	Ottawa (Distinct)	60 Years (2 Life Cycles)	10%	\$52,278	17	Ottawa (Distinct)	\$39,156	17	Peterborough (Distinct)	\$38,532
18	Kingston (South)	60 Years (2 Life Cycles)	10%	\$52,347	18	Kingston (South)	\$39,226	18	Mt. Forest (South)	\$38,532
19	Warton (South)	60 Years (2 Life Cycles)	10%	\$52,472	19	Warton (South)	\$39,333	19	Kitchener-Waterloo (South)	\$38,706
20	Peterborough (Distinct)	60 Years (2 Life Cycles)	10%	\$52,669	20	Peterborough (Distinct)	\$39,547	20	Warton (South)	\$39,564
21	North Bay (North)	60 Years (2 Life Cycles)	10%	\$52,756	21	Muskoka (Distinct)	\$39,617	21	Thunder Bay (North)	\$40,090
22	Muskoka (Distinct)	60 Years (2 Life Cycles)	10%	\$52,761	22	North Bay (North)	\$39,655	22	Trenton (South)	\$40,751
23	Sudbury (North)	60 Years (2 Life Cycles)	10%	\$53,275	23	Sudbury (North)	\$40,179	23	Kingston (South)	\$41,068
24	Timmins (North)	60 Years (2 Life Cycles)	10%	\$54,141	24	Timmins (North)	\$41,046	24	Sudbury (North)	\$40,962
25	Thunder Bay (North)	60 Years (2 Life Cycles)	10%	\$54,489	25	Thunder Bay (North)	\$41,376	25	Kenora (North)	\$40,826
26	Kenora (North)	60 Years (2 Life Cycles)	10%	\$54,759	26	Kenora (North)	\$41,625	26	Timmins (North)	\$41,195
27	Kapuskasing (North)	60 Years (2 Life Cycles)	10%	\$55,348	27	Kapuskasing (North)	\$42,219	27	Kapuskasing (North)	\$45,166

Table F2-1.25: Rankings of cities for base case scenario (improved construction type) at a discount rate of 10% (two life cycles of V.GSHP and H.GSHP and five life cycles of Traditional HVAC Applications for a 60 year project lifespan)

Carbon Taxes – (#1)

Total Present Value										
Carbon Taxes - (#1)										
#	City	Project Life Span	Discount Rate	V.GSHP	#	City	H.GSHP	#	City	Traditional
1	Sarnia (South)	60 Years (2 Life Cycles)	10%	\$41,048	1	St. Catharines (South)	\$30,907	1	Cambridge (South)	\$39,811
2	Chatham (South)	60 Years (2 Life Cycles)	10%	\$41,204	2	Sarnia (South)	\$31,211	2	Guelph (South)	\$40,419
3	Windsor (South)	60 Years (2 Life Cycles)	10%	\$41,216	3	Chatham (South)	\$31,387	3	Barrie (Distinct)	\$41,593
4	Niagara Falls (South)	60 Years (2 Life Cycles)	10%	\$41,388	4	Windsor (South)	\$31,405	4	London (South)	\$42,025
5	Simcoe (South)	60 Years (2 Life Cycles)	10%	\$41,676	5	Niagara Falls (South)	\$31,576	5	Chatham (South)	\$42,040
6	Hamilton (South)	60 Years (2 Life Cycles)	10%	\$41,894	6	Simcoe (South)	\$31,863	6	Windsor (South)	\$42,081
7	Cambridge (South)	60 Years (2 Life Cycles)	10%	\$42,137	7	Hamilton (South)	\$32,082	7	Sarnia (South)	\$42,465
8	London (South)	60 Years (2 Life Cycles)	10%	\$42,141	8	London (South)	\$32,315	8	St. Catharines (South)	\$42,849
9	Guelph (South)	60 Years (2 Life Cycles)	10%	\$42,321	9	Cambridge (South)	\$32,325	9	Niagara Falls (South)	\$42,886
10	Sault Ste. Marie (North)	60 Years (2 Life Cycles)	10%	\$43,297	10	Toronto (South)	\$32,343	10	Muskoka (Distinct)	\$43,234
11	St. Catharines (South)	60 Years (2 Life Cycles)	10%	\$50,373	11	Guelph (South)	\$32,509	11	Sault Ste. Marie (North)	\$43,518
12	Toronto (South)	60 Years (2 Life Cycles)	10%	\$51,761	12	Mt. Forest (South)	\$32,834	12	Toronto (South)	\$43,644
13	Trenton (South)	60 Years (2 Life Cycles)	10%	\$51,907	13	Sault Ste. Marie (North)	\$33,507	13	Hamilton (South)	\$43,935
14	Kitchener-Waterloo (South)	60 Years (2 Life Cycles)	10%	\$52,068	14	Trenton (South)	\$38,771	14	Ottawa (Distinct)	\$44,168
15	Mt. Forest (South)	60 Years (2 Life Cycles)	10%	\$52,180	15	Kitchener-Waterloo (South)	\$38,947	15	Simcoe (South)	\$44,353
16	Barrie (Distinct)	60 Years (2 Life Cycles)	10%	\$52,234	16	Barrie (Distinct)	\$39,090	16	North Bay (North)	\$44,504
17	Ottawa (Distinct)	60 Years (2 Life Cycles)	10%	\$52,278	17	Ottawa (Distinct)	\$39,156	17	Kitchener-Waterloo (South)	\$44,878
18	Kingston (South)	60 Years (2 Life Cycles)	10%	\$52,347	18	Kingston (South)	\$39,226	18	Peterborough (Distinct)	\$44,993
19	Warton (South)	60 Years (2 Life Cycles)	10%	\$52,472	19	Warton (South)	\$39,333	19	Mt. Forest (South)	\$45,090
20	Peterborough (Distinct)	60 Years (2 Life Cycles)	10%	\$52,669	20	Peterborough (Distinct)	\$39,547	20	Warton (South)	\$45,962
21	North Bay (North)	60 Years (2 Life Cycles)	10%	\$52,756	21	Muskoka (Distinct)	\$39,617	21	Trenton (South)	\$46,782
22	Muskoka (Distinct)	60 Years (2 Life Cycles)	10%	\$52,761	22	North Bay (North)	\$39,655	22	Kingston (South)	\$47,274
23	Sudbury (North)	60 Years (2 Life Cycles)	10%	\$53,275	23	Sudbury (North)	\$40,179	23	Thunder Bay (North)	\$47,475
24	Timmins (North)	60 Years (2 Life Cycles)	10%	\$54,141	24	Timmins (North)	\$41,046	24	Sudbury (North)	\$47,952
25	Thunder Bay (North)	60 Years (2 Life Cycles)	10%	\$54,489	25	Thunder Bay (North)	\$41,376	25	Kenora (North)	\$48,309
26	Kenora (North)	60 Years (2 Life Cycles)	10%	\$54,759	26	Kenora (North)	\$41,625	26	Timmins (North)	\$48,887
27	Kapuskasing (North)	60 Years (2 Life Cycles)	10%	\$55,348	27	Kapuskasing (North)	\$42,219	27	Kapuskasing (North)	\$53,140

Table F2-1.26: Rankings of cities for carbon taxes scenario (improved construction type) at a discount rate of 10% (two life cycles of V.GSHP and H.GSHP and five life cycles of Traditional HVAC Applications for a 60 year project lifespan)

FIT – (#2)

Total Present Value										
FIT - (#2)										
#	City	Project Life Span	Discount Rate	V.GSHP	#	City	H.GSHP	#	City	Traditional
1	Sarnia (South)	60 Years (2 Life Cycles)	10%	\$36,933	1	St. Catharines (South)	\$26,855	1	Cambridge (South)	\$33,830
2	Chatham (South)	60 Years (2 Life Cycles)	10%	\$37,042	2	Sarnia (South)	\$27,067	2	Guelph (South)	\$34,261
3	Windsor (South)	60 Years (2 Life Cycles)	10%	\$37,050	3	Chatham (South)	\$27,189	3	Barrie (Distinct)	\$35,534
4	Niagara Falls (South)	60 Years (2 Life Cycles)	10%	\$37,170	4	Windsor (South)	\$27,202	4	London (South)	\$36,044
5	Simcoe (South)	60 Years (2 Life Cycles)	10%	\$37,371	5	Niagara Falls (South)	\$27,321	5	Chatham (South)	\$36,663
6	Hamilton (South)	60 Years (2 Life Cycles)	10%	\$37,523	6	Simcoe (South)	\$27,521	6	Windsor (South)	\$36,691
7	Cambridge (South)	60 Years (2 Life Cycles)	10%	\$37,692	7	Hamilton (South)	\$27,673	7	Muskoka (Distinct)	\$36,752
8	London (South)	60 Years (2 Life Cycles)	10%	\$37,694	8	London (South)	\$27,836	8	Sarnia (South)	\$36,973
9	Guelph (South)	60 Years (2 Life Cycles)	10%	\$37,820	9	Cambridge (South)	\$27,842	9	Sault Ste. Marie (North)	\$36,850
10	Sault Ste. Marie (North)	60 Years (2 Life Cycles)	10%	\$38,500	10	Toronto (South)	\$27,855	10	Niagara Falls (South)	\$37,447
11	St. Catharines (South)	60 Years (2 Life Cycles)	10%	\$46,208	11	Guelph (South)	\$27,971	11	St. Catharines (South)	\$37,585
12	Toronto (South)	60 Years (2 Life Cycles)	10%	\$47,175	12	Mt. Forest (South)	\$28,197	12	Toronto (South)	\$37,652
13	Trenton (South)	60 Years (2 Life Cycles)	10%	\$47,277	13	Sault Ste. Marie (North)	\$28,666	13	Ottawa (Distinct)	\$37,971
14	Kitchener-Waterloo (South)	60 Years (2 Life Cycles)	10%	\$47,389	14	Trenton (South)	\$34,108	14	North Bay (North)	\$37,981
15	Mt. Forest (South)	60 Years (2 Life Cycles)	10%	\$47,467	15	Kitchener-Waterloo (South)	\$34,231	15	Hamilton (South)	\$38,106
16	Barrie (Distinct)	60 Years (2 Life Cycles)	10%	\$47,505	16	Barrie (Distinct)	\$34,330	16	Simcoe (South)	\$38,653
17	Ottawa (Distinct)	60 Years (2 Life Cycles)	10%	\$47,536	17	Ottawa (Distinct)	\$34,376	17	Peterborough (Distinct)	\$38,532
18	Kingston (South)	60 Years (2 Life Cycles)	10%	\$47,584	18	Kingston (South)	\$34,425	18	Mt. Forest (South)	\$38,532
19	Warton (South)	60 Years (2 Life Cycles)	10%	\$47,671	19	Warton (South)	\$34,499	19	Kitchener-Waterloo (South)	\$38,706
20	Peterborough (Distinct)	60 Years (2 Life Cycles)	10%	\$47,808	20	Peterborough (Distinct)	\$34,648	20	Warton (South)	\$39,564
21	North Bay (North)	60 Years (2 Life Cycles)	10%	\$47,869	21	Muskoka (Distinct)	\$34,697	21	Thunder Bay (North)	\$40,090
22	Muskoka (Distinct)	60 Years (2 Life Cycles)	10%	\$47,872	22	North Bay (North)	\$34,724	22	Trenton (South)	\$40,751
23	Sudbury (North)	60 Years (2 Life Cycles)	10%	\$48,230	23	Sudbury (North)	\$35,089	23	Kingston (South)	\$41,068
24	Timmins (North)	60 Years (2 Life Cycles)	10%	\$48,833	24	Timmins (North)	\$35,693	24	Sudbury (North)	\$40,962
25	Thunder Bay (North)	60 Years (2 Life Cycles)	10%	\$49,076	25	Thunder Bay (North)	\$35,923	25	Kenora (North)	\$40,826
26	Kenora (North)	60 Years (2 Life Cycles)	10%	\$49,264	26	Kenora (North)	\$36,096	26	Timmins (North)	\$41,195
27	Kapuskasing (North)	60 Years (2 Life Cycles)	10%	\$49,674	27	Kapuskasing (North)	\$36,510	27	Kapuskasing (North)	\$45,166

Table F2-1.27: Rankings of cities for feed-in tariff scenario (improved construction type) at a discount rate of 10% (two life cycles of V.GSHP and H.GSHP and five life cycles of Traditional HVAC Applications for a 60 year project lifespan)

Rebates – (#3)

Total Present Value										
Rebates - (#3)										
#	City	Project Life Span	Discount Rate	V.GSHP	#	City	H.GSHP	#	City	Traditional
1	Sarnia (South)	60 Years (2 Life Cycles)	10%	\$35,529	1	St. Catharines (South)	\$25,388	1	Cambridge (South)	\$33,830
2	Chatham (South)	60 Years (2 Life Cycles)	10%	\$35,685	2	Sarnia (South)	\$25,692	2	Guelph (South)	\$34,261
3	Windsor (South)	60 Years (2 Life Cycles)	10%	\$35,697	3	Chatham (South)	\$25,868	3	Barrie (Distinct)	\$35,534
4	Niagara Falls (South)	60 Years (2 Life Cycles)	10%	\$35,869	4	Windsor (South)	\$25,886	4	London (South)	\$36,044
5	Simcoe (South)	60 Years (2 Life Cycles)	10%	\$36,157	5	Niagara Falls (South)	\$26,057	5	Chatham (South)	\$36,663
6	Hamilton (South)	60 Years (2 Life Cycles)	10%	\$36,375	6	Simcoe (South)	\$26,344	6	Windsor (South)	\$36,691
7	Cambridge (South)	60 Years (2 Life Cycles)	10%	\$36,618	7	Hamilton (South)	\$26,563	7	Muskoka (Distinct)	\$36,752
8	London (South)	60 Years (2 Life Cycles)	10%	\$36,622	8	London (South)	\$26,796	8	Sarnia (South)	\$36,973
9	Guelph (South)	60 Years (2 Life Cycles)	10%	\$36,802	9	Cambridge (South)	\$26,806	9	Sault Ste. Marie (North)	\$36,850
10	Sault Ste. Marie (North)	60 Years (2 Life Cycles)	10%	\$37,778	10	Toronto (South)	\$26,824	10	Niagara Falls (South)	\$37,447
11	St. Catharines (South)	60 Years (2 Life Cycles)	10%	\$44,854	11	Guelph (South)	\$26,990	11	St. Catharines (South)	\$37,585
12	Toronto (South)	60 Years (2 Life Cycles)	10%	\$46,242	12	Mt. Forest (South)	\$27,315	12	Toronto (South)	\$37,652
13	Trenton (South)	60 Years (2 Life Cycles)	10%	\$46,388	13	Sault Ste. Marie (North)	\$27,988	13	Ottawa (Distinct)	\$37,971
14	Kitchener-Waterloo (South)	60 Years (2 Life Cycles)	10%	\$46,549	14	Trenton (South)	\$33,252	14	North Bay (North)	\$37,981
15	Mt. Forest (South)	60 Years (2 Life Cycles)	10%	\$46,661	15	Kitchener-Waterloo (South)	\$33,428	15	Hamilton (South)	\$38,106
16	Barrie (Distinct)	60 Years (2 Life Cycles)	10%	\$46,715	16	Barrie (Distinct)	\$33,571	16	Simcoe (South)	\$38,653
17	Ottawa (Distinct)	60 Years (2 Life Cycles)	10%	\$46,759	17	Ottawa (Distinct)	\$33,637	17	Peterborough (Distinct)	\$38,532
18	Kingston (South)	60 Years (2 Life Cycles)	10%	\$46,828	18	Kingston (South)	\$33,707	18	Mt. Forest (South)	\$38,532
19	Warton (South)	60 Years (2 Life Cycles)	10%	\$46,953	19	Warton (South)	\$33,814	19	Kitchener-Waterloo (South)	\$38,706
20	Peterborough (Distinct)	60 Years (2 Life Cycles)	10%	\$47,150	20	Peterborough (Distinct)	\$34,028	20	Warton (South)	\$39,564
21	North Bay (North)	60 Years (2 Life Cycles)	10%	\$47,237	21	Muskoka (Distinct)	\$34,098	21	Thunder Bay (North)	\$40,090
22	Muskoka (Distinct)	60 Years (2 Life Cycles)	10%	\$47,242	22	North Bay (North)	\$34,136	22	Trenton (South)	\$40,751
23	Sudbury (North)	60 Years (2 Life Cycles)	10%	\$47,756	23	Sudbury (North)	\$34,660	23	Kingston (South)	\$41,068
24	Timmins (North)	60 Years (2 Life Cycles)	10%	\$48,622	24	Timmins (North)	\$35,527	24	Sudbury (North)	\$40,962
25	Thunder Bay (North)	60 Years (2 Life Cycles)	10%	\$48,970	25	Thunder Bay (North)	\$35,857	25	Kenora (North)	\$40,826
26	Kenora (North)	60 Years (2 Life Cycles)	10%	\$49,239	26	Kenora (North)	\$36,106	26	Timmins (North)	\$41,195
27	Kapuskasing (North)	60 Years (2 Life Cycles)	10%	\$49,829	27	Kapuskasing (North)	\$36,700	27	Kapuskasing (North)	\$45,166

Table F2-1.28: Rankings of cities for rebates scenario (improved construction type) at a discount rate of 10% (two life cycles of V.GSHP and H.GSHP and five life cycles of Traditional HVAC Applications for a 60 year project lifespan)

FIT + Rebates – (#4)

Total Present Value										
(FIT+Rebates) - (#4)										
#	City	Project Life Span	Discount Rate	V.GSHP	#	City	H.GSHP	#	City	Traditional
1	Sarnia (South)	60 Years (2 Life Cycles)	10%	\$31,414	1	St. Catharines (South)	\$21,336	1	Cambridge (South)	\$33,830
2	Chatham (South)	60 Years (2 Life Cycles)	10%	\$31,523	2	Sarnia (South)	\$21,548	2	Guelph (South)	\$34,261
3	Windsor (South)	60 Years (2 Life Cycles)	10%	\$31,531	3	Chatham (South)	\$21,670	3	Barrie (Distinct)	\$35,534
4	Niagara Falls (South)	60 Years (2 Life Cycles)	10%	\$31,651	4	Windsor (South)	\$21,683	4	London (South)	\$36,044
5	Simcoe (South)	60 Years (2 Life Cycles)	10%	\$31,851	5	Niagara Falls (South)	\$21,802	5	Chatham (South)	\$36,663
6	Hamilton (South)	60 Years (2 Life Cycles)	10%	\$32,004	6	Simcoe (South)	\$22,002	6	Windsor (South)	\$36,691
7	Cambridge (South)	60 Years (2 Life Cycles)	10%	\$32,173	7	Hamilton (South)	\$22,154	7	Muskoka (Distinct)	\$36,752
8	London (South)	60 Years (2 Life Cycles)	10%	\$32,175	8	London (South)	\$22,317	8	Sarnia (South)	\$36,973
9	Guelph (South)	60 Years (2 Life Cycles)	10%	\$32,301	9	Cambridge (South)	\$22,323	9	Sault Ste. Marie (North)	\$36,850
10	Sault Ste. Marie (North)	60 Years (2 Life Cycles)	10%	\$32,981	10	Toronto (South)	\$22,336	10	Niagara Falls (South)	\$37,447
11	St. Catharines (South)	60 Years (2 Life Cycles)	10%	\$40,689	11	Guelph (South)	\$22,452	11	St. Catharines (South)	\$37,585
12	Toronto (South)	60 Years (2 Life Cycles)	10%	\$41,656	12	Mt. Forest (South)	\$22,678	12	Toronto (South)	\$37,652
13	Trenton (South)	60 Years (2 Life Cycles)	10%	\$41,758	13	Sault Ste. Marie (North)	\$23,147	13	Ottawa (Distinct)	\$37,971
14	Kitchener-Waterloo (South)	60 Years (2 Life Cycles)	10%	\$41,870	14	Trenton (South)	\$28,589	14	North Bay (North)	\$37,981
15	Mt. Forest (South)	60 Years (2 Life Cycles)	10%	\$41,948	15	Kitchener-Waterloo (South)	\$28,712	15	Hamilton (South)	\$38,106
16	Barrie (Distinct)	60 Years (2 Life Cycles)	10%	\$41,986	16	Barrie (Distinct)	\$28,811	16	Simcoe (South)	\$38,653
17	Ottawa (Distinct)	60 Years (2 Life Cycles)	10%	\$42,017	17	Ottawa (Distinct)	\$28,857	17	Peterborough (Distinct)	\$38,532
18	Kingston (South)	60 Years (2 Life Cycles)	10%	\$42,065	18	Kingston (South)	\$28,906	18	Mt. Forest (South)	\$38,532
19	Warton (South)	60 Years (2 Life Cycles)	10%	\$42,152	19	Warton (South)	\$28,980	19	Kitchener-Waterloo (South)	\$38,706
20	Peterborough (Distinct)	60 Years (2 Life Cycles)	10%	\$42,289	20	Peterborough (Distinct)	\$29,129	20	Warton (South)	\$39,564
21	North Bay (North)	60 Years (2 Life Cycles)	10%	\$42,350	21	Muskoka (Distinct)	\$29,178	21	Thunder Bay (North)	\$40,090
22	Muskoka (Distinct)	60 Years (2 Life Cycles)	10%	\$42,353	22	North Bay (North)	\$29,205	22	Trenton (South)	\$40,751
23	Sudbury (North)	60 Years (2 Life Cycles)	10%	\$42,711	23	Sudbury (North)	\$29,570	23	Kingston (South)	\$41,068
24	Timmins (North)	60 Years (2 Life Cycles)	10%	\$43,314	24	Timmins (North)	\$30,174	24	Sudbury (North)	\$40,962
25	Thunder Bay (North)	60 Years (2 Life Cycles)	10%	\$43,557	25	Thunder Bay (North)	\$30,404	25	Kenora (North)	\$40,826
26	Kenora (North)	60 Years (2 Life Cycles)	10%	\$43,745	26	Kenora (North)	\$30,577	26	Timmins (North)	\$41,195
27	Kapuskasing (North)	60 Years (2 Life Cycles)	10%	\$44,155	27	Kapuskasing (North)	\$30,991	27	Kapuskasing (North)	\$45,166

Table F2-1.29: Rankings of cities for feed-in tariff + rebates scenario (improved construction type) at a discount rate of 10% (two life cycles of V.GSHP and H.GSHP and five life cycles of Traditional HVAC Applications for a 60 year project lifespan)

(FIT + Rebates) + Carbon Taxes – (#5)

Total Present Value										
(FIT+Rebates) + Carbon Taxes - (#5)										
#	City	Project Life Span	Discount Rate	V.GSHP	#	City	H.GSHP	#	City	Traditional
1	Sarnia (South)	60 Years (2 Life Cycles)	10%	\$31,414	1	St. Catharines (South)	\$21,336	1	Cambridge (South)	\$39,811
2	Chatham (South)	60 Years (2 Life Cycles)	10%	\$31,523	2	Sarnia (South)	\$21,548	2	Guelph (South)	\$40,419
3	Windsor (South)	60 Years (2 Life Cycles)	10%	\$31,531	3	Chatham (South)	\$21,670	3	Barrie (Distinct)	\$41,593
4	Niagara Falls (South)	60 Years (2 Life Cycles)	10%	\$31,651	4	Windsor (South)	\$21,683	4	London (South)	\$42,025
5	Simcoe (South)	60 Years (2 Life Cycles)	10%	\$31,851	5	Niagara Falls (South)	\$21,802	5	Chatham (South)	\$42,040
6	Hamilton (South)	60 Years (2 Life Cycles)	10%	\$32,004	6	Simcoe (South)	\$22,002	6	Windsor (South)	\$42,081
7	Cambridge (South)	60 Years (2 Life Cycles)	10%	\$32,173	7	Hamilton (South)	\$22,154	7	Sarnia (South)	\$42,465
8	London (South)	60 Years (2 Life Cycles)	10%	\$32,175	8	London (South)	\$22,317	8	St. Catharines (South)	\$42,849
9	Guelph (South)	60 Years (2 Life Cycles)	10%	\$32,301	9	Cambridge (South)	\$22,323	9	Niagara Falls (South)	\$42,886
10	Sault Ste. Marie (North)	60 Years (2 Life Cycles)	10%	\$32,981	10	Toronto (South)	\$22,336	10	Muskoka (Distinct)	\$43,234
11	St. Catharines (South)	60 Years (2 Life Cycles)	10%	\$40,689	11	Guelph (South)	\$22,452	11	Sault Ste. Marie (North)	\$43,518
12	Toronto (South)	60 Years (2 Life Cycles)	10%	\$41,656	12	Mt. Forest (South)	\$22,678	12	Toronto (South)	\$43,644
13	Trenton (South)	60 Years (2 Life Cycles)	10%	\$41,758	13	Sault Ste. Marie (North)	\$23,147	13	Hamilton (South)	\$43,935
14	Kitchener-Waterloo (South)	60 Years (2 Life Cycles)	10%	\$41,870	14	Trenton (South)	\$28,589	14	Ottawa (Distinct)	\$44,168
15	Mt. Forest (South)	60 Years (2 Life Cycles)	10%	\$41,948	15	Kitchener-Waterloo (South)	\$28,712	15	Simcoe (South)	\$44,353
16	Barrie (Distinct)	60 Years (2 Life Cycles)	10%	\$41,986	16	Barrie (Distinct)	\$28,811	16	North Bay (North)	\$44,504
17	Ottawa (Distinct)	60 Years (2 Life Cycles)	10%	\$42,017	17	Ottawa (Distinct)	\$28,857	17	Kitchener-Waterloo (South)	\$44,878
18	Kingston (South)	60 Years (2 Life Cycles)	10%	\$42,065	18	Kingston (South)	\$28,906	18	Peterborough (Distinct)	\$44,993
19	Warton (South)	60 Years (2 Life Cycles)	10%	\$42,152	19	Warton (South)	\$28,980	19	Mt. Forest (South)	\$45,090
20	Peterborough (Distinct)	60 Years (2 Life Cycles)	10%	\$42,289	20	Peterborough (Distinct)	\$29,129	20	Warton (South)	\$45,962
21	North Bay (North)	60 Years (2 Life Cycles)	10%	\$42,350	21	Muskoka (Distinct)	\$29,178	21	Trenton (South)	\$46,782
22	Muskoka (Distinct)	60 Years (2 Life Cycles)	10%	\$42,353	22	North Bay (North)	\$29,205	22	Kingston (South)	\$47,274
23	Sudbury (North)	60 Years (2 Life Cycles)	10%	\$42,711	23	Sudbury (North)	\$29,570	23	Thunder Bay (North)	\$47,475
24	Timmins (North)	60 Years (2 Life Cycles)	10%	\$43,314	24	Timmins (North)	\$30,174	24	Sudbury (North)	\$47,952
25	Thunder Bay (North)	60 Years (2 Life Cycles)	10%	\$43,557	25	Thunder Bay (North)	\$30,404	25	Kenora (North)	\$48,309
26	Kenora (North)	60 Years (2 Life Cycles)	10%	\$43,745	26	Kenora (North)	\$30,577	26	Timmins (North)	\$48,887
27	Kapuskasing (North)	60 Years (2 Life Cycles)	10%	\$44,155	27	Kapuskasing (North)	\$30,991	27	Kapuskasing (North)	\$53,140

Table F2-1.30: Rankings of cities for feed-in tariff + rebates + carbon tax scenario (improved construction type) at a discount rate of 10% (two life cycles of V.GSHP and H.GSHP and five life cycles of Traditional HVAC Applications for a 60 year project lifespan)

6. Two Life Cycles of V.GSHP and H.GSHP and Five Life Cycles of Traditional HVAC Applications @ 12% Discount Rate

Base Case Scenario

Total Present Value										
Base Case Scenario										
#	City	Project Life Span	Discount Rate	V.GSHP	#	City	H.GSHP	#	City	Traditional
1	Sarnia (South)	60 Years (2 Life Cycles)	12%	\$37,502	1	St. Catharines (South)	\$27,786	1	Cambridge (South)	\$28,760
2	Chatham (South)	60 Years (2 Life Cycles)	12%	\$37,631	2	Sarnia (South)	\$28,038	2	Guelph (South)	\$29,115
3	Windsor (South)	60 Years (2 Life Cycles)	12%	\$37,641	3	Chatham (South)	\$28,184	3	Barrie (Distinct)	\$30,231
4	Niagara Falls (South)	60 Years (2 Life Cycles)	12%	\$37,784	4	Windsor (South)	\$28,199	4	London (South)	\$30,655
5	Simcoe (South)	60 Years (2 Life Cycles)	12%	\$38,022	5	Niagara Falls (South)	\$28,341	5	Chatham (South)	\$31,235
6	Hamilton (South)	60 Years (2 Life Cycles)	12%	\$38,203	6	Simcoe (South)	\$28,579	6	Windsor (South)	\$31,257
7	Cambridge (South)	60 Years (2 Life Cycles)	12%	\$38,405	7	Hamilton (South)	\$28,760	7	Muskoka (Distinct)	\$31,236
8	London (South)	60 Years (2 Life Cycles)	12%	\$38,407	8	London (South)	\$28,953	8	Sarnia (South)	\$31,490
9	Guelph (South)	60 Years (2 Life Cycles)	12%	\$38,557	9	Cambridge (South)	\$28,961	9	Sault Ste. Marie (North)	\$31,315
10	Sault Ste. Marie (North)	60 Years (2 Life Cycles)	12%	\$39,366	10	Toronto (South)	\$28,976	10	Niagara Falls (South)	\$31,884
11	St. Catharines (South)	60 Years (2 Life Cycles)	12%	\$46,391	11	Guelph (South)	\$29,114	11	St. Catharines (South)	\$32,000
12	Toronto (South)	60 Years (2 Life Cycles)	12%	\$47,541	12	Mt. Forest (South)	\$29,383	12	Toronto (South)	\$32,047
13	Trenton (South)	60 Years (2 Life Cycles)	12%	\$47,662	13	Sault Ste. Marie (North)	\$29,941	13	Ottawa (Distinct)	\$32,309
14	Kitchener-Waterloo (South)	60 Years (2 Life Cycles)	12%	\$47,796	14	Trenton (South)	\$35,028	14	North Bay (North)	\$32,314
15	Mt. Forest (South)	60 Years (2 Life Cycles)	12%	\$47,888	15	Kitchener-Waterloo (South)	\$35,174	15	Hamilton (South)	\$32,426
16	Barrie (Distinct)	60 Years (2 Life Cycles)	12%	\$47,933	16	Barrie (Distinct)	\$35,292	16	Simcoe (South)	\$32,940
17	Ottawa (Distinct)	60 Years (2 Life Cycles)	12%	\$47,970	17	Ottawa (Distinct)	\$35,347	17	Peterborough (Distinct)	\$32,772
18	Kingston (South)	60 Years (2 Life Cycles)	12%	\$48,027	18	Kingston (South)	\$35,405	18	Mt. Forest (South)	\$32,771
19	Warton (South)	60 Years (2 Life Cycles)	12%	\$48,131	19	Warton (South)	\$35,494	19	Kitchener-Waterloo (South)	\$32,919
20	Peterborough (Distinct)	60 Years (2 Life Cycles)	12%	\$48,294	20	Peterborough (Distinct)	\$35,671	20	Warton (South)	\$33,687
21	North Bay (North)	60 Years (2 Life Cycles)	12%	\$48,366	21	Muskoka (Distinct)	\$35,729	21	Thunder Bay (North)	\$34,052
22	Muskoka (Distinct)	60 Years (2 Life Cycles)	12%	\$48,370	22	North Bay (North)	\$35,760	22	Trenton (South)	\$34,735
23	Sudbury (North)	60 Years (2 Life Cycles)	12%	\$48,796	23	Sudbury (North)	\$36,195	23	Kingston (South)	\$34,995
24	Timmins (North)	60 Years (2 Life Cycles)	12%	\$49,514	24	Timmins (North)	\$36,913	24	Sudbury (North)	\$34,839
25	Thunder Bay (North)	60 Years (2 Life Cycles)	12%	\$49,802	25	Thunder Bay (North)	\$37,187	25	Kenora (North)	\$34,661
26	Kenora (North)	60 Years (2 Life Cycles)	12%	\$50,026	26	Kenora (North)	\$37,393	26	Timmins (North)	\$34,965
27	Kapuskasing (North)	60 Years (2 Life Cycles)	12%	\$50,514	27	Kapuskasing (North)	\$37,885	27	Kapuskasing (North)	\$38,372

Table F2-1.31: Rankings of cities for base case scenario (improved construction type) at a discount rate of 12% (two life cycles of V.GSHP and H.GSHP and five life cycles of Traditional HVAC Applications for a 60 year project lifespan)

Carbon Taxes – (#1)

Total Present Value										
Carbon Taxes - (#1)										
#	City	Project Life Span	Discount Rate	V.GSHP	#	City	H.GSHP	#	City	Traditional
1	Sarnia (South)	60 Years (2 Life Cycles)	12%	\$37,502	1	St. Catharines (South)	\$27,786	1	Cambridge (South)	\$33,045
2	Chatham (South)	60 Years (2 Life Cycles)	12%	\$37,631	2	Sarnia (South)	\$28,038	2	Guelph (South)	\$33,527
3	Windsor (South)	60 Years (2 Life Cycles)	12%	\$37,641	3	Chatham (South)	\$28,184	3	Barrie (Distinct)	\$34,572
4	Niagara Falls (South)	60 Years (2 Life Cycles)	12%	\$37,784	4	Windsor (South)	\$28,199	4	London (South)	\$34,939
5	Simcoe (South)	60 Years (2 Life Cycles)	12%	\$38,022	5	Niagara Falls (South)	\$28,341	5	Chatham (South)	\$35,086
6	Hamilton (South)	60 Years (2 Life Cycles)	12%	\$38,203	6	Simcoe (South)	\$28,579	6	Windsor (South)	\$35,119
7	Cambridge (South)	60 Years (2 Life Cycles)	12%	\$38,405	7	Hamilton (South)	\$28,760	7	Sarnia (South)	\$35,425
8	London (South)	60 Years (2 Life Cycles)	12%	\$38,407	8	London (South)	\$28,953	8	St. Catharines (South)	\$35,771
9	Guelph (South)	60 Years (2 Life Cycles)	12%	\$38,557	9	Cambridge (South)	\$28,961	9	Niagara Falls (South)	\$35,780
10	Sault Ste. Marie (North)	60 Years (2 Life Cycles)	12%	\$39,366	10	Toronto (South)	\$28,976	10	Muskoka (Distinct)	\$35,879
11	St. Catharines (South)	60 Years (2 Life Cycles)	12%	\$46,391	11	Guelph (South)	\$29,114	11	Sault Ste. Marie (North)	\$36,092
12	Toronto (South)	60 Years (2 Life Cycles)	12%	\$47,541	12	Mt. Forest (South)	\$29,383	12	Toronto (South)	\$36,340
13	Trenton (South)	60 Years (2 Life Cycles)	12%	\$47,662	13	Sault Ste. Marie (North)	\$29,941	13	Hamilton (South)	\$36,601
14	Kitchener-Waterloo (South)	60 Years (2 Life Cycles)	12%	\$47,796	14	Trenton (South)	\$35,028	14	Ottawa (Distinct)	\$36,749
15	Mt. Forest (South)	60 Years (2 Life Cycles)	12%	\$47,888	15	Kitchener-Waterloo (South)	\$35,174	15	North Bay (North)	\$36,987
16	Barrie (Distinct)	60 Years (2 Life Cycles)	12%	\$47,933	16	Barrie (Distinct)	\$35,292	16	Simcoe (South)	\$37,024
17	Ottawa (Distinct)	60 Years (2 Life Cycles)	12%	\$47,970	17	Ottawa (Distinct)	\$35,347	17	Kitchener-Waterloo (South)	\$37,340
18	Kingston (South)	60 Years (2 Life Cycles)	12%	\$48,027	18	Kingston (South)	\$35,405	18	Peterborough (Distinct)	\$37,400
19	Warton (South)	60 Years (2 Life Cycles)	12%	\$48,131	19	Warton (South)	\$35,494	19	Mt. Forest (South)	\$37,469
20	Peterborough (Distinct)	60 Years (2 Life Cycles)	12%	\$48,294	20	Peterborough (Distinct)	\$35,671	20	Warton (South)	\$38,271
21	North Bay (North)	60 Years (2 Life Cycles)	12%	\$48,366	21	Muskoka (Distinct)	\$35,729	21	Trenton (South)	\$39,056
22	Muskoka (Distinct)	60 Years (2 Life Cycles)	12%	\$48,370	22	North Bay (North)	\$35,760	22	Thunder Bay (North)	\$39,343
23	Sudbury (North)	60 Years (2 Life Cycles)	12%	\$48,796	23	Sudbury (North)	\$36,195	23	Kingston (South)	\$39,442
24	Timmins (North)	60 Years (2 Life Cycles)	12%	\$49,514	24	Timmins (North)	\$36,913	24	Sudbury (North)	\$39,847
25	Thunder Bay (North)	60 Years (2 Life Cycles)	12%	\$49,802	25	Thunder Bay (North)	\$37,187	25	Kenora (North)	\$40,022
26	Kenora (North)	60 Years (2 Life Cycles)	12%	\$50,026	26	Kenora (North)	\$37,393	26	Timmins (North)	\$40,475
27	Kapuskasing (North)	60 Years (2 Life Cycles)	12%	\$50,514	27	Kapuskasing (North)	\$37,885	27	Kapuskasing (North)	\$44,085

Table F2-1.32: Rankings of cities for carbon taxes scenario (improved construction type) at a discount rate of 12% (two life cycles of V.GSHP and H.GSHP and five life cycles of Traditional HVAC Applications for a 60 year project lifespan)

FIT – (#2)

Total Present Value										
FIT - (#2)										
#	City	Project Life Span	Discount Rate	V.GSHP	#	City	H.GSHP	#	City	Traditional
1	Sarnia (South)	60 Years (2 Life Cycles)	12%	\$34,066	1	St. Catharines (South)	\$24,402	1	Cambridge (South)	\$28,760
2	Chatham (South)	60 Years (2 Life Cycles)	12%	\$34,155	2	Sarnia (South)	\$24,577	2	Guelph (South)	\$29,115
3	Windsor (South)	60 Years (2 Life Cycles)	12%	\$34,162	3	Chatham (South)	\$24,678	3	Barrie (Distinct)	\$30,231
4	Niagara Falls (South)	60 Years (2 Life Cycles)	12%	\$34,261	4	Windsor (South)	\$24,689	4	London (South)	\$30,655
5	Simcoe (South)	60 Years (2 Life Cycles)	12%	\$34,427	5	Niagara Falls (South)	\$24,787	5	Chatham (South)	\$31,235
6	Hamilton (South)	60 Years (2 Life Cycles)	12%	\$34,552	6	Simcoe (South)	\$24,952	6	Windsor (South)	\$31,257
7	Cambridge (South)	60 Years (2 Life Cycles)	12%	\$34,692	7	Hamilton (South)	\$25,078	7	Muskoka (Distinct)	\$31,236
8	London (South)	60 Years (2 Life Cycles)	12%	\$34,694	8	London (South)	\$25,212	8	Sarnia (South)	\$31,490
9	Guelph (South)	60 Years (2 Life Cycles)	12%	\$34,798	9	Cambridge (South)	\$25,218	9	Sault Ste. Marie (North)	\$31,315
10	Sault Ste. Marie (North)	60 Years (2 Life Cycles)	12%	\$35,359	10	Toronto (South)	\$25,228	10	Niagara Falls (South)	\$31,884
11	St. Catharines (South)	60 Years (2 Life Cycles)	12%	\$42,913	11	Guelph (South)	\$25,324	11	St. Catharines (South)	\$32,000
12	Toronto (South)	60 Years (2 Life Cycles)	12%	\$43,712	12	Mt. Forest (South)	\$25,511	12	Toronto (South)	\$32,047
13	Trenton (South)	60 Years (2 Life Cycles)	12%	\$43,796	13	Sault Ste. Marie (North)	\$25,898	13	Ottawa (Distinct)	\$32,309
14	Kitchener-Waterloo (South)	60 Years (2 Life Cycles)	12%	\$43,888	14	Trenton (South)	\$31,134	14	North Bay (North)	\$32,314
15	Mt. Forest (South)	60 Years (2 Life Cycles)	12%	\$43,953	15	Kitchener-Waterloo (South)	\$31,235	15	Hamilton (South)	\$32,426
16	Barrie (Distinct)	60 Years (2 Life Cycles)	12%	\$43,984	16	Barrie (Distinct)	\$31,317	16	Simcoe (South)	\$32,940
17	Ottawa (Distinct)	60 Years (2 Life Cycles)	12%	\$44,009	17	Ottawa (Distinct)	\$31,355	17	Peterborough (Distinct)	\$32,772
18	Kingston (South)	60 Years (2 Life Cycles)	12%	\$44,049	18	Kingston (South)	\$31,395	18	Mt. Forest (South)	\$32,771
19	Warton (South)	60 Years (2 Life Cycles)	12%	\$44,121	19	Warton (South)	\$31,457	19	Kitchener-Waterloo (South)	\$32,919
20	Peterborough (Distinct)	60 Years (2 Life Cycles)	12%	\$44,234	20	Peterborough (Distinct)	\$31,580	20	Warton (South)	\$33,687
21	North Bay (North)	60 Years (2 Life Cycles)	12%	\$44,284	21	Muskoka (Distinct)	\$31,620	21	Thunder Bay (North)	\$34,052
22	Muskoka (Distinct)	60 Years (2 Life Cycles)	12%	\$44,287	22	North Bay (North)	\$31,642	22	Trenton (South)	\$34,735
23	Sudbury (North)	60 Years (2 Life Cycles)	12%	\$44,583	23	Sudbury (North)	\$31,944	23	Kingston (South)	\$34,995
24	Timmins (North)	60 Years (2 Life Cycles)	12%	\$45,081	24	Timmins (North)	\$32,443	24	Sudbury (North)	\$34,839
25	Thunder Bay (North)	60 Years (2 Life Cycles)	12%	\$45,281	25	Thunder Bay (North)	\$32,633	25	Kenora (North)	\$34,661
26	Kenora (North)	60 Years (2 Life Cycles)	12%	\$45,436	26	Kenora (North)	\$32,775	26	Timmins (North)	\$34,965
27	Kapuskasing (North)	60 Years (2 Life Cycles)	12%	\$45,776	27	Kapuskasing (North)	\$33,117	27	Kapuskasing (North)	\$38,372

Table F2-1.33: Rankings of cities for feed-in tariff scenario (improved construction type) at a discount rate of 12% (two life cycles of V.GSHP and H.GSHP and five life cycles of Traditional HVAC Applications for a 60 year project lifespan)

Rebates – (#3)

Total Present Value										
Rebates - (#3)										
#	City	Project Life Span	Discount Rate	V.GSHP	#	City	H.GSHP	#	City	Traditional
1	Sarnia (South)	60 Years (2 Life Cycles)	12%	\$32,200	1	St. Catharines (South)	\$22,484	1	Cambridge (South)	\$28,760
2	Chatham (South)	60 Years (2 Life Cycles)	12%	\$32,329	2	Sarnia (South)	\$22,736	2	Guelph (South)	\$29,115
3	Windsor (South)	60 Years (2 Life Cycles)	12%	\$32,339	3	Chatham (South)	\$22,882	3	Barrie (Distinct)	\$30,231
4	Niagara Falls (South)	60 Years (2 Life Cycles)	12%	\$32,482	4	Windsor (South)	\$22,897	4	London (South)	\$30,655
5	Simcoe (South)	60 Years (2 Life Cycles)	12%	\$32,720	5	Niagara Falls (South)	\$23,038	5	Chatham (South)	\$31,235
6	Hamilton (South)	60 Years (2 Life Cycles)	12%	\$32,901	6	Simcoe (South)	\$23,276	6	Windsor (South)	\$31,257
7	Cambridge (South)	60 Years (2 Life Cycles)	12%	\$33,102	7	Hamilton (South)	\$23,458	7	Muskoka (Distinct)	\$31,236
8	London (South)	60 Years (2 Life Cycles)	12%	\$33,105	8	London (South)	\$23,651	8	Sarnia (South)	\$31,490
9	Guelph (South)	60 Years (2 Life Cycles)	12%	\$33,255	9	Cambridge (South)	\$23,659	9	Sault Ste. Marie (North)	\$31,315
10	Sault Ste. Marie (North)	60 Years (2 Life Cycles)	12%	\$34,063	10	Toronto (South)	\$23,674	10	Niagara Falls (South)	\$31,884
11	St. Catharines (South)	60 Years (2 Life Cycles)	12%	\$41,089	11	Guelph (South)	\$23,811	11	St. Catharines (South)	\$32,000
12	Toronto (South)	60 Years (2 Life Cycles)	12%	\$42,239	12	Mt. Forest (South)	\$24,081	12	Toronto (South)	\$32,047
13	Trenton (South)	60 Years (2 Life Cycles)	12%	\$42,360	13	Sault Ste. Marie (North)	\$24,639	13	Ottawa (Distinct)	\$32,309
14	Kitchener-Waterloo (South)	60 Years (2 Life Cycles)	12%	\$42,493	14	Trenton (South)	\$29,726	14	North Bay (North)	\$32,314
15	Mt. Forest (South)	60 Years (2 Life Cycles)	12%	\$42,586	15	Kitchener-Waterloo (South)	\$29,871	15	Hamilton (South)	\$32,426
16	Barrie (Distinct)	60 Years (2 Life Cycles)	12%	\$42,631	16	Barrie (Distinct)	\$29,990	16	Simcoe (South)	\$32,940
17	Ottawa (Distinct)	60 Years (2 Life Cycles)	12%	\$42,668	17	Ottawa (Distinct)	\$30,044	17	Peterborough (Distinct)	\$32,772
18	Kingston (South)	60 Years (2 Life Cycles)	12%	\$42,725	18	Kingston (South)	\$30,103	18	Mt. Forest (South)	\$32,771
19	Warton (South)	60 Years (2 Life Cycles)	12%	\$42,828	19	Warton (South)	\$30,191	19	Kitchener-Waterloo (South)	\$32,919
20	Peterborough (Distinct)	60 Years (2 Life Cycles)	12%	\$42,992	20	Peterborough (Distinct)	\$30,368	20	Warton (South)	\$33,687
21	North Bay (North)	60 Years (2 Life Cycles)	12%	\$43,064	21	Muskoka (Distinct)	\$30,427	21	Thunder Bay (North)	\$34,052
22	Muskoka (Distinct)	60 Years (2 Life Cycles)	12%	\$43,068	22	North Bay (North)	\$30,458	22	Trenton (South)	\$34,735
23	Sudbury (North)	60 Years (2 Life Cycles)	12%	\$43,494	23	Sudbury (North)	\$30,892	23	Kingston (South)	\$34,995
24	Timmins (North)	60 Years (2 Life Cycles)	12%	\$44,211	24	Timmins (North)	\$31,611	24	Sudbury (North)	\$34,839
25	Thunder Bay (North)	60 Years (2 Life Cycles)	12%	\$44,500	25	Thunder Bay (North)	\$31,885	25	Kenora (North)	\$34,661
26	Kenora (North)	60 Years (2 Life Cycles)	12%	\$44,723	26	Kenora (North)	\$32,090	26	Timmins (North)	\$34,965
27	Kapuskasing (North)	60 Years (2 Life Cycles)	12%	\$45,212	27	Kapuskasing (North)	\$32,583	27	Kapuskasing (North)	\$38,372

Table F2-1.34: Rankings of cities for rebates scenario (improved construction type) at a discount rate of 12% (two life cycles of V.GSHP and H.GSHP and five life cycles of Traditional HVAC Applications for a 60 year project lifespan)

FIT + Rebates – (#4)

Total Present Value										
(FIT+Rebates) - (#4)										
#	City	Project Life Span	Discount Rate	V.GSHP	#	City	H.GSHP	#	City	Traditional
1	Sarnia (South)	60 Years (2 Life Cycles)	12%	\$28,763	1	St. Catharines (South)	\$19,100	1	Cambridge (South)	\$28,760
2	Chatham (South)	60 Years (2 Life Cycles)	12%	\$28,853	2	Sarnia (South)	\$19,275	2	Guelph (South)	\$29,115
3	Windsor (South)	60 Years (2 Life Cycles)	12%	\$28,860	3	Chatham (South)	\$19,376	3	Barrie (Distinct)	\$30,231
4	Niagara Falls (South)	60 Years (2 Life Cycles)	12%	\$28,959	4	Windsor (South)	\$19,386	4	London (South)	\$30,655
5	Simcoe (South)	60 Years (2 Life Cycles)	12%	\$29,124	5	Niagara Falls (South)	\$19,485	5	Chatham (South)	\$31,235
6	Hamilton (South)	60 Years (2 Life Cycles)	12%	\$29,250	6	Simcoe (South)	\$19,650	6	Windsor (South)	\$31,257
7	Cambridge (South)	60 Years (2 Life Cycles)	12%	\$29,390	7	Hamilton (South)	\$19,776	7	Muskoka (Distinct)	\$31,236
8	London (South)	60 Years (2 Life Cycles)	12%	\$29,392	8	London (South)	\$19,910	8	Sarnia (South)	\$31,490
9	Guelph (South)	60 Years (2 Life Cycles)	12%	\$29,496	9	Cambridge (South)	\$19,916	9	Sault Ste. Marie (North)	\$31,315
10	Sault Ste. Marie (North)	60 Years (2 Life Cycles)	12%	\$30,057	10	Toronto (South)	\$19,926	10	Niagara Falls (South)	\$31,884
11	St. Catharines (South)	60 Years (2 Life Cycles)	12%	\$37,611	11	Guelph (South)	\$20,021	11	St. Catharines (South)	\$32,000
12	Toronto (South)	60 Years (2 Life Cycles)	12%	\$38,409	12	Mt. Forest (South)	\$20,209	12	Toronto (South)	\$32,047
13	Trenton (South)	60 Years (2 Life Cycles)	12%	\$38,494	13	Sault Ste. Marie (North)	\$20,596	13	Ottawa (Distinct)	\$32,309
14	Kitchener-Waterloo (South)	60 Years (2 Life Cycles)	12%	\$38,586	14	Trenton (South)	\$25,831	14	North Bay (North)	\$32,314
15	Mt. Forest (South)	60 Years (2 Life Cycles)	12%	\$38,650	15	Kitchener-Waterloo (South)	\$25,932	15	Hamilton (South)	\$32,426
16	Barrie (Distinct)	60 Years (2 Life Cycles)	12%	\$38,682	16	Barrie (Distinct)	\$26,015	16	Simcoe (South)	\$32,940
17	Ottawa (Distinct)	60 Years (2 Life Cycles)	12%	\$38,707	17	Ottawa (Distinct)	\$26,052	17	Peterborough (Distinct)	\$32,772
18	Kingston (South)	60 Years (2 Life Cycles)	12%	\$38,747	18	Kingston (South)	\$26,093	18	Mt. Forest (South)	\$32,771
19	Warton (South)	60 Years (2 Life Cycles)	12%	\$38,819	19	Warton (South)	\$26,155	19	Kitchener-Waterloo (South)	\$32,919
20	Peterborough (Distinct)	60 Years (2 Life Cycles)	12%	\$38,932	20	Peterborough (Distinct)	\$26,277	20	Warton (South)	\$33,687
21	North Bay (North)	60 Years (2 Life Cycles)	12%	\$38,982	21	Muskoka (Distinct)	\$26,318	21	Thunder Bay (North)	\$34,052
22	Muskoka (Distinct)	60 Years (2 Life Cycles)	12%	\$38,985	22	North Bay (North)	\$26,340	22	Trenton (South)	\$34,735
23	Sudbury (North)	60 Years (2 Life Cycles)	12%	\$39,281	23	Sudbury (North)	\$26,641	23	Kingston (South)	\$34,995
24	Timmins (North)	60 Years (2 Life Cycles)	12%	\$39,779	24	Timmins (North)	\$27,140	24	Sudbury (North)	\$34,839
25	Thunder Bay (North)	60 Years (2 Life Cycles)	12%	\$39,979	25	Thunder Bay (North)	\$27,330	25	Kenora (North)	\$34,661
26	Kenora (North)	60 Years (2 Life Cycles)	12%	\$40,134	26	Kenora (North)	\$27,473	26	Timmins (North)	\$34,965
27	Kapuskasing (North)	60 Years (2 Life Cycles)	12%	\$40,473	27	Kapuskasing (North)	\$27,815	27	Kapuskasing (North)	\$38,372

Table F2-1.35: Rankings of cities for feed-in tariff + rebates scenario (improved construction type) at a discount rate of 12% (two life cycles of V.GSHP and H.GSHP and five life cycles of Traditional HVAC Applications for a 60 year project lifespan)

(FIT + Rebates) + Carbon Taxes – (#5)

Total Present Value										
(FIT+Rebates) + Carbon Taxes - (#5)										
#	City	Project Life Span	Discount Rate	V.GSHP	#	City	H.GSHP	#	City	Traditional
1	Sarnia (South)	60 Years (2 Life Cycles)	12%	\$28,763	1	St. Catharines (South)	\$19,100	1	Cambridge (South)	\$33,045
2	Chatham (South)	60 Years (2 Life Cycles)	12%	\$28,853	2	Sarnia (South)	\$19,275	2	Guelph (South)	\$33,527
3	Windsor (South)	60 Years (2 Life Cycles)	12%	\$28,860	3	Chatham (South)	\$19,376	3	Barrie (Distinct)	\$34,572
4	Niagara Falls (South)	60 Years (2 Life Cycles)	12%	\$28,959	4	Windsor (South)	\$19,386	4	London (South)	\$34,939
5	Simcoe (South)	60 Years (2 Life Cycles)	12%	\$29,124	5	Niagara Falls (South)	\$19,485	5	Chatham (South)	\$35,086
6	Hamilton (South)	60 Years (2 Life Cycles)	12%	\$29,250	6	Simcoe (South)	\$19,650	6	Windsor (South)	\$35,119
7	Cambridge (South)	60 Years (2 Life Cycles)	12%	\$29,390	7	Hamilton (South)	\$19,776	7	Sarnia (South)	\$35,425
8	London (South)	60 Years (2 Life Cycles)	12%	\$29,392	8	London (South)	\$19,910	8	St. Catharines (South)	\$35,771
9	Guelph (South)	60 Years (2 Life Cycles)	12%	\$29,496	9	Cambridge (South)	\$19,916	9	Niagara Falls (South)	\$35,780
10	Sault Ste. Marie (North)	60 Years (2 Life Cycles)	12%	\$30,057	10	Toronto (South)	\$19,926	10	Muskoka (Distinct)	\$35,879
11	St. Catharines (South)	60 Years (2 Life Cycles)	12%	\$37,611	11	Guelph (South)	\$20,021	11	Sault Ste. Marie (North)	\$36,092
12	Toronto (South)	60 Years (2 Life Cycles)	12%	\$38,409	12	Mt. Forest (South)	\$20,209	12	Toronto (South)	\$36,340
13	Trenton (South)	60 Years (2 Life Cycles)	12%	\$38,494	13	Sault Ste. Marie (North)	\$20,596	13	Hamilton (South)	\$36,601
14	Kitchener-Waterloo (South)	60 Years (2 Life Cycles)	12%	\$38,586	14	Trenton (South)	\$25,831	14	Ottawa (Distinct)	\$36,749
15	Mt. Forest (South)	60 Years (2 Life Cycles)	12%	\$38,650	15	Kitchener-Waterloo (South)	\$25,932	15	North Bay (North)	\$36,987
16	Barrie (Distinct)	60 Years (2 Life Cycles)	12%	\$38,682	16	Barrie (Distinct)	\$26,015	16	Simcoe (South)	\$37,024
17	Ottawa (Distinct)	60 Years (2 Life Cycles)	12%	\$38,707	17	Ottawa (Distinct)	\$26,052	17	Kitchener-Waterloo (South)	\$37,340
18	Kingston (South)	60 Years (2 Life Cycles)	12%	\$38,747	18	Kingston (South)	\$26,093	18	Peterborough (Distinct)	\$37,400
19	Warton (South)	60 Years (2 Life Cycles)	12%	\$38,819	19	Warton (South)	\$26,155	19	Mt. Forest (South)	\$37,469
20	Peterborough (Distinct)	60 Years (2 Life Cycles)	12%	\$38,932	20	Peterborough (Distinct)	\$26,277	20	Warton (South)	\$38,271
21	North Bay (North)	60 Years (2 Life Cycles)	12%	\$38,982	21	Muskoka (Distinct)	\$26,318	21	Trenton (South)	\$39,056
22	Muskoka (Distinct)	60 Years (2 Life Cycles)	12%	\$38,985	22	North Bay (North)	\$26,340	22	Thunder Bay (North)	\$39,343
23	Sudbury (North)	60 Years (2 Life Cycles)	12%	\$39,281	23	Sudbury (North)	\$26,641	23	Kingston (South)	\$39,442
24	Timmins (North)	60 Years (2 Life Cycles)	12%	\$39,779	24	Timmins (North)	\$27,140	24	Sudbury (North)	\$39,847
25	Thunder Bay (North)	60 Years (2 Life Cycles)	12%	\$39,979	25	Thunder Bay (North)	\$27,330	25	Kenora (North)	\$40,022
26	Kenora (North)	60 Years (2 Life Cycles)	12%	\$40,134	26	Kenora (North)	\$27,473	26	Timmins (North)	\$40,475
27	Kapuskasing (North)	60 Years (2 Life Cycles)	12%	\$40,473	27	Kapuskasing (North)	\$27,815	27	Kapuskasing (North)	\$44,085

Table F2-1.36: Rankings of cities for feed-in tariff + rebates + carbon tax scenario (improved construction type) at a discount rate of 12% (two life cycles of V.GSHP and H.GSHP and five life cycles of Traditional HVAC Applications for a 60 year project lifespan)

7. Three Life Cycles of V.GSHP and H.GSHP and Five Life Cycles of Traditional HVAC Applications @ 5% Discount Rate

Base Case Scenario

Total Present Value										
Base Case Scenario										
#	City	Project Life Span	Discount Rate	V.GSHP	#	City	H.GSHP	#	City	Traditional
1	Sarnia (South)	60 Years (3 Life Cycles)	5%	\$73,760	1	St. Catharines (South)	\$56,491	1	Cambridge (South)	\$64,147
2	Chatham (South)	60 Years (3 Life Cycles)	5%	\$74,066	2	Sarnia (South)	\$57,087	2	Guelph (South)	\$65,014
3	Windsor (South)	60 Years (3 Life Cycles)	5%	\$74,089	3	Chatham (South)	\$57,432	3	Barrie (Distinct)	\$67,268
4	Niagara Falls (South)	60 Years (3 Life Cycles)	5%	\$74,427	4	Windsor (South)	\$57,468	4	London (South)	\$68,258
5	Simcoe (South)	60 Years (3 Life Cycles)	5%	\$74,992	5	Niagara Falls (South)	\$57,803	5	Chatham (South)	\$69,170
6	Hamilton (South)	60 Years (3 Life Cycles)	5%	\$75,420	6	Simcoe (South)	\$58,367	6	Windsor (South)	\$69,226
7	Cambridge (South)	60 Years (3 Life Cycles)	5%	\$75,897	7	Hamilton (South)	\$58,796	7	Muskoka (Distinct)	\$69,707
8	London (South)	60 Years (3 Life Cycles)	5%	\$75,904	8	London (South)	\$59,254	8	Sarnia (South)	\$69,792
9	Guelph (South)	60 Years (3 Life Cycles)	5%	\$76,258	9	Cambridge (South)	\$59,273	9	Sault Ste. Marie (North)	\$69,921
10	Sault Ste. Marie (North)	60 Years (3 Life Cycles)	5%	\$78,173	10	Toronto (South)	\$59,308	10	Niagara Falls (South)	\$70,716
11	St. Catharines (South)	60 Years (3 Life Cycles)	5%	\$89,793	11	Guelph (South)	\$59,634	11	St. Catharines (South)	\$70,967
12	Toronto (South)	60 Years (3 Life Cycles)	5%	\$92,517	12	Mt. Forest (South)	\$60,272	12	Toronto (South)	\$71,183
13	Trenton (South)	60 Years (3 Life Cycles)	5%	\$92,804	13	Sault Ste. Marie (North)	\$61,594	13	Ottawa (Distinct)	\$71,833
14	Kitchener-Waterloo (South)	60 Years (3 Life Cycles)	5%	\$93,120	14	Trenton (South)	\$70,536	14	North Bay (North)	\$71,891
15	Mt. Forest (South)	60 Years (3 Life Cycles)	5%	\$93,339	15	Kitchener-Waterloo (South)	\$70,881	15	Hamilton (South)	\$72,055
16	Barrie (Distinct)	60 Years (3 Life Cycles)	5%	\$93,446	16	Barrie (Distinct)	\$71,161	16	Simcoe (South)	\$72,880
17	Ottawa (Distinct)	60 Years (3 Life Cycles)	5%	\$93,533	17	Ottawa (Distinct)	\$71,290	17	Peterborough (Distinct)	\$72,966
18	Kingston (South)	60 Years (3 Life Cycles)	5%	\$93,668	18	Kingston (South)	\$71,429	18	Mt. Forest (South)	\$72,977
19	Warton (South)	60 Years (3 Life Cycles)	5%	\$93,913	19	Warton (South)	\$71,638	19	Kitchener-Waterloo (South)	\$73,273
20	Peterborough (Distinct)	60 Years (3 Life Cycles)	5%	\$94,300	20	Peterborough (Distinct)	\$72,058	20	Warton (South)	\$74,750
21	North Bay (North)	60 Years (3 Life Cycles)	5%	\$94,471	21	Muskoka (Distinct)	\$72,196	21	Thunder Bay (North)	\$76,130
22	Muskoka (Distinct)	60 Years (3 Life Cycles)	5%	\$94,480	22	North Bay (North)	\$72,270	22	Trenton (South)	\$76,803
23	Sudbury (North)	60 Years (3 Life Cycles)	5%	\$95,489	23	Sudbury (North)	\$73,299	23	Kingston (South)	\$77,445
24	Timmins (North)	60 Years (3 Life Cycles)	5%	\$97,188	24	Timmins (North)	\$75,001	24	Sudbury (North)	\$77,563
25	Thunder Bay (North)	60 Years (3 Life Cycles)	5%	\$97,872	25	Thunder Bay (North)	\$75,649	25	Kenora (North)	\$77,586
26	Kenora (North)	60 Years (3 Life Cycles)	5%	\$98,400	26	Kenora (North)	\$76,136	26	Timmins (North)	\$78,336
27	Kapuskasing (North)	60 Years (3 Life Cycles)	5%	\$99,558	27	Kapuskasing (North)	\$77,303	27	Kapuskasing (North)	\$85,695

Table F2-1.37: Rankings of cities for base case scenario (improved construction type) at a discount rate of 5% (three life cycles of V.GSHP and H.GSHP and five life cycles of Traditional HVAC Applications for a 60 year project lifespan)

Carbon Taxes – (#1)

Total Present Value										
Carbon Taxes - (#1)										
#	City	Project Life Span	Discount Rate	V.GSHP	#	City	H.GSHP	#	City	Traditional
1	Sarnia (South)	60 Years (3 Life Cycles)	5%	\$73,760	1	St. Catharines (South)	\$56,491	1	Cambridge (South)	\$82,660
2	Chatham (South)	60 Years (3 Life Cycles)	5%	\$74,066	2	Sarnia (South)	\$57,087	2	Guelph (South)	\$84,076
3	Windsor (South)	60 Years (3 Life Cycles)	5%	\$74,089	3	Chatham (South)	\$57,432	3	Chatham (South)	\$85,813
4	Niagara Falls (South)	60 Years (3 Life Cycles)	5%	\$74,427	4	Windsor (South)	\$57,468	4	Windsor (South)	\$85,911
5	Simcoe (South)	60 Years (3 Life Cycles)	5%	\$74,992	5	Niagara Falls (South)	\$57,803	5	Barrie (Distinct)	\$86,022
6	Hamilton (South)	60 Years (3 Life Cycles)	5%	\$75,420	6	Simcoe (South)	\$58,367	6	London (South)	\$86,771
7	Cambridge (South)	60 Years (3 Life Cycles)	5%	\$75,897	7	Hamilton (South)	\$58,796	7	Sarnia (South)	\$86,791
8	London (South)	60 Years (3 Life Cycles)	5%	\$75,904	8	London (South)	\$59,254	8	St. Catharines (South)	\$87,260
9	Guelph (South)	60 Years (3 Life Cycles)	5%	\$76,258	9	Cambridge (South)	\$59,273	9	Niagara Falls (South)	\$87,552
10	Sault Ste. Marie (North)	60 Years (3 Life Cycles)	5%	\$78,173	10	Toronto (South)	\$59,308	10	Toronto (South)	\$89,732
11	St. Catharines (South)	60 Years (3 Life Cycles)	5%	\$89,793	11	Guelph (South)	\$59,634	11	Muskoka (Distinct)	\$89,770
12	Toronto (South)	60 Years (3 Life Cycles)	5%	\$92,517	12	Mt. Forest (South)	\$60,272	12	Hamilton (South)	\$90,098
13	Trenton (South)	60 Years (3 Life Cycles)	5%	\$92,804	13	Sault Ste. Marie (North)	\$61,594	13	Simcoe (South)	\$90,524
14	Kitchener-Waterloo (South)	60 Years (3 Life Cycles)	5%	\$93,120	14	Trenton (South)	\$70,536	14	Sault Ste. Marie (North)	\$90,563
15	Mt. Forest (South)	60 Years (3 Life Cycles)	5%	\$93,339	15	Kitchener-Waterloo (South)	\$70,881	15	Ottawa (Distinct)	\$91,015
16	Barrie (Distinct)	60 Years (3 Life Cycles)	5%	\$93,446	16	Barrie (Distinct)	\$71,161	16	North Bay (North)	\$92,081
17	Ottawa (Distinct)	60 Years (3 Life Cycles)	5%	\$93,533	17	Ottawa (Distinct)	\$71,290	17	Kitchener-Waterloo (South)	\$92,377
18	Kingston (South)	60 Years (3 Life Cycles)	5%	\$93,668	18	Kingston (South)	\$71,429	18	Peterborough (Distinct)	\$92,963
19	Warton (South)	60 Years (3 Life Cycles)	5%	\$93,913	19	Warton (South)	\$71,638	19	Mt. Forest (South)	\$93,276
20	Peterborough (Distinct)	60 Years (3 Life Cycles)	5%	\$94,300	20	Peterborough (Distinct)	\$72,058	20	Warton (South)	\$94,554
21	North Bay (North)	60 Years (3 Life Cycles)	5%	\$94,471	21	Muskoka (Distinct)	\$72,196	21	Trenton (South)	\$95,472
22	Muskoka (Distinct)	60 Years (3 Life Cycles)	5%	\$94,480	22	North Bay (North)	\$72,270	22	Kingston (South)	\$96,658
23	Sudbury (North)	60 Years (3 Life Cycles)	5%	\$95,489	23	Sudbury (North)	\$73,299	23	Thunder Bay (North)	\$98,992
24	Timmins (North)	60 Years (3 Life Cycles)	5%	\$97,188	24	Timmins (North)	\$75,001	24	Sudbury (North)	\$99,200
25	Thunder Bay (North)	60 Years (3 Life Cycles)	5%	\$97,872	25	Thunder Bay (North)	\$75,649	25	Kenora (North)	\$100,750
26	Kenora (North)	60 Years (3 Life Cycles)	5%	\$98,400	26	Kenora (North)	\$76,136	26	Timmins (North)	\$102,145
27	Kapuskasing (North)	60 Years (3 Life Cycles)	5%	\$99,558	27	Kapuskasing (North)	\$77,303	27	Kapuskasing (North)	\$110,379

Table F2-1.38: Rankings of cities for carbon taxes scenario (improved construction type) at a discount rate of 5% (three life cycles of V.GSHP and H.GSHP and five life cycles of Traditional HVAC Applications for a 60 year project lifespan)

FIT – (#2)

Total Present Value										
FIT - (#2)										
#	City	Project Life Span	Discount Rate	V.GSHP	#	City	H.GSHP	#	City	Traditional
1	Sarnia (South)	60 Years (3 Life Cycles)	5%	\$65,945	1	St. Catharines (South)	\$48,795	1	Cambridge (South)	\$64,147
2	Chatham (South)	60 Years (3 Life Cycles)	5%	\$66,161	2	Sarnia (South)	\$49,216	2	Guelph (South)	\$65,014
3	Windsor (South)	60 Years (3 Life Cycles)	5%	\$66,177	3	Chatham (South)	\$49,460	3	Barrie (Distinct)	\$67,268
4	Niagara Falls (South)	60 Years (3 Life Cycles)	5%	\$66,417	4	Windsor (South)	\$49,485	4	London (South)	\$68,258
5	Simcoe (South)	60 Years (3 Life Cycles)	5%	\$66,815	5	Niagara Falls (South)	\$49,722	5	Chatham (South)	\$69,170
6	Hamilton (South)	60 Years (3 Life Cycles)	5%	\$67,118	6	Simcoe (South)	\$50,120	6	Windsor (South)	\$69,226
7	Cambridge (South)	60 Years (3 Life Cycles)	5%	\$67,455	7	Hamilton (South)	\$50,423	7	Muskoka (Distinct)	\$69,707
8	London (South)	60 Years (3 Life Cycles)	5%	\$67,460	8	London (South)	\$50,747	8	Sarnia (South)	\$69,792
9	Guelph (South)	60 Years (3 Life Cycles)	5%	\$67,710	9	Cambridge (South)	\$50,760	9	Sault Ste. Marie (North)	\$69,921
10	Sault Ste. Marie (North)	60 Years (3 Life Cycles)	5%	\$69,063	10	Toronto (South)	\$50,785	10	Niagara Falls (South)	\$70,716
11	St. Catharines (South)	60 Years (3 Life Cycles)	5%	\$81,884	11	Guelph (South)	\$51,015	11	St. Catharines (South)	\$70,967
12	Toronto (South)	60 Years (3 Life Cycles)	5%	\$83,809	12	Mt. Forest (South)	\$51,466	12	Toronto (South)	\$71,183
13	Trenton (South)	60 Years (3 Life Cycles)	5%	\$84,011	13	Sault Ste. Marie (North)	\$52,400	13	Ottawa (Distinct)	\$71,833
14	Kitchener-Waterloo (South)	60 Years (3 Life Cycles)	5%	\$84,235	14	Trenton (South)	\$61,680	14	North Bay (North)	\$71,891
15	Mt. Forest (South)	60 Years (3 Life Cycles)	5%	\$84,389	15	Kitchener-Waterloo (South)	\$61,923	15	Hamilton (South)	\$72,055
16	Barrie (Distinct)	60 Years (3 Life Cycles)	5%	\$84,465	16	Barrie (Distinct)	\$62,122	16	Simcoe (South)	\$72,880
17	Ottawa (Distinct)	60 Years (3 Life Cycles)	5%	\$84,526	17	Ottawa (Distinct)	\$62,213	17	Peterborough (Distinct)	\$72,966
18	Kingston (South)	60 Years (3 Life Cycles)	5%	\$84,622	18	Kingston (South)	\$62,311	18	Mt. Forest (South)	\$72,977
19	Warton (South)	60 Years (3 Life Cycles)	5%	\$84,795	19	Warton (South)	\$62,459	19	Kitchener-Waterloo (South)	\$73,273
20	Peterborough (Distinct)	60 Years (3 Life Cycles)	5%	\$85,068	20	Peterborough (Distinct)	\$62,755	20	Warton (South)	\$74,750
21	North Bay (North)	60 Years (3 Life Cycles)	5%	\$85,189	21	Muskoka (Distinct)	\$62,853	21	Thunder Bay (North)	\$76,130
22	Muskoka (Distinct)	60 Years (3 Life Cycles)	5%	\$85,196	22	North Bay (North)	\$62,905	22	Trenton (South)	\$76,803
23	Sudbury (North)	60 Years (3 Life Cycles)	5%	\$85,908	23	Sudbury (North)	\$63,631	23	Kingston (South)	\$77,445
24	Timmins (North)	60 Years (3 Life Cycles)	5%	\$87,109	24	Timmins (North)	\$64,834	24	Sudbury (North)	\$77,563
25	Thunder Bay (North)	60 Years (3 Life Cycles)	5%	\$87,591	25	Thunder Bay (North)	\$65,292	25	Kenora (North)	\$77,586
26	Kenora (North)	60 Years (3 Life Cycles)	5%	\$87,965	26	Kenora (North)	\$65,635	26	Timmins (North)	\$78,336
27	Kapuskasing (North)	60 Years (3 Life Cycles)	5%	\$88,782	27	Kapuskasing (North)	\$66,460	27	Kapuskasing (North)	\$85,695

Table F2-1.39: Rankings of cities for feed-in tariff scenario (improved construction type) at a discount rate of 5% (three life cycles of V.GSHP and H.GSHP and five life cycles of Traditional HVAC Applications for a 60 year project lifespan)

Rebates – (#3)

Total Present Value										
Rebates - (#3)										
#	City	Project Life Span	Discount Rate	V.GSHP	#	City	H.GSHP	#	City	Traditional
1	Sarnia (South)	60 Years (3 Life Cycles)	5%	\$64,392	1	St. Catharines (South)	\$47,122	1	Cambridge (South)	\$64,147
2	Chatham (South)	60 Years (3 Life Cycles)	5%	\$64,698	2	Sarnia (South)	\$47,719	2	Guelph (South)	\$65,014
3	Windsor (South)	60 Years (3 Life Cycles)	5%	\$64,720	3	Chatham (South)	\$48,064	3	Barrie (Distinct)	\$67,268
4	Niagara Falls (South)	60 Years (3 Life Cycles)	5%	\$65,059	4	Windsor (South)	\$48,099	4	London (South)	\$68,258
5	Simcoe (South)	60 Years (3 Life Cycles)	5%	\$65,623	5	Niagara Falls (South)	\$48,434	5	Chatham (South)	\$69,170
6	Hamilton (South)	60 Years (3 Life Cycles)	5%	\$66,052	6	Simcoe (South)	\$48,999	6	Windsor (South)	\$69,226
7	Cambridge (South)	60 Years (3 Life Cycles)	5%	\$66,529	7	Hamilton (South)	\$49,427	7	Muskoka (Distinct)	\$69,707
8	London (South)	60 Years (3 Life Cycles)	5%	\$66,535	8	London (South)	\$49,885	8	Sarnia (South)	\$69,792
9	Guelph (South)	60 Years (3 Life Cycles)	5%	\$66,890	9	Cambridge (South)	\$49,904	9	Sault Ste. Marie (North)	\$69,921
10	Sault Ste. Marie (North)	60 Years (3 Life Cycles)	5%	\$68,805	10	Toronto (South)	\$49,940	10	Niagara Falls (South)	\$70,716
11	St. Catharines (South)	60 Years (3 Life Cycles)	5%	\$80,425	11	Guelph (South)	\$50,265	11	St. Catharines (South)	\$70,967
12	Toronto (South)	60 Years (3 Life Cycles)	5%	\$83,149	12	Mt. Forest (South)	\$50,904	12	Toronto (South)	\$71,183
13	Trenton (South)	60 Years (3 Life Cycles)	5%	\$83,436	13	Sault Ste. Marie (North)	\$52,226	13	Ottawa (Distinct)	\$71,833
14	Kitchener-Waterloo (South)	60 Years (3 Life Cycles)	5%	\$83,752	14	Trenton (South)	\$61,167	14	North Bay (North)	\$71,891
15	Mt. Forest (South)	60 Years (3 Life Cycles)	5%	\$83,971	15	Kitchener-Waterloo (South)	\$61,512	15	Hamilton (South)	\$72,055
16	Barrie (Distinct)	60 Years (3 Life Cycles)	5%	\$84,077	16	Barrie (Distinct)	\$61,793	16	Simcoe (South)	\$72,880
17	Ottawa (Distinct)	60 Years (3 Life Cycles)	5%	\$84,164	17	Ottawa (Distinct)	\$61,922	17	Peterborough (Distinct)	\$72,966
18	Kingston (South)	60 Years (3 Life Cycles)	5%	\$84,300	18	Kingston (South)	\$62,060	18	Mt. Forest (South)	\$72,977
19	Warton (South)	60 Years (3 Life Cycles)	5%	\$84,545	19	Warton (South)	\$62,270	19	Kitchener-Waterloo (South)	\$73,273
20	Peterborough (Distinct)	60 Years (3 Life Cycles)	5%	\$84,931	20	Peterborough (Distinct)	\$62,689	20	Warton (South)	\$74,750
21	North Bay (North)	60 Years (3 Life Cycles)	5%	\$85,102	21	Muskoka (Distinct)	\$62,828	21	Thunder Bay (North)	\$76,130
22	Muskoka (Distinct)	60 Years (3 Life Cycles)	5%	\$85,112	22	North Bay (North)	\$62,902	22	Trenton (South)	\$76,803
23	Sudbury (North)	60 Years (3 Life Cycles)	5%	\$86,121	23	Sudbury (North)	\$63,930	23	Kingston (South)	\$77,445
24	Timmins (North)	60 Years (3 Life Cycles)	5%	\$87,820	24	Timmins (North)	\$65,632	24	Sudbury (North)	\$77,563
25	Thunder Bay (North)	60 Years (3 Life Cycles)	5%	\$88,503	25	Thunder Bay (North)	\$66,280	25	Kenora (North)	\$77,586
26	Kenora (North)	60 Years (3 Life Cycles)	5%	\$89,032	26	Kenora (North)	\$66,767	26	Timmins (North)	\$78,336
27	Kapuskasing (North)	60 Years (3 Life Cycles)	5%	\$90,189	27	Kapuskasing (North)	\$67,934	27	Kapuskasing (North)	\$85,695

Table F2-1.40: Rankings of cities for rebates scenario (improved construction type) at a discount rate of 5% (three life cycles of V.GSHP and H.GSHP and five life cycles of Traditional HVAC Applications for a 60 year project lifespan)

FIT + Rebates – (#4)

Total Present Value										
(FIT+Rebates) - (#4)										
#	City	Project Life Span	Discount Rate	V.GSHP	#	City	H.GSHP	#	City	Traditional
1	Sarnia (South)	60 Years (3 Life Cycles)	5%	\$56,577	1	St. Catharines (South)	\$39,427	1	Cambridge (South)	\$64,147
2	Chatham (South)	60 Years (3 Life Cycles)	5%	\$56,793	2	Sarnia (South)	\$39,848	2	Guelph (South)	\$65,014
3	Windsor (South)	60 Years (3 Life Cycles)	5%	\$56,809	3	Chatham (South)	\$40,092	3	Barrie (Distinct)	\$67,268
4	Niagara Falls (South)	60 Years (3 Life Cycles)	5%	\$57,048	4	Windsor (South)	\$40,117	4	London (South)	\$68,258
5	Simcoe (South)	60 Years (3 Life Cycles)	5%	\$57,447	5	Niagara Falls (South)	\$40,354	5	Chatham (South)	\$69,170
6	Hamilton (South)	60 Years (3 Life Cycles)	5%	\$57,750	6	Simcoe (South)	\$40,752	6	Windsor (South)	\$69,226
7	Cambridge (South)	60 Years (3 Life Cycles)	5%	\$58,087	7	Hamilton (South)	\$41,055	7	Muskoka (Distinct)	\$69,707
8	London (South)	60 Years (3 Life Cycles)	5%	\$58,091	8	London (South)	\$41,378	8	Sarnia (South)	\$69,792
9	Guelph (South)	60 Years (3 Life Cycles)	5%	\$58,342	9	Cambridge (South)	\$41,392	9	Sault Ste. Marie (North)	\$69,921
10	Sault Ste. Marie (North)	60 Years (3 Life Cycles)	5%	\$59,694	10	Toronto (South)	\$41,417	10	Niagara Falls (South)	\$70,716
11	St. Catharines (South)	60 Years (3 Life Cycles)	5%	\$72,516	11	Guelph (South)	\$41,647	11	St. Catharines (South)	\$70,967
12	Toronto (South)	60 Years (3 Life Cycles)	5%	\$74,440	12	Mt. Forest (South)	\$42,098	12	Toronto (South)	\$71,183
13	Trenton (South)	60 Years (3 Life Cycles)	5%	\$74,643	13	Sault Ste. Marie (North)	\$43,032	13	Ottawa (Distinct)	\$71,833
14	Kitchener-Waterloo (South)	60 Years (3 Life Cycles)	5%	\$74,866	14	Trenton (South)	\$52,311	14	North Bay (North)	\$71,891
15	Mt. Forest (South)	60 Years (3 Life Cycles)	5%	\$75,021	15	Kitchener-Waterloo (South)	\$52,555	15	Hamilton (South)	\$72,055
16	Barrie (Distinct)	60 Years (3 Life Cycles)	5%	\$75,096	16	Barrie (Distinct)	\$52,753	16	Simcoe (South)	\$72,880
17	Ottawa (Distinct)	60 Years (3 Life Cycles)	5%	\$75,158	17	Ottawa (Distinct)	\$52,844	17	Peterborough (Distinct)	\$72,966
18	Kingston (South)	60 Years (3 Life Cycles)	5%	\$75,253	18	Kingston (South)	\$52,942	18	Mt. Forest (South)	\$72,977
19	Warton (South)	60 Years (3 Life Cycles)	5%	\$75,426	19	Warton (South)	\$53,090	19	Kitchener-Waterloo (South)	\$73,273
20	Peterborough (Distinct)	60 Years (3 Life Cycles)	5%	\$75,700	20	Peterborough (Distinct)	\$53,386	20	Warton (South)	\$74,750
21	North Bay (North)	60 Years (3 Life Cycles)	5%	\$75,820	21	Muskoka (Distinct)	\$53,484	21	Thunder Bay (North)	\$76,130
22	Muskoka (Distinct)	60 Years (3 Life Cycles)	5%	\$75,827	22	North Bay (North)	\$53,537	22	Trenton (South)	\$76,803
23	Sudbury (North)	60 Years (3 Life Cycles)	5%	\$76,540	23	Sudbury (North)	\$54,263	23	Kingston (South)	\$77,445
24	Timmins (North)	60 Years (3 Life Cycles)	5%	\$77,740	24	Timmins (North)	\$55,465	24	Sudbury (North)	\$77,563
25	Thunder Bay (North)	60 Years (3 Life Cycles)	5%	\$78,223	25	Thunder Bay (North)	\$55,923	25	Kenora (North)	\$77,586
26	Kenora (North)	60 Years (3 Life Cycles)	5%	\$78,596	26	Kenora (North)	\$56,267	26	Timmins (North)	\$78,336
27	Kapuskasing (North)	60 Years (3 Life Cycles)	5%	\$79,414	27	Kapuskasing (North)	\$57,091	27	Kapuskasing (North)	\$85,695

Table F2-1.41: Rankings of cities for feed-in tariff + rebates scenario (improved construction type) at a discount rate of 5% (three life cycles of V.GSHP and H.GSHP and five life cycles of Traditional HVAC Applications for a 60 year project lifespan)

(FIT + Rebates) + Carbon Taxes – (#5)

Total Present Value										
(FIT+Rebates) + Carbon Taxes - (#5)										
#	City	Project Life Span	Discount Rate	V.GSHP	#	City	H.GSHP	#	City	Traditional
1	Sarnia (South)	60 Years (3 Life Cycles)	5%	\$56,577	1	St. Catharines (South)	\$39,427	1	Cambridge (South)	\$82,660
2	Chatham (South)	60 Years (3 Life Cycles)	5%	\$56,793	2	Sarnia (South)	\$39,848	2	Guelph (South)	\$84,076
3	Windsor (South)	60 Years (3 Life Cycles)	5%	\$56,809	3	Chatham (South)	\$40,092	3	Chatham (South)	\$85,813
4	Niagara Falls (South)	60 Years (3 Life Cycles)	5%	\$57,048	4	Windsor (South)	\$40,117	4	Windsor (South)	\$85,911
5	Simcoe (South)	60 Years (3 Life Cycles)	5%	\$57,447	5	Niagara Falls (South)	\$40,354	5	Barrie (Distinct)	\$86,022
6	Hamilton (South)	60 Years (3 Life Cycles)	5%	\$57,750	6	Simcoe (South)	\$40,752	6	London (South)	\$86,771
7	Cambridge (South)	60 Years (3 Life Cycles)	5%	\$58,087	7	Hamilton (South)	\$41,055	7	Sarnia (South)	\$86,791
8	London (South)	60 Years (3 Life Cycles)	5%	\$58,091	8	London (South)	\$41,378	8	St. Catharines (South)	\$87,260
9	Guelph (South)	60 Years (3 Life Cycles)	5%	\$58,342	9	Cambridge (South)	\$41,392	9	Niagara Falls (South)	\$87,552
10	Sault Ste. Marie (North)	60 Years (3 Life Cycles)	5%	\$59,694	10	Toronto (South)	\$41,417	10	Toronto (South)	\$89,732
11	St. Catharines (South)	60 Years (3 Life Cycles)	5%	\$72,516	11	Guelph (South)	\$41,647	11	Muskoka (Distinct)	\$89,770
12	Toronto (South)	60 Years (3 Life Cycles)	5%	\$74,440	12	Mt. Forest (South)	\$42,098	12	Hamilton (South)	\$90,098
13	Trenton (South)	60 Years (3 Life Cycles)	5%	\$74,643	13	Sault Ste. Marie (North)	\$43,032	13	Simcoe (South)	\$90,524
14	Kitchener-Waterloo (South)	60 Years (3 Life Cycles)	5%	\$74,866	14	Trenton (South)	\$52,311	14	Sault Ste. Marie (North)	\$90,563
15	Mt. Forest (South)	60 Years (3 Life Cycles)	5%	\$75,021	15	Kitchener-Waterloo (South)	\$52,555	15	Ottawa (Distinct)	\$91,015
16	Barrie (Distinct)	60 Years (3 Life Cycles)	5%	\$75,096	16	Barrie (Distinct)	\$52,753	16	North Bay (North)	\$92,081
17	Ottawa (Distinct)	60 Years (3 Life Cycles)	5%	\$75,158	17	Ottawa (Distinct)	\$52,844	17	Kitchener-Waterloo (South)	\$92,377
18	Kingston (South)	60 Years (3 Life Cycles)	5%	\$75,253	18	Kingston (South)	\$52,942	18	Peterborough (Distinct)	\$92,963
19	Warton (South)	60 Years (3 Life Cycles)	5%	\$75,426	19	Warton (South)	\$53,090	19	Mt. Forest (South)	\$93,276
20	Peterborough (Distinct)	60 Years (3 Life Cycles)	5%	\$75,700	20	Peterborough (Distinct)	\$53,386	20	Warton (South)	\$94,554
21	North Bay (North)	60 Years (3 Life Cycles)	5%	\$75,820	21	Muskoka (Distinct)	\$53,484	21	Trenton (South)	\$95,472
22	Muskoka (Distinct)	60 Years (3 Life Cycles)	5%	\$75,827	22	North Bay (North)	\$53,537	22	Kingston (South)	\$96,658
23	Sudbury (North)	60 Years (3 Life Cycles)	5%	\$76,540	23	Sudbury (North)	\$54,263	23	Thunder Bay (North)	\$98,992
24	Timmins (North)	60 Years (3 Life Cycles)	5%	\$77,740	24	Timmins (North)	\$55,465	24	Sudbury (North)	\$99,200
25	Thunder Bay (North)	60 Years (3 Life Cycles)	5%	\$78,223	25	Thunder Bay (North)	\$55,923	25	Kenora (North)	\$100,750
26	Kenora (North)	60 Years (3 Life Cycles)	5%	\$78,596	26	Kenora (North)	\$56,267	26	Timmins (North)	\$102,145
27	Kapuskasing (North)	60 Years (3 Life Cycles)	5%	\$79,414	27	Kapuskasing (North)	\$57,091	27	Kapuskasing (North)	\$110,379

Table F2-1.42: Rankings of cities for feed-in tariff + rebates + carbon tax scenario (improved construction type) at a discount rate of 5% (three life cycles of V.GSHP and H.GSHP and five life cycles of Traditional HVAC Applications for a 60 year project lifespan)

8. Three Life Cycles of V.GSHP and H.GSHP and Five Life Cycles of Traditional HVAC Applications @ 7% Discount Rate

Base Case Scenario

Total Present Value										
Base Case Scenario										
#	City	Project Life Span	Discount Rate	V.GSHP	#	City	H.GSHP	#	City	Traditional
1	Sarnia (South)	60 Years (3 Life Cycles)	7%	\$57,687	1	St. Catharines (South)	\$43,608	1	Cambridge (South)	\$47,171
2	Chatham (South)	60 Years (3 Life Cycles)	7%	\$57,911	2	Sarnia (South)	\$44,043	2	Guelph (South)	\$47,796
3	Windsor (South)	60 Years (3 Life Cycles)	7%	\$57,927	3	Chatham (South)	\$44,295	3	Barrie (Distinct)	\$49,495
4	Niagara Falls (South)	60 Years (3 Life Cycles)	7%	\$58,174	4	Windsor (South)	\$44,321	4	London (South)	\$50,222
5	Simcoe (South)	60 Years (3 Life Cycles)	7%	\$58,586	5	Niagara Falls (South)	\$44,565	5	Chatham (South)	\$50,963
6	Hamilton (South)	60 Years (3 Life Cycles)	7%	\$58,899	6	Simcoe (South)	\$44,977	6	Windsor (South)	\$51,004
7	Cambridge (South)	60 Years (3 Life Cycles)	7%	\$59,247	7	Hamilton (South)	\$45,290	7	Muskoka (Distinct)	\$51,258
8	London (South)	60 Years (3 Life Cycles)	7%	\$59,252	8	London (South)	\$45,624	8	Sarnia (South)	\$51,412
9	Guelph (South)	60 Years (3 Life Cycles)	7%	\$59,511	9	Cambridge (South)	\$45,638	9	Sault Ste. Marie (North)	\$51,406
10	Sault Ste. Marie (North)	60 Years (3 Life Cycles)	7%	\$60,908	10	Toronto (South)	\$45,664	10	Niagara Falls (South)	\$52,089
11	St. Catharines (South)	60 Years (3 Life Cycles)	7%	\$70,674	11	Guelph (South)	\$45,902	11	St. Catharines (South)	\$52,280
12	Toronto (South)	60 Years (3 Life Cycles)	7%	\$72,662	12	Mt. Forest (South)	\$46,368	12	Toronto (South)	\$52,406
13	Trenton (South)	60 Years (3 Life Cycles)	7%	\$72,872	13	Sault Ste. Marie (North)	\$47,332	13	Ottawa (Distinct)	\$52,872
14	Kitchener-Waterloo (South)	60 Years (3 Life Cycles)	7%	\$73,102	14	Trenton (South)	\$54,652	14	North Bay (North)	\$52,901
15	Mt. Forest (South)	60 Years (3 Life Cycles)	7%	\$73,262	15	Kitchener-Waterloo (South)	\$54,904	15	Hamilton (South)	\$53,050
16	Barrie (Distinct)	60 Years (3 Life Cycles)	7%	\$73,340	16	Barrie (Distinct)	\$55,108	16	Simcoe (South)	\$53,708
17	Ottawa (Distinct)	60 Years (3 Life Cycles)	7%	\$73,403	17	Ottawa (Distinct)	\$55,202	17	Peterborough (Distinct)	\$53,687
18	Kingston (South)	60 Years (3 Life Cycles)	7%	\$73,502	18	Kingston (South)	\$55,303	18	Mt. Forest (South)	\$53,692
19	Warton (South)	60 Years (3 Life Cycles)	7%	\$73,681	19	Warton (South)	\$55,456	19	Kitchener-Waterloo (South)	\$53,924
20	Peterborough (Distinct)	60 Years (3 Life Cycles)	7%	\$73,963	20	Peterborough (Distinct)	\$55,762	20	Warton (South)	\$55,043
21	North Bay (North)	60 Years (3 Life Cycles)	7%	\$74,088	21	Muskoka (Distinct)	\$55,863	21	Thunder Bay (North)	\$55,958
22	Muskoka (Distinct)	60 Years (3 Life Cycles)	7%	\$74,095	22	North Bay (North)	\$55,917	22	Trenton (South)	\$56,607
23	Sudbury (North)	60 Years (3 Life Cycles)	7%	\$74,831	23	Sudbury (North)	\$56,668	23	Kingston (South)	\$57,068
24	Timmins (North)	60 Years (3 Life Cycles)	7%	\$76,071	24	Timmins (North)	\$57,910	24	Sudbury (North)	\$57,070
25	Thunder Bay (North)	60 Years (3 Life Cycles)	7%	\$76,570	25	Thunder Bay (North)	\$58,383	25	Kenora (North)	\$57,016
26	Kenora (North)	60 Years (3 Life Cycles)	7%	\$76,956	26	Kenora (North)	\$58,738	26	Timmins (North)	\$57,554
27	Kapuskasing (North)	60 Years (3 Life Cycles)	7%	\$77,800	27	Kapuskasing (North)	\$59,590	27	Kapuskasing (North)	\$63,014

Table F2-1.43: Rankings of cities for base case scenario (improved construction type) at a discount rate of 7% (three life cycles of V.GSHP and H.GSHP and five life cycles of Traditional HVAC Applications for a 60 year project lifespan)

Carbon Taxes – (#1)

Total Present Value										
Carbon Taxes - (#1)										
#	City	Project Life Span	Discount Rate	V.GSHP	#	City	H.GSHP	#	City	Traditional
1	Sarnia (South)	60 Years (3 Life Cycles)	7%	\$57,687	1	St. Catharines (South)	\$43,608	1	Cambridge (South)	\$58,270
2	Chatham (South)	60 Years (3 Life Cycles)	7%	\$57,911	2	Sarnia (South)	\$44,043	2	Guelph (South)	\$59,224
3	Windsor (South)	60 Years (3 Life Cycles)	7%	\$57,927	3	Chatham (South)	\$44,295	3	Chatham (South)	\$60,941
4	Niagara Falls (South)	60 Years (3 Life Cycles)	7%	\$58,174	4	Windsor (South)	\$44,321	4	Windsor (South)	\$61,007
5	Simcoe (South)	60 Years (3 Life Cycles)	7%	\$58,586	5	Niagara Falls (South)	\$44,565	5	Barrie (Distinct)	\$60,739
6	Hamilton (South)	60 Years (3 Life Cycles)	7%	\$58,899	6	Simcoe (South)	\$44,977	6	London (South)	\$61,321
7	Cambridge (South)	60 Years (3 Life Cycles)	7%	\$59,247	7	Hamilton (South)	\$45,290	7	Sarnia (South)	\$61,604
8	London (South)	60 Years (3 Life Cycles)	7%	\$59,252	8	London (South)	\$45,624	8	St. Catharines (South)	\$62,048
9	Guelph (South)	60 Years (3 Life Cycles)	7%	\$59,511	9	Cambridge (South)	\$45,638	9	Niagara Falls (South)	\$62,183
10	Sault Ste. Marie (North)	60 Years (3 Life Cycles)	7%	\$60,908	10	Toronto (South)	\$45,664	10	Toronto (South)	\$63,527
11	St. Catharines (South)	60 Years (3 Life Cycles)	7%	\$70,674	11	Guelph (South)	\$45,902	11	Muskoka (Distinct)	\$63,286
12	Toronto (South)	60 Years (3 Life Cycles)	7%	\$72,662	12	Mt. Forest (South)	\$46,368	12	Hamilton (South)	\$63,867
13	Trenton (South)	60 Years (3 Life Cycles)	7%	\$72,872	13	Sault Ste. Marie (North)	\$47,332	13	Simcoe (South)	\$64,286
14	Kitchener-Waterloo (South)	60 Years (3 Life Cycles)	7%	\$73,102	14	Trenton (South)	\$54,652	14	Sault Ste. Marie (North)	\$63,781
15	Mt. Forest (South)	60 Years (3 Life Cycles)	7%	\$73,262	15	Kitchener-Waterloo (South)	\$54,904	15	Ottawa (Distinct)	\$64,372
16	Barrie (Distinct)	60 Years (3 Life Cycles)	7%	\$73,340	16	Barrie (Distinct)	\$55,108	16	North Bay (North)	\$65,005
17	Ottawa (Distinct)	60 Years (3 Life Cycles)	7%	\$73,403	17	Ottawa (Distinct)	\$55,202	17	Kitchener-Waterloo (South)	\$65,377
18	Kingston (South)	60 Years (3 Life Cycles)	7%	\$73,502	18	Kingston (South)	\$55,303	18	Peterborough (Distinct)	\$65,676
19	Warton (South)	60 Years (3 Life Cycles)	7%	\$73,681	19	Warton (South)	\$55,456	19	Mt. Forest (South)	\$65,861
20	Peterborough (Distinct)	60 Years (3 Life Cycles)	7%	\$73,963	20	Peterborough (Distinct)	\$55,762	20	Warton (South)	\$66,916
21	North Bay (North)	60 Years (3 Life Cycles)	7%	\$74,088	21	Muskoka (Distinct)	\$55,863	21	Trenton (South)	\$67,800
22	Muskoka (Distinct)	60 Years (3 Life Cycles)	7%	\$74,095	22	North Bay (North)	\$55,917	22	Kingston (South)	\$68,587
23	Sudbury (North)	60 Years (3 Life Cycles)	7%	\$74,831	23	Sudbury (North)	\$56,668	23	Thunder Bay (North)	\$69,664
24	Timmins (North)	60 Years (3 Life Cycles)	7%	\$76,071	24	Timmins (North)	\$57,910	24	Sudbury (North)	\$70,043
25	Thunder Bay (North)	60 Years (3 Life Cycles)	7%	\$76,570	25	Thunder Bay (North)	\$58,383	25	Kenora (North)	\$70,903
26	Kenora (North)	60 Years (3 Life Cycles)	7%	\$76,956	26	Kenora (North)	\$58,738	26	Timmins (North)	\$71,829
27	Kapuskasing (North)	60 Years (3 Life Cycles)	7%	\$77,800	27	Kapuskasing (North)	\$59,590	27	Kapuskasing (North)	\$77,813

Table F2-1.44: Rankings of cities for carbon taxes scenario (improved construction type) at a discount rate of 7% (three life cycles of V.GSHP and H.GSHP and five life cycles of Traditional HVAC Applications for a 60 year project lifespan)

FIT – (#2)

Total Present Value										
FIT - (#2)										
#	City	Project Life Span	Discount Rate	V.GSHP	#	City	H.GSHP	#	City	Traditional
1	Sarnia (South)	60 Years (3 Life Cycles)	7%	\$51,891	1	St. Catharines (South)	\$37,900	1	Cambridge (South)	\$47,171
2	Chatham (South)	60 Years (3 Life Cycles)	7%	\$52,048	2	Sarnia (South)	\$38,206	2	Guelph (South)	\$47,796
3	Windsor (South)	60 Years (3 Life Cycles)	7%	\$52,060	3	Chatham (South)	\$38,382	3	Barrie (Distinct)	\$49,495
4	Niagara Falls (South)	60 Years (3 Life Cycles)	7%	\$52,233	4	Windsor (South)	\$38,400	4	London (South)	\$50,222
5	Simcoe (South)	60 Years (3 Life Cycles)	7%	\$52,522	5	Niagara Falls (South)	\$38,572	5	Chatham (South)	\$50,963
6	Hamilton (South)	60 Years (3 Life Cycles)	7%	\$52,741	6	Simcoe (South)	\$38,861	6	Windsor (South)	\$51,004
7	Cambridge (South)	60 Years (3 Life Cycles)	7%	\$52,986	7	Hamilton (South)	\$39,080	7	Muskoka (Distinct)	\$51,258
8	London (South)	60 Years (3 Life Cycles)	7%	\$52,989	8	London (South)	\$39,315	8	Sarnia (South)	\$51,412
9	Guelph (South)	60 Years (3 Life Cycles)	7%	\$53,171	9	Cambridge (South)	\$39,325	9	Sault Ste. Marie (North)	\$51,406
10	Sault Ste. Marie (North)	60 Years (3 Life Cycles)	7%	\$54,151	10	Toronto (South)	\$39,343	10	Niagara Falls (South)	\$52,089
11	St. Catharines (South)	60 Years (3 Life Cycles)	7%	\$64,809	11	Guelph (South)	\$39,510	11	St. Catharines (South)	\$52,280
12	Toronto (South)	60 Years (3 Life Cycles)	7%	\$66,203	12	Mt. Forest (South)	\$39,836	12	Toronto (South)	\$52,406
13	Trenton (South)	60 Years (3 Life Cycles)	7%	\$66,350	13	Sault Ste. Marie (North)	\$40,513	13	Ottawa (Distinct)	\$52,872
14	Kitchener-Waterloo (South)	60 Years (3 Life Cycles)	7%	\$66,512	14	Trenton (South)	\$48,084	14	North Bay (North)	\$52,901
15	Mt. Forest (South)	60 Years (3 Life Cycles)	7%	\$66,624	15	Kitchener-Waterloo (South)	\$48,260	15	Hamilton (South)	\$53,050
16	Barrie (Distinct)	60 Years (3 Life Cycles)	7%	\$66,679	16	Barrie (Distinct)	\$48,404	16	Simcoe (South)	\$53,708
17	Ottawa (Distinct)	60 Years (3 Life Cycles)	7%	\$66,723	17	Ottawa (Distinct)	\$48,470	17	Peterborough (Distinct)	\$53,687
18	Kingston (South)	60 Years (3 Life Cycles)	7%	\$66,793	18	Kingston (South)	\$48,541	18	Mt. Forest (South)	\$53,692
19	Warton (South)	60 Years (3 Life Cycles)	7%	\$66,918	19	Warton (South)	\$48,648	19	Kitchener-Waterloo (South)	\$53,924
20	Peterborough (Distinct)	60 Years (3 Life Cycles)	7%	\$67,116	20	Peterborough (Distinct)	\$48,863	20	Warton (South)	\$55,043
21	North Bay (North)	60 Years (3 Life Cycles)	7%	\$67,204	21	Muskoka (Distinct)	\$48,934	21	Thunder Bay (North)	\$55,958
22	Muskoka (Distinct)	60 Years (3 Life Cycles)	7%	\$67,209	22	North Bay (North)	\$48,972	22	Trenton (South)	\$56,607
23	Sudbury (North)	60 Years (3 Life Cycles)	7%	\$67,725	23	Sudbury (North)	\$49,498	23	Kingston (South)	\$57,068
24	Timmins (North)	60 Years (3 Life Cycles)	7%	\$68,595	24	Timmins (North)	\$50,370	24	Sudbury (North)	\$57,070
25	Thunder Bay (North)	60 Years (3 Life Cycles)	7%	\$68,945	25	Thunder Bay (North)	\$50,701	25	Kenora (North)	\$57,016
26	Kenora (North)	60 Years (3 Life Cycles)	7%	\$69,216	26	Kenora (North)	\$50,951	26	Timmins (North)	\$57,554
27	Kapuskasing (North)	60 Years (3 Life Cycles)	7%	\$69,808	27	Kapuskasing (North)	\$51,548	27	Kapuskasing (North)	\$63,014

Table F2-1.45: Rankings of cities for feed-in tariff scenario (improved construction type) at a discount rate of 7% (three life cycles of V.GSHP and H.GSHP and five life cycles of Traditional HVAC Applications for a 60 year project lifespan)

Rebates – (#3)

Total Present Value										
Rebates - (#3)										
#	City	Project Life Span	Discount Rate	V.GSHP	#	City	H.GSHP	#	City	Traditional
1	Sarnia (South)	60 Years (3 Life Cycles)	7%	\$50,030	1	St. Catharines (South)	\$35,951	1	Cambridge (South)	\$47,171
2	Chatham (South)	60 Years (3 Life Cycles)	7%	\$50,254	2	Sarnia (South)	\$36,386	2	Guelph (South)	\$47,796
3	Windsor (South)	60 Years (3 Life Cycles)	7%	\$50,270	3	Chatham (South)	\$36,638	3	Barrie (Distinct)	\$49,495
4	Niagara Falls (South)	60 Years (3 Life Cycles)	7%	\$50,517	4	Windsor (South)	\$36,663	4	London (South)	\$50,222
5	Simcoe (South)	60 Years (3 Life Cycles)	7%	\$50,929	5	Niagara Falls (South)	\$36,908	5	Chatham (South)	\$50,963
6	Hamilton (South)	60 Years (3 Life Cycles)	7%	\$51,242	6	Simcoe (South)	\$37,320	6	Windsor (South)	\$51,004
7	Cambridge (South)	60 Years (3 Life Cycles)	7%	\$51,590	7	Hamilton (South)	\$37,633	7	Muskoka (Distinct)	\$51,258
8	London (South)	60 Years (3 Life Cycles)	7%	\$51,595	8	London (South)	\$37,967	8	Sarnia (South)	\$51,412
9	Guelph (South)	60 Years (3 Life Cycles)	7%	\$51,853	9	Cambridge (South)	\$37,981	9	Sault Ste. Marie (North)	\$51,406
10	Sault Ste. Marie (North)	60 Years (3 Life Cycles)	7%	\$53,251	10	Toronto (South)	\$38,007	10	Niagara Falls (South)	\$52,089
11	St. Catharines (South)	60 Years (3 Life Cycles)	7%	\$63,017	11	Guelph (South)	\$38,244	11	St. Catharines (South)	\$52,280
12	Toronto (South)	60 Years (3 Life Cycles)	7%	\$65,005	12	Mt. Forest (South)	\$38,710	12	Toronto (South)	\$52,406
13	Trenton (South)	60 Years (3 Life Cycles)	7%	\$65,214	13	Sault Ste. Marie (North)	\$39,675	13	Ottawa (Distinct)	\$52,872
14	Kitchener-Waterloo (South)	60 Years (3 Life Cycles)	7%	\$65,445	14	Trenton (South)	\$46,995	14	North Bay (North)	\$52,901
15	Mt. Forest (South)	60 Years (3 Life Cycles)	7%	\$65,605	15	Kitchener-Waterloo (South)	\$47,246	15	Hamilton (South)	\$53,050
16	Barrie (Distinct)	60 Years (3 Life Cycles)	7%	\$65,682	16	Barrie (Distinct)	\$47,451	16	Simcoe (South)	\$53,708
17	Ottawa (Distinct)	60 Years (3 Life Cycles)	7%	\$65,746	17	Ottawa (Distinct)	\$47,545	17	Peterborough (Distinct)	\$53,687
18	Kingston (South)	60 Years (3 Life Cycles)	7%	\$65,845	18	Kingston (South)	\$47,646	18	Mt. Forest (South)	\$53,692
19	Warton (South)	60 Years (3 Life Cycles)	7%	\$66,024	19	Warton (South)	\$47,799	19	Kitchener-Waterloo (South)	\$53,924
20	Peterborough (Distinct)	60 Years (3 Life Cycles)	7%	\$66,306	20	Peterborough (Distinct)	\$48,105	20	Warton (South)	\$55,043
21	North Bay (North)	60 Years (3 Life Cycles)	7%	\$66,431	21	Muskoka (Distinct)	\$48,206	21	Thunder Bay (North)	\$55,958
22	Muskoka (Distinct)	60 Years (3 Life Cycles)	7%	\$66,438	22	North Bay (North)	\$48,260	22	Trenton (South)	\$56,607
23	Sudbury (North)	60 Years (3 Life Cycles)	7%	\$67,174	23	Sudbury (North)	\$49,011	23	Kingston (South)	\$57,068
24	Timmins (North)	60 Years (3 Life Cycles)	7%	\$68,414	24	Timmins (North)	\$50,253	24	Sudbury (North)	\$57,070
25	Thunder Bay (North)	60 Years (3 Life Cycles)	7%	\$68,913	25	Thunder Bay (North)	\$50,726	25	Kenora (North)	\$57,016
26	Kenora (North)	60 Years (3 Life Cycles)	7%	\$69,298	26	Kenora (North)	\$51,081	26	Timmins (North)	\$57,554
27	Kapuskasing (North)	60 Years (3 Life Cycles)	7%	\$70,143	27	Kapuskasing (North)	\$51,933	27	Kapuskasing (North)	\$63,014

Table F2-1.46: Rankings of cities for rebates scenario (improved construction type) at a discount rate of 7% (three life cycles of V.GSHP and H.GSHP and five life cycles of Traditional HVAC Applications for a 60 year project lifespan)

FIT + Rebates – (#4)

Total Present Value										
(FIT+Rebates) - (#4)										
#	City	Project Life Span	Discount Rate	V.GSHP	#	City	H.GSHP	#	City	Traditional
1	Sarnia (South)	60 Years (3 Life Cycles)	7%	\$44,234	1	St. Catharines (South)	\$30,243	1	Cambridge (South)	\$47,171
2	Chatham (South)	60 Years (3 Life Cycles)	7%	\$44,391	2	Sarnia (South)	\$30,548	2	Guelph (South)	\$47,796
3	Windsor (South)	60 Years (3 Life Cycles)	7%	\$44,402	3	Chatham (South)	\$30,725	3	Barrie (Distinct)	\$49,495
4	Niagara Falls (South)	60 Years (3 Life Cycles)	7%	\$44,576	4	Windsor (South)	\$30,743	4	London (South)	\$50,222
5	Simcoe (South)	60 Years (3 Life Cycles)	7%	\$44,865	5	Niagara Falls (South)	\$30,915	5	Chatham (South)	\$50,963
6	Hamilton (South)	60 Years (3 Life Cycles)	7%	\$45,084	6	Simcoe (South)	\$31,204	6	Windsor (South)	\$51,004
7	Cambridge (South)	60 Years (3 Life Cycles)	7%	\$45,328	7	Hamilton (South)	\$31,423	7	Muskoka (Distinct)	\$51,258
8	London (South)	60 Years (3 Life Cycles)	7%	\$45,332	8	London (South)	\$31,658	8	Sarnia (South)	\$51,412
9	Guelph (South)	60 Years (3 Life Cycles)	7%	\$45,513	9	Cambridge (South)	\$31,668	9	Sault Ste. Marie (North)	\$51,406
10	Sault Ste. Marie (North)	60 Years (3 Life Cycles)	7%	\$46,494	10	Toronto (South)	\$31,686	10	Niagara Falls (South)	\$52,089
11	St. Catharines (South)	60 Years (3 Life Cycles)	7%	\$57,151	11	Guelph (South)	\$31,852	11	St. Catharines (South)	\$52,280
12	Toronto (South)	60 Years (3 Life Cycles)	7%	\$58,546	12	Mt. Forest (South)	\$32,179	12	Toronto (South)	\$52,406
13	Trenton (South)	60 Years (3 Life Cycles)	7%	\$58,693	13	Sault Ste. Marie (North)	\$32,856	13	Ottawa (Distinct)	\$52,872
14	Kitchener-Waterloo (South)	60 Years (3 Life Cycles)	7%	\$58,855	14	Trenton (South)	\$40,426	14	North Bay (North)	\$52,901
15	Mt. Forest (South)	60 Years (3 Life Cycles)	7%	\$58,967	15	Kitchener-Waterloo (South)	\$40,603	15	Hamilton (South)	\$53,050
16	Barrie (Distinct)	60 Years (3 Life Cycles)	7%	\$59,022	16	Barrie (Distinct)	\$40,747	16	Simcoe (South)	\$53,708
17	Ottawa (Distinct)	60 Years (3 Life Cycles)	7%	\$59,066	17	Ottawa (Distinct)	\$40,813	17	Peterborough (Distinct)	\$53,687
18	Kingston (South)	60 Years (3 Life Cycles)	7%	\$59,135	18	Kingston (South)	\$40,884	18	Mt. Forest (South)	\$53,692
19	Warton (South)	60 Years (3 Life Cycles)	7%	\$59,261	19	Warton (South)	\$40,991	19	Kitchener-Waterloo (South)	\$53,924
20	Peterborough (Distinct)	60 Years (3 Life Cycles)	7%	\$59,459	20	Peterborough (Distinct)	\$41,205	20	Warton (South)	\$55,043
21	North Bay (North)	60 Years (3 Life Cycles)	7%	\$59,546	21	Muskoka (Distinct)	\$41,276	21	Thunder Bay (North)	\$55,958
22	Muskoka (Distinct)	60 Years (3 Life Cycles)	7%	\$59,551	22	North Bay (North)	\$41,314	22	Trenton (South)	\$56,607
23	Sudbury (North)	60 Years (3 Life Cycles)	7%	\$60,068	23	Sudbury (North)	\$41,841	23	Kingston (South)	\$57,068
24	Timmins (North)	60 Years (3 Life Cycles)	7%	\$60,938	24	Timmins (North)	\$42,712	24	Sudbury (North)	\$57,070
25	Thunder Bay (North)	60 Years (3 Life Cycles)	7%	\$61,288	25	Thunder Bay (North)	\$43,044	25	Kenora (North)	\$57,016
26	Kenora (North)	60 Years (3 Life Cycles)	7%	\$61,559	26	Kenora (North)	\$43,293	26	Timmins (North)	\$57,554
27	Kapuskasing (North)	60 Years (3 Life Cycles)	7%	\$62,151	27	Kapuskasing (North)	\$43,891	27	Kapuskasing (North)	\$63,014

Table F2-1.47: Rankings of cities for feed-in tariff + rebates scenario (improved construction type) at a discount rate of 7% (three life cycles of V.GSHP and H.GSHP and five life cycles of Traditional HVAC Applications for a 60 year project lifespan)

(FIT + Rebates) + Carbon Taxes – (#5)

Total Present Value										
(FIT+Rebates) + Carbon Taxes - (#5)										
#	City	Project Life Span	Discount Rate	V.GSHP	#	City	H.GSHP	#	City	Traditional
1	Sarnia (South)	60 Years (3 Life Cycles)	7%	\$44,234	1	St. Catharines (South)	\$30,243	1	Cambridge (South)	\$58,270
2	Chatham (South)	60 Years (3 Life Cycles)	7%	\$44,391	2	Sarnia (South)	\$30,548	2	Guelph (South)	\$59,224
3	Windsor (South)	60 Years (3 Life Cycles)	7%	\$44,402	3	Chatham (South)	\$30,725	3	Chatham (South)	\$60,941
4	Niagara Falls (South)	60 Years (3 Life Cycles)	7%	\$44,576	4	Windsor (South)	\$30,743	4	Windsor (South)	\$61,007
5	Simcoe (South)	60 Years (3 Life Cycles)	7%	\$44,865	5	Niagara Falls (South)	\$30,915	5	Barrie (Distinct)	\$60,739
6	Hamilton (South)	60 Years (3 Life Cycles)	7%	\$45,084	6	Simcoe (South)	\$31,204	6	London (South)	\$61,321
7	Cambridge (South)	60 Years (3 Life Cycles)	7%	\$45,328	7	Hamilton (South)	\$31,423	7	Sarnia (South)	\$61,604
8	London (South)	60 Years (3 Life Cycles)	7%	\$45,332	8	London (South)	\$31,658	8	St. Catharines (South)	\$62,048
9	Guelph (South)	60 Years (3 Life Cycles)	7%	\$45,513	9	Cambridge (South)	\$31,668	9	Niagara Falls (South)	\$62,183
10	Sault Ste. Marie (North)	60 Years (3 Life Cycles)	7%	\$46,494	10	Toronto (South)	\$31,686	10	Toronto (South)	\$63,527
11	St. Catharines (South)	60 Years (3 Life Cycles)	7%	\$57,151	11	Guelph (South)	\$31,852	11	Muskoka (Distinct)	\$63,286
12	Toronto (South)	60 Years (3 Life Cycles)	7%	\$58,546	12	Mt. Forest (South)	\$32,179	12	Hamilton (South)	\$63,867
13	Trenton (South)	60 Years (3 Life Cycles)	7%	\$58,693	13	Sault Ste. Marie (North)	\$32,856	13	Simcoe (South)	\$64,286
14	Kitchener-Waterloo (South)	60 Years (3 Life Cycles)	7%	\$58,855	14	Trenton (South)	\$40,426	14	Sault Ste. Marie (North)	\$63,781
15	Mt. Forest (South)	60 Years (3 Life Cycles)	7%	\$58,967	15	Kitchener-Waterloo (South)	\$40,603	15	Ottawa (Distinct)	\$64,372
16	Barrie (Distinct)	60 Years (3 Life Cycles)	7%	\$59,022	16	Barrie (Distinct)	\$40,747	16	North Bay (North)	\$65,005
17	Ottawa (Distinct)	60 Years (3 Life Cycles)	7%	\$59,066	17	Ottawa (Distinct)	\$40,813	17	Kitchener-Waterloo (South)	\$65,377
18	Kingston (South)	60 Years (3 Life Cycles)	7%	\$59,135	18	Kingston (South)	\$40,884	18	Peterborough (Distinct)	\$65,676
19	Warton (South)	60 Years (3 Life Cycles)	7%	\$59,261	19	Warton (South)	\$40,991	19	Mt. Forest (South)	\$65,861
20	Peterborough (Distinct)	60 Years (3 Life Cycles)	7%	\$59,459	20	Peterborough (Distinct)	\$41,205	20	Warton (South)	\$66,916
21	North Bay (North)	60 Years (3 Life Cycles)	7%	\$59,546	21	Muskoka (Distinct)	\$41,276	21	Trenton (South)	\$67,800
22	Muskoka (Distinct)	60 Years (3 Life Cycles)	7%	\$59,551	22	North Bay (North)	\$41,314	22	Kingston (South)	\$68,587
23	Sudbury (North)	60 Years (3 Life Cycles)	7%	\$60,068	23	Sudbury (North)	\$41,841	23	Thunder Bay (North)	\$69,664
24	Timmins (North)	60 Years (3 Life Cycles)	7%	\$60,938	24	Timmins (North)	\$42,712	24	Sudbury (North)	\$70,043
25	Thunder Bay (North)	60 Years (3 Life Cycles)	7%	\$61,288	25	Thunder Bay (North)	\$43,044	25	Kenora (North)	\$70,903
26	Kenora (North)	60 Years (3 Life Cycles)	7%	\$61,559	26	Kenora (North)	\$43,293	26	Timmins (North)	\$71,829
27	Kapuskasing (North)	60 Years (3 Life Cycles)	7%	\$62,151	27	Kapuskasing (North)	\$43,891	27	Kapuskasing (North)	\$77,813

Table F2-1.48: Rankings of cities for feed-in tariff + rebates + carbon tax scenario (improved construction type) at a discount rate of 7% (three life cycles of V.GSHP and H.GSHP and five life cycles of Traditional HVAC Applications for a 60 year project lifespan)

9. Three Life Cycles of V.GSHP and H.GSHP and Five Life Cycles of Traditional HVAC Applications @ 7.5% Discount Rate

Base Case Scenario

Total Present Value										
Base Case Scenario										
#	City	Project Life Span	Discount Rate	V.GSHP	#	City	H.GSHP	#	City	Traditional
1	Sarnia (South)	60 Years (3 Life Cycles)	7.5%	\$54,874	1	St. Catharines (South)	\$41,347	1	Cambridge (South)	\$44,213
2	Chatham (South)	60 Years (3 Life Cycles)	7.5%	\$55,082	2	Sarnia (South)	\$41,754	2	Guelph (South)	\$44,795
3	Windsor (South)	60 Years (3 Life Cycles)	7.5%	\$55,098	3	Chatham (South)	\$41,989	3	Barrie (Distinct)	\$46,399
4	Niagara Falls (South)	60 Years (3 Life Cycles)	7.5%	\$55,329	4	Windsor (South)	\$42,013	4	London (South)	\$47,078
5	Simcoe (South)	60 Years (3 Life Cycles)	7.5%	\$55,713	5	Niagara Falls (South)	\$42,242	5	Chatham (South)	\$47,791
6	Hamilton (South)	60 Years (3 Life Cycles)	7.5%	\$56,006	6	Simcoe (South)	\$42,626	6	Windsor (South)	\$47,829
7	Cambridge (South)	60 Years (3 Life Cycles)	7.5%	\$56,331	7	Hamilton (South)	\$42,919	7	Muskoka (Distinct)	\$48,042
8	London (South)	60 Years (3 Life Cycles)	7.5%	\$56,335	8	London (South)	\$43,231	8	Sarnia (South)	\$48,210
9	Guelph (South)	60 Years (3 Life Cycles)	7.5%	\$56,577	9	Cambridge (South)	\$43,244	9	Sault Ste. Marie (North)	\$48,179
10	Sault Ste. Marie (North)	60 Years (3 Life Cycles)	7.5%	\$57,883	10	Toronto (South)	\$43,268	10	Niagara Falls (South)	\$48,843
11	St. Catharines (South)	60 Years (3 Life Cycles)	7.5%	\$67,333	11	Guelph (South)	\$43,490	11	St. Catharines (South)	\$49,022
12	Toronto (South)	60 Years (3 Life Cycles)	7.5%	\$69,190	12	Mt. Forest (South)	\$43,925	12	Toronto (South)	\$49,134
13	Trenton (South)	60 Years (3 Life Cycles)	7.5%	\$69,386	13	Sault Ste. Marie (North)	\$44,826	13	Ottawa (Distinct)	\$49,568
14	Kitchener-Waterloo (South)	60 Years (3 Life Cycles)	7.5%	\$69,601	14	Trenton (South)	\$51,867	14	North Bay (North)	\$49,592
15	Mt. Forest (South)	60 Years (3 Life Cycles)	7.5%	\$69,751	15	Kitchener-Waterloo (South)	\$52,102	15	Hamilton (South)	\$49,737
16	Barrie (Distinct)	60 Years (3 Life Cycles)	7.5%	\$69,823	16	Barrie (Distinct)	\$52,293	16	Simcoe (South)	\$50,368
17	Ottawa (Distinct)	60 Years (3 Life Cycles)	7.5%	\$69,883	17	Ottawa (Distinct)	\$52,381	17	Peterborough (Distinct)	\$50,327
18	Kingston (South)	60 Years (3 Life Cycles)	7.5%	\$69,975	18	Kingston (South)	\$52,476	18	Mt. Forest (South)	\$50,331
19	Warton (South)	60 Years (3 Life Cycles)	7.5%	\$70,142	19	Warton (South)	\$52,619	19	Kitchener-Waterloo (South)	\$50,550
20	Peterborough (Distinct)	60 Years (3 Life Cycles)	7.5%	\$70,406	20	Peterborough (Distinct)	\$52,904	20	Warton (South)	\$51,609
21	North Bay (North)	60 Years (3 Life Cycles)	7.5%	\$70,522	21	Muskoka (Distinct)	\$52,999	21	Thunder Bay (North)	\$52,441
22	Muskoka (Distinct)	60 Years (3 Life Cycles)	7.5%	\$70,529	22	North Bay (North)	\$53,050	22	Trenton (South)	\$53,089
23	Sudbury (North)	60 Years (3 Life Cycles)	7.5%	\$71,217	23	Sudbury (North)	\$53,751	23	Kingston (South)	\$53,519
24	Timmins (North)	60 Years (3 Life Cycles)	7.5%	\$72,375	24	Timmins (North)	\$54,911	24	Sudbury (North)	\$53,499
25	Thunder Bay (North)	60 Years (3 Life Cycles)	7.5%	\$72,841	25	Thunder Bay (North)	\$55,353	25	Kenora (North)	\$53,428
26	Kenora (North)	60 Years (3 Life Cycles)	7.5%	\$73,201	26	Kenora (North)	\$55,685	26	Timmins (North)	\$53,930
27	Kapuskasing (North)	60 Years (3 Life Cycles)	7.5%	\$73,991	27	Kapuskasing (North)	\$56,480	27	Kapuskasing (North)	\$59,059

Table F2-1.49: Rankings of cities for base case scenario (improved construction type) at a discount rate of 7.5% (three life cycles of V.GSHP and H.GSHP and five life cycles of Traditional HVAC Applications for a 60 year project lifespan)

Carbon Taxes – (#1)

Total Present Value										
Carbon Taxes - (#1)										
#	City	Project Life Span	Discount Rate	V.GSHP	#	City	H.GSHP	#	City	Traditional
1	Sarnia (South)	60 Years (3 Life Cycles)	7.5%	\$54,874	1	St. Catharines (South)	\$41,347	1	Cambridge (South)	\$54,110
2	Chatham (South)	60 Years (3 Life Cycles)	7.5%	\$55,082	2	Sarnia (South)	\$41,754	2	Guelph (South)	\$54,986
3	Windsor (South)	60 Years (3 Life Cycles)	7.5%	\$55,098	3	Chatham (South)	\$41,989	3	Barrie (Distinct)	\$56,426
4	Niagara Falls (South)	60 Years (3 Life Cycles)	7.5%	\$55,329	4	Windsor (South)	\$42,013	4	Chatham (South)	\$56,689
5	Simcoe (South)	60 Years (3 Life Cycles)	7.5%	\$55,713	5	Niagara Falls (South)	\$42,242	5	Windsor (South)	\$56,749
6	Hamilton (South)	60 Years (3 Life Cycles)	7.5%	\$56,006	6	Simcoe (South)	\$42,626	6	London (South)	\$56,976
7	Cambridge (South)	60 Years (3 Life Cycles)	7.5%	\$56,331	7	Hamilton (South)	\$42,919	7	Sarnia (South)	\$57,298
8	London (South)	60 Years (3 Life Cycles)	7.5%	\$56,335	8	London (South)	\$43,231	8	St. Catharines (South)	\$57,733
9	Guelph (South)	60 Years (3 Life Cycles)	7.5%	\$56,577	9	Cambridge (South)	\$43,244	9	Niagara Falls (South)	\$57,844
10	Sault Ste. Marie (North)	60 Years (3 Life Cycles)	7.5%	\$57,883	10	Toronto (South)	\$43,268	10	Muskoka (Distinct)	\$58,769
11	St. Catharines (South)	60 Years (3 Life Cycles)	7.5%	\$67,333	11	Guelph (South)	\$43,490	11	Toronto (South)	\$59,051
12	Toronto (South)	60 Years (3 Life Cycles)	7.5%	\$69,190	12	Mt. Forest (South)	\$43,925	12	Sault Ste. Marie (North)	\$59,215
13	Trenton (South)	60 Years (3 Life Cycles)	7.5%	\$69,386	13	Sault Ste. Marie (North)	\$44,826	13	Hamilton (South)	\$59,383
14	Kitchener-Waterloo (South)	60 Years (3 Life Cycles)	7.5%	\$69,601	14	Trenton (South)	\$51,867	14	Simcoe (South)	\$59,801
15	Mt. Forest (South)	60 Years (3 Life Cycles)	7.5%	\$69,751	15	Kitchener-Waterloo (South)	\$52,102	15	Ottawa (Distinct)	\$59,823
16	Barrie (Distinct)	60 Years (3 Life Cycles)	7.5%	\$69,823	16	Barrie (Distinct)	\$52,293	16	North Bay (North)	\$60,386
17	Ottawa (Distinct)	60 Years (3 Life Cycles)	7.5%	\$69,883	17	Ottawa (Distinct)	\$52,381	17	Kitchener-Waterloo (South)	\$60,764
18	Kingston (South)	60 Years (3 Life Cycles)	7.5%	\$69,975	18	Kingston (South)	\$52,476	18	Peterborough (Distinct)	\$61,018
19	Warton (South)	60 Years (3 Life Cycles)	7.5%	\$70,142	19	Warton (South)	\$52,619	19	Mt. Forest (South)	\$61,183
20	Peterborough (Distinct)	60 Years (3 Life Cycles)	7.5%	\$70,406	20	Peterborough (Distinct)	\$52,904	20	Warton (South)	\$62,197
21	North Bay (North)	60 Years (3 Life Cycles)	7.5%	\$70,522	21	Muskoka (Distinct)	\$52,999	21	Trenton (South)	\$63,071
22	Muskoka (Distinct)	60 Years (3 Life Cycles)	7.5%	\$70,529	22	North Bay (North)	\$53,050	22	Kingston (South)	\$63,791
23	Sudbury (North)	60 Years (3 Life Cycles)	7.5%	\$71,217	23	Sudbury (North)	\$53,751	23	Thunder Bay (North)	\$64,664
24	Timmins (North)	60 Years (3 Life Cycles)	7.5%	\$72,375	24	Timmins (North)	\$54,911	24	Sudbury (North)	\$65,067
25	Thunder Bay (North)	60 Years (3 Life Cycles)	7.5%	\$72,841	25	Thunder Bay (North)	\$55,353	25	Kenora (North)	\$65,813
26	Kenora (North)	60 Years (3 Life Cycles)	7.5%	\$73,201	26	Kenora (North)	\$55,685	26	Timmins (North)	\$66,659
27	Kapuskasing (North)	60 Years (3 Life Cycles)	7.5%	\$73,991	27	Kapuskasing (North)	\$56,480	27	Kapuskasing (North)	\$72,256

Table F2-1.50: Rankings of cities for carbon taxes scenario (improved construction type) at a discount rate of 7.5% (three life cycles of V.GSHP and H.GSHP and five life cycles of Traditional HVAC Applications for a 60 year project lifespan)

FIT – (#2)

Total Present Value										
FIT - (#2)										
#	City	Project Life Span	Discount Rate	V.GSHP	#	City	H.GSHP	#	City	Traditional
1	Sarnia (South)	60 Years (3 Life Cycles)	7.5%	\$49,441	1	St. Catharines (South)	\$35,997	1	Cambridge (South)	\$44,213
2	Chatham (South)	60 Years (3 Life Cycles)	7.5%	\$49,587	2	Sarnia (South)	\$36,282	2	Guelph (South)	\$44,795
3	Windsor (South)	60 Years (3 Life Cycles)	7.5%	\$49,598	3	Chatham (South)	\$36,447	3	Barrie (Distinct)	\$46,399
4	Niagara Falls (South)	60 Years (3 Life Cycles)	7.5%	\$49,760	4	Windsor (South)	\$36,464	4	London (South)	\$47,078
5	Simcoe (South)	60 Years (3 Life Cycles)	7.5%	\$50,029	5	Niagara Falls (South)	\$36,624	5	Chatham (South)	\$47,791
6	Hamilton (South)	60 Years (3 Life Cycles)	7.5%	\$50,234	6	Simcoe (South)	\$36,893	6	Windsor (South)	\$47,829
7	Cambridge (South)	60 Years (3 Life Cycles)	7.5%	\$50,462	7	Hamilton (South)	\$37,098	7	Muskoka (Distinct)	\$48,042
8	London (South)	60 Years (3 Life Cycles)	7.5%	\$50,465	8	London (South)	\$37,317	8	Sarnia (South)	\$48,210
9	Guelph (South)	60 Years (3 Life Cycles)	7.5%	\$50,634	9	Cambridge (South)	\$37,326	9	Sault Ste. Marie (North)	\$48,179
10	Sault Ste. Marie (North)	60 Years (3 Life Cycles)	7.5%	\$51,549	10	Toronto (South)	\$37,343	10	Niagara Falls (South)	\$48,843
11	St. Catharines (South)	60 Years (3 Life Cycles)	7.5%	\$61,835	11	Guelph (South)	\$37,499	11	St. Catharines (South)	\$49,022
12	Toronto (South)	60 Years (3 Life Cycles)	7.5%	\$63,136	12	Mt. Forest (South)	\$37,803	12	Toronto (South)	\$49,134
13	Trenton (South)	60 Years (3 Life Cycles)	7.5%	\$63,273	13	Sault Ste. Marie (North)	\$38,435	13	Ottawa (Distinct)	\$49,568
14	Kitchener-Waterloo (South)	60 Years (3 Life Cycles)	7.5%	\$63,424	14	Trenton (South)	\$45,710	14	North Bay (North)	\$49,592
15	Mt. Forest (South)	60 Years (3 Life Cycles)	7.5%	\$63,529	15	Kitchener-Waterloo (South)	\$45,875	15	Hamilton (South)	\$49,737
16	Barrie (Distinct)	60 Years (3 Life Cycles)	7.5%	\$63,580	16	Barrie (Distinct)	\$46,009	16	Simcoe (South)	\$50,368
17	Ottawa (Distinct)	60 Years (3 Life Cycles)	7.5%	\$63,621	17	Ottawa (Distinct)	\$46,071	17	Peterborough (Distinct)	\$50,327
18	Kingston (South)	60 Years (3 Life Cycles)	7.5%	\$63,686	18	Kingston (South)	\$46,137	18	Mt. Forest (South)	\$50,331
19	Warton (South)	60 Years (3 Life Cycles)	7.5%	\$63,803	19	Warton (South)	\$46,237	19	Kitchener-Waterloo (South)	\$50,550
20	Peterborough (Distinct)	60 Years (3 Life Cycles)	7.5%	\$63,988	20	Peterborough (Distinct)	\$46,437	20	Warton (South)	\$51,609
21	North Bay (North)	60 Years (3 Life Cycles)	7.5%	\$64,070	21	Muskoka (Distinct)	\$46,504	21	Thunder Bay (North)	\$52,441
22	Muskoka (Distinct)	60 Years (3 Life Cycles)	7.5%	\$64,074	22	North Bay (North)	\$46,539	22	Trenton (South)	\$53,089
23	Sudbury (North)	60 Years (3 Life Cycles)	7.5%	\$64,556	23	Sudbury (North)	\$47,030	23	Kingston (South)	\$53,519
24	Timmins (North)	60 Years (3 Life Cycles)	7.5%	\$65,368	24	Timmins (North)	\$47,843	24	Sudbury (North)	\$53,499
25	Thunder Bay (North)	60 Years (3 Life Cycles)	7.5%	\$65,694	25	Thunder Bay (North)	\$48,153	25	Kenora (North)	\$53,428
26	Kenora (North)	60 Years (3 Life Cycles)	7.5%	\$65,947	26	Kenora (North)	\$48,385	26	Timmins (North)	\$53,930
27	Kapuskasing (North)	60 Years (3 Life Cycles)	7.5%	\$66,500	27	Kapuskasing (North)	\$48,943	27	Kapuskasing (North)	\$59,059

Table F2-1.51: Rankings of cities for feed-in tariff scenario (improved construction type) at a discount rate of 7.5% (three life cycles of V.GSHP and H.GSHP and five life cycles of Traditional HVAC Applications for a 60 year project lifespan)

Rebates – (#3)

Total Present Value										
Rebates - (#3)										
#	City	Project Life Span	Discount Rate	V.GSHP	#	City	H.GSHP	#	City	Traditional
1	Sarnia (South)	60 Years (3 Life Cycles)	7.5%	\$47,513	1	St. Catharines (South)	\$33,986	1	Cambridge (South)	\$44,213
2	Chatham (South)	60 Years (3 Life Cycles)	7.5%	\$47,722	2	Sarnia (South)	\$34,393	2	Guelph (South)	\$44,795
3	Windsor (South)	60 Years (3 Life Cycles)	7.5%	\$47,737	3	Chatham (South)	\$34,628	3	Barrie (Distinct)	\$46,399
4	Niagara Falls (South)	60 Years (3 Life Cycles)	7.5%	\$47,968	4	Windsor (South)	\$34,652	4	London (South)	\$47,078
5	Simcoe (South)	60 Years (3 Life Cycles)	7.5%	\$48,352	5	Niagara Falls (South)	\$34,881	5	Chatham (South)	\$47,791
6	Hamilton (South)	60 Years (3 Life Cycles)	7.5%	\$48,645	6	Simcoe (South)	\$35,265	6	Windsor (South)	\$47,829
7	Cambridge (South)	60 Years (3 Life Cycles)	7.5%	\$48,970	7	Hamilton (South)	\$35,558	7	Muskoka (Distinct)	\$48,042
8	London (South)	60 Years (3 Life Cycles)	7.5%	\$48,974	8	London (South)	\$35,870	8	Sarnia (South)	\$48,210
9	Guelph (South)	60 Years (3 Life Cycles)	7.5%	\$49,216	9	Cambridge (South)	\$35,883	9	Sault Ste. Marie (North)	\$48,179
10	Sault Ste. Marie (North)	60 Years (3 Life Cycles)	7.5%	\$50,522	10	Toronto (South)	\$35,907	10	Niagara Falls (South)	\$48,843
11	St. Catharines (South)	60 Years (3 Life Cycles)	7.5%	\$59,972	11	Guelph (South)	\$36,129	11	St. Catharines (South)	\$49,022
12	Toronto (South)	60 Years (3 Life Cycles)	7.5%	\$61,830	12	Mt. Forest (South)	\$36,564	12	Toronto (South)	\$49,134
13	Trenton (South)	60 Years (3 Life Cycles)	7.5%	\$62,025	13	Sault Ste. Marie (North)	\$37,465	13	Ottawa (Distinct)	\$49,568
14	Kitchener-Waterloo (South)	60 Years (3 Life Cycles)	7.5%	\$62,241	14	Trenton (South)	\$44,506	14	North Bay (North)	\$49,592
15	Mt. Forest (South)	60 Years (3 Life Cycles)	7.5%	\$62,390	15	Kitchener-Waterloo (South)	\$44,741	15	Hamilton (South)	\$49,737
16	Barrie (Distinct)	60 Years (3 Life Cycles)	7.5%	\$62,462	16	Barrie (Distinct)	\$44,933	16	Simcoe (South)	\$50,368
17	Ottawa (Distinct)	60 Years (3 Life Cycles)	7.5%	\$62,522	17	Ottawa (Distinct)	\$45,021	17	Peterborough (Distinct)	\$50,327
18	Kingston (South)	60 Years (3 Life Cycles)	7.5%	\$62,614	18	Kingston (South)	\$45,115	18	Mt. Forest (South)	\$50,331
19	Warton (South)	60 Years (3 Life Cycles)	7.5%	\$62,781	19	Warton (South)	\$45,258	19	Kitchener-Waterloo (South)	\$50,550
20	Peterborough (Distinct)	60 Years (3 Life Cycles)	7.5%	\$63,045	20	Peterborough (Distinct)	\$45,544	20	Warton (South)	\$51,609
21	North Bay (North)	60 Years (3 Life Cycles)	7.5%	\$63,161	21	Muskoka (Distinct)	\$45,638	21	Thunder Bay (North)	\$52,441
22	Muskoka (Distinct)	60 Years (3 Life Cycles)	7.5%	\$63,168	22	North Bay (North)	\$45,689	22	Trenton (South)	\$53,089
23	Sudbury (North)	60 Years (3 Life Cycles)	7.5%	\$63,856	23	Sudbury (North)	\$46,390	23	Kingston (South)	\$53,519
24	Timmins (North)	60 Years (3 Life Cycles)	7.5%	\$65,014	24	Timmins (North)	\$47,550	24	Sudbury (North)	\$53,499
25	Thunder Bay (North)	60 Years (3 Life Cycles)	7.5%	\$65,480	25	Thunder Bay (North)	\$47,992	25	Kenora (North)	\$53,428
26	Kenora (North)	60 Years (3 Life Cycles)	7.5%	\$65,841	26	Kenora (North)	\$48,324	26	Timmins (North)	\$53,930
27	Kapuskasing (North)	60 Years (3 Life Cycles)	7.5%	\$66,630	27	Kapuskasing (North)	\$49,120	27	Kapuskasing (North)	\$59,059

Table F2-1.52: Rankings of cities for rebates scenario (improved construction type) at a discount rate of 7.5% (three life cycles of V.GSHP and H.GSHP and five life cycles of Traditional HVAC Applications for a 60 year project lifespan)

FIT + Rebates – (#4)

Total Present Value										
(FIT+Rebates) - (#4)										
#	City	Project Life Span	Discount Rate	V.GSHP	#	City	H.GSHP	#	City	Traditional
1	Sarnia (South)	60 Years (3 Life Cycles)	7.5%	\$42,080	1	St. Catharines (South)	\$28,636	1	Cambridge (South)	\$44,213
2	Chatham (South)	60 Years (3 Life Cycles)	7.5%	\$42,226	2	Sarnia (South)	\$28,921	2	Guelph (South)	\$44,795
3	Windsor (South)	60 Years (3 Life Cycles)	7.5%	\$42,237	3	Chatham (South)	\$29,086	3	Barrie (Distinct)	\$46,399
4	Niagara Falls (South)	60 Years (3 Life Cycles)	7.5%	\$42,399	4	Windsor (South)	\$29,103	4	London (South)	\$47,078
5	Simcoe (South)	60 Years (3 Life Cycles)	7.5%	\$42,668	5	Niagara Falls (South)	\$29,263	5	Chatham (South)	\$47,791
6	Hamilton (South)	60 Years (3 Life Cycles)	7.5%	\$42,873	6	Simcoe (South)	\$29,532	6	Windsor (South)	\$47,829
7	Cambridge (South)	60 Years (3 Life Cycles)	7.5%	\$43,101	7	Hamilton (South)	\$29,737	7	Muskoka (Distinct)	\$48,042
8	London (South)	60 Years (3 Life Cycles)	7.5%	\$43,104	8	London (South)	\$29,956	8	Sarnia (South)	\$48,210
9	Guelph (South)	60 Years (3 Life Cycles)	7.5%	\$43,273	9	Cambridge (South)	\$29,965	9	Sault Ste. Marie (North)	\$48,179
10	Sault Ste. Marie (North)	60 Years (3 Life Cycles)	7.5%	\$44,188	10	Toronto (South)	\$29,982	10	Niagara Falls (South)	\$48,843
11	St. Catharines (South)	60 Years (3 Life Cycles)	7.5%	\$54,474	11	Guelph (South)	\$30,138	11	St. Catharines (South)	\$49,022
12	Toronto (South)	60 Years (3 Life Cycles)	7.5%	\$55,776	12	Mt. Forest (South)	\$30,443	12	Toronto (South)	\$49,134
13	Trenton (South)	60 Years (3 Life Cycles)	7.5%	\$55,913	13	Sault Ste. Marie (North)	\$31,074	13	Ottawa (Distinct)	\$49,568
14	Kitchener-Waterloo (South)	60 Years (3 Life Cycles)	7.5%	\$56,063	14	Trenton (South)	\$38,350	14	North Bay (North)	\$49,592
15	Mt. Forest (South)	60 Years (3 Life Cycles)	7.5%	\$56,168	15	Kitchener-Waterloo (South)	\$38,514	15	Hamilton (South)	\$49,737
16	Barrie (Distinct)	60 Years (3 Life Cycles)	7.5%	\$56,219	16	Barrie (Distinct)	\$38,648	16	Simcoe (South)	\$50,368
17	Ottawa (Distinct)	60 Years (3 Life Cycles)	7.5%	\$56,261	17	Ottawa (Distinct)	\$38,710	17	Peterborough (Distinct)	\$50,327
18	Kingston (South)	60 Years (3 Life Cycles)	7.5%	\$56,325	18	Kingston (South)	\$38,776	18	Mt. Forest (South)	\$50,331
19	Warton (South)	60 Years (3 Life Cycles)	7.5%	\$56,442	19	Warton (South)	\$38,876	19	Kitchener-Waterloo (South)	\$50,550
20	Peterborough (Distinct)	60 Years (3 Life Cycles)	7.5%	\$56,627	20	Peterborough (Distinct)	\$39,076	20	Warton (South)	\$51,609
21	North Bay (North)	60 Years (3 Life Cycles)	7.5%	\$56,709	21	Muskoka (Distinct)	\$39,143	21	Thunder Bay (North)	\$52,441
22	Muskoka (Distinct)	60 Years (3 Life Cycles)	7.5%	\$56,713	22	North Bay (North)	\$39,178	22	Trenton (South)	\$53,089
23	Sudbury (North)	60 Years (3 Life Cycles)	7.5%	\$57,195	23	Sudbury (North)	\$39,669	23	Kingston (South)	\$53,519
24	Timmins (North)	60 Years (3 Life Cycles)	7.5%	\$58,007	24	Timmins (North)	\$40,482	24	Sudbury (North)	\$53,499
25	Thunder Bay (North)	60 Years (3 Life Cycles)	7.5%	\$58,333	25	Thunder Bay (North)	\$40,792	25	Kenora (North)	\$53,428
26	Kenora (North)	60 Years (3 Life Cycles)	7.5%	\$58,586	26	Kenora (North)	\$41,024	26	Timmins (North)	\$53,930
27	Kapuskasing (North)	60 Years (3 Life Cycles)	7.5%	\$59,139	27	Kapuskasing (North)	\$41,582	27	Kapuskasing (North)	\$59,059

Table F2-1.53: Rankings of cities for feed-in tariff + rebates scenario (improved construction type) at a discount rate of 7.5% (three life cycles of V.GSHP and H.GSHP and five life cycles of Traditional HVAC Applications for a 60 year project lifespan)

(FIT + Rebates) + Carbon Taxes – (#5)

Total Present Value										
(FIT+Rebates) + Carbon Taxes - (#5)										
#	City	Project Life Span	Discount Rate	V.GSHP	#	City	H.GSHP	#	City	Traditional
1	Sarnia (South)	60 Years (3 Life Cycles)	7.5%	\$42,080	1	St. Catharines (South)	\$28,636	1	Cambridge (South)	\$54,110
2	Chatham (South)	60 Years (3 Life Cycles)	7.5%	\$42,226	2	Sarnia (South)	\$28,921	2	Guelph (South)	\$54,986
3	Windsor (South)	60 Years (3 Life Cycles)	7.5%	\$42,237	3	Chatham (South)	\$29,086	3	Barrie (Distinct)	\$56,426
4	Niagara Falls (South)	60 Years (3 Life Cycles)	7.5%	\$42,399	4	Windsor (South)	\$29,103	4	Chatham (South)	\$56,689
5	Simcoe (South)	60 Years (3 Life Cycles)	7.5%	\$42,668	5	Niagara Falls (South)	\$29,263	5	Windsor (South)	\$56,749
6	Hamilton (South)	60 Years (3 Life Cycles)	7.5%	\$42,873	6	Simcoe (South)	\$29,532	6	London (South)	\$56,976
7	Cambridge (South)	60 Years (3 Life Cycles)	7.5%	\$43,101	7	Hamilton (South)	\$29,737	7	Sarnia (South)	\$57,298
8	London (South)	60 Years (3 Life Cycles)	7.5%	\$43,104	8	London (South)	\$29,956	8	St. Catharines (South)	\$57,733
9	Guelph (South)	60 Years (3 Life Cycles)	7.5%	\$43,273	9	Cambridge (South)	\$29,965	9	Niagara Falls (South)	\$57,844
10	Sault Ste. Marie (North)	60 Years (3 Life Cycles)	7.5%	\$44,188	10	Toronto (South)	\$29,982	10	Muskoka (Distinct)	\$58,769
11	St. Catharines (South)	60 Years (3 Life Cycles)	7.5%	\$54,474	11	Guelph (South)	\$30,138	11	Toronto (South)	\$59,051
12	Toronto (South)	60 Years (3 Life Cycles)	7.5%	\$55,776	12	Mt. Forest (South)	\$30,443	12	Sault Ste. Marie (North)	\$59,215
13	Trenton (South)	60 Years (3 Life Cycles)	7.5%	\$55,913	13	Sault Ste. Marie (North)	\$31,074	13	Hamilton (South)	\$59,383
14	Kitchener-Waterloo (South)	60 Years (3 Life Cycles)	7.5%	\$56,063	14	Trenton (South)	\$38,350	14	Simcoe (South)	\$59,801
15	Mt. Forest (South)	60 Years (3 Life Cycles)	7.5%	\$56,168	15	Kitchener-Waterloo (South)	\$38,514	15	Ottawa (Distinct)	\$59,823
16	Barrie (Distinct)	60 Years (3 Life Cycles)	7.5%	\$56,219	16	Barrie (Distinct)	\$38,648	16	North Bay (North)	\$60,386
17	Ottawa (Distinct)	60 Years (3 Life Cycles)	7.5%	\$56,261	17	Ottawa (Distinct)	\$38,710	17	Kitchener-Waterloo (South)	\$60,764
18	Kingston (South)	60 Years (3 Life Cycles)	7.5%	\$56,325	18	Kingston (South)	\$38,776	18	Peterborough (Distinct)	\$61,018
19	Warton (South)	60 Years (3 Life Cycles)	7.5%	\$56,442	19	Warton (South)	\$38,876	19	Mt. Forest (South)	\$61,183
20	Peterborough (Distinct)	60 Years (3 Life Cycles)	7.5%	\$56,627	20	Peterborough (Distinct)	\$39,076	20	Warton (South)	\$62,197
21	North Bay (North)	60 Years (3 Life Cycles)	7.5%	\$56,709	21	Muskoka (Distinct)	\$39,143	21	Trenton (South)	\$63,071
22	Muskoka (Distinct)	60 Years (3 Life Cycles)	7.5%	\$56,713	22	North Bay (North)	\$39,178	22	Kingston (South)	\$63,791
23	Sudbury (North)	60 Years (3 Life Cycles)	7.5%	\$57,195	23	Sudbury (North)	\$39,669	23	Thunder Bay (North)	\$64,664
24	Timmins (North)	60 Years (3 Life Cycles)	7.5%	\$58,007	24	Timmins (North)	\$40,482	24	Sudbury (North)	\$65,067
25	Thunder Bay (North)	60 Years (3 Life Cycles)	7.5%	\$58,333	25	Thunder Bay (North)	\$40,792	25	Kenora (North)	\$65,813
26	Kenora (North)	60 Years (3 Life Cycles)	7.5%	\$58,586	26	Kenora (North)	\$41,024	26	Timmins (North)	\$66,659
27	Kapuskasing (North)	60 Years (3 Life Cycles)	7.5%	\$59,139	27	Kapuskasing (North)	\$41,582	27	Kapuskasing (North)	\$72,256

Table F2-1.54: Rankings of cities for feed-in tariff + rebates + carbon tax scenario (improved construction type) at a discount rate of 7.5% (three life cycles of V.GSHP and H.GSHP and five life cycles of Traditional HVAC Applications for a 60 year project lifespan)

10. Three Life Cycles of V.GSHP and H.GSHP and Five Life Cycles of Traditional HVAC Applications @ 8.5% Discount Rate

Base Case Scenario

Total Present Value										
Base Case Scenario										
#	City	Project Life Span	Discount Rate	V.GSHP	#	City	H.GSHP	#	City	Traditional
1	Sarnia (South)	60 Years (3 Life Cycles)	8.5%	\$50,220	1	St. Catharines (South)	\$37,599	1	Cambridge (South)	\$39,315
2	Chatham (South)	60 Years (3 Life Cycles)	8.5%	\$50,404	2	Sarnia (South)	\$37,958	2	Guelph (South)	\$39,826
3	Windsor (South)	60 Years (3 Life Cycles)	8.5%	\$50,417	3	Chatham (South)	\$38,165	3	Barrie (Distinct)	\$41,273
4	Niagara Falls (South)	60 Years (3 Life Cycles)	8.5%	\$50,621	4	Windsor (South)	\$38,186	4	London (South)	\$41,873
5	Simcoe (South)	60 Years (3 Life Cycles)	8.5%	\$50,960	5	Niagara Falls (South)	\$38,388	5	Chatham (South)	\$42,540
6	Hamilton (South)	60 Years (3 Life Cycles)	8.5%	\$51,218	6	Simcoe (South)	\$38,727	6	Windsor (South)	\$42,573
7	Cambridge (South)	60 Years (3 Life Cycles)	8.5%	\$51,505	7	Hamilton (South)	\$38,985	7	Muskoka (Distinct)	\$42,717
8	London (South)	60 Years (3 Life Cycles)	8.5%	\$51,509	8	London (South)	\$39,260	8	Sarnia (South)	\$42,908
9	Guelph (South)	60 Years (3 Life Cycles)	8.5%	\$51,722	9	Cambridge (South)	\$39,272	9	Sault Ste. Marie (North)	\$42,835
10	Sault Ste. Marie (North)	60 Years (3 Life Cycles)	8.5%	\$52,874	10	Toronto (South)	\$39,293	10	Niagara Falls (South)	\$43,467
11	St. Catharines (South)	60 Years (3 Life Cycles)	8.5%	\$61,816	11	Guelph (South)	\$39,489	11	St. Catharines (South)	\$43,627
12	Toronto (South)	60 Years (3 Life Cycles)	8.5%	\$63,454	12	Mt. Forest (South)	\$39,873	12	Toronto (South)	\$43,717
13	Trenton (South)	60 Years (3 Life Cycles)	8.5%	\$63,626	13	Sault Ste. Marie (North)	\$40,668	13	Ottawa (Distinct)	\$44,097
14	Kitchener-Waterloo (South)	60 Years (3 Life Cycles)	8.5%	\$63,816	14	Trenton (South)	\$47,254	14	North Bay (North)	\$44,114
15	Mt. Forest (South)	60 Years (3 Life Cycles)	8.5%	\$63,948	15	Kitchener-Waterloo (South)	\$47,462	15	Hamilton (South)	\$44,251
16	Barrie (Distinct)	60 Years (3 Life Cycles)	8.5%	\$64,012	16	Barrie (Distinct)	\$47,630	16	Simcoe (South)	\$44,840
17	Ottawa (Distinct)	60 Years (3 Life Cycles)	8.5%	\$64,064	17	Ottawa (Distinct)	\$47,708	17	Peterborough (Distinct)	\$44,764
18	Kingston (South)	60 Years (3 Life Cycles)	8.5%	\$64,146	18	Kingston (South)	\$47,791	18	Mt. Forest (South)	\$44,765
19	Warton (South)	60 Years (3 Life Cycles)	8.5%	\$64,293	19	Warton (South)	\$47,917	19	Kitchener-Waterloo (South)	\$44,964
20	Peterborough (Distinct)	60 Years (3 Life Cycles)	8.5%	\$64,526	20	Peterborough (Distinct)	\$48,169	20	Warton (South)	\$45,926
21	North Bay (North)	60 Years (3 Life Cycles)	8.5%	\$64,629	21	Muskoka (Distinct)	\$48,253	21	Thunder Bay (North)	\$46,616
22	Muskoka (Distinct)	60 Years (3 Life Cycles)	8.5%	\$64,634	22	North Bay (North)	\$48,297	22	Trenton (South)	\$47,266
23	Sudbury (North)	60 Years (3 Life Cycles)	8.5%	\$65,241	23	Sudbury (North)	\$48,916	23	Kingston (South)	\$47,643
24	Timmins (North)	60 Years (3 Life Cycles)	8.5%	\$66,263	24	Timmins (North)	\$49,939	24	Sudbury (North)	\$47,585
25	Thunder Bay (North)	60 Years (3 Life Cycles)	8.5%	\$66,674	25	Thunder Bay (North)	\$50,329	25	Kenora (North)	\$47,486
26	Kenora (North)	60 Years (3 Life Cycles)	8.5%	\$66,992	26	Kenora (North)	\$50,622	26	Timmins (North)	\$47,925
27	Kapuskasing (North)	60 Years (3 Life Cycles)	8.5%	\$67,688	27	Kapuskasing (North)	\$51,323	27	Kapuskasing (North)	\$52,507

Table F2-1.55: Rankings of cities for base case scenario (improved construction type) at a discount rate of 8.5% (three life cycles of V.GSHP and H.GSHP and five life cycles of Traditional HVAC Applications for a 60 year project lifespan)

Carbon Taxes – (#1)

Total Present Value										
Carbon Taxes - (#1)										
#	City	Project Life Span	Discount Rate	V.GSHP	#	City	H.GSHP	#	City	Traditional
1	Sarnia (South)	60 Years (3 Life Cycles)	8.5%	\$50,220	1	St. Catharines (South)	\$37,599	1	Cambridge (South)	\$47,301
2	Chatham (South)	60 Years (3 Life Cycles)	8.5%	\$50,404	2	Sarnia (South)	\$37,958	2	Guelph (South)	\$48,049
3	Windsor (South)	60 Years (3 Life Cycles)	8.5%	\$50,417	3	Chatham (South)	\$38,165	3	Barrie (Distinct)	\$49,363
4	Niagara Falls (South)	60 Years (3 Life Cycles)	8.5%	\$50,621	4	Windsor (South)	\$38,186	4	Chatham (South)	\$49,720
5	Simcoe (South)	60 Years (3 Life Cycles)	8.5%	\$50,960	5	Niagara Falls (South)	\$38,388	5	Windsor (South)	\$49,771
6	Hamilton (South)	60 Years (3 Life Cycles)	8.5%	\$51,218	6	Simcoe (South)	\$38,727	6	London (South)	\$49,859
7	Cambridge (South)	60 Years (3 Life Cycles)	8.5%	\$51,505	7	Hamilton (South)	\$38,985	7	Sarnia (South)	\$50,241
8	London (South)	60 Years (3 Life Cycles)	8.5%	\$51,509	8	London (South)	\$39,260	8	St. Catharines (South)	\$50,656
9	Guelph (South)	60 Years (3 Life Cycles)	8.5%	\$51,722	9	Cambridge (South)	\$39,272	9	Niagara Falls (South)	\$50,730
10	Sault Ste. Marie (North)	60 Years (3 Life Cycles)	8.5%	\$52,874	10	Toronto (South)	\$39,293	10	Muskoka (Distinct)	\$51,372
11	St. Catharines (South)	60 Years (3 Life Cycles)	8.5%	\$61,816	11	Guelph (South)	\$39,489	11	Toronto (South)	\$51,719
12	Toronto (South)	60 Years (3 Life Cycles)	8.5%	\$63,454	12	Mt. Forest (South)	\$39,873	12	Sault Ste. Marie (North)	\$51,739
13	Trenton (South)	60 Years (3 Life Cycles)	8.5%	\$63,626	13	Sault Ste. Marie (North)	\$40,668	13	Hamilton (South)	\$52,034
14	Kitchener-Waterloo (South)	60 Years (3 Life Cycles)	8.5%	\$63,816	14	Trenton (South)	\$47,254	14	Ottawa (Distinct)	\$52,372
15	Mt. Forest (South)	60 Years (3 Life Cycles)	8.5%	\$63,948	15	Kitchener-Waterloo (South)	\$47,462	15	Simcoe (South)	\$52,451
16	Barrie (Distinct)	60 Years (3 Life Cycles)	8.5%	\$64,012	16	Barrie (Distinct)	\$47,630	16	North Bay (North)	\$52,823
17	Ottawa (Distinct)	60 Years (3 Life Cycles)	8.5%	\$64,064	17	Ottawa (Distinct)	\$47,708	17	Kitchener-Waterloo (South)	\$53,205
18	Kingston (South)	60 Years (3 Life Cycles)	8.5%	\$64,146	18	Kingston (South)	\$47,791	18	Peterborough (Distinct)	\$53,390
19	Warton (South)	60 Years (3 Life Cycles)	8.5%	\$64,293	19	Warton (South)	\$47,917	19	Mt. Forest (South)	\$53,521
20	Peterborough (Distinct)	60 Years (3 Life Cycles)	8.5%	\$64,526	20	Peterborough (Distinct)	\$48,169	20	Warton (South)	\$54,469
21	North Bay (North)	60 Years (3 Life Cycles)	8.5%	\$64,629	21	Muskoka (Distinct)	\$48,253	21	Trenton (South)	\$55,320
22	Muskoka (Distinct)	60 Years (3 Life Cycles)	8.5%	\$64,634	22	North Bay (North)	\$48,297	22	Kingston (South)	\$55,931
23	Sudbury (North)	60 Years (3 Life Cycles)	8.5%	\$65,241	23	Sudbury (North)	\$48,916	23	Thunder Bay (North)	\$56,478
24	Timmins (North)	60 Years (3 Life Cycles)	8.5%	\$66,263	24	Timmins (North)	\$49,939	24	Sudbury (North)	\$56,919
25	Thunder Bay (North)	60 Years (3 Life Cycles)	8.5%	\$66,674	25	Thunder Bay (North)	\$50,329	25	Kenora (North)	\$57,478
26	Kenora (North)	60 Years (3 Life Cycles)	8.5%	\$66,992	26	Kenora (North)	\$50,622	26	Timmins (North)	\$58,196
27	Kapuskasing (North)	60 Years (3 Life Cycles)	8.5%	\$67,688	27	Kapuskasing (North)	\$51,323	27	Kapuskasing (North)	\$63,155

Table F2-1.56: Rankings of cities for carbon taxes scenario (improved construction type) at a discount rate of 8.5% (three life cycles of V.GSHP and H.GSHP and five life cycles of Traditional HVAC Applications for a 60 year project lifespan)

FIT – (#2)

Total Present Value										
FIT - (#2)										
#	City	Project Life Span	Discount Rate	V.GSHP	#	City	H.GSHP	#	City	Traditional
1	Sarnia (South)	60 Years (3 Life Cycles)	8.5%	\$45,399	1	St. Catharines (South)	\$32,852	1	Cambridge (South)	\$39,315
2	Chatham (South)	60 Years (3 Life Cycles)	8.5%	\$45,528	2	Sarnia (South)	\$33,102	2	Guelph (South)	\$39,826
3	Windsor (South)	60 Years (3 Life Cycles)	8.5%	\$45,537	3	Chatham (South)	\$33,247	3	Barrie (Distinct)	\$41,273
4	Niagara Falls (South)	60 Years (3 Life Cycles)	8.5%	\$45,679	4	Windsor (South)	\$33,262	4	London (South)	\$41,873
5	Simcoe (South)	60 Years (3 Life Cycles)	8.5%	\$45,916	5	Niagara Falls (South)	\$33,403	5	Chatham (South)	\$42,540
6	Hamilton (South)	60 Years (3 Life Cycles)	8.5%	\$46,097	6	Simcoe (South)	\$33,640	6	Windsor (South)	\$42,573
7	Cambridge (South)	60 Years (3 Life Cycles)	8.5%	\$46,297	7	Hamilton (South)	\$33,820	7	Muskoka (Distinct)	\$42,717
8	London (South)	60 Years (3 Life Cycles)	8.5%	\$46,300	8	London (South)	\$34,013	8	Sarnia (South)	\$42,908
9	Guelph (South)	60 Years (3 Life Cycles)	8.5%	\$46,449	9	Cambridge (South)	\$34,021	9	Sault Ste. Marie (North)	\$42,835
10	Sault Ste. Marie (North)	60 Years (3 Life Cycles)	8.5%	\$47,254	10	Toronto (South)	\$34,036	10	Niagara Falls (South)	\$43,467
11	St. Catharines (South)	60 Years (3 Life Cycles)	8.5%	\$56,937	11	Guelph (South)	\$34,173	11	St. Catharines (South)	\$43,627
12	Toronto (South)	60 Years (3 Life Cycles)	8.5%	\$58,082	12	Mt. Forest (South)	\$34,441	12	Toronto (South)	\$43,717
13	Trenton (South)	60 Years (3 Life Cycles)	8.5%	\$58,203	13	Sault Ste. Marie (North)	\$34,996	13	Ottawa (Distinct)	\$44,097
14	Kitchener-Waterloo (South)	60 Years (3 Life Cycles)	8.5%	\$58,335	14	Trenton (South)	\$41,791	14	North Bay (North)	\$44,114
15	Mt. Forest (South)	60 Years (3 Life Cycles)	8.5%	\$58,427	15	Kitchener-Waterloo (South)	\$41,936	15	Hamilton (South)	\$44,251
16	Barrie (Distinct)	60 Years (3 Life Cycles)	8.5%	\$58,472	16	Barrie (Distinct)	\$42,054	16	Simcoe (South)	\$44,840
17	Ottawa (Distinct)	60 Years (3 Life Cycles)	8.5%	\$58,509	17	Ottawa (Distinct)	\$42,108	17	Peterborough (Distinct)	\$44,764
18	Kingston (South)	60 Years (3 Life Cycles)	8.5%	\$58,566	18	Kingston (South)	\$42,167	18	Mt. Forest (South)	\$44,765
19	Warton (South)	60 Years (3 Life Cycles)	8.5%	\$58,669	19	Warton (South)	\$42,255	19	Kitchener-Waterloo (South)	\$44,964
20	Peterborough (Distinct)	60 Years (3 Life Cycles)	8.5%	\$58,831	20	Peterborough (Distinct)	\$42,431	20	Warton (South)	\$45,926
21	North Bay (North)	60 Years (3 Life Cycles)	8.5%	\$58,903	21	Muskoka (Distinct)	\$42,489	21	Thunder Bay (North)	\$46,616
22	Muskoka (Distinct)	60 Years (3 Life Cycles)	8.5%	\$58,907	22	North Bay (North)	\$42,520	22	Trenton (South)	\$47,266
23	Sudbury (North)	60 Years (3 Life Cycles)	8.5%	\$59,331	23	Sudbury (North)	\$42,952	23	Kingston (South)	\$47,643
24	Timmins (North)	60 Years (3 Life Cycles)	8.5%	\$60,045	24	Timmins (North)	\$43,668	24	Sudbury (North)	\$47,585
25	Thunder Bay (North)	60 Years (3 Life Cycles)	8.5%	\$60,332	25	Thunder Bay (North)	\$43,940	25	Kenora (North)	\$47,486
26	Kenora (North)	60 Years (3 Life Cycles)	8.5%	\$60,555	26	Kenora (North)	\$44,145	26	Timmins (North)	\$47,925
27	Kapuskasing (North)	60 Years (3 Life Cycles)	8.5%	\$61,041	27	Kapuskasing (North)	\$44,635	27	Kapuskasing (North)	\$52,507

Table F2-1.57: Rankings of cities for feed-in tariff scenario (improved construction type) at a discount rate of 8.5% (three life cycles of V.GSHP and H.GSHP and five life cycles of Traditional HVAC Applications for a 60 year project lifespan)

Rebates – (#3)

Total Present Value										
Rebates - (#3)										
#	City	Project Life Span	Discount Rate	V.GSHP	#	City	H.GSHP	#	City	Traditional
1	Sarnia (South)	60 Years (3 Life Cycles)	8.5%	\$43,344	1	St. Catharines (South)	\$30,723	1	Cambridge (South)	\$39,315
2	Chatham (South)	60 Years (3 Life Cycles)	8.5%	\$43,528	2	Sarnia (South)	\$31,082	2	Guelph (South)	\$39,826
3	Windsor (South)	60 Years (3 Life Cycles)	8.5%	\$43,542	3	Chatham (South)	\$31,289	3	Barrie (Distinct)	\$41,273
4	Niagara Falls (South)	60 Years (3 Life Cycles)	8.5%	\$43,745	4	Windsor (South)	\$31,310	4	London (South)	\$41,873
5	Simcoe (South)	60 Years (3 Life Cycles)	8.5%	\$44,084	5	Niagara Falls (South)	\$31,512	5	Chatham (South)	\$42,540
6	Hamilton (South)	60 Years (3 Life Cycles)	8.5%	\$44,342	6	Simcoe (South)	\$31,851	6	Windsor (South)	\$42,573
7	Cambridge (South)	60 Years (3 Life Cycles)	8.5%	\$44,629	7	Hamilton (South)	\$32,109	7	Muskoka (Distinct)	\$42,717
8	London (South)	60 Years (3 Life Cycles)	8.5%	\$44,633	8	London (South)	\$32,384	8	Sarnia (South)	\$42,908
9	Guelph (South)	60 Years (3 Life Cycles)	8.5%	\$44,846	9	Cambridge (South)	\$32,396	9	Sault Ste. Marie (North)	\$42,835
10	Sault Ste. Marie (North)	60 Years (3 Life Cycles)	8.5%	\$45,998	10	Toronto (South)	\$32,417	10	Niagara Falls (South)	\$43,467
11	St. Catharines (South)	60 Years (3 Life Cycles)	8.5%	\$54,940	11	Guelph (South)	\$32,613	11	St. Catharines (South)	\$43,627
12	Toronto (South)	60 Years (3 Life Cycles)	8.5%	\$56,578	12	Mt. Forest (South)	\$32,997	12	Toronto (South)	\$43,717
13	Trenton (South)	60 Years (3 Life Cycles)	8.5%	\$56,750	13	Sault Ste. Marie (North)	\$33,792	13	Ottawa (Distinct)	\$44,097
14	Kitchener-Waterloo (South)	60 Years (3 Life Cycles)	8.5%	\$56,940	14	Trenton (South)	\$40,378	14	North Bay (North)	\$44,114
15	Mt. Forest (South)	60 Years (3 Life Cycles)	8.5%	\$57,072	15	Kitchener-Waterloo (South)	\$40,586	15	Hamilton (South)	\$44,251
16	Barrie (Distinct)	60 Years (3 Life Cycles)	8.5%	\$57,136	16	Barrie (Distinct)	\$40,754	16	Simcoe (South)	\$44,840
17	Ottawa (Distinct)	60 Years (3 Life Cycles)	8.5%	\$57,189	17	Ottawa (Distinct)	\$40,832	17	Peterborough (Distinct)	\$44,764
18	Kingston (South)	60 Years (3 Life Cycles)	8.5%	\$57,270	18	Kingston (South)	\$40,915	18	Mt. Forest (South)	\$44,765
19	Warton (South)	60 Years (3 Life Cycles)	8.5%	\$57,417	19	Warton (South)	\$41,041	19	Kitchener-Waterloo (South)	\$44,964
20	Peterborough (Distinct)	60 Years (3 Life Cycles)	8.5%	\$57,650	20	Peterborough (Distinct)	\$41,293	20	Warton (South)	\$45,926
21	North Bay (North)	60 Years (3 Life Cycles)	8.5%	\$57,753	21	Muskoka (Distinct)	\$41,377	21	Thunder Bay (North)	\$46,616
22	Muskoka (Distinct)	60 Years (3 Life Cycles)	8.5%	\$57,759	22	North Bay (North)	\$41,421	22	Trenton (South)	\$47,266
23	Sudbury (North)	60 Years (3 Life Cycles)	8.5%	\$58,365	23	Sudbury (North)	\$42,040	23	Kingston (South)	\$47,643
24	Timmins (North)	60 Years (3 Life Cycles)	8.5%	\$59,387	24	Timmins (North)	\$43,063	24	Sudbury (North)	\$47,585
25	Thunder Bay (North)	60 Years (3 Life Cycles)	8.5%	\$59,798	25	Thunder Bay (North)	\$43,453	25	Kenora (North)	\$47,486
26	Kenora (North)	60 Years (3 Life Cycles)	8.5%	\$60,116	26	Kenora (North)	\$43,746	26	Timmins (North)	\$47,925
27	Kapuskasing (North)	60 Years (3 Life Cycles)	8.5%	\$60,812	27	Kapuskasing (North)	\$44,448	27	Kapuskasing (North)	\$52,507

Table F2-1.58: Rankings of cities for rebates scenario (improved construction type) at a discount rate of 8.5% (three life cycles of V.GSHP and H.GSHP and five life cycles of Traditional HVAC Applications for a 60 year project lifespan)

FIT + Rebates – (#4)

Total Present Value										
(FIT+Rebates) - (#4)										
#	City	Project Life Span	Discount Rate	V.GSHP	#	City	H.GSHP	#	City	Traditional
1	Sarnia (South)	60 Years (3 Life Cycles)	8.5%	\$38,523	1	St. Catharines (South)	\$25,976	1	Cambridge (South)	\$39,315
2	Chatham (South)	60 Years (3 Life Cycles)	8.5%	\$38,652	2	Sarnia (South)	\$26,227	2	Guelph (South)	\$39,826
3	Windsor (South)	60 Years (3 Life Cycles)	8.5%	\$38,661	3	Chatham (South)	\$26,371	3	Barrie (Distinct)	\$41,273
4	Niagara Falls (South)	60 Years (3 Life Cycles)	8.5%	\$38,804	4	Windsor (South)	\$26,386	4	London (South)	\$41,873
5	Simcoe (South)	60 Years (3 Life Cycles)	8.5%	\$39,041	5	Niagara Falls (South)	\$26,527	5	Chatham (South)	\$42,540
6	Hamilton (South)	60 Years (3 Life Cycles)	8.5%	\$39,221	6	Simcoe (South)	\$26,764	6	Windsor (South)	\$42,573
7	Cambridge (South)	60 Years (3 Life Cycles)	8.5%	\$39,421	7	Hamilton (South)	\$26,945	7	Muskoka (Distinct)	\$42,717
8	London (South)	60 Years (3 Life Cycles)	8.5%	\$39,424	8	London (South)	\$27,137	8	Sarnia (South)	\$42,908
9	Guelph (South)	60 Years (3 Life Cycles)	8.5%	\$39,573	9	Cambridge (South)	\$27,145	9	Sault Ste. Marie (North)	\$42,835
10	Sault Ste. Marie (North)	60 Years (3 Life Cycles)	8.5%	\$40,378	10	Toronto (South)	\$27,160	10	Niagara Falls (South)	\$43,467
11	St. Catharines (South)	60 Years (3 Life Cycles)	8.5%	\$50,061	11	Guelph (South)	\$27,297	11	St. Catharines (South)	\$43,627
12	Toronto (South)	60 Years (3 Life Cycles)	8.5%	\$51,206	12	Mt. Forest (South)	\$27,565	12	Toronto (South)	\$43,717
13	Trenton (South)	60 Years (3 Life Cycles)	8.5%	\$51,327	13	Sault Ste. Marie (North)	\$28,121	13	Ottawa (Distinct)	\$44,097
14	Kitchener-Waterloo (South)	60 Years (3 Life Cycles)	8.5%	\$51,459	14	Trenton (South)	\$34,915	14	North Bay (North)	\$44,114
15	Mt. Forest (South)	60 Years (3 Life Cycles)	8.5%	\$51,552	15	Kitchener-Waterloo (South)	\$35,060	15	Hamilton (South)	\$44,251
16	Barrie (Distinct)	60 Years (3 Life Cycles)	8.5%	\$51,596	16	Barrie (Distinct)	\$35,178	16	Simcoe (South)	\$44,840
17	Ottawa (Distinct)	60 Years (3 Life Cycles)	8.5%	\$51,633	17	Ottawa (Distinct)	\$35,232	17	Peterborough (Distinct)	\$44,764
18	Kingston (South)	60 Years (3 Life Cycles)	8.5%	\$51,690	18	Kingston (South)	\$35,291	18	Mt. Forest (South)	\$44,765
19	Warton (South)	60 Years (3 Life Cycles)	8.5%	\$51,793	19	Warton (South)	\$35,379	19	Kitchener-Waterloo (South)	\$44,964
20	Peterborough (Distinct)	60 Years (3 Life Cycles)	8.5%	\$51,955	20	Peterborough (Distinct)	\$35,555	20	Warton (South)	\$45,926
21	North Bay (North)	60 Years (3 Life Cycles)	8.5%	\$52,027	21	Muskoka (Distinct)	\$35,613	21	Thunder Bay (North)	\$46,616
22	Muskoka (Distinct)	60 Years (3 Life Cycles)	8.5%	\$52,031	22	North Bay (North)	\$35,644	22	Trenton (South)	\$47,266
23	Sudbury (North)	60 Years (3 Life Cycles)	8.5%	\$52,455	23	Sudbury (North)	\$36,077	23	Kingston (South)	\$47,643
24	Timmins (North)	60 Years (3 Life Cycles)	8.5%	\$53,169	24	Timmins (North)	\$36,792	24	Sudbury (North)	\$47,585
25	Thunder Bay (North)	60 Years (3 Life Cycles)	8.5%	\$53,456	25	Thunder Bay (North)	\$37,064	25	Kenora (North)	\$47,486
26	Kenora (North)	60 Years (3 Life Cycles)	8.5%	\$53,679	26	Kenora (North)	\$37,269	26	Timmins (North)	\$47,925
27	Kapuskasing (North)	60 Years (3 Life Cycles)	8.5%	\$54,165	27	Kapuskasing (North)	\$37,759	27	Kapuskasing (North)	\$52,507

Table F2-1.59: Rankings of cities for feed-in tariff + rebates scenario (improved construction type) at a discount rate of 8.5% (three life cycles of V.GSHP and H.GSHP and five life cycles of Traditional HVAC Applications for a 60 year project lifespan)

(FIT + Rebates) + Carbon Taxes – (#5)

Total Present Value										
(FIT+Rebates) + Carbon Taxes - (#5)										
#	City	Project Life Span	Discount Rate	V.GSHP	#	City	H.GSHP	#	City	Traditional
1	Sarnia (South)	60 Years (3 Life Cycles)	8.5%	\$38,523	1	St. Catharines (South)	\$25,976	1	Cambridge (South)	\$47,301
2	Chatham (South)	60 Years (3 Life Cycles)	8.5%	\$38,652	2	Sarnia (South)	\$26,227	2	Guelph (South)	\$48,049
3	Windsor (South)	60 Years (3 Life Cycles)	8.5%	\$38,661	3	Chatham (South)	\$26,371	3	Barrie (Distinct)	\$49,363
4	Niagara Falls (South)	60 Years (3 Life Cycles)	8.5%	\$38,804	4	Windsor (South)	\$26,386	4	Chatham (South)	\$49,720
5	Simcoe (South)	60 Years (3 Life Cycles)	8.5%	\$39,041	5	Niagara Falls (South)	\$26,527	5	Windsor (South)	\$49,771
6	Hamilton (South)	60 Years (3 Life Cycles)	8.5%	\$39,221	6	Simcoe (South)	\$26,764	6	London (South)	\$49,859
7	Cambridge (South)	60 Years (3 Life Cycles)	8.5%	\$39,421	7	Hamilton (South)	\$26,945	7	Sarnia (South)	\$50,241
8	London (South)	60 Years (3 Life Cycles)	8.5%	\$39,424	8	London (South)	\$27,137	8	St. Catharines (South)	\$50,656
9	Guelph (South)	60 Years (3 Life Cycles)	8.5%	\$39,573	9	Cambridge (South)	\$27,145	9	Niagara Falls (South)	\$50,730
10	Sault Ste. Marie (North)	60 Years (3 Life Cycles)	8.5%	\$40,378	10	Toronto (South)	\$27,160	10	Muskoka (Distinct)	\$51,372
11	St. Catharines (South)	60 Years (3 Life Cycles)	8.5%	\$50,061	11	Guelph (South)	\$27,297	11	Toronto (South)	\$51,719
12	Toronto (South)	60 Years (3 Life Cycles)	8.5%	\$51,206	12	Mt. Forest (South)	\$27,565	12	Sault Ste. Marie (North)	\$51,739
13	Trenton (South)	60 Years (3 Life Cycles)	8.5%	\$51,327	13	Sault Ste. Marie (North)	\$28,121	13	Hamilton (South)	\$52,034
14	Kitchener-Waterloo (South)	60 Years (3 Life Cycles)	8.5%	\$51,459	14	Trenton (South)	\$34,915	14	Ottawa (Distinct)	\$52,372
15	Mt. Forest (South)	60 Years (3 Life Cycles)	8.5%	\$51,552	15	Kitchener-Waterloo (South)	\$35,060	15	Simcoe (South)	\$52,451
16	Barrie (Distinct)	60 Years (3 Life Cycles)	8.5%	\$51,596	16	Barrie (Distinct)	\$35,178	16	North Bay (North)	\$52,823
17	Ottawa (Distinct)	60 Years (3 Life Cycles)	8.5%	\$51,633	17	Ottawa (Distinct)	\$35,232	17	Kitchener-Waterloo (South)	\$53,205
18	Kingston (South)	60 Years (3 Life Cycles)	8.5%	\$51,690	18	Kingston (South)	\$35,291	18	Peterborough (Distinct)	\$53,390
19	Warton (South)	60 Years (3 Life Cycles)	8.5%	\$51,793	19	Warton (South)	\$35,379	19	Mt. Forest (South)	\$53,521
20	Peterborough (Distinct)	60 Years (3 Life Cycles)	8.5%	\$51,955	20	Peterborough (Distinct)	\$35,555	20	Warton (South)	\$54,469
21	North Bay (North)	60 Years (3 Life Cycles)	8.5%	\$52,027	21	Muskoka (Distinct)	\$35,613	21	Trenton (South)	\$55,320
22	Muskoka (Distinct)	60 Years (3 Life Cycles)	8.5%	\$52,031	22	North Bay (North)	\$35,644	22	Kingston (South)	\$55,931
23	Sudbury (North)	60 Years (3 Life Cycles)	8.5%	\$52,455	23	Sudbury (North)	\$36,077	23	Thunder Bay (North)	\$56,478
24	Timmins (North)	60 Years (3 Life Cycles)	8.5%	\$53,169	24	Timmins (North)	\$36,792	24	Sudbury (North)	\$56,919
25	Thunder Bay (North)	60 Years (3 Life Cycles)	8.5%	\$53,456	25	Thunder Bay (North)	\$37,064	25	Kenora (North)	\$57,478
26	Kenora (North)	60 Years (3 Life Cycles)	8.5%	\$53,679	26	Kenora (North)	\$37,269	26	Timmins (North)	\$58,196
27	Kapuskasing (North)	60 Years (3 Life Cycles)	8.5%	\$54,165	27	Kapuskasing (North)	\$37,759	27	Kapuskasing (North)	\$63,155

Table F2-1.60: Rankings of cities for feed-in tariff + rebates + carbon tax scenario (improved construction type) at a discount rate of 8.5% (three life cycles of V.GSHP and H.GSHP and five life cycles of Traditional HVAC Applications for a 60 year project lifespan)

11. Three Life Cycles of V.GSHP and H.GSHP and Five Life Cycles of Traditional HVAC Applications @ 10% Discount Rate

Base Case Scenario

Total Present Value										
Base Case Scenario										
#	City	Project Life Span	Discount Rate	V.GSHP	#	City	H.GSHP	#	City	Traditional
1	Sarnia (South)	60 Years (3 Life Cycles)	10%	\$45,039	1	St. Catharines (South)	\$33,405	1	Cambridge (South)	\$33,830
2	Chatham (South)	60 Years (3 Life Cycles)	10%	\$45,195	2	Sarnia (South)	\$33,709	2	Guelph (South)	\$34,261
3	Windsor (South)	60 Years (3 Life Cycles)	10%	\$45,206	3	Chatham (South)	\$33,885	3	Barrie (Distinct)	\$35,534
4	Niagara Falls (South)	60 Years (3 Life Cycles)	10%	\$45,379	4	Windsor (South)	\$33,903	4	London (South)	\$36,044
5	Simcoe (South)	60 Years (3 Life Cycles)	10%	\$45,666	5	Niagara Falls (South)	\$34,073	5	Chatham (South)	\$36,663
6	Hamilton (South)	60 Years (3 Life Cycles)	10%	\$45,885	6	Simcoe (South)	\$34,361	6	Windsor (South)	\$36,691
7	Cambridge (South)	60 Years (3 Life Cycles)	10%	\$46,128	7	Hamilton (South)	\$34,579	7	Muskoka (Distinct)	\$36,752
8	London (South)	60 Years (3 Life Cycles)	10%	\$46,131	8	London (South)	\$34,813	8	Sarnia (South)	\$36,973
9	Guelph (South)	60 Years (3 Life Cycles)	10%	\$46,312	9	Cambridge (South)	\$34,823	9	Sault Ste. Marie (North)	\$36,850
10	Sault Ste. Marie (North)	60 Years (3 Life Cycles)	10%	\$47,288	10	Toronto (South)	\$34,841	10	Niagara Falls (South)	\$37,447
11	St. Catharines (South)	60 Years (3 Life Cycles)	10%	\$55,693	11	Guelph (South)	\$35,007	11	St. Catharines (South)	\$37,585
12	Toronto (South)	60 Years (3 Life Cycles)	10%	\$57,081	12	Mt. Forest (South)	\$35,332	12	Toronto (South)	\$37,652
13	Trenton (South)	60 Years (3 Life Cycles)	10%	\$57,228	13	Sault Ste. Marie (North)	\$36,005	13	Ottawa (Distinct)	\$37,971
14	Kitchener-Waterloo (South)	60 Years (3 Life Cycles)	10%	\$57,389	14	Trenton (South)	\$42,102	14	North Bay (North)	\$37,981
15	Mt. Forest (South)	60 Years (3 Life Cycles)	10%	\$57,500	15	Kitchener-Waterloo (South)	\$42,277	15	Hamilton (South)	\$38,106
16	Barrie (Distinct)	60 Years (3 Life Cycles)	10%	\$57,554	16	Barrie (Distinct)	\$42,420	16	Simcoe (South)	\$38,653
17	Ottawa (Distinct)	60 Years (3 Life Cycles)	10%	\$57,599	17	Ottawa (Distinct)	\$42,486	17	Peterborough (Distinct)	\$38,532
18	Kingston (South)	60 Years (3 Life Cycles)	10%	\$57,668	18	Kingston (South)	\$42,557	18	Mt. Forest (South)	\$38,532
19	Warton (South)	60 Years (3 Life Cycles)	10%	\$57,793	19	Warton (South)	\$42,663	19	Kitchener-Waterloo (South)	\$38,706
20	Peterborough (Distinct)	60 Years (3 Life Cycles)	10%	\$57,990	20	Peterborough (Distinct)	\$42,877	20	Warton (South)	\$39,564
21	North Bay (North)	60 Years (3 Life Cycles)	10%	\$58,077	21	Muskoka (Distinct)	\$42,948	21	Thunder Bay (North)	\$40,090
22	Muskoka (Distinct)	60 Years (3 Life Cycles)	10%	\$58,082	22	North Bay (North)	\$42,985	22	Trenton (South)	\$40,751
23	Sudbury (North)	60 Years (3 Life Cycles)	10%	\$58,596	23	Sudbury (North)	\$43,509	23	Kingston (South)	\$41,068
24	Timmins (North)	60 Years (3 Life Cycles)	10%	\$59,462	24	Timmins (North)	\$44,377	24	Sudbury (North)	\$40,962
25	Thunder Bay (North)	60 Years (3 Life Cycles)	10%	\$59,810	25	Thunder Bay (North)	\$44,707	25	Kenora (North)	\$40,826
26	Kenora (North)	60 Years (3 Life Cycles)	10%	\$60,079	26	Kenora (North)	\$44,955	26	Timmins (North)	\$41,195
27	Kapuskasing (North)	60 Years (3 Life Cycles)	10%	\$60,669	27	Kapuskasing (North)	\$45,550	27	Kapuskasing (North)	\$45,166

Table F2-1.61: Rankings of cities for base case scenario (improved construction type) at a discount rate of 10% (three life cycles of V.GSHP and H.GSHP and five life cycles of Traditional HVAC Applications for a 60 year project lifespan)

Carbon Taxes – (#1)

Total Present Value										
Carbon Taxes - (#1)										
#	City	Project Life Span	Discount Rate	V.GSHP	#	City	H.GSHP	#	City	Traditional
1	Sarnia (South)	60 Years (3 Life Cycles)	10%	\$45,039	1	St. Catharines (South)	\$33,405	1	Cambridge (South)	\$39,811
2	Chatham (South)	60 Years (3 Life Cycles)	10%	\$45,195	2	Sarnia (South)	\$33,709	2	Guelph (South)	\$40,419
3	Windsor (South)	60 Years (3 Life Cycles)	10%	\$45,206	3	Chatham (South)	\$33,885	3	Barrie (Distinct)	\$41,593
4	Niagara Falls (South)	60 Years (3 Life Cycles)	10%	\$45,379	4	Windsor (South)	\$33,903	4	London (South)	\$42,025
5	Simcoe (South)	60 Years (3 Life Cycles)	10%	\$45,666	5	Niagara Falls (South)	\$34,073	5	Chatham (South)	\$42,040
6	Hamilton (South)	60 Years (3 Life Cycles)	10%	\$45,885	6	Simcoe (South)	\$34,361	6	Windsor (South)	\$42,081
7	Cambridge (South)	60 Years (3 Life Cycles)	10%	\$46,128	7	Hamilton (South)	\$34,579	7	Sarnia (South)	\$42,465
8	London (South)	60 Years (3 Life Cycles)	10%	\$46,131	8	London (South)	\$34,813	8	St. Catharines (South)	\$42,849
9	Guelph (South)	60 Years (3 Life Cycles)	10%	\$46,312	9	Cambridge (South)	\$34,823	9	Niagara Falls (South)	\$42,886
10	Sault Ste. Marie (North)	60 Years (3 Life Cycles)	10%	\$47,288	10	Toronto (South)	\$34,841	10	Muskoka (Distinct)	\$43,234
11	St. Catharines (South)	60 Years (3 Life Cycles)	10%	\$55,693	11	Guelph (South)	\$35,007	11	Sault Ste. Marie (North)	\$43,518
12	Toronto (South)	60 Years (3 Life Cycles)	10%	\$57,081	12	Mt. Forest (South)	\$35,332	12	Toronto (South)	\$43,644
13	Trenton (South)	60 Years (3 Life Cycles)	10%	\$57,228	13	Sault Ste. Marie (North)	\$36,005	13	Hamilton (South)	\$43,935
14	Kitchener-Waterloo (South)	60 Years (3 Life Cycles)	10%	\$57,389	14	Trenton (South)	\$42,102	14	Ottawa (Distinct)	\$44,168
15	Mt. Forest (South)	60 Years (3 Life Cycles)	10%	\$57,500	15	Kitchener-Waterloo (South)	\$42,277	15	Simcoe (South)	\$44,353
16	Barrie (Distinct)	60 Years (3 Life Cycles)	10%	\$57,554	16	Barrie (Distinct)	\$42,420	16	North Bay (North)	\$44,504
17	Ottawa (Distinct)	60 Years (3 Life Cycles)	10%	\$57,599	17	Ottawa (Distinct)	\$42,486	17	Kitchener-Waterloo (South)	\$44,878
18	Kingston (South)	60 Years (3 Life Cycles)	10%	\$57,668	18	Kingston (South)	\$42,557	18	Peterborough (Distinct)	\$44,993
19	Warton (South)	60 Years (3 Life Cycles)	10%	\$57,793	19	Warton (South)	\$42,663	19	Mt. Forest (South)	\$45,090
20	Peterborough (Distinct)	60 Years (3 Life Cycles)	10%	\$57,990	20	Peterborough (Distinct)	\$42,877	20	Warton (South)	\$45,962
21	North Bay (North)	60 Years (3 Life Cycles)	10%	\$58,077	21	Muskoka (Distinct)	\$42,948	21	Trenton (South)	\$46,782
22	Muskoka (Distinct)	60 Years (3 Life Cycles)	10%	\$58,082	22	North Bay (North)	\$42,985	22	Kingston (South)	\$47,274
23	Sudbury (North)	60 Years (3 Life Cycles)	10%	\$58,596	23	Sudbury (North)	\$43,509	23	Thunder Bay (North)	\$47,475
24	Timmins (North)	60 Years (3 Life Cycles)	10%	\$59,462	24	Timmins (North)	\$44,377	24	Sudbury (North)	\$47,952
25	Thunder Bay (North)	60 Years (3 Life Cycles)	10%	\$59,810	25	Thunder Bay (North)	\$44,707	25	Kenora (North)	\$48,309
26	Kenora (North)	60 Years (3 Life Cycles)	10%	\$60,079	26	Kenora (North)	\$44,955	26	Timmins (North)	\$48,887
27	Kapuskasing (North)	60 Years (3 Life Cycles)	10%	\$60,669	27	Kapuskasing (North)	\$45,550	27	Kapuskasing (North)	\$53,140

Table F2-1.62: Rankings of cities for carbon taxes scenario (improved construction type) at a discount rate of 10% (three life cycles of V.GSHP and H.GSHP and five life cycles of Traditional HVAC Applications for a 60 year project lifespan)

FIT – (#2)

Total Present Value										
FIT - (#2)										
#	City	Project Life Span	Discount Rate	V.GSHP	#	City	H.GSHP	#	City	Traditional
1	Sarnia (South)	60 Years (3 Life Cycles)	10%	\$40,924	1	St. Catharines (South)	\$29,353	1	Cambridge (South)	\$33,830
2	Chatham (South)	60 Years (3 Life Cycles)	10%	\$41,033	2	Sarnia (South)	\$29,564	2	Guelph (South)	\$34,261
3	Windsor (South)	60 Years (3 Life Cycles)	10%	\$41,041	3	Chatham (South)	\$29,687	3	Barrie (Distinct)	\$35,534
4	Niagara Falls (South)	60 Years (3 Life Cycles)	10%	\$41,161	4	Windsor (South)	\$29,699	4	London (South)	\$36,044
5	Simcoe (South)	60 Years (3 Life Cycles)	10%	\$41,361	5	Niagara Falls (South)	\$29,818	5	Chatham (South)	\$36,663
6	Hamilton (South)	60 Years (3 Life Cycles)	10%	\$41,513	6	Simcoe (South)	\$30,019	6	Windsor (South)	\$36,691
7	Cambridge (South)	60 Years (3 Life Cycles)	10%	\$41,683	7	Hamilton (South)	\$30,171	7	Muskoka (Distinct)	\$36,752
8	London (South)	60 Years (3 Life Cycles)	10%	\$41,685	8	London (South)	\$30,333	8	Sarnia (South)	\$36,973
9	Guelph (South)	60 Years (3 Life Cycles)	10%	\$41,811	9	Cambridge (South)	\$30,340	9	Sault Ste. Marie (North)	\$36,850
10	Sault Ste. Marie (North)	60 Years (3 Life Cycles)	10%	\$42,490	10	Toronto (South)	\$30,353	10	Niagara Falls (South)	\$37,447
11	St. Catharines (South)	60 Years (3 Life Cycles)	10%	\$51,529	11	Guelph (South)	\$30,468	11	St. Catharines (South)	\$37,585
12	Toronto (South)	60 Years (3 Life Cycles)	10%	\$52,496	12	Mt. Forest (South)	\$30,695	12	Toronto (South)	\$37,652
13	Trenton (South)	60 Years (3 Life Cycles)	10%	\$52,598	13	Sault Ste. Marie (North)	\$31,164	13	Ottawa (Distinct)	\$37,971
14	Kitchener-Waterloo (South)	60 Years (3 Life Cycles)	10%	\$52,710	14	Trenton (South)	\$37,439	14	North Bay (North)	\$37,981
15	Mt. Forest (South)	60 Years (3 Life Cycles)	10%	\$52,788	15	Kitchener-Waterloo (South)	\$37,561	15	Hamilton (South)	\$38,106
16	Barrie (Distinct)	60 Years (3 Life Cycles)	10%	\$52,826	16	Barrie (Distinct)	\$37,661	16	Simcoe (South)	\$38,653
17	Ottawa (Distinct)	60 Years (3 Life Cycles)	10%	\$52,856	17	Ottawa (Distinct)	\$37,706	17	Peterborough (Distinct)	\$38,532
18	Kingston (South)	60 Years (3 Life Cycles)	10%	\$52,904	18	Kingston (South)	\$37,755	18	Mt. Forest (South)	\$38,532
19	Warton (South)	60 Years (3 Life Cycles)	10%	\$52,991	19	Warton (South)	\$37,830	19	Kitchener-Waterloo (South)	\$38,706
20	Peterborough (Distinct)	60 Years (3 Life Cycles)	10%	\$53,129	20	Peterborough (Distinct)	\$37,979	20	Warton (South)	\$39,564
21	North Bay (North)	60 Years (3 Life Cycles)	10%	\$53,189	21	Muskoka (Distinct)	\$38,028	21	Thunder Bay (North)	\$40,090
22	Muskoka (Distinct)	60 Years (3 Life Cycles)	10%	\$53,193	22	North Bay (North)	\$38,054	22	Trenton (South)	\$40,751
23	Sudbury (North)	60 Years (3 Life Cycles)	10%	\$53,551	23	Sudbury (North)	\$38,419	23	Kingston (South)	\$41,068
24	Timmins (North)	60 Years (3 Life Cycles)	10%	\$54,154	24	Timmins (North)	\$39,023	24	Sudbury (North)	\$40,962
25	Thunder Bay (North)	60 Years (3 Life Cycles)	10%	\$54,397	25	Thunder Bay (North)	\$39,253	25	Kenora (North)	\$40,826
26	Kenora (North)	60 Years (3 Life Cycles)	10%	\$54,584	26	Kenora (North)	\$39,426	26	Timmins (North)	\$41,195
27	Kapuskasing (North)	60 Years (3 Life Cycles)	10%	\$54,995	27	Kapuskasing (North)	\$39,840	27	Kapuskasing (North)	\$45,166

Table F2-1.63: Rankings of cities for feed-in tariff scenario (improved construction type) at a discount rate of 10% (three life cycles of V.GSHP and H.GSHP and five life cycles of Traditional HVAC Applications for a 60 year project lifespan)

Rebates – (#3)

Total Present Value										
Rebates - (#3)										
#	City	Project Life Span	Discount Rate	V.GSHP	#	City	H.GSHP	#	City	Traditional
1	Sarnia (South)	60 Years (3 Life Cycles)	10%	\$38,691	1	St. Catharines (South)	\$27,057	1	Cambridge (South)	\$33,830
2	Chatham (South)	60 Years (3 Life Cycles)	10%	\$38,847	2	Sarnia (South)	\$27,360	2	Guelph (South)	\$34,261
3	Windsor (South)	60 Years (3 Life Cycles)	10%	\$38,858	3	Chatham (South)	\$27,536	3	Barrie (Distinct)	\$35,534
4	Niagara Falls (South)	60 Years (3 Life Cycles)	10%	\$39,031	4	Windsor (South)	\$27,554	4	London (South)	\$36,044
5	Simcoe (South)	60 Years (3 Life Cycles)	10%	\$39,318	5	Niagara Falls (South)	\$27,725	5	Chatham (South)	\$36,663
6	Hamilton (South)	60 Years (3 Life Cycles)	10%	\$39,537	6	Simcoe (South)	\$28,013	6	Windsor (South)	\$36,691
7	Cambridge (South)	60 Years (3 Life Cycles)	10%	\$39,780	7	Hamilton (South)	\$28,231	7	Muskoka (Distinct)	\$36,752
8	London (South)	60 Years (3 Life Cycles)	10%	\$39,783	8	London (South)	\$28,464	8	Sarnia (South)	\$36,973
9	Guelph (South)	60 Years (3 Life Cycles)	10%	\$39,964	9	Cambridge (South)	\$28,474	9	Sault Ste. Marie (North)	\$36,850
10	Sault Ste. Marie (North)	60 Years (3 Life Cycles)	10%	\$40,939	10	Toronto (South)	\$28,492	10	Niagara Falls (South)	\$37,447
11	St. Catharines (South)	60 Years (3 Life Cycles)	10%	\$49,345	11	Guelph (South)	\$28,658	11	St. Catharines (South)	\$37,585
12	Toronto (South)	60 Years (3 Life Cycles)	10%	\$50,733	12	Mt. Forest (South)	\$28,983	12	Toronto (South)	\$37,652
13	Trenton (South)	60 Years (3 Life Cycles)	10%	\$50,879	13	Sault Ste. Marie (North)	\$29,657	13	Ottawa (Distinct)	\$37,971
14	Kitchener-Waterloo (South)	60 Years (3 Life Cycles)	10%	\$51,040	14	Trenton (South)	\$35,753	14	North Bay (North)	\$37,981
15	Mt. Forest (South)	60 Years (3 Life Cycles)	10%	\$51,152	15	Kitchener-Waterloo (South)	\$35,929	15	Hamilton (South)	\$38,106
16	Barrie (Distinct)	60 Years (3 Life Cycles)	10%	\$51,206	16	Barrie (Distinct)	\$36,072	16	Simcoe (South)	\$38,653
17	Ottawa (Distinct)	60 Years (3 Life Cycles)	10%	\$51,250	17	Ottawa (Distinct)	\$36,138	17	Peterborough (Distinct)	\$38,532
18	Kingston (South)	60 Years (3 Life Cycles)	10%	\$51,319	18	Kingston (South)	\$36,208	18	Mt. Forest (South)	\$38,532
19	Warton (South)	60 Years (3 Life Cycles)	10%	\$51,444	19	Warton (South)	\$36,315	19	Kitchener-Waterloo (South)	\$38,706
20	Peterborough (Distinct)	60 Years (3 Life Cycles)	10%	\$51,641	20	Peterborough (Distinct)	\$36,529	20	Warton (South)	\$39,564
21	North Bay (North)	60 Years (3 Life Cycles)	10%	\$51,728	21	Muskoka (Distinct)	\$36,599	21	Thunder Bay (North)	\$40,090
22	Muskoka (Distinct)	60 Years (3 Life Cycles)	10%	\$51,733	22	North Bay (North)	\$36,637	22	Trenton (South)	\$40,751
23	Sudbury (North)	60 Years (3 Life Cycles)	10%	\$52,248	23	Sudbury (North)	\$37,161	23	Kingston (South)	\$41,068
24	Timmins (North)	60 Years (3 Life Cycles)	10%	\$53,113	24	Timmins (North)	\$38,028	24	Sudbury (North)	\$40,962
25	Thunder Bay (North)	60 Years (3 Life Cycles)	10%	\$53,461	25	Thunder Bay (North)	\$38,359	25	Kenora (North)	\$40,826
26	Kenora (North)	60 Years (3 Life Cycles)	10%	\$53,731	26	Kenora (North)	\$38,607	26	Timmins (North)	\$41,195
27	Kapuskasing (North)	60 Years (3 Life Cycles)	10%	\$54,321	27	Kapuskasing (North)	\$39,201	27	Kapuskasing (North)	\$45,166

Table F2-1.64: Rankings of cities for rebates scenario (improved construction type) at a discount rate of 10% (three life cycles of V.GSHP and H.GSHP and five life cycles of Traditional HVAC Applications for a 60 year project lifespan)

FIT + Rebates – (#4)

Total Present Value										
(FIT+Rebates) - (#4)										
#	City	Project Life Span	Discount Rate	V.GSHP	#	City	H.GSHP	#	City	Traditional
1	Sarnia (South)	60 Years (3 Life Cycles)	10%	\$34,576	1	St. Catharines (South)	\$23,004	1	Cambridge (South)	\$33,830
2	Chatham (South)	60 Years (3 Life Cycles)	10%	\$34,684	2	Sarnia (South)	\$23,216	2	Guelph (South)	\$34,261
3	Windsor (South)	60 Years (3 Life Cycles)	10%	\$34,692	3	Chatham (South)	\$23,339	3	Barrie (Distinct)	\$35,534
4	Niagara Falls (South)	60 Years (3 Life Cycles)	10%	\$34,812	4	Windsor (South)	\$23,351	4	London (South)	\$36,044
5	Simcoe (South)	60 Years (3 Life Cycles)	10%	\$35,013	5	Niagara Falls (South)	\$23,470	5	Chatham (South)	\$36,663
6	Hamilton (South)	60 Years (3 Life Cycles)	10%	\$35,165	6	Simcoe (South)	\$23,670	6	Windsor (South)	\$36,691
7	Cambridge (South)	60 Years (3 Life Cycles)	10%	\$35,334	7	Hamilton (South)	\$23,823	7	Muskoka (Distinct)	\$36,752
8	London (South)	60 Years (3 Life Cycles)	10%	\$35,337	8	London (South)	\$23,985	8	Sarnia (South)	\$36,973
9	Guelph (South)	60 Years (3 Life Cycles)	10%	\$35,462	9	Cambridge (South)	\$23,992	9	Sault Ste. Marie (North)	\$36,850
10	Sault Ste. Marie (North)	60 Years (3 Life Cycles)	10%	\$36,142	10	Toronto (South)	\$24,005	10	Niagara Falls (South)	\$37,447
11	St. Catharines (South)	60 Years (3 Life Cycles)	10%	\$45,181	11	Guelph (South)	\$24,120	11	St. Catharines (South)	\$37,585
12	Toronto (South)	60 Years (3 Life Cycles)	10%	\$46,148	12	Mt. Forest (South)	\$24,347	12	Toronto (South)	\$37,652
13	Trenton (South)	60 Years (3 Life Cycles)	10%	\$46,249	13	Sault Ste. Marie (North)	\$24,816	13	Ottawa (Distinct)	\$37,971
14	Kitchener-Waterloo (South)	60 Years (3 Life Cycles)	10%	\$46,362	14	Trenton (South)	\$31,090	14	North Bay (North)	\$37,981
15	Mt. Forest (South)	60 Years (3 Life Cycles)	10%	\$46,439	15	Kitchener-Waterloo (South)	\$31,213	15	Hamilton (South)	\$38,106
16	Barrie (Distinct)	60 Years (3 Life Cycles)	10%	\$46,477	16	Barrie (Distinct)	\$31,312	16	Simcoe (South)	\$38,653
17	Ottawa (Distinct)	60 Years (3 Life Cycles)	10%	\$46,508	17	Ottawa (Distinct)	\$31,358	17	Peterborough (Distinct)	\$38,532
18	Kingston (South)	60 Years (3 Life Cycles)	10%	\$46,556	18	Kingston (South)	\$31,407	18	Mt. Forest (South)	\$38,532
19	Warton (South)	60 Years (3 Life Cycles)	10%	\$46,643	19	Warton (South)	\$31,482	19	Kitchener-Waterloo (South)	\$38,706
20	Peterborough (Distinct)	60 Years (3 Life Cycles)	10%	\$46,780	20	Peterborough (Distinct)	\$31,630	20	Warton (South)	\$39,564
21	North Bay (North)	60 Years (3 Life Cycles)	10%	\$46,841	21	Muskoka (Distinct)	\$31,680	21	Thunder Bay (North)	\$40,090
22	Muskoka (Distinct)	60 Years (3 Life Cycles)	10%	\$46,845	22	North Bay (North)	\$31,706	22	Trenton (South)	\$40,751
23	Sudbury (North)	60 Years (3 Life Cycles)	10%	\$47,203	23	Sudbury (North)	\$32,071	23	Kingston (South)	\$41,068
24	Timmins (North)	60 Years (3 Life Cycles)	10%	\$47,806	24	Timmins (North)	\$32,675	24	Sudbury (North)	\$40,962
25	Thunder Bay (North)	60 Years (3 Life Cycles)	10%	\$48,048	25	Thunder Bay (North)	\$32,905	25	Kenora (North)	\$40,826
26	Kenora (North)	60 Years (3 Life Cycles)	10%	\$48,236	26	Kenora (North)	\$33,078	26	Timmins (North)	\$41,195
27	Kapuskasing (North)	60 Years (3 Life Cycles)	10%	\$48,647	27	Kapuskasing (North)	\$33,492	27	Kapuskasing (North)	\$45,166

Table F2-1.65: Rankings of cities for feed-in tariff + rebates scenario (improved construction type) at a discount rate of 10% (three life cycles of V.GSHP and H.GSHP and five life cycles of Traditional HVAC Applications for a 60 year project lifespan)

(FIT + Rebates) + Carbon Taxes – (#5)

Total Present Value										
(FIT+Rebates) + Carbon Taxes - (#5)										
#	City	Project Life Span	Discount Rate	V.GSHP	#	City	H.GSHP	#	City	Traditional
1	Sarnia (South)	60 Years (3 Life Cycles)	10%	\$34,576	1	St. Catharines (South)	\$23,004	1	Cambridge (South)	\$39,811
2	Chatham (South)	60 Years (3 Life Cycles)	10%	\$34,684	2	Sarnia (South)	\$23,216	2	Guelph (South)	\$40,419
3	Windsor (South)	60 Years (3 Life Cycles)	10%	\$34,692	3	Chatham (South)	\$23,339	3	Barrie (Distinct)	\$41,593
4	Niagara Falls (South)	60 Years (3 Life Cycles)	10%	\$34,812	4	Windsor (South)	\$23,351	4	London (South)	\$42,025
5	Simcoe (South)	60 Years (3 Life Cycles)	10%	\$35,013	5	Niagara Falls (South)	\$23,470	5	Chatham (South)	\$42,040
6	Hamilton (South)	60 Years (3 Life Cycles)	10%	\$35,165	6	Simcoe (South)	\$23,670	6	Windsor (South)	\$42,081
7	Cambridge (South)	60 Years (3 Life Cycles)	10%	\$35,334	7	Hamilton (South)	\$23,823	7	Sarnia (South)	\$42,465
8	London (South)	60 Years (3 Life Cycles)	10%	\$35,337	8	London (South)	\$23,985	8	St. Catharines (South)	\$42,849
9	Guelph (South)	60 Years (3 Life Cycles)	10%	\$35,462	9	Cambridge (South)	\$23,992	9	Niagara Falls (South)	\$42,886
10	Sault Ste. Marie (North)	60 Years (3 Life Cycles)	10%	\$36,142	10	Toronto (South)	\$24,005	10	Muskoka (Distinct)	\$43,234
11	St. Catharines (South)	60 Years (3 Life Cycles)	10%	\$45,181	11	Guelph (South)	\$24,120	11	Sault Ste. Marie (North)	\$43,518
12	Toronto (South)	60 Years (3 Life Cycles)	10%	\$46,148	12	Mt. Forest (South)	\$24,347	12	Toronto (South)	\$43,644
13	Trenton (South)	60 Years (3 Life Cycles)	10%	\$46,249	13	Sault Ste. Marie (North)	\$24,816	13	Hamilton (South)	\$43,935
14	Kitchener-Waterloo (South)	60 Years (3 Life Cycles)	10%	\$46,362	14	Trenton (South)	\$31,090	14	Ottawa (Distinct)	\$44,168
15	Mt. Forest (South)	60 Years (3 Life Cycles)	10%	\$46,439	15	Kitchener-Waterloo (South)	\$31,213	15	Simcoe (South)	\$44,353
16	Barrie (Distinct)	60 Years (3 Life Cycles)	10%	\$46,477	16	Barrie (Distinct)	\$31,312	16	North Bay (North)	\$44,504
17	Ottawa (Distinct)	60 Years (3 Life Cycles)	10%	\$46,508	17	Ottawa (Distinct)	\$31,358	17	Kitchener-Waterloo (South)	\$44,878
18	Kingston (South)	60 Years (3 Life Cycles)	10%	\$46,556	18	Kingston (South)	\$31,407	18	Peterborough (Distinct)	\$44,993
19	Warton (South)	60 Years (3 Life Cycles)	10%	\$46,643	19	Warton (South)	\$31,482	19	Mt. Forest (South)	\$45,090
20	Peterborough (Distinct)	60 Years (3 Life Cycles)	10%	\$46,780	20	Peterborough (Distinct)	\$31,630	20	Warton (South)	\$45,962
21	North Bay (North)	60 Years (3 Life Cycles)	10%	\$46,841	21	Muskoka (Distinct)	\$31,680	21	Trenton (South)	\$46,782
22	Muskoka (Distinct)	60 Years (3 Life Cycles)	10%	\$46,845	22	North Bay (North)	\$31,706	22	Kingston (South)	\$47,274
23	Sudbury (North)	60 Years (3 Life Cycles)	10%	\$47,203	23	Sudbury (North)	\$32,071	23	Thunder Bay (North)	\$47,475
24	Timmins (North)	60 Years (3 Life Cycles)	10%	\$47,806	24	Timmins (North)	\$32,675	24	Sudbury (North)	\$47,952
25	Thunder Bay (North)	60 Years (3 Life Cycles)	10%	\$48,048	25	Thunder Bay (North)	\$32,905	25	Kenora (North)	\$48,309
26	Kenora (North)	60 Years (3 Life Cycles)	10%	\$48,236	26	Kenora (North)	\$33,078	26	Timmins (North)	\$48,887
27	Kapuskasing (North)	60 Years (3 Life Cycles)	10%	\$48,647	27	Kapuskasing (North)	\$33,492	27	Kapuskasing (North)	\$53,140

Table F2-1.66: Rankings of cities for feed-in tariff + rebates + carbon tax scenario (improved construction type) at a discount rate of 10% (three life cycles of V.GSHP and H.GSHP and five life cycles of Traditional HVAC Applications for a 60 year project lifespan)

12. Three Life Cycles of V.GSHP and H.GSHP and Five Life Cycles of Traditional HVAC Applications @ 12% Discount Rate

Base Case Scenario

Total Present Value										
Base Case Scenario										
#	City	Project Life Span	Discount Rate	V.GSHP	#	City	H.GSHP	#	City	Traditional
1	Sarnia (South)	60 Years (3 Life Cycles)	12%	\$40,325	1	St. Catharines (South)	\$29,553	1	Cambridge (South)	\$28,760
2	Chatham (South)	60 Years (3 Life Cycles)	12%	\$40,454	2	Sarnia (South)	\$29,805	2	Guelph (South)	\$29,115
3	Windsor (South)	60 Years (3 Life Cycles)	12%	\$40,464	3	Chatham (South)	\$29,951	3	Barrie (Distinct)	\$30,231
4	Niagara Falls (South)	60 Years (3 Life Cycles)	12%	\$40,606	4	Windsor (South)	\$29,966	4	London (South)	\$30,655
5	Simcoe (South)	60 Years (3 Life Cycles)	12%	\$40,845	5	Niagara Falls (South)	\$30,107	5	Chatham (South)	\$31,235
6	Hamilton (South)	60 Years (3 Life Cycles)	12%	\$41,026	6	Simcoe (South)	\$30,345	6	Windsor (South)	\$31,257
7	Cambridge (South)	60 Years (3 Life Cycles)	12%	\$41,227	7	Hamilton (South)	\$30,527	7	Muskoka (Distinct)	\$31,236
8	London (South)	60 Years (3 Life Cycles)	12%	\$41,230	8	London (South)	\$30,720	8	Sarnia (South)	\$31,490
9	Guelph (South)	60 Years (3 Life Cycles)	12%	\$41,380	9	Cambridge (South)	\$30,728	9	Sault Ste. Marie (North)	\$31,315
10	Sault Ste. Marie (North)	60 Years (3 Life Cycles)	12%	\$42,188	10	Toronto (South)	\$30,743	10	Niagara Falls (South)	\$31,884
11	St. Catharines (South)	60 Years (3 Life Cycles)	12%	\$50,154	11	Guelph (South)	\$30,880	11	St. Catharines (South)	\$32,000
12	Toronto (South)	60 Years (3 Life Cycles)	12%	\$51,305	12	Mt. Forest (South)	\$31,150	12	Toronto (South)	\$32,047
13	Trenton (South)	60 Years (3 Life Cycles)	12%	\$51,426	13	Sault Ste. Marie (North)	\$31,708	13	Ottawa (Distinct)	\$32,309
14	Kitchener-Waterloo (South)	60 Years (3 Life Cycles)	12%	\$51,559	14	Trenton (South)	\$37,384	14	North Bay (North)	\$32,314
15	Mt. Forest (South)	60 Years (3 Life Cycles)	12%	\$51,652	15	Kitchener-Waterloo (South)	\$37,529	15	Hamilton (South)	\$32,426
16	Barrie (Distinct)	60 Years (3 Life Cycles)	12%	\$51,697	16	Barrie (Distinct)	\$37,648	16	Simcoe (South)	\$32,940
17	Ottawa (Distinct)	60 Years (3 Life Cycles)	12%	\$51,733	17	Ottawa (Distinct)	\$37,702	17	Peterborough (Distinct)	\$32,772
18	Kingston (South)	60 Years (3 Life Cycles)	12%	\$51,791	18	Kingston (South)	\$37,761	18	Mt. Forest (South)	\$32,771
19	Warton (South)	60 Years (3 Life Cycles)	12%	\$51,894	19	Warton (South)	\$37,849	19	Kitchener-Waterloo (South)	\$32,919
20	Peterborough (Distinct)	60 Years (3 Life Cycles)	12%	\$52,057	20	Peterborough (Distinct)	\$38,026	20	Warton (South)	\$33,687
21	North Bay (North)	60 Years (3 Life Cycles)	12%	\$52,130	21	Muskoka (Distinct)	\$38,085	21	Thunder Bay (North)	\$34,052
22	Muskoka (Distinct)	60 Years (3 Life Cycles)	12%	\$52,134	22	North Bay (North)	\$38,116	22	Trenton (South)	\$34,735
23	Sudbury (North)	60 Years (3 Life Cycles)	12%	\$52,560	23	Sudbury (North)	\$38,550	23	Kingston (South)	\$34,995
24	Timmins (North)	60 Years (3 Life Cycles)	12%	\$53,277	24	Timmins (North)	\$39,269	24	Sudbury (North)	\$34,839
25	Thunder Bay (North)	60 Years (3 Life Cycles)	12%	\$53,566	25	Thunder Bay (North)	\$39,543	25	Kenora (North)	\$34,661
26	Kenora (North)	60 Years (3 Life Cycles)	12%	\$53,789	26	Kenora (North)	\$39,748	26	Timmins (North)	\$34,965
27	Kapuskasing (North)	60 Years (3 Life Cycles)	12%	\$54,278	27	Kapuskasing (North)	\$40,241	27	Kapuskasing (North)	\$38,372

Table F2-1.67: Rankings of cities for base case scenario (improved construction type) at a discount rate of 12% (three life cycles of V.GSHP and H.GSHP and five life cycles of Traditional HVAC Applications for a 60 year project lifespan)

Carbon Taxes – (#1)

Total Present Value										
Carbon Taxes - (#1)										
#	City	Project Life Span	Discount Rate	V.GSHP	#	City	H.GSHP	#	City	Traditional
1	Sarnia (South)	60 Years (3 Life Cycles)	12%	\$40,325	1	St. Catharines (South)	\$29,553	1	Cambridge (South)	\$33,045
2	Chatham (South)	60 Years (3 Life Cycles)	12%	\$40,454	2	Sarnia (South)	\$29,805	2	Guelph (South)	\$33,527
3	Windsor (South)	60 Years (3 Life Cycles)	12%	\$40,464	3	Chatham (South)	\$29,951	3	Barrie (Distinct)	\$34,572
4	Niagara Falls (South)	60 Years (3 Life Cycles)	12%	\$40,606	4	Windsor (South)	\$29,966	4	London (South)	\$34,939
5	Simcoe (South)	60 Years (3 Life Cycles)	12%	\$40,845	5	Niagara Falls (South)	\$30,107	5	Chatham (South)	\$35,086
6	Hamilton (South)	60 Years (3 Life Cycles)	12%	\$41,026	6	Simcoe (South)	\$30,345	6	Windsor (South)	\$35,119
7	Cambridge (South)	60 Years (3 Life Cycles)	12%	\$41,227	7	Hamilton (South)	\$30,527	7	Sarnia (South)	\$35,425
8	London (South)	60 Years (3 Life Cycles)	12%	\$41,230	8	London (South)	\$30,720	8	St. Catharines (South)	\$35,771
9	Guelph (South)	60 Years (3 Life Cycles)	12%	\$41,380	9	Cambridge (South)	\$30,728	9	Niagara Falls (South)	\$35,780
10	Sault Ste. Marie (North)	60 Years (3 Life Cycles)	12%	\$42,188	10	Toronto (South)	\$30,743	10	Muskoka (Distinct)	\$35,879
11	St. Catharines (South)	60 Years (3 Life Cycles)	12%	\$50,154	11	Guelph (South)	\$30,880	11	Sault Ste. Marie (North)	\$36,092
12	Toronto (South)	60 Years (3 Life Cycles)	12%	\$51,305	12	Mt. Forest (South)	\$31,150	12	Toronto (South)	\$36,340
13	Trenton (South)	60 Years (3 Life Cycles)	12%	\$51,426	13	Sault Ste. Marie (North)	\$31,708	13	Hamilton (South)	\$36,601
14	Kitchener-Waterloo (South)	60 Years (3 Life Cycles)	12%	\$51,559	14	Trenton (South)	\$37,384	14	Ottawa (Distinct)	\$36,749
15	Mt. Forest (South)	60 Years (3 Life Cycles)	12%	\$51,652	15	Kitchener-Waterloo (South)	\$37,529	15	North Bay (North)	\$36,987
16	Barrie (Distinct)	60 Years (3 Life Cycles)	12%	\$51,697	16	Barrie (Distinct)	\$37,648	16	Simcoe (South)	\$37,024
17	Ottawa (Distinct)	60 Years (3 Life Cycles)	12%	\$51,733	17	Ottawa (Distinct)	\$37,702	17	Kitchener-Waterloo (South)	\$37,340
18	Kingston (South)	60 Years (3 Life Cycles)	12%	\$51,791	18	Kingston (South)	\$37,761	18	Peterborough (Distinct)	\$37,400
19	Warton (South)	60 Years (3 Life Cycles)	12%	\$51,894	19	Warton (South)	\$37,849	19	Mt. Forest (South)	\$37,469
20	Peterborough (Distinct)	60 Years (3 Life Cycles)	12%	\$52,057	20	Peterborough (Distinct)	\$38,026	20	Warton (South)	\$38,271
21	North Bay (North)	60 Years (3 Life Cycles)	12%	\$52,130	21	Muskoka (Distinct)	\$38,085	21	Trenton (South)	\$39,056
22	Muskoka (Distinct)	60 Years (3 Life Cycles)	12%	\$52,134	22	North Bay (North)	\$38,116	22	Thunder Bay (North)	\$39,343
23	Sudbury (North)	60 Years (3 Life Cycles)	12%	\$52,560	23	Sudbury (North)	\$38,550	23	Kingston (South)	\$39,442
24	Timmins (North)	60 Years (3 Life Cycles)	12%	\$53,277	24	Timmins (North)	\$39,269	24	Sudbury (North)	\$39,847
25	Thunder Bay (North)	60 Years (3 Life Cycles)	12%	\$53,566	25	Thunder Bay (North)	\$39,543	25	Kenora (North)	\$40,022
26	Kenora (North)	60 Years (3 Life Cycles)	12%	\$53,789	26	Kenora (North)	\$39,748	26	Timmins (North)	\$40,475
27	Kapuskasing (North)	60 Years (3 Life Cycles)	12%	\$54,278	27	Kapuskasing (North)	\$40,241	27	Kapuskasing (North)	\$44,085

Table F2-1.68: Rankings of cities for carbon taxes scenario (improved construction type) at a discount rate of 12% (three life cycles of V.GSHP and H.GSHP and five life cycles of Traditional HVAC Applications for a 60 year project lifespan)

FIT – (#2)

Total Present Value										
FIT - (#2)										
#	City	Project Life Span	Discount Rate	V.GSHP	#	City	H.GSHP	#	City	Traditional
1	Sarnia (South)	60 Years (3 Life Cycles)	12%	\$36,888	1	St. Catharines (South)	\$26,169	1	Cambridge (South)	\$28,760
2	Chatham (South)	60 Years (3 Life Cycles)	12%	\$36,978	2	Sarnia (South)	\$26,344	2	Guelph (South)	\$29,115
3	Windsor (South)	60 Years (3 Life Cycles)	12%	\$36,985	3	Chatham (South)	\$26,445	3	Barrie (Distinct)	\$30,231
4	Niagara Falls (South)	60 Years (3 Life Cycles)	12%	\$37,084	4	Windsor (South)	\$26,455	4	London (South)	\$30,655
5	Simcoe (South)	60 Years (3 Life Cycles)	12%	\$37,249	5	Niagara Falls (South)	\$26,554	5	Chatham (South)	\$31,235
6	Hamilton (South)	60 Years (3 Life Cycles)	12%	\$37,375	6	Simcoe (South)	\$26,719	6	Windsor (South)	\$31,257
7	Cambridge (South)	60 Years (3 Life Cycles)	12%	\$37,515	7	Hamilton (South)	\$26,845	7	Muskoka (Distinct)	\$31,236
8	London (South)	60 Years (3 Life Cycles)	12%	\$37,517	8	London (South)	\$26,979	8	Sarnia (South)	\$31,490
9	Guelph (South)	60 Years (3 Life Cycles)	12%	\$37,621	9	Cambridge (South)	\$26,985	9	Sault Ste. Marie (North)	\$31,315
10	Sault Ste. Marie (North)	60 Years (3 Life Cycles)	12%	\$38,182	10	Toronto (South)	\$26,995	10	Niagara Falls (South)	\$31,884
11	St. Catharines (South)	60 Years (3 Life Cycles)	12%	\$46,676	11	Guelph (South)	\$27,091	11	St. Catharines (South)	\$32,000
12	Toronto (South)	60 Years (3 Life Cycles)	12%	\$47,475	12	Mt. Forest (South)	\$27,278	12	Toronto (South)	\$32,047
13	Trenton (South)	60 Years (3 Life Cycles)	12%	\$47,559	13	Sault Ste. Marie (North)	\$27,665	13	Ottawa (Distinct)	\$32,309
14	Kitchener-Waterloo (South)	60 Years (3 Life Cycles)	12%	\$47,652	14	Trenton (South)	\$33,489	14	North Bay (North)	\$32,314
15	Mt. Forest (South)	60 Years (3 Life Cycles)	12%	\$47,716	15	Kitchener-Waterloo (South)	\$33,590	15	Hamilton (South)	\$32,426
16	Barrie (Distinct)	60 Years (3 Life Cycles)	12%	\$47,747	16	Barrie (Distinct)	\$33,673	16	Simcoe (South)	\$32,940
17	Ottawa (Distinct)	60 Years (3 Life Cycles)	12%	\$47,773	17	Ottawa (Distinct)	\$33,710	17	Peterborough (Distinct)	\$32,772
18	Kingston (South)	60 Years (3 Life Cycles)	12%	\$47,812	18	Kingston (South)	\$33,751	18	Mt. Forest (South)	\$32,771
19	Warton (South)	60 Years (3 Life Cycles)	12%	\$47,884	19	Warton (South)	\$33,812	19	Kitchener-Waterloo (South)	\$32,919
20	Peterborough (Distinct)	60 Years (3 Life Cycles)	12%	\$47,998	20	Peterborough (Distinct)	\$33,935	20	Warton (South)	\$33,687
21	North Bay (North)	60 Years (3 Life Cycles)	12%	\$48,048	21	Muskoka (Distinct)	\$33,976	21	Thunder Bay (North)	\$34,052
22	Muskoka (Distinct)	60 Years (3 Life Cycles)	12%	\$48,051	22	North Bay (North)	\$33,998	22	Trenton (South)	\$34,735
23	Sudbury (North)	60 Years (3 Life Cycles)	12%	\$48,346	23	Sudbury (North)	\$34,299	23	Kingston (South)	\$34,995
24	Timmins (North)	60 Years (3 Life Cycles)	12%	\$48,845	24	Timmins (North)	\$34,798	24	Sudbury (North)	\$34,839
25	Thunder Bay (North)	60 Years (3 Life Cycles)	12%	\$49,045	25	Thunder Bay (North)	\$34,988	25	Kenora (North)	\$34,661
26	Kenora (North)	60 Years (3 Life Cycles)	12%	\$49,200	26	Kenora (North)	\$35,131	26	Timmins (North)	\$34,965
27	Kapuskasing (North)	60 Years (3 Life Cycles)	12%	\$49,539	27	Kapuskasing (North)	\$35,473	27	Kapuskasing (North)	\$38,372

Table F2-1.69: Rankings of cities for feed-in tariff scenario (improved construction type) at a discount rate of 12% (three life cycles of V.GSHP and H.GSHP and five life cycles of Traditional HVAC Applications for a 60 year project lifespan)

Rebates – (#3)

Total Present Value										
Rebates - (#3)										
#	City	Project Life Span	Discount Rate	V.GSHP	#	City	H.GSHP	#	City	Traditional
1	Sarnia (South)	60 Years (3 Life Cycles)	12%	\$34,436	1	St. Catharines (South)	\$23,664	1	Cambridge (South)	\$28,760
2	Chatham (South)	60 Years (3 Life Cycles)	12%	\$34,565	2	Sarnia (South)	\$23,916	2	Guelph (South)	\$29,115
3	Windsor (South)	60 Years (3 Life Cycles)	12%	\$34,575	3	Chatham (South)	\$24,062	3	Barrie (Distinct)	\$30,231
4	Niagara Falls (South)	60 Years (3 Life Cycles)	12%	\$34,718	4	Windsor (South)	\$24,077	4	London (South)	\$30,655
5	Simcoe (South)	60 Years (3 Life Cycles)	12%	\$34,956	5	Niagara Falls (South)	\$24,218	5	Chatham (South)	\$31,235
6	Hamilton (South)	60 Years (3 Life Cycles)	12%	\$35,137	6	Simcoe (South)	\$24,457	6	Windsor (South)	\$31,257
7	Cambridge (South)	60 Years (3 Life Cycles)	12%	\$35,338	7	Hamilton (South)	\$24,638	7	Muskoka (Distinct)	\$31,236
8	London (South)	60 Years (3 Life Cycles)	12%	\$35,341	8	London (South)	\$24,831	8	Sarnia (South)	\$31,490
9	Guelph (South)	60 Years (3 Life Cycles)	12%	\$35,491	9	Cambridge (South)	\$24,839	9	Sault Ste. Marie (North)	\$31,315
10	Sault Ste. Marie (North)	60 Years (3 Life Cycles)	12%	\$36,299	10	Toronto (South)	\$24,854	10	Niagara Falls (South)	\$31,884
11	St. Catharines (South)	60 Years (3 Life Cycles)	12%	\$44,265	11	Guelph (South)	\$24,992	11	St. Catharines (South)	\$32,000
12	Toronto (South)	60 Years (3 Life Cycles)	12%	\$45,416	12	Mt. Forest (South)	\$25,261	12	Toronto (South)	\$32,047
13	Trenton (South)	60 Years (3 Life Cycles)	12%	\$45,537	13	Sault Ste. Marie (North)	\$25,819	13	Ottawa (Distinct)	\$32,309
14	Kitchener-Waterloo (South)	60 Years (3 Life Cycles)	12%	\$45,670	14	Trenton (South)	\$31,495	14	North Bay (North)	\$32,314
15	Mt. Forest (South)	60 Years (3 Life Cycles)	12%	\$45,763	15	Kitchener-Waterloo (South)	\$31,640	15	Hamilton (South)	\$32,426
16	Barrie (Distinct)	60 Years (3 Life Cycles)	12%	\$45,808	16	Barrie (Distinct)	\$31,759	16	Simcoe (South)	\$32,940
17	Ottawa (Distinct)	60 Years (3 Life Cycles)	12%	\$45,845	17	Ottawa (Distinct)	\$31,813	17	Peterborough (Distinct)	\$32,772
18	Kingston (South)	60 Years (3 Life Cycles)	12%	\$45,902	18	Kingston (South)	\$31,872	18	Mt. Forest (South)	\$32,771
19	Warton (South)	60 Years (3 Life Cycles)	12%	\$46,005	19	Warton (South)	\$31,960	19	Kitchener-Waterloo (South)	\$32,919
20	Peterborough (Distinct)	60 Years (3 Life Cycles)	12%	\$46,169	20	Peterborough (Distinct)	\$32,137	20	Warton (South)	\$33,687
21	North Bay (North)	60 Years (3 Life Cycles)	12%	\$46,241	21	Muskoka (Distinct)	\$32,196	21	Thunder Bay (North)	\$34,052
22	Muskoka (Distinct)	60 Years (3 Life Cycles)	12%	\$46,245	22	North Bay (North)	\$32,227	22	Trenton (South)	\$34,735
23	Sudbury (North)	60 Years (3 Life Cycles)	12%	\$46,671	23	Sudbury (North)	\$32,661	23	Kingston (South)	\$34,995
24	Timmins (North)	60 Years (3 Life Cycles)	12%	\$47,388	24	Timmins (North)	\$33,380	24	Sudbury (North)	\$34,839
25	Thunder Bay (North)	60 Years (3 Life Cycles)	12%	\$47,677	25	Thunder Bay (North)	\$33,654	25	Kenora (North)	\$34,661
26	Kenora (North)	60 Years (3 Life Cycles)	12%	\$47,900	26	Kenora (North)	\$33,859	26	Timmins (North)	\$34,965
27	Kapuskasing (North)	60 Years (3 Life Cycles)	12%	\$48,389	27	Kapuskasing (North)	\$34,352	27	Kapuskasing (North)	\$38,372

Table F2-1.70: Rankings of cities for rebates scenario (improved construction type) at a discount rate of 12% (three life cycles of V.GSHP and H.GSHP and five life cycles of Traditional HVAC Applications for a 60 year project lifespan)

FIT + Rebates – (#4)

Total Present Value										
(FIT+Rebates) - (#4)										
#	City	Project Life Span	Discount Rate	V.GSHP	#	City	H.GSHP	#	City	Traditional
1	Sarnia (South)	60 Years (3 Life Cycles)	12%	\$30,999	1	St. Catharines (South)	\$20,280	1	Cambridge (South)	\$28,760
2	Chatham (South)	60 Years (3 Life Cycles)	12%	\$31,089	2	Sarnia (South)	\$20,455	2	Guelph (South)	\$29,115
3	Windsor (South)	60 Years (3 Life Cycles)	12%	\$31,096	3	Chatham (South)	\$20,556	3	Barrie (Distinct)	\$30,231
4	Niagara Falls (South)	60 Years (3 Life Cycles)	12%	\$31,195	4	Windsor (South)	\$20,567	4	London (South)	\$30,655
5	Simcoe (South)	60 Years (3 Life Cycles)	12%	\$31,360	5	Niagara Falls (South)	\$20,665	5	Chatham (South)	\$31,235
6	Hamilton (South)	60 Years (3 Life Cycles)	12%	\$31,486	6	Simcoe (South)	\$20,830	6	Windsor (South)	\$31,257
7	Cambridge (South)	60 Years (3 Life Cycles)	12%	\$31,626	7	Hamilton (South)	\$20,956	7	Muskoka (Distinct)	\$31,236
8	London (South)	60 Years (3 Life Cycles)	12%	\$31,628	8	London (South)	\$21,090	8	Sarnia (South)	\$31,490
9	Guelph (South)	60 Years (3 Life Cycles)	12%	\$31,732	9	Cambridge (South)	\$21,096	9	Sault Ste. Marie (North)	\$31,315
10	Sault Ste. Marie (North)	60 Years (3 Life Cycles)	12%	\$32,293	10	Toronto (South)	\$21,106	10	Niagara Falls (South)	\$31,884
11	St. Catharines (South)	60 Years (3 Life Cycles)	12%	\$40,788	11	Guelph (South)	\$21,202	11	St. Catharines (South)	\$32,000
12	Toronto (South)	60 Years (3 Life Cycles)	12%	\$41,586	12	Mt. Forest (South)	\$21,389	12	Toronto (South)	\$32,047
13	Trenton (South)	60 Years (3 Life Cycles)	12%	\$41,670	13	Sault Ste. Marie (North)	\$21,776	13	Ottawa (Distinct)	\$32,309
14	Kitchener-Waterloo (South)	60 Years (3 Life Cycles)	12%	\$41,763	14	Trenton (South)	\$27,600	14	North Bay (North)	\$32,314
15	Mt. Forest (South)	60 Years (3 Life Cycles)	12%	\$41,827	15	Kitchener-Waterloo (South)	\$27,702	15	Hamilton (South)	\$32,426
16	Barrie (Distinct)	60 Years (3 Life Cycles)	12%	\$41,858	16	Barrie (Distinct)	\$27,784	16	Simcoe (South)	\$32,940
17	Ottawa (Distinct)	60 Years (3 Life Cycles)	12%	\$41,884	17	Ottawa (Distinct)	\$27,822	17	Peterborough (Distinct)	\$32,772
18	Kingston (South)	60 Years (3 Life Cycles)	12%	\$41,924	18	Kingston (South)	\$27,862	18	Mt. Forest (South)	\$32,771
19	Warton (South)	60 Years (3 Life Cycles)	12%	\$41,995	19	Warton (South)	\$27,924	19	Kitchener-Waterloo (South)	\$32,919
20	Peterborough (Distinct)	60 Years (3 Life Cycles)	12%	\$42,109	20	Peterborough (Distinct)	\$28,046	20	Warton (South)	\$33,687
21	North Bay (North)	60 Years (3 Life Cycles)	12%	\$42,159	21	Muskoka (Distinct)	\$28,087	21	Thunder Bay (North)	\$34,052
22	Muskoka (Distinct)	60 Years (3 Life Cycles)	12%	\$42,162	22	North Bay (North)	\$28,109	22	Trenton (South)	\$34,735
23	Sudbury (North)	60 Years (3 Life Cycles)	12%	\$42,458	23	Sudbury (North)	\$28,410	23	Kingston (South)	\$34,995
24	Timmins (North)	60 Years (3 Life Cycles)	12%	\$42,956	24	Timmins (North)	\$28,909	24	Sudbury (North)	\$34,839
25	Thunder Bay (North)	60 Years (3 Life Cycles)	12%	\$43,156	25	Thunder Bay (North)	\$29,099	25	Kenora (North)	\$34,661
26	Kenora (North)	60 Years (3 Life Cycles)	12%	\$43,311	26	Kenora (North)	\$29,242	26	Timmins (North)	\$34,965
27	Kapuskasing (North)	60 Years (3 Life Cycles)	12%	\$43,650	27	Kapuskasing (North)	\$29,584	27	Kapuskasing (North)	\$38,372

Table F2-1.71: Rankings of cities for feed-in tariff + rebates scenario (improved construction type) at a discount rate of 12% (three life cycles of V.GSHP and H.GSHP and five life cycles of Traditional HVAC Applications for a 60 year project lifespan)

(FIT + Rebates) + Carbon Taxes – (#5)

Total Present Value										
(FIT+Rebates) + Carbon Taxes - (#5)										
#	City	Project Life Span	Discount Rate	V.GSHP	#	City	H.GSHP	#	City	Traditional
1	Sarnia (South)	60 Years (3 Life Cycles)	12%	\$30,999	1	St. Catharines (South)	\$20,280	1	Cambridge (South)	\$33,045
2	Chatham (South)	60 Years (3 Life Cycles)	12%	\$31,089	2	Sarnia (South)	\$20,455	2	Guelph (South)	\$33,527
3	Windsor (South)	60 Years (3 Life Cycles)	12%	\$31,096	3	Chatham (South)	\$20,556	3	Barrie (Distinct)	\$34,572
4	Niagara Falls (South)	60 Years (3 Life Cycles)	12%	\$31,195	4	Windsor (South)	\$20,567	4	London (South)	\$34,939
5	Simcoe (South)	60 Years (3 Life Cycles)	12%	\$31,360	5	Niagara Falls (South)	\$20,665	5	Chatham (South)	\$35,086
6	Hamilton (South)	60 Years (3 Life Cycles)	12%	\$31,486	6	Simcoe (South)	\$20,830	6	Windsor (South)	\$35,119
7	Cambridge (South)	60 Years (3 Life Cycles)	12%	\$31,626	7	Hamilton (South)	\$20,956	7	Sarnia (South)	\$35,425
8	London (South)	60 Years (3 Life Cycles)	12%	\$31,628	8	London (South)	\$21,090	8	St. Catharines (South)	\$35,771
9	Guelph (South)	60 Years (3 Life Cycles)	12%	\$31,732	9	Cambridge (South)	\$21,096	9	Niagara Falls (South)	\$35,780
10	Sault Ste. Marie (North)	60 Years (3 Life Cycles)	12%	\$32,293	10	Toronto (South)	\$21,106	10	Muskoka (Distinct)	\$35,879
11	St. Catharines (South)	60 Years (3 Life Cycles)	12%	\$40,788	11	Guelph (South)	\$21,202	11	Sault Ste. Marie (North)	\$36,092
12	Toronto (South)	60 Years (3 Life Cycles)	12%	\$41,586	12	Mt. Forest (South)	\$21,389	12	Toronto (South)	\$36,340
13	Trenton (South)	60 Years (3 Life Cycles)	12%	\$41,670	13	Sault Ste. Marie (North)	\$21,776	13	Hamilton (South)	\$36,601
14	Kitchener-Waterloo (South)	60 Years (3 Life Cycles)	12%	\$41,763	14	Trenton (South)	\$27,600	14	Ottawa (Distinct)	\$36,749
15	Mt. Forest (South)	60 Years (3 Life Cycles)	12%	\$41,827	15	Kitchener-Waterloo (South)	\$27,702	15	North Bay (North)	\$36,987
16	Barrie (Distinct)	60 Years (3 Life Cycles)	12%	\$41,858	16	Barrie (Distinct)	\$27,784	16	Simcoe (South)	\$37,024
17	Ottawa (Distinct)	60 Years (3 Life Cycles)	12%	\$41,884	17	Ottawa (Distinct)	\$27,822	17	Kitchener-Waterloo (South)	\$37,340
18	Kingston (South)	60 Years (3 Life Cycles)	12%	\$41,924	18	Kingston (South)	\$27,862	18	Peterborough (Distinct)	\$37,400
19	Warton (South)	60 Years (3 Life Cycles)	12%	\$41,995	19	Warton (South)	\$27,924	19	Mt. Forest (South)	\$37,469
20	Peterborough (Distinct)	60 Years (3 Life Cycles)	12%	\$42,109	20	Peterborough (Distinct)	\$28,046	20	Warton (South)	\$38,271
21	North Bay (North)	60 Years (3 Life Cycles)	12%	\$42,159	21	Muskoka (Distinct)	\$28,087	21	Trenton (South)	\$39,056
22	Muskoka (Distinct)	60 Years (3 Life Cycles)	12%	\$42,162	22	North Bay (North)	\$28,109	22	Thunder Bay (North)	\$39,343
23	Sudbury (North)	60 Years (3 Life Cycles)	12%	\$42,458	23	Sudbury (North)	\$28,410	23	Kingston (South)	\$39,442
24	Timmins (North)	60 Years (3 Life Cycles)	12%	\$42,956	24	Timmins (North)	\$28,909	24	Sudbury (North)	\$39,847
25	Thunder Bay (North)	60 Years (3 Life Cycles)	12%	\$43,156	25	Thunder Bay (North)	\$29,099	25	Kenora (North)	\$40,022
26	Kenora (North)	60 Years (3 Life Cycles)	12%	\$43,311	26	Kenora (North)	\$29,242	26	Timmins (North)	\$40,475
27	Kapuskasing (North)	60 Years (3 Life Cycles)	12%	\$43,650	27	Kapuskasing (North)	\$29,584	27	Kapuskasing (North)	\$44,085

Table F2-1.72: Rankings of cities for feed-in tariff + rebates + carbon tax scenario (improved construction type) at a discount rate of 12% (three life cycles of V.GSHP and H.GSHP and five life cycles of Traditional HVAC Applications for a 60 year project lifespan)