

# **The Intrinsic Agent**

Working with Light

*by*

Trimira Anil Garach

A thesis  
presented to the University of Waterloo  
in fulfillment of the  
thesis requirement for the degree of  
Master of Architecture

Waterloo, Ontario, Canada, 2017

© Trimira Anil Garach 2017

## **AUTHOR'S DECLARATION**

---

I hereby declare that I am the sole author of this thesis.  
This is a true copy of the thesis, including any required final  
revisions, as accepted by my examiners.

I understand that my thesis may be made electronically  
available to the public.

## ABSTRACT

---

Architecture's intrinsic natural agent, light, is an elusive and mysterious figure in the process of architectural design. The very phenomenon that reveals to us the contents, materials, and proportions of a space is frequently a passive, incidental occupant. Its potential to affect our perception of architecture and architectural space is clear in religious spaces, where it plays the role of spiritual metaphor, and in artistic installation work, where it is often exposed as a fascinating physical phenomenon. These works have a greater capacity to reveal light's potential because they utilise it as a primary conceptual tool or catalyst. However, to position light as a necessary overarching conceptual driver of all architectural work because of its pervasiveness is an unreasonable proposition. Instead, *The Intrinsic Agent* advocates for a greater engagement with light throughout the architectural design process for its *communicative power*<sup>1</sup>, its ability to reinforce and reveal various larger project concepts and tectonic strategies.

*The Intrinsic Agent* documents the process of finding a methodology of involving light in architectural design. It begins by analysing the positions and tools offered by architectural

lighting design and phenomenology and testing the diagrammatic case study, a traditional pedagogical tool, for its effectiveness in revealing an evolvable light strategy. Parametric and computational tools, commonly used to evaluate light, are then introduced as an alternative means by which to physically capture ambient light information and acknowledge its presence. Finding these two avenues lacking as generative methods, knowledge from the fields of architectural lighting design, phenomenology, and optics (the physics of light) is combined and presented in the form of a methodological reference. The reference offers architects and students a loosely structured method of designing with light using three main elements: a system strategy, archetypes of light effect, and optic devices and their parameters. The reference can be used to analyse projects and generate systems of involving light in design using common terms, providing a foundation for discourse and development in this area. For clarity, the reference is then used to study and identify the system strategy of a built project which is then expanded upon and applied in the proposed design of an addition to the building.

---

1 Francois Mangion and Shuchi Agarwal, "Virtual Light," Francois Mangion, accessed November 9, 2016, <http://www.francoismangion.com/?project=virtual-light>.

## ACKNOWLEDGEMENTS

---

Thank you to Dereck Revington for his patience, tenacity, and intuition throughout the process of refining the trajectory of my thesis. It is with your guidance that I was able to find the questions that mattered to me most, and with your enthusiasm that I pushed myself to develop a nuanced, measured answer.

Thank you to David Correa for joining my thesis committee without hesitation at a critical moment. Your thoughtful questions changed my perspective in a way that allowed me to reflect on my work critically and effectively, and to direct my thesis toward a more productive outcome.

Thank you to Rick Andrighetti for his enthusiasm toward my work and ambitions. Your encouraging attitude and design acumen helped me to develop my design work further in moments of frustration, and to have faith in my work, both now and as an undergraduate student.

Thank you to Ila Berman for her early contributions to my thesis and for encouraging me to pursue an aesthetic argument.

Thank you to my family. Thank you to my mum and dad for all of your love, support, and faith in me. Thank you to Mehul for displaying my work with pride in your apartment and for always cheering me on. Thank you to Vatsal for patiently discussing my work with me for hours and for your advice that has deeply impacted my work.

Thank you to all of my studiomates for their conversation and camaraderie. Thank you to Safira and Paniz for their warmth and friendship, and for all of our shared meals, experiences, and laughter. Lastly, thank you to Ronald for being the most wonderful, steadfast companion I could have hoped to have from start to finish.





# table of contents

## PREFACE

*author's declaration*

*abstract*

*acknowledgements*

*dedication*

*list of figures*

ii  
iii  
iv  
v  
viii

## INTRODUCTION

*a hypothesis*

1

## PART I\_AESTHETIC PEDAGOGY

### **THE STATUS QUO**

*present light pedagogy*

7

### **THE CASE STUDY**

*lumière en vibration*

15

## PART II\_TESTING PARAMETRICS

### **EVALUATING LIGHT**

*gangxia urban village*

45

### **CAPTURING LIGHT**

*experimenting with information*

59

## PART III\_A METHODOLOGICAL REFERENCE

### **INTRODUCTION**

*developing a reference*

79

### **SYSTEM STRATEGY**

91

### **ARCHETYPES**

93

### **OPTIC DEVICES**

109

## PART IV\_DESIGNING WITH LIGHT

### **SEASHORE LIBRARY**

*an analysis*

131

### **SEASHORE DWELLING**

*testing the reference*

141

### **REFLECTION**

*applying the methodology*

209

## CONCLUSION

*embracing potential*

211

*bibliography*

214

LIST OF FIGURES

<b>Fig. 1 Francis Mangion, <i>Architecture of Light</i></b>	
Francis Mangion, <i>Architecture of Light: Caustic Architecture</i> January 23, 2014, Digital Image. Available from: <i>architecture lab</i> . Accessed December 21, 2015. <a href="http://architecturelab.net/architecture-light-caustic-architecture/">http://architecturelab.net/architecture-light-caustic-architecture/</a> .	xviii
<b>Fig. 2 Tadao Ando, <i>Church of Light</i></b>	
Andy B., <i>Church of the Light cruciform</i> , April 26, 2014, Digital Image. Available from: <i>Flickr</i> . Accessed July 6, 2017. <a href="https://www.flickr.com/photos/andyb/14091709803/">https://www.flickr.com/photos/andyb/14091709803/</a> .	6
<b>Fig. 3 Visual Hierarchy of a Storefront Window</b>	
<i>Effects of luminance in accentuating or negating perception of depth through a window</i> . Scanned Image. In: <i>Architectural Lighting: Designing with Light and Space</i> ((New York: Princeton Architectural Press, 2011), 35.	10
<b>Fig. 4 Reflected Orange Light in Holl's Chapel of St. Ignatius</b>	
Mabel, Joe. <i>Chapel of St. Ignatius</i> , Seattle University. September 30, 2007. Available from: <i>Wikimedia Commons</i> . Accessed July 6, 2017. <a href="https://commons.wikimedia.org/wiki/File:Seattle_U_St_Ignatius_22.jpg">https://commons.wikimedia.org/wiki/File:Seattle_U_St_Ignatius_22.jpg</a> .	12
<b>Fig. 5 Waves of Light in Le Corbusier's Church at Firminy</b>	
Plummer, Henry. <i>View looking south to "upwardly springing" waves of light</i> . 2011. Available from: <i>ArchDaily</i> . Accessed July 6, 2017. <a href="http://www.archdaily.com/597598/light-matters-le-corbusier-and-the-trinity-of-light">http://www.archdaily.com/597598/light-matters-le-corbusier-and-the-trinity-of-light</a>	12
<b>Fig. 6 Lumière en Vibration, 1968</b>	
Fritschi, Adrian. <i>Lumière en Vibration, 1968</i> . Zurich. In <i>Livin Cool</i> . November 25, 2014. Accessed December 19, 2015. <a href="http://www.livincool.com/art/julio-le-parc-at-serpentine-sackler-gallery/attachment/2-lumiere-en-vibration">http://www.livincool.com/art/julio-le-parc-at-serpentine-sackler-gallery/attachment/2-lumiere-en-vibration</a> .	14
<b>Fig. 7 Light Source at Center of Installation</b>	
<i>Lumière en Vibrations - Julio Le PARC</i> . March 2, 2012. Available from: <i>Flickr</i> . Accessed December 19, 2015. <a href="https://www.flickr.com/photos/daily-b/6915257036">https://www.flickr.com/photos/daily-b/6915257036</a> .	16
<b>Fig. 8 Registration of Light</b>	
Image by author.	16
<b>Fig. 9 Digitally Replicated Frontal Image</b>	
Image by author.	18
<b>Fig. 10 Plan Showing Panel Rotation</b>	
Image by author.	20
<b>Fig. 11 Depth of installation</b>	
Image by author.	20
<b>Fig. 12 Light Source (Side Elevation)</b>	
Image by author.	22
<b>Fig. 13 Logic of Panel Layout</b>	
Image by author.	22
<b>Fig. 14 Rectilinear and Radial Organisations of Panel Layout</b>	
Image by author.	24
<b>Fig. 16 Horizontal Delamination Diagram Series</b>	
Image by author.	26
<b>Fig. 15 Interaction of Light and Fabric (Front Elevation)</b>	
Image by author.	26
<b>Fig. 17 Intersection of Light Rays and Panels</b>	
Image by author.	28
<b>Fig. 18 Front Elevation of Compiled Intersection Points</b>	
Image by author.	29
<b>Fig. 19 Front Elevation of Compiled Intersection Points</b>	
Image by author.	29
<b>Fig. 20 Delaminated Light Volumes</b>	
Image by author.	29
<b>Fig. 21 Compiled Planar Sections Showing Points of Intersection</b>	
Image by author.	30



<b>Fig. 22</b>	<b>Compiled Volumetric Sections</b> Image by author.	32
<b>Fig. 23</b>	<b>Collapsed Radial Array</b> Image by author.	34
<b>Fig. 24</b>	<b>Radial Array of Light Projected onto Panels</b> Image by author.	34
<b>Fig. 25</b>	<b>Concentric Rectangular Array of Panel Elevations</b> Image by author.	36
<b>Fig. 26</b>	<b>Columnar Delamination Illustrating Light Decay</b> Image by author.	37
<b>Fig. 27</b>	<b>Diagram of Ideas - "The Smooth and the Striated"</b> Image by author.	38
<b>Fig. 28</b>	<b>Diagram of Ideas - <i>The Architect's Brain</i></b> Image by author.	40
<b>Fig. 29</b>	<b>Urban Villages in Shenzhen</b> Zhang, Lily. "Urban Villages' Locations in Shenzhen." Digital image. <i>AA School</i> . 2014. Accessed December 19, 2015. <a href="http://pr2014.aaschool.ac.uk/DIP-02/Li%20Zhang">http://pr2014.aaschool.ac.uk/DIP-02/Li Zhang</a> .	44
<b>Fig. 30</b>	<b>Location of Shenzhen in China</b> Dederling, Uwe. "Shenzhen Is Located in China." Digital image. <i>Wikipedia</i> . March 3, 2010. Accessed December 19, 2015. <a href="https://en.wikipe">https://en.wikipe</a>	44
<b>Fig. 31</b>	<b>Gangxia Urban Village</b> "Urbanus-gangxia Village." Digital image. <i>Architettura. Ricerca. Citta</i> . July 10, 2012. Accessed December 19, 2015. <a href="http://www.arcduccitta.it/world/2012/07/notes-on-urban-villages-as-a-global-condition/">http://www.arcduccitta.it/world/2012/07/notes-on-urban-villages-as-a-global-condition/</a> .	46
<b>Fig. 32</b>	<b>Gangxia Urban Village Plan</b> Image by author.	47
<b>Fig. 33</b>	<b>Summer Solstice Ladybug Daylight Analysis</b> Image by author.	48
<b>Fig. 34</b>	<b>Ray Tracing Within Urban Fabric (Summer Solstice)</b> Image by author.	50
<b>Fig. 35</b>	<b>Ray Tracing Within Urban Fabric</b> Image by author.	52
<b>Fig. 36</b>	<b>Binary Descriptions of the Shifting of Light and Shadow Over Time</b> Image by author.	54
<b>Fig. 37</b>	<b>Light and Shadow Composites</b> Image by author.	56
<b>Fig. 38</b>	<b>Light Contour Transformation for Building 1 (7AM-6PM)</b> Image by author.	57
<b>Fig. 39</b>	<b>Veil Form in Isolation</b> Image by author.	58
<b>Fig. 40</b>	<b>Sun Path Diagram / Lat 43.67°</b> Image by author.	60
<b>Fig. 41</b>	<b>Plan View of Indexed Rays Undergoing Reflection</b> Image by author.	60
<b>Fig. 42</b>	<b>Internal Reflections</b> Image by author.	62
<b>Fig. 43</b>	<b>Optic Device - Curving Reflective Steel Ribbon</b> Image by author.	62
<b>Fig. 44</b>	<b>3D Grid Spreading Definition</b> Image by author.	64
<b>Fig. 45</b>	<b>Select Distended (Vertical) Grid Curves</b> Image by author.	64



## THE INTRINSIC AGENT

<b>Fig. 46</b>	<b>Interpolation of Curves</b> Image by author.	66
<b>Fig. 47</b>	<b>Interpolation of Curves</b> Image by author.	68
<b>Fig. 48</b>	<b>Sections Showing the Differential Thickening of the Veil</b> Image by author.	69
<b>Fig. 49</b>	<b>Rendered Veil Form</b> Image by author.	70
<b>Fig. 50</b>	<b>Veil 3D Printed in Various Plastics</b> Photographs by author.	71
<b>Fig. 51</b>	<b>Detail of Sections Featuring Developed Veils</b> Image by author.	72
<b>Fig. 52</b>	<b>Interior Rendering of Veil and Exterior Facade</b> Image by author.	72
<b>Fig. 53</b>	<b>Sections Featuring Developed Veils</b> Image by author.	73
<b>Fig. 54</b>	<b>Floor Plans of Experiment in Application</b> Image by author.	74
<b>Fig. 55</b>	<b>Renzo Piano Building Workshop, <i>Pathé Foundation</i></b> Denancé, Michel. <i>Pathé Foundation-15</i> . Available from: <i>arch2o</i> . Accessed November 1, 2017. <a href="https://www.arch2o.com/pathé-foundation-renzo-piano-building-workshop/">https://www.arch2o.com/pathé-foundation-renzo-piano-building-workshop/</a> .	78
<b>Fig. 56</b>	<b>Relation of Reference Components</b> Image by author.	81
<b>Fig. 57</b>	<b>From Source to Effect</b> Image by author.	82
<b>Fig. 58</b>	<b>Reading the Optic Device Series</b> Image by author.	85
<b>Fig. 59</b>	<b>High Dynamic Range Image</b> Denko, Marek and Peter Sanitra. <i>05-18_Day_A</i> . Available from: <i>NoEmotion</i> . Accessed November 1, 2017. <a href="http://noemotionhdrs.net/hdrday.html">http://noemotionhdrs.net/hdrday.html</a> .	87
<b>Fig. 60</b>	<b>Sun Angle Calculator Settings</b> Robert McNeel & Associates. <i>Sun Angle Calculator</i> . Screenshot captured: July 6, 2017. <i>Rhinoceros 5</i> .	87
<b>Fig. 61</b>	<b>Material Samples</b> Image by author.	88
<b>Fig. 62</b>	<b>Peter Zumthor, <i>Therme Vals</i></b> Tantra, Patrick. <i>Vals, Therme, Peter Zumthor</i> . Available from: <i>Flickr</i> . Accessed November 1, 2017. <a href="https://www.flickr.com/photos/cmyk100dpi/5095045074/">https://www.flickr.com/photos/cmyk100dpi/5095045074/</a> .	90
<b>Fig. 63</b>	<b>Sample of Archetype Illustration</b> Image by author.	92
<b>Fig. 64</b>	<b>Example of a Neutral State</b> Image by author.	94
<b>Fig. 65</b>	<b>SANAA, <i>Naoshima Ferry Terminal</i></b> Hjortshoj, Rasmus. Available from: <i>Divisare</i> . Accessed November 1, 2017. <a href="https://divisare.com/projects/322291-kazuyo-sejima-ryue-nishizawa-sanaa-rasmus-hjortshoj-naoshima-ferry-terminal">https://divisare.com/projects/322291-kazuyo-sejima-ryue-nishizawa-sanaa-rasmus-hjortshoj-naoshima-ferry-terminal</a> .	94
<b>Fig. 66</b>	<b>Example of Simple Image</b> Image by author.	96
<b>Fig. 67</b>	<b>Atelier Jean Nouvel, <i>Arab World Institute</i></b> <i>Atelier Jean Nouvel</i> . Available from: <i>Jean Nouvel</i> . Accessed November 1, 2017. <a href="http://www.jeannouvel.com/en/desktop/home/#/en/desktop/projet/paris-france-arab-world-institut1">http://www.jeannouvel.com/en/desktop/home/#/en/desktop/projet/paris-france-arab-world-institut1</a> .	96
<b>Fig. 68</b>	<b>Example of Caustic Light</b> Image by author.	98

<b>Fig. 69</b>	<b>HENN Architekten, <i>Porsche Pavilion</i></b> Esch, HG. Available from: <i>Bustler</i> . Accessed November 1, 2017. <a href="http://bustler.net/news/2610/porsche-pavilion-at-the-autostadt-in-wolfsburg-germany">http://bustler.net/news/2610/porsche-pavilion-at-the-autostadt-in-wolfsburg-germany</a> .	98
<b>Fig. 70</b>	<b>Example of the Specular Image</b> Image by author.	100
<b>Fig. 71</b>	<b>Mira Arquitetos, <i>National Cities Confederation</i></b> Finotti, Leonardo. Available from: <i>Dezeen</i> . Accessed November 1, 2017. <a href="https://www.dezeen.com/2016/12/18/glazed-office-block-cantilever-pool-mira-arquitetos-brasilia-brazil/">https://www.dezeen.com/2016/12/18/glazed-office-block-cantilever-pool-mira-arquitetos-brasilia-brazil/</a>	100
<b>Fig. 72</b>	<b>Example of a Secondary Source of Light</b> Image by author.	102
<b>Fig. 73</b>	<b>Louis Kahn, <i>Kimbell Art Museum</i></b> <i>Kimbell Art Museum Interior Gallery</i> . Available from: <i>AEDesign</i> . Accessed November 1, 2017. <a href="https://aedesign.wordpress.com/2009/10/08/kimbell-art-museum-fort-worth-texas/">https://aedesign.wordpress.com/2009/10/08/kimbell-art-museum-fort-worth-texas/</a>	102
<b>Fig. 74</b>	<b>Example of Textural Light</b> Image by author.	104
<b>Fig. 75</b>	<b>Peter Zumthor, <i>Bruder Klaus Field Chapel</i></b> Amoretti, Aldo. <i>Image 13/13</i> . Available from: <i>ArchDaily</i> . Accessed November 1, 2017. <a href="https://www.archdaily.com/798340/peter-zumthors-bruder-klaus-field-chapel-through-the-lens-of-aldo-amoretti/581389d2e58ce9678000313-peter-zumthors-bruder-klaus-field-chapel-through-the-lens-of-aldo-amoretti-photo">https://www.archdaily.com/798340/peter-zumthors-bruder-klaus-field-chapel-through-the-lens-of-aldo-amoretti/581389d2e58ce9678000313-peter-zumthors-bruder-klaus-field-chapel-through-the-lens-of-aldo-amoretti-photo</a>	104
<b>Fig. 76</b>	<b>Example of Dispersed Light</b> Image by author.	106
<b>Fig. 77</b>	<b>James Carpenter, <i>Dichroic Light Field</i></b> Dzikowski, Francis. <i>Dichroic Light Field; Millennium Tower</i> . Available from: <i>Francis Dzikowski photography</i> . Accessed July 6, 2017. <a href="http://www.fphoto.biz/portfolio/public-art-new-york/">http://www.fphoto.biz/portfolio/public-art-new-york/</a> .	106
<b>Fig. 78</b>	<b>Sample of Optic Device Illustration</b> Image by author.	108
<b>Fig. 79</b>	<b>Base Frame Instance</b> Image by author.	110
<b>Fig. 80</b>	<b>Series Demonstrating Frame Parameters</b> Image by author.	111
<b>Fig. 81</b>	<b>Alternate Frame Parameter Series</b> Image by author.	112
<b>Fig. 82</b>	<b>Base Lens Instance</b> Image by author.	113
<b>Fig. 83</b>	<b>Series Demonstrating Lens Parameters</b> Image by author.	114
<b>Fig. 84</b>	<b>Base Screen Instance</b> Image by author.	116
<b>Fig. 85</b>	<b>Series Demonstrating Screen Parameters</b> Image by author.	117
<b>Fig. 86</b>	<b>Alternate Screen Parameter Series</b> Image by author.	118
<b>Fig. 87</b>	<b>Base Diffuser Instance</b> Image by author.	119
<b>Fig. 88</b>	<b>Series Demonstrating Diffuser Parameters</b> Image by author.	120
<b>Fig. 89</b>	<b>Alternate Diffuser Parameter Series</b> Image by author.	121
<b>Fig. 90</b>	<b>Base Diffuser Instance</b> Image by author.	122
<b>Fig. 91</b>	<b>Series Demonstrating Mirror Parameters</b> Image by author.	123



<b>Fig. 92 Alternate Mirror Parameter Series</b> Image by author.	124
<b>Fig. 93 Base Receiving Surface Instance</b> Image by author.	125
<b>Fig. 94 Series Demonstrating Receiving Surface Parameters</b> Image by author.	126
<b>Fig. 95 Alternate Receiving Surface Series</b> Image by author.	127
<b>Fig. 96 Vector Architects, Seashore Library</b> Su, Shengliang. <i>Image 2/48</i> . Digital Image. Available from: <i>ArchDaily</i> . Accessed July 6, 2017. <a href="http://www.archdaily.com/638390/seashore-library-vector-architects">http://www.archdaily.com/638390/seashore-library-vector-architects</a> .	130
<b>Fig. 97 Seashore Library Site Plan</b> Vector Architects. <i>Site Plan</i> . Digital Images. Available from: <i>ArchDaily</i> . Accessed July 6, 2017. <a href="http://www.archdaily.com/638390/seashore-library-vector-architects">http://www.archdaily.com/638390/seashore-library-vector-architects</a> .	132
<b>Fig. 99 Seashore Library Second Floor Plan</b> Vector Architects. <i>Second Floor Plan</i> . Digital Images. Available from: <i>ArchDaily</i> . Accessed July 6, 2017. <a href="http://www.archdaily.com/638390/seashore-library-vector-architects">http://www.archdaily.com/638390/seashore-library-vector-architects</a> .	133
<b>Fig. 98 Seashore Library Ground Floor Plan</b> Vector Architects. <i>First Floor Plans</i> . Digital Images. Available from: <i>ArchDaily</i> . Accessed July 6, 2017. <a href="http://www.archdaily.com/638390/seashore-library-vector-architects">http://www.archdaily.com/638390/seashore-library-vector-architects</a> .	133
<b>Fig. 101 View Toward Bohai Sea</b> Su, Shengliang. <i>Image 23/48</i> . Digital Image. Available from: <i>ArchDaily</i> . Accessed July 6, 2017. <a href="http://www.archdaily.com/638390/seashore-library-vector-architects">http://www.archdaily.com/638390/seashore-library-vector-architects</a> .	134
<b>Fig. 100 Transverse Sections</b> Vector Architects. Sections 2 - 5. Digital Images. Available from: <i>ArchDaily</i> . Accessed July 6, 2017. <a href="http://www.archdaily.com/638390/seashore-library-vector-architects">http://www.archdaily.com/638390/seashore-library-vector-architects</a> .	134
<b>Fig. 102 Textural Light</b> Xia, Zhi. <i>Image 13/48</i> . Digital Image. Available from: <i>ArchDaily</i> . Accessed July 6, 2017. <a href="http://www.archdaily.com/638390/seashore-library-vector-architects">http://www.archdaily.com/638390/seashore-library-vector-architects</a> .	136
<b>Fig. 103 Specular Image</b> Xia, Zhi. <i>Image 24/48</i> . Digital Image. Available from: <i>ArchDaily</i> . Accessed July 6, 2017. <a href="http://www.archdaily.com/638390/seashore-library-vector-architects">http://www.archdaily.com/638390/seashore-library-vector-architects</a> .	136
<b>Fig. 104 Outdoor Slit Aperture</b> Xia, Zhi. <i>Image 15/48</i> . Digital Image. Available from: <i>ArchDaily</i> . Accessed July 6, 2017. <a href="http://www.archdaily.com/638390/seashore-library-vector-architects">http://www.archdaily.com/638390/seashore-library-vector-architects</a> .	136
<b>Fig. 106 Deepening Contrast of Effect</b> Xia, Zhi. <i>Image 12/48</i> . Digital Image. Available from: <i>ArchDaily</i> . Accessed July 6, 2017. <a href="http://www.archdaily.com/638390/seashore-library-vector-architects">http://www.archdaily.com/638390/seashore-library-vector-architects</a> .	138
<b>Fig. 105 Neutral Effect</b> Xia, Zhi. <i>Image 33/48</i> . Digital Image. Available from: <i>ArchDaily</i> . Accessed July 6, 2017. <a href="http://www.archdaily.com/638390/seashore-library-vector-architects">http://www.archdaily.com/638390/seashore-library-vector-architects</a> .	138
<b>Fig. 107 Horizontal Aperture in Meditation Room</b> Xia, Zhi. <i>Image 17/48</i> . Digital Image. Available from: <i>ArchDaily</i> . Accessed July 6, 2017. <a href="http://www.archdaily.com/638390/seashore-library-vector-architects">http://www.archdaily.com/638390/seashore-library-vector-architects</a> .	138
<b>Fig. 108 Exterior Rendering, View from the Sea</b> Image by author.	140
<b>Fig. 109 Second Floor Plan with Preliminary Addition</b> Image by author.	143
<b>Fig. 110 Ground Floor Plan with Preliminary Addition</b> Image by author.	143
<b>Fig. 111 Preliminary Second Floor Plan, 1:100</b> Image by author.	144
<b>Fig. 112 Preliminary Ground Floor Plan, 1:100</b>	

	Image by author.	145
<b>Fig. 113</b>	<b>Preliminary Sections, 1:200</b> Image by author.	146
<b>Fig. 115</b>	<b>Key Plan, Ground Floor</b> Image by author.	148
<b>Fig. 114</b>	<b>First Draft Kitchen and Dining Areas</b> Image by author.	148
<b>Fig. 116</b>	<b>First Draft Entrance and Study</b> Image by author.	149
<b>Fig. 117</b>	<b>Key Plan, Ground Floor</b> Image by author.	149
<b>Fig. 119</b>	<b>Key Plan, Ground Floor</b> Image by author.	150
<b>Fig. 118</b>	<b>First Draft Bedroom</b> Image by author.	150
<b>Fig. 120</b>	<b>First Draft Reading Area and Bathroom</b> Image by author.	151
<b>Fig. 121</b>	<b>Key Plan, Ground Floor</b> Image by author.	151
<b>Fig. 122</b>	<b>First Draft Bridge Over Reflecting Pool</b> Image by author.	152
<b>Fig. 123</b>	<b>Key Plan, 2<sup>nd</sup> Floor</b> Image by author.	152
<b>Fig. 124</b>	<b>Tentative Plans</b> Image by author.	153
<b>Fig. 125</b>	<b>Key Plan, 2<sup>nd</sup> Floor</b> Image by author.	153
<b>Fig. 126</b>	<b>Expediting Visualisation</b> Image by author.	154
<b>Fig. 127</b>	<b>Axonometric Expanded by Section</b> Image by author.	156
<b>Fig. 128</b>	<b>Bedroom Diffuser - Diagram of Parameters</b> Image by author.	159
<b>Fig. 130</b>	<b>Ground Floor, Bedroom</b> Image by author.	160
<b>Fig. 129</b>	<b>Bedroom Resolution</b> Image by author.	160
<b>Fig. 131</b>	<b>Section A Comparison</b> Image by author.	160
<b>Fig. 132</b>	<b>Work Area Diffuser - Diagram of Parameters</b> Image by author.	163
<b>Fig. 133</b>	<b>Work Area Resolution</b> Image by author.	164
<b>Fig. 134</b>	<b>2<sup>nd</sup> Floor, Work Area</b> Image by author.	164
<b>Fig. 135</b>	<b>Section B Comparison</b> Image by author.	164
<b>Fig. 136</b>	<b>Kitchen Diffuser - Diagram of Parameters</b> Image by author.	167



## THE INTRINSIC AGENT

<b>Fig. 138</b>	<b>Ground Floor, Kitchen/Dining</b> Image by author.	168
<b>Fig. 137</b>	<b>Kitchen/Dining Resolution</b> Image by author.	168
<b>Fig. 139</b>	<b>Section C Comparison</b> Image by author.	168
<b>Fig. 140</b>	<b>Reading Area Diffuser - Diagram of Parameters</b> Image by author.	171
<b>Fig. 142</b>	<b>Ground Floor, Reading Area</b> Image by author.	172
<b>Fig. 141</b>	<b>Reading Area Resolution</b> Image by author.	172
<b>Fig. 143</b>	<b>Ground Floor, Bathroom</b> Image by author.	176
<b>Fig. 144</b>	<b>Section D Comparison</b> Image by author.	176
<b>Fig. 145</b>	<b>Bathroom Resolution</b> Image by author.	177
<b>Fig. 146</b>	<b>Ground Floor, Meditation Space</b> Image by author.	178
<b>Fig. 147</b>	<b>Section F Comparison</b> Image by author.	178
<b>Fig. 148</b>	<b>Meditation Space Resolution</b> Image by author.	179
<b>Fig. 149</b>	<b>Ground Floor, Living Room</b> Image by author.	180
<b>Fig. 150</b>	<b>Section G Comparison</b> Image by author.	180
<b>Fig. 151</b>	<b>Living Room Resolution</b> Image by author.	181
<b>Fig. 153</b>	<b>2<sup>nd</sup> Floor, Laser Area</b> Image by author.	182
<b>Fig. 154</b>	<b>Section H Comparison</b> Image by author.	182
<b>Fig. 152</b>	<b>Laser Room Resolution</b> Image by author.	182
<b>Fig. 155</b>	<b>Maker Area Resolution</b> Image by author.	183
<b>Fig. 156</b>	<b>2<sup>nd</sup> Floor, Maker Area</b> Image by author.	183
<b>Fig. 157</b>	<b>2<sup>nd</sup> Floor, Gallery Area</b> Image by author.	184
<b>Fig. 158</b>	<b>Section I Comparison</b> Image by author.	184
<b>Fig. 159</b>	<b>Gallery Space Resolution</b> Image by author.	185
<b>Fig. 161</b>	<b>Ground Floor, Bedroom Wall</b> Image by author.	186
<b>Fig. 160</b>	<b>Bedroom Wall Detail Resolution</b> Image by author.	186

<b>Fig. 162</b>	<b>Second Floor Plan</b> Image by author.	188
<b>Fig. 163</b>	<b>Ground Floor Plan</b> Image by author.	189
<b>Fig. 165</b>	<b>Key Plan, Sections 1 and 2</b> Image by author.	190
<b>Fig. 164</b>	<b>Section 1</b> Image by author.	190
<b>Fig. 166</b>	<b>Section 2</b> Image by author.	191
<b>Fig. 168</b>	<b>Key Plan, Sections 3 and 4</b> Image by author.	192
<b>Fig. 167</b>	<b>Section 3</b> Image by author.	192
<b>Fig. 169</b>	<b>Section 4</b> Image by author.	193
<b>Fig. 170</b>	<b>View South from Reflecting Pool</b> Image by author.	194
<b>Fig. 171</b>	<b>Key Plan, Reflecting Pool and Study Views</b> Image by author.	194
<b>Fig. 172</b>	<b>View North from Entrance to Study</b> Image by author.	195
<b>Fig. 173</b>	<b>View East to Kitchen/Dining</b> Image by author.	196
<b>Fig. 175</b>	<b>Key Plan, Kitchen/Dining and Bathroom Views</b> Image by author.	196
<b>Fig. 174</b>	<b>View North in Kitchen</b> Image by author.	196
<b>Fig. 176</b>	<b>View West to Shower</b> Image by author.	197
<b>Fig. 177</b>	<b>View East to Meditation Space</b> Image by author.	198
<b>Fig. 178</b>	<b>Key Plan, Meditation and Reading Area Views</b> Image by author.	198
<b>Fig. 179</b>	<b>View West to Reading Area</b> Image by author.	199
<b>Fig. 180</b>	<b>View East in Bedroom</b> Image by author.	200
<b>Fig. 181</b>	<b>Key Plan, Bedroom and Living Area Views</b> Image by author.	200
<b>Fig. 183</b>	<b>View of Living Room with Screen Unfolded</b> Image by author.	201
<b>Fig. 182</b>	<b>View West in Living Room</b> Image by author.	201
<b>Fig. 184</b>	<b>View South from Bridge over Reflecting Pool</b> Image by author.	202
<b>Fig. 185</b>	<b>Key Plan, Exterior Bridge Views</b> Image by author.	202
<b>Fig. 186</b>	<b>View East from Maker Space Entrance</b> Image by author.	203



## THE INTRINSIC AGENT

<b>Fig. 187</b>	<b>View East to Laser Cutting Room</b> Image by author.	204
<b>Fig. 189</b>	<b>Key Plan, Makerbot and Laser Area Views</b> Image by author.	204
<b>Fig. 188</b>	<b>Close View East in Laser Room</b> Image by author.	204
<b>Fig. 190</b>	<b>View West Maker Bot Station</b> Image by author.	205
<b>Fig. 191</b>	<b>View East to Laser Cutting Room</b> Image by author.	206
<b>Fig. 192</b>	<b>Key Plan, Maker Work Area and Gallery Views</b> Image by author.	206
<b>Fig. 193</b>	<b>View West Maker Gallery</b> Image by author.	207
<b>Fig. 194</b>	<b>Exterior Rendering, View from West</b> Image by author.	208
<b>Fig. 195</b>	<b>Julio Le Parc, <i>Continuous Light Cylinder</i></b> Galerie Perrotin. <i>CONTINUUEL-LUMIÈRE-CYLINDRE</i> . Digital Image. Available from: <i>Perrotin</i> . Accessed November 13, 2017. <a href="https://www.perrotin.com/artists/Julio_Le_Parc/307/continuel-lumiere-cylindre/38824">https://www.perrotin.com/artists/Julio_Le_Parc/307/continuel-lumiere-cylindre/38824</a> .	210

### Icons at right margin throughout (Second from top to bottom):

Stanislav Levin, *Book*. Digital Image. Available from: *The Noun Project*. Accessed December 21, 2015. <https://thenounproject.com/brandcut/collection/books-and-notebooks/?oq=book &cid=1&i=183337>.

Yugu Design, *Image View*. Digital Image. Available from: *The Noun Project*. Accessed December 21, 2015. <https://thenounproject.com/term/image-view/281560/>.

Evan Schuster, *Sundial*. Digital Image. Available from: *The Noun Project*. Accessed December 21, 2015. <https://thenounproject.com/search/?q=sun&i=100731>.

Chameleon Design, *Flow*. Digital Image. Available from: *The Noun Project*. Accessed December 21, 2015. <https://thenounproject.com/search/?q=genealogy&i=204512>.

Jannick Utke, *Pencil*. Digital Image. Available from: *The Noun Project*. Accessed December 21, 2015. <https://thenounproject.com/term/pencil/1209691/>.







Fig. 1 Francis Mangion, *Architecture of Light*

# i introduction

## A HYPOTHESIS

---

*The Intrinsic Agent* introduces architects to a means of accessing and developing the presently limited interface between light and architecture, and advocates for an architecture of aesthetic variety and designed difference of condition. The convenience and ease of applying even, diffuse artificial light to spaces that can then serve our functional needs over much longer periods of the day has overtaken our sense, as architects, of what involving light in architecture entails. Literature on the combined topics of light and architecture overwhelmingly speaks to the principles and theory behind architectural lighting design while a few works document religious architecture and art installations, the primary sites in which investigations of natural and artificial light can respectively be found. It is important to note that in the documented religious and art projects, light is the primary conceptual driver of the project, be it as a spiritual metaphor or intangible physical phenomenon. However, despite the clear potential of this meeting of agent and design, architects lack the necessary hypothetical tools to experiment with light in its capacity (outside metaphor and pure study) to act as a communicative tool and significant contributor to architectural

experience. *The Intrinsic Agent* provides architects with a methodological reference that allows them to explore the extent to which light can complement and deepen the resolution of larger project concepts, tectonic strategies, and narratives.

The thesis begins with a survey of present methods of studying and working with artificial and natural light. Architectural lighting design, a primary pedagogical source, largely neglects natural light in its address of the selection and application of luminaires. Its focus lies in the design and spatial distribution of fixed artificial sources of light following the completion of the design of the adjacent architecture, and its impact on the tectonic resolution of the project is therefore limited. Phenomenological discourse, on the other hand, conjectures much more convincingly on the mutual interaction of natural light and architecture, but offers little by way of pedagogical theory. It describes to architects the nuanced varieties of effects of light that have been captured in past and present projects, using the case study as its primary pedagogical tool. The advantages and disadvantages of using a case study to learn about working with light and architecture were explored through a drawing analysis of Julio Le Parc's light-driven installation, *Lumière en Vibration*, which

ultimately finds that although the study does reveal the significant elements of the project, it does not equip an architect to evolve new optic devices and systems from the parts or studies of the whole. Despite the neuroscientific evidence that agrees with the traditional reliance of architects upon the recollection, re-contextualisation, and reassembly of prior schemas into novel schemas<sup>1</sup> or solutions, the productive conception of light as an agent arguably lies beyond the schema that are gained primarily through case studies over the course of an architectural education.

Another generative method has since arisen in the realm of architectural education; in recent years, architects and students have been increasingly trained to operate on information with parametric plugins. Specialised parametric and computational tools often serve as the first point of access for those looking to work with light information to conduct daylight studies and develop environmentally-conscious designs. Although these studies have become sophisticated enough to return nuanced feedback regarding potential outcomes, they remain evaluative rather than generative. The use of more generic parametric tools to apply transformations to architectural elements like screens and facades based on input data is another common practice. It allows architects to physicalise information in 3-dimensional geometry, producing a clear relationship between the agent and architecture. In order to investigate the products of this method, an experiment was conducted that applied a selection of light information to a uniform, malleable architecture. It shows that although the interface between light information and architecture is activated, the conceptual and functional integrity of the product can be difficult to maintain from its conception to its application in an intended context. The complexity of reaching a satisfactory

tectonic and contextually appropriate resolution of the experiment prompted a shift in the thesis investigation. The usefulness of parametrics in this work lies in aiding the development of a theoretical foundation moreso than in implying a necessity of application to works that involve light. It must be noted that despite this change in approach, the value of parametric tools in applying and expediting the process of exploring optic devices has been demonstrated and is encouraged. For the purposes of this argument, an optic device includes any tectonic element or collection of elements that have been designed to interact with light. The use of the term parameter refers to the qualities of the optic device (or its elements) whose alteration will affect its operation as a light-filtering mechanism.

A theoretically parametric approach is then used to introduce architects to the types and layers of interaction between light and architecture that exist while still acknowledging the sheer breadth and diversity of combination of light phenomena. Having explored the merits and shortcomings of the first two conventional methods, an original methodological reference was composed that takes the position that light information cannot be directly applied to architectural work. The developed intermediary tool allows architects to hypothetically identify and experiment with the different possible elements of the site of interaction and the characteristics of their subsequently produced effects. It gathers insight from phenomenology, architectural lighting design, and optics (the physics of light) to identify the archetypes of produced light effect (i.e. the types of manifestation of light information that occur), and then explains their possible variations in terms of the physical device and parameters of that device that directly impact the relevant archetype. The reference is intended to be viewed as a collection of starting points to which one brings conceptual ideas, develops a system strategy, and takes away the architectural optic devices necessary to produce and adjust an effect. The archetypes interpret effects of light as intangible added layers that shift and change over time within a space, sometimes coming into

---

1 Michael Arbib, "Toward a Neuroscience of the Design Process," in *Mind in Architecture*, ed. Sarah Robinson and Juhani Pallasmaa (Cambridge: MIT Press, 2015), 93.

focus by way of the designed device, and other times existing as a foggy rendition that interprets light information without quite crystallizing it.

Vector Architects' *Seashore Library*, a built project that contains a suite of optic devices, has been analysed using the terms laid out by the index in order to familiarise the architect with its application, and a design proposal that extends the program of the built project to include a public maker area and private dwelling for a librarian acts as a study of the application of the developed tool. While the concepts of the main building inform the addition, the existing system strategy (identified in the analysis) was expanded to consider the need for privacy in a home with such a public context. The process of beginning with a preliminary design and using both parametric and rendering tools to test and develop the selected optic devices has been documented in detail to illustrate the often non-linear manner in which the methodological reference must be applied. A reflection on the effectiveness of the tool in encouraging the design and realisation of light effect concludes the thesis investigation. By expanding the interface between the architect and effects of light, architects can be introduced to light not as a purely religious or aesthetic conceptual driver, but as an agent with which to differentiate and tune space. While constructing physical mock-ups to test light effect remains ideal, providing architects with the tools that they need to be able to gain access and find traction in their investigations of the interaction of light and architecture is the priority of this thesis. It is an invitation to architects and students to generate more articulate meetings of architecture and its intrinsic agent in the future.





# PART I

---

LIGHT PEDAGOGY

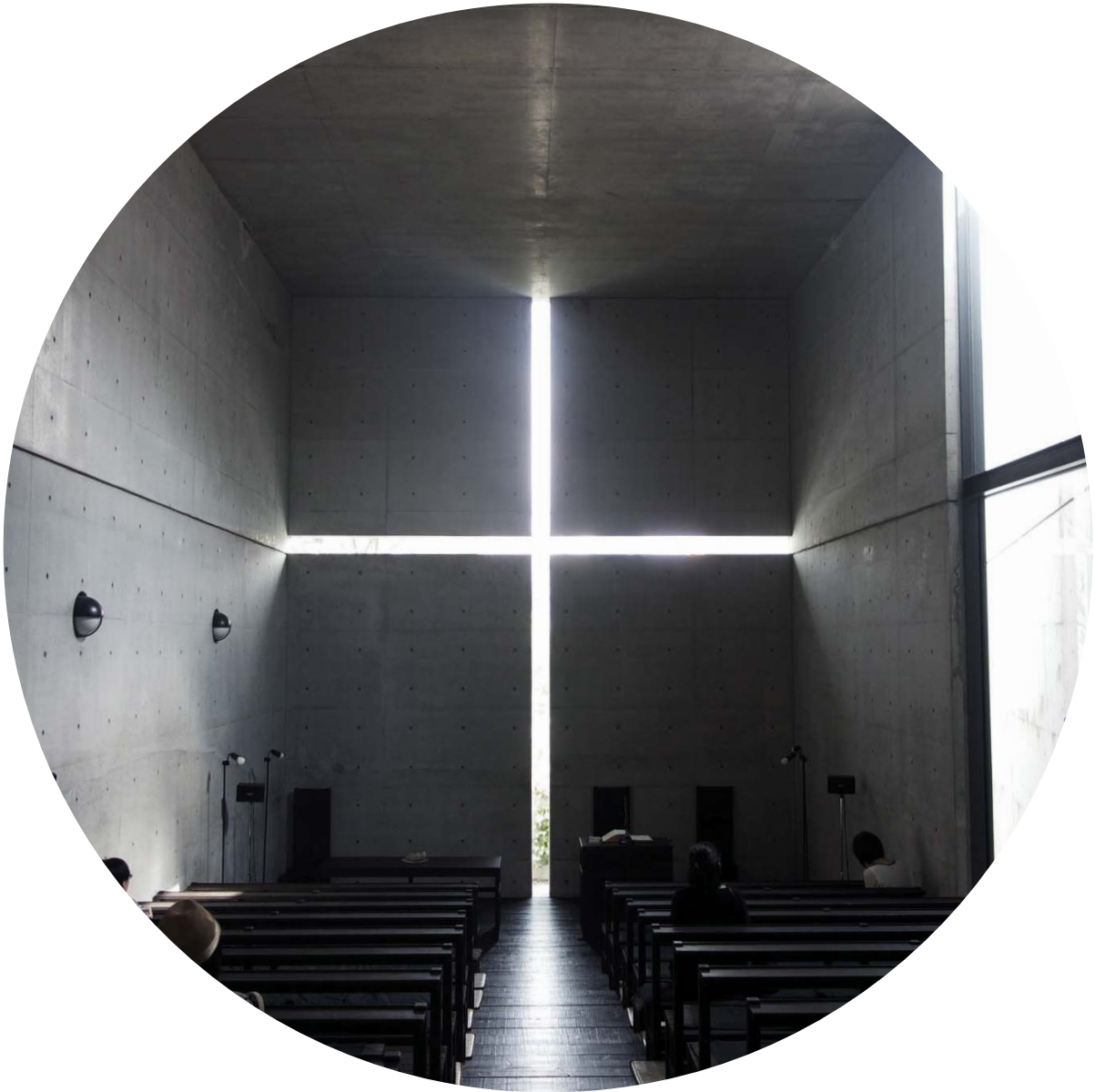


Fig. 2 Tadao Ando, *Church of Light*



## PRESENT LIGHT PEDAGOGY

---

Within the profession, there is a currently a state of confusion that surrounds the conceptual involvement of light in architectural space and pedagogy. Our sense of detachment toward candelas, lumens, and luminaires often finds architectural design thrust upon lighting designers at the last minute, leaving only enough time and flexibility in the project to design sufficient lighting to serve the functionality of the space. As a result, a very limited form of architectural lighting has since occupied our sense of (and pedagogical approach toward) what a further study of light entails. When pursuing a deeper study of the interaction of light and architecture, architects often turn to phenomenology, a branch of philosophy that addresses our experiences of built space, to invoke in themselves a disposition toward thinking about how a space physically and mentally impacts a person. Henry Plummer, an architecture professor and philosopher, has dedicated his life to documenting and describing the interaction of light and architecture. Though his

## the status quo

words move, the focus of his writings lie primarily in finding spiritual conceptual correlates to the observed phenomena. The tendency toward an approach that either prescribes artificial light as its mode of agency or ascribes notions of genesis and other religious meanings to light is inhibitive of the foregrounding of new methods of sensitively utilizing and applying light to architectural works. A third approach, quantitative management in pursuit of sustainability goals, will not be addressed due to its fundamentally divergent intentions and ambitions. The continuation of an otherwise exclusively phenomenological and ‘quasi-scientific’ approach to the study of light limits its potential. The thesis examines the pedagogical positions of architectural lighting design and phenomenology, finding their proposals of generative methods for architects to fall short in terms of their conceptual integrity and physical grounding respectively.

Many books have been published that focus on the combined topics of light and architecture. However, these texts do not adequately explicate a balanced, reciprocal relationship between the

two; instead, they heavily focus on the technical knowledge that supports the selection of artificial light sources. *Light Perspectives: Between Culture and Technology*<sup>1</sup>, *The Architecture of Light*<sup>2</sup>, and *Made of Light: The Art of Light and Architecture*<sup>3</sup> are just a few of the titles that one might optimistically leaf through with the expectation that light and architecture will be shown to significantly influence one another, and that each will present different interpretations of the dynamic intersection. Instead, it soon becomes clear that these publications are compendiums that illustrate a multitude of applications of the same six visual principles of architectural lighting design. They have similar views, present similar parameters, and are compiled in similar formats. This content is very concisely presented by Hervé Descottes in his book, *Architectural Lighting: Designing with Light and Space*.<sup>4</sup> In this text, a tension between the conceptual discourse and technical knowledge base is evident. Scattered throughout Descottes' book are ideas that are easily sympathized with and that catch one's attention: "In turn, the architecture will engage in a game of reciprocity, further sculpting the light while simultaneously being visually sculpted by the effects of light."<sup>5</sup> This evocation of a reciprocal, binding relationship is then immediately quarantined within the terms of luminaire specification: "The form of light is governed by the principle of direction and distribution, which concerns the aim shape and beam characteristics of a light source."<sup>6</sup> All of a sudden,

the element of architecture is removed from the declaration of co-existence and mutual dependence. The reversion from conceptual dialogue to technical specificity is more broadly evident in other texts including *The Architecture of Light* by Sage Russell, in which the author quickly moves on from such topics as phototropism and the purpose of light to glossaries of terms and instructions for selecting luminaires based on their properties. These terms do have their place in architectural lighting design and are well-needed guides to enhancing the ambient quality of sequences of space, but they have little power to influence the architect due to their technical and summative natures. They provide little material with which to develop the interplay of light and space, particularly natural light.

In instances where both light and architecture are addressed in more depth, the conceptual discourse that is paired with the specialized terminology and knowledge that is part and parcel of architectural lighting design often lacks clarity and consistency. For example, in his introduction to the "Six Visual Principles of Light," Descottes states, "The ideal relationship between light and architecture is mutual enhancement."<sup>7</sup> However, just a few paragraphs later he reiterates the idea differently by saying, "in an ideal relationship... the architecture becomes porous to light, and the two become one and the same."<sup>8</sup> These two ideas seem to propose approaches to light and architecture that require different degrees of interconnectedness. In the first instance, it is implied that the two media are distinct entities that must be designed in tandem to their mutual enhancement, but in the second instance, it is implied that once light penetrates the architectural form, the two combine with one another to produce a third, synthesized outcome. While design approaches vary significantly from project to project, this kind of description leaves the architect with little by way of a guideline of engagement. This kind of pseudo-

---

1 Martin Krautter and Thomas Schielke, *Light Perspectives: Between Culture and Technology* (Lüdenscheid: ERCO GmbH, 2009).

2 Sage Russell, *The Architecture of Light* (La Jolla: Conceptnine, 2008).

3 Mark Major, Jonathan Speirs, and Anthony Tischhauser, *Made of Light: The Art of Light and Architecture* (Basel: Birkhäuser, 2005).

4 Hervé Descottes and Cecilia E. Ramos, *Architectural Lighting: Designing with Light and Space* (New York: Princeton Architectural Press, 2011).

5 Descottes, *Architectural Lighting*, 70.

6 Ibid.

---

7 Ibid., 80.

8 Ibid., 81.

phenomenological discourse is so vague that it loses its potency and ability to foster a change of method in the designer. The lack of conceptual integrity limits the ability of the architect to engage with the material and underlying principles of the work.

Descottes' Six Visual Principles of Light (illuminance, luminance, colour and temperature, height, density, and lastly, direction and distribution)<sup>9</sup> fall into two categories. The first three exist primarily as quantitative measures of light performance, while the latter refer to the physical location of the luminaire with respect to the architecture at hand. These variables can have a significant impact on the utility of a room and its functionality beyond daylight hours. Descottes notes that the height of a luminaire can implicitly influence the sense of privacy of a space, while the introduction of various densities of luminaire arrangement can produce spatial rhythm.<sup>10</sup> He even introduces an interesting tonal hierarchy among objects that can be generated through a designed positioning of light and form, as is demonstrated in the given example of a store window (Fig. 3). However, the interaction of light with architectural openings, surfaces, and space is something that must be extrapolated by the architect from the principles that have been designed to correspond with the manufactured parameters of artificial luminaires. Though architectural examples are sometimes given, the principles do not speak directly to the design of architecture. Descottes reaches beyond the fairly straightforward description of one of the six visual principles, luminance, when he addresses the interaction of light with interior surfaces: "Perhaps one of the most surprising yet powerful ideas in lighting design is that a surface or object itself has the potential to become a secondary light source." The potential impact of light in architecture through this kind of mechanism is noted by both Descottes and Plummer in several instances throughout their writings. In this phenomenon, architecture is fully engaged in the formation of the

9 Ibid., 13.

10 Ibid., 60.

effect, which is an interesting departure from what can only be described as an imbalance of influence in lighting design strategy.

Descottes briefly expands on this phenomenon in his discussion of light colour and temperature. A red wall that is lit with a red light, he states, will appear much more luminous than a red wall that is lit with a white light, due to a "higher quantity of light waves falling within the red portion of the light spectrum to reflect" in the first case.<sup>11</sup> Although this is an expansion of the concept of the secondary light source, the architectural implications of the consistent use of a surface in such a manner are much richer. The qualities of the surface material will significantly impact the occupants' experience of the space, and the connection between this aspect of the interaction and its larger architectural implications is not noted in (and perhaps lies beyond the scope of) Descottes' principles. For example: in his work, *The Eyes of the Skin*,<sup>12</sup> Juhani Pallasmaa follows a critical summary of the introduction of 'unyielding' and 'scaleless' machine-made materials that presently play a significant role in promoting themes of transparency and weightlessness in architecture with an optimistic opinion. He states, "In recent decades, a new architectural imagery has emerged, which employs reflection, gradations of transparency, overlay and juxtaposition to create a sense of spatial thickness, as well as subtle and changing sensations of movement and light."<sup>13</sup> The terms that Pallasmaa uses speak to the necessity of utilizing architectural tectonics to soften, layer, and diversify light effect, thereby giving rise to a new architectural confluence of material and light. This conceptual discourse expands our understanding of the potential of the optic device that Descottes introduces. Additionally, the question of the nature

11 Ibid., 45.

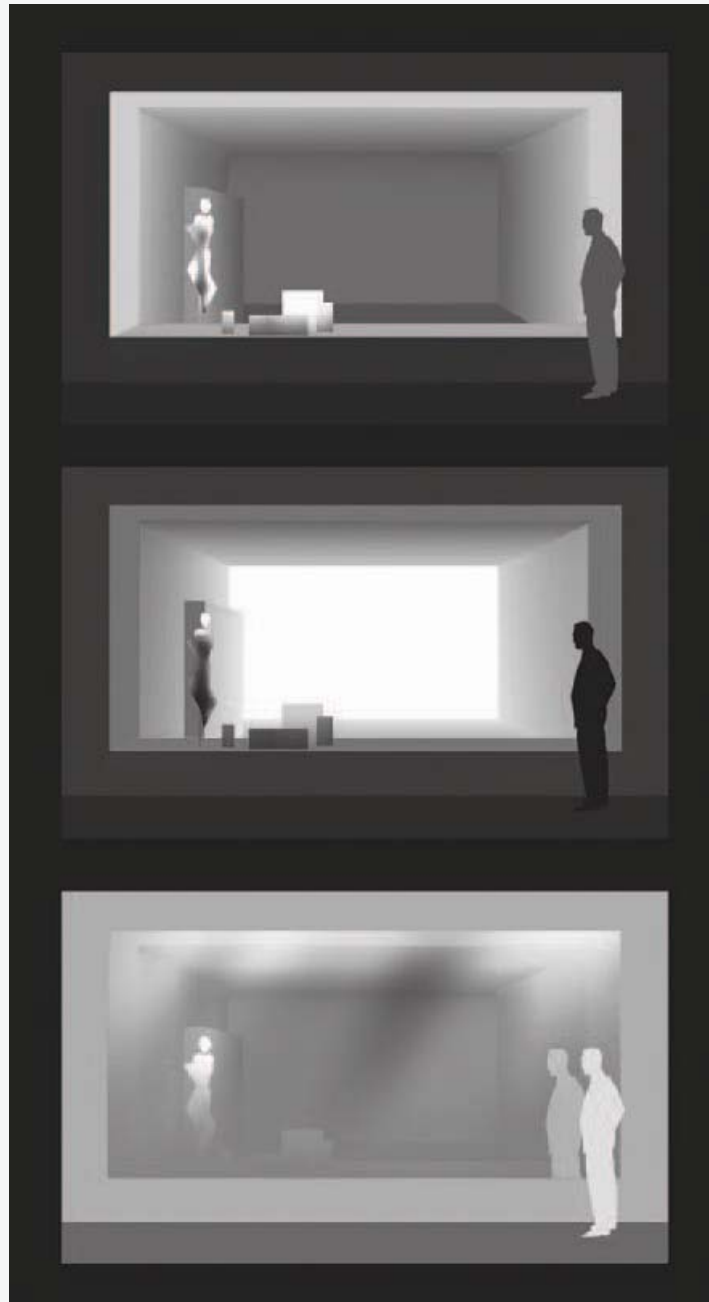
12 Juhani Pallasmaa, *The Eyes of the Skin: Architecture and the Senses* (Chichester: Wiley, 2005).

Pallasmaa is a Finnish architect and former professor and dean at the Helsinki University of Technology.

13 Ibid., 32.



# THE INTRINSIC AGENT



**Fig. 3** Visual Hierarchy of a Storefront Window

of the material that receives the light becomes immediately obvious and significant.

Pallasmaa also speaks specifically about the potential consequences of ignoring the generation of diverse light conditions in architecture. He says, “Homogenous bright light paralyses the imagination in the same way that homogenisation of space weakens the experience of being, and wipes away the sense of place.”<sup>14</sup> Upon exploring the visual principles of light that are proposed by architectural lighting design, it is clear that the field itself does not promote a homogeneity of light condition. Instead, one can infer that it is because architecture plays an apparently passive role in the proposed method that it has not captured the interest of architects. Because of this lack of adoption and subsequent adaptation of lighting design principles by architects, what might have become an exploration of light’s relationship to the perceiving body has instead become overlooked banality. The invitation of contrast, a broader range of luminance levels within a single space, can have an impact on our ability to more completely sense space. Rather than a purely visual encounter, our experience can become visceral. Pallasmaa states, “Deep shadows and darkness are essential, because they dim the sharpness of vision, make depth and distance ambiguous, and invite unconscious peripheral vision and tactile fantasy.”<sup>15</sup> This augmentation of everyday experience is what remains to be capitalised upon in our design of the spaces in which we spend the majority of our lives. It is possible to provoke our sense of touch and fuel our imaginations when architecture is given agency in our discourse surrounding light.

As it becomes clear that phenomenology rather than architectural lighting design is the field through which one is most likely to gain the interest of architects, it becomes necessary to address the field’s traditional pedagogical tools. In an interview conducted for ArchDaily’s *Light Matters* series, Plummer describes his pedagogical strategy

of asking students to “question how phenomena come into being through an interaction of sky and building, as the ebb and flow of incident light is guided by architectural openings and volumes, colors and textures.”<sup>16</sup> This strategy seems to share some similarities with Descottes’ six visual principles, but additionally calls for a more in-depth study of the participatory role of architecture in producing the observed effect. By Plummer’s own admission, he is promoting the traditional mode of design education through empirical precedent study: “This quasi-scientific knowledge depends on a careful investigation of how light phenomena were shaped in the past, through traditions handed down to us by our predecessors, as well as how the phenomena we love can be authentically formed and recreated in the future.”<sup>17</sup> This method of study is clearly sufficient to a certain degree – it is easily possible for a student to understand how the recessed coloured panels within the Chapel of St. Ignatius (Fig. 4) are able to create the semblance of a stained glass effect by reflecting selected wavelengths of light onto the interior surfaces of the chapel.<sup>18</sup> However, a phenomenon akin to the shifting waves of light that occupy Le Corbusier’s posthumously completed design of the parish church of Saint-Pierre in Firminy (Fig. 5) is impossible to study in this way. In Plummer’s book, *Cosmos of Light: The Sacred Architecture of Le Corbusier*,<sup>19</sup> he notes that the effect is caused by cylindrical polycarbonate tubes that are mounted within the altar wall. The tubes feature concentric grooves filled with glue that cause the caustic to appear on all three other walls of the

14 Ibid., 45.

15 Ibid.

16 Thomas Schielke, “Light Matters: Heightening The Perception Of Daylight With Henry Plummer (Part 2),” 7 May, 2015. ArchDaily. Accessed 5 July, 2017, <http://www.archdaily.com/627695/light-matters-heightening-the-perception-of-daylight-with-henry-plummer-part-2/>.

17 Ibid.

18 Descottes, *Architectural Lighting*, 33.

19 Henry Plummer, *Cosmos of Light: The Sacred Architecture of Le Corbusier* (Bloomington: Indiana University Press, 2013).



THE INTRINSIC AGENT



Fig. 4 Reflected Orange Light in Holl's Chapel of St. Ignatius

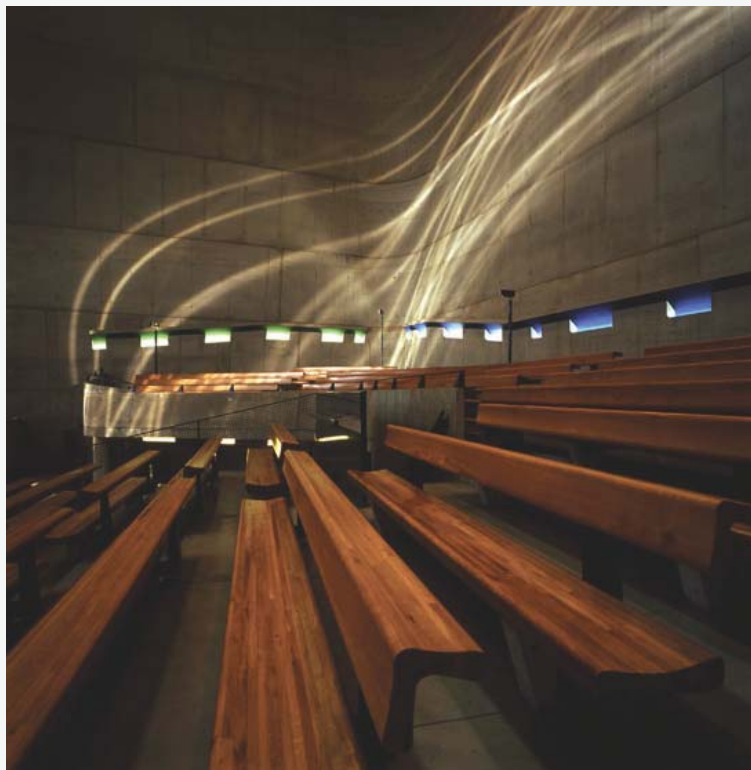


Fig. 5 Waves of Light in Le Corbusier's Church at Firminy

volume. Plummer notes that Le Corbusier could not have anticipated the effect, though he did often experiment with similar details of construction.<sup>20</sup> Using traditional architectural precedent studies, it would be incredibly difficult to study and reproduce this phenomenon. Proposing a study of the optical processes at work in even this simple system would generally lie beyond the scope of an undergraduate studio exercise, and instead other, much more simple interactions of light and architecture become the focus of study. This thesis posits that it would be more productive and empowering to provide students with a foundational understanding of the physical, phenomenological, and potential conceptual interactions of light with architecture. Light is the single agent with which all architects must work, and acknowledging the heterogeneity and richness of various manifestations of light effect can only serve to enhance an architect's capacity to reconcile the architecture and agent.

The next section of the thesis probes the case study for its strengths and limits as a source of knowledge regarding the interaction of light, surface, and space. Julio Le Parc's 1968 installation, *Lumière en Vibration*, has been selected for its complex meeting of filtered light and tectonic system. Though the installation is not architectural in the conventional sense and has no specific conceptual or functional obligations, it can be studied from a variety of perspectives and through the lens of a number of its primary parameters. A diagrammatic analysis will demonstrate the role and impact of key parameters while a complementary written analysis details the usefulness of this study to an architect.

---

20 Plummer, *Cosmos of Light*, 123.



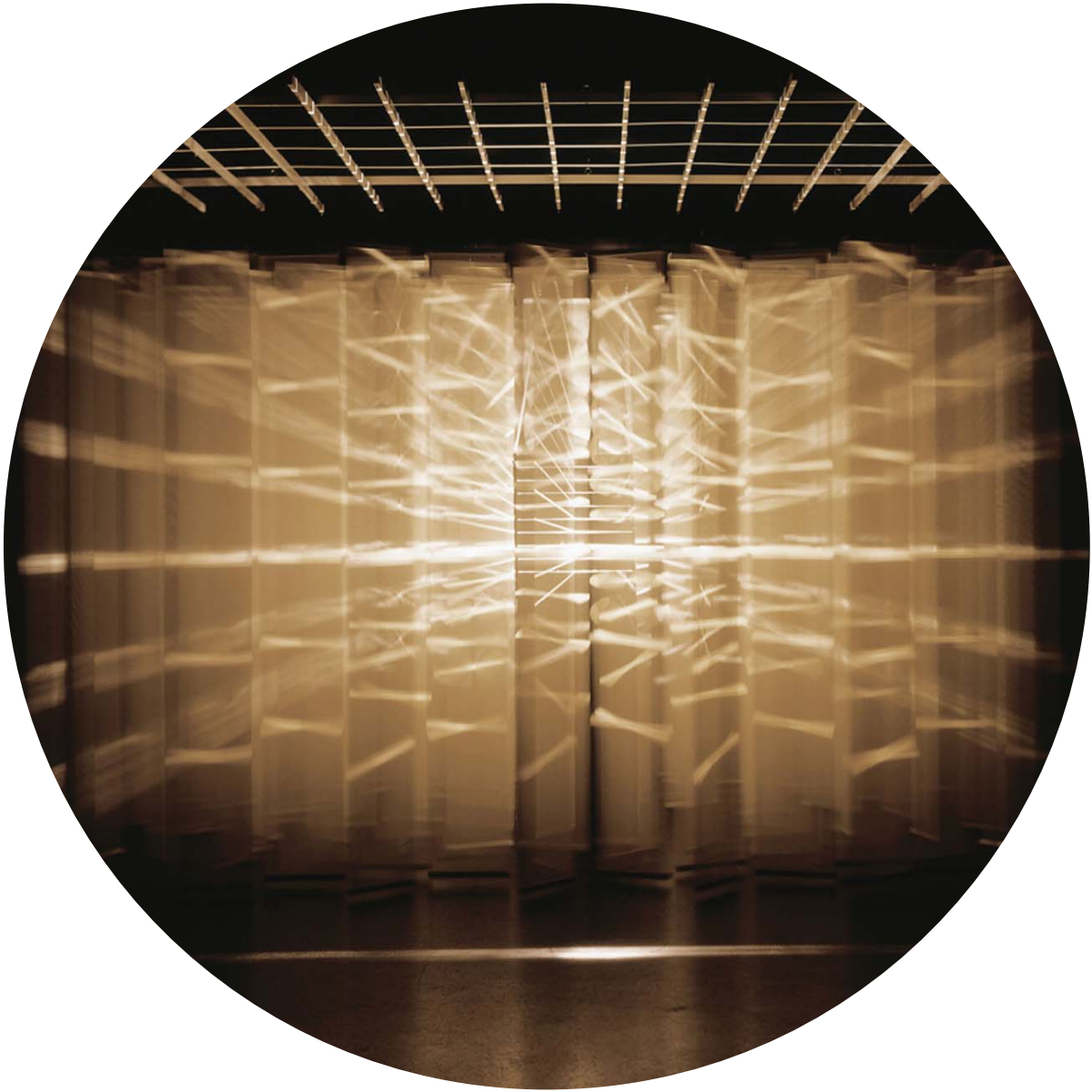


Fig. 6 *Lumière en Vibration*, 1968



## LUMIÈRE EN VIBRATION

---

Carefully studying the performance of an aesthetically ambitious project has unquestionably highlighted the value of a tectonic intervention whose parameters directly engage with the presence and behaviours of light in space. *Lumière en Vibration*, first exhibited in 1968, catalogues the trajectory of strobing light through space by way of a concentrated field of panels. In the interest of developing of a full understanding of the installation, both written and drawn analyses have been conducted. This case study reveals the strengths and weaknesses of the tool as a means by which to study the interaction of light with a tectonic assembly. The written portion of the analysis uses the philosophy of matter as a lens through which to describe the formation of the overall effect of light in terms of a registration of signs. The conduction of the drawing analysis, on the other hand, reveals the key tectonic components behind the effect. These two perspectives are brought together through a brief neuroscientific overview of the process of perception that occurs on the part of the installation's viewers and possible occupants. Harry Francis Mallgrave's writing in



## the case study

the chapter “Ambiguity: Architecture of Vision” in *The Architect's Brain* and Gilles Deleuze and Félix Guattari's essay “The Smooth and the Striated” in *A Thousand Plateaus* provide the basis for the analysis of the installation in terms of the philosophy of matter and the neuroscience of perception. The synthesising of the drawn and written analyses highlights the usefulness of this method in identifying the quality of light that drives the experience of installation and the reasons for its effectiveness. However, the case study does not produce a generalised explanation of the relationship between the light source and architecture of the installation, which inhibits the adaptation of this system in future work.

*Lumière en Vibration* is an optimal case study because it engages and agitates convention at every stage between the propagation of light from the central source to the final perception of the artifact by the viewer. This aspect of the installation results in some ambiguity in the viewer's understanding of the perceived image. Semir Zeki, a neurobiologist referenced by Mallgrave, defines ambiguity not as uncertainty but rather as “*certainty – the certainty of many equally plausible interpretations, each one of which is sovereign when it occupies the conscious*

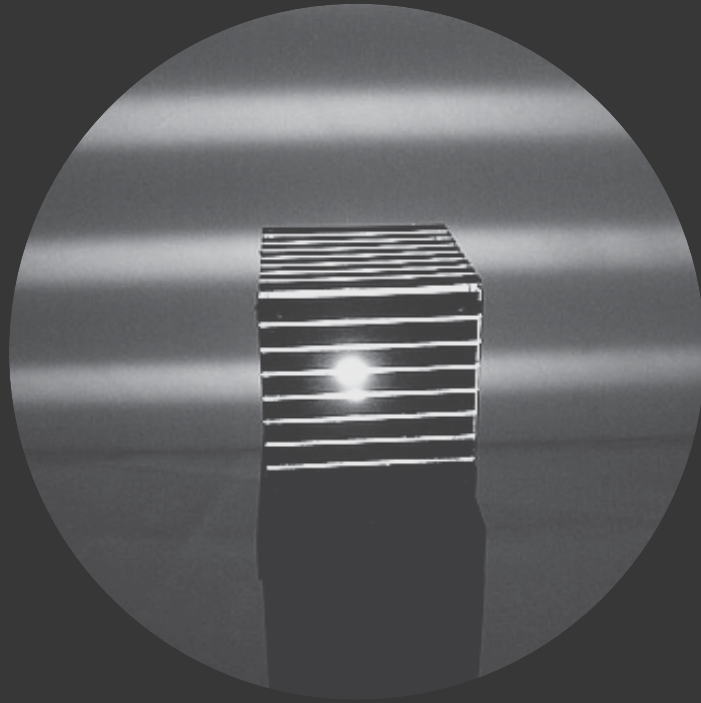


Fig. 7 Light Source at Center of Installation

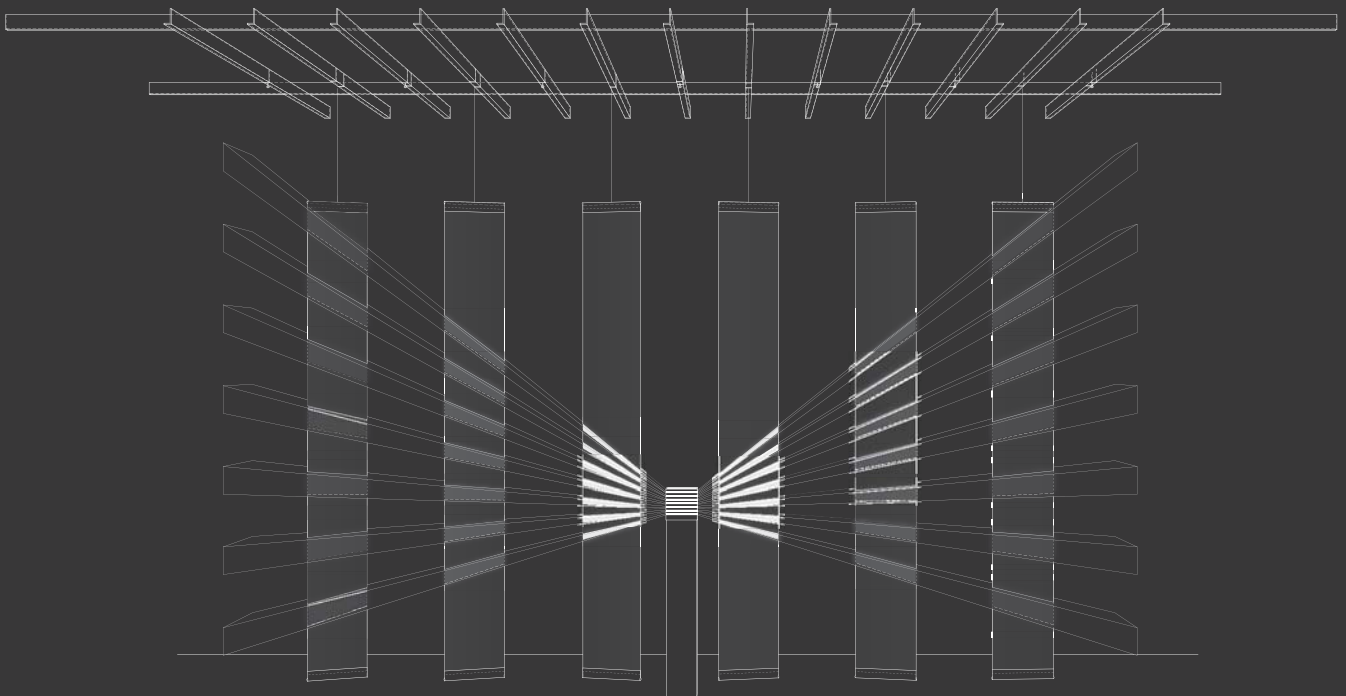


Fig. 8 Registration of Light

stage.”<sup>1</sup> Zeki might argue that the installation is successful precisely because it takes advantage of our preconceived notion of the effect that would be achieved were the room to be filled with water vapour (Fig. 8). Per his concept of neuroaesthetics, this disruption of our expectations is an essential purpose of art,<sup>2</sup> and as Mallgrave later states from a scientific standpoint, “the brain... demands both novelty and highly varied environments.”<sup>3</sup> The series of diagrams that conclude this section examine different interpretations of the interplay of light and (tectonic) film. They are an exploration of multiple lenses through which one can reveal the depth and interconnectedness of the physical exchange between light and material, and describe the interaction from various points of reference such as the individual plastic film, the rotation of the film, the edges of each of the seven volumes of light, and the boundary of each film, among others. Each of these studies stand as an interpretation of the installation and its many parts. They represent the depth of the system’s effectiveness and the ambiguity that the installation offers architects as case study material.

The installation’s effects of light are easily reconcilable with Deleuze and Guattari’s paradigm of smooth and striated spaces; the installation parameterises or striates light to allow for its reception by the suspended panels in a form that is unique to each panel but generally consistent in

the mode of its registration across the field (Fig. 9). The homogeneous spherical projection of light from the central source is released by its housing in the form of striated bands (Fig. 7). Regarding the transition from one character to another, Deleuze and Guattari emphasize the inevitable progression of the character of space in their model by saying, “Nothing is ever done with: smooth space allows itself to be striated, and striated space reimparts a smooth space, with potentially different values, scope and signs.”<sup>4</sup> The space of the frontal image (Fig. 9) of the installation is a smooth space of ubiquitous heterogeneous differentiation that is the direct product of the striation of light and the striated quality of the field of panels. The form of the projected light and the parameters of the installation’s receiving surfaces (i.e. their randomised rotation) are of equal value to the final image, as is corroborated by Deleuze and Guattari in their assertion that “the metrics of striated spaces (metrori) are indispensable for the translation of the strange data of a smooth multiplicity.”<sup>5</sup>

The front view of the installation is simply the collapsed view of many signs that signify a volume of light that has been striated into thickened, captured lines. This smooth space that is constructed by the installation takes the manifold form of what Deleuze and Guattari describe as an “abstract line”. The diverging, thickening volumes of striated light that depart from the light source are fragmented by the bounding edges of the panels that hold them in place at varying angles, constructing a smooth abstraction of the volumes. Deleuze and Guattari specify that the abstract line must be “of variable

1 Harry Francis Mallgrave, “Ambiguity: The Architecture of Vision,” in *The Architect’s Brain: Neuroscience, Creativity, and Architecture* (Chichester: Wiley-Blackwell, 2010), 149.

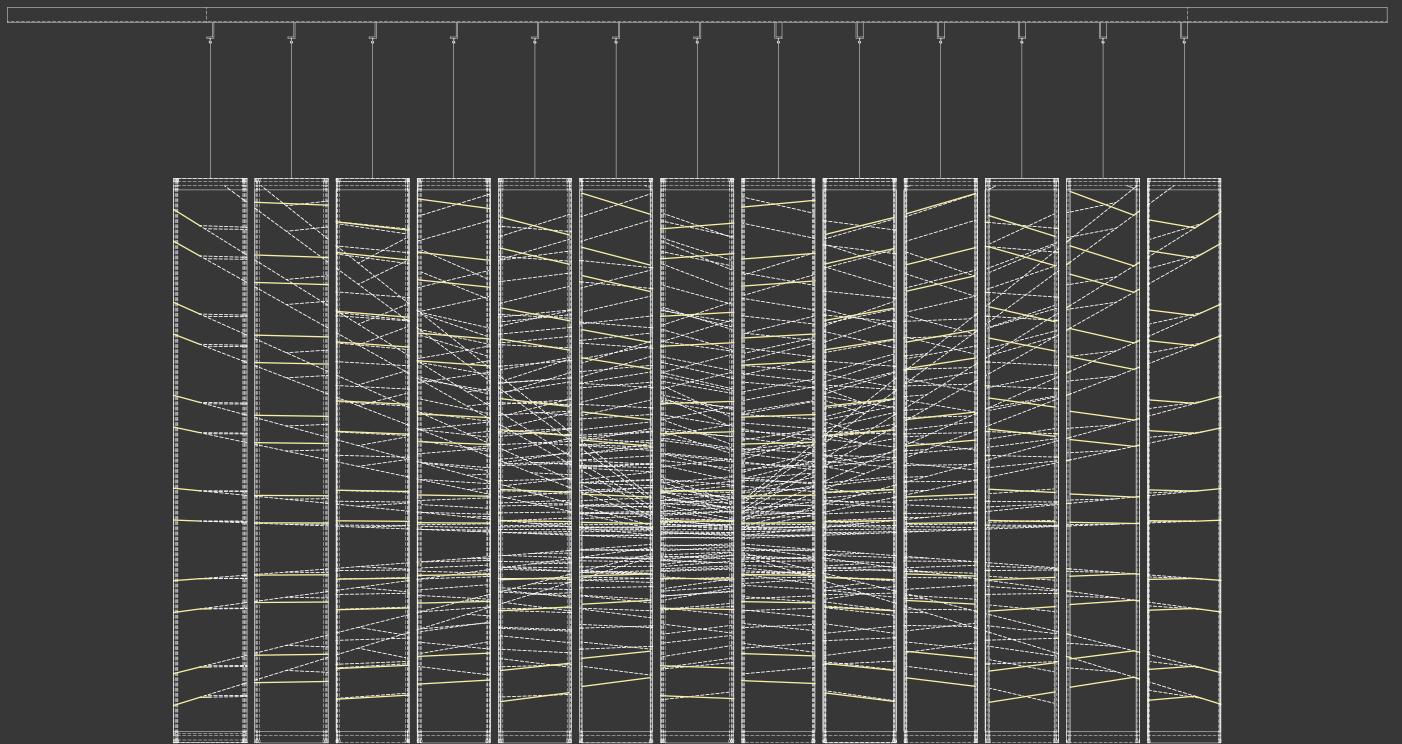
2 Ibid., 144.

3 Harry Francis Mallgrave, “Hapticity: Architecture of the Senses,” in *The Architect’s Brain: Neuroscience, Creativity, and Architecture* (Chichester: Wiley-Blackwell, 2010), 205.

4 Gilles Deleuze and Felix Guattari, “The Smooth and the Striated,” in *A Thousand Plateaus: Capitalism and Schizophrenia* (Minneapolis: University of Minnesota Press, 1987), 486.

5 Ibid.





**Fig. 9** Digitally Replicated Frontal Image

direction that describes no contour and delimits no form.”<sup>6</sup> This is true of the truncated lines of light that the installation forms because they do not simply capture the progressively widening profiles of light or even consistent sections of the volumes. Instead, the imposed random rotation of every panel smooths the striated information into something that is defined by the heterogeneous variation of torsion in each thread that is suspending a panel as well as by the uniformly distributed field of panels and the uniformly striated light.

The primary position from which one views the information that is projected by the installation occurs within what Deleuze and Guattari refer to as optical and distant space, the complement of close, haptic space. This viewing of the installation as a whole allows for an analysis of the contributions of its various components to the overall perception of the installation. According to Mallgrave’s notion of perception, the installation is the product of its many parts and details. Zeki asserts that “our overall visual conscious is formed from a series of spatially and temporally distinct ‘microconsciousness’.”<sup>7</sup> This conclusion is drawn from the recent finding that, “Single cells or columns of cells in the visual cortex... might respond only to lines, but some even more selectively to just horizontal lines, others to vertical or diagonal lines.”<sup>8</sup> This implies that every line that one perceives upon viewing the installation is inherently considered categorically distinct by the physiology of the brain. The brain prioritizes this information when constructing multiple understandings of a perceived image.<sup>9</sup> The vertical and horizontal edges of the installation’s panels, for example, are considered distinct from the diagonal lines of light even before their relative brightness is taken into consideration. Mallgrave goes on to explain that although there is no one area in which

all of the functionally specialised information is re-collected, the sensing of these precise visual cues “call memories and other associations into play.”<sup>10</sup> As case studies serve to broaden our scope of mental references and associations, this connection between the perceiving brain and pedagogical tool must be acknowledged.

In his essay “Toward a Neuroscience of the Design Process” in the edited volume *Mind in Architecture*, Michael Arbib conjectures on the relevance of neuroscientific findings to the workflow of the architect. Arbib references Peter Zumthor’s assertion that, “*Construction is the art of making a meaningful whole out of many parts*”<sup>11</sup> in Zumthor’s essay “A Way of Looking at Things” found in *Thinking Architecture*.<sup>12</sup> The need to establish the working relationship between the gestalt and its parts stems from the tendency of the case study to reveal the parts and workings of a very specific example. Though the analytic drawings are indicative of the feasibility of developing new frames of reference for the installation, the case study does not readily reveal how one might evolve the system. The case study, a form of striation, does not easily foster the escape of the striated into the smooth: new architectural work that is sensitive to light. Arbib sympathizes with the traditional method behind architectural work. He quotes a previous section of Zumthor’s essay: “When I design, I frequently find myself sinking into old, *half-forgotten memories*. ... Yet, at the same time, I know that all is *new* and that there is no direct reference to a former work of architecture.”<sup>13</sup> Arbib describes the process of design with respect to the whole and the parts as being characterised as such: “one has this general idea of the whole, and details begin to come into

6 Ibid., 499.

7 Mallgrave, “Ambiguity: The Architecture of Vision,” 142.

8 Ibid., 145.

9 Ibid., 149.

10 Ibid., 142.

11 Michael Arbib, “Toward a Neuroscience of the Design Process,” in *Mind in Architecture*, ed. Sarah Robinson and Juhani Pallasmaa (Cambridge: MIT Press, 2015), 85.

12 Ibid., 93.

13 Ibid., 85.



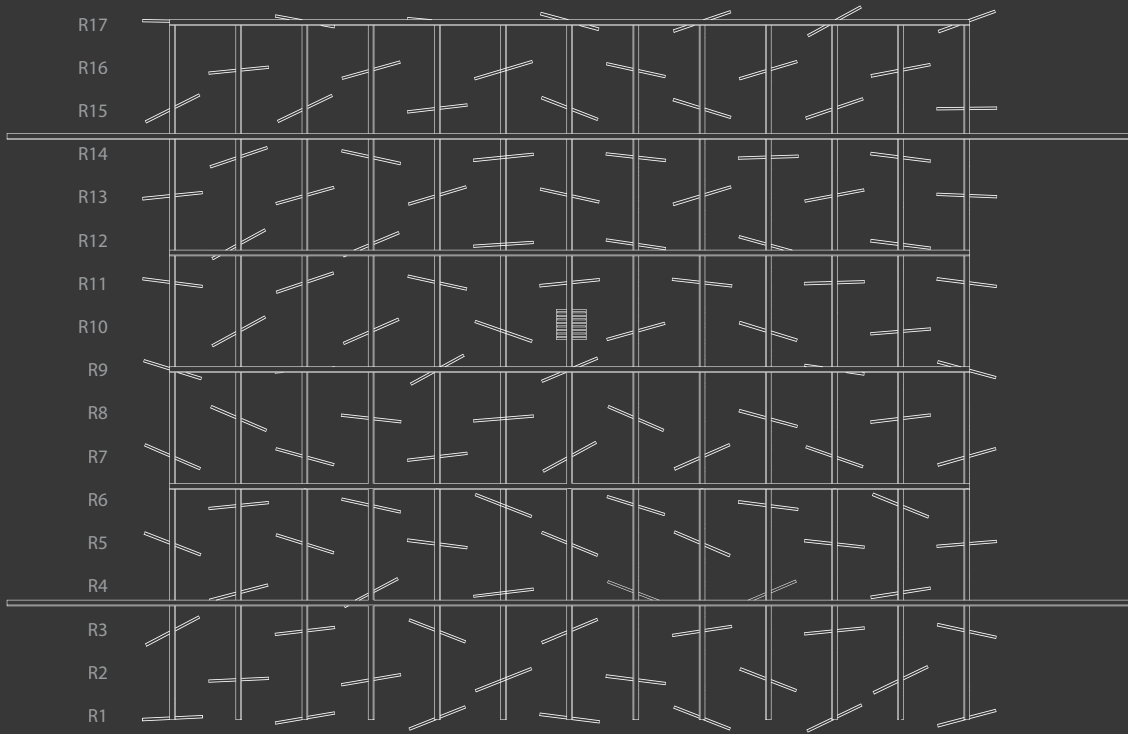


Fig. 10 Plan Showing Panel Rotation

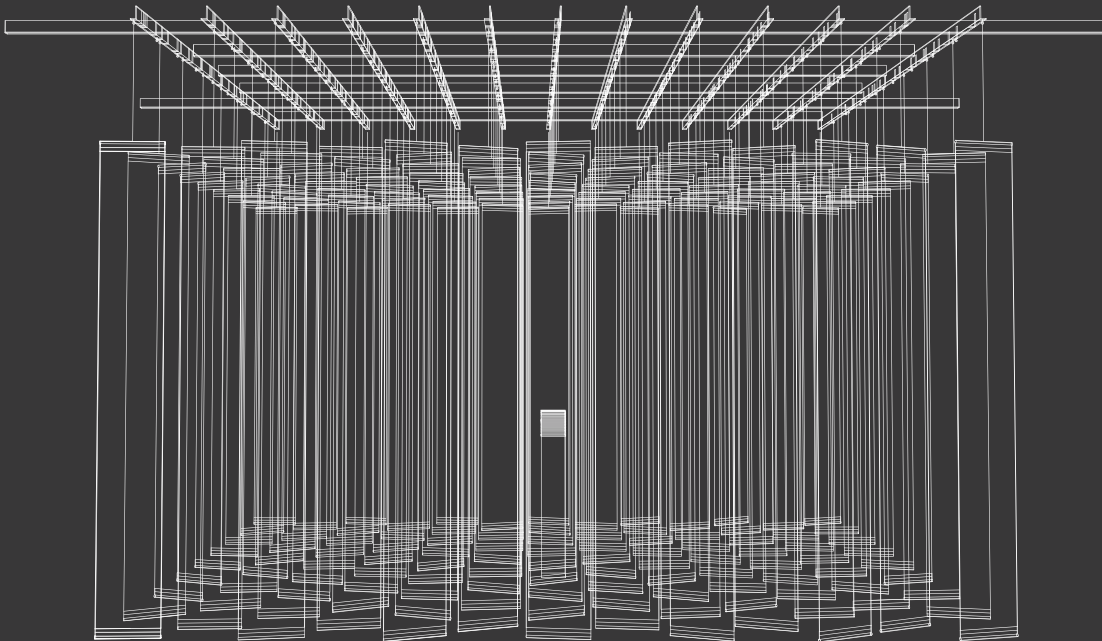


Fig. 11 Depth of installation

place, and to replace that vague understanding of the whole with a more precise understanding of the parts of the whole, which now constrain how you will fill in other parts of that whole.” In short, “Creativity exploits the prior schemas, places them in new contexts, and assembles them in new ways to transform them into novel schemas...”<sup>14</sup>

This thesis argues that the productive conception of light as an agent lies beyond the schema that are gained over the course of an architectural education that utilises the case study as its primary pedagogical tool. The spectrum of possible light effect is difficult to establish when one accumulates knowledge through the study of small, independent systems, especially those that function within very specific contextual conditions, as is the case with the Le Parc installation. In the case of urban planning and design, students of architecture are introduced to a range of urban typologies that cater to a variety of conditions and functional requirements. These typologies, established as general guidelines for engaging with conditions that are unfamiliar but have historical or conventional tendencies, are instrumental in allowing one to engage with ideas that are not based upon experience and memory, but rather abstract contexts and projected outcomes. Unlike urban planning, whose relationship to architecture and relevance to working architects is a well-established, institutionalised part of project development, the role of light in the design process of the architect remains an enigma. Studies of light can be disparate in nature and contained within various disciplines, and have yet to be reconciled into an architecturally-oriented body of knowledge. This stands as the most significant shortcoming of the case study when it is applied to studies of light and architecture.

Despite this weakness, studying the effects of the installation, particularly in real time, showcases and informs one of the power of accelerated light – light that doesn’t slowly shift over the course of a day but instead binarily shivers inside

the span of a second. The steady, rapid pulsating of the strobe is what truly creates the ‘light vibration’ that the installation is named for. The external and internal experiences of the installation allow for the simultaneous understanding on the part of the viewer that the installation is not only a 3-dimensional artifact, but that it also presents information in terms of a distant, 2-dimensional image. A conceptual resolution of these two readings on the part of the viewer seems to be overtly discouraged by the strobing light at the center of the work. When one occupies the interstitial space between the panels, the installation can no longer be optically read at such a close range and must instead be haptically experienced. Within the field of abstract lines of light, close vision “[presupposes] the smooth, which has no background, plane, or contour, but rather changes in direction and local linkages between parts.”<sup>15</sup> The changes in direction and local linkages of parts are quite literally exemplified in the context of the installation by the changes in the direction of the panels that begin to guide movement as well as by the lines that in proximity with one another begin to seem to come together. In this scenario, it is appropriate to consider the perception and understanding of the artifact to be arrested; due to the closeness of the encounter, the brain cannot rationalize the perceived image and alter its understanding of it before the strobing light disappears and reappears once again, seen then from a different perspective as the viewer moves between the panels. This exacerbates the perceived priority of the observation of the bright, diagonal bands and light becomes physical, visceral, and trapped at the forefront of the mind, unencumbered by a logical puzzling over the means of its registration. The amalgam of the experience of the installation is a direct result of uniform striation that is balanced by the introduction of randomness that allows the interaction between matter, light, and human to take on smooth qualities. The installation, intentionally

14 Ibid., 93.

15 Deleuze and Guattari, “The Smooth and the Striated,” 496.



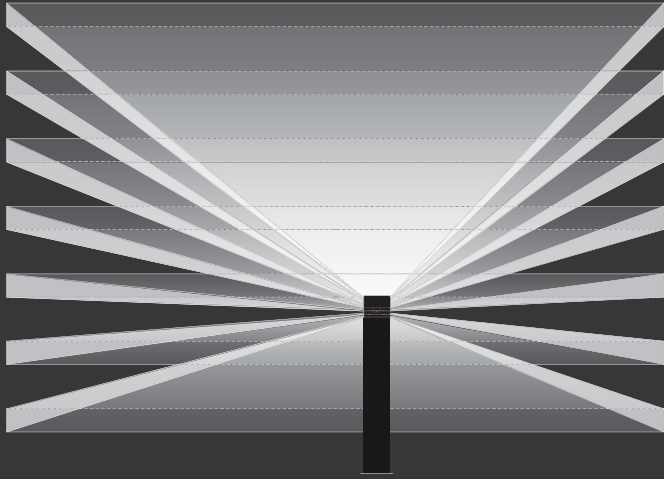


Fig. 12 Light Source (Side Elevation)

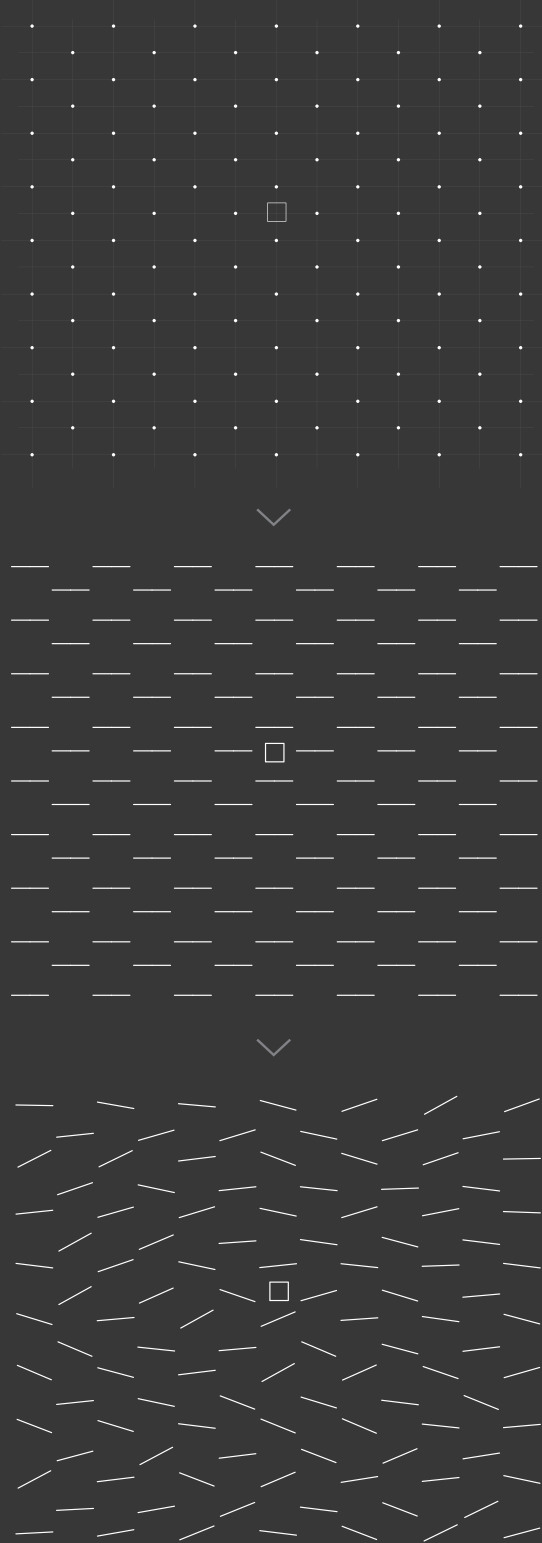


Fig. 13 Logic of Panel Layout

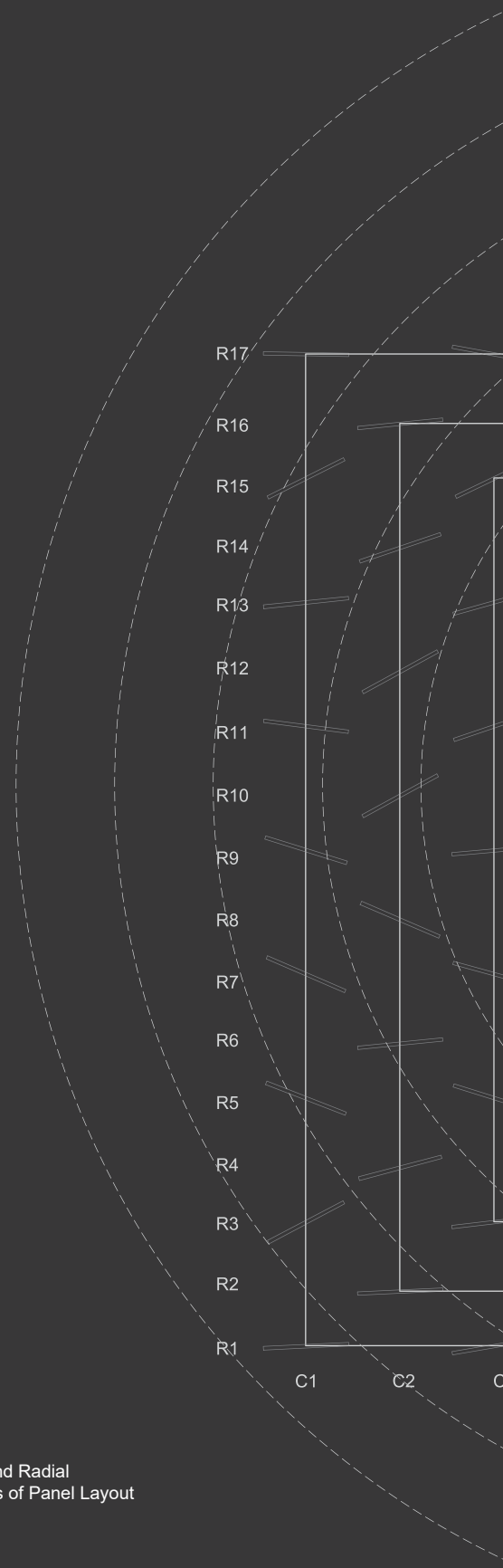


## LIGHT PEDAGOGY

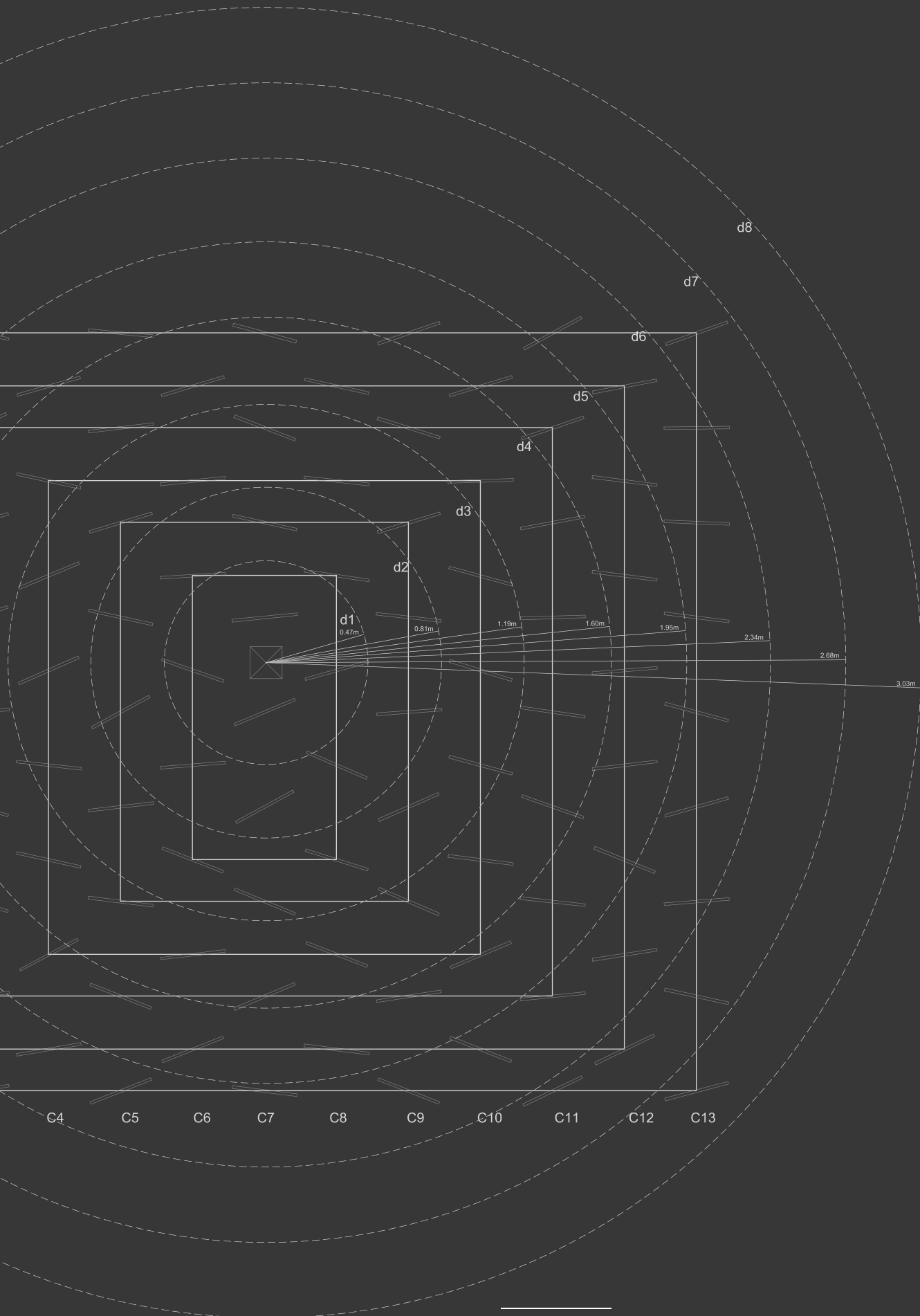
or otherwise, takes advantage of neurological behaviours to compel a specific reaction, which is to focus solely on the implied but elusive physicality of light.

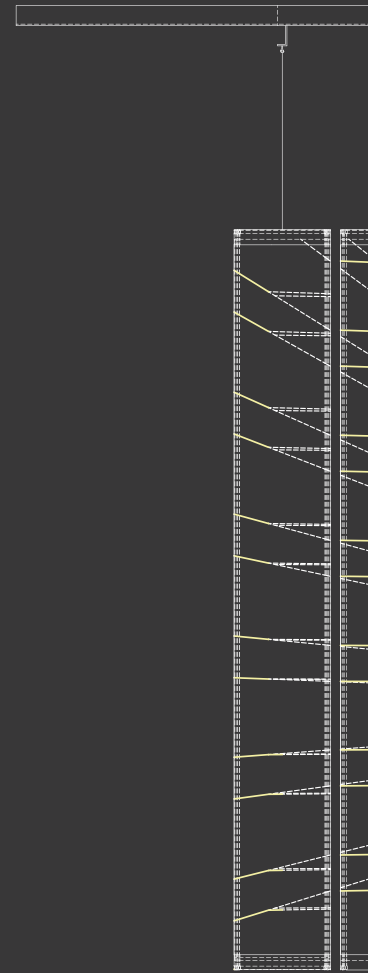
*i*





**Fig. 14** Rectilinear and Radial Organisations of Panel Layout

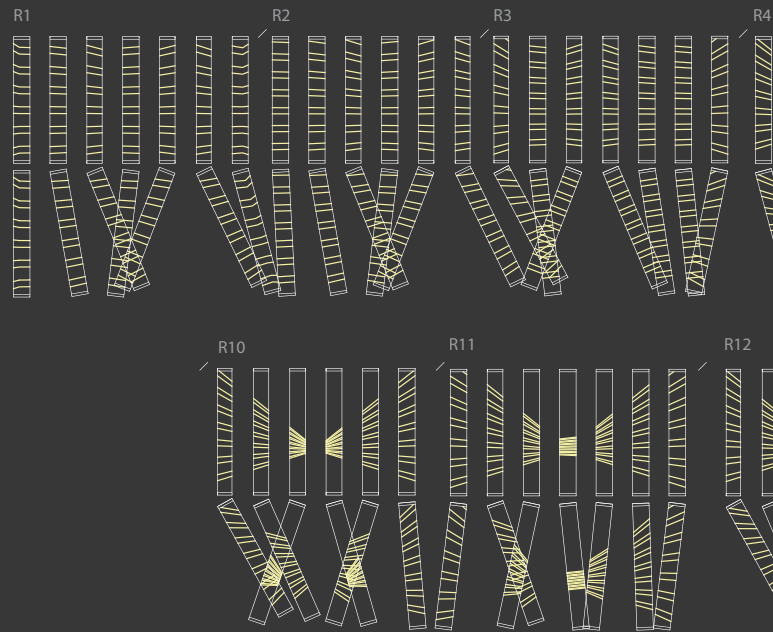


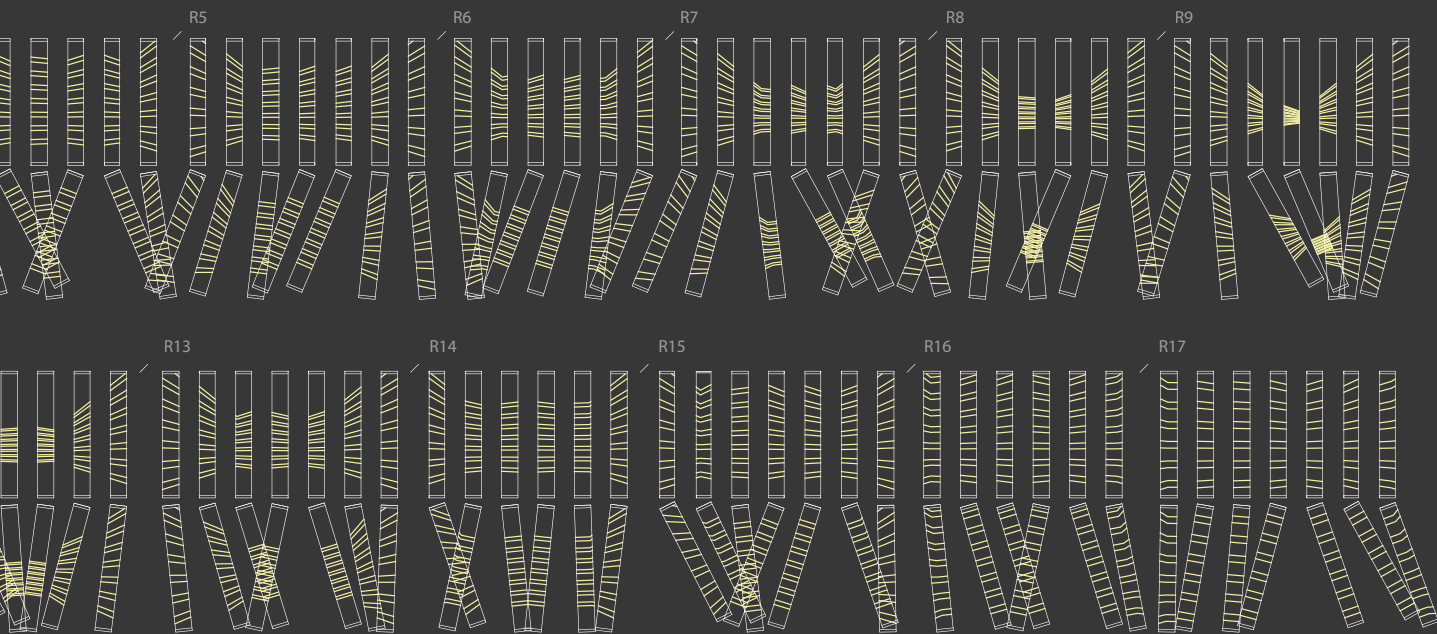
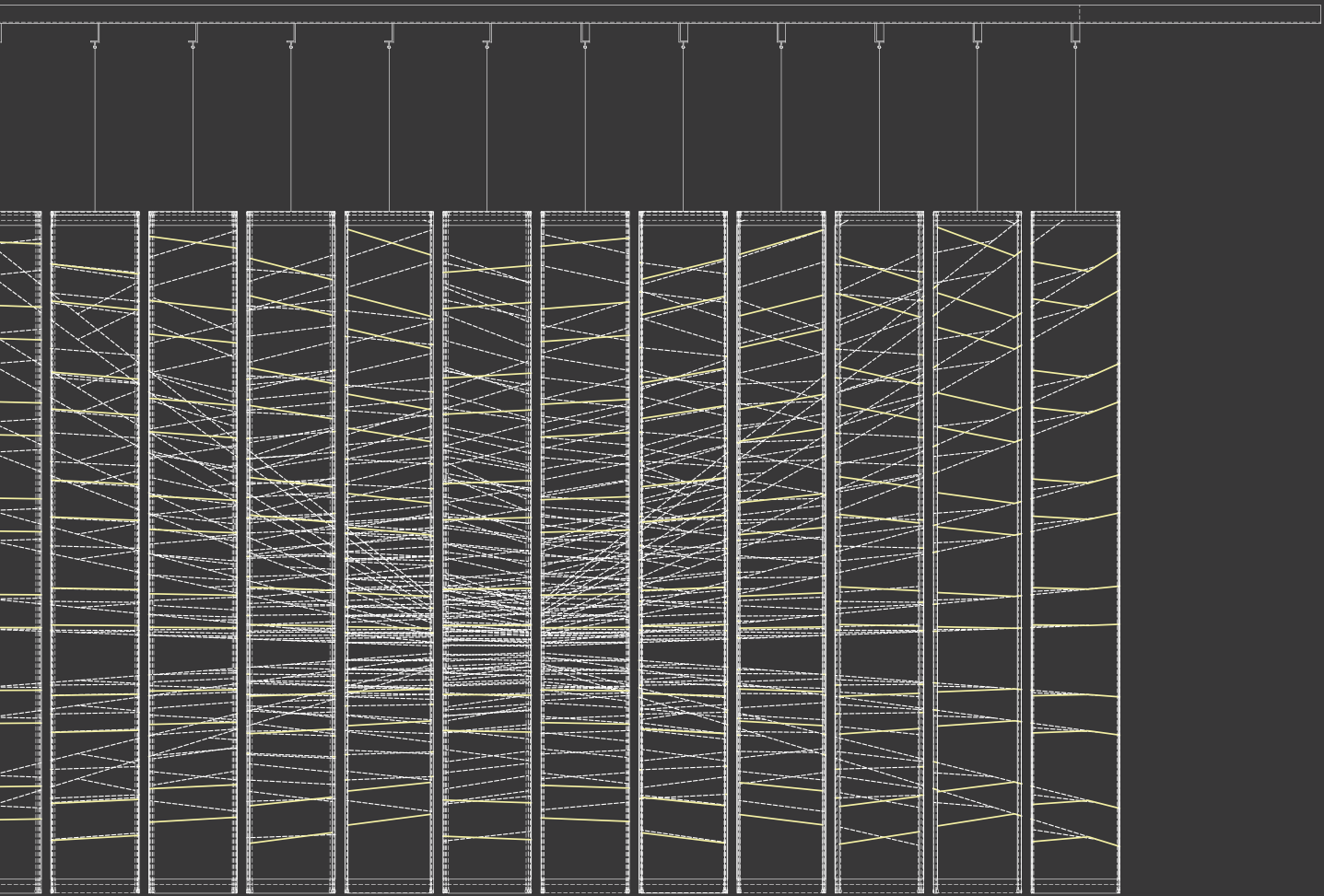


**Fig. 15** Interaction of Light and Fabric (Front Elevation)

**Fig. 16** Horizontal Delamination Diagram Series

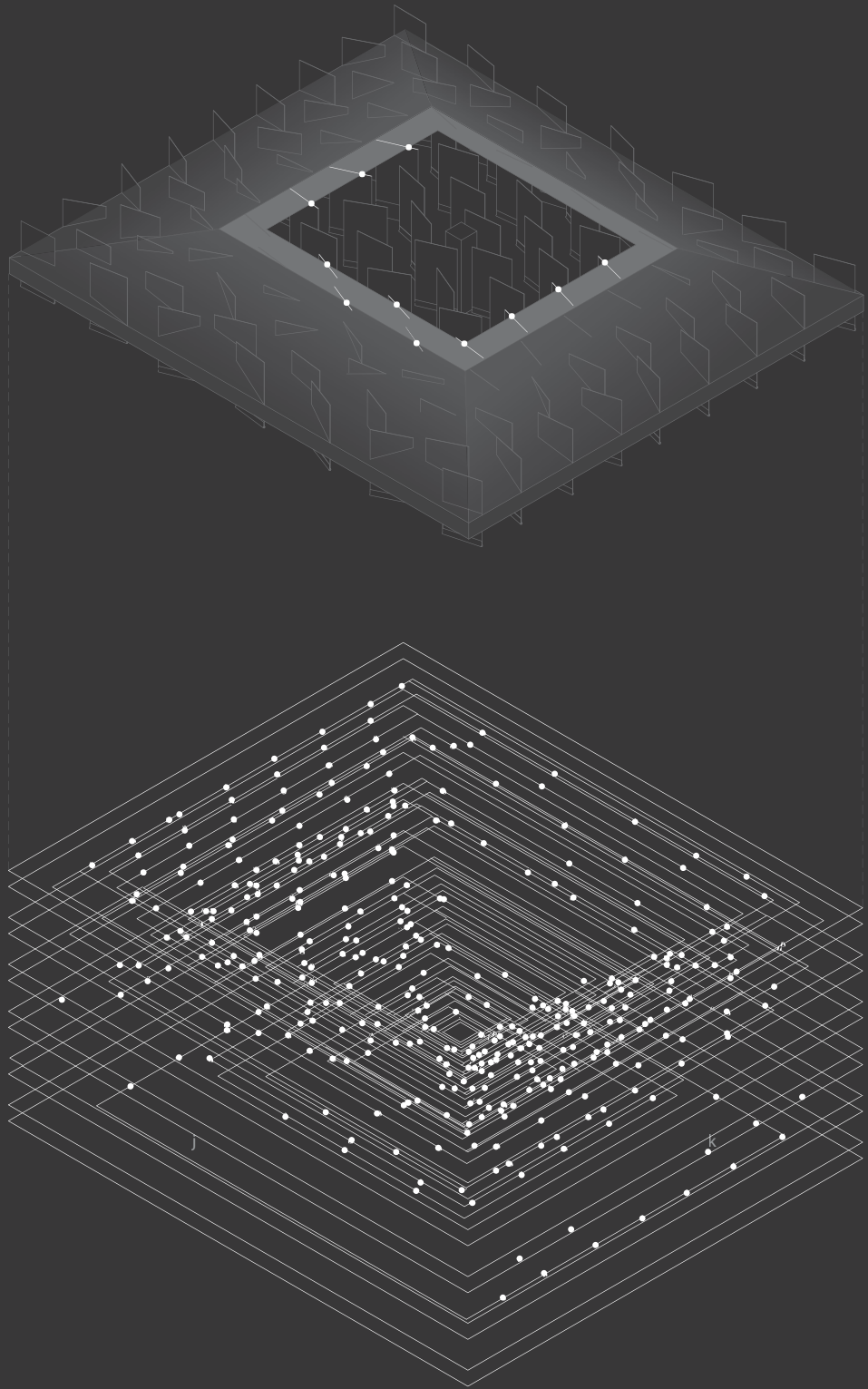
*Panels reflected and rotated per corresponding plan rotation angle.*





Sections a through l shown  
in Fig. 21.

l  
k  
j  
i  
h  
g  
f  
e  
d  
c  
b  
a



**Fig. 17** Intersection of Light Rays and Panels

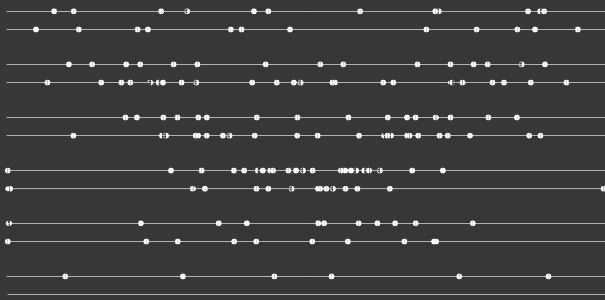


Fig. 18 Front Elevation of Compiled Intersection Points

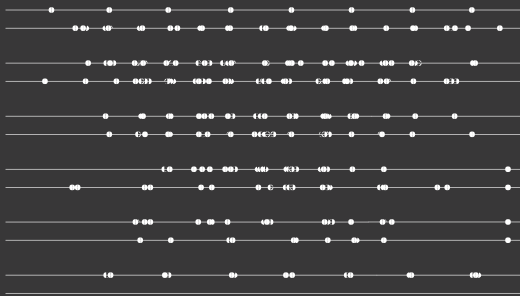


Fig. 19 Front Elevation of Compiled Intersection Points

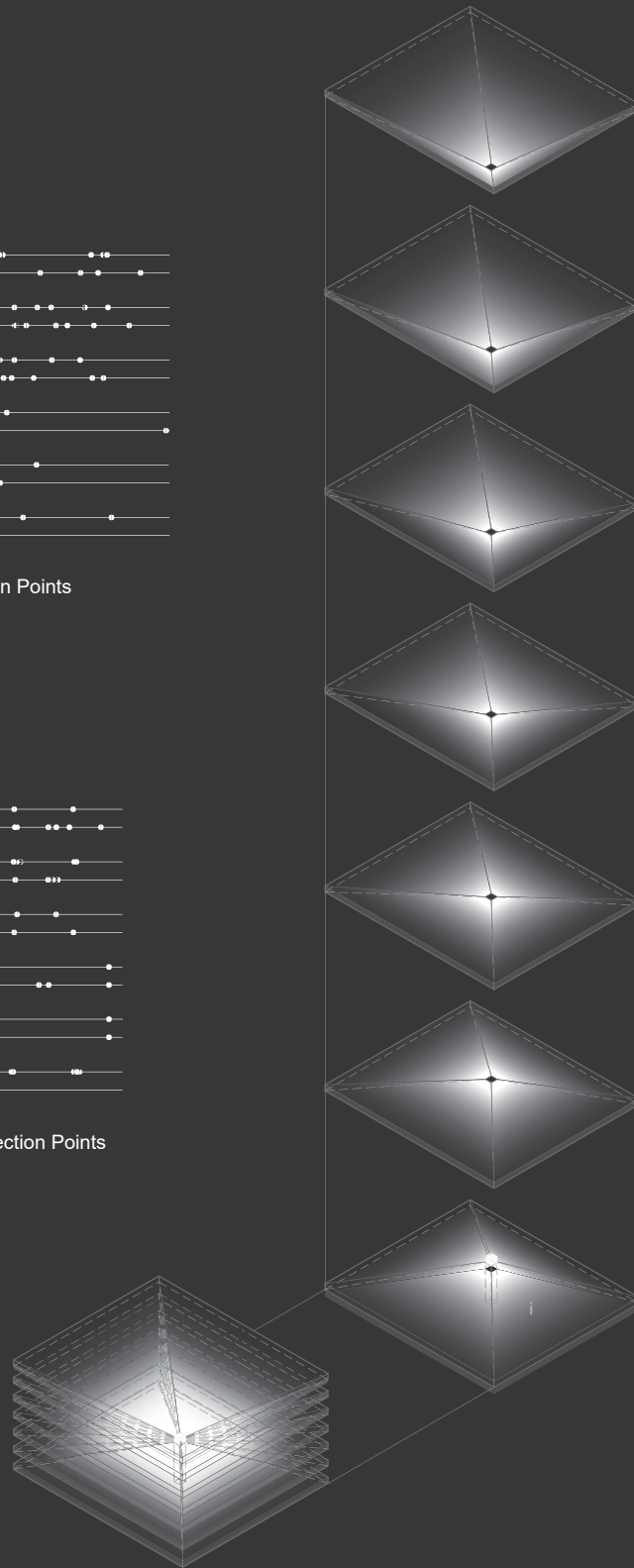
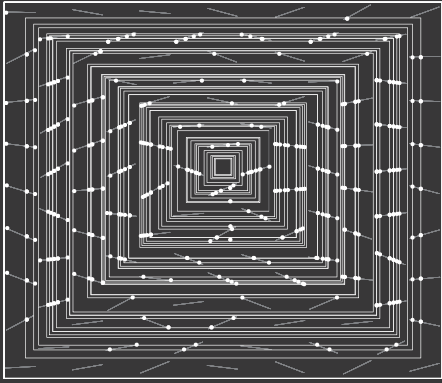
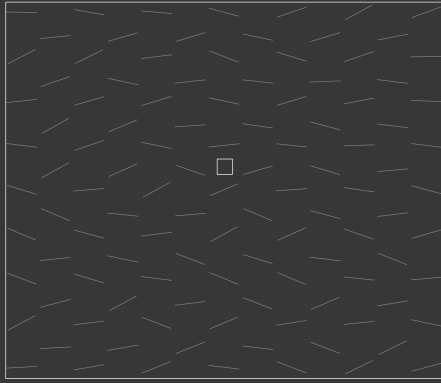


Fig. 20 Delaminated Light Volumes

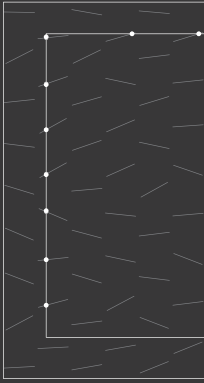




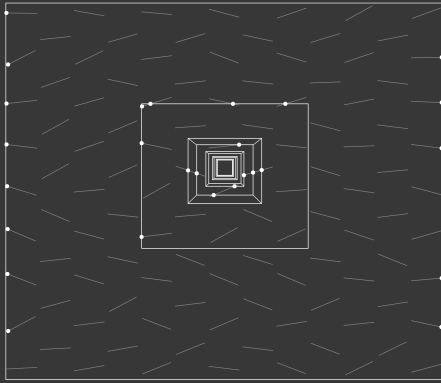
**Fig. 21** Compiled Planar Sections Showing Points of Intersection



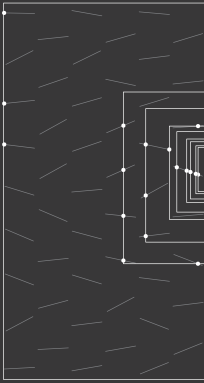
a



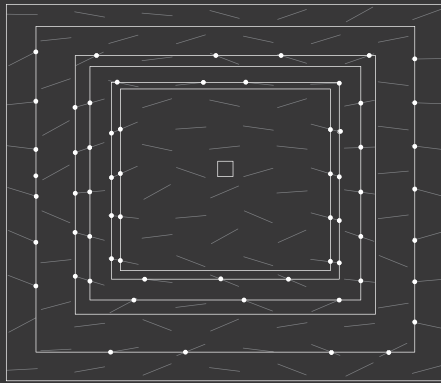
b



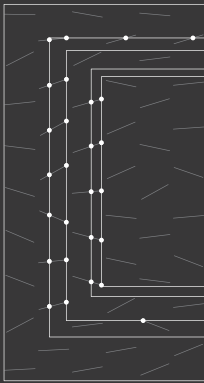
e



f

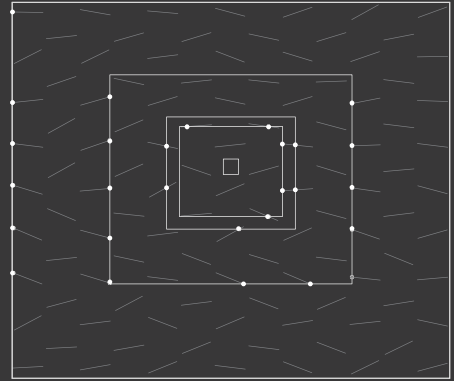
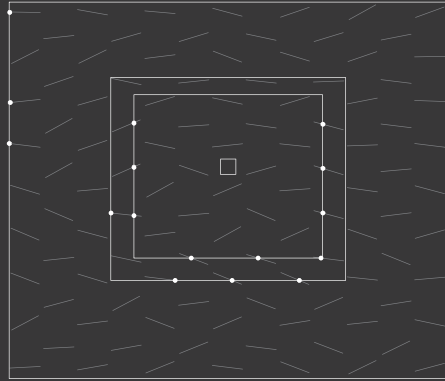
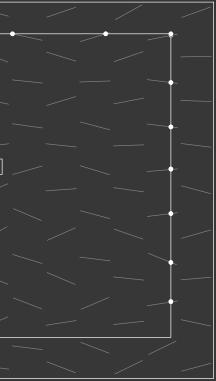


i



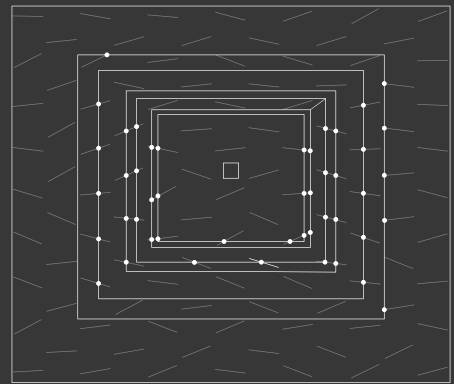
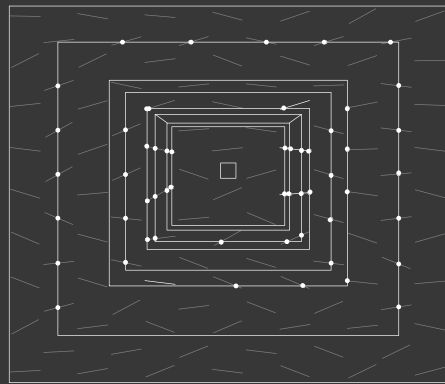
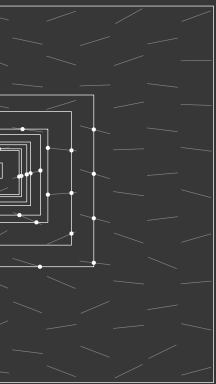
j





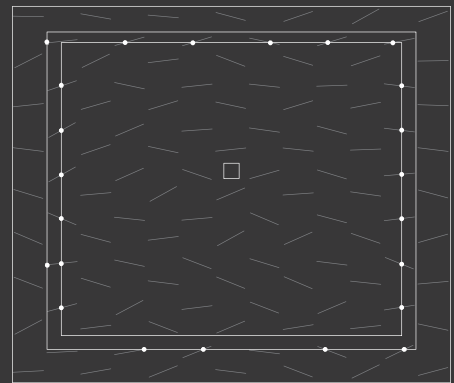
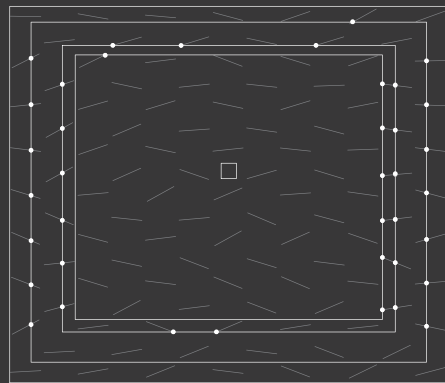
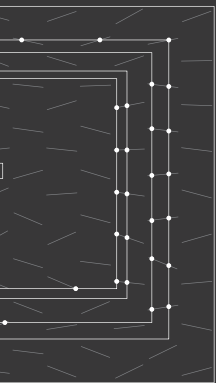
c

d



g

h



k

l

*i*



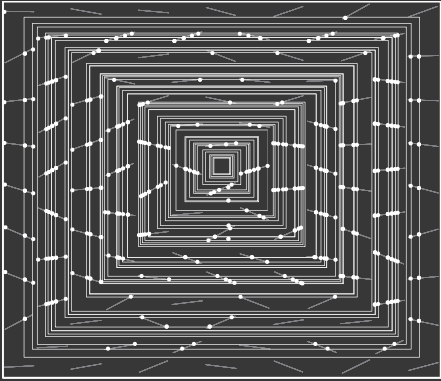
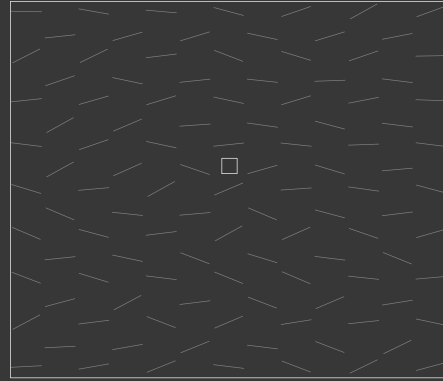
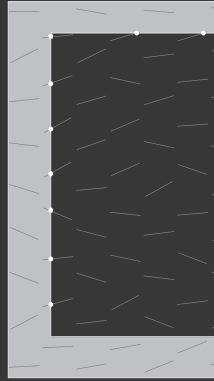


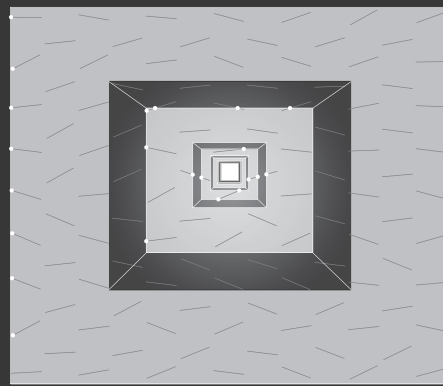
Fig. 22 Compiled Volumetric Sections



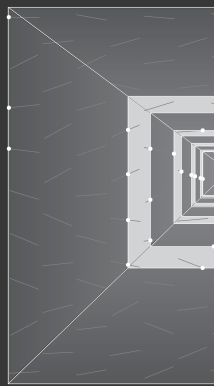
a



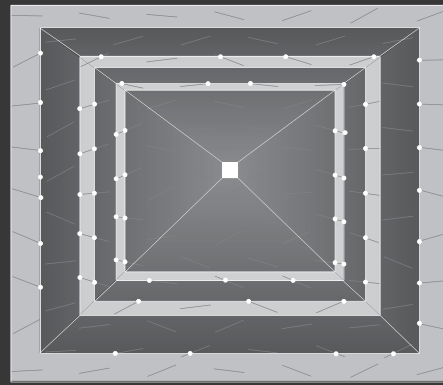
b



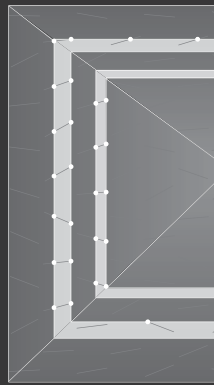
e



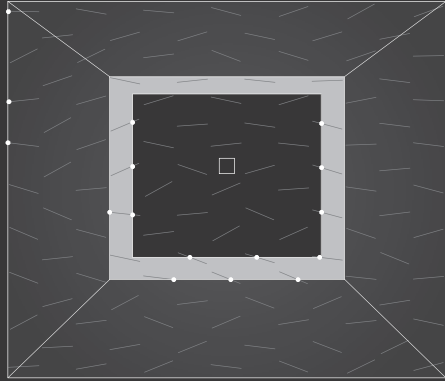
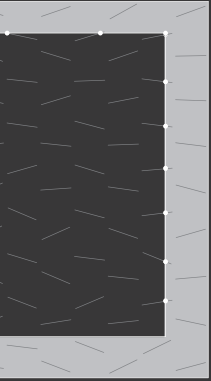
f



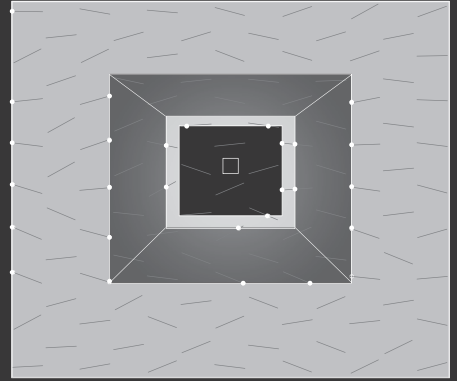
i



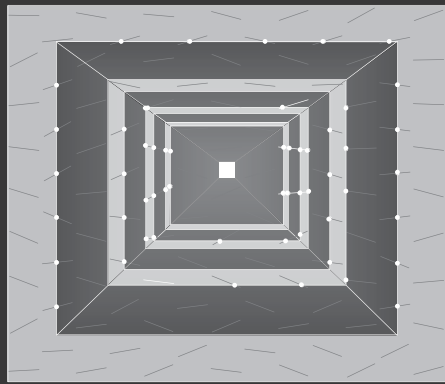
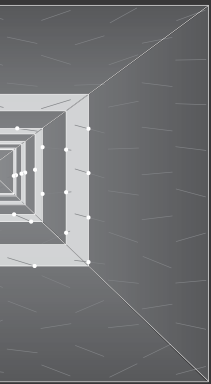
j



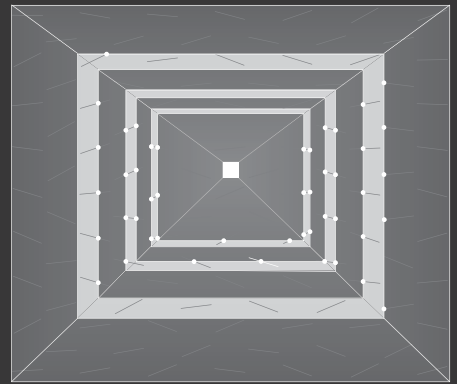
c



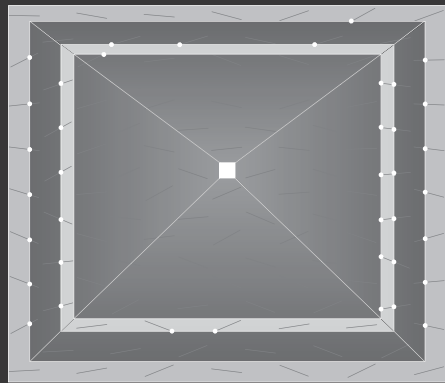
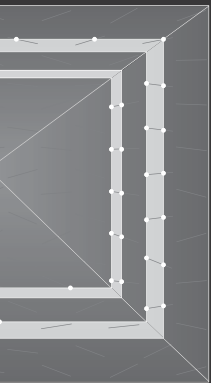
d



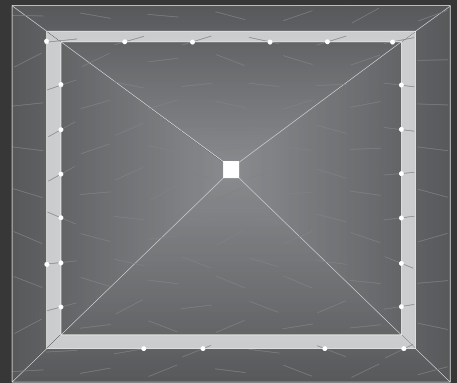
g



h



k



l



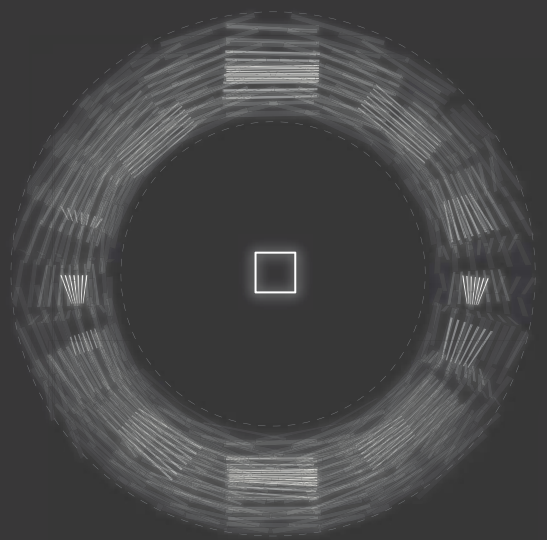


Fig. 23 Collapsed Radial Array

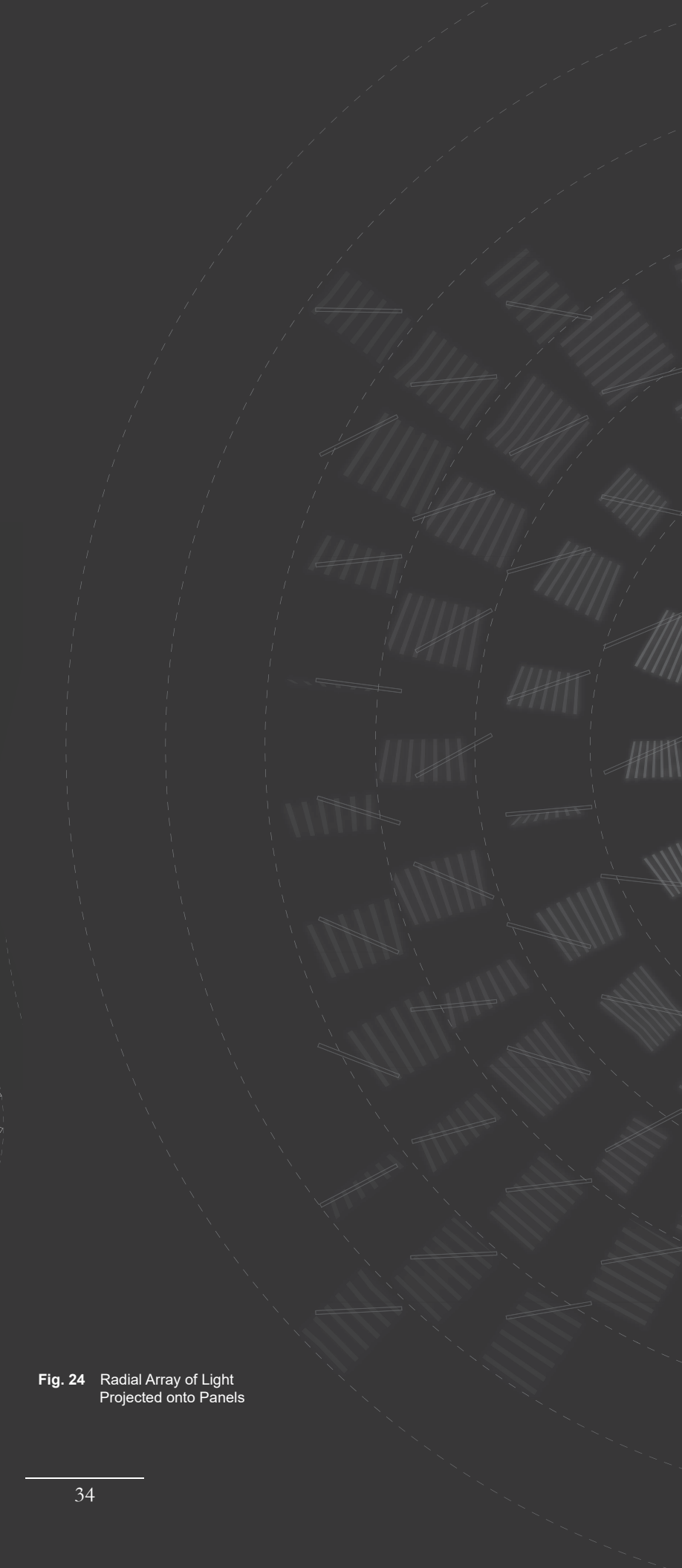
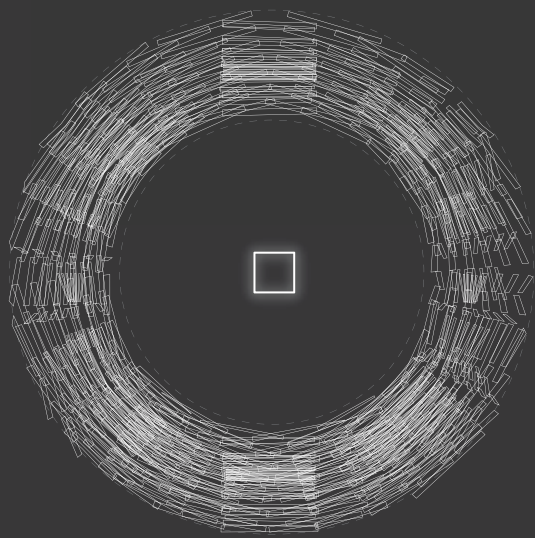
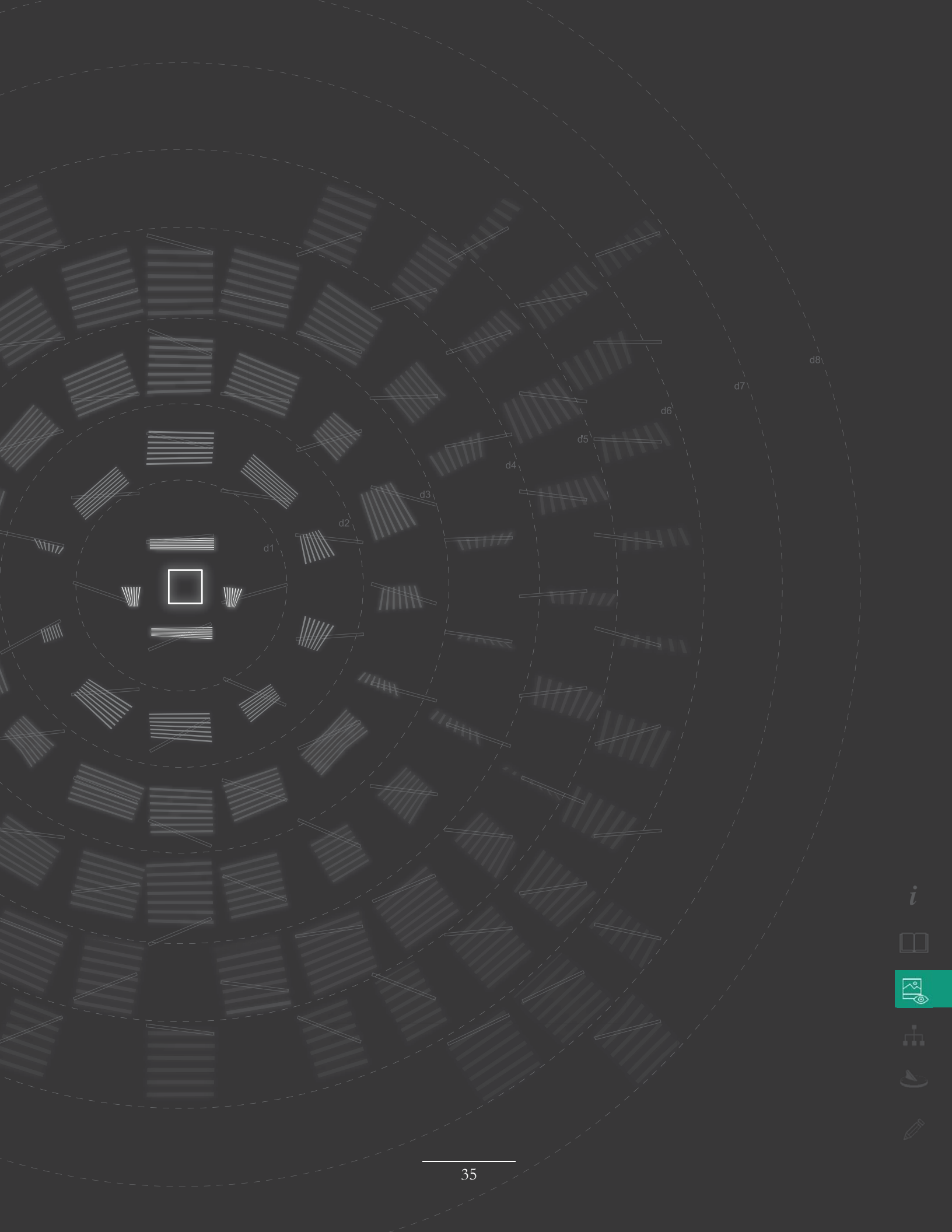
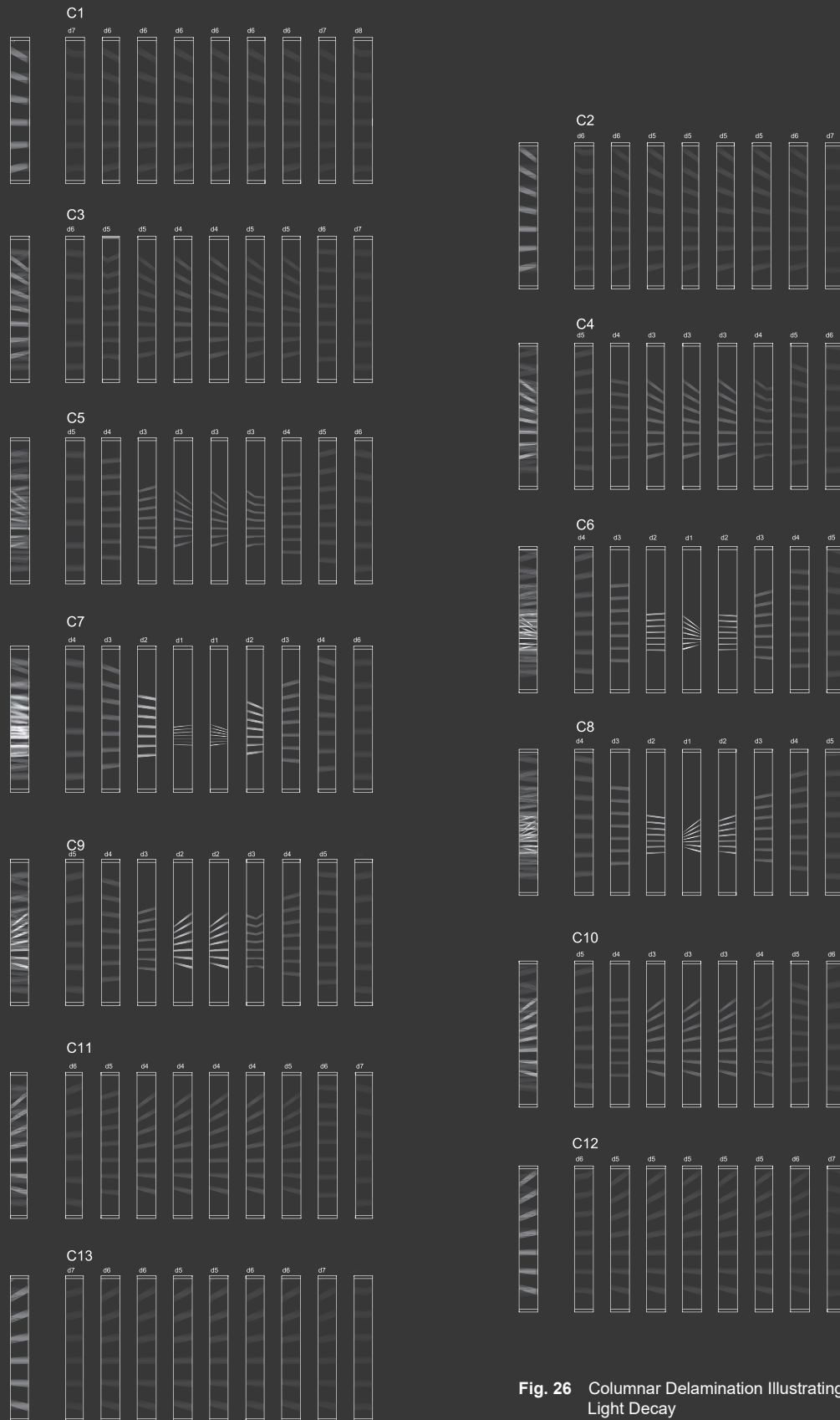


Fig. 24 Radial Array of Light Projected onto Panels







**Fig. 26** Columnar Delamination Illustrating Light Decay

THE STRIATED

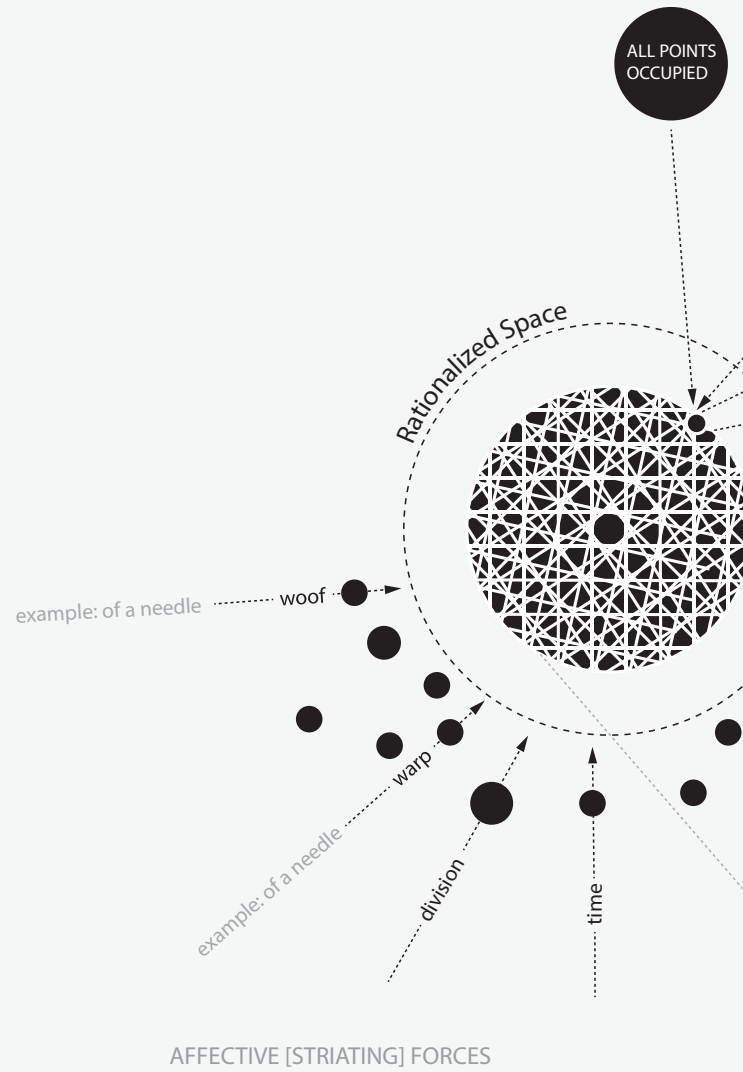
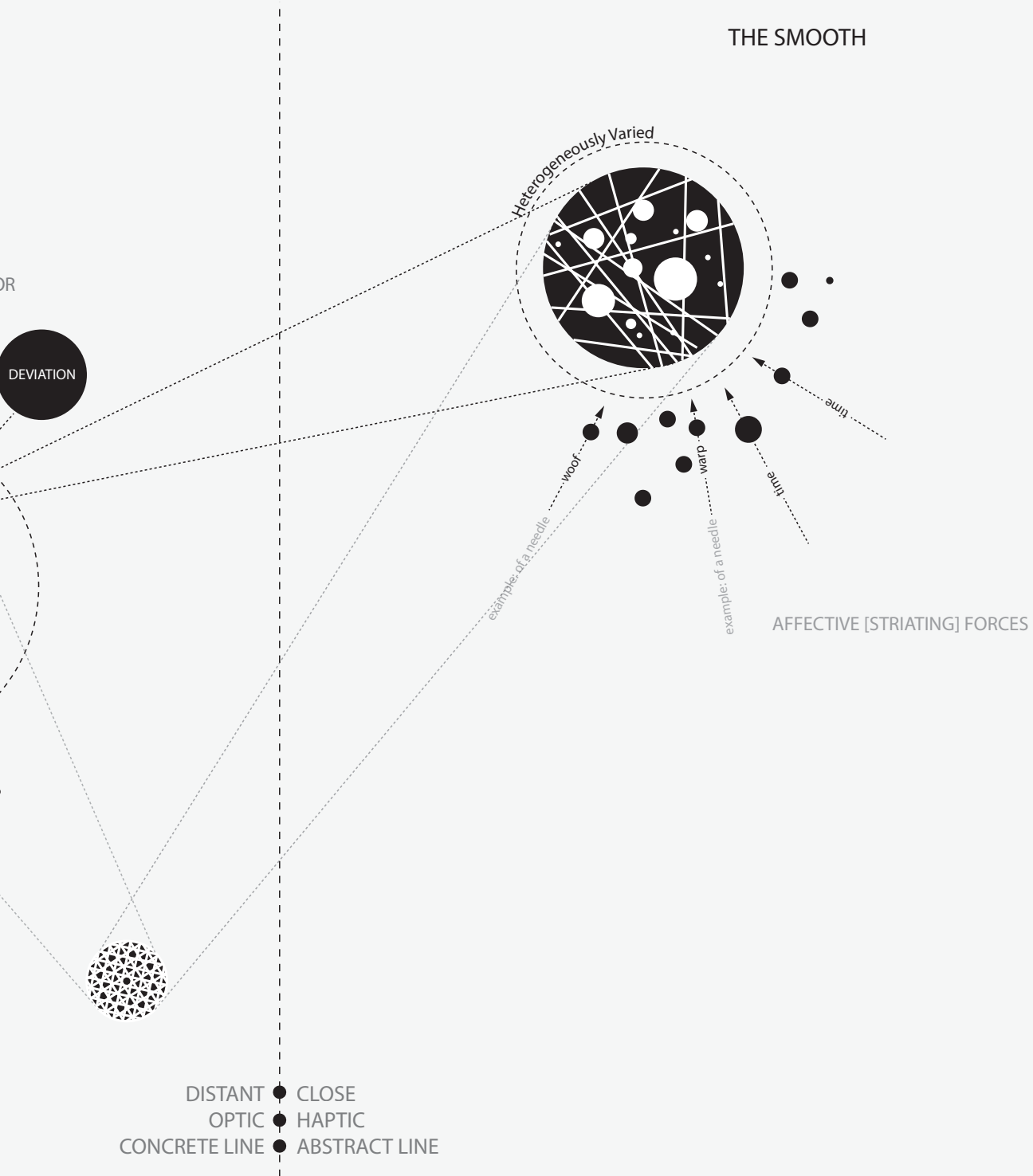


Fig. 27 Diagram of Ideas - "The Smooth and the Striated"



THE SMOOTH



THE INTRINSIC AGENT

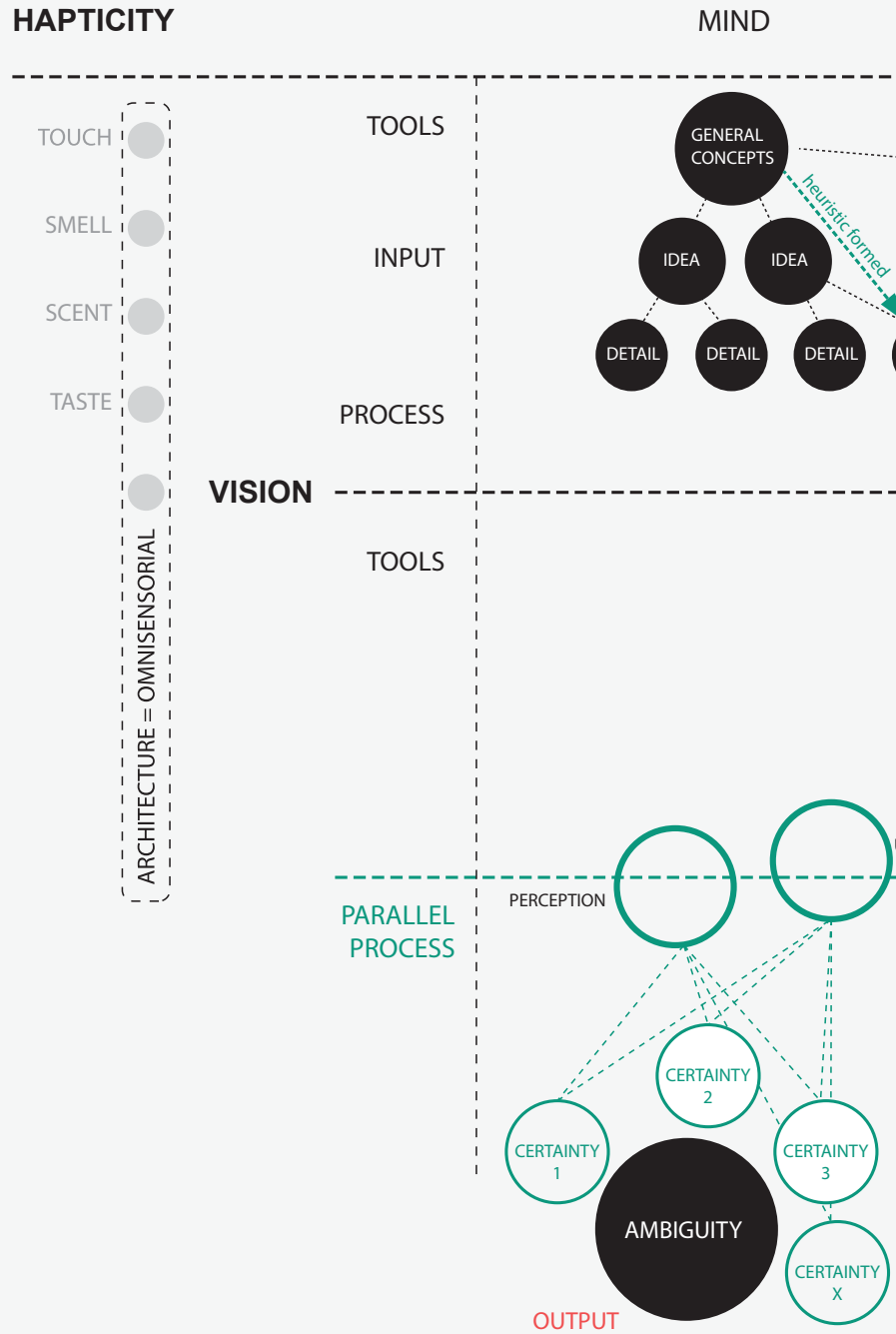
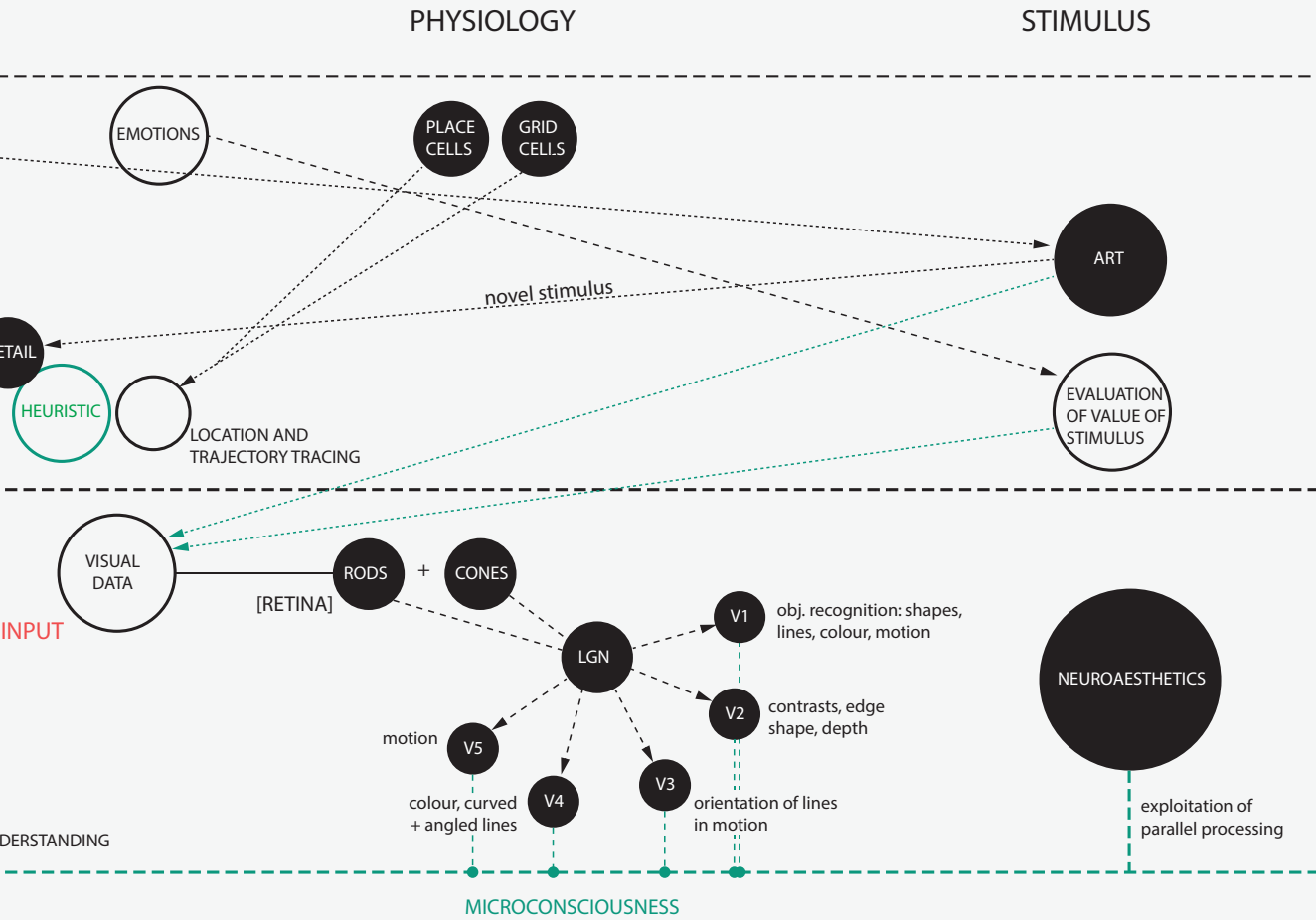


Fig. 28 Diagram of Ideas - The Architect's Brain

# LIGHT PEDAGOGY

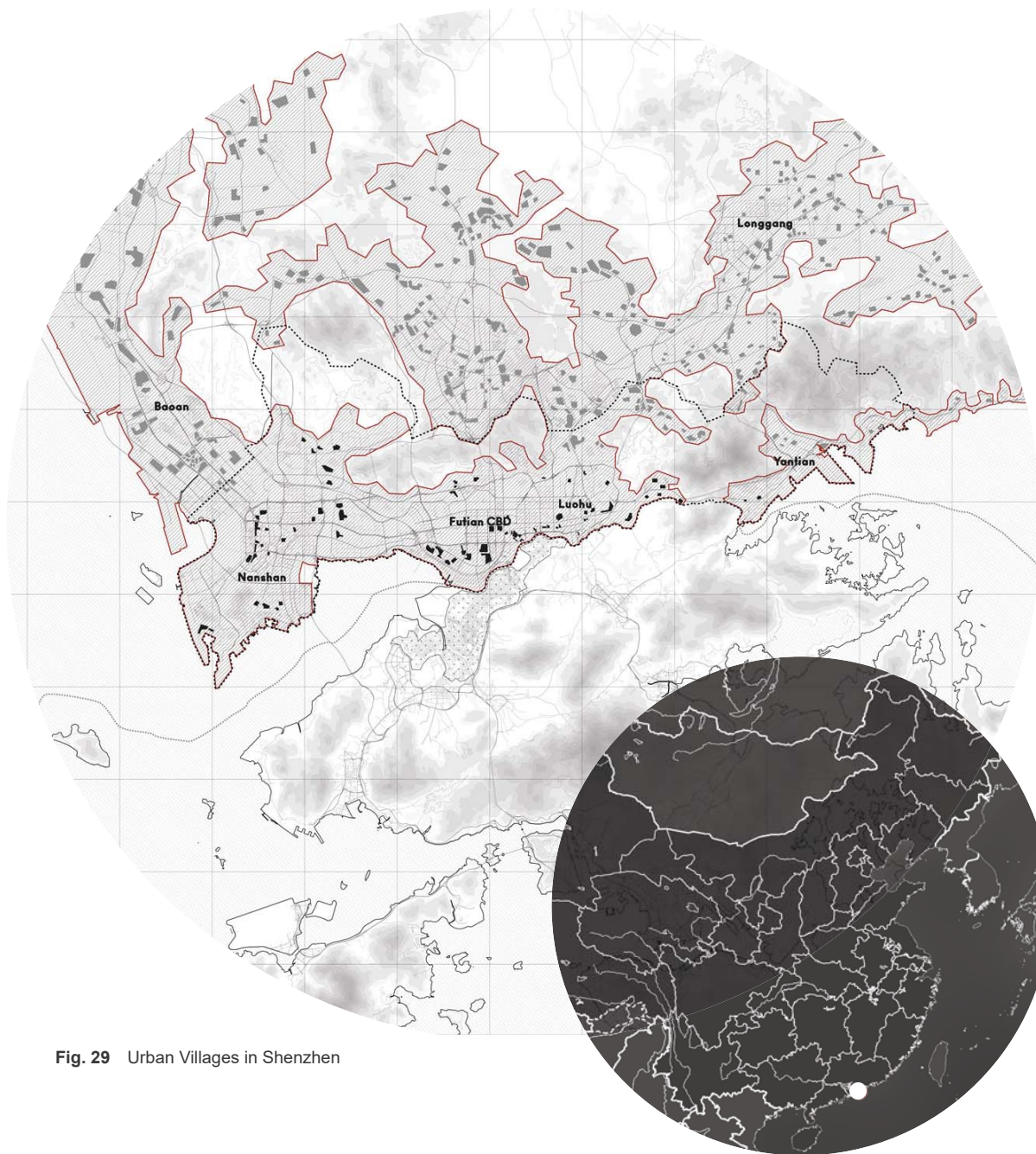




# PART II

---

TESTING PARAMETRICS



**Fig. 29** Urban Villages in Shenzhen

**Fig. 30** Location of Shenzhen in China

## GANGXIA URBAN VILLAGE

---

In the absence of a broader pedagogical framework regarding effects of light, parametric and computational tools with integrated workflows have begun to significantly aid architects in the evaluation of light in built and unbuilt projects. As interest in sustainability has grown, the quantitative analysis of such variables as solar heat gain and sunlight hours has become an increasingly common. These studies can be easily visualised using parametric tools. Grasshopper is a graphical algorithm editor that has been developed for and heavily integrated with Rhinoceros' modeling tools. Rhinoceros, commonly referred to as Rhino, is a NURBS-based<sup>1</sup> 3-D modeling software and computer-aided design application. The tools offered by a standard install of Grasshopper can be useful in developing 3-dimensional models with adaptable histories and inputs. For more specialised operations, plugins have been created for use with Grasshopper.

---

1 NURBS, non-uniform rational basis spline, is a mathematical model that is used by Rhinoceros and other computer-aided design programs to generate and represent curves and surfaces.

## evaluating light

Ladybug, one such “environmental” analysis plugin,<sup>2</sup> offers users the ability to generate graphics that showcase the interaction between weather data and 3-dimensional design geometry. Ladybug, a parametric tool, uses several other programs, computational and otherwise, to generate its results. These integrated tools include EnergyPlus, a whole building energy simulation program, RADIANCE, an engine that produces physical accurate and valid lighting and daylighting simulations, OpenStudio, a collection of software tools that support the energy and light modeling/simulation of EnergyPlus and RADIANCE, and DAYSIM, a RADIANCE-based daylighting simulation and analysis tool that describes the annual amount of daylight in and around buildings.

One of the graphics that Ladybug produces is a 3-dimensional mapping of the total sun hours received by a surface over the course of a given time

---

2 Mostapha Sadeghipour Roudsari and Michelle Pak, “Ladybug: a parametric environmental plugin for grasshopper to help designers create an environmentally-conscious design” (paper presented at the proceedings of the 13th International IBPSA Conference Held in Lyon, France, Aug 25–30, 2013).



Fig. 31 Gangxia Urban Village



# TESTING PARAMETRICS



Fig. 32 Gangxia Urban Village Plan



THE INTRINSIC AGENT

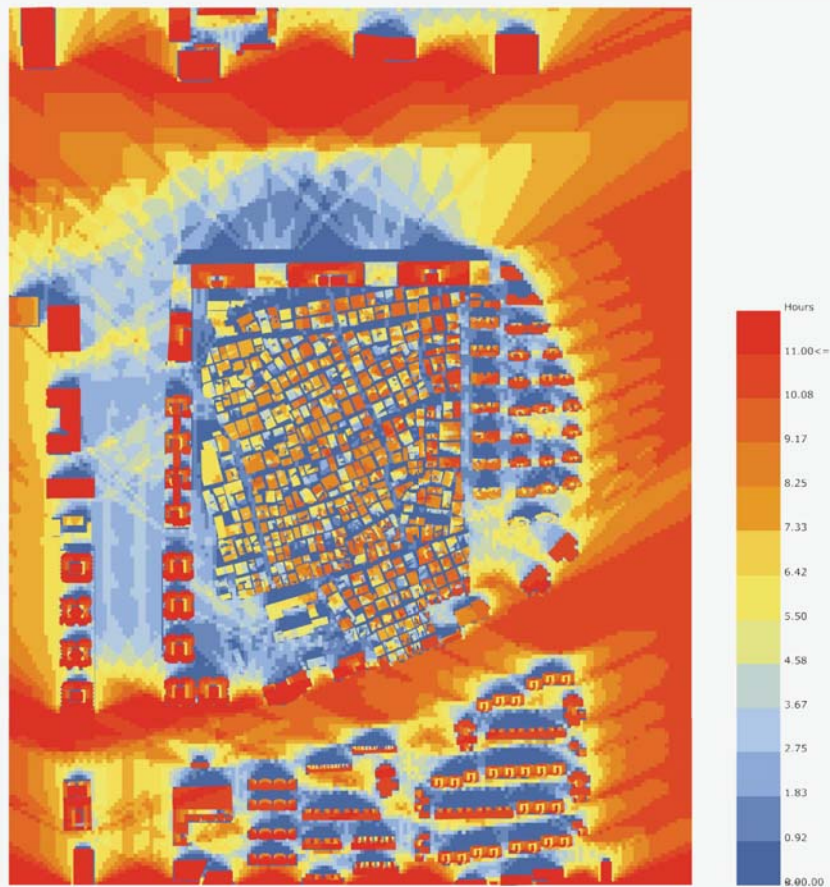
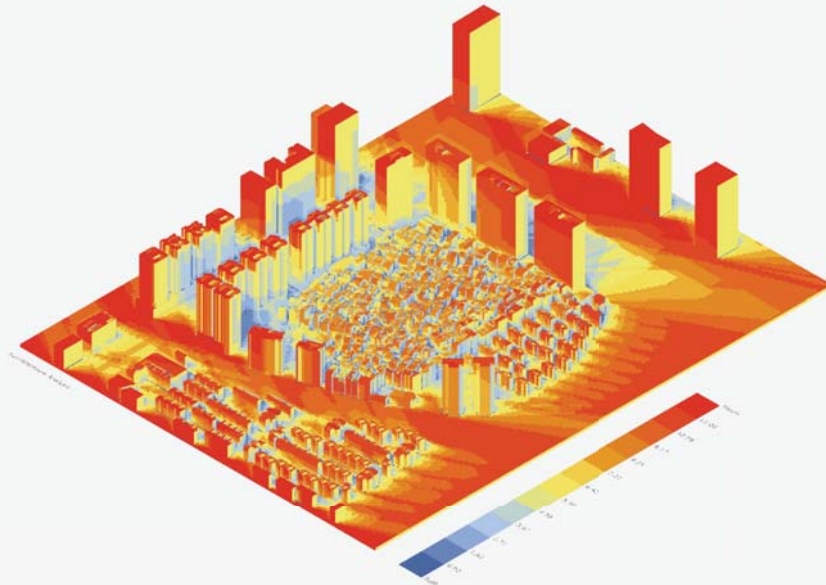


Fig. 33 Summer Solstice Ladybug Daylight Analysis

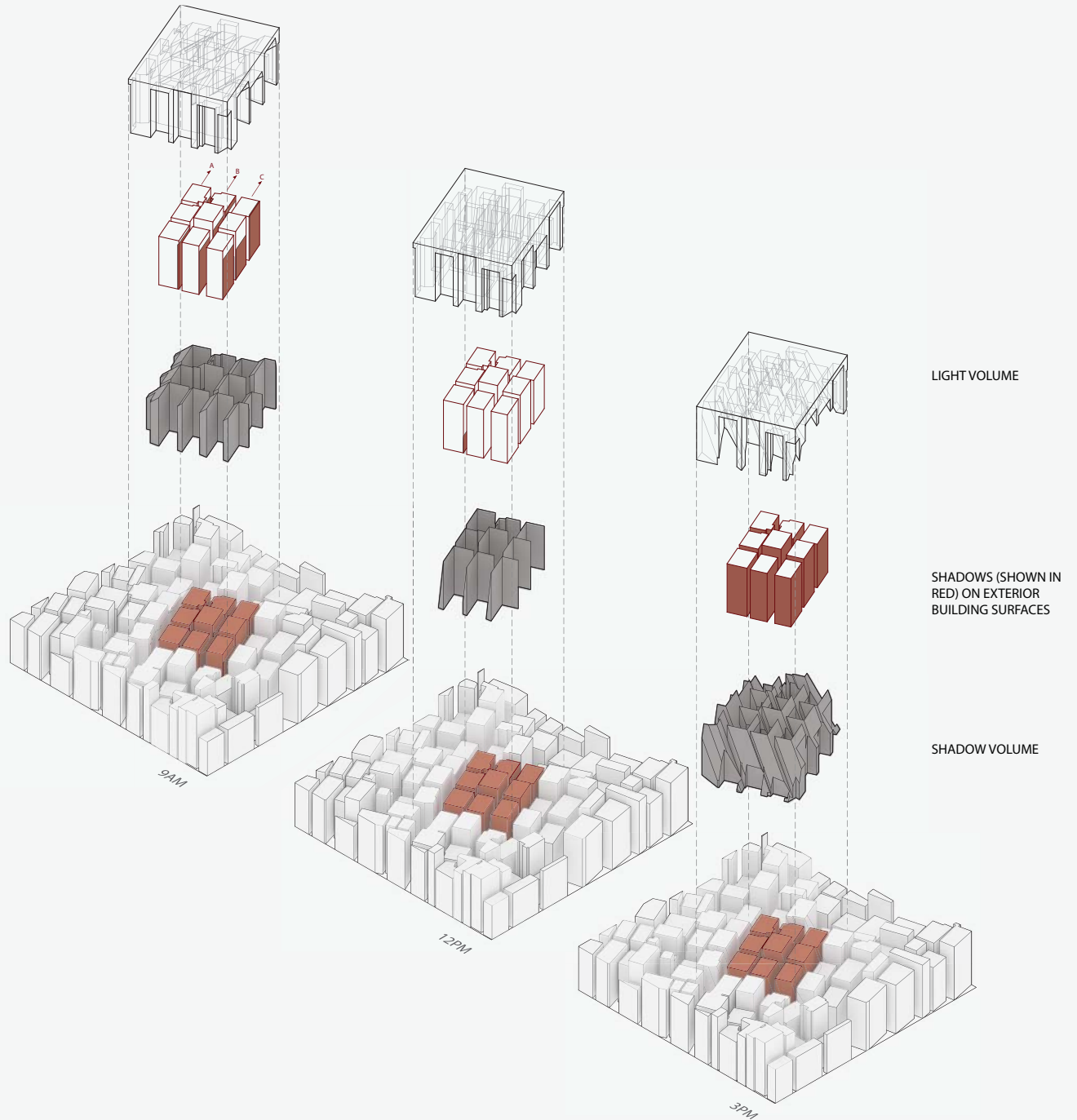
period. This visualisation is useful for highlighting areas that receive either an abundance or scarcity of light over time. Fig. 33 shows the graphic produced by the plugin when the weather data for Shenzhen, China is applied to a Rhino model of Gangxia Urban Village over the course of the Summer Solstice. Gangxia Urban Village is a historic agricultural village whose small, densely-packed building footprints have been extruded into the sky as a simple result of rapid urban growth and land reform, “the dual urban and rural land ownership and management system”, and a large rural migrant population.<sup>3</sup> The village, simultaneously nurtured, surrounded, and being consumed by the metropolis of Shenzhen, is a fertile test site with which to identify the usefulness of this particular tool as a means by which to probe the meeting of light and architecture. Rather than serving as a site study, this investigation of the movement of light through the challenging urban fabric of Gangxia Urban Village in Shenzhen considers the sifting of natural light through a populated, densely built area. The visualisation shows the layering of hourly samples of 3-dimensionally raytraced mappings of lit and shadowed areas based on the position of the sun and the input urban fabric. When the samples are compiled by Ladybug, the accumulated sun hours, based on the overlapping areas, are graded on a colour spectrum of the user’s choosing (in Fig. 33, the default blue to red spectrum is used). While this 3-dimensional image can be converted into a mesh in Rhino, working with the mesh to isolate building faces using Rhino’s (limited) mesh tools can be difficult. However, without this added means of refining the selection of information, the relationship of one sample to the next, especially within the context of sunlight moving through and around the urban fabric remains bound up in the general overview and visual impression of accumulated hours of sunlight exposure. It must be taken into

3 Stefan Al, ed., *Villages in the City: A Guide to China’s Informal Settlements* (Honolulu: University of Hawai’i Press, 2014), 1.

consideration that this site has been selected for its density and scope. At a smaller scale, perhaps that of a small building or room, the accumulation of sunlight hours on individual surfaces might be obvious and informative. However, as far as revealing how light occupies the urban village, the output of the application falls short.

Because Ladybug’s SunlightHours function exclusively visualises the effect of direct light from the sun, it does not take diffuse and specular reflections and ambient light from the sky into consideration. The path of light is traced from the light source until it reaches the geometry of the urban fabric, where it terminates. Conversely, rendering software applications that generate photorealistic (and non-photorealistic) images utilise global illumination (GI) algorithms to produce images that show effects of light scattering (used here in the general sense). In short, the SunLightHours diagram shows *direct illumination* but not *indirect illumination*. As a result, the edge that exists between lit and shadowed areas has absolute resolution and contains no information regarding the possible variety of light effects and conditions. Given this circumstance, the real potential of this kind of simple raytracing arguably lies in the temporal study that is lost in the sun hour analysis, which is typically an image that describes an accumulation over time. A volumetric study (Fig. 34) was instead conducted to generate the digital infill shadow forms that would result from the obstruction of light by the buildings around and among a sample of nine buildings. This laborious process of manual raytracing produces the results of the SunlightHours analysis in a form that can be studied in greater depth. The method involves extruding the footprint of each building along an hourly solar vector before the extrusions are then extended downward to fill the shadowed urban fabric. The difference between the solid shadow volume and building volumes is then removed and an intersection command performed to produce a volume of six or more surfaces split into lit and shadowed faces. These surfaces are then unrolled into flat images that illustrate each vertical façade

# THE INTRINSIC AGENT



**Fig. 34** Ray Tracing Within Urban Fabric (Summer Solstice)

of the nine buildings as a continuous rectangular image (Fig. 36). Fig. 37 recreates the cumulative SunlightHours diagram by using additive layers of opacity. Fig. 38, however, uses a thickening line to show the movement of the boundary between lit and shadowed surface over the course of the day. The progressive movement of the line toward an edge before it slips around it and illuminates or shadows the entire surface presents an alternate point of view regarding the temporal presence of light in the area over the course of a day. Though the more conventional drawing clearly exposes the rather bleak truth regarding the number of sun hours received by the building surfaces as an average over a longer period, the second drawing more effectively allows the viewer to find and understand light as an agent that slips and slides over and between buildings, sometimes arresting entire facades and other times only obliquely catching edges.

The limitations described above are not at all intended as an indictment of a quantitative analyses of light. Though the SunLightHours study is a very common and easy study to complete, the computational tools that Ladybug accesses such as RADIANCE and DAYSIM can produce very sophisticated and precise quantitative and visual analyses (for example, in terms of luminance and illuminance) that can then be tied to a more subjective review. In their paper, “A Simulation-Based Workflow to Assess Human-Centric Daylight Performance”,<sup>4</sup> Rockcastle et al. tie quantitative analysis to a modified algorithm, modified spatial contrast (mSC), and a non-visual direct-response model (nvR<sub>D</sub>). The first criterion measures visual interest detected in 360° renderings against the 7-point (calming – exciting) bi-polar ordinal scale responses to sample renderings of lit scenes

provided by survey of 167 people. While this algorithm returns a calibrated measure of visual interest along a spectrum that ranges from calming to neutral to exciting, the non-visual response model returns a yes-no response to a desired daily dose of light in full and half day increments of light for the purposes of such non-visual human centric benefits as sleep quality, alertness, and vitality.<sup>5</sup> Using these metrics and a streamlined workflow, Rockcastle et al. use Rhinoceros (3-D modeler), DIVA-for-Rhino (daylight and energy modeling plugin), and EnergyPlus and RADIANCE (simulation engines), to develop an exhaustive analysis of the *Ryerson University Student Learning Centre* designed by Snøhetta and Zeidler Partnership Architects.<sup>6</sup> The workflow assesses the two criteria from 135 view points (between the 6<sup>th</sup> and 7<sup>th</sup> floors of the building), 8 view directions from each view point, 28 points in time distributed over four days of the first six months of the year, and 2 sky conditions. This comprehensive study has clear potential to guide the development of the optic devices that have already been developed for a space. Analysis completed from multiple view points and view directions can ensure that the experience is sufficiently consistent or varied. However, the nature of the designed difference and means by which to alter the qualities of the effects are questions that remain with the architect. The thesis seeks to establish the framework within which the nature and tuning of light effect can be expressed in terms that can be reconciled and integrated with these highly developed tools.

---

4 Siobhan Rockcastle, María Lovísa Ámundadóttir, and Marilyne Andersen, “A Simulation-Based Workflow to Assess Human-Centric Daylight Performance” (paper presented at the annual Symposium on Simulation for Architecture and Urban Design [SimAUD], Toronto, Canada, May 22-24, 2017).

---

5 Ibid., 25  
6 Ibid., 28.



THE INTRINSIC AGENT

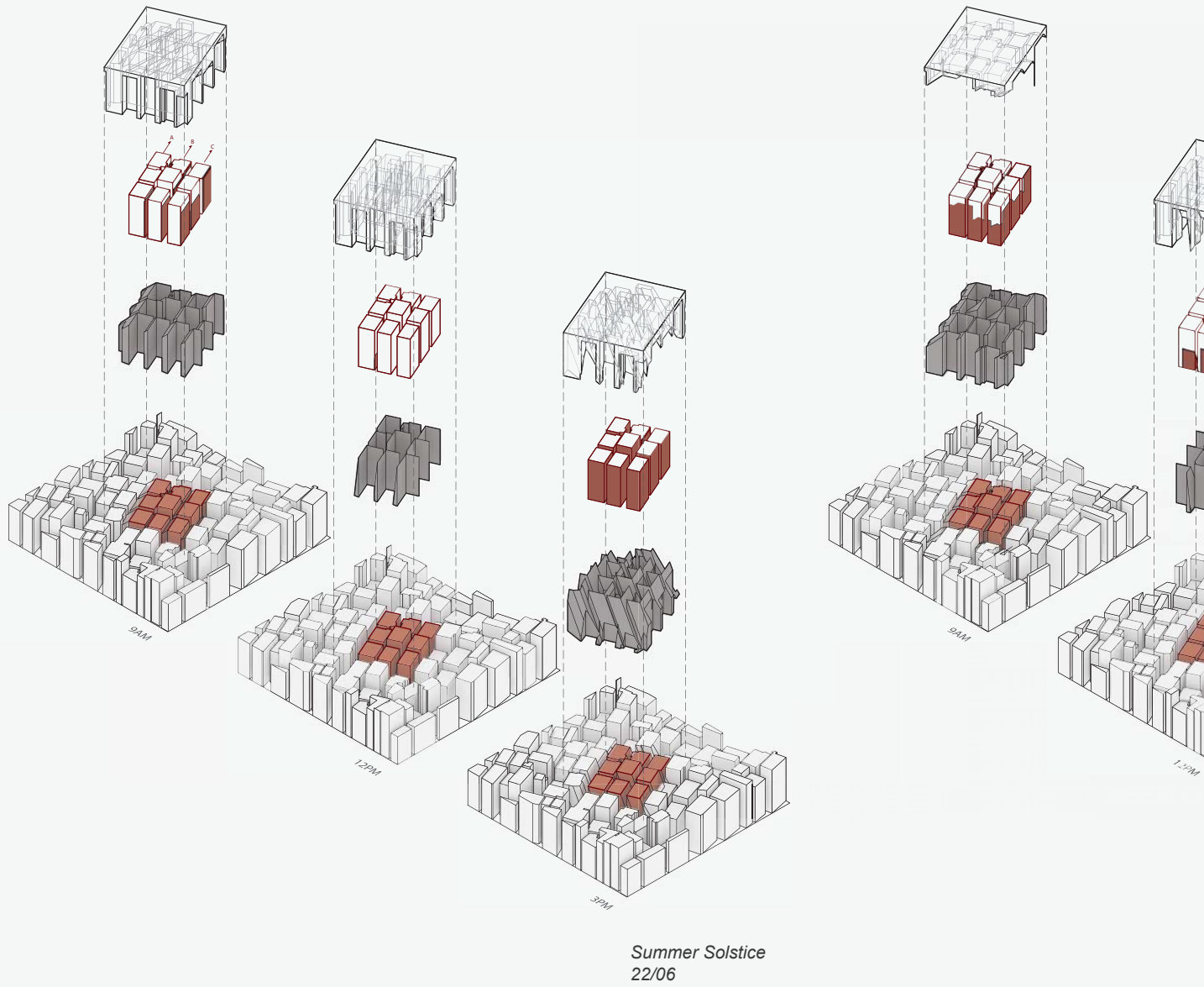
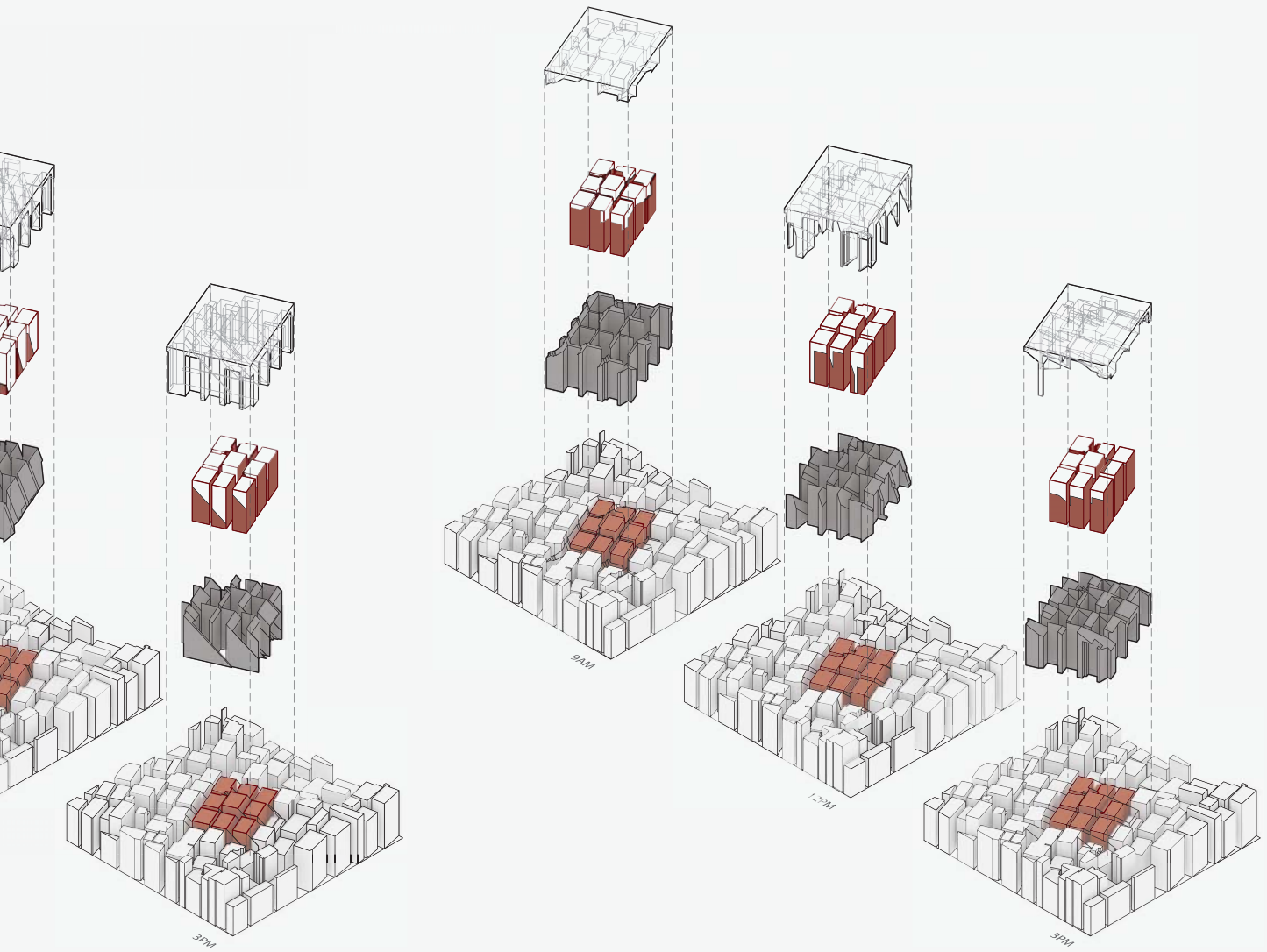


Fig. 35 Ray Tracing Within Urban Fabric

# TESTING PARAMETRICS

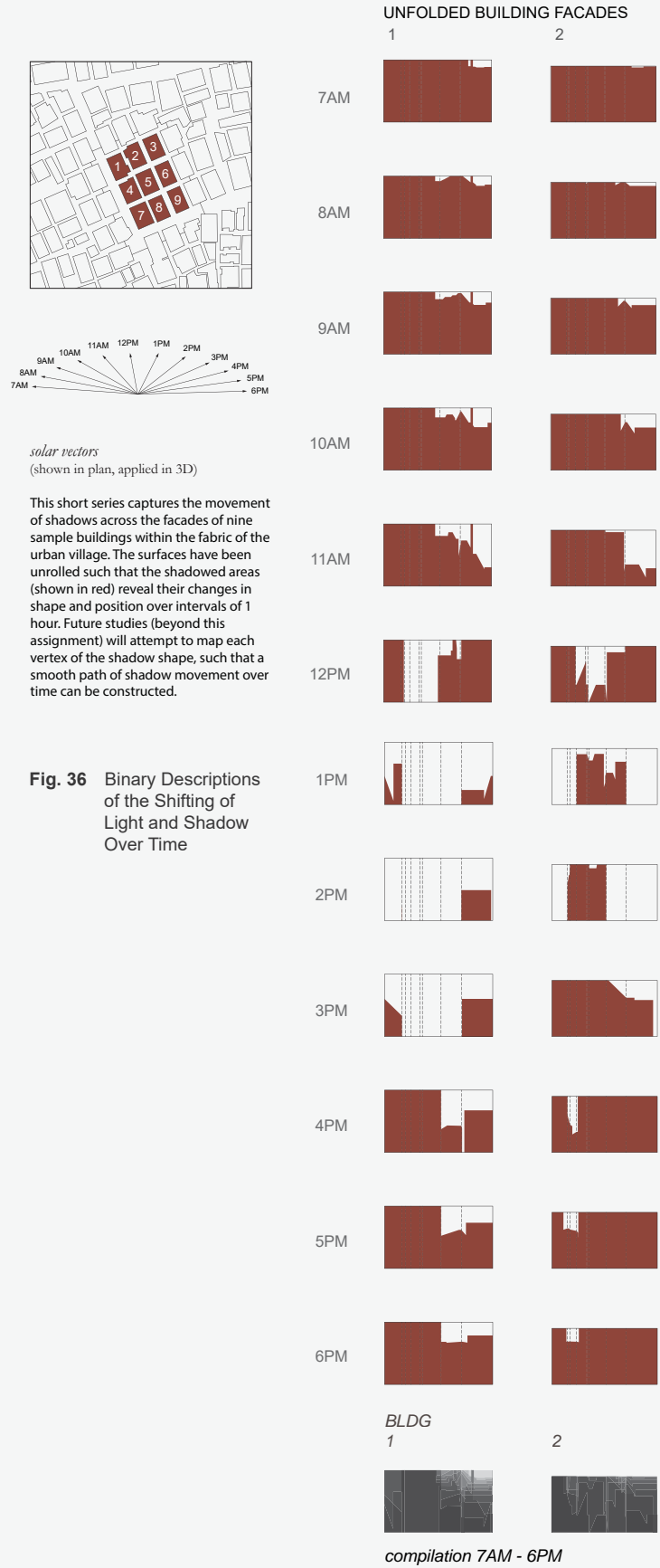


Autumn Equinox  
23/09

Winter Solstice  
22/12

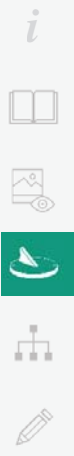
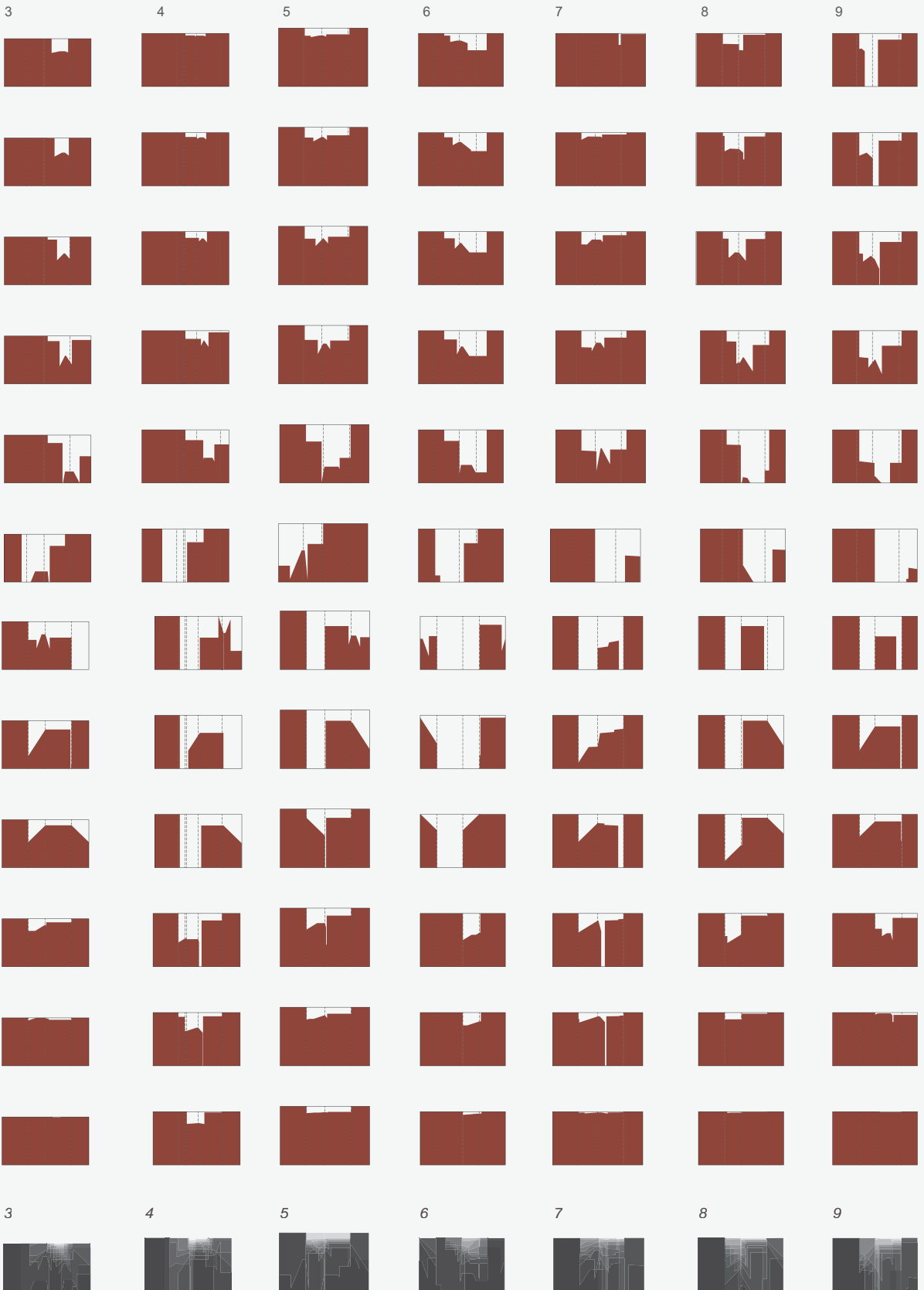


# THE INTRINSIC AGENT





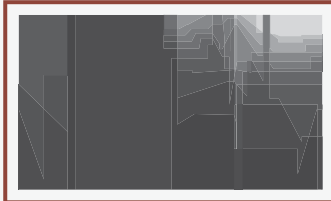
# TESTING PARAMETRICS



THE INTRINSIC AGENT

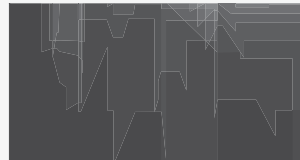
*BLDG*

1

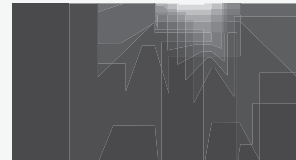


*compilation 7AM - 6PM*

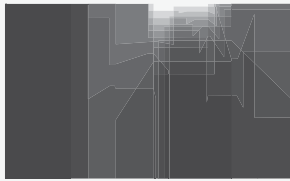
2



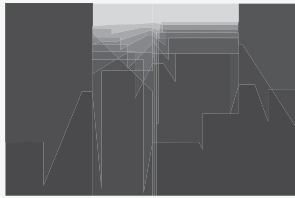
3



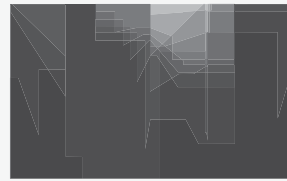
4



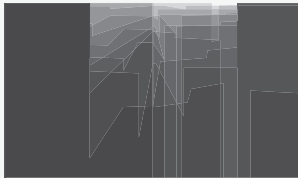
5



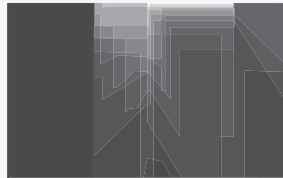
6



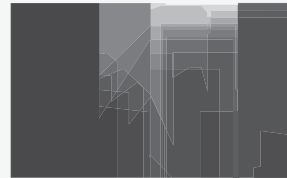
7



8



9

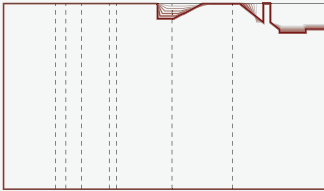


**Fig. 37** Light and Shadow Composites

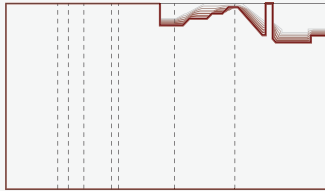
TESTING PARAMETRICS

*BLDG 1*

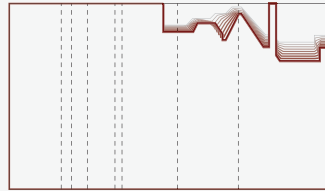
7AM - 8AM



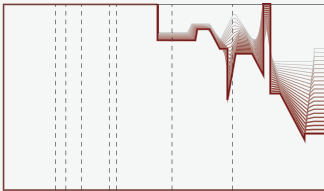
8AM - 9AM



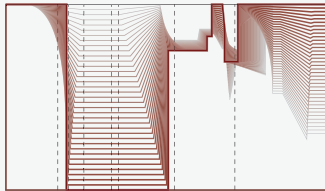
9AM - 10AM



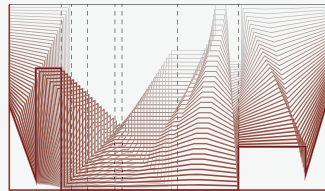
10AM - 11AM



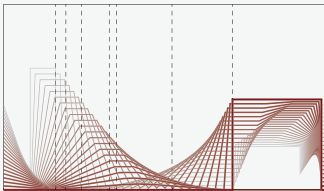
11AM - 12PM



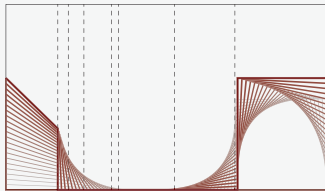
12PM - 1PM



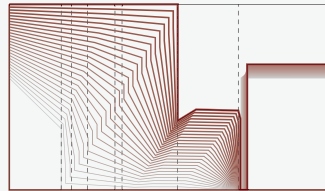
1PM - 2PM



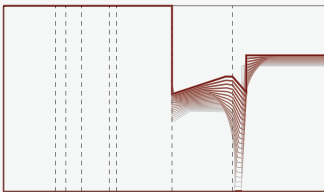
2PM - 3PM



3PM - 4PM



4PM - 5PM



5PM - 6PM

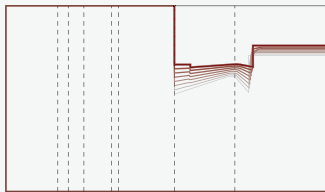


Fig. 38 Light Contour Transformation for Building 1 (7AM-6PM)





**Fig. 39** Veil Form in Isolation

## EXPERIMENTING WITH INFORMATION

---

At the core of finding the relationship between light and architecture is the determination of the degree of agency that tectonic devices can have in the formation of light effect. The following illustrated experiment intentionally relinquishes architecture's agency in favour of a light-influenced form-finding process. At the foundation of the experiment is the hypothesis that parametric tools can be used to disrupt a homogenous, generic architectural logic and produce an aesthetically consistent form that is derived from a significant source of ambient information. Because my thesis seeks to expose the potential convolution of the logics that govern light and architecture, the raw data that is the primary input of the algorithmic modeler (Grasshopper) is a sampling of real world solar vectors. The experiment began with a reading of Manuel DeLanda's essay, "Uniformity and Variability", in which he raises the issue of contemporary material isotropism, the homogenisation of material behaviour in all directions.<sup>1</sup> He argues that this kind of treatment of

---

1 Manuel DeLanda, "Uniformity and Variability: An Essay in the Philosophy of Matter" (paper presented at the Doors of Perception 3: On Matter conference, Amsterdam, Netherlands, November, 1995).

## capturing light

raw materials produces inert and invariant materials that are then used in mass producible but inefficient structures.<sup>2</sup> I have proposed that an extreme architectural manifestation of this phenomenon would take the form of a tower of gridlines that are uniformly distributed in all three directions at one metre intervals. This resolution has been chosen for its architectural scale and ability to receive, in some detail, the information that is imposed upon the grid by the parametric definition. In this scenario, architecture falls in line with the structural grid, and has no concept or functional purpose through which to deviate from the norm.

The input light information distorts the perfect uniformity of the gridlines with a grid spreading definition that registers the points where reflections of light entering only from the top of the form intersect a perfect cylindrical 'core' within the tower of lines. The disrupted lines are then used to interpolate an undulating surface that registers the concentrations of light that would be received and subsequently generated by the mirrored, ribbon-like optic infrastructure. Light is found to be concentrated around the vertex of the parabolic path of the movement of the sun over the course of the day, and this manifests itself in open, atria-like spaces that are fluted at either end and occur along

---

2 Ibid.

# THE INTRINSIC AGENT

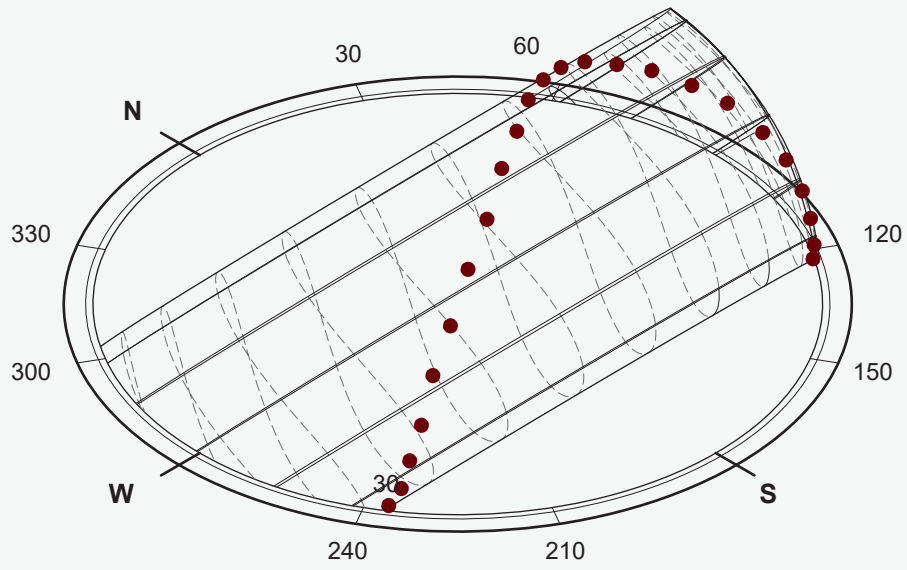


Fig. 40 Sun Path Diagram / Lat 43.67°

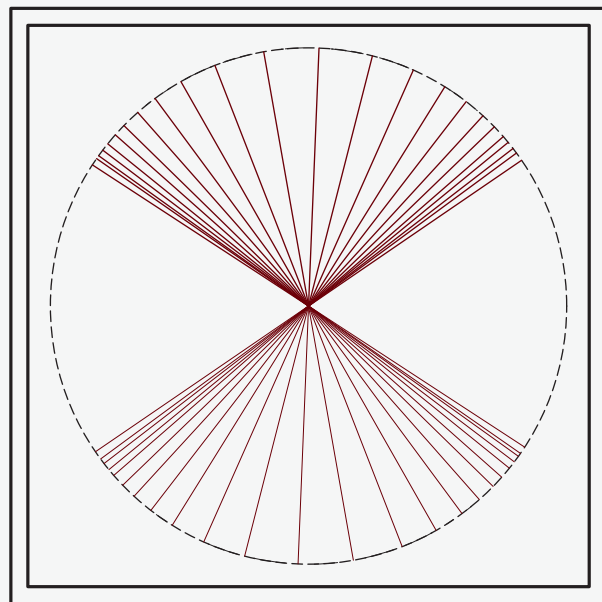


Fig. 41 Plan View of Indexed Rays Undergoing Reflection

the length of the produced surfaces. The definition, a linearly procedural and derivative tool by nature, then extracts the mean curvature of eight hundred points along the generated surface and creates a solid form of variable thickness. The geometry is thick where the mean curvature of the surface is low and thin where the mean curvature is high. The experiment has been intentionally completed as an isolated control experiment and means by which to directly apply ambient information to a base architecture. It assumes that one of the participating parties (architecture) is homogenous and takes a single, simplified behaviour of the other (sunlight), adds a degree of manipulation to it, and posits an interaction of the two that produces a series of surfaces with fluid aesthetic qualities.

This experiment was developed with the intention of introducing heterogeneous effects of light to the everyday life of the urban dweller. For its projected context, the experiment draws on the densely-packed urban fabric of Gangxia Urban Village, the subject of the sunlight hour study in Part II. The forms were forecast as the core of a small residential tower whose entire length would be visible to the viewer, something that was impossible to preserve alongside the division of the tower into individual living units. Recessing the units from the forms would have the effect of completely disenfranchising the central veils from their role as an everyday optic infrastructure. Instead, they would become sculptures within a courtyard. In his book, *Anti-Object*, Kengo Kuma addresses the past and present tension between subject and object that confronts architects as they develop architectural forms. In his analysis of the cultural and architectural developments that fueled Bruno Taut's design of the Hyuga Residence, Kuma introduces some relevant rules made by Kant regarding the treatment of both architecture and object. Using the English landscape garden as an analogy for the architecture of the time, Kuma summarises, "...the subject... does not simply compartmentalise qualitatively different experiences... Unsatisfied by superficial experiences, the human spirit naturally seeks an underlying

order."<sup>3</sup> In this experiment, an underlying order is apparent in the consistent aesthetic of the generated form. However, the method of its production does not consider the future presence and participation of the 'human spirit' within the space, rendering the produced form an entity whose scale and ambiguous role render it an object (in the form of an oversized sculpture) within space. Though it may be possible to argue that the object could have become a part of the architecture through its tectonic resolution, attempts to post-rationally construct a logic of integration were unsuccessful. The attempts to resolve the issue only serve to clarify the need for the exterior and interior characteristics of the space to be governed by the same underlying logic. Although containing the light-driven form within a traditional residential tower typology fails to produce functional architecture by combining two disparate logics, I would argue that an exterior governed by the same limited definition used to develop the veils would not be able to accommodate conventional habits of dwelling. Without significant redesigning, the limited definition is incapable of anticipating our human need for a variety of types of space including those that are private, semi-private, and public.

The method of using data to transform subdivided surfaces or an array of base units is a common architectural practice that has merit. However, in this case, problems are evident because the scope of input architectural and ambient information is too limited and the parametric model too linear. The two main points of contention that I found to come out of the veil experiment were ones of objecthood and scale. Is it possible for the interpolated form to serve to enrich the occupant's perception of the space if the form occupies it as an object in its own right? This intrusion on the part of the nested forms upon the usefulness of space is a contravention of the ambition of the experiment to shape everyday life without instigating a complete

---

3 Kengo Kuma, *Anti-object: The Dissolution and Disintegration of Architecture* (London: Architectural Association, 2008), 24.



THE INTRINSIC AGENT

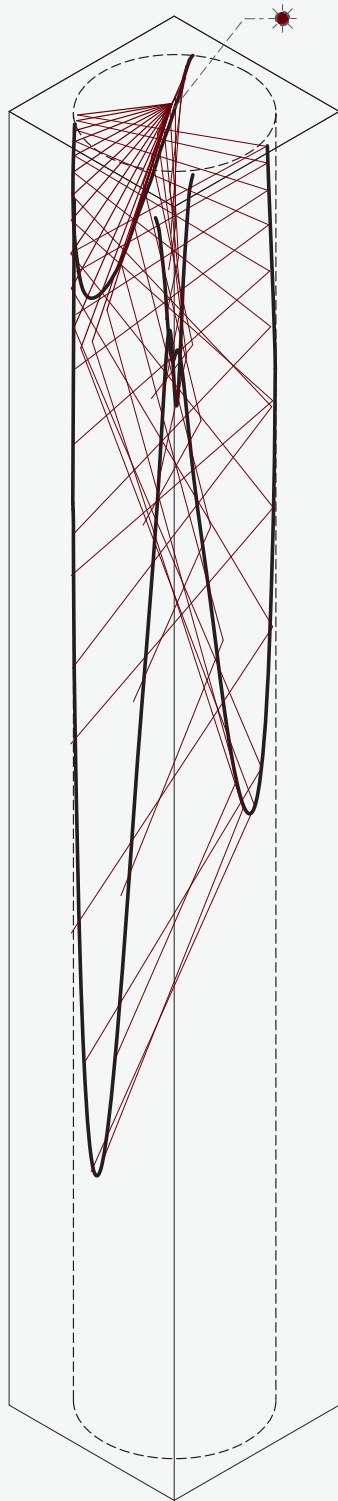


Fig. 42 Internal Reflections



Fig. 43 Optic Device - Curving Reflective Steel Ribbon



re-imagination of its conventional modes and functional requirements. Part of the fault in the experiment undoubtedly lies in its conception as an isolated occurrence that is driven solely by one aspect of light information. Early in the experiment, the conceptual mirror device (visible in Fig. 43) is removed from the system as a conveyor of light, and the veil forms subsequently lose their intended function as a diffusing mechanism. The produced form has no limiting variables beyond the manual elimination of self-intersecting solutions, and is consistently represented and fabricated as a stand-alone object. Given this approach, it stands to reason that then developing an architecture to surround such a purely derived form is difficult, as it contains zero embedded information regarding its role as a facilitator of daily life.

The experiment, purposefully privileging the impact of light on a recipient architecture, exposes the need for the optic system to defer to the intended use and atmosphere of a loosely designed space. By introducing this caveat, light begins to serve and inform rather than dictate the conditions of a project. Light's role as a driving concept of a project becomes secondary to its potential to express the project's greater narrative. This provokes a reconsideration of the influence of light information on the design and tectonic resolution of its recipient architecture. Phenomenological insight regarding the connection between light, information, and architecture is offered by both Peter Zumthor and James Carpenter in their writings on the topic. These two professionals work with light with the understanding that it is an agent that has arrived to built forms from a distance - they seek to clarify its presence as a kind of recorded history that begins at its source, the distant sun. James Carpenter's architectural works explore the capture and expression of ambient information and otherwise overlooked phenomena of light. He explains the motivation behind incorporating the environment in his work by saying, "When you find a way to break down the information contained by light, you reveal a much richer world, which is

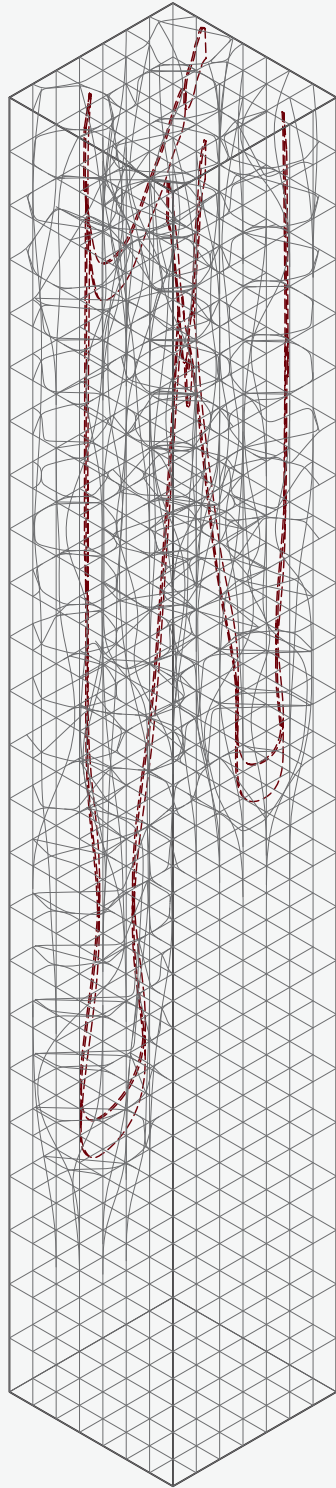
typically inaccessible to us."<sup>4</sup> Having explored the quandary of an isolated, large-scale abstract meeting of light and architecture in the veil experiment, the introduction of smaller, local optic devices emerges as a way to compartmentalise interactions of light and architecture into instances of unique functional, spatial, and atmospheric characteristics. With this change in approach, the architect can begin to question which facet of light effect will be most desirable within a specific context. Nevertheless, the world of light information that Carpenter references is quite ambiguous and can be dismissed as an elusive ambition during a design investigation. If the facets of light information and their respective interactions with architecture remain a mystery, the tectonic resolution of such a vague relationship will depend unnecessarily on the implementation of well-established optic devices (e.g. clerestories) or, conversely, rarely undertaken intensive light and material investigations.

Considering the prevalent conflation of designing with discrete information and designing with parametric tools, it is natural that quantitative studies have dominated light study. My thesis posits that parametric tools, specifically easily accessible graphical tools such as Grasshopper can and should be used to generate a new architectural body of optic devices. The question remains: what is the methodological and parametric framework that will allow us to engage with parametric tools such that they tune and guide rather than evaluate light effect? The thesis hopes to address this question by offering architects a reference that addresses architecturally-produced light effects, optic devices, and their relevant parameters. In his book, *Elements of Parametric Design*, Robert Woodbury lists and describes the six skills that are essential to working parametrically: "Conceiving data flow; dividing to conquer; naming; and thinking

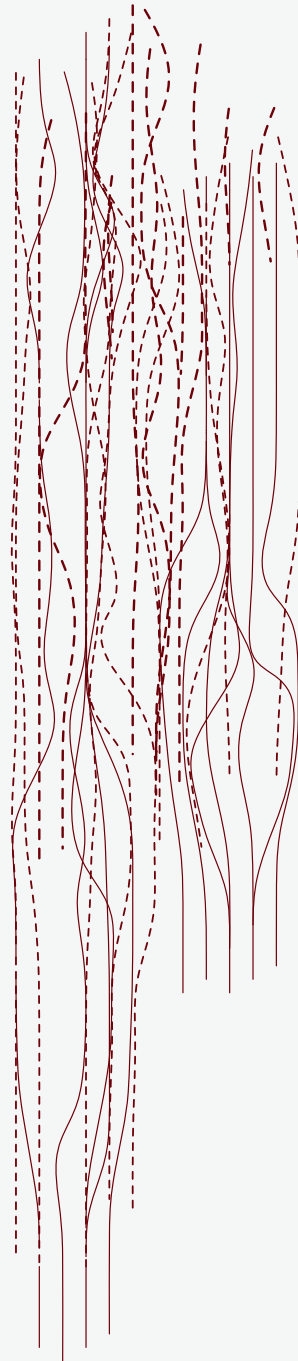
---

4 Sarah Whiting, ed., *Beyond Surface Appeal: Literalism, Sensibilities, and Constituencies in the Work of James Carpenter* (Cambridge: Harvard University Press, 2012), 19.





**Fig. 44** 3D Grid Spreading Definition



**Fig. 45** Select Distended (Vertical) Grid Curves

abstractly, mathematically and algorithmically”<sup>5</sup>. Some of these skills are readily applicable to the development of optic devices while others require further elaboration to become useful in the pursuit of designed light effect. A directly applicable skill is the organisation and management of data flow, which is instrumental to working with an algorithm editor. On the other hand, Woodbury notes that design specifically engages two essential elements of algorithmic thinking: procedure and precision.<sup>6</sup> Though precision can be easily achieved through practice, the involvement of procedural thinking in a design process can be challenging. As Woodbury states, “Designers largely describe objects rather than processes.”<sup>7</sup> Parametric systems that have graphical interfaces and preview changes in geometry in real time can alleviate this source of frustration as the designer works to design the process that informs the geometry. ‘Thinking mathematically’ and being able to apply the appropriate operations to achieve desired results with vectors, planes, and matrices is another area that designers can benefit from. The application of these skills in developing optic devices is generic in the sense that these are skills that should be developed regardless of the nature of the work being completed. To this end, there is a primer that has been released by Rajaa Issa of Robert McNeel and Associates (developer of Rhinoceros) titled *Essential Mathematics for Computational Design*.<sup>8</sup> This supplementary material has been developed using visual Grasshopper examples for designers that have little to no exposure to university or college-level mathematics. The document is exemplary of the translation of a field of information into an

overview that designers can use to progress their work.

Even with these pragmatic skills and supplementary documents, architects still require a larger construct within which to advance their understanding of optic devices. Per Woodbury’s enumerated six skills, an essential component of the development of this framework is naming. Woodbury’s illustrative example of the significance of a naming convention contrasts random letters and animal names like ‘skunk’ and ‘rat’ used to construct a very confusing data flow diagram with the conventional symbolism of the characters *w*, *h*, and *a* to represent width, height, and area respectively.<sup>9</sup> Architects lack this kind of consistent nomenclature in their description of light effect and optic devices, which can inhibit the development of a larger understanding of these aspects of architectural design. In his article “Morphogenetics and Emergence”,<sup>10</sup> published in the Architectural Design compilation *Computational Design Thinking*, Michael Weinstock briefly explains the significance of the “underlying relations that do not vary – the ‘homologies’”<sup>11</sup> in the study of morphogenesis. The usefulness of this biological model to the design process becomes apparent when one considers the parallel that exists between the relation of forms by morphogenetic tendencies<sup>12</sup> and the commonly accepted architectural practice of design iteration, in which the form and resolution of the overall design progressively evolve. Once a structure of the reference of light effects and optic devices is developed, it will fix in place the consistent elements (tectonic or otherwise) that play a role in the formation and reception of light effect.

A point of divergence between computational models of biology versus architecture

5 Robert Woodbury, *Elements of Parametric Design* (New York: Routledge, 2010), 35.

6 Woodbury, *Elements of Parametric Design*, 35.

7 Ibid.

8 Rajaa Issa, *Essential Mathematics for Computational Design 3<sup>rd</sup> Edition* (Robert McNeel and Associates, 2017) accessed July 5, 2017, <http://www.rhino3d.com/download/rhino/5.0/essentialmathematicsthirdedition/>.

9 Woodbury, *Elements of Parametric Design*, 29.

10 Michael Weinstock, “Morphogenetics and Emergence,” in *Computational Design Thinking*, ed. Achim Menges and Sean Ahlquist. (Chichester: Wiley, 2011).

11 Ibid., 160.

12 Ibid.



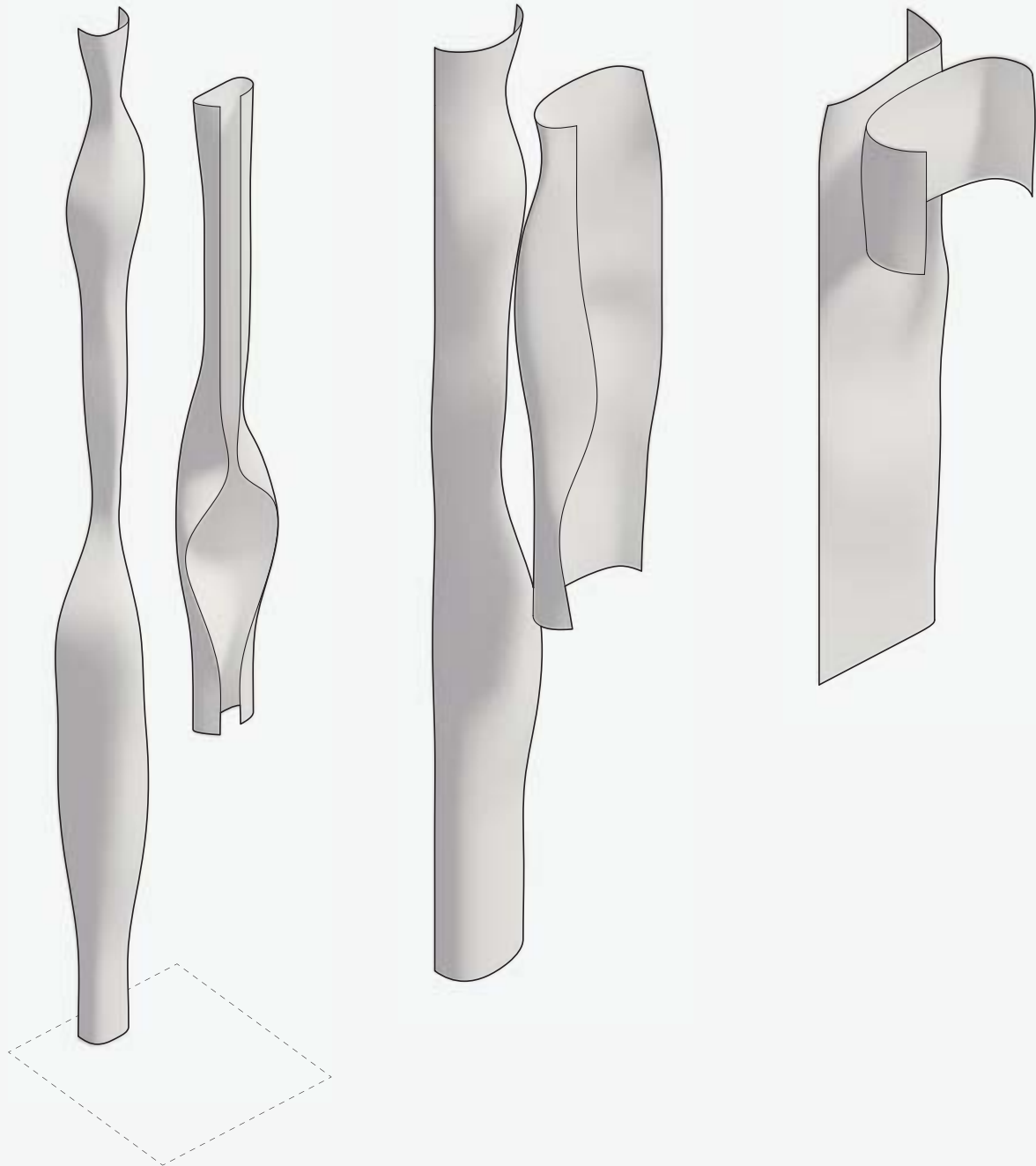


Fig. 46 Interpolation of Curves

are their levels of complexity. For this reason, Woodbury, writing for designers, includes ‘dividing to conquer’ as a common skill among those that design parametrically. He states “For very good reasons, designers organize their work as *near-hierarchies*, that is, recursive systems of parts with limited interactions between parts.”<sup>13</sup> The thesis proposes that parametric optic devices can be most effectively resolved on a room-by-room basis, with several simple parameters playing a role in the formation of the device. Though the dependency between parameters will necessarily be established by the architect, the *near-hierarchies* of the parametrically-controlled components of the optic device will allow for changes to be easily made to the sequence of operations before their effects are tested with a rendering engine. Perhaps one of the most significant skills that the reference will help architects with is the ability to think abstractly about the interaction of light and architecture. Woodbury introduces this concept, which is common in computer science, by explaining that the “utility of a computational idea is deeply linked to its generality”.<sup>14</sup> Furthermore, “To abstract a parametric model is to make it applicable in new situations, to make it depend only on essential inputs and to remove reference to and use of overly specific terms.”<sup>15</sup> The reference has been developed by collectivising information that can be found in three areas of light study: optics (the physics of light), architectural lighting design, and phenomenology. This information has been combined into a series of archetypes of light effect and demonstrably manipulable optic devices. Written and visual descriptions invite the architect to select or identify a desirable type of effect and apply it within a greater tectonic or conceptual scheme. The reference advocates for the enrichment of everyday architectural spaces. By consolidating multiple bases of knowledge on the subject and presenting it in an abstract process-oriented form, this thesis hopes

to promote the frequent integration of designed effects of light in architecture.

An architect’s personal intuition is often what drives aesthetic innovation in current architectural practice. Though the context of the work is often taken into consideration in projects that have been designed to immerse themselves within a certain realm of culture, landscape, or urban development, the inherent richness of ambient information is rarely captured, much less embedded within the architecture itself. In this model, the parametric tool complements the architect’s ability to design sensitively. It is difficult to apply terms such as integration, variety, and distinction to architecture without an accompanying framework of ideas, concepts, limiting variables, and functions of interaction to monitor their interconnectedness and dependencies. Their inclusion in architectural discourse is paramount to the development of engaging space. It is only with this supporting confluence of concepts in mind that the fine subtlety and phenomenal heterogeneity of light may be expressed with architecture. The following methodological reference aspires to address the absence of a consolidated and appropriately abstracted architectural body of knowledge regarding the most effervescent of agents.

13 Woodbury, *Elements of Parametric Design*, 27.

14 *Ibid.*, 30.

15 *Ibid.*



THE INTRINSIC AGENT

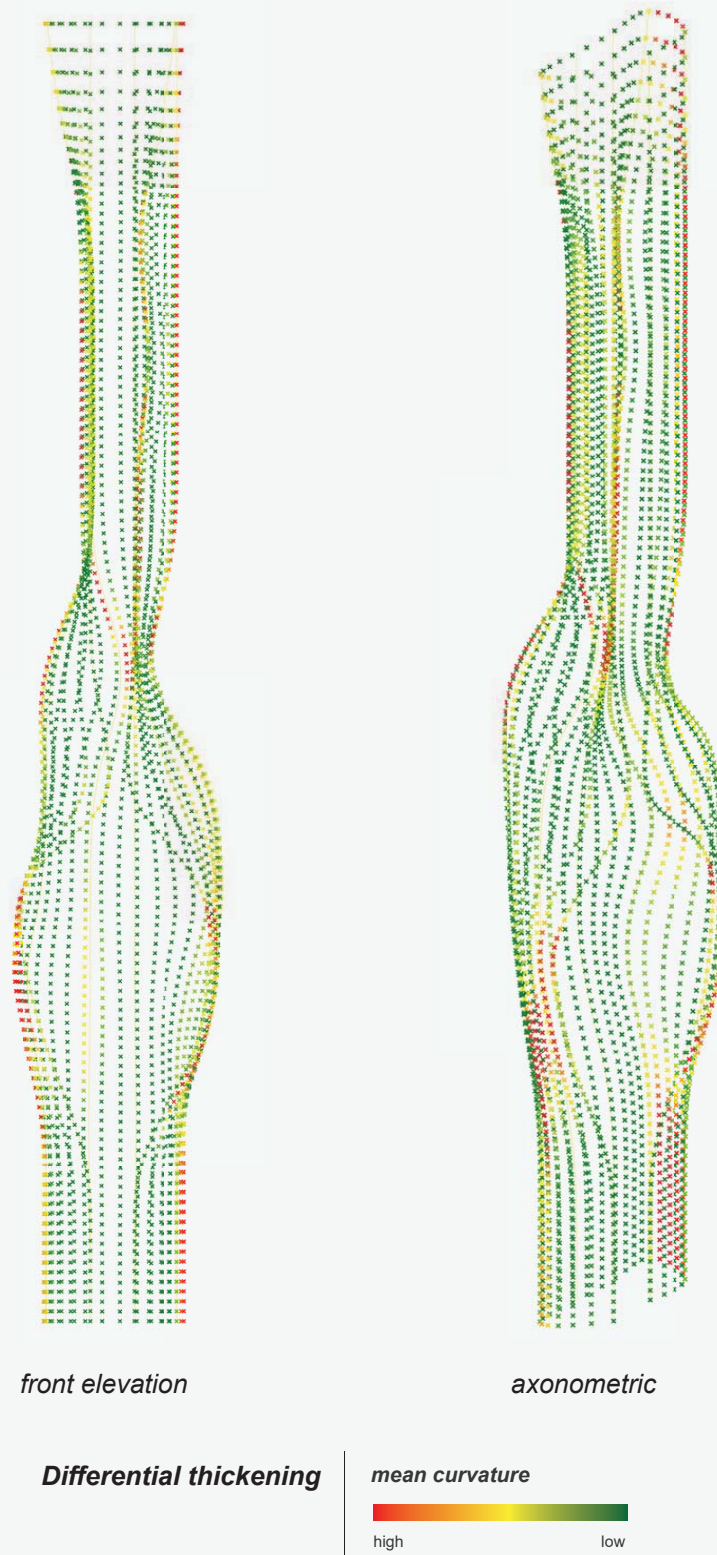


Fig. 47 Interpolation of Curves

TESTING PARAMETRICS

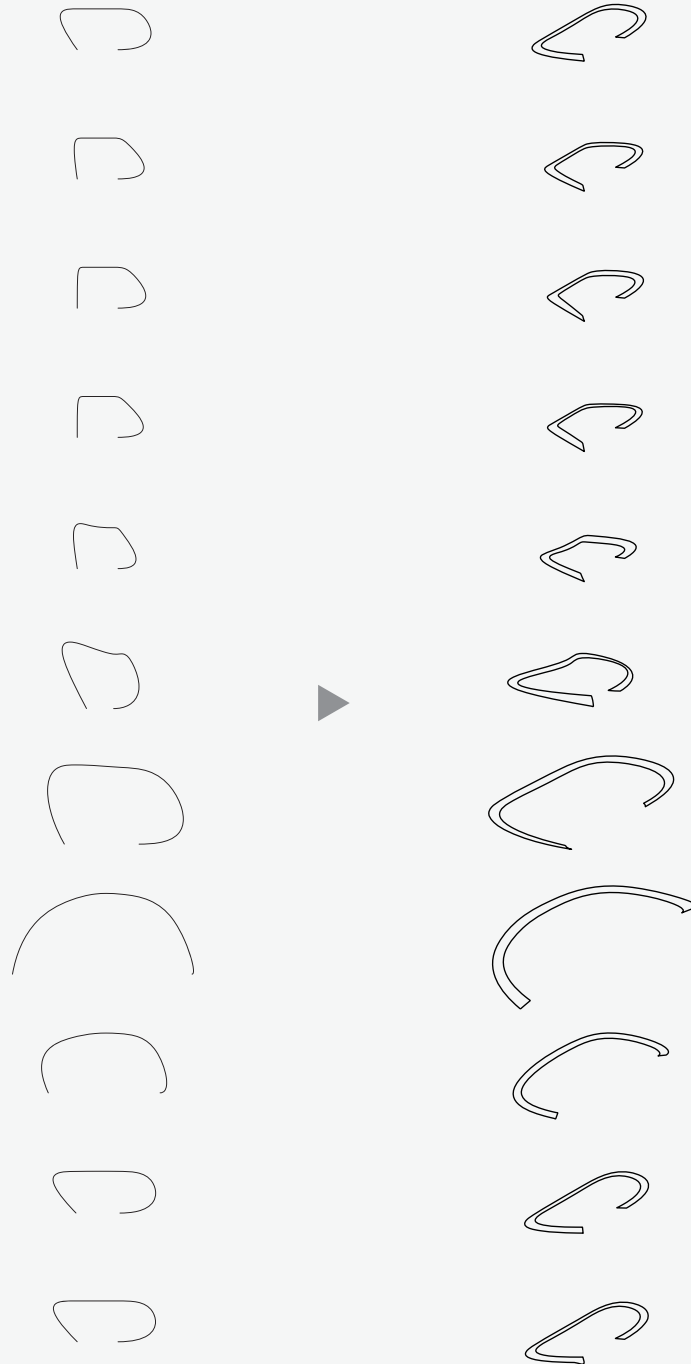


Fig. 48 Sections Showing the Differential Thickening of the Veil



THE INTRINSIC AGENT



**Fig. 49** Rendered Veil Form



TESTING PARAMETRICS



clear acrylic

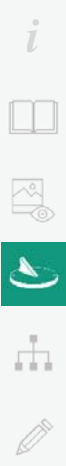


ABS plastic



white nylon plastic

**Fig. 50** Veil 3D Printed in Various Plastics



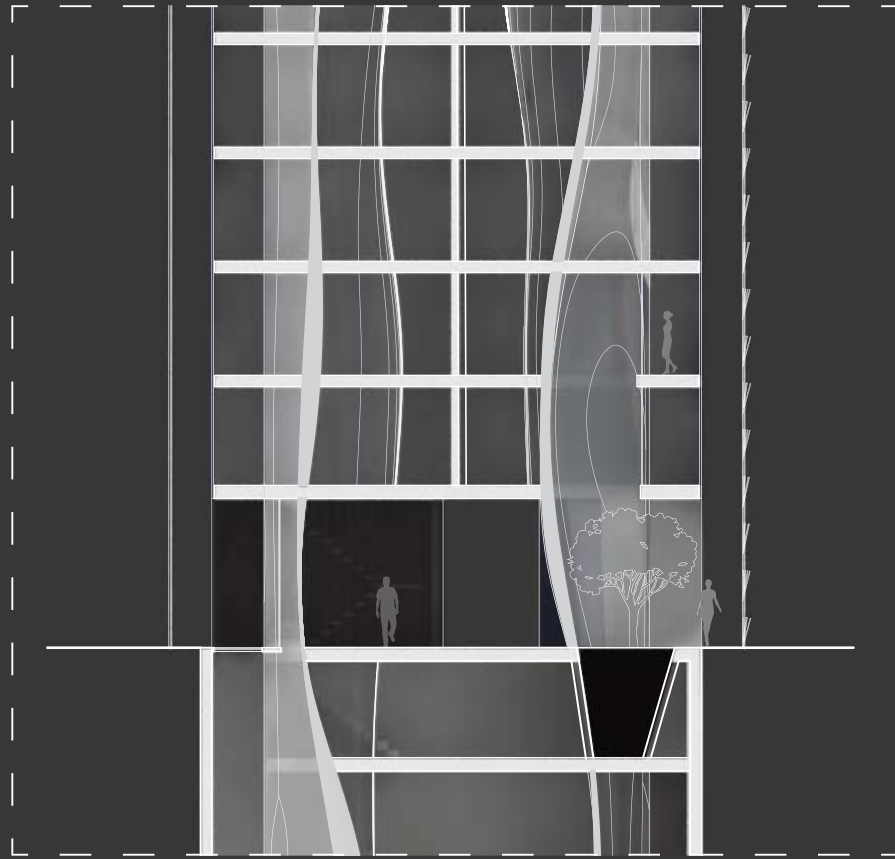


Fig. 51 Detail of Sections Featuring Developed Veils

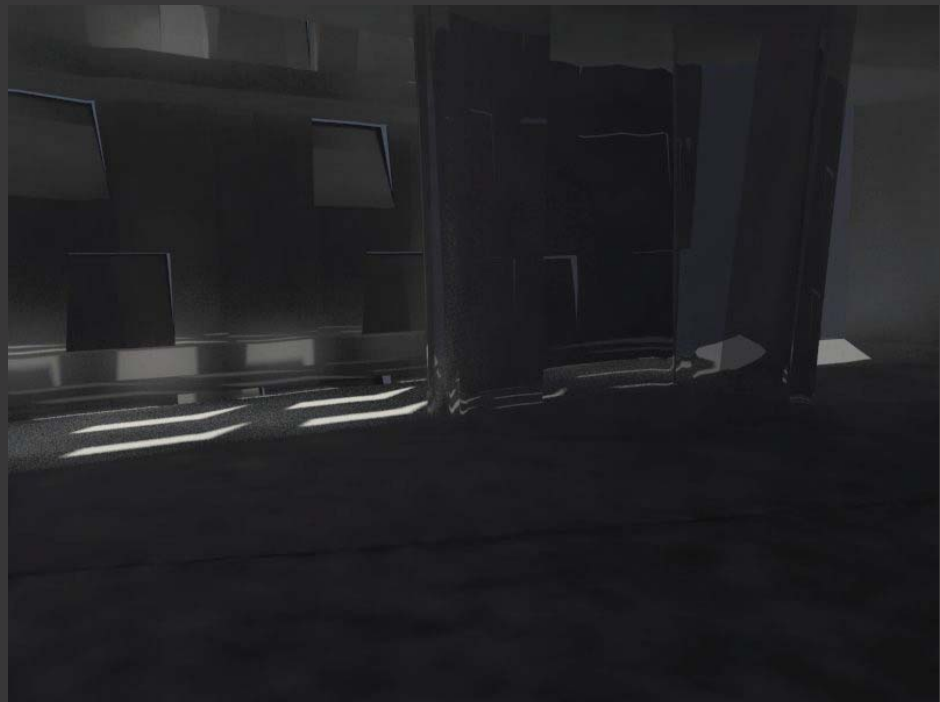


Fig. 52 Interior Rendering of Veil and Exterior Facade

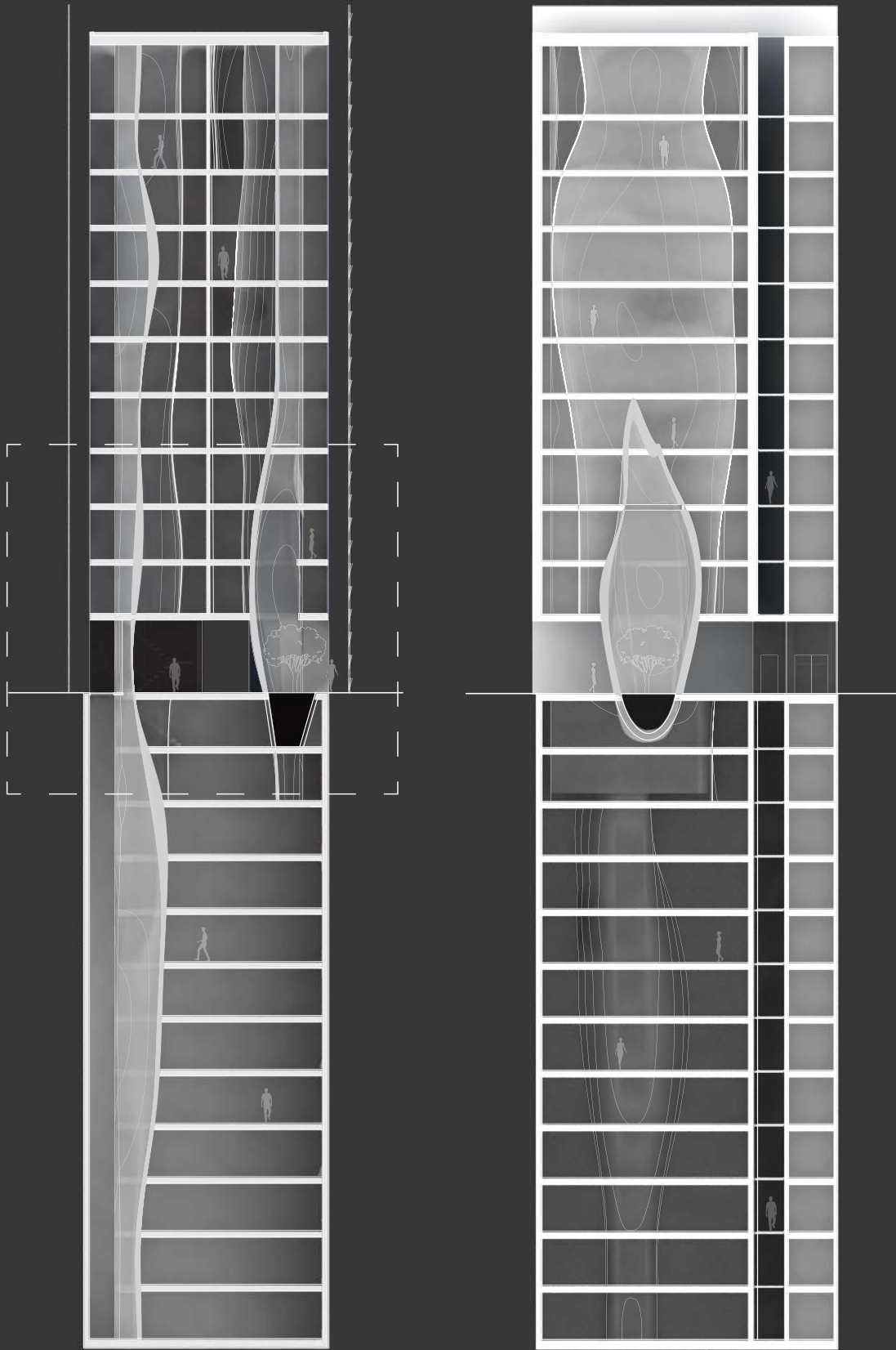
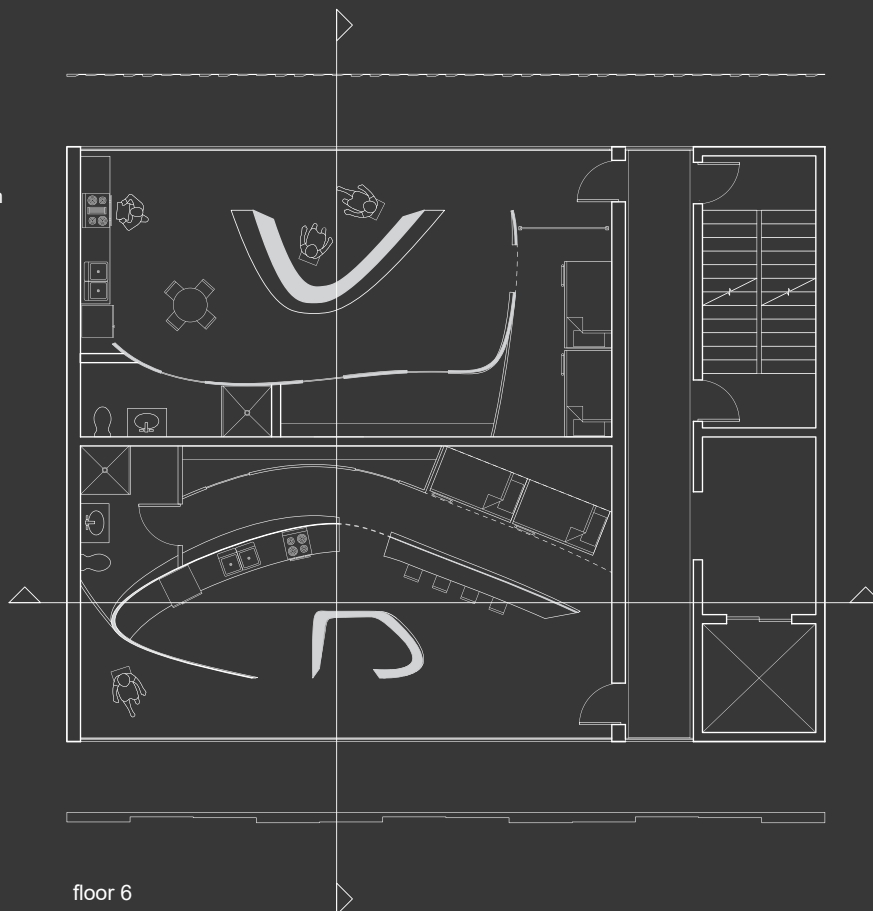


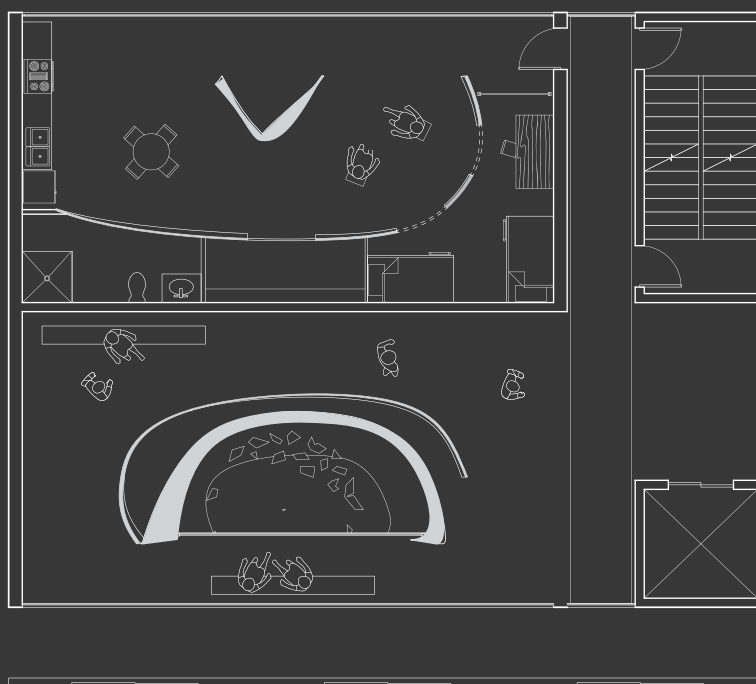
Fig. 53 Sections Featuring Developed Veils



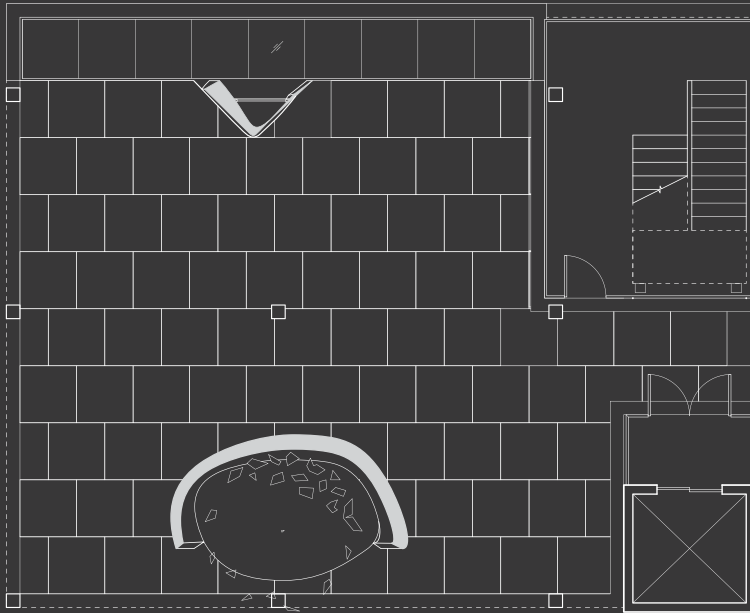
Fig. 54 Floor Plans of Experiment in Application



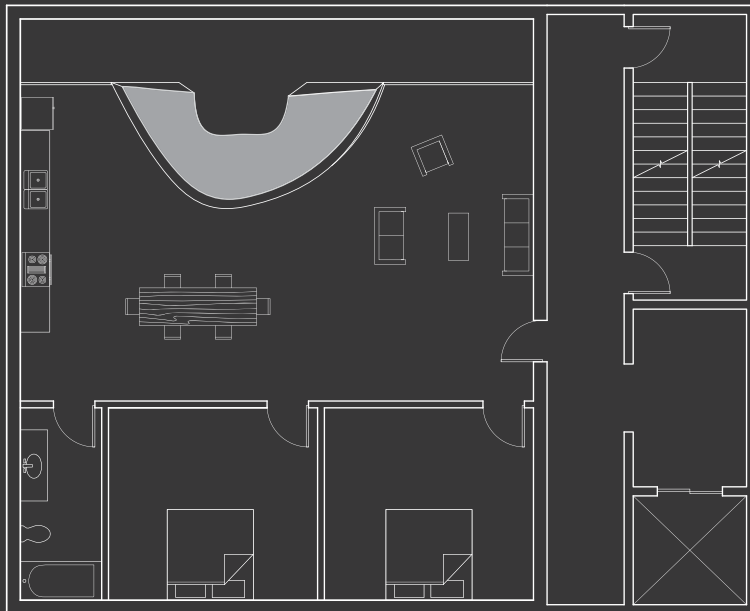
floor 6



grade



floor 2



floor b4





# PART III

---

A METHODOLOGICAL REFERENCE



**Fig. 55** Renzo Piano Building Workshop, *Pathé Foundation*



## introduction

### **DEVELOPING A REFERENCE**

---

This reference is a loose methodological guide with three elements that come together to produce tectonic solutions that use light to reinforce the tectonic strategies and conceptual drivers of a larger project. The three elements include the archetypes of light effect, [light] system strategy, and optic devices and their parameters. The archetypes of light effect are categorical descriptions of various manifestations of light effect. The archetypes cover a wide range of frequent and infrequent manifestations of light effect that can be used in pursuit of communicating larger conceptual or material project ideas. With respect to light effect, the archetypes are the architect's primary means of communication. In order to focus the development of tectonic solutions that will produce the desired archetypes and promote cohesion among the suite of optic devices, the architect is encouraged

to select or develop a system strategy. The system strategy identifies the common root or point of experimentation among the deployed optic devices. From this strategy, which can engage with a particular desirable quality of light (functional or otherwise), geometry, or material, the architect can then select optic devices that will produce the desired archetype and use the strategy as a point of evolution. The optic devices can then be tuned or experimented with using the parameters that have been depicted in their respective following sections. Figure 56 presents a diagrammatic summation of the relationship between these parts, from main project concept to tectonic resolution. This reference situates concepts, ideas, and illustrative examples in as generic terms as is possible in order to emphasize the adaptability of the proposed framework and methodology. For an in-depth case study and application of the methodology, refer to Part IV.

## using the reference

It is important to note that this reference is not intended as a replacement for less structured methods of discovering and deploying tectonics in pursuit of diverse light conditions and effects. It would be remiss to discount the ideas garnered through material exploration, physical models, and more complex but familiar applications of parametric tools. This reference collects and positions knowledge from various fields within a cohesive framework with the intention of providing architects with a tool that they can utilise in a way that best serves their existing modes and methods of working.

Despite its apparent methodological rigour, the various parts of the reference can be read or applied in isolation. When a student or architect finds that they do not know or understand how to

proceed in the development of a system strategy, particular optic device, or conceptual correlate, the reference can act as a guide and means by which to gain traction in the problem area. Knowledge that is disseminated among architects and students regarding the interaction of light with architecture can often be either too broad and conceptual or too detailed and technical. The reference offers knowledge about light that is directed toward its immediate implications in architectural work as well as a method by which to digitally test and tune possible outcomes. Note that although it is possible to transfer light over a distance or to channelize light using the introduced tools and methods, this reference does assume that an exterior source of light, be it natural or artificial, is directly available to the space.

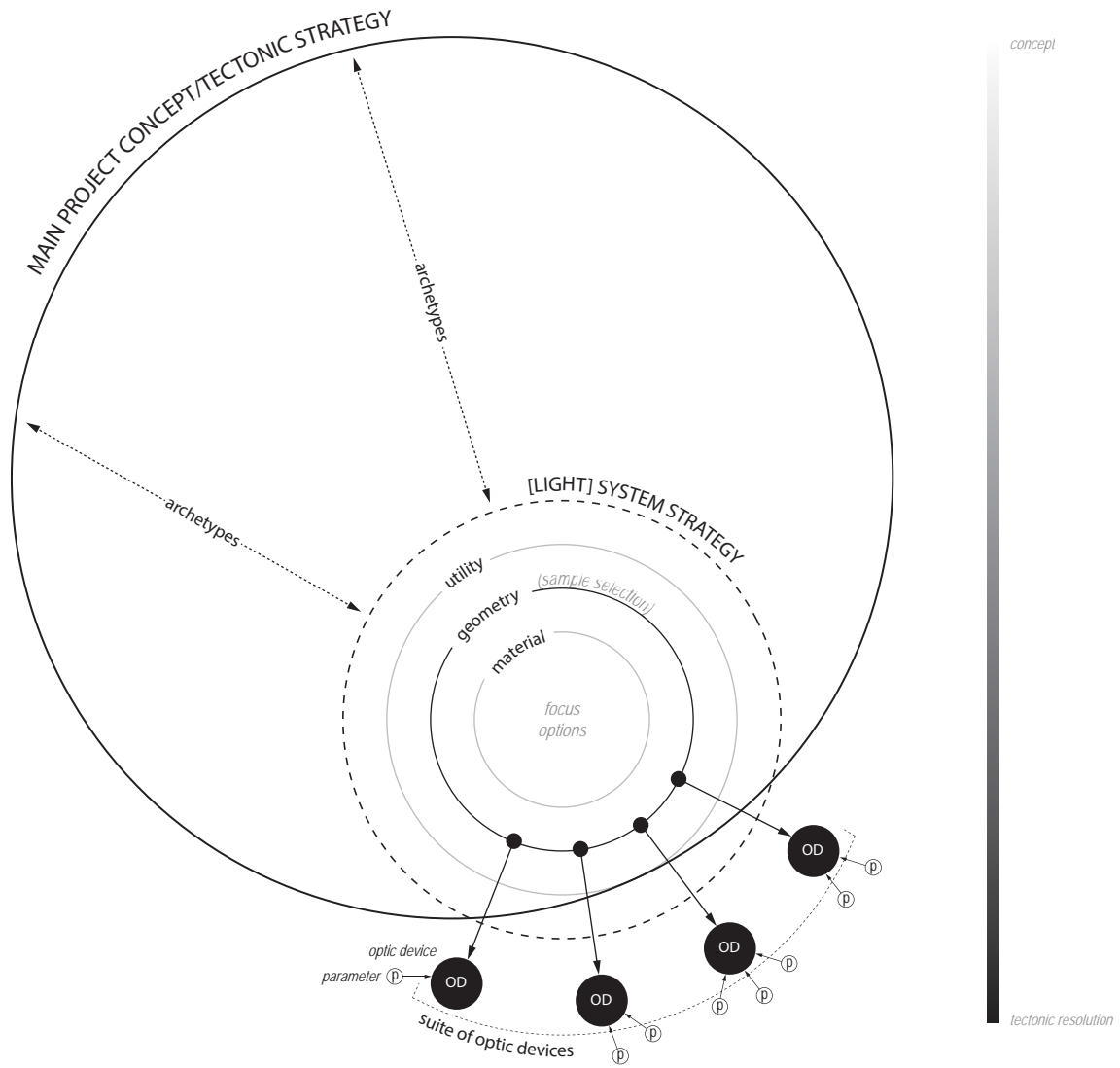


Fig. 56 Relation of Reference Components

<b>SOURCE</b>	<b>+</b>	<b>TECTONIC</b>
<b>AMBIENT LIGHT</b>		<b>PRIMARY INTERACTION</b>
<b>PRIMARY ARCHETYPE</b>		<b>OPTIC DEVICE 1</b> <i>(one or more primary optic devices occurring at a single site)</i>
THE NEUTRAL STATE and/or INCIDENT ARTIFICIAL LIGHT		<b>FRAMES</b> <i>(parameters to consider)</i> <ul style="list-style-type: none"><li>&gt; size</li><li>&gt; position</li><li>&gt; proportion</li><li>&gt; orientation</li><li>&gt; array</li></ul> <b>SCREENS</b> <ul style="list-style-type: none"><li>&gt; material</li><li>&gt; unit type/configuration</li><li>&gt; array</li><li>&gt; density</li><li>&gt; orientation</li></ul> <b>LENSES</b> <ul style="list-style-type: none"><li>&gt; position</li><li>&gt; reflectivity</li><li>&gt; transparency</li><li>&gt; geometry (curvature)</li></ul> <b>MIRRORS</b> <ul style="list-style-type: none"><li>&gt; number</li><li>&gt; adjacency</li><li>&gt; curvature</li><li>&gt; faceting</li><li>&gt; smoothness</li></ul> <b>DIFFUSERS</b> <ul style="list-style-type: none"><li>&gt; size</li><li>&gt; proportion</li><li>&gt; translucency</li><li>&gt; reflectivity</li><li>&gt; geometry</li><li>&gt; covering panel</li></ul>

Fig. 57 From Source to Effect

INTERVENTION	=	LIGHT EFFECT
<p>+      <b>SECONDARY INTERACTION</b> <i>(if applicable)</i></p>		<b>TUNED LIGHT</b>
<p>+                      <b>OPTIC DEVICE 2</b> <i>(secondary optic device)</i></p>		<b>SECONDARY ARCHETYPE</b> <i>(one or more produced)</i>
<p>RECEIVING SURFACE            &gt; <i>texture</i>            &gt; <i>geometry</i>            &gt; <i>transparency</i>            &gt; <i>reflectivity</i>            &gt; <i>colour</i>            &gt; <i>order of layering (if any)</i></p>		<p>THE SIMPLE IMAGE            CAUSTIC LIGHT            THE SPECULAR IMAGE            THE SECONDARY SOURCE            TEXTURAL LIGHT            DISPERSED LIGHT</p>
<p><i>(effect need not be registered by secondary optic device)</i></p>		
N/A		



## setting up the reference

The methodology is comprised of three main parts: the archetypes, system strategy, and optic devices and their parameters. Because the archetypes of light effect are the means through which the architect is able to reinforce the guiding concepts or major architectural moves of the project, knowledge from the fields of optics (physics of light), architectural lighting design, and phenomenology have been used to outline the physical nature of each type of effect, its applications in architecture, and the physical limits, if any exist, that will alter the effect beyond the range of the archetype. These written descriptions and examples of each archetype

can then be used by the architect to develop a system strategy that guides the selection of optic devices and key parameters. The architect brings the system strategy to the reference. The system strategy can be rooted in a particular material, geometry, use, or any combination of the three. It acts as a filter and guide in the selection and tuning of each device. Sequential illustrative examples of each optic device and its parameters showcase the impact of considering each device as an instrument that can be implemented and then examined and experimented with using visualisation tools.

## drawing the reference

In order to present the reference in generic terms that can be applied to other projects, the illustrations in this section demonstrate concepts and parameters in the simplest architectural terms. Instead of cluttering the illustrations with extraneous design elements, a room of cubic proportions and the same base materials was used to illustrate the archetypes and various forms of the optic devices. The materials were chosen for their prevalence in Vector Architects' *Seashore Library*, the case study that follows this section. These common elements provide a measure of continuity between these two sections. Although the effects of light will inevitably shift over the course of the day, the lighting in each drawing refers to the same point in time and place. This decision has been made in order to reinforce the changes in effect that can be brought about

by simple tectonic alterations. In the optic device series, a single tectonic parameter is changed in each step of the sequence in order to show the impact of that change. The base instance is a generic or conventional implementation of the optic device that is then visibly manipulated by simple sequential parametric operations. The order of application of the parameters is up to the architect. Please note that no parametric Grasshopper definitions were developed for the presentation of this reference as it would have been inefficient to create a definition for the purpose of showcasing a single instance of the parameter changing. The design project in Part IV illustrates a more in-depth application of the reference using a workflow involving Rhinoceros, Grasshopper (0.9.0076), and V-Ray (3.40.01) for Rhinoceros.

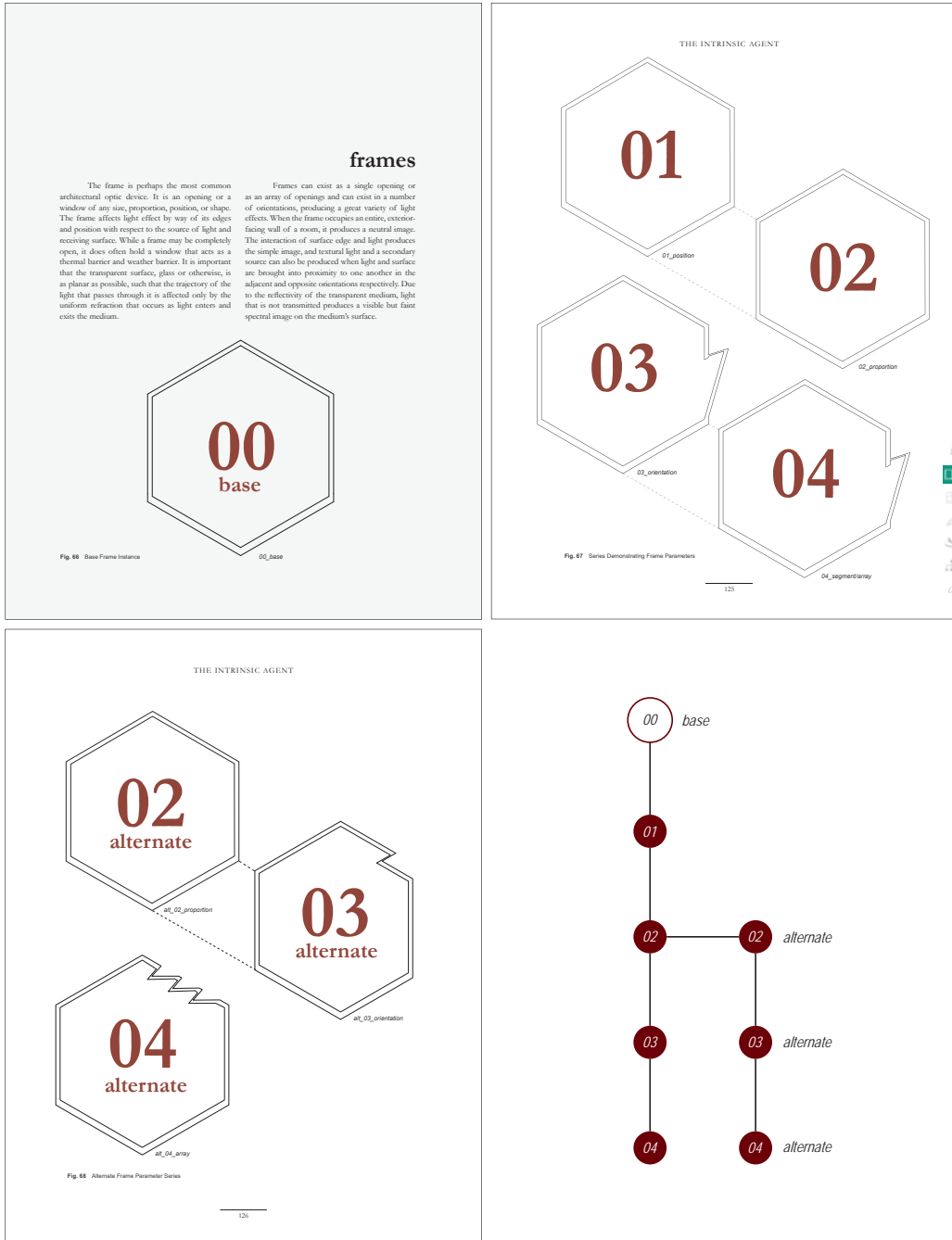


Fig. 58 Reading the Optic Device Series

# lighting

Two lighting tools have been used to illustrate the archetypes and optic device series. The first is a V-Ray (for Rhinoceros) Sun Light object, a directional light source whose direction and colour temperature can be set to correspond with the sun's real position given a time, location, and date. The time, location, and date of the sunlight object remains the same across all of the rendered images in this section. The object was set to simulate the sun's position at 12:00pm, on March 20th (Spring Equinox), in Toronto, Ontario. This V-Ray light and its accompanying settings are primarily responsible for the shadows that appear in the scene. Another lighting system, an environment-based system, was

used to simulate the effects of diffuse, coloured light from the sky. This HDRI, or High Dynamic Range Image, exists as a spherical map of skylight that surrounds the entire scene. Light scattered by clouds and Earth's atmosphere as well as the ground is included in the rendering of the final image, producing results that reflect the existence of these real-world conditions. Although the inclusion of these two elements remains consistent throughout this section, variables such as their intensity have been altered from one optic series to another to ensure that demonstrable changes in certain effects, such as caustics, are visible.



A METHODOLOGICAL REFERENCE



Fig. 59 High Dynamic Range Image

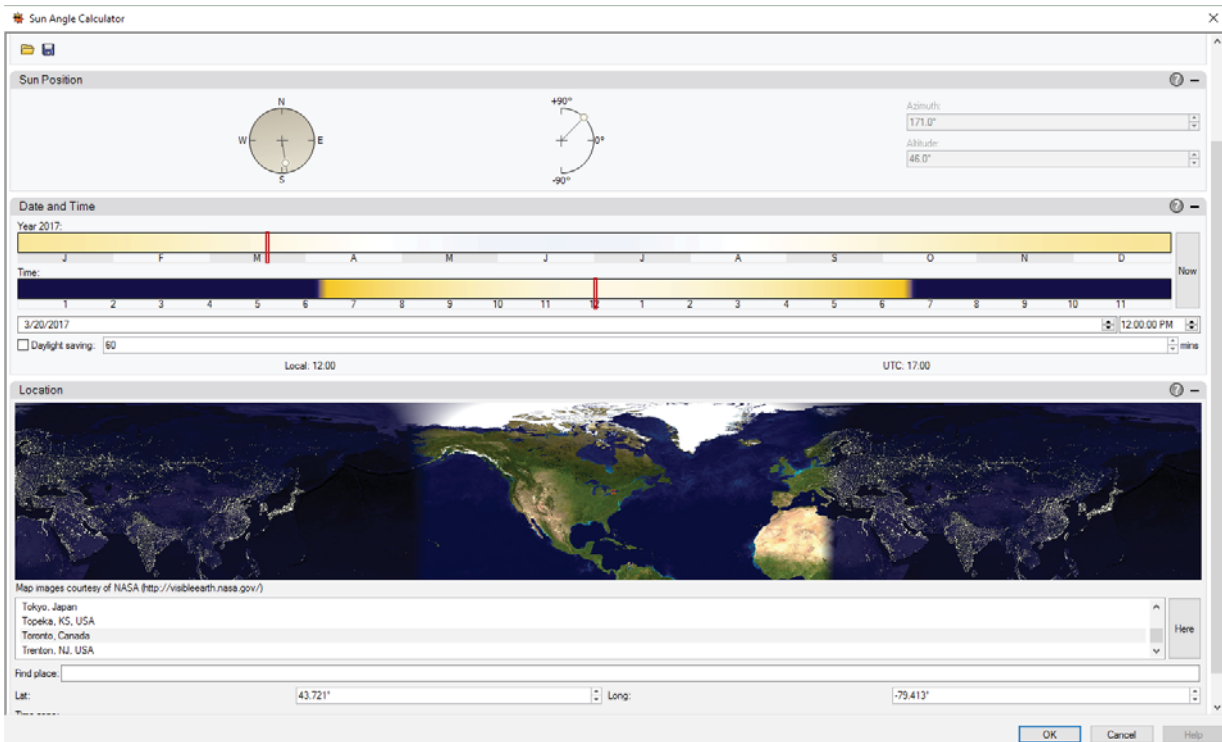


Fig. 60 Sun Angle Calculator Settings

## setting up materials

The materials used in the renderings in this section have been set up to address basic properties of the interaction of light and material. These materials address four main areas: the base image, reflectivity, index of refraction (IOR), and texture. The base image captures the range of colour and texture that is observable in a material under diffuse light. The diffuse nature of the lighting in this reference image is important - if the reference contains evidence of a strong, directional light source, the rendering may appear to contain inconsistent sources of light. The reflection parameters of the material affect its glossiness, the sharpness of the reflection, and the mapping of areas of the material that are more reflective than others. The index of refraction of the medium that is being modeled should be researched and applied to the material in the refractive settings in order to produce a better simulation of the

bending of light as it passes through the geometry. Refractive settings such as the translucency and fog can be used to adjust the characteristics of non-opaque materials. Lastly, textural detail can be added to materials by adding a bump, normal and/or displacement map to the base image under the maps setting. Bump and normal maps create the illusion of geometric detail, while a displacement map directly affects the surfaces of applicable geometry at the time of rendering. Textural detail that is achieved using this method emphasises the interaction between a surface and the source of light in the scene. Some of the following materials have been developed by myself using reference images, while others are stock materials created by the company behind V-Ray for Rhinoceros, Chaos Group.



Fig. 61 Material Samples

A METHODOLOGICAL REFERENCE





Fig. 62 Peter Zumthor, *Therme Vals*



## system strategy

The system strategy is the common ground from which the suite of optic devices for a particular project is born. Though significant, it is the least prescriptive component of the proposed methodology. The architect develops the system strategy by first considering the overarching concepts and tectonic moves of the project. Because this methodology is not intended to produce projects whose entire conceptual basis lies in an exploration of light effect, the system strategy must function as the working tool that the architect develops to focus their selection and tuning of optic devices.

The thesis posits that deliberate and nuanced effects of light can help architects to communicate various concepts and ideas. In order to develop a system strategy, the architect should consider which archetypes of effect will most effectively communicate the larger concepts or produce desired conditions. Then, the system strategy can be grounded in a certain material, geometry, utility, or any combination of the three options. The architect can easily select a category

of system strategy by considering the parameters that are integral to the production of the desired archetypes and then refine the scope of the strategy as desired or necessary. For example, if many layered specular images (archetype) are desired, the architect will require optically smooth surfaces (relevant parameter). Many materials will satisfy this requirement, including polished stone (opaque or translucent), glass (opaque to transparent), and some metals (various degrees of reflectivity). The architect can select a material based on the concepts or materials that are driving the project as a whole, and use it as a system strategy. The material then becomes the common element and point of experimentation in the deployed mirror devices (optic devices that produce specular images). The system strategy then acts as an intermediary between the architect and optic devices and their parameters. It alleviates confusion on the part of the architect and promotes cohesion within the suite of optic devices and seamless integration with the project.



Fig. 63 Sample of Archetype Illustration

## archetypes

The following visual and written descriptions of the archetypes of light manifestation are intended to categorically identify the various incidences of light information that we passively perceive on a daily basis. Some of these archetypes truncate information, some separate information, some concentrate information, and others duplicate information. These manifestations and intangible products are here viewed as different layers of information that undergo various optic processes

and appear as a projected image. The description of each archetype presents the parameters of each type of light effect, clarifies the role and agency of architecture in producing the effect, and finally considers the boundaries between and limits of the set of archetypes. Some fringe behaviours of light such as its behaviour as a wave and possible visible diffraction under specific conditions are viewed as existing beyond the scope of reasonable reproduction in an architectural context.

**THE NEUTRAL STATE**

**THE SIMPLE IMAGE**

**CAUSTIC LIGHT**

**THE SPECULAR IMAGE**

**THE SECONDARY SOURCE**

**TEXTURAL LIGHT**

**DISPERSED LIGHT**



Fig. 65 SANA A, Naoshima Ferry Terminal



Fig. 64 Example of a Neutral State



## the neutral state

The neutral state is considered to be the closest possible approximation of a baseline of interaction between light and architecture. Within the example of the rectangular room, the baseline represents the range of effect that occurs when one face of the room is a single, perfectly smooth, uncoated, and uninterrupted pane of glass.

Rather than describing a particular effect that occurs through the use of a mediating architectural device, the neutral image acknowledges the range of effect that occurs despite minimal architectural intervention. The notion of this inherent variability is evident in the writings of architects that address the role of light in their work. Natural light is presented as a body of information unto itself. In *Thinking Architecture*, Peter Zumthor recounts, "I want to think about the artificial light in my buildings, in our cities and in our landscapes, and I catch myself forever returning, like a lover, to the object of my admiration: the light that meets the earth from afar..."<sup>1</sup> This light is the product of a history of interaction. After being scattered differently by the gasses and water droplets of clouds in our atmosphere, light arrives to the surface of the earth and is transformed by our natural and

built environments before it reaches the site of the architectural opening. The range of operation that occurs within the immediate context of the project is augmented by seasonal changes and day to day atmospheric weathers. Similar shifts in our personal predispositions toward the perception of and attentiveness to effects of light affect the range of effect that we observe in the neutral state. Certain archetypes attract our attention more than others because of their rare forms of manifestation. The neutral state is often only the object of our attention in those moments when it threatens to disrupt our ability to attend to a task.

By acknowledging this inherent range of incident light that arrives to our architecture, one can acknowledge that the light of a single moment has certain properties, biases, and limits. It may change over the course of a minute, an hour, or a season, but natural light is never truly stagnant. Its interaction with designed devices is similarly transient. Some devices may perform consistently while others require specific circumstances in order to manifest an effect that exists beyond the neutral range.

<sup>1</sup> Peter Zumthor, *Thinking Architecture*, 3rd ed. (Basel: Birkhauser, 2010), 89.





Fig. 67 Atelier Jean Nouvel, Arab World Institute



Fig. 66 Example of Simple Image

## the simple image

The simplest of all images formed in geometrical optics is the shadow, which occurs “when an opaque object in the path of a light source prevents the light source from traveling through to the surface behind the object.”<sup>1</sup> This description may seem simplistic, but it establishes the key relationships that exist between architecture, light, and object. It is quite common to see studies done in environmental plugins such as Ladybug for Grasshopper that depict light in terms of absolute light and absolute shadow (*umbra*). Though architects are commonly interested in the white, daylight portions of these studies, this archetype encourages architects to instead consider the movement of the shadow image over the course of time and to expand its rigid, black outlines to include the consideration of the softer, layered penumbras that are an integral part of our observation of objects in space.

The role of architecture in forming the shadow primarily lies in framing natural light as it enters a space and interacts with the objects within it. It acts as a filter through which the single, distant, and highly directional light of the sun can be instantaneously operated upon and controls the number, size, and proportion of the sources of natural light that illuminate the interior. Though the directionality of the light is dependent upon the

time of year and amount of light scattering<sup>2</sup> that has already occurred due to weather, the points from which light enters a room can have a significant impact upon the appearance of the shadow image. In a way, the shadow inscribes the presence of the architecture on its own interior skin, and never fails to record the passage of time until artificial light sources control the image instead.

All obstacles, furniture, louver, or screen, are subject to produce shadows of variable size and definition. Architecture determines, to a certain degree, what the nature of the produced image will be. For example, based on the sources of light produced by the architecture, the image can be fragmented, smoothly gradated, or nonexistent. These conditions can be altered by increasing the number of small sources, changing the proportion of the light source, or changing the distance between the source, object, and nearest surface. In the event that a screen is placed directly in front of the source, the image of that entity will appear to be projected onto the objects of the room – depending on the directionality of the source, its image may be preserved or, on a diffuse day, it may only affect those surfaces that it is closest to. The shadow is useful in exposing to us the agency of architecture in framing the light of the sun.

1 Galen Duree Jr., *Optics for Dummies* (Indianapolis: Wiley, 2011), 60. Galen Duree is a professor of physics and Optical Engineering Director at the Centre for Applied Optics Studies Rose-Hulman Institute of Technology.

2 *Ibid.*, 48.



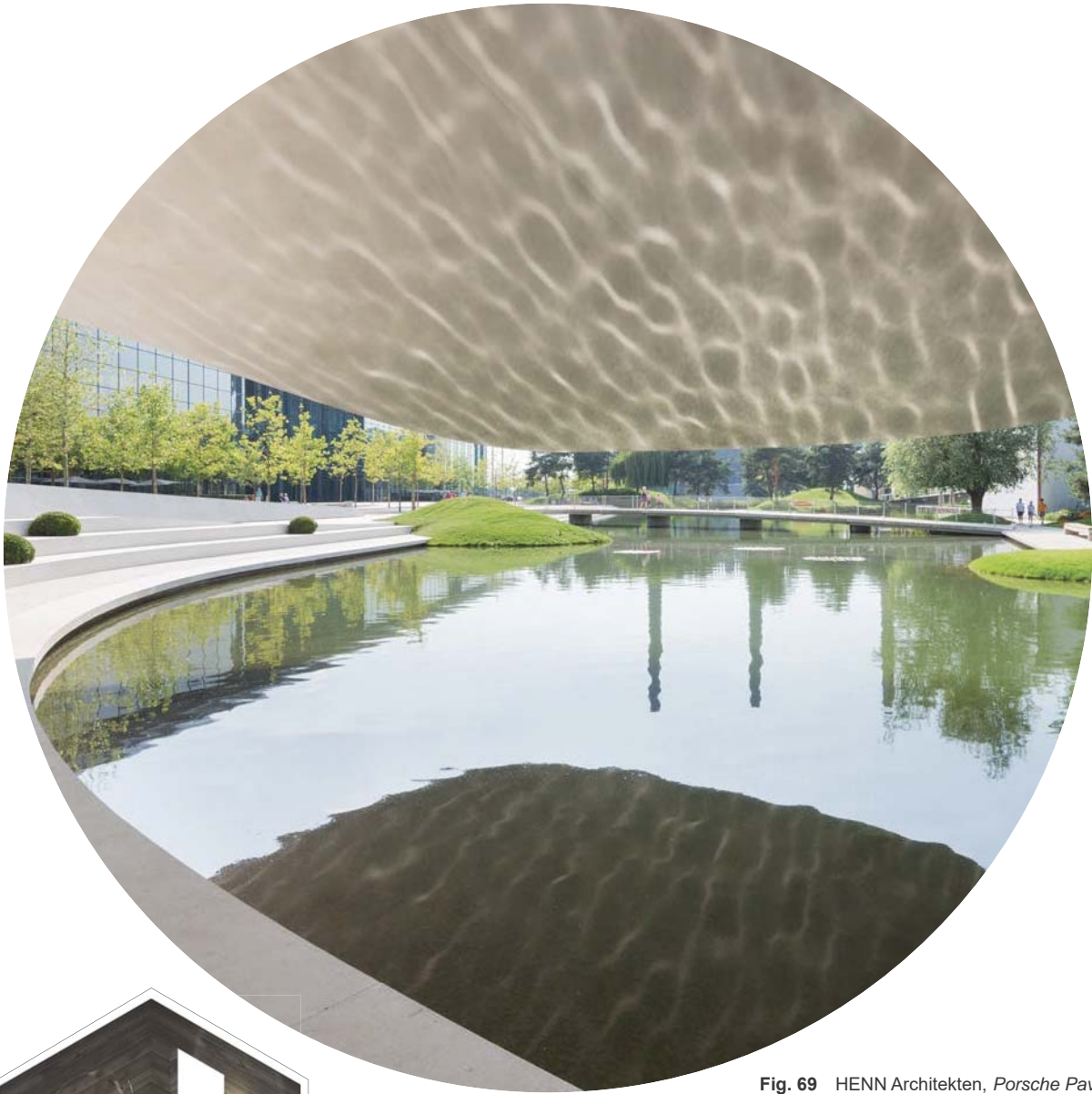


Fig. 69 HENN Architekten, *Porsche Pavilion*



Fig. 68 Example of Caustic Light

# caustic light

Caustics are formed by light rays that are reflected or refracted by a curved surface or lens. The phenomenon, often visible when light passes through a glass or at the bottom of a pool, exists because of the interaction of uniformly directional light with the fluidly curved surface. In David K. Lynch and William Livingston's book *Color and Light in Nature*, the surface of water is described as a series of positive and negative lenses. The positive, convex lenses act to concentrated light while the negative, concave lenses direct light away from the interstitial areas, producing a vibrant network of concentrated curves of light.<sup>1</sup>

Architecture typically plays a passive role with respect to this archetype of light effect. Incidences of caustic effects are often happenstance, and can be dismissed or heralded as serendipitous coincidence. However, it is difficult to deny the curiosity and wonder that is evoked in the viewer when concentrations of light appear in the umbra of the shadow image despite our contradictory common understanding of shadows as being indicative of an absence of or an obstruction of light. The caustic therefore appears as a true secondary layer of information.

Unless viewed in extremely bright ambient conditions, the caustic will always appear to the

viewer as superseding the brightness of proximate light effects. The etymology of the word *caustic* lies in the Greek words *kaiein*, 'to burn', and *kaustos*, 'combustible'. Though caustics require some computational power to replicate, it is possible to digitally reproduce and manipulate their most common forms. This changes the role of architecture from passive recipient to possible instrument with which to tune these fine structures of light.

Though forms can be generated that produce intricate patterns and lines of light, caustic propagation can be resolved in great detail. Research conducted by the Computer Graphics and Geometry Laboratory at the École Polytechnique Fédérale de Lausanne shows that any desired photographic digital image can be reproduced in caustic form when a transparent or highly reflective material is milled with the geometry that computationally corresponds with the image's light and dark areas. Upon exposure to a direct light source, the image is revealed.<sup>2</sup> This research, though as of yet tentative in its proposed application, marks the first foray of architecture into the realm of active engagement with caustic phenomena.

---

1 David K. Lynch and William Livingston, *Color and Light in Nature* (Cambridge: Cambridge University Press, 2004) 93-94.

---

2 Thomas Kiser et al., "Architectural Caustics - Controlling Light with Geometry," EPFL Computer Graphics and Geometry Laboratory, accessed April 4, 2017, [http://lgg.epfl.ch/publications/2012/caustics/ArchitecturalCaustics\\_AAAG.pdf](http://lgg.epfl.ch/publications/2012/caustics/ArchitecturalCaustics_AAAG.pdf).





Fig. 71 Mira Arquitectos, *National Cities Confederation*

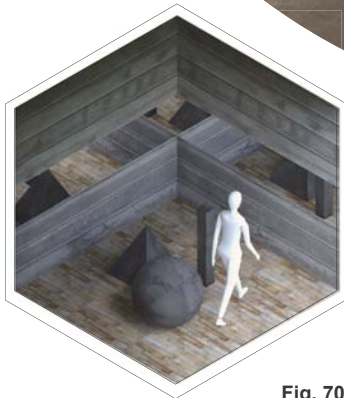


Fig. 70 Example of the Specular Image

# the specular image

The specular image is formed when light information is redirected from its incidental direction to the occupant. There is an intrinsic relationship between the image and surface that holds the optically virtual image. The fragility of the image is matched only by the necessary order of the smoothness of the receiving surface. In order to offer the image to the viewer as if it were its own, the surface must be optically smooth, and is so only "if any surface feature height... is much smaller than the wavelength of the incident light."<sup>1</sup> The preservation of the image is possible only because the directionality of all incident rays relative to one another is preserved.

Architecture must very carefully consider the incidental outcomes of introducing mirror surfaces in space. In "The Poetics of Light," Henry Plummer cautions against mirrors: "The plane mirror is always susceptible to squandering its incident light and, by complete reflection, annihilating its very existence."<sup>2</sup> Not only does the image have the power to supersede the surface, but the precise directionality of the reflected rays will

often render the intended image only perceptible to the viewer from a certain position. In a sense, the mirror will fulfill its intended role only through the specific, successful choreography of the orientation of both the architecture and the body. The mirror also has the ability to fragment and distort. When two different choreographies of surface orientation are placed next to one another, the virtual image disrupts the real image. Plummer addresses this strange phenomenon in his analysis of the mirror 'windows' of Amalienburg: "...each slippery sheet is actually a terrain of cold silver, shimmering and shadowy, possessing radiant images that are somewhat warped, broken up, and disarranged".<sup>3</sup> His evocation of the mirror as a terrain of cold silver is not without value - the life of the mirror outside its designed viewing is integral to the atmosphere of the space.

The limitation of the specular image lies in its flattening of information and fleeting existence. The precision of the archetype is wholly determined by the quality of its host surface. As the optical smoothness of the surface deteriorates, so does the quality of the image, until the image is indiscernible and another archetype is born.

---

1 Duree, *Optics*, 46.

2 Henry Plummer, "Poetics of Light," A+U December Extra Edition (December 1987): 25.

---

3 Plummer, "Poetics of Light," 25.





Fig. 73 Louis Kahn, *Kimbell Art Museum*



Fig. 72 Example of a Secondary Source of Light



# the secondary source

When the surface feature height of the surface is larger than the wavelength of incident light, the incident rays are reflected at various angles because they no longer share the same surface normal.<sup>1</sup> Any image carried by the incident light rays is destroyed as it interacts with the heterogeneously textured surface and is fragmented into many directions. The use of a surface as a secondary source of light is part and parcel of Hervé Descottes' "Six Visual Principles of Light".<sup>2</sup> He aptly describes the power of this archetype through an example: "Consider the moon: it does not emit light on its own, but the sun's light reflected off the moon's surface creates what we recognize as moonlight."<sup>3</sup> In *Architectural Lighting Design*, Descottes establishes that the process by which an object returns the light that it has received from a source of light to the eye of the viewer is quantitatively measured as luminance.<sup>4</sup> He claims a sense of hierarchy can be developed within a space when surfaces of varying luminance levels are placed in proximity with one

another.<sup>5</sup>

Architecture mediates the production of this archetype at two places. The source of light must be framed and placed into a dialogue with a receiving surface before that surface can act as a secondary source of light. The architecture can express or conceal this relationship and can choose to display the secondary surface as a diffuser or conceal it and instead present it as a site of registration. The relative intensity of the light that is directed to the eye of the viewer can produce effects of both sharp and subtle layering of both surface and object.

It is interesting to note that the secondary surface can be used to itself perpetuate the production of silhouettes, one form of the simple image, within a space. A concealed source that washes a wall with light can reduce the appearance of a three-dimensional object to a crisp, dark outline of its potentially rich form. The secondary surface can thus be revealed as one of the most active and illusory of the seven archetypes. The range of luminance is so great as to include that amount of light information which imposes a kind of violence on our senses as well as a total absence of light information which reduces an object to an edge.

---

1 Duree, *Optics*, 48.

2 Hervé Descottes and Cecilia E. Ramos, *Architectural Lighting: Designing with Light and Space* (New York: Princeton Architectural Press, 2011).

3 Descottes, *Architectural Lighting Design*, 31.

4 *Ibid.*, 30.

---

5 *Ibid.*, 34.





Fig. 75 Peter Zumthor, *Bruder Klaus Field Chapel*



Fig. 74 Example of Textural Light

# textural light

The transition from the archetypal effect of the uniformly luminous secondary surface to the more variegated textural light is once again due to an increase in the order of surface feature height of the receiving surface. When the surface features, surface geometry, or surface quality or patina are such that parts of the surface will collect or hold light while other areas are recessed or lost in shadow, textural light is at play. Even minute details can be revealed by a source that pushes light across an architectural surface.

Architecture can inform the intensity and directionality of incident light in order to express the materials and methods of its construction. Textural light most commonly exists when a source is narrowly framed and deployed along the edge of the surface plane with few or limited sources of light illuminating other areas of the room. Few additional sources are needed as this archetype of light often acts as a fractured secondary source, providing sufficient illumination for those tasks that do not require precise illumination. In *The Eyes of the Skin*, Juhani Pallasmaa describes materials that lend themselves to textural effects of light: "Natural materials - stone, brick and wood - allow our vision to penetrate their surfaces and enable us to become convinced of the veracity of matter."<sup>1</sup> In some ways, the depth that is apparent when light interacts with

1 Juhani Pallasmaa, *The Eyes of the Skin: Architecture and the Senses* (Chichester: Wiley-Academy, 2005), 31.

these materials is the opposite of "the architectural mirror, that returns our gaze and doubles the world, [and] is an enigmatic and frightening device."<sup>2</sup> Details in construction that capture the human endeavour of building are equally important in the realization of this archetype. In Peter Zumthor's renowned *Therme Vals* project, on-site masons were first disappointed when the slit-like apertures that bathe adjacent interior stone surfaces in light were opened. "The shafts of light washed the walls of their finished work causing tiny irregularities in the stone bond to cast dramatic shadows. But watching optical illusion, which at first seemed to suggest a job poorly done, soon turned into pure delight."<sup>3</sup> The power of this archetype often lies in the subconscious history that is imparted to the viewer as they observe the phenomenon, be it a history of labour or fabrication.

Textural light is a friend of the shadow - it is through a balance of light and shadow that it exists, and it can continue to exist when this relationship skewed toward shadow until just the barest hint of direct or filtered light is registered by the non-uniform surface. Textural light engages both our visual and visceral senses of experience.

2 Ibid.

3 Sigrid Hauser and Peter Zumthor, *Peter Zumthor Therme Vals* (Zurich: Scheidegger & Spiess, 2007), 113.



THE INTRINSIC AGENT



Fig. 77 James Carpenter, *Dichroic Light Field*



Fig. 76 Example of Dispersed Light

# dispersed light

The archetype of dispersed light occurs when the wavelengths or colours of light that combine to produce sunlight are visibly separated, isolated, or selected. These effects can occur due to a variety of optic phenomena, but can most commonly be observed by way of dispersion, when the effects of minor variances among the indices of refraction for shorter wavelengths (such as blue light) and longer wavelengths of light (such as red light) are exacerbated. Because the indices of refraction increase or decrease alongside an increase or decrease in the wavelength of incident light, the paths of various wavelengths are bent to a greater or lesser degree as they pass through different media (per Snell's law).<sup>1</sup> This effect is significant in the engineering of optical instruments whose operation depends upon refraction,<sup>2</sup> but is often only visible in architectural settings when the geometry of the medium (generally glass) that light passes through exaggerates the effect. When one uses a triangular prism to disperse light, the effect is observable because different wavelengths of light will continue to travel in different directions upon exiting the prism. In the case of a prism with parallel sides, the various wavelengths of light will be inversely dispersed at the second surface and will therefore continue on in the same direction with little evidence of any separation of wavelengths.

---

1 Duree, *Optics*, 50.

2 Ibid., 54.

Architecture can facilitate the production of this archetype through the geometry of glass and glass-like materials. The effect commonly occurs when the edges of glass architectural artifacts are beveled, creating prisms. If the prism is stretched, the effect will diminish as the two planes become increasingly parallel. The archetype therefore has the greatest potential for impact through small or arrayed instances. This limitation can be circumvented through the use of dichroic filters. These materials are typically polymers that absorb much more light in one linear polarised state than the other perpendicularly oriented state. As Duree describes, this "process of selective absorption is very much dependent on the wavelength of the light."<sup>3</sup> James Carpenter uses dichroic films in his 1995 facade project, *Dichroic Light Field*. The dichroic film on each of the two hundred and sixteen fins that project from the mirror-like screen transmits one half of the visible light spectrum while the other half is reflected.<sup>4</sup> This polarisation of light provides the means by which to achieve a variation of the archetype, and deploys it in combination with the specular image archetype to register ambient lighting conditions while simultaneously operating on incident light.

---

3 Ibid., 109.

4 Sandro Marpillero, *James Carpenter Environmental Refractions* (Basel: Birkhäuser, 2006), 41.



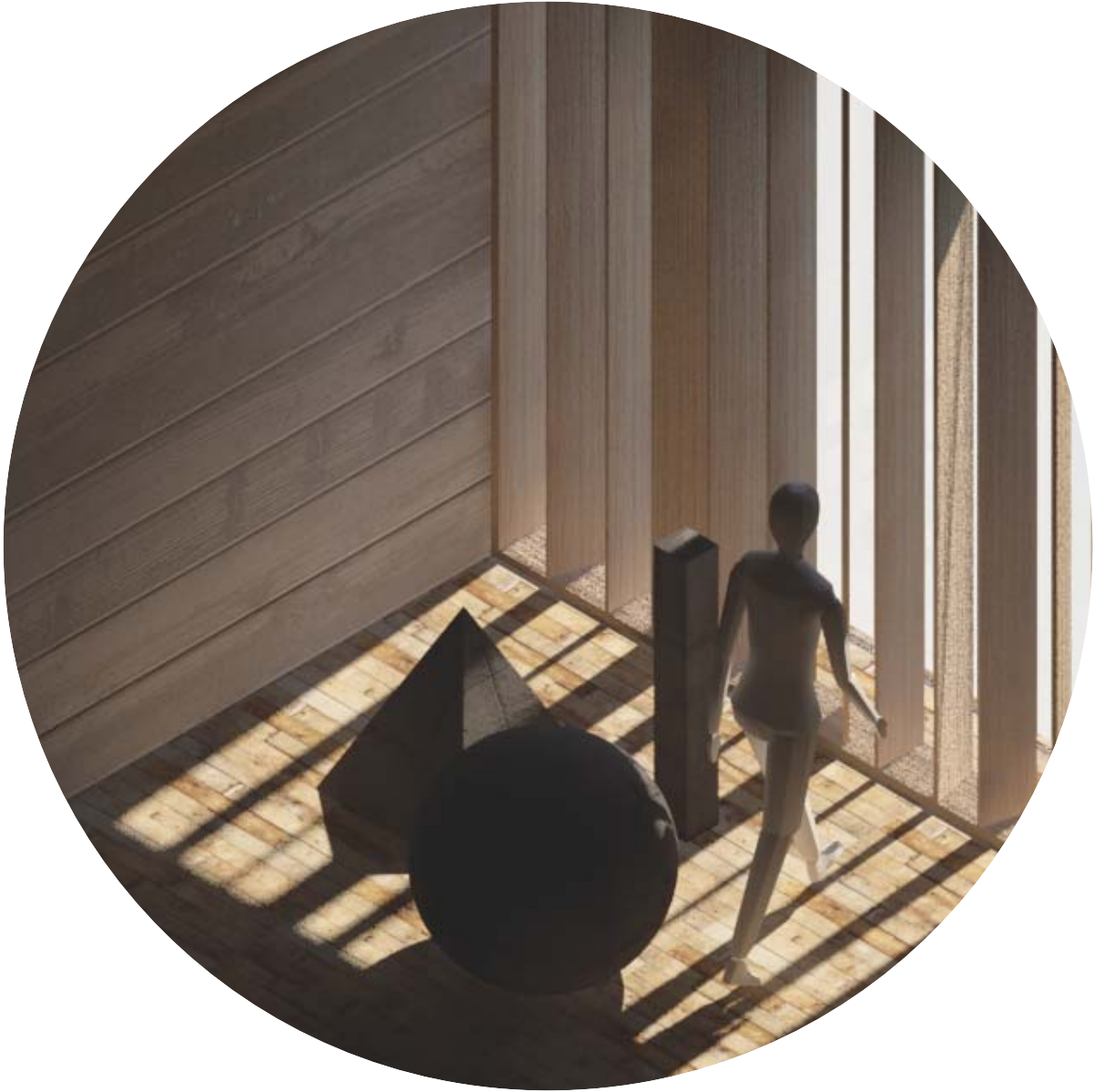


Fig. 78 Sample of Optic Device Illustration



## optic devices

Five primary and one secondary optic tools are proposed as the primary avenues through which an architect may attempt to produce light effect. Though a desired effect may involve multiple devices, and particular architectural artifacts may simultaneously perform as a combination of two or more devices, this part of the index categorically isolates the various devices and their intrinsic parameters in order to showcase the variety and spectrum of effect that even the simplest device can engender. Each device is described in terms of its physical characteristics before a parametrically neutral instance of the device is proposed in a cutaway axonometric rendering. The subsequent series of instances illustrate the cumulative effect of relevant parameters on the produced effect. Each instance that illustrates a variation showcases the change in effect that occurs as a result of a single, relevant parameter being adjusted. The next instance operates

on the previous instance while demonstrating the effect of a different parameter. In the interest of brevity, the series does not demonstrate gradual changes that occur as a result of the alteration of a single parameter. These subtler changes in effect are important and must be considered by the architect. Though the individual series showcase the application of parametric changes as a linear, step-by-step process, the seeking and development of an effect is rarely so straightforward. The series simply introduce a collection of parameters that have the most potential to shape and form the desired effect. The application of parameters in different orders and to different degrees is encouraged as an integral part of the process. The index briefly introduces the branching possibilities that exist when a single parameter is adjusted to its complementary extreme (or otherwise) in the form of alternate series or instances (noted as alt\_).

**FRAMES**

**LENSES**

**MIRRORS**

**SCREENS**

**DIFFUSERS**

**THE RECEIVING SURFACE**

# frames

The frame is perhaps the most common architectural optic device. It is an opening or a window of any size, proportion, position, or shape. The frame affects light effect by way of its edges and position with respect to the source of light and receiving surface. While a frame may be completely open, it does often hold a window that acts as a thermal barrier and weather barrier. It is important that the transparent surface, glass or otherwise, is as planar as possible, such that the trajectory of the light that passes through it is affected only by the uniform refraction that occurs as light enters and exits the medium.

Frames can exist as a single opening or as an array of openings and can exist in a number of orientations, producing a great variety of light effects. When the frame occupies an entire, exterior-facing wall of a room, it produces a neutral image. The interaction of surface edge and light produces the simple image, and textural light and a secondary source can also be produced when light and surface are brought into proximity to one another in the adjacent and opposite orientations respectively. Due to the reflectivity of the transparent medium, light that is not transmitted produces a visible but faint specular image on the medium's surface.

## CAMERA

*ISO\_2500*  
*Aperture\_f/3.2*  
*Shutter Speed\_200*

## SUN OBJECT

*Intensity Multiplier\_0.1*  
*Size Multiplier\_2.5*

## ENVIRONMENT

*Background\_1*  
*GI (Skylight)\_1*

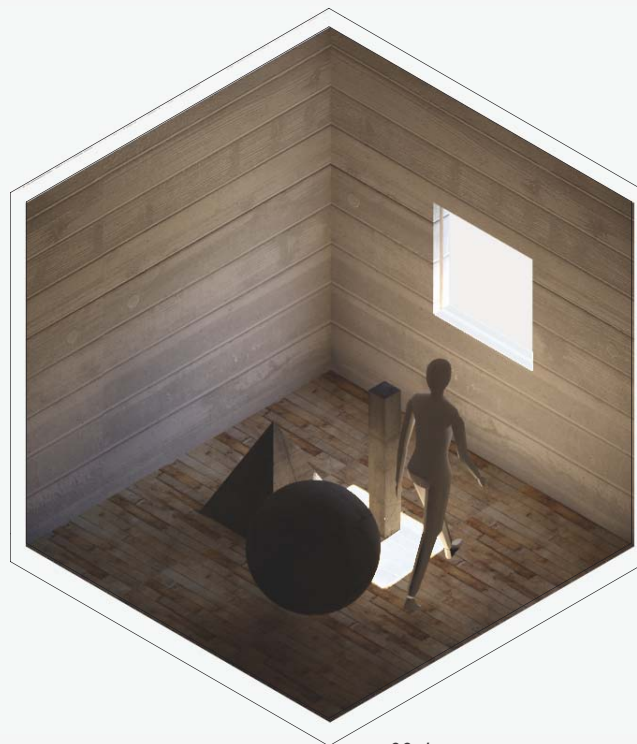


Fig. 79 Base Frame Instance

00\_base



THE INTRINSIC AGENT



Fig. 80 Series Demonstrating Frame Parameters



THE INTRINSIC AGENT

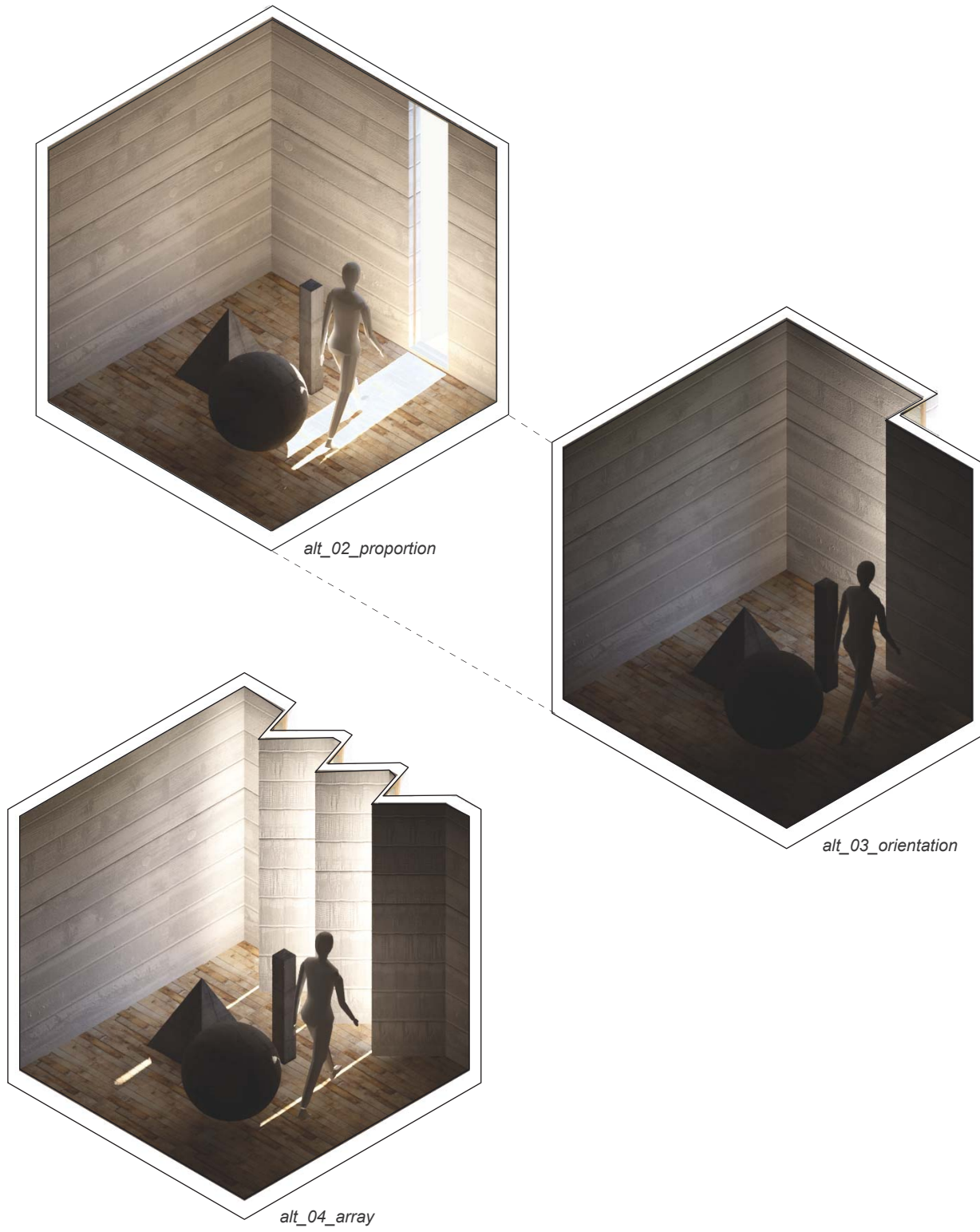


Fig. 81 Alternate Frame Parameter Series

# lenses

The primary characteristics of the lens are its transparency or reflectivity and the curvature of its surfaces. Two of these characteristics in combination produce a focusing and deflection of light from alternate areas of the receiving surface. This optic device is rarely found in architectural work and instead commonly exists in the form of glass tumblers, reflective welded surfaces, adjacent bodies of water, and imperfect planar surfaces. The inclusion of this device as an architectural device can produce significant effects that are unique in their form and notable for their relative rareness. However, because the effect relies on fluid patterns of refraction due to the curvature of one or both

surfaces, the incident light must be directional and intense for effect to be produced. Apart from this incidental parameter, the lens can manifest itself in a variety of forms, both large and small, with single or dual curvature, and with first and second surfaces that are uniformly or non-uniformly curved. Unlike the frame, the lens is harder to integrate into an architectural assembly and has therefore been proposed in its neutral state as an object that sits within the room. This device requires physical experimentation in order to produce precise caustic light, but can be introduced as a less precise interpreter of light information within a space as well.

## CAMERA

*ISO\_2500*  
*Aperture\_f/6*  
*Shutter Speed\_200*

## SUN OBJECT

*Intensity Multiplier\_0.25*  
*Size Multiplier\_1*

## ENVIRONMENT

*Background\_20*  
*GI (Skylight)\_20*

## CAUSTICS\_on

*Search Distance\_10*  
*Max Photons\_65*  
*Max Density\_0*  
*Multiplier\_0.6*

*note: model scaled  
down to 1:15 in order  
to render visible effect*



Fig. 82 Base Lens Instance

00\_base

THE INTRINSIC AGENT



Fig. 83 Series Demonstrating Lens Parameters

THE INTRINSIC AGENT



*05\_pattern*



*06\_non-uniform thickness*

*i*



# screens

The screen is another fairly common architectural device. In the case of a curtain wall system that involves structural framing or structural silicone, a screen is an intrinsic part of the system. Screens often exist within the frame (another optic device) as decorative or sun shading elements. However, the screen can stand alone in warmer climates or within or outside a thermally broken element such as a window. Screens are significantly present in historical architectural work in the form of such elements as the *masbrabiya*, a traditional element of Arab architecture, as well as in contemporary architecture in the form of both environmentally- and mechanically-driven kinetic screen systems. The possible variety of the architectural screens is well-

established, with such parameters as its materials, unit configuration, array type, and orientation guiding and diversifying their design. The screen as an optic device, however, aims to address the qualities of light that are produced by the screen within the space whose light reception it modulates. Though screens can be designed to control the amount of light that enters a space in the interest of reducing solar gain, parameters such as the screen's thickness and proximity to the opening/light source and any secondary light sources play a significant role in shaping the simple image that is formed by the interaction of light with the edges or material of the screen.

## CAMERA

ISO\_2500  
Aperture\_f/7  
Shutter Speed\_200

## SUN OBJECT

Intensity Multiplier\_0.02  
Size Multiplier\_2.5

## ENVIRONMENT

Background\_0.6  
GI (Skylight)\_0.6



Fig. 84 Base Screen Instance

00\_base

THE INTRINSIC AGENT

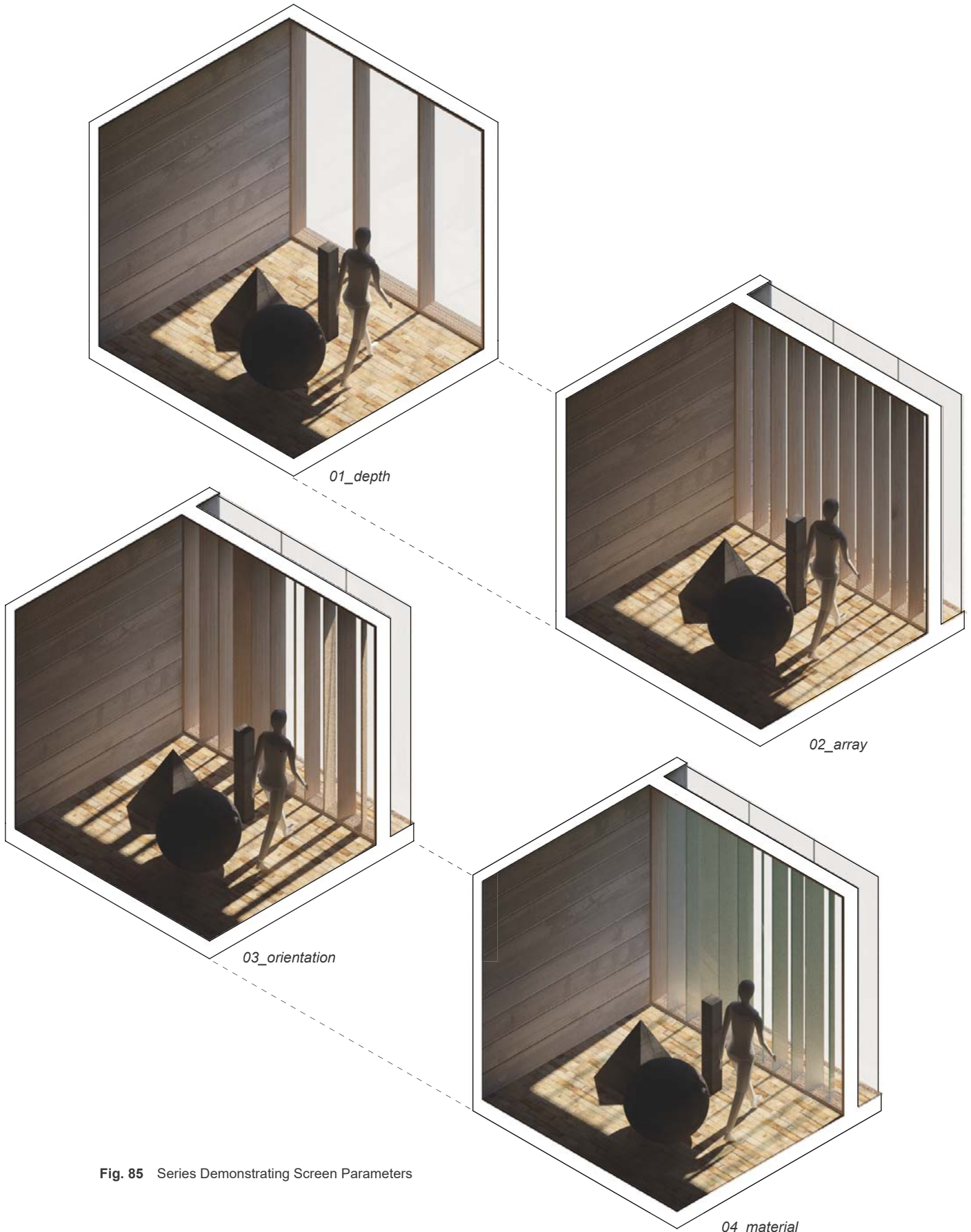


Fig. 85 Series Demonstrating Screen Parameters



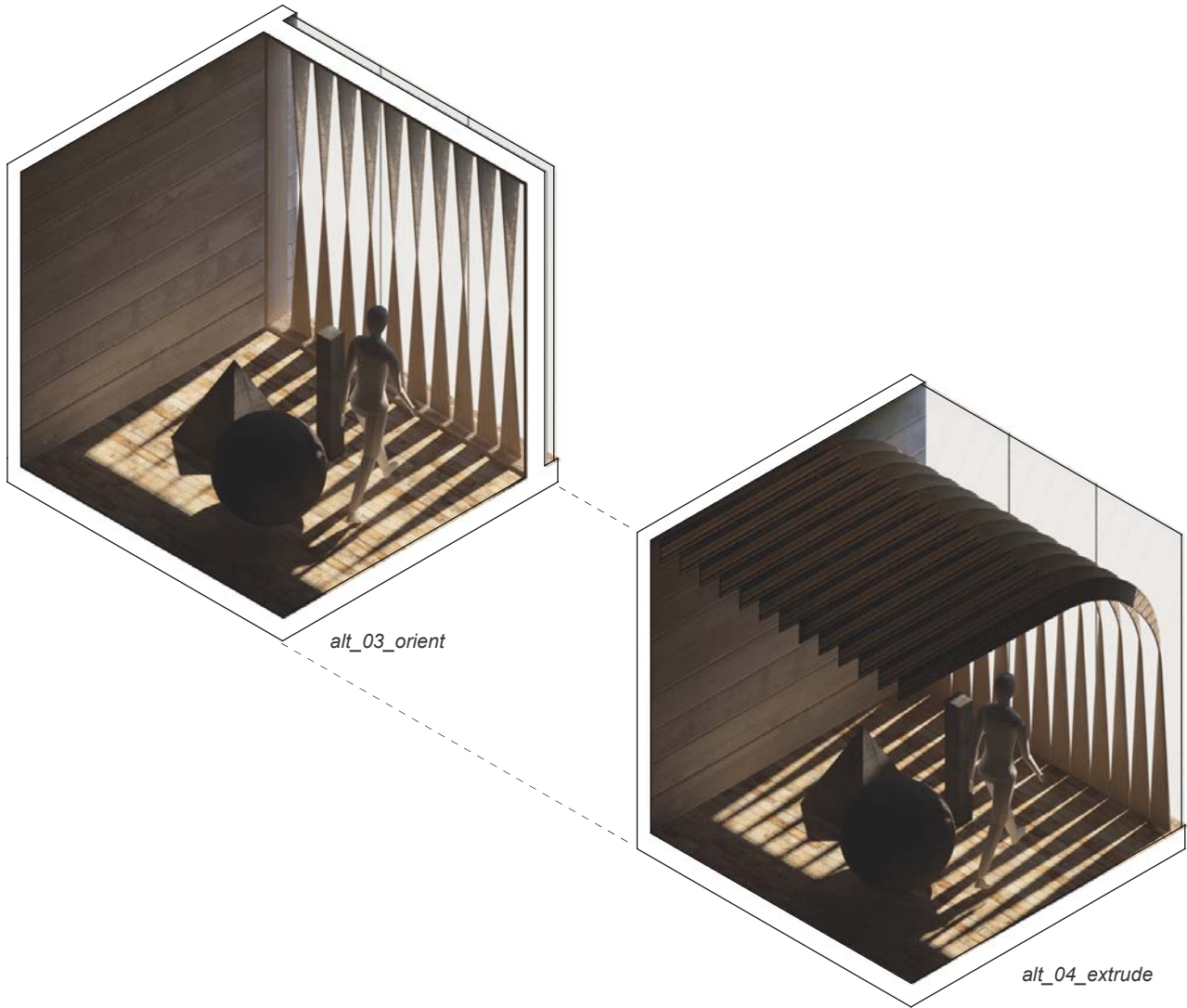


Fig. 86 Alternate Screen Parameter Series



# diffusers

Diffusers are primarily used in architectural work to reduce the directionality or intensity of incident light. When light-sensitive materials are present in a space, a diffusing mechanism can be used to provide ambient illumination and indirect access to daylight while significantly reducing the possible degradation of the artifacts. These optic devices can also be used to preserve privacy or improve the distribution of light within a space. The parameters that inform the nature of the diffuser can include its size, proportion, translucency, reflectivity, geometry, and the possible introduction of a covering panel. Where a covering panel is not used to obscure the source, thickening the frame of the opening produces surfaces of a more significant surface area around the source that can act to diffuse

the incident light. Because this mechanism relies on diffuse reflection, it will most often produce the archetypical effect of a secondary source, wherein light that directly enters the space is reflected onto another surface which then also acts as a source of light within the room. Diffusers can also exist at a much smaller scale within an architectural space. Mists and clouds are diffusers because the size of the water droplets is similar to the size of the wavelengths of incident light that interact with them. Mie scattering, a process that equally scatters all wavelengths of light in all directions including the forward direction occurs, and the scattered white light appears diffuse while each droplet appears as a miniscule secondary source of light.

## CAMERA

*ISO\_2500*  
*Aperture\_f/3.2*  
*Shutter Speed\_200*

## SUN OBJECT

*Intensity Multiplier\_0.1*  
*Size Multiplier\_2.5*

## ENVIRONMENT

*Background\_1*  
*GI (Skylight)\_1*

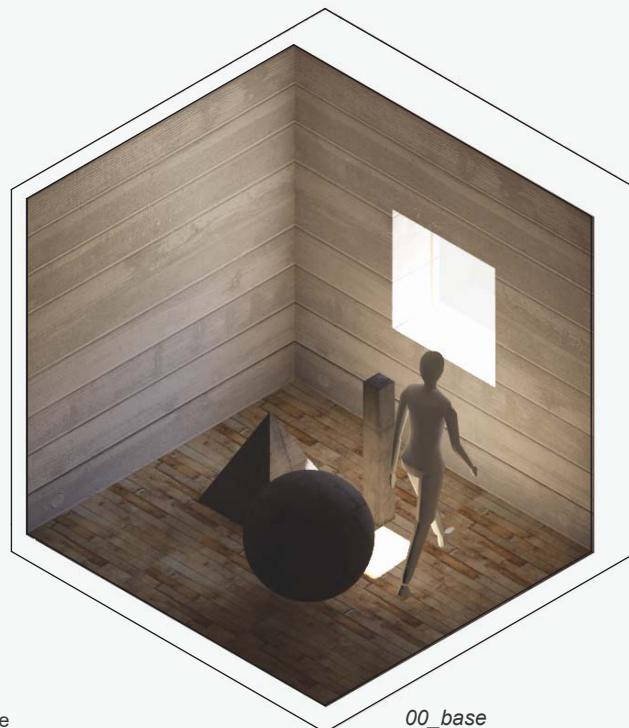


Fig. 87 Base Diffuser Instance

00\_base

THE INTRINSIC AGENT

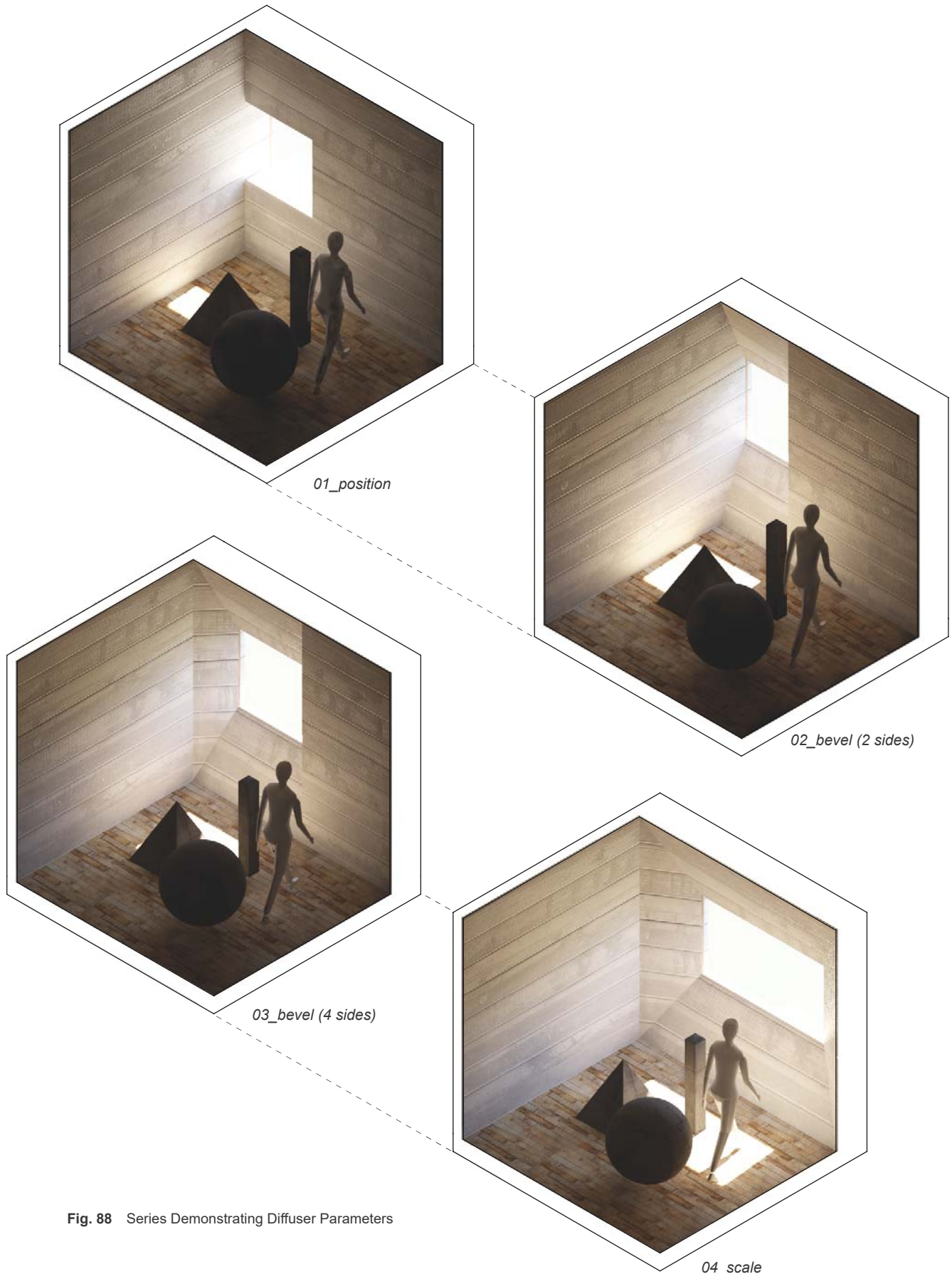


Fig. 88 Series Demonstrating Diffuser Parameters

THE INTRINSIC AGENT



Fig. 89 Alternate Diffuser Parameter Series



# mirrors

Plane mirrors are commonly found in homes as artifacts of daily living and in larger spaces as the finish quality of certain materials such as glass and metal. Plane mirrors produce a specular image of light that is arriving from another mirror surface or from objects and scenes that exist at another location. It is the preservation of the image and the almost complete reflection of the incident light, a result of the surface being optically smooth, that allows the mirror device to carry light further into a space or to an unexpected plane or surface. Parameters that inform the mirror device include the curvature (specular image distortion), faceting, (specular image fragmentation), number and

adjacency of mirror devices, and the smoothness of the surface. Though it does not concentrate light, light that reflects from the surface can be observed to produce a bright white or golden image of the mirror surface on nearby surfaces that are not optically smooth. The brightness of this image, that can often appear on shadowed surfaces, gives it the appearance of a caustic image, though it is not technically so. The smoothness of the surface can also affect the quality of the specular image that is produced, which may or may not be desirable to the architect. The surface of a reflecting pool may also act as a mirror device, as shown.

## CAMERA

*ISO\_2500*  
*Aperture\_f/7*  
*Shutter Speed\_200*

## SUN OBJECT

*Intensity Multiplier\_0.01*  
*Size Multiplier\_4*

## ENVIRONMENT\_light dome

*Intensity\_2.1*  
*Texture Resolution\_975*  
*Target Radius\_100*  
*Emit Radius\_122*

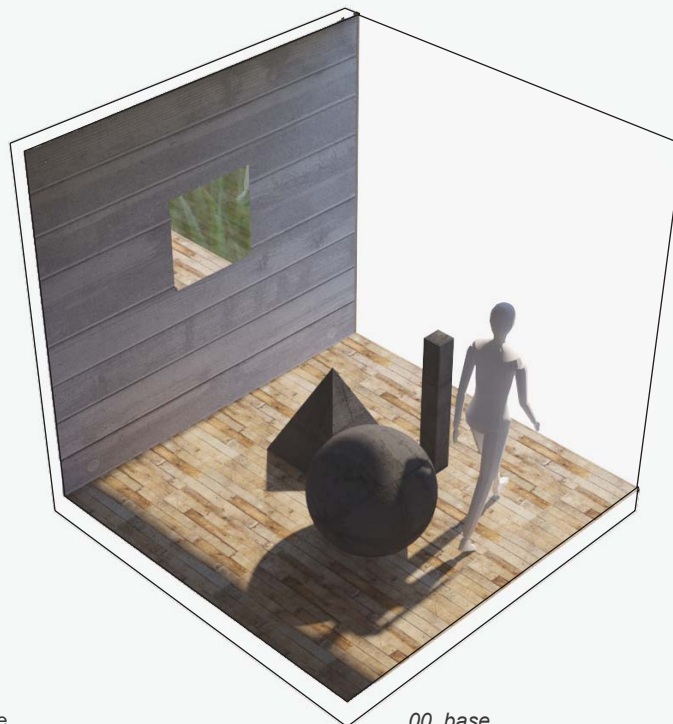


Fig. 90 Base Diffuser Instance

00\_base

THE INTRINSIC AGENT

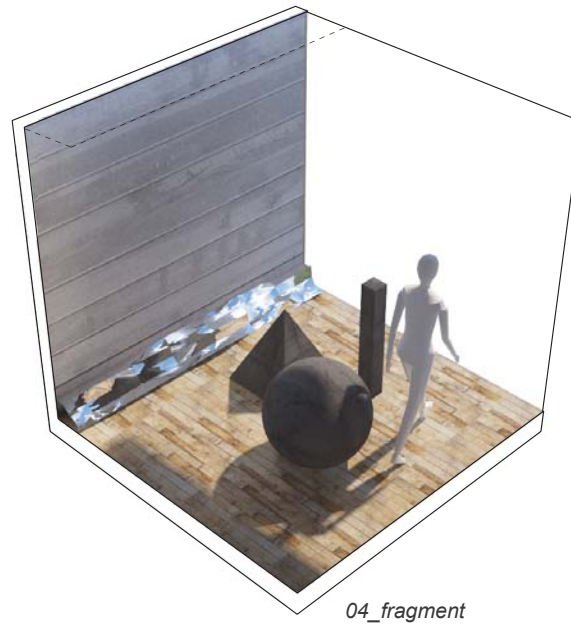
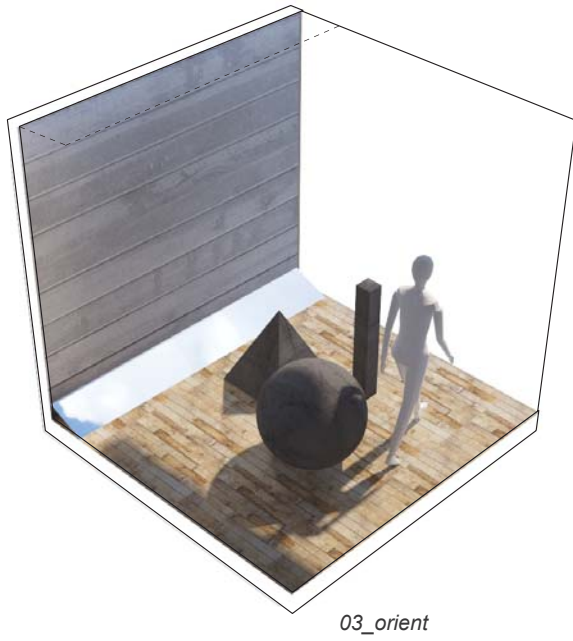
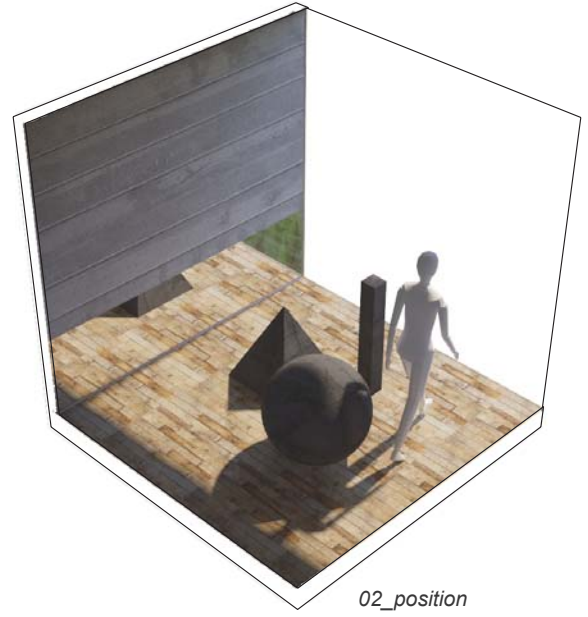
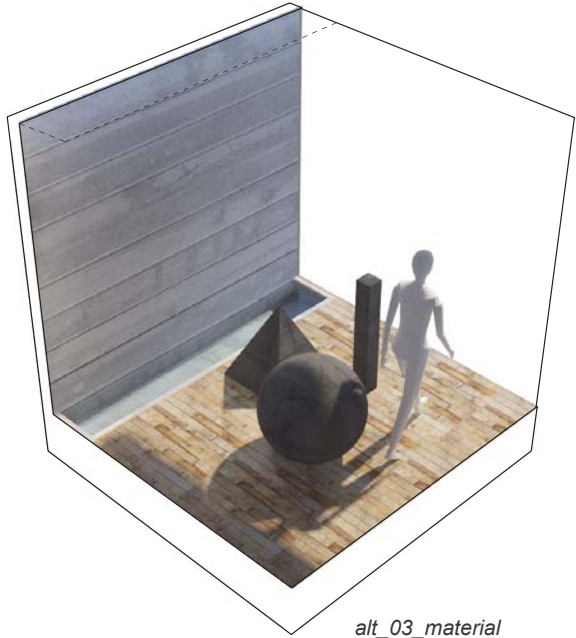


Fig. 91 Series Demonstrating Mirror Parameters





*alt\_03\_material*



*alt\_04\_adjacency*



*alt\_05\_proportion*



*alt\_06\_agitate*

**Fig. 92** Alternate Mirror Parameter Series

## the receiving surface

In some cases, in order to for the viewer to fully perceive an effect of light, a receiving surface must be present to register the operation that has been performed by the primary optic device. For two out of the five primary optic devices, namely mirrors and diffusers, it is often the case that the role of the receiving surface, a secondary optic device, is performed by the primary device. A water droplet that scatters light is also the material from which the effect's light arrives to the viewer's eyes. This secondary device is therefore not an essential component of every light effect, but it does have the capacity to transform the light arriving to it from a primary optic device through the adjustment of its own parameters. The receiving surface is not always solid, does not always have a certain order of texture, is not always uniform in colour, and is not always planar. All of these parameters affect how the surface registers light, and this in turn affects

the patterns of light that we observe from the receiving surface and the sensations that they evoke. The receiving surface plays a critical role in the formation of the specular image, secondary source, and textural light archetypes, as these archetypes of effect are produced as a result of the receiving surface's parameter of roughness. At an extreme, the receiving surface can become a primary optic device (the mirror). Though primary optic devices can be deployed in combination, it is perhaps more common in architectural practice to observe a layering of receiving surfaces such as stone and glass. These compound interactions can be difficult to simulate and study, but can significantly influence the registration and subsequent perception of the light effect. The loose parameter of layering is therefore particularly applicable to this secondary optic device, and it must be given its due attention in the course of the design of light-driven tectonics.

### CAMERA

*ISO\_2500*  
*Aperture\_f/7*  
*Shutter Speed\_200*

### SUN OBJECT

*Intensity Multiplier\_0.05*  
*Size Multiplier\_2.5*

### ENVIRONMENT

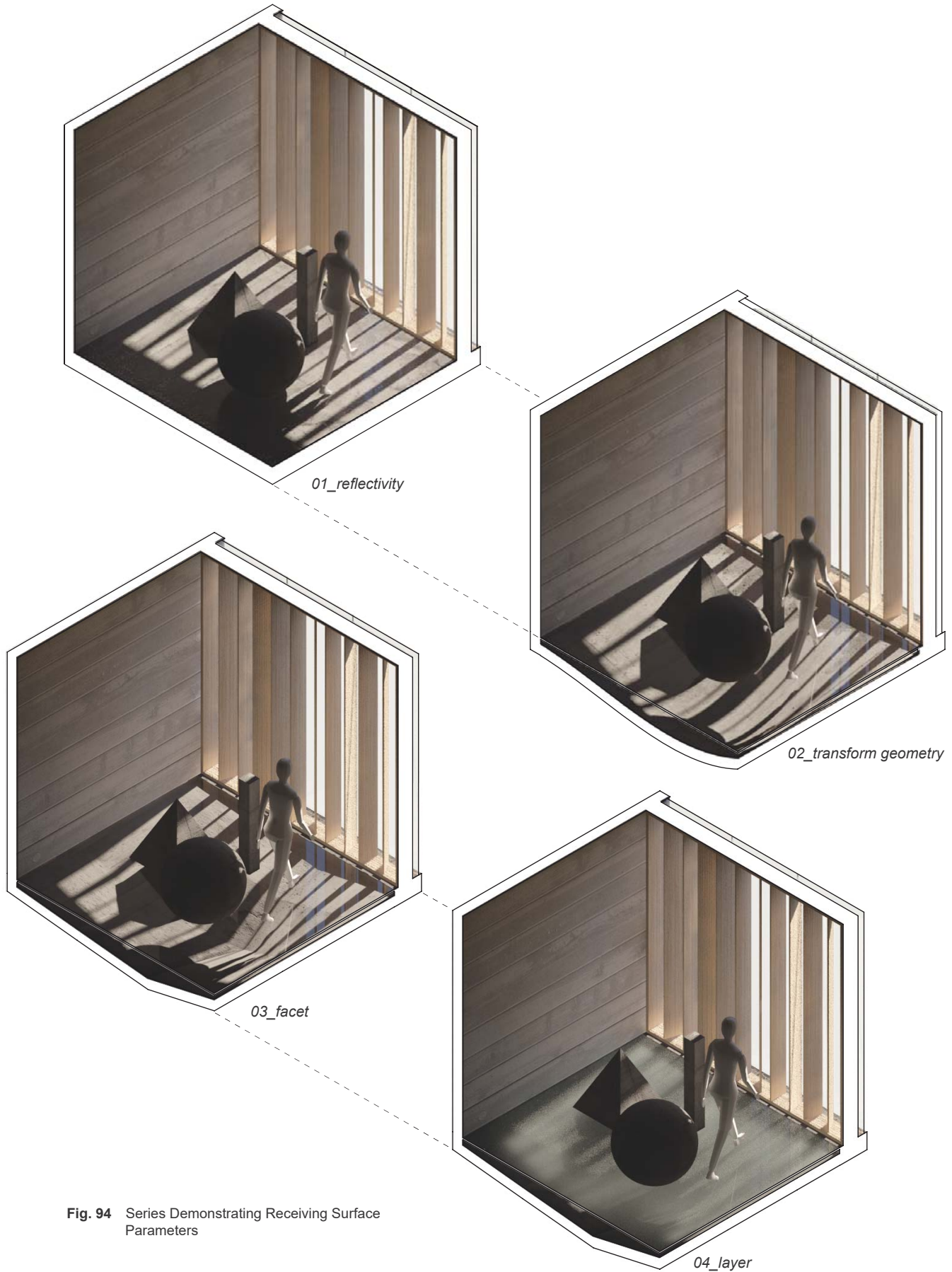
*Background\_0.6*  
*GI (Skylight)\_0.6*



Fig. 93 Base Receiving Surface Instance

00\_base

THE INTRINSIC AGENT



**Fig. 94** Series Demonstrating Receiving Surface Parameters



THE INTRINSIC AGENT

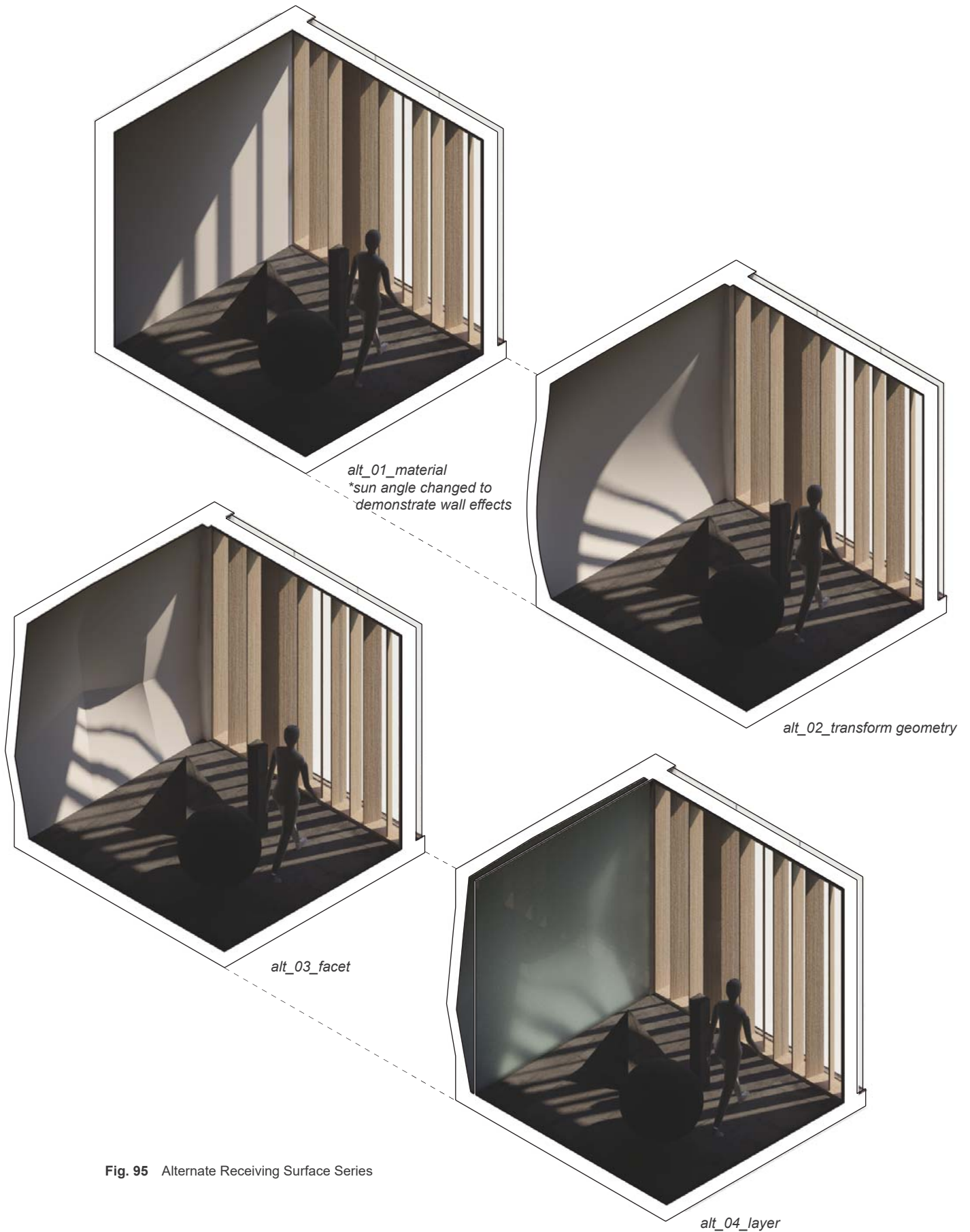


Fig. 95 Alternate Receiving Surface Series





# PART IV

---

DESIGNING WITH LIGHT



Fig. 96 Vector Architects, *Seashore Library*



## seashore library

### AN ANALYSIS

---

Vector Architects' *Seashore Library* project has been chosen as the subject of the last part of this thesis investigation because it contains a simple, cohesive suite of optic devices. A larger goal of evoking a connection between the memories of the individual and the sea drives the formulation of the devices, alongside secondary considerations such as their performance in terms of view and ventilation. The building, a curious, isolated figure standing on Nandaihe Pleasure City's beach in Hebei, China, serves the nearby neighbourhood with its loosely programmed spaces that primarily access eastern and western light. The shifting effects of light that enter the space over the course of the day are therefore quite dramatic and uninhibited by surrounding buildings, rendering the site an ideal place in which to investigate optic tools. This investigation explores how the proposed reference of archetypes of effect, optic devices, and their

parameters can be used to take apart, study, identify, and evolve an existing system strategy of involving light in architecture. The architects describe the building as “quietly sitting on the seashore”,<sup>1</sup> and containing diverse experiences that raise the senses of the occupant and provoke a curated engagement with the adjacent Bohai sea. It is further described as a “spiritual linkage” that “[unfolds] the feeling of distant and loneliness [that is] different from city life.”<sup>2</sup> The architects assert that this feeling of loneliness, distance, and memory is captured in the texture of the board formed concrete walls, which is inspired by “the sand marks of footprints, wind and wheels on site. It implies a mark of memory in time that can be read as a poem.”<sup>3</sup>

---

1 “Seashore Library / Vector Architects” June 2, 2015. ArchDaily. Accessed: July 5, 2017, <http://www.archdaily.com/638390/seashore-library-vector-architects/>.

2 Ibid.

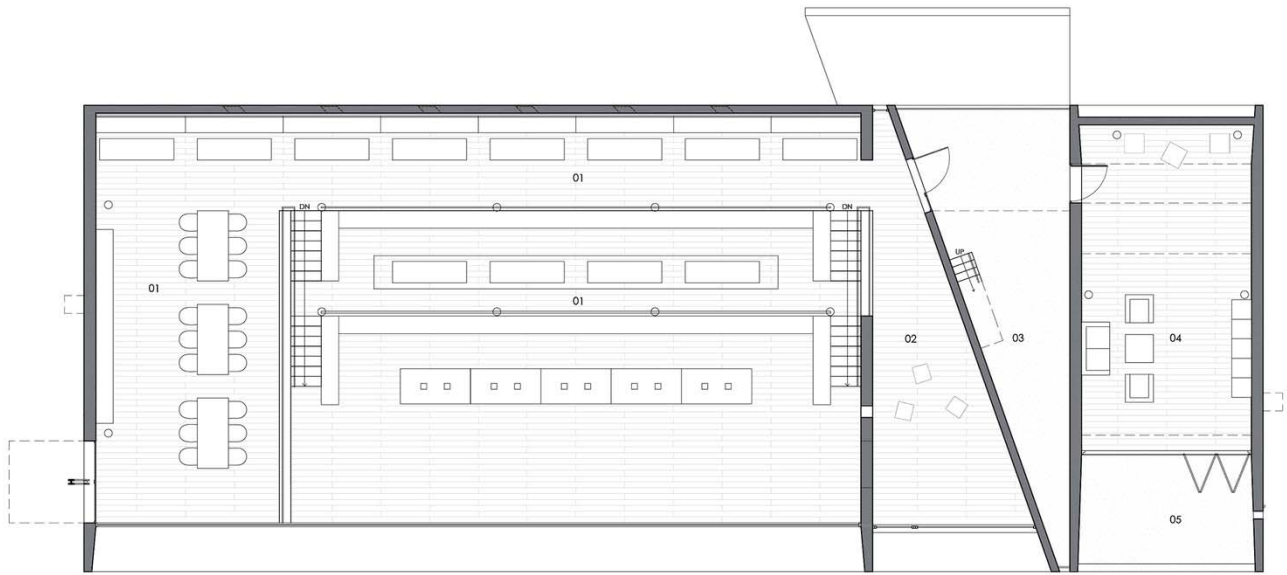
3 Ibid.

THE INTRINSIC AGENT



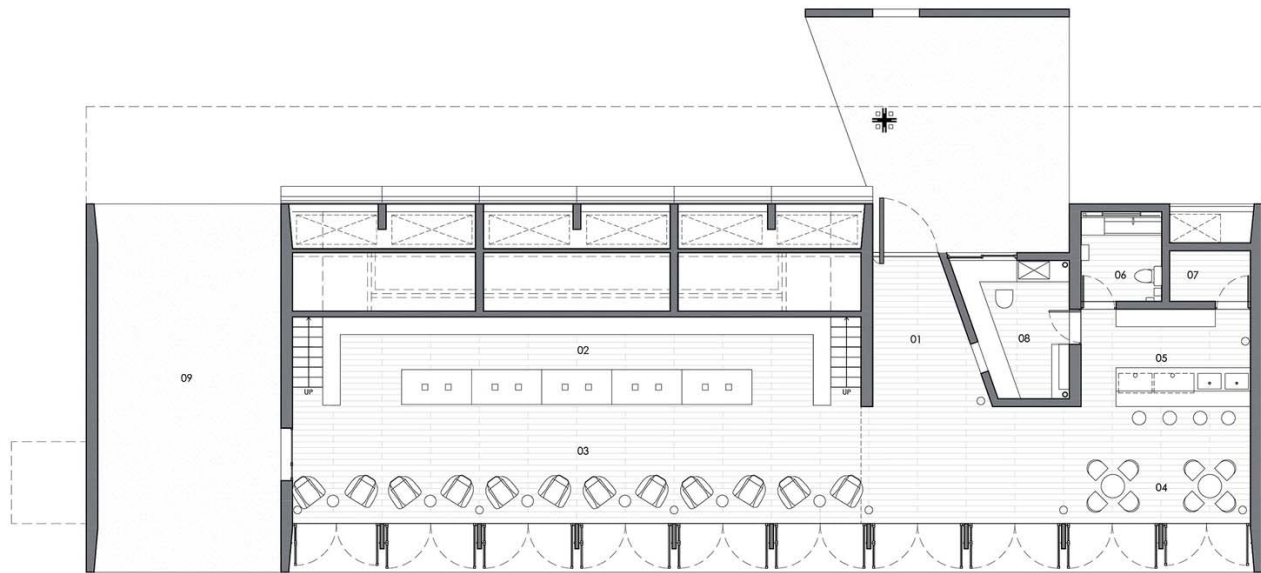
Fig. 97 Seashore Library Site Plan

## DESIGNING WITH LIGHT



- 01. Reading area
- 02. Meditation space
- 03. Outdoor platform
- 04. Activity room
- 05. Balcony

**Fig. 99** Seashore Library Second Floor Plan



- 01. Reception
- 06. Toilet
- 02. Book display area
- 07. Storage
- 03. Reading lounge
- 08. Office
- 04. Resting area
- 09. Outdoor area
- 05. Bar

**Fig. 98** Seashore Library Ground Floor Plan





(Section 1 omitted)

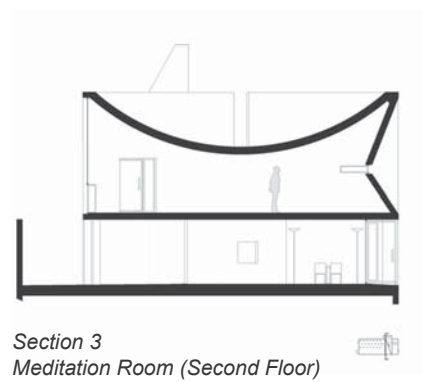
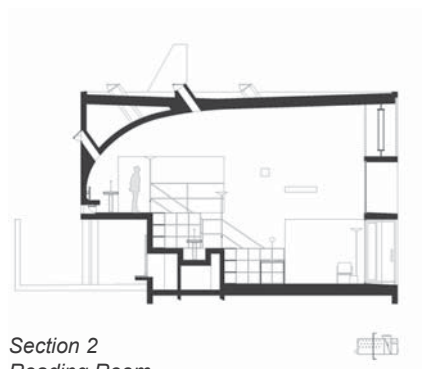


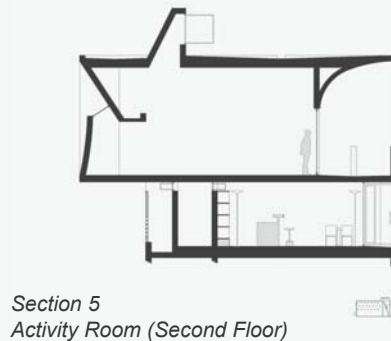
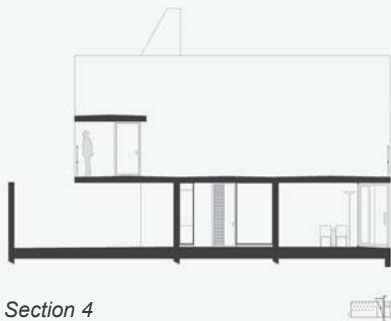
Fig. 100 Transverse Sections



## system strategy

The overall system strategy behind the project's optic devices is not immediately discernible because of the variety of spatial conditions produced by the dynamic profiles of each section of the building and the conceptual significance of the chosen materials. Though the architects state that the project was developed in section, and the section drawings themselves (Fig. 100) speak to an overall strategy of curving and angular profiles, these architectural moves on their own do not speak to an investigation of light effect. Similarly, although light does enhance the texture of the board formed concrete surfaces, the optic devices do not engage with this phenomenon which appears to be a by-product of the shallow angle at which direct morning and evening light enters the project. In comparison, many of the optic devices can be characterised as slit-like apertures (Fig. 104), focused sources that frame the viewer's perception of the outside world within a taut band, a marked threshold between the interior and exterior world. These slit apertures, a clear system strategy, can be found throughout the

design, from both facades of the meditation room to the activity room and main reading room. The combination of the axial orientation of the building and the roughened but slightly glossy surfaces of the wood floor and concrete walls produces slivers of secondary sources that spark an interplay of diffuse and direct light. Because the narrow opening restricts the amount of light that enters the room, more subtle effects are visible against the shadows of the room. The system strategy is also applied on a larger scale in the reading room. The design of the reading room avoids a homogeneous openness and draws from the natural adjacent triumvirate of sand, water, and sky in its treatment and reception of light. The three tools present in the reading room's sea-facing façade include the panel of doors at grade, the panoramic glass expanse above it, and finally the section of frosted glass block at the top of the façade (Fig. 101). They section and provide access, free the gaze of the viewer, and diffuse and conceal disruptive elements respectively.



THE INTRINSIC AGENT



Fig. 102 Textural Light

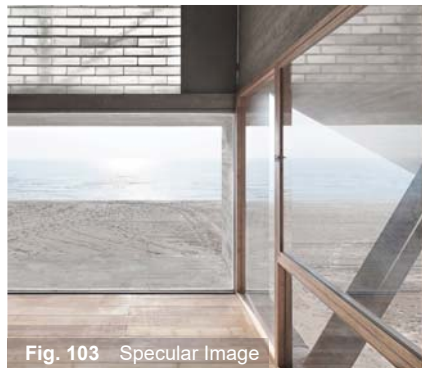


Fig. 103 Specular Image

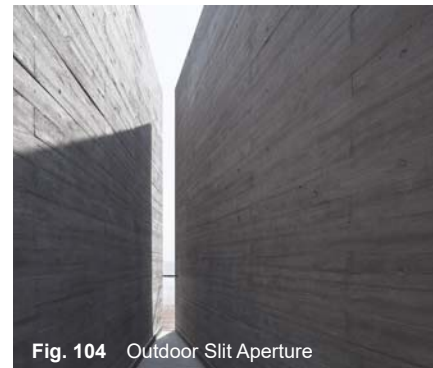
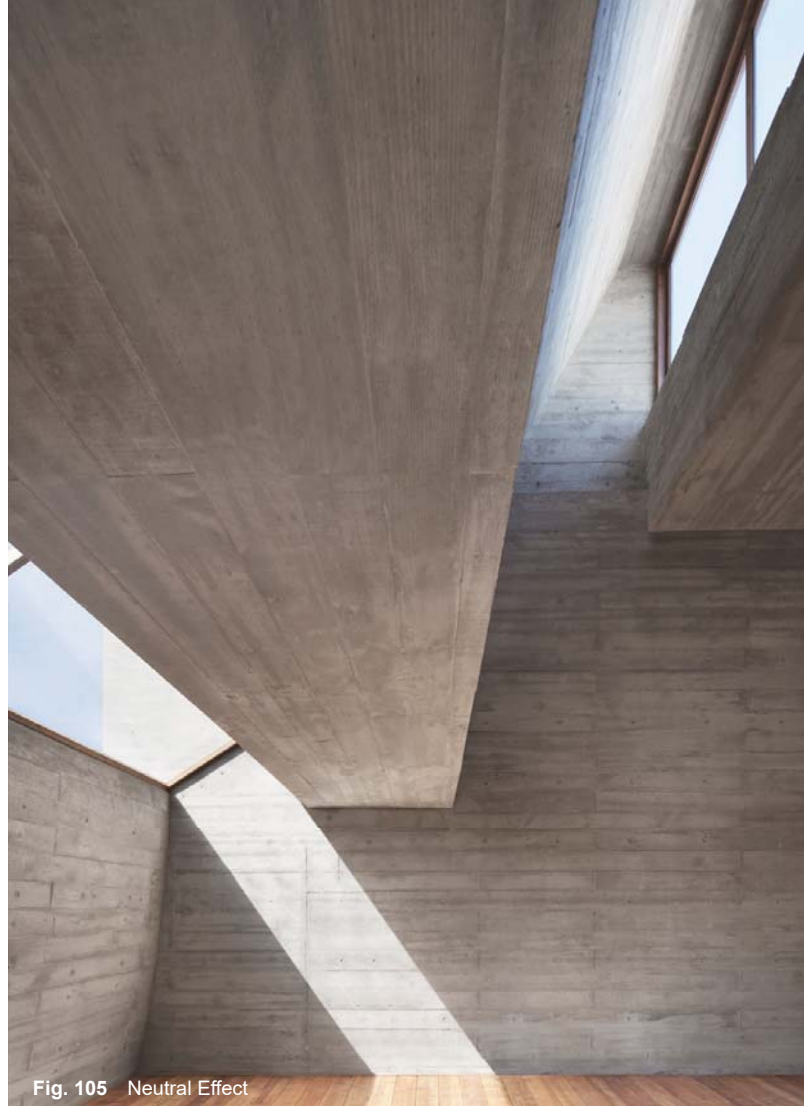


Fig. 104 Outdoor Slit Aperture

## archetypes

The architects' use of board formed concrete throughout the project renders textural light (Fig. 102) the most striking archetypical effect of light that can be observed in the building. The cast concrete surface can produce a vibratory tension in combination with strong, directional light (as the receiving surface holds and releases light along its contours) just as it can soften and blur under diffuse light. The textural light produced by the concrete is accompanied by other archetypical forms of light effect that can be readily identified throughout the building. A general view toward the sea from the reading room (Fig. 101) offers a rhythmic array of simple images in the form of sharp shadows that reach into the room at grade. Just above the panel

of operable doors, the image of the sea is contained within a deep frame featuring an uninterrupted panoramic expanse of glass. Lastly, the frosted handmade glass block, a diffusing mechanism, acts as a secondary source for the light behind, softening what would have otherwise been the sharp simple image of the structural steel. There are smaller optic devices that also play a role in the experience of the reading room. For example, when one's gaze is parallel to the window shown in Fig. 103, a specular image appears to the viewer. The adjacency of this glass mirror (optic device) and the panoramic frame produce an experience in which the ocean, sand, and reflected light appear to continue into the building and to surround the viewer.



# optic devices

The openness of the eastern façade of the reading room is contrasted by the relatively small and precise 30cm circular perforations that are arrayed along the half-arched roof of the space. In all seasons except winter, patterns of ellipses drifting over the floor signal the fading of light in the eastern sky over the sea. The light in the reading room is more even and diffuse in deference to the act of reading, while the two remaining rooms take advantage of the near east-west orientation of the building and prioritise visceral experience over programmatic specificity and utility. These rooms span the width of the building and feature optic devices positioned along both the eastern and western facades of the building. Skylight and sunlight therefore enter the room from opposing directions during the morning and evening. The warm, yellow and golden light of sunrise and sunset meets the deep blue of growing and fading skylight from across the room, producing a tension between the two simultaneously occurring neutral states.

The meditation room and outdoor space are formed of the same rectangular area that spans the width of the building and is bisected by a wall that does not quite meet the opposite corners of the space. The meditation room can be entered from the reading room and features one optic device at both ends: one that is vertically oriented and fills the space left by the bisection, and a second that is a horizontally oriented frame of the same width (Fig. 107). The east-facing horizontal frame sits at the vertex of a wall that has been pinched inward, while a curved ceiling that drops down to a single storey stretches from end to end of the tapered room (Fig. 100, Section 3). The effect is vivid and complex. The interaction of sky, sand, wood, and concrete produces a variety of tones and hues in the diffuse spray of light from the horizontal opening. Bluish light from the sky colour the wash of light that is layered with the pale orange reflections from the

sand and wooden window frame. From the west, a long band of bright golden light strikes the interior wall and rough interior wood flooring. The intensity of the light coupled with the soft light scattering and reflectivity of the wood and roughened plastic surfaces of the concrete produces a luminous golden haze at the base of the wall, while the shadowed inward sloping wall in the east seems to reach out just far enough to capture the energy arriving from the temporary, wooden secondary source (i.e. the floor).

The activity room, undisturbed from its geometry as a single rectangular room spanning across the building features a balcony in the east and a dramatic combination of hidden light source (a frame receiving western light) and a clerestory (a diffuser receiving eastern light), in the west. The proximity of these hidden sources produces a direct interaction of eastern and western light. Though the devices in combination can appear neutral (as they appear in Fig. 105), in the evening the effect becomes quite stark as the golden western light fades further and further from the eastern sky, and the rich blue light of evening ventures into the space from both east-facing devices, namely the balcony and clerestory. The contrast of the eastern and western devices is further enhanced by the cave-like image that is produced by the western device when the bottom edge of wall profile above it is extended into the room. Receiving little light due to its geometry and position, the cavernous space recedes and further increases the mystery of the sources of light when the assembly is viewed directly from the east (Fig. 106). As is the case in the meditation room, the western light that enters from the hidden, western-facing frame is intense, directional and very warm in colour. Reflections from the wood floor create a tertiary source of light on the underside of the cold cavern above, while the surrounding concrete holds the glow of the incident light.





**Fig. 108** Exterior Rendering, View from the Sea



## seashore dwelling

### TESTING THE REFERENCE

---

In many of the existing project's spaces, the meeting of framed light from the eastern and western skies (co-existing but different neutral states) drives the ambience of the room by producing a dynamic range of light effect. However, with the exception of the reading room, the utility of the space does not come to bear on the generation of the optic devices that govern the effects of light. The design of a dwelling for a librarian and an extension of the library's program, a maker space, borrows from the tectonic strategy of the existing building but reinterprets its model of optic devices to suit and complement smaller spaces of prescribed activity. The system strategy, which has been established as being based in a slit-like geometry, will be expanded to include the secondary considerations of utility and privacy. The design exercise tests whether the

methodological reference will enable an architect to reveal new ways in which to deploy the slit-aperture. By identifying the desirable archetypal effects of light, understanding their requisite tectonic elements, and experimenting with the parameters that govern them, the architect can delve beyond the existing optic devices and light phenomena of the case study.

Given the expanded system strategy, the design will primarily explore the combination of the slit geometry with a preference for diffuse, indirect light. The design will privilege the secondary source archetype in order to confer light to the interior of the ground level dwelling while maintaining privacy in certain areas. Many of the existing tectonic strategies will create interiors that resonate with Vector Architects' conception of the existing project as a solid, weathered rock that contains diverse, rich experiences.

## documenting the process

What follows is a thorough documentation of the process of testing a preliminary design and developing it using the proposed methodology. Tools include Rhinoceros 5 Service Release 14 (3D modeler) V-Ray 3.40.01 for Rhinoceros (rendering software, light simulator), and Grasshopper Build 0.9.0076 (algorithm editor for use in parametric modeling).

Following the completion of initial renders of various views of the digital model, portions of the design are resolved on a space-by-space basis. Some of the design solutions are parametrically modeled once the basic optic device is established, while others are developed more traditionally from start to finish.

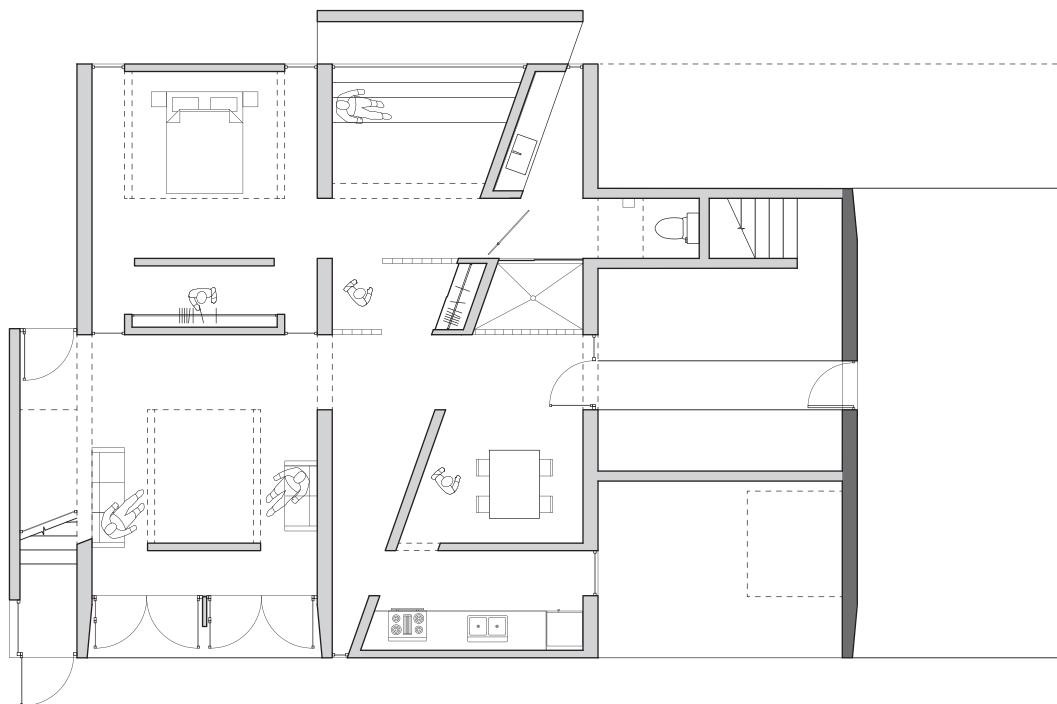
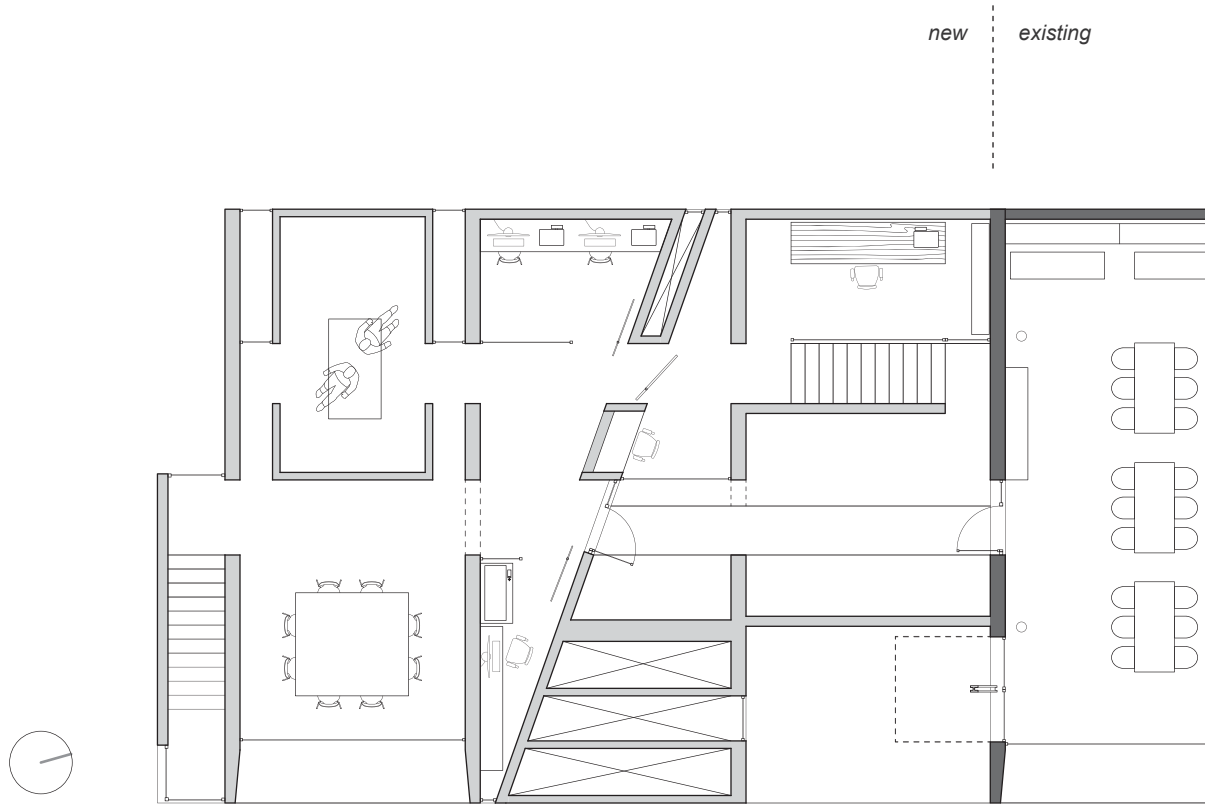
Both an HDRI and SunLight light source

were used to light the scene (as described in detail in the lighting section of Part III). No additional light sources have been added to simulate artificial lighting as the design exclusively tests the application of the reference with respect to natural light. A clear, well-established and well-documented methodology for designing a system of artificial light may be found in architectural lighting design literature. Testing the architectural lighting design methodology lies beyond the scope of this work.

Please note that only a selection of renders completed throughout the design process have been included here. Of those that have been omitted, some show a calibration of lighting intensity and camera settings while others show the resolution of noise and blotchiness issues with V-Ray.

THE INTRINSIC AGENT

new existing





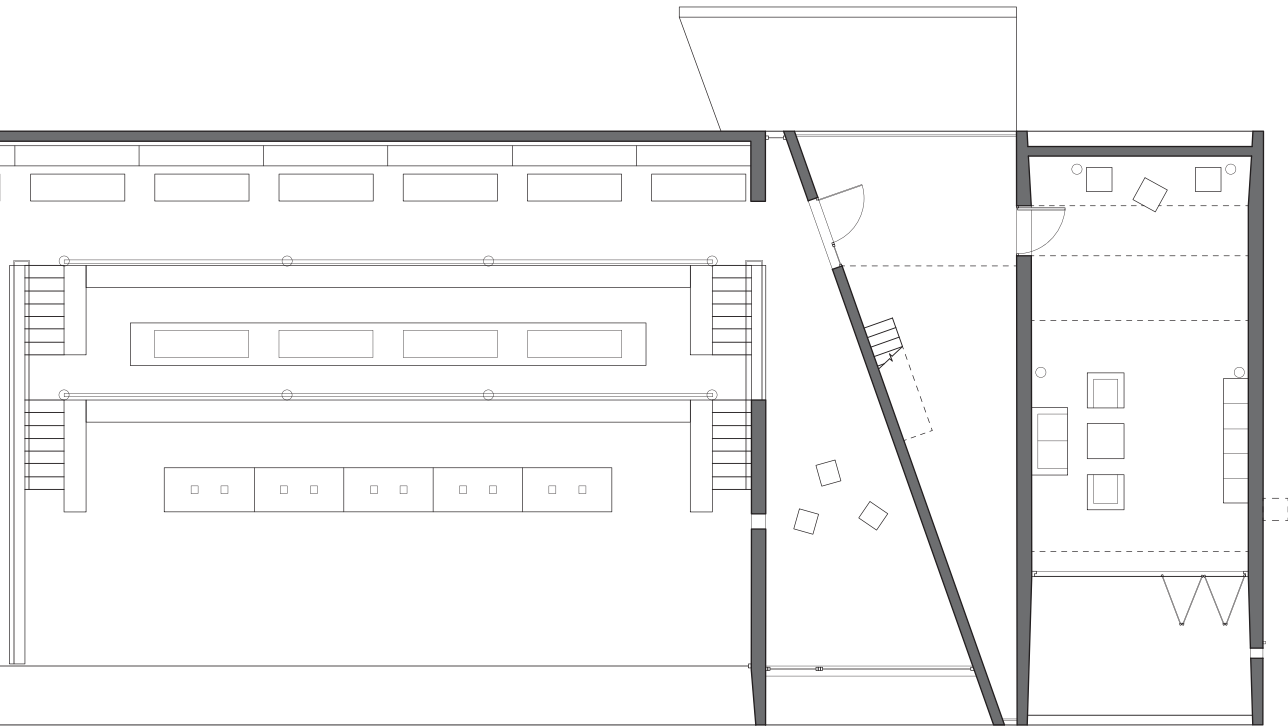


Fig. 109 Second Floor Plan with Preliminary Addition

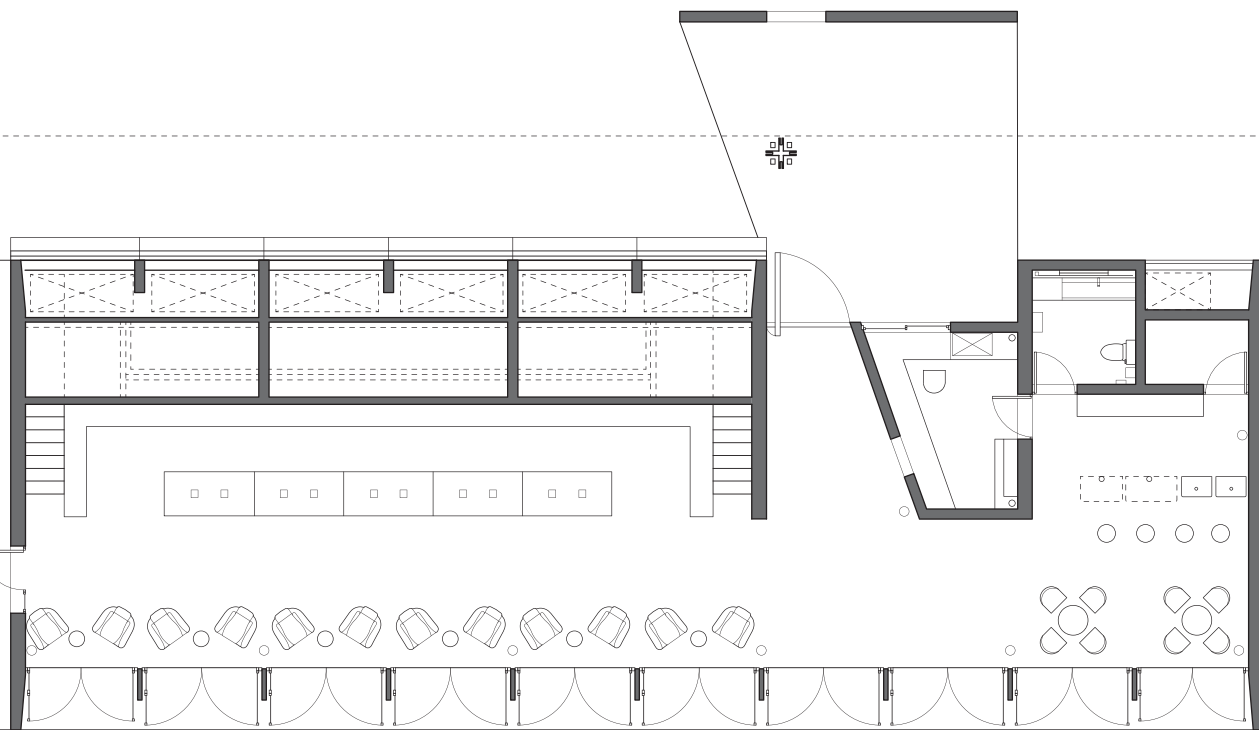


Fig. 110 Ground Floor Plan with Preliminary Addition



THE INTRINSIC AGENT

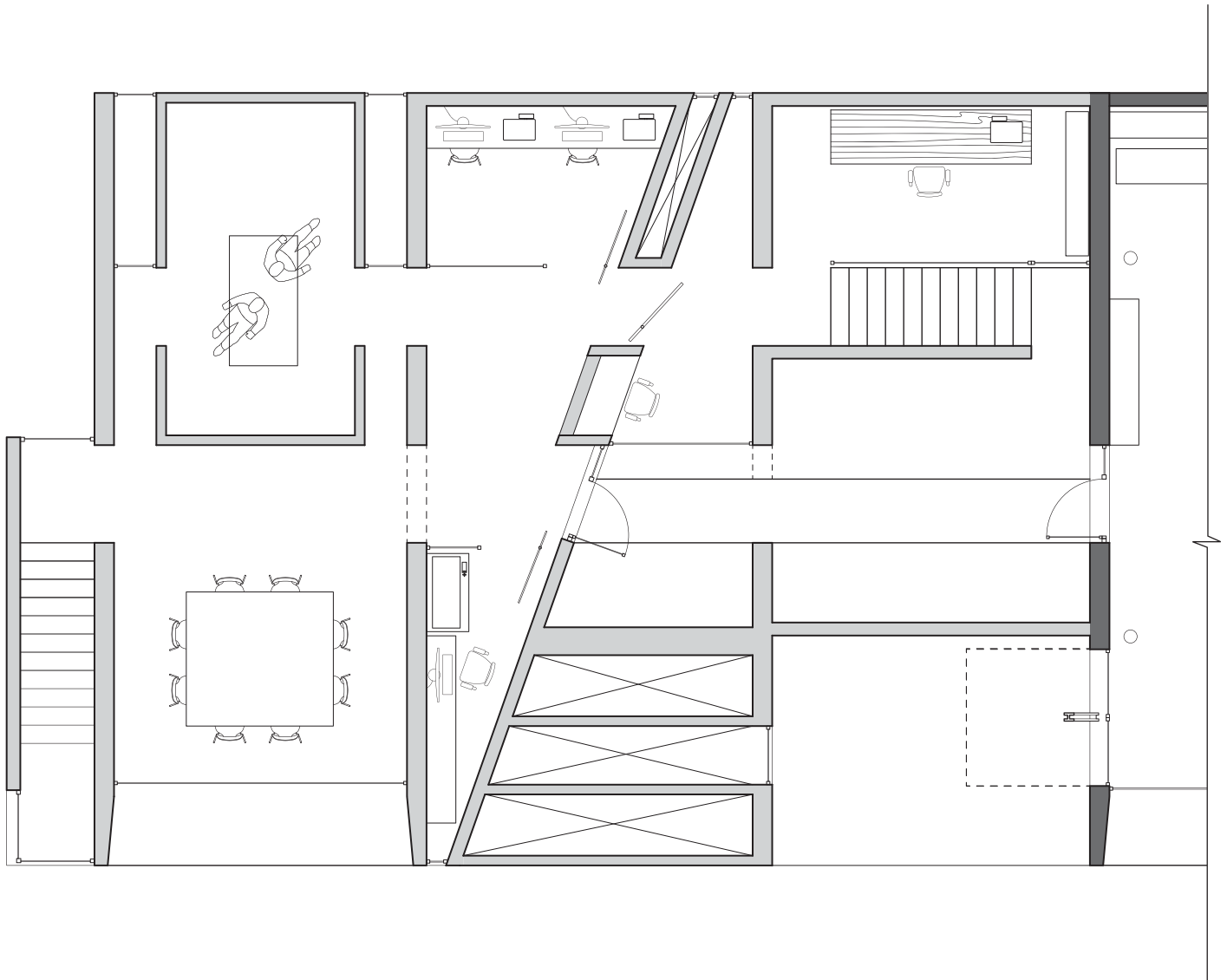


Fig. 111 Preliminary Second Floor Plan, 1:100

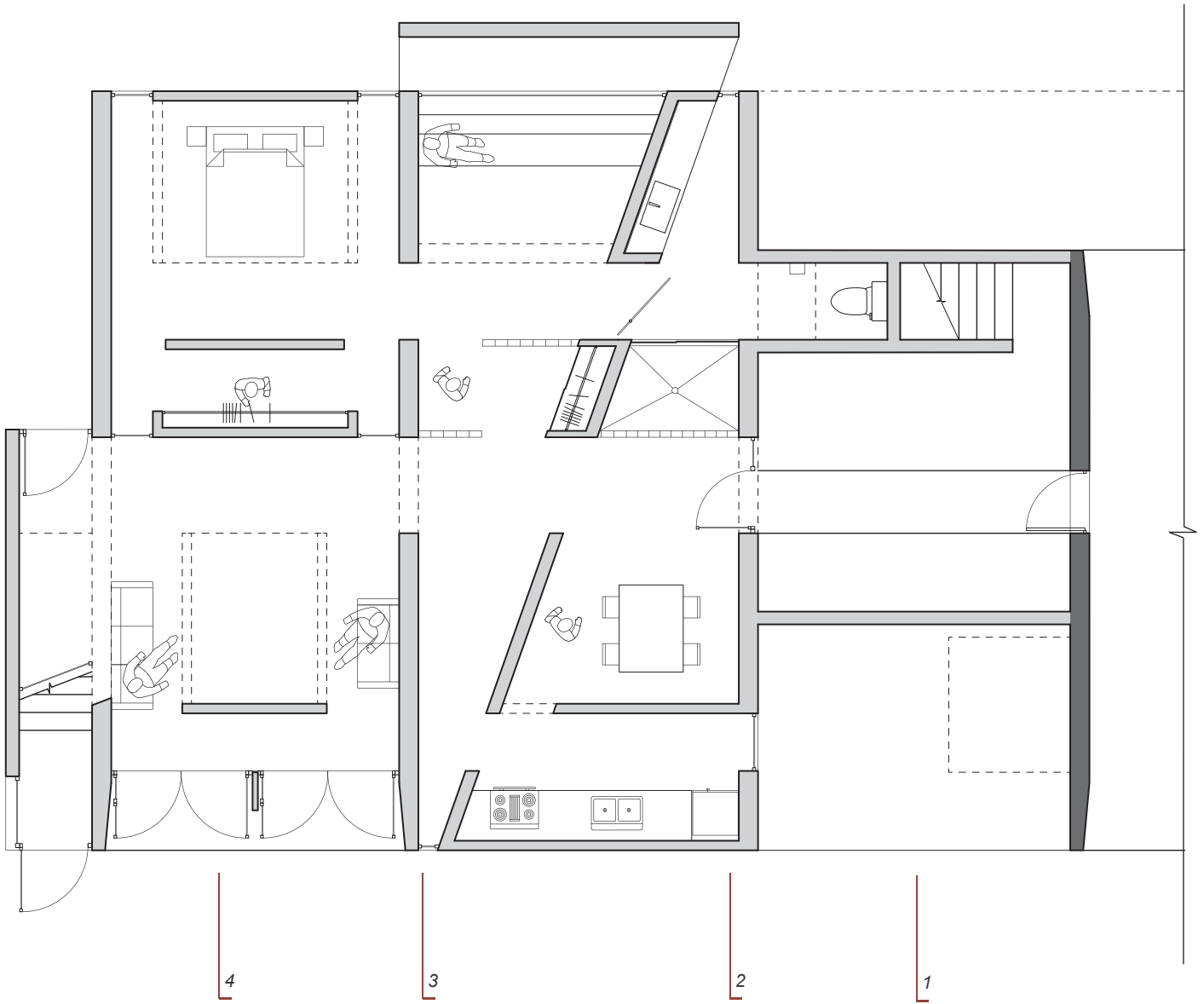


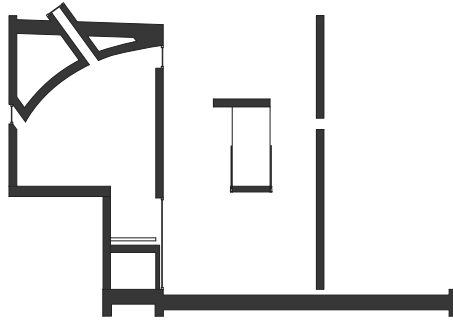
Fig. 112 Preliminary Ground Floor Plan, 1:100



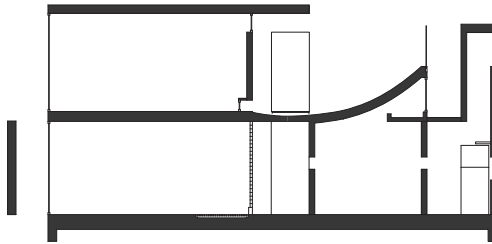
## THE INTRINSIC AGENT

*These drawings are rough sketches for reference only, as the 3D model was exclusively referenced during the design process.*

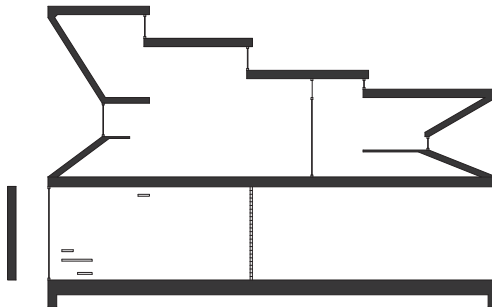
*Section 1*



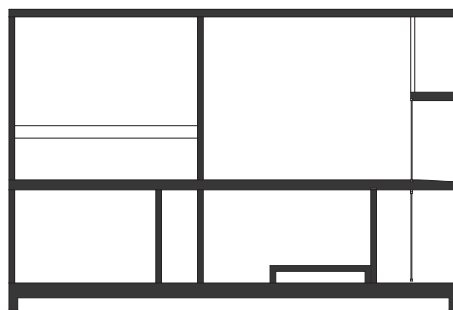
*Section 2*



*Section 3*



*Section 4*



**Fig. 113** Preliminary Sections, 1:200

# first render set

---

DIRECT TRANSLATION FROM PRELIMINARY  
PLANS

## THE INTRINSIC AGENT

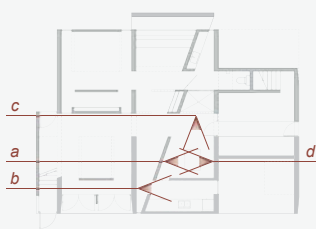
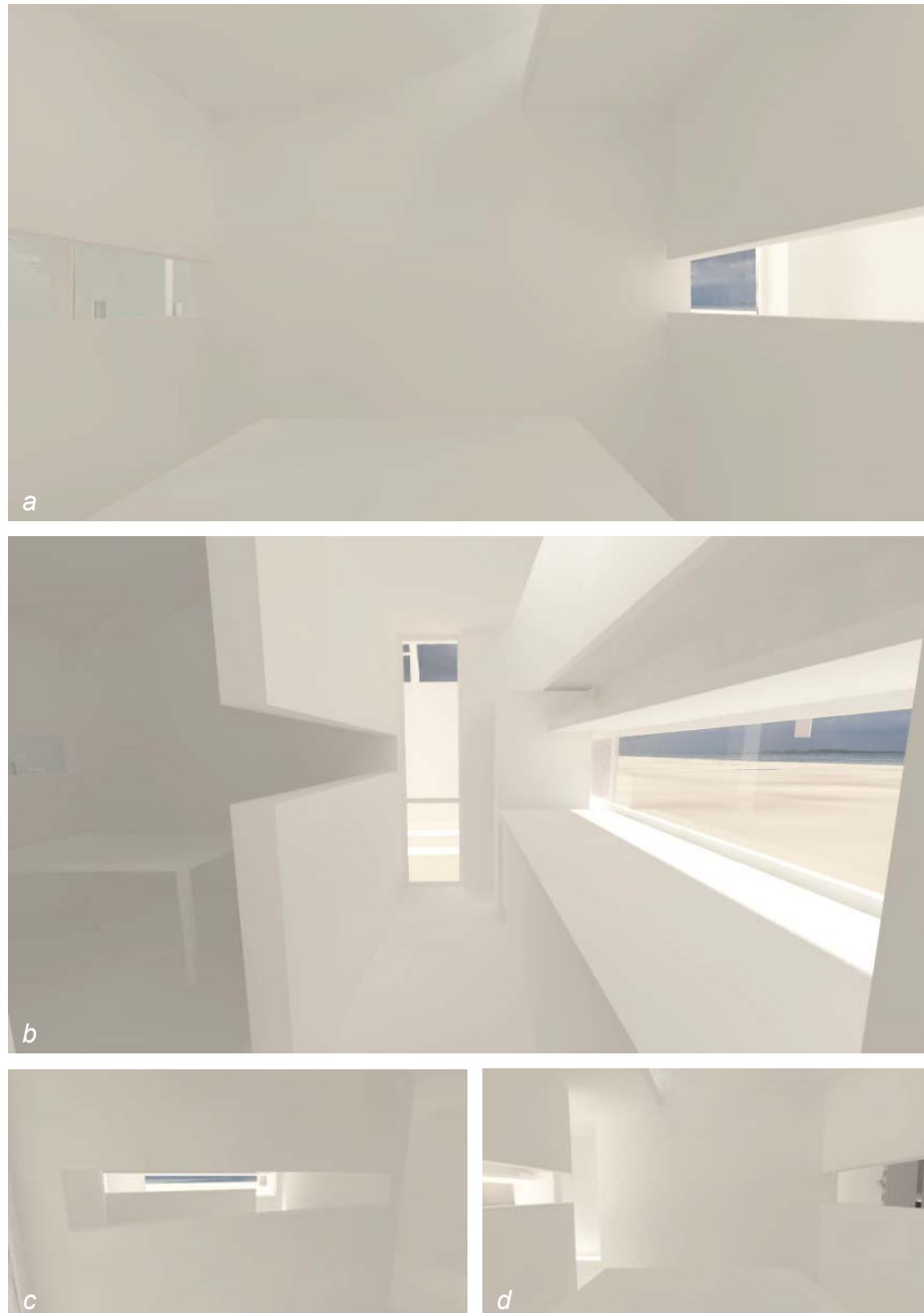
**Fig. 114** First Draft Kitchen and Dining Areas

a) View north from dining room at 10AM, 170621. Light effect from diffusing device is too weak, space appears too small.

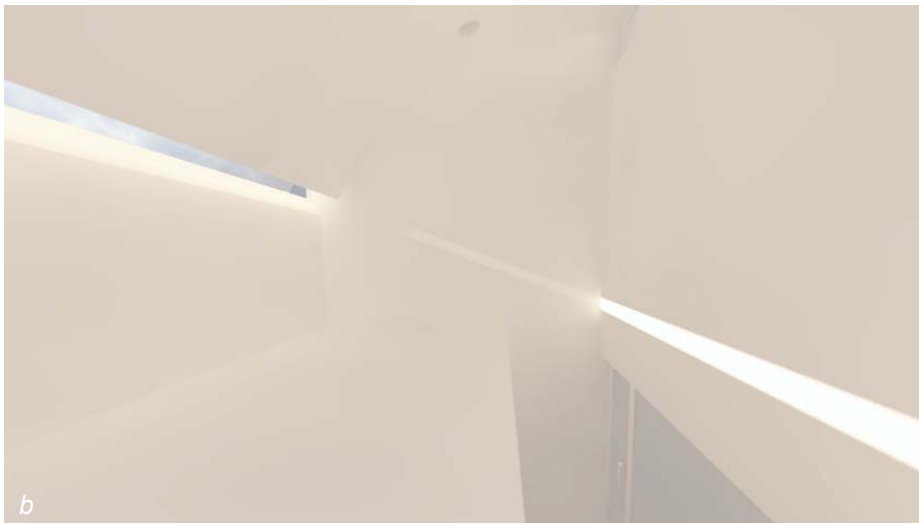
b) View north from kitchen area at 10AM, 170621. Optic device seems effective above shelving (top right). Adjacent dining area is comparatively too dark.

c) View east from entrance at 10AM, 170621. Layered framing devices restrict passage of light too much. Devices are positioned at the kitchen counter height, too low to be effectively observed by the viewer.

d) View south from dining area at 10AM, 170621. View showcases an awkward meeting of the east wall of the room with the entrance at its side (view b). The intersection of the wall and diffuser above is also aesthetically problematic (top left).



**Fig. 115** Key Plan, Ground Floor

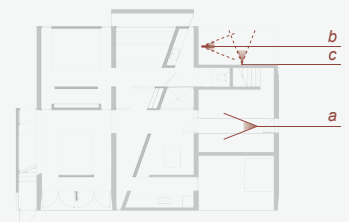


**Fig. 116** First Draft Entrance and Study

a) View south from reflecting pool courtyard at 5:45PM, 170621. View shows an unexpected bright area at the end of the main circulation axis. Layered receiving surfaces at the right appear as expected, and stairs desirably transfer soft light from study to courtyard area.

b) View north from study entrance at 5:45PM, 170621. Frame device functions as expected, with edges of the roof profile sufficiently acting as secondary sources as evidenced by light pooling at the base of the west wall (bottom left).

c) View west from near top of stairwell to study at 5:45PM, 170621. Position of frame appears as desired, with the view of the sky obscured upon approach, but visible from working surface (not shown).



**Fig. 117** Key Plan, Ground Floor



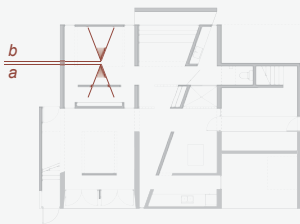
## THE INTRINSIC AGENT

**Fig. 118** First Draft Bedroom

a) View east from bed (not shown) at 5:45PM, 170621. Image appears to indicate that the full length of the ceiling of the cavity can act as a secondary source of light within the space. Note: this condition may only occur during the summer months when the sun sets in a sufficiently low and westerly position.



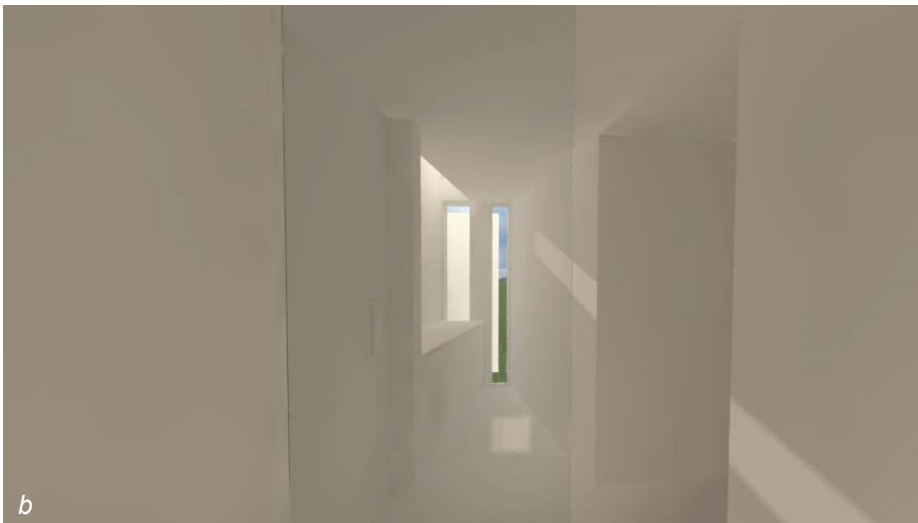
b) View west in bedroom at 5:45PM, 170621. Position of opening is intended to allow a limited amount of light to enter the space via the diffusing mechanism of the cavity. Light appears to be too diffuse, space appears flat.



**Fig. 119** Key Plan, Ground Floor



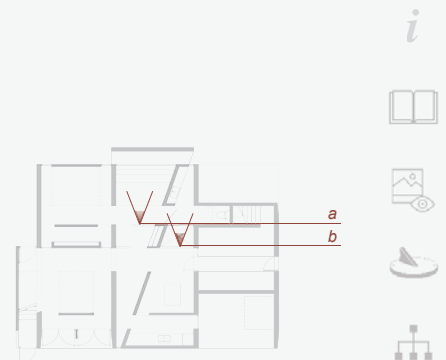
## DESIGNING WITH LIGHT



**Fig. 120** First Draft Reading Area and Bathroom

a) View west to reading area at 5:45PM, 170621. Diffuser sits outside a glass enclosure, reflecting and scattering light into the space in order to facilitate reading.

b) View west from shower at 5:45PM, 170621. Light appears to be quite soft and desirable. Light in vanity area from diffuser above (Fig. 120a) appears to serve the purpose of personal grooming, but the adjacency of the millwork and two frame devices is architecturally problematic. Frame at end of space raises privacy concerns.



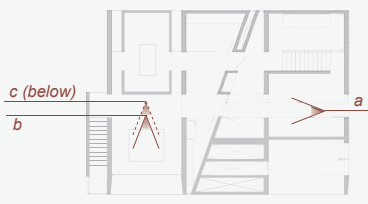
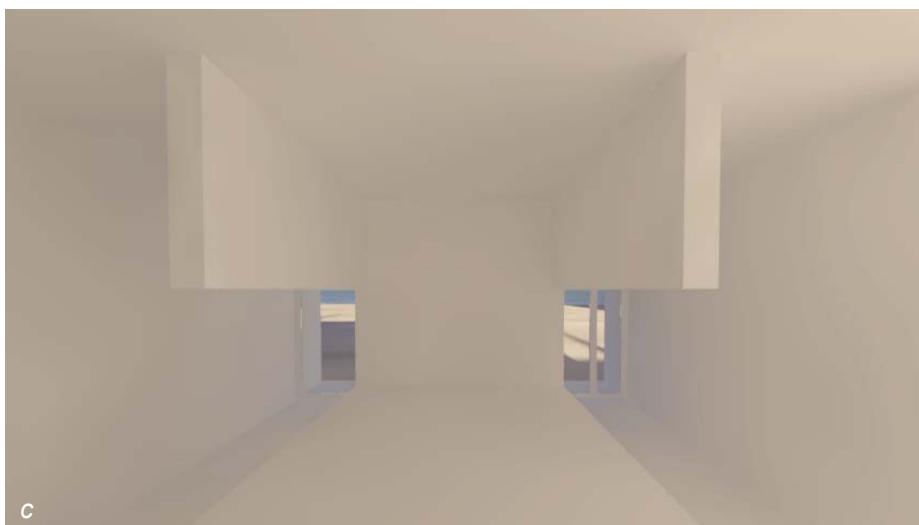
**Fig. 121** Key Plan, Ground Floor

**Fig. 122** First Draft Bridge Over Reflecting Pool

a) View south from bridge between new and existing public library areas at 5:45PM on 170621. Light and view is satisfactory. Potential for a variety of light effects, including the generation of specular images along the glass barrier is promising.

b) View east to work area at 5:45PM, 170621. Space is as of yet undeveloped, new HDRI required to reflect seashore site. Water shown is a Rhino object that has a stock V-Ray material applied to it. Goals for space include a large opening through which to view the Bohai Sea and a diffusing mechanism by which to finish and refine 3d printing projects.

c) View east to living room (below work area) at 5:45PM, 170621. Device shown was developed in plan. In this design, one occupies the illuminated slits to either side of a raised (platform table) and framed (half walls from ceiling) interior area. Design was developed in consideration of the need for some element of privacy, but dominates the space, hindering circulation and ease of use.



**Fig. 123** Key Plan, 2<sup>nd</sup> Floor



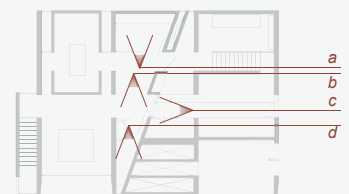
**Fig. 124** Tentative Plans

*a) View west to makerbot station at 6PM, 170320. Extended diffuser device from bathroom below (developed for privacy) is a very intrusive volume in this space. Openings (shown left and very right) detract from recessed diffusing device (center).*

*b) View east from makerbot station at 9AM, 170320. Position of roof segments with respect to areas below (especially with respect to the laser room at center of image) needs work. Frame device should take place of transom.*

*c) View south from end of bridge to maker space at 5:45, 170621. View doesn't show anything of significance.*

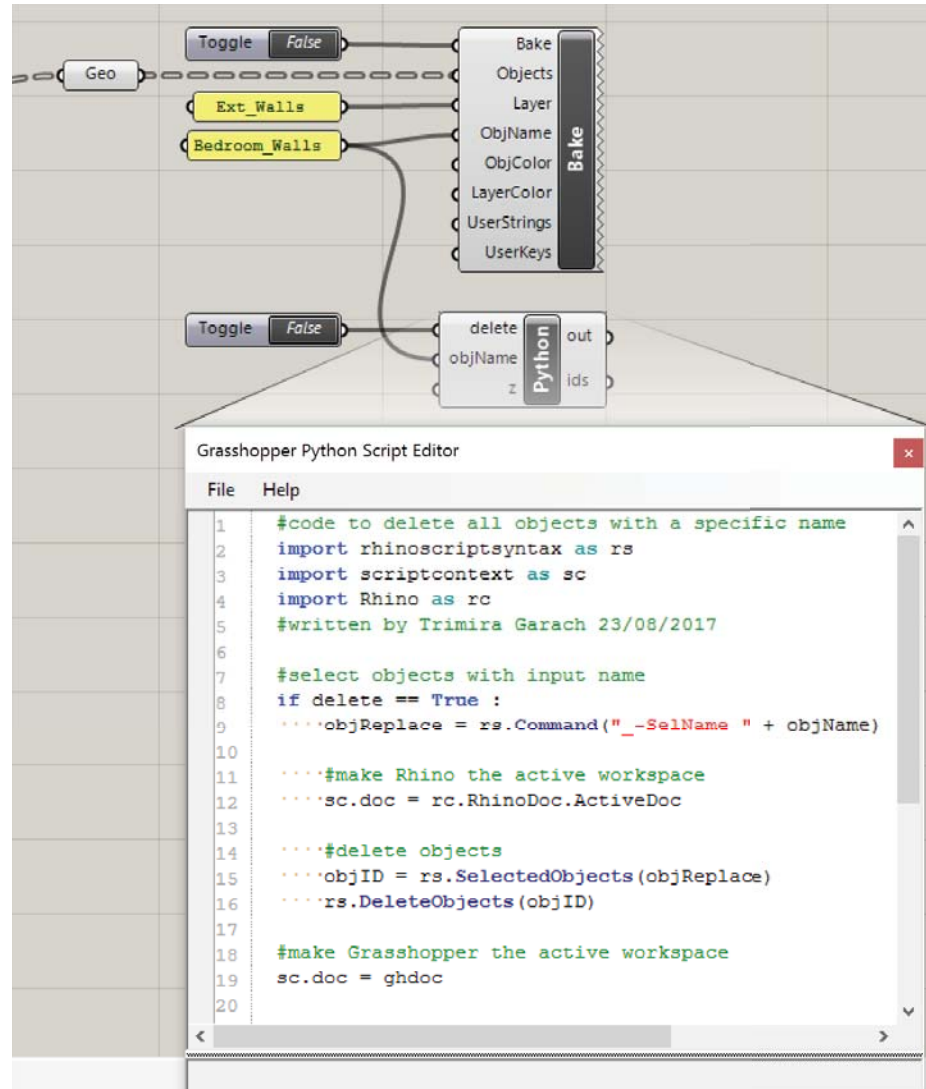
*d) View east to laser room at 5:45, 170621. Pinched design closes the space too much, providing a focused view but a darkened work area. Work surface that continues from the inward sloping profile is most promising element.*



**Fig. 125** Key Plan, 2<sup>nd</sup> Floor

**Fig. 126** Expediting Visualisation

Once a designer has developed a parametric definition that generates a desired geometry, the Grasshopper geometry must be "Baked" or copied as Rhino geometry that can be subsequently rendered and drawn. Baking the geometry, selecting a designated layer, grouping the objects, rendering them, and then deleting them in order to generate a new version can slow down the process of arriving at a tuned solution. A group of components was assembled and developed in order to alleviate the inconvenience of this process. The first part involves a workflow component from LunchBox,<sup>1</sup> a plugin for Grasshopper. The component allows the user to bake objects to any Rhino layer with any object name. I have supplemented this component with a Python component of my own that selects and deletes the objects that have been baked and named. This workflow shortcut has been an instrumental part of the process of evaluating the effects of light produced by parameterised optic devices.



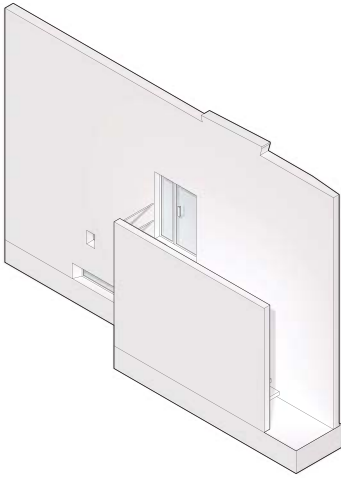
<sup>1</sup> Lunchbox was developed by Nathan Miller. The plugin may be found on Food4Rhino, McNeels's plugin community service. LunchBox is a free plugin that can be found at <http://www.food4rhino.com/app/lunchbox>, accessed for use August 23, 2017.

# algorithmic tuning

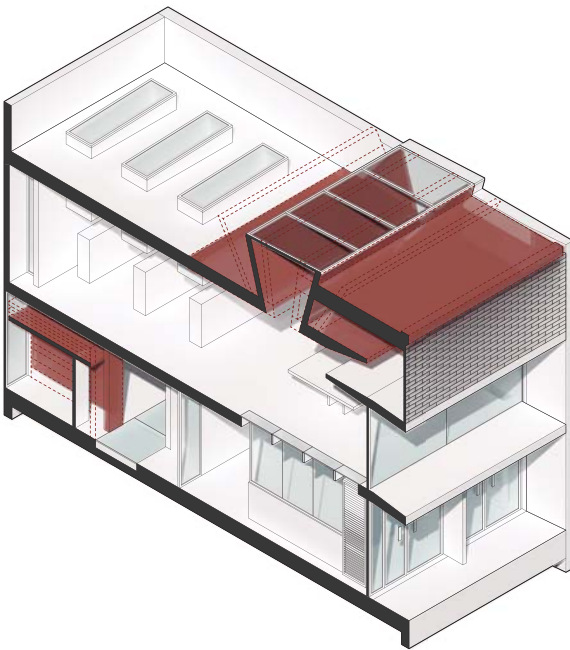
---

SINGLE- OR MULTIPLE-PARAMETER  
MANIPULATIONS

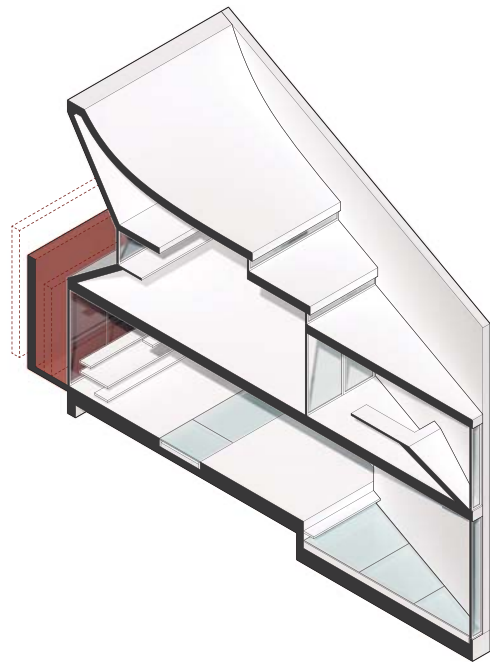
THE INTRINSIC AGENT



Section 5 (South Facade)

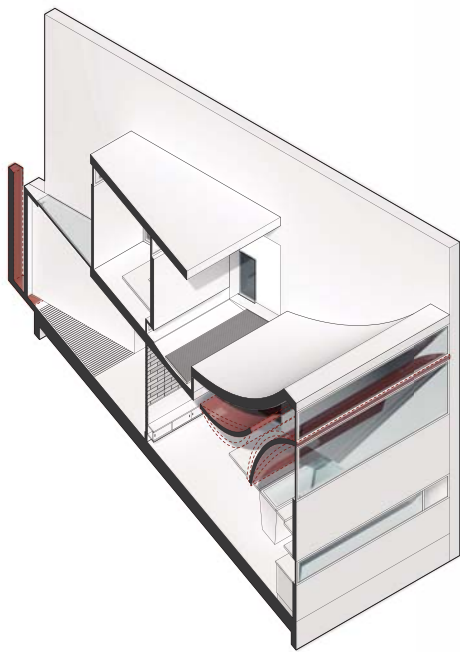


Section 4  
(Parameterised design solutions shown in red)



Section 3

Fig. 127 Axonometric Expanded by Section

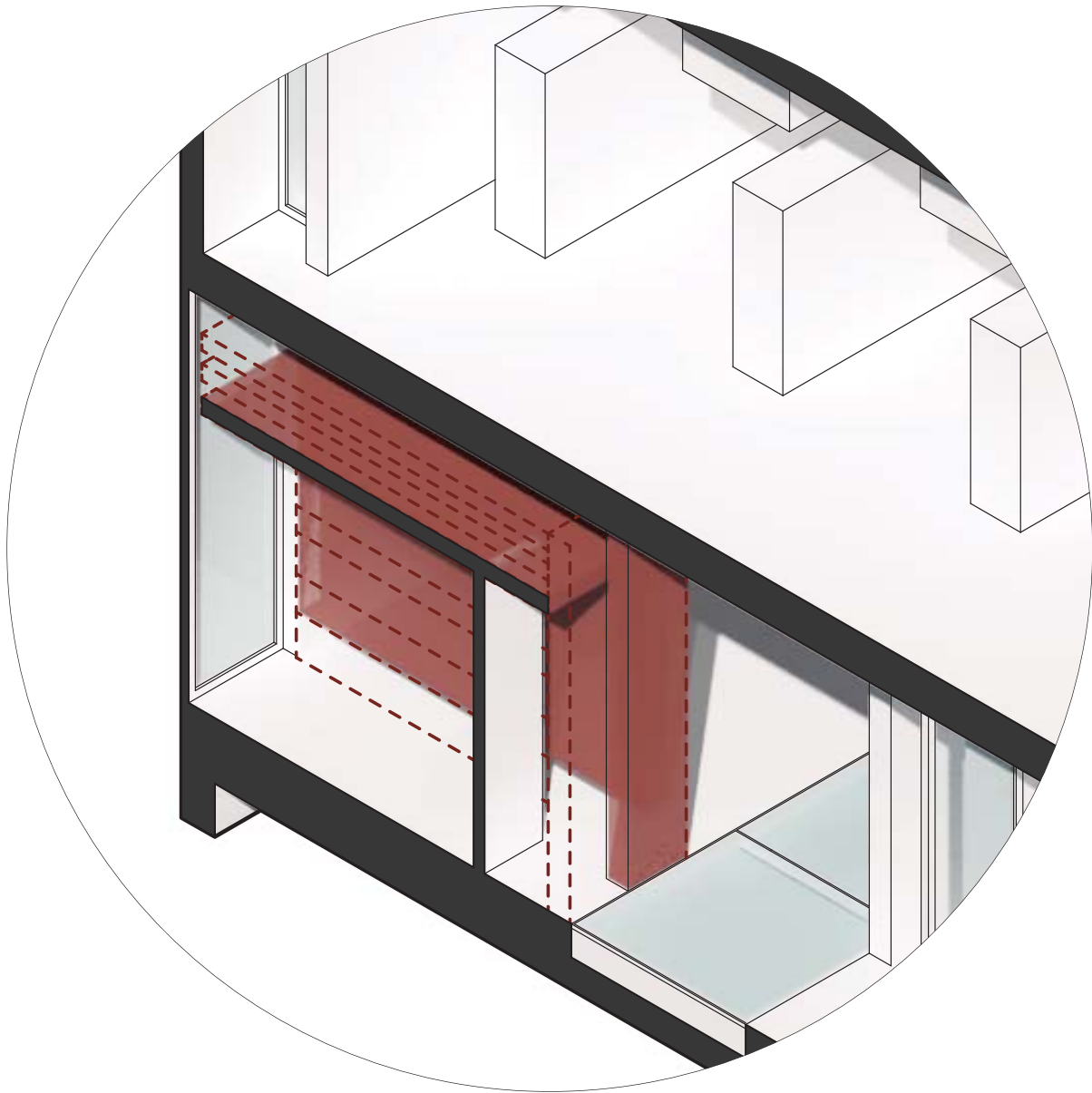


Section 2



Section 1

THE INTRINSIC AGENT





# bedroom diffuser

Channels on either side of the bedroom create pools of light on the floor that act as *secondary sources* in the space. Flat planes near the top of the cavity reflect light to the ceiling above, rendering it a soft, tertiary source.

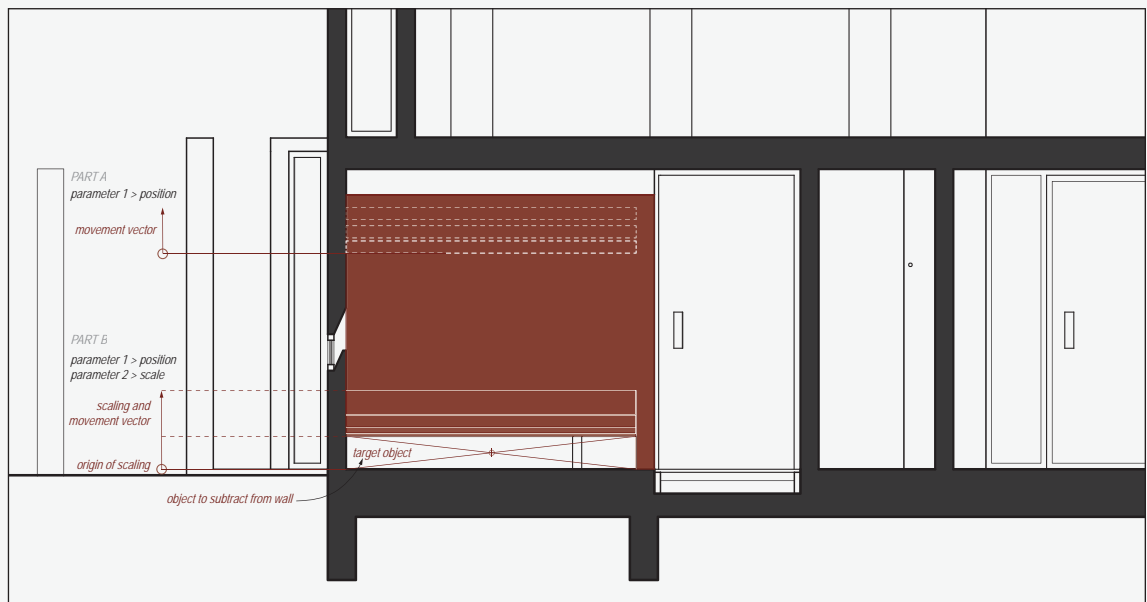
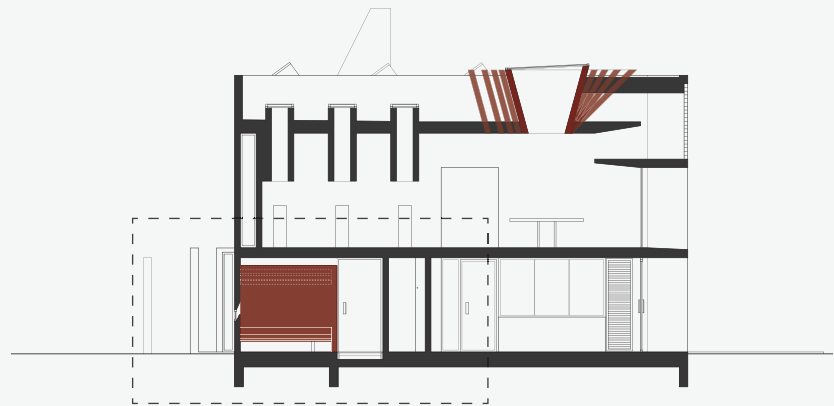


Fig. 128 Bedroom Diffuser - Diagram of Parameters

# THE INTRINSIC AGENT



**Fig. 129** Bedroom Resolution

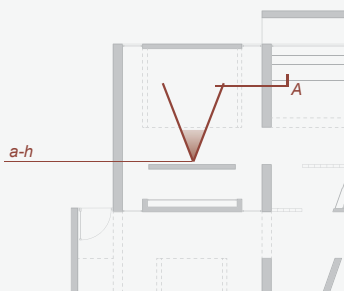
*a) first - desired effect of diffuse light entering the space away from eye level is not apparent*

*b) move opening to floor in order to create pools of light (in the form of a secondary surface) at the feet of the occupant*

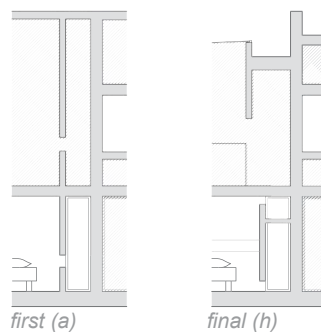
*c) reduce size of opening to conceal frame behind*

*d) create reveal at top of diffuser to use ceiling as secondary source*

*e) changing sun position has only minor effect on improving the luminous effect*



**Fig. 130** Ground Floor, Bedroom



**Fig. 131** Section A Comparison

## DESIGNING WITH LIGHT



*f) inserting shelf/surface in cavity (which becomes a secondary surface) immediately improves the effect*

*g) cap the ends of the cavity in order to improve privacy of the space*

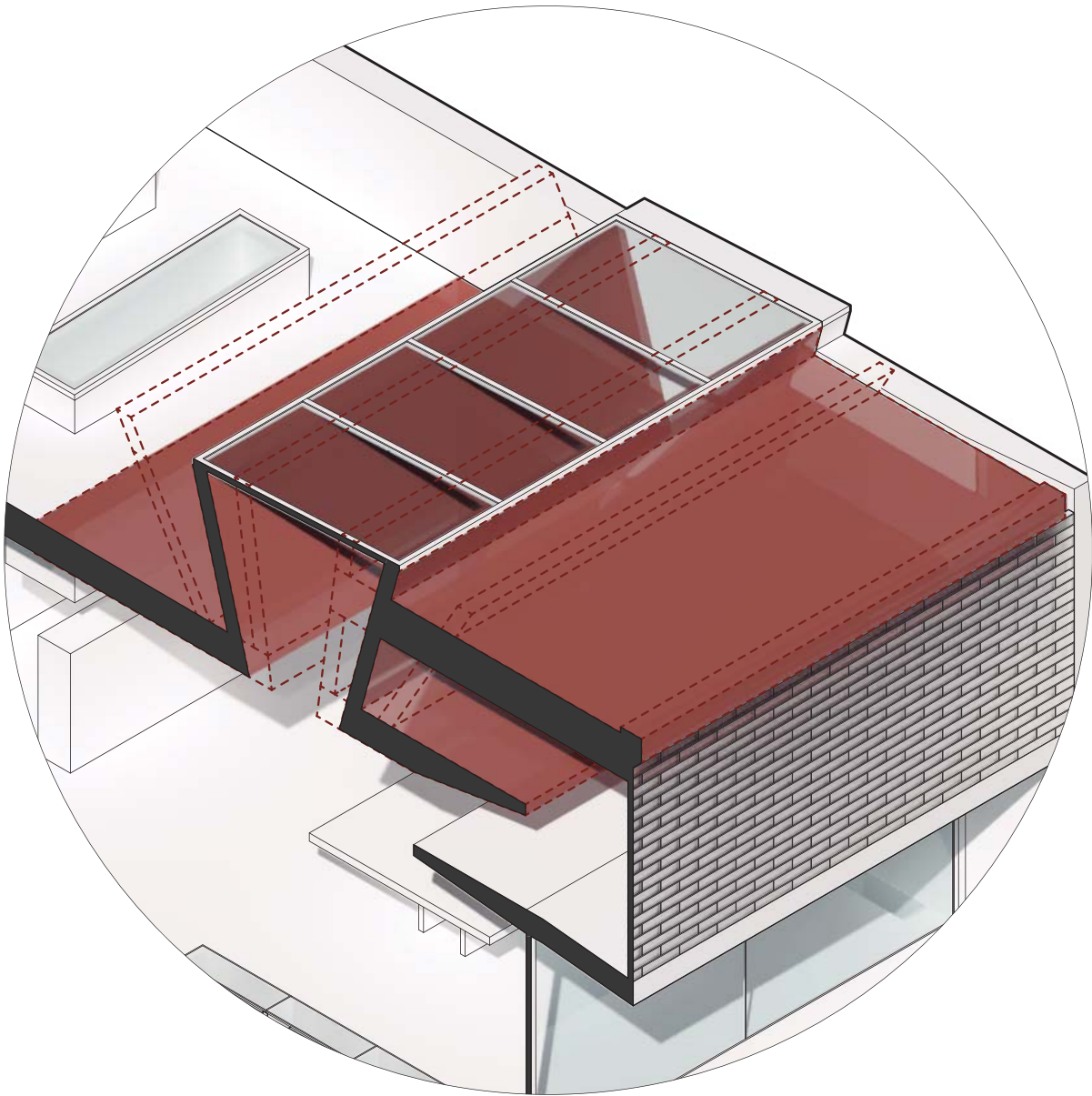
*h) tentative final - cavity behind headboard provides an accent and point of focus*



*i*



THE INTRINSIC AGENT



# work area diffuser

The work area diffuser utilises a funnel shape to capture as much light as possible in a light chamber that opens to the work surface below. It mitigates the harshness of direct light entering the space.

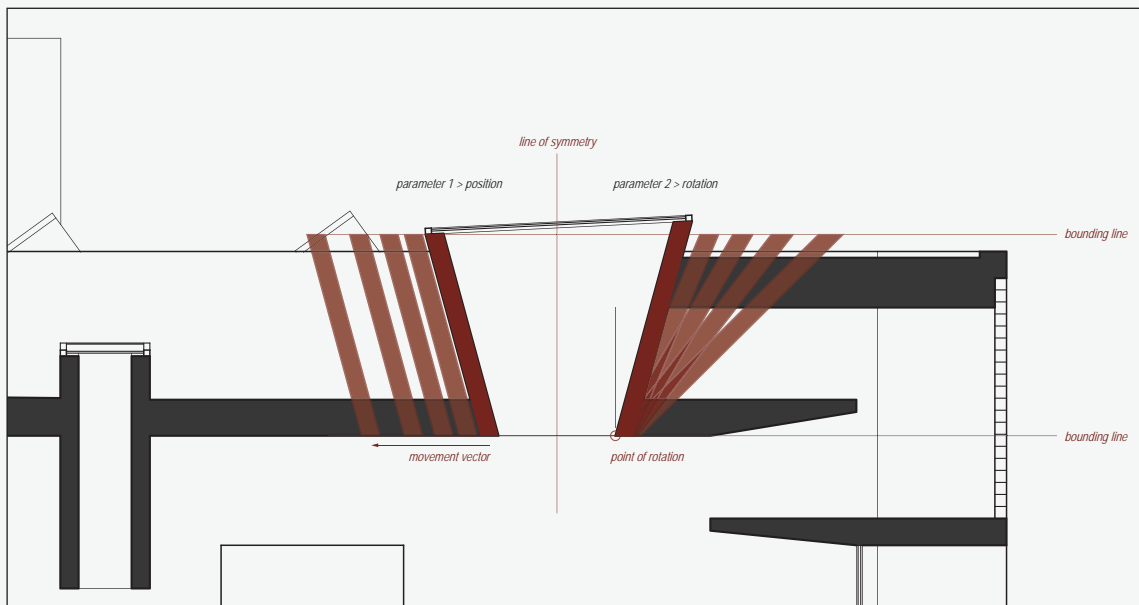
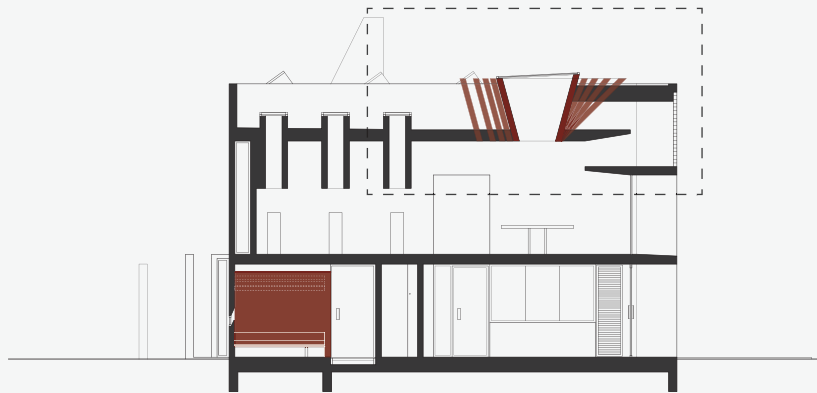


Fig. 132 Work Area Diffuser - Diagram of Parameters



# THE INTRINSIC AGENT



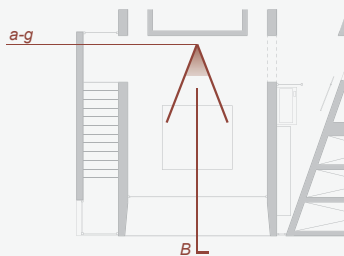
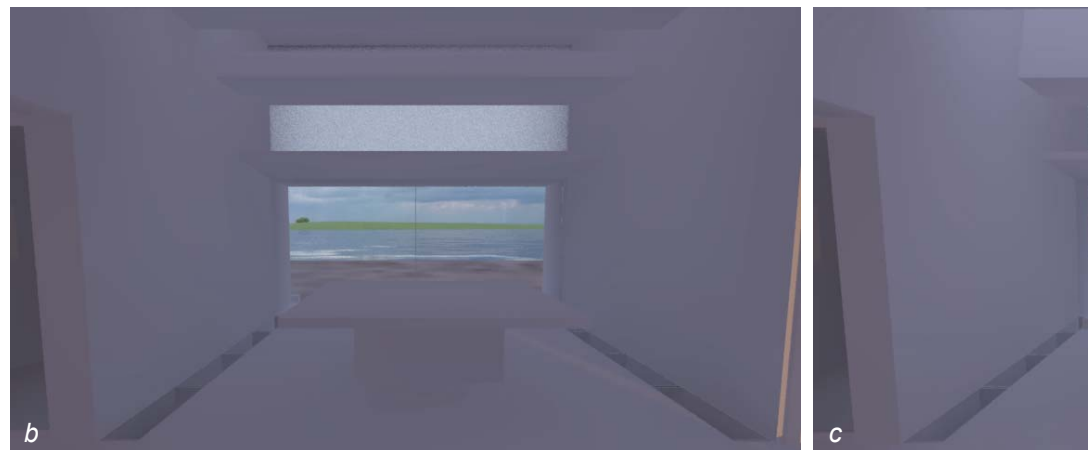
**Fig. 133** Work Area Resolution

a) first - initial view includes roof profile that is open to the frosted block behind (shown as solid here)

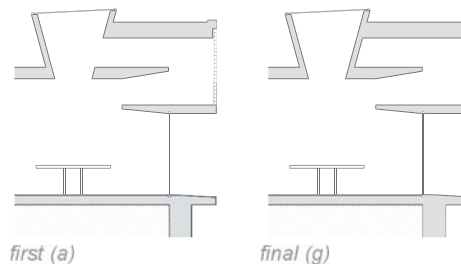
b) low light situation showcases the amount of light reaching the work table surface

c) covering the opening (top of image) significantly improves the brightness of the surface

d) HDRI replaced with a more suitable beach scene - water object/material blends into the environment behind



**Fig. 134** 2<sup>nd</sup> Floor, Work Area



**Fig. 135** Section B Comparison



*e-g) matrix of nine renders illustrating two changing parameters, various combinations of three opening widths and and three slopes (shown in Fig. 132)*

*e) opening of 0.24m*

*f) opening of 0.72m*

*g) opening of 0.48m*

*x1) slope angle of 15°*

*x2) slope angle of 30°*

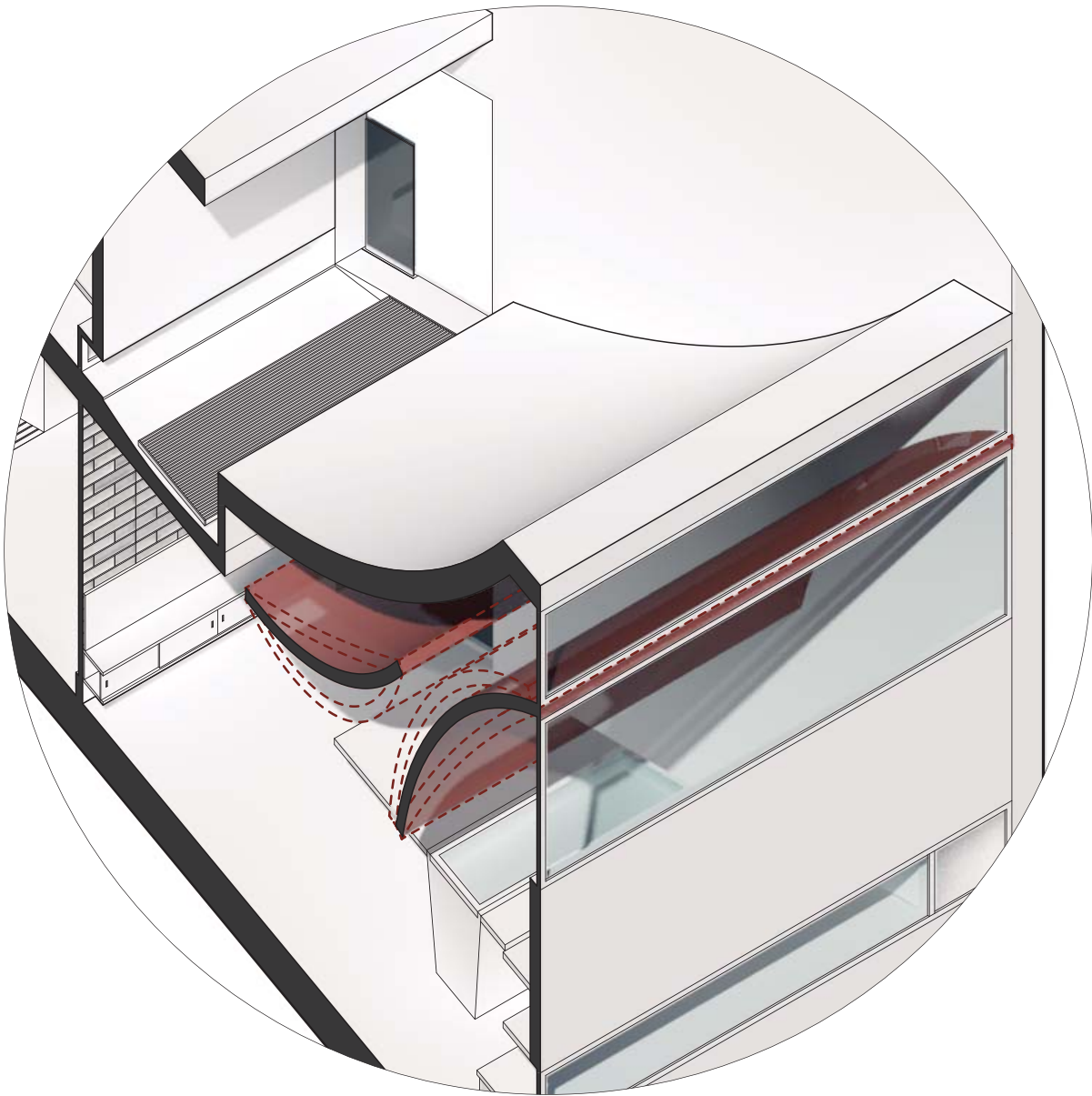
*x3) slope angle of 45°*

*g2) tentative final - selected version*

*i*



THE INTRINSIC AGENT





# kitchen diffuser

This diffusing mechanism helps to distribute and direct light to specific work surfaces in the kitchen and dining spaces. The divided *frame* at the sea-facing end of the space delivers light to the curved, *diffusing* surfaces that then transfer light to the working and dining portions of the large table below.

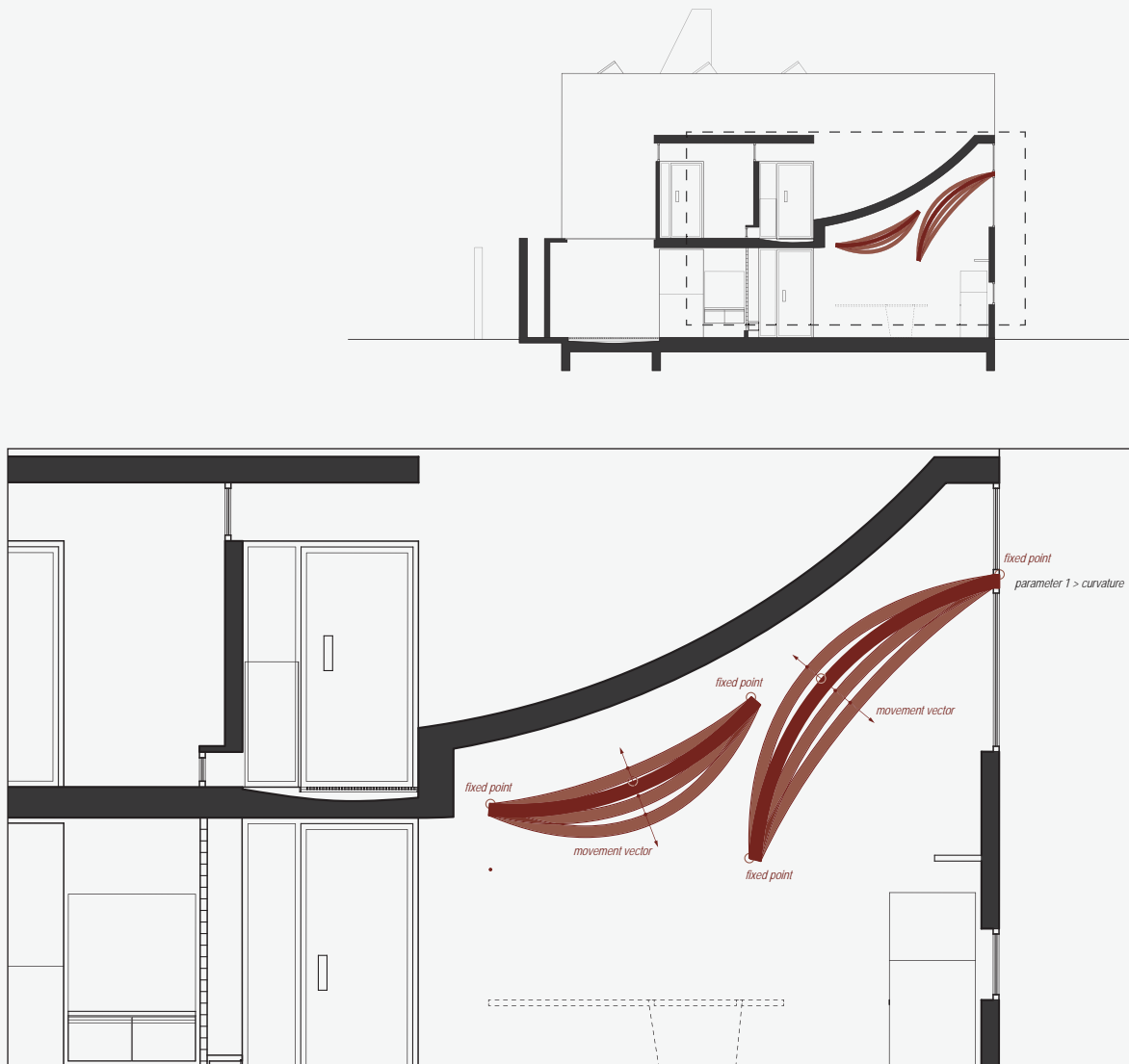


Fig. 136 Kitchen Diffuser - Diagram of Parameters



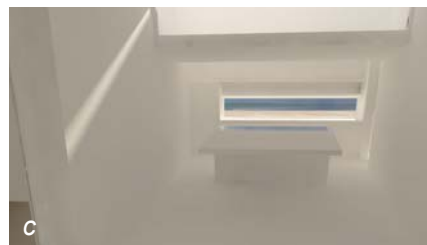
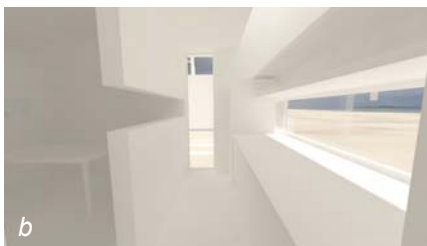


**Fig. 137** Kitchen/Dining Resolution  
*a) first - kitchen and dining areas separated by a wall, with a frame and diffuser respectively serving the spaces*

*b) alternate view of initial design*

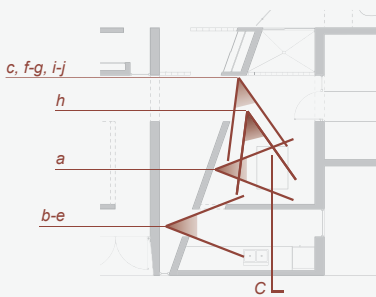
*c) second iteration of the diffuser attempts to capture light from both east and west (by functioning as a frame for eastern light and a diffuser for western light). device is successful as a lightbox, but does not appear to adequately transfer light to the space below*

*d) alternate view of second iteration*

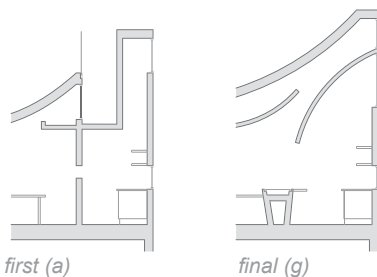


f1

f2

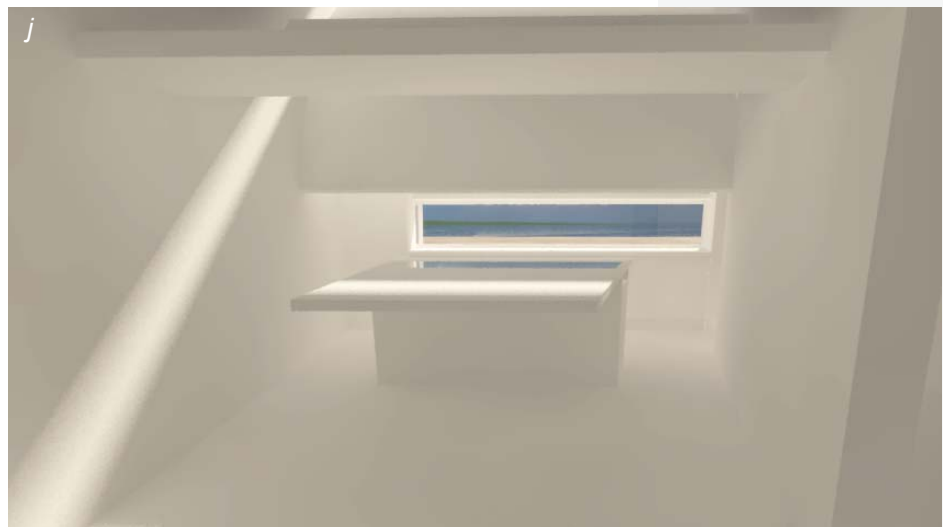
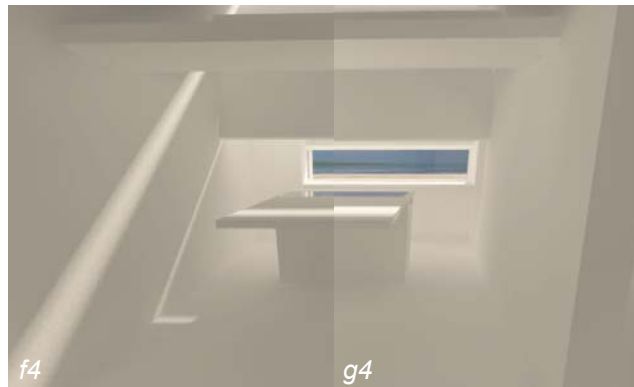
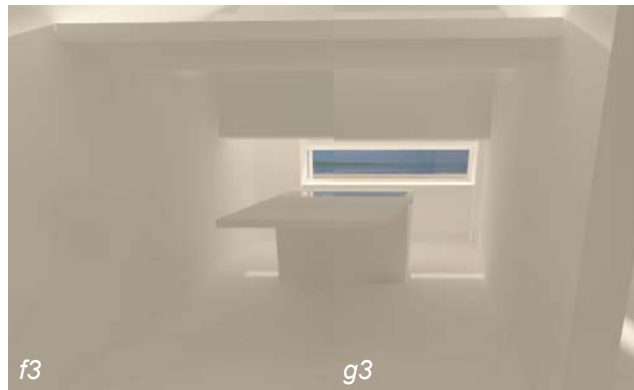
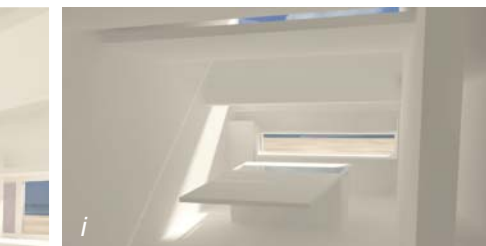
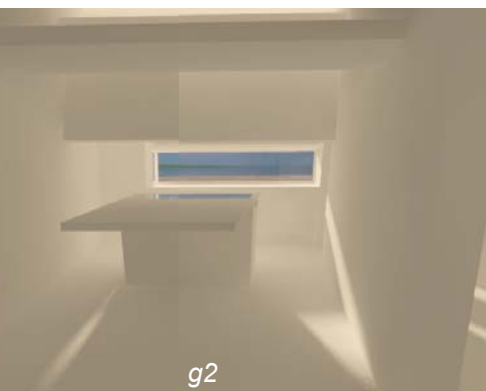
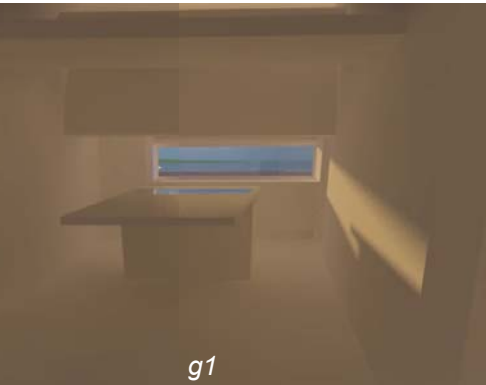


**Fig. 138** Ground Floor, Kitchen/Dining



**Fig. 139** Section C Comparison

## DESIGNING WITH LIGHT



e) third iteration uses a curving roof profile as a diffuser that directs light to the working portion of the surface below - lower edge of profile is too low

x1-x4) renderings in hourly increments between 7AM and 10AM

f-g) testing two different curvatures using the parametric definition, the g series diffuses light more effectively, producing a glowing effect

h) close-up view from dining table shows effect of bands of light moving across the working surfaces

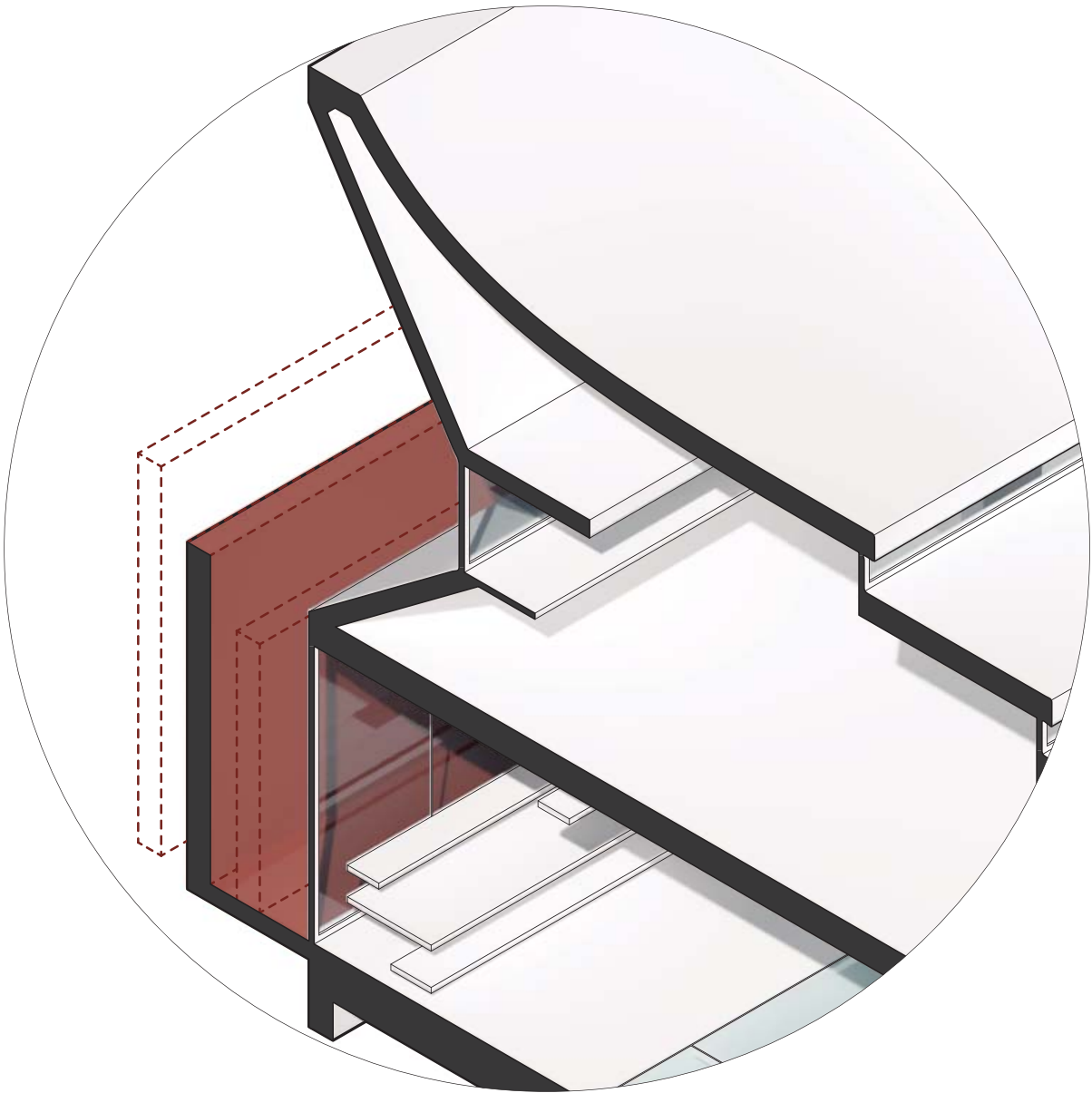
i) shows relationship between the curving profiles

j) tentative final - shows the illuminated working area of the kitchen and softer light in dining area

i



THE INTRINSIC AGENT



# reading area diffuser

This optic device uses an exterior wall as a *secondary source* of light. The exterior wall fills the entire opening at the end of the small library, producing soft, diffuse light for reading.

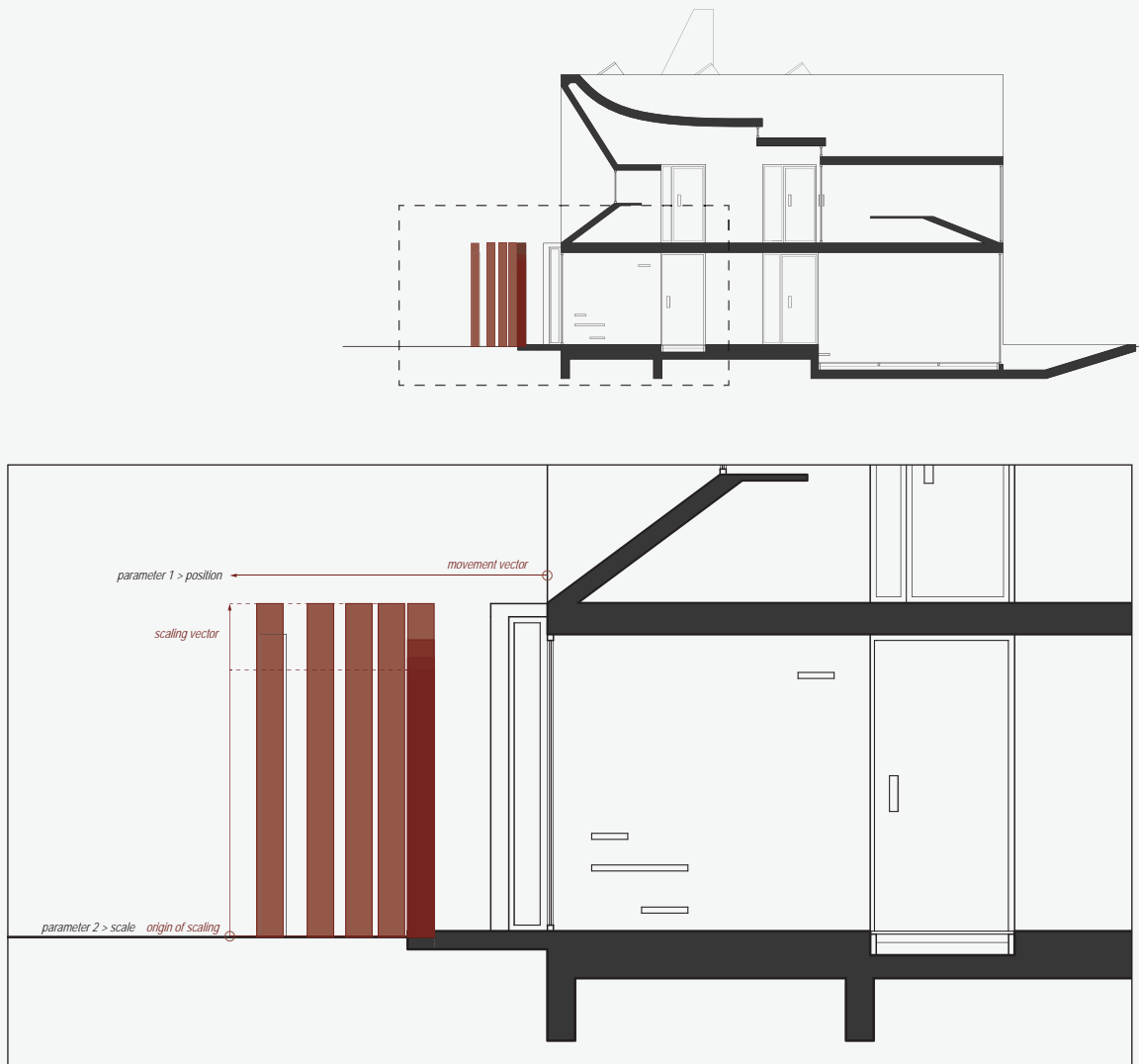
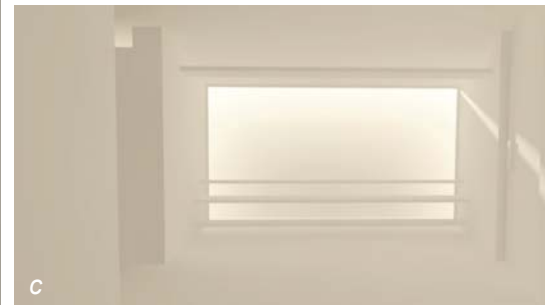


Fig. 140 Reading Area Diffuser - Diagram of Parameters

# THE INTRINSIC AGENT



**Fig. 141** Reading Area Resolution

a) first - diffusing wall needs to be extended to cover visible sky

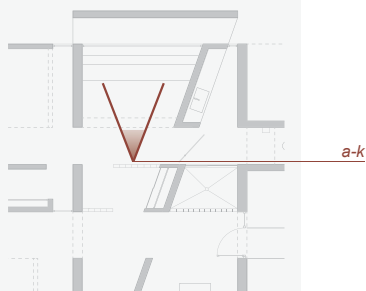
b) change sun position to late afternoon

c) diffuser satisfactorily fills opening

d) parameterisation of distance of wall from glass fill, wall at 0.5m

e) wall at 1.0m

f) wall at 1.25m



**Fig. 142** Ground Floor, Reading Area

Note: no major sectional change

## DESIGNING WITH LIGHT



*g) introduce shower opening (visible at right of opening), visibility needs to be minimized*

*h) shower opening affects distribution of light on the diffuser surface*

*i) pull back end of shower from the diffuser wall, leaving a gap and decreasing the impact of the obstruction*

*j) increase gap*

*k) introduce glass floor element that produces a specular image of the diffuser and emphasizes the presence of the secondary, private corridor*

*i*







# geometric tuning

---

MANUAL GEOMETRY MANIPULATION

THE INTRINSIC AGENT



a) first - sink/millwork is recessed into a diffuser that goes up to the second floor. tectonic resolution is difficult

a1) view from outside - very undesirable

b) pulled back wall in order to conceal the frame of the diffuser - still unsuccessful

c) shows another variation, that lowers the ceiling of the diffuser to the first level so as not to disrupt the makerbot station above

d) position of sink and shower reversed in order to eliminate the need to cut out and push back the wall - deep fins (screen device) introduced to improve privacy of space, result is much too dark

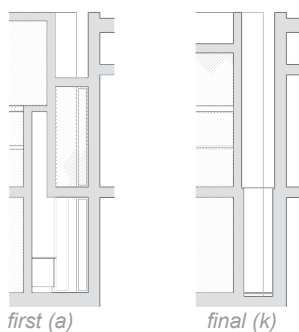
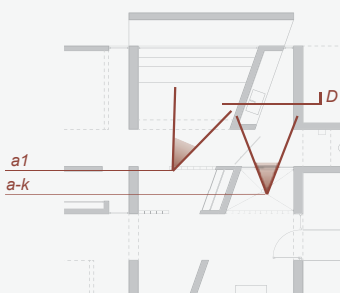


Fig. 143 Ground Floor, Bathroom

Fig. 144 Section D Comparison

# shower

Fig. 145 Bathroom Resolution

e) density of screen decreased, result still too dark

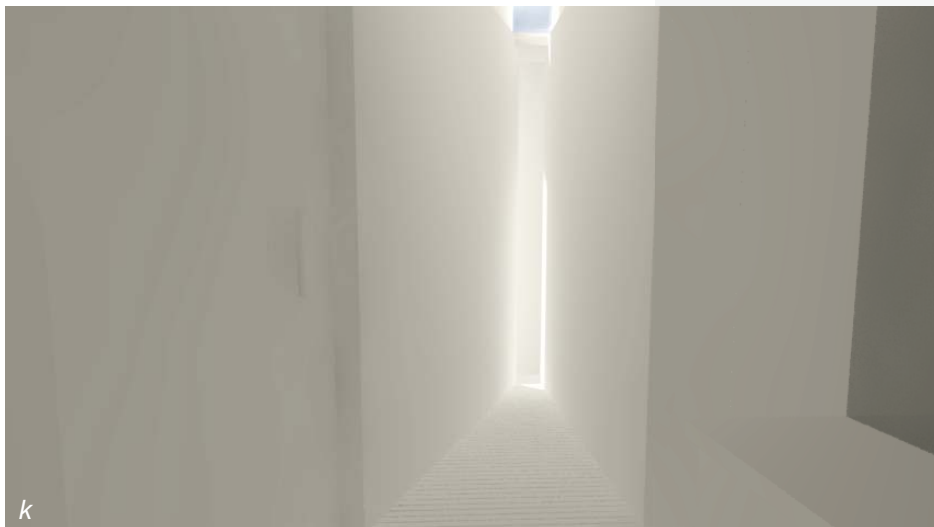
f) area above shower removed and replaced with a seamless skylight spanning from wall to wall, frame removed from end of shower, space is much more pleasant but also lacks focus that can interact with the steam of the shower

g) view later in the day

h) reading area wall and right wall of shower extended to meet, forming a diffusing mechanism for southern light

i) shower wall pulled back from reading area wall in order to minimize the impact on the reading area diffusing mechanism

j-k) tentative final - distance of end of shower adjusted to conceal the frame behind the left wall



*i*



THE INTRINSIC AGENT

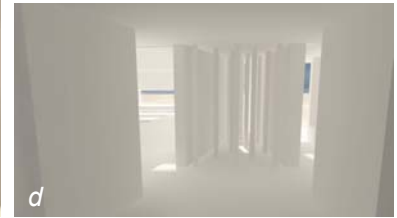
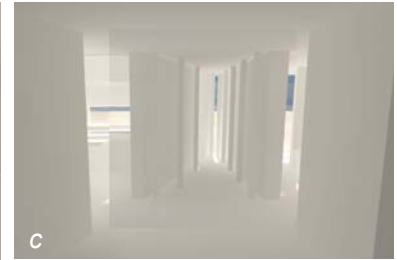


a) first - single frame at the end of the narrow space, adjacent opening to kitchen area. at this point the use of the space is ambiguous

b) testing the space as a pantry that is accessible only from kitchen (opening shown in image a)



c) pivoting to a meditation space - here attempting to use a deep screen to create a layered simple image, frame does not seem to allow enough directional light into the space to produce the desired archetype of effect



d) screen density increased



e-g) attempts to create an occupiable diffusing chamber by thickening the perimeter, sloping the seating plane to make it a secondary source - trials do not engender desired (cont'd)

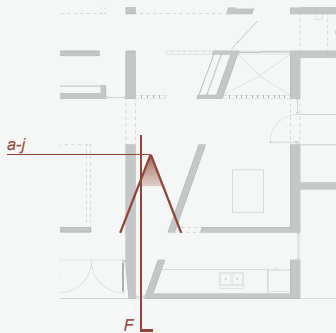


Fig. 146 Ground Floor, Meditation Space

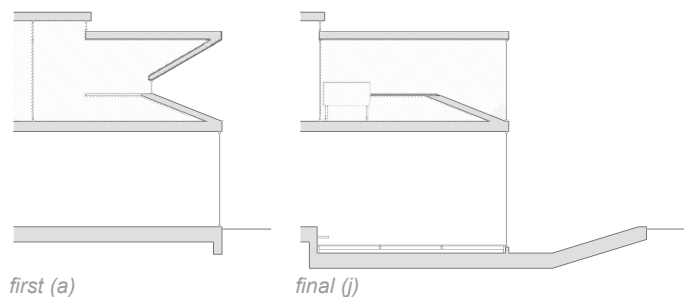


Fig. 147 Section F Comparison

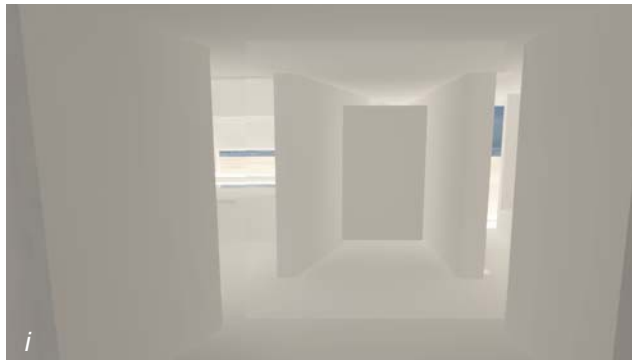
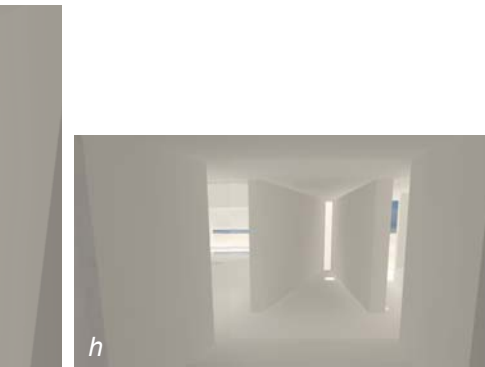
# meditation space

Fig. 148 Meditation Space Resolution

*effect - space seems short, out of place, and uninviting*

*i) poses an attempt to utilise the architectural lighting design principle of hierarchy - using the position of an object with respect to the light source to create a silhouette, thereby creating a diffusing mechanism through the obstruction of the light source. back side is intended as pantry for kitchen, front side (shown) to be used as a coat hanging wall or similar*

*j) tentative final - not being satisfied with the resolution of the space as shown in previous render, I observed that the primary issue with the space was its limited height - the proportion of the slit was incorrect. having explored raising the ceiling in the bathroom experiment (a problematic scenario), I instead had the idea to lower the floor in the area, creating a threshold to the meditation area. the glass floor additionally extends the perceived height of the opening through the creation of a specular image - visible because of the distant, low angle from which it will be viewed from the reading area. this rendering is the first after modeling the solution.*



*i*



# THE INTRINSIC AGENT



a) first - doors copied from main building to present some continuity in east facade. device shown (idea to occupy, instead of draw from, the diffuser) dominates the room.

b) remove device, preserve doors, simple images (also present in reading room of main building) look good

c) pull second floor plate away from walls

d-e) add pseudo-structural elements in cavity and increase array

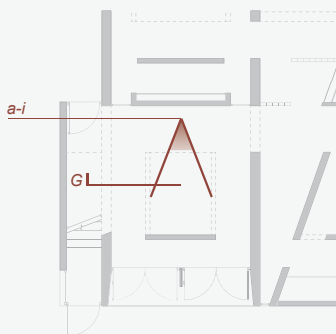
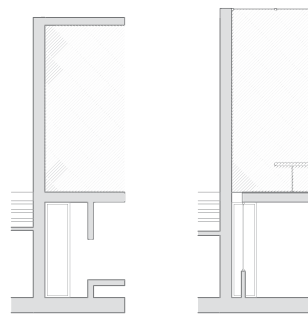


Fig. 149 Ground Floor, Living Room



first (a) final (i)  
Fig. 150 Section G Comparison

# living room

Fig. 151 Living Room Resolution

f) layer glass receiving surface over board formed concrete walls - bringing the sea view into the room (as specular image). layers appear too close together. (wall temporarily added as a media wall/privacy tool, but removed in favour of another, less obstructive solution)

g) glass surfaces moved to edge of opening of floor plate above. light effect occupies space between wall and glass layer

h) HDRI updated - glass receiving surface partitioned into low concrete wall with glass frame above in anticipation of furniture. screens introduced and folded at north and south end of room

i1-2) tentative final - screen devices folded (i1) and expanded (i2). slats of screen increasingly rotated toward the horizontal at the horizon. screening of view more effectively shown in final, rendered image. rotation of slats completed in Grasshopper



# laser cutting room

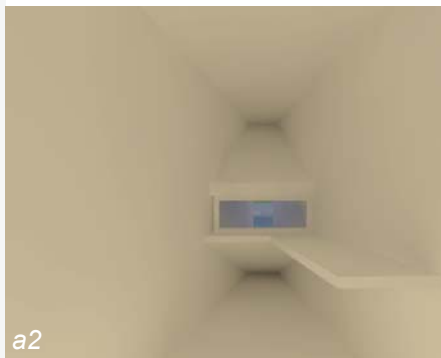
Fig. 152 Laser Room Resolution



a1

a1-2) first - openings not lined up, pinched facade at end of laser room too small

b1-2) tentative final - position of openings corrected. ceiling remains flat and frame is pushed to end of room.



a2



b1

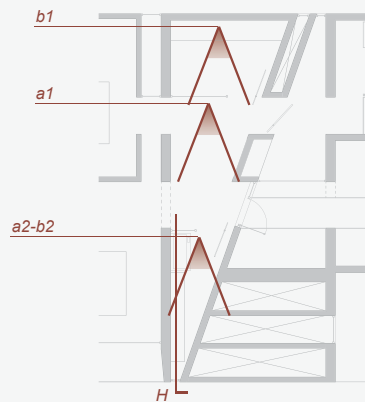
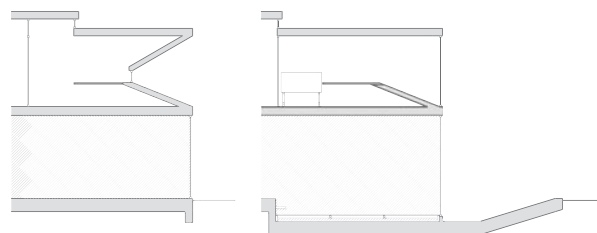


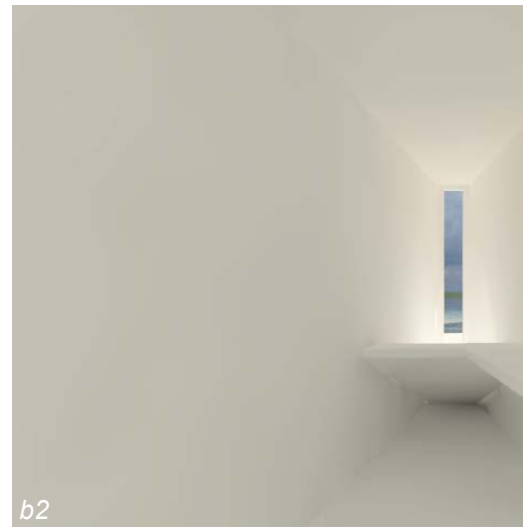
Fig. 153 2<sup>nd</sup> Floor, Laser Area



first (a1)

final (b2)

Fig. 154 Section H Comparison



b2



# maker area

Fig. 155 Maker Area Resolution

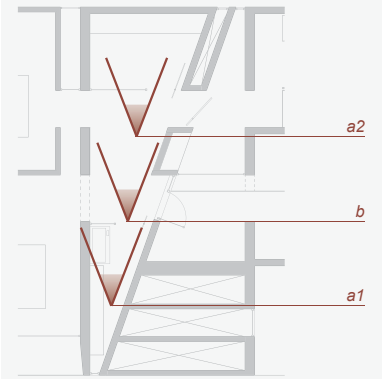
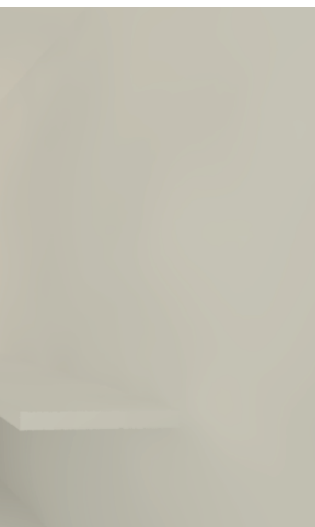


Fig. 156 2<sup>nd</sup> Floor, Maker Area

Note: no major sectional change

a1-2) first - makerbot station is obstructed by diffusing mechanism from shower below

b1-2) tentative final - obstruction is removed and entrances are minimised. help desk is further condensed into a single door opening in future images.

i





a1-2) first - interior and exterior views of the initial design of the 3d model gallery space.

b) alternate design of enclosure - rendered result is desirable

c-e) resolution of interior proves problematic in terms of concealing the source of light and simultaneously evenly lighting the perimeter shelf

f) initial proposal of long light shafts that diffuse light to objects on similarly proportioned podiums below - result is promising

g) assess light at midday. note that design of roof is incomplete on eastern portion of scene, allowing more light to enter the space

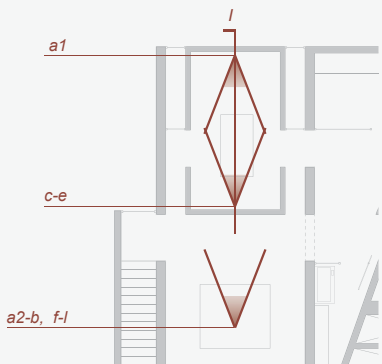
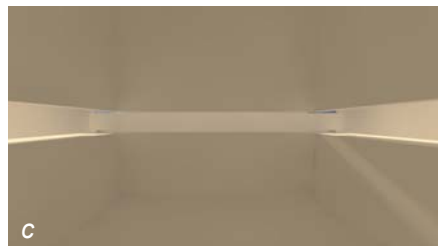
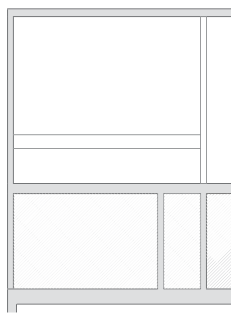
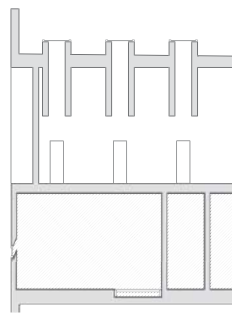


Fig. 157 2<sup>nd</sup> Floor, Gallery Area



first (a)

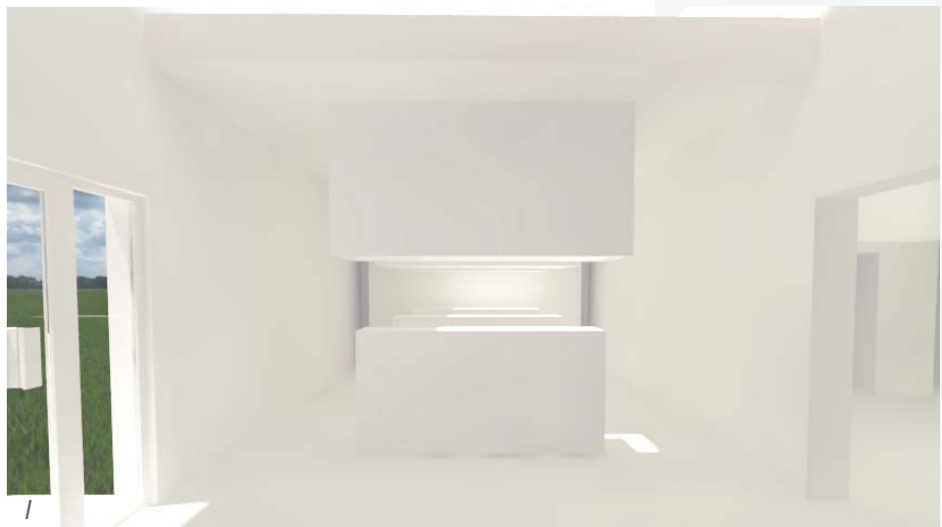


final (l)

Fig. 158 Section I Comparison

# gallery space

Fig. 159 Gallery Space Resolution



*g-k) determine possible solution for the end of the gallery (west facade). j appears to have a more significant effect, but results in light effects appearing on the floor (undesirable except from diffusers above).*

*l) tentative final - slit diffusers at end of space frame the gallery diffusers and acts as a secondary surface for light from the diffusers above, drawing visitors to the back of the space*

*i*



# bedroom wall detail



a) first - glass portion of floor lacks continuity, simply terminates at wall

b) introduce small frame that corresponds to width of glass

c) lengthen frame to fit between perpendicular walls - edge of frame is visible

d) shorten frame to align with end of bedroom diffuser device

e) camera position adjusted to the viewpoint of a standing person



Fig. 160 Bedroom Wall Detail Resolution

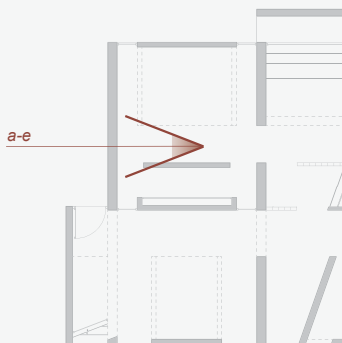


Fig. 161 Ground Floor, Bedroom Wall

# final design drawings

---

THE REFINED DESIGN SOLUTION

THE INTRINSIC AGENT



Fig. 162 Second Floor Plan



Fig. 163 Ground Floor Plan





Fig. 164 Section 1

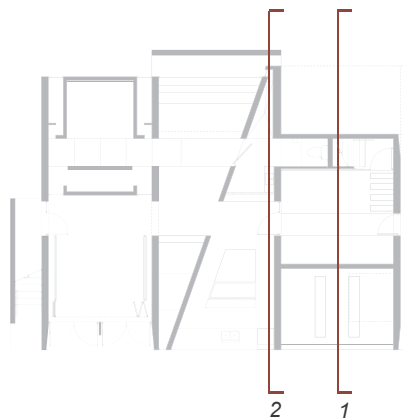


Fig. 165 Key Plan, Sections 1 and 2





Fig. 166 Section 2

*i*





Fig. 167 Section 3

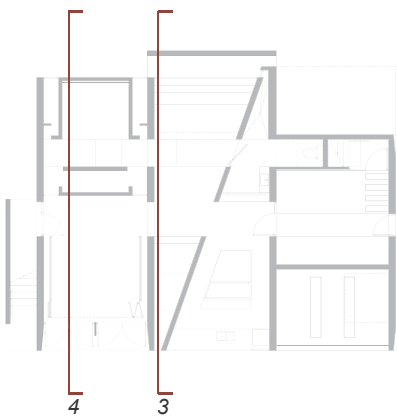


Fig. 168 Key Plan, Sections 3 and 4



Fig. 169 Section 4

*i*





Fig. 170 View South from Reflecting Pool

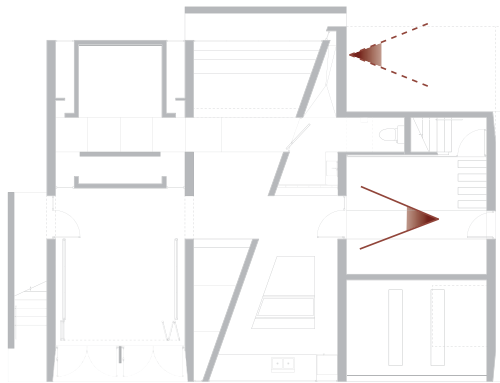


Fig. 171 Key Plan, Reflecting Pool and Study Views



Fig. 172 View North from Entrance to Study

*i*



THE INTRINSIC AGENT



Fig. 173 View East to Kitchen/Dining

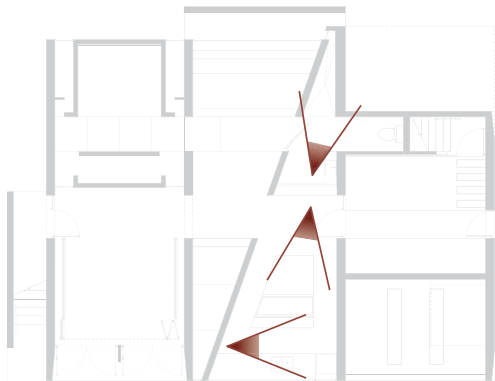


Fig. 175 Key Plan, Kitchen/Dining and Bathroom Views



Fig. 174 View North in Kitchen

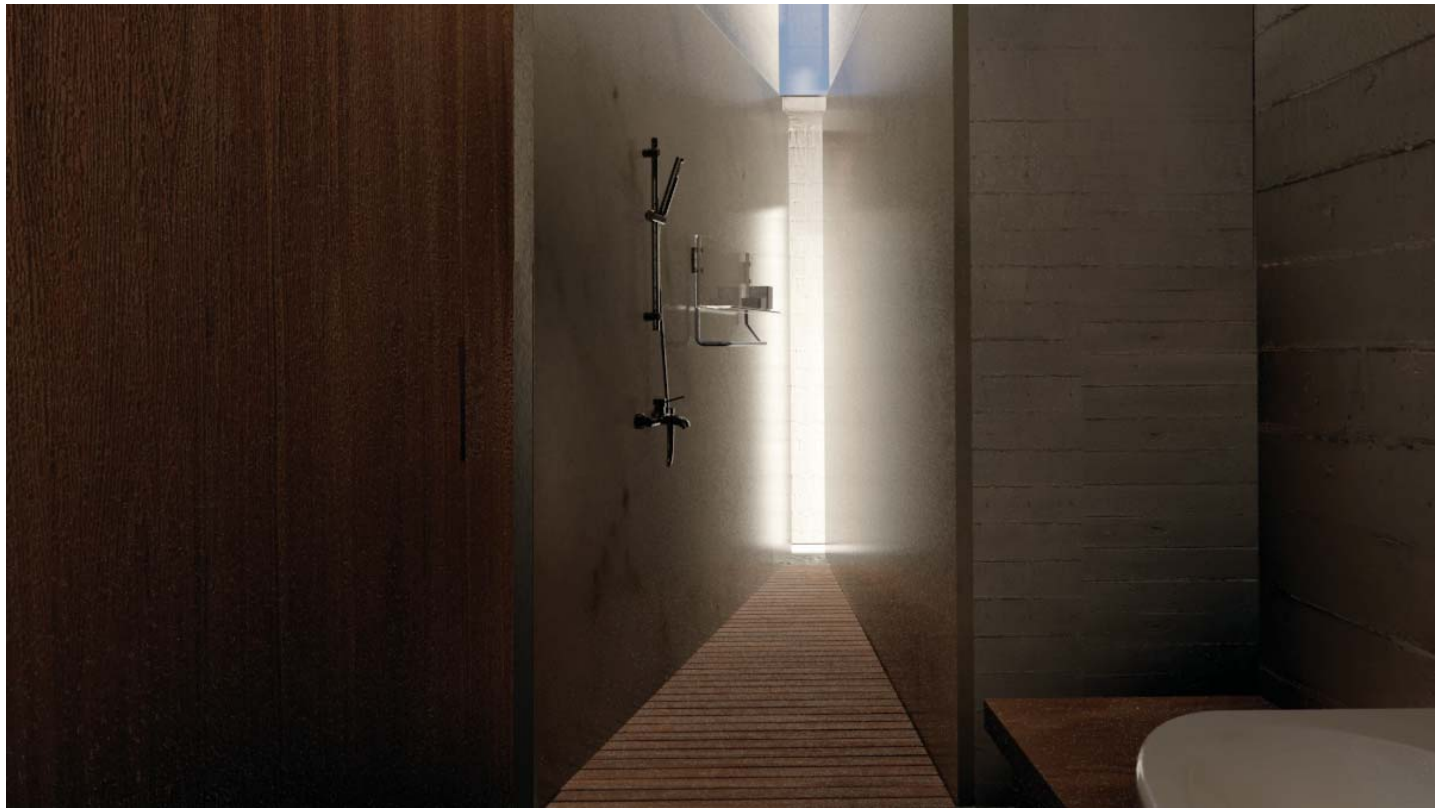


Fig. 176 View West to Shower

*i*





Fig. 177 View East to Meditation Space

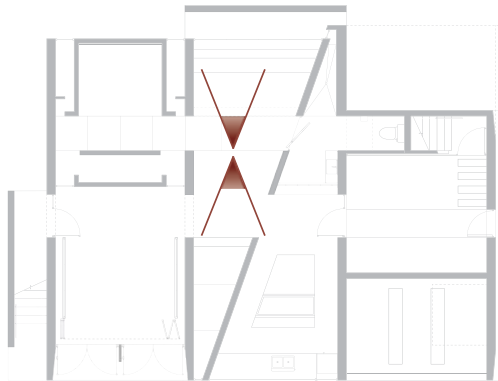


Fig. 178 Key Plan, Meditation and Reading Area Views



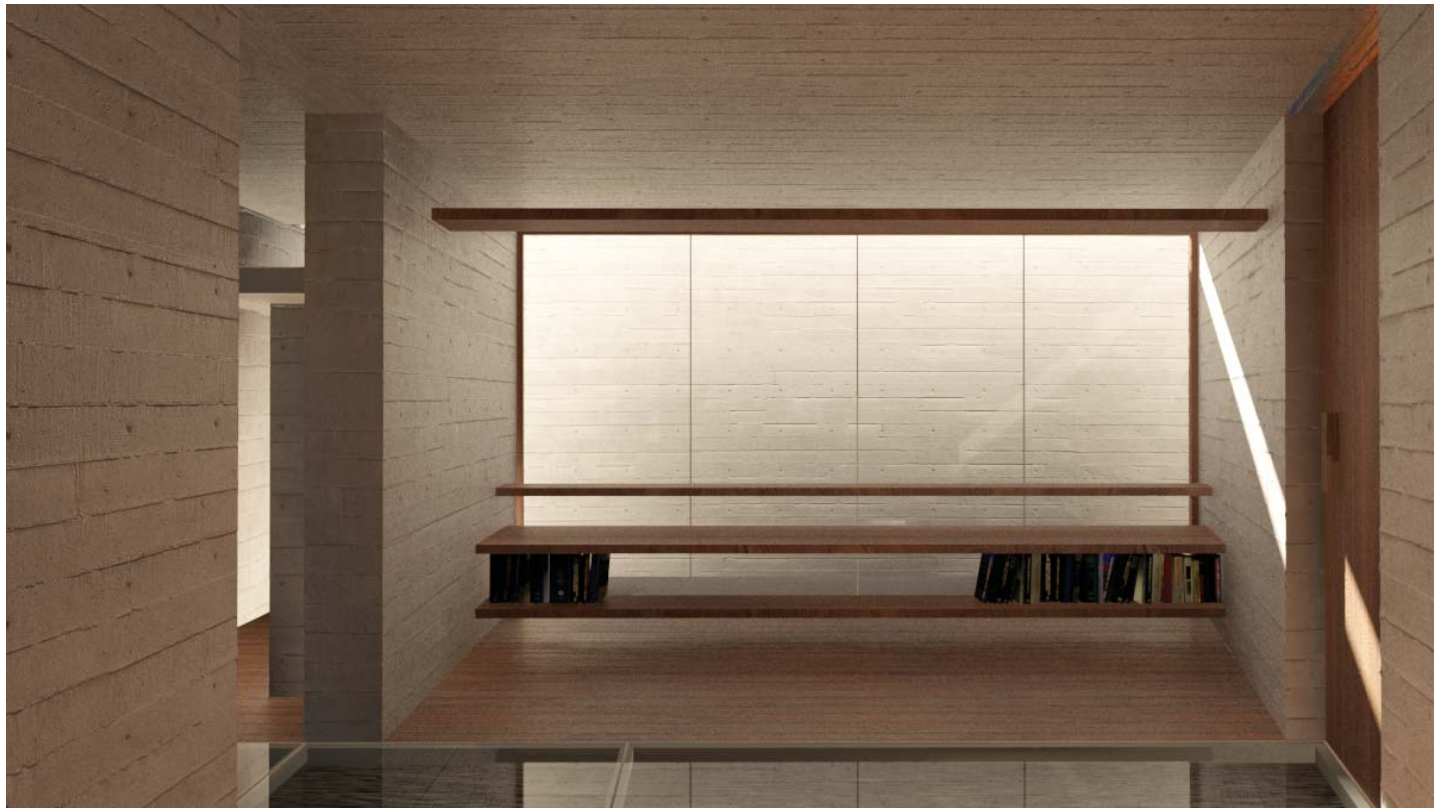


Fig. 179 View West to Reading Area

*i*



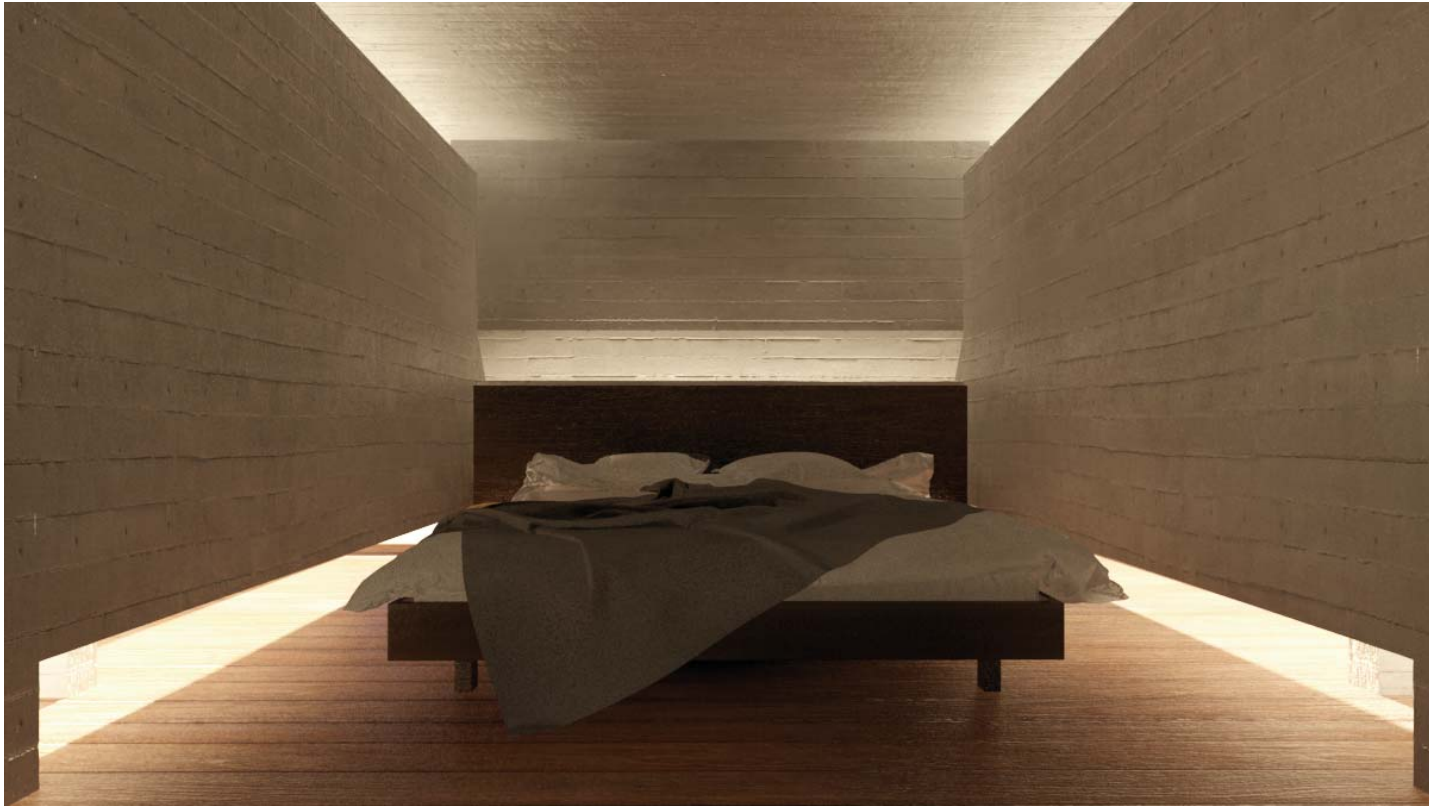


Fig. 180 View East in Bedroom

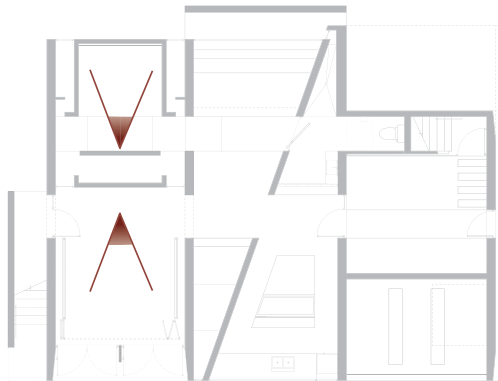


Fig. 181 Key Plan, Bedroom and Living Area Views



Fig. 182 View West in Living Room



Fig. 183 View of Living Room with Screen Unfolded





Fig. 184 View South from Bridge over Reflecting Pool

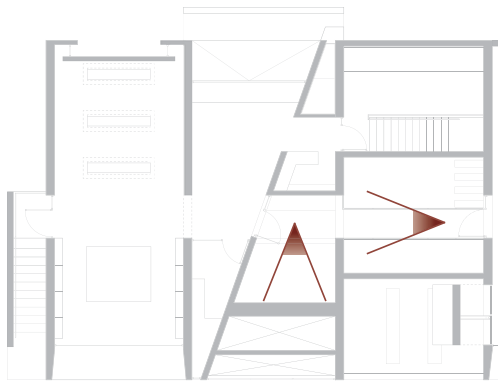
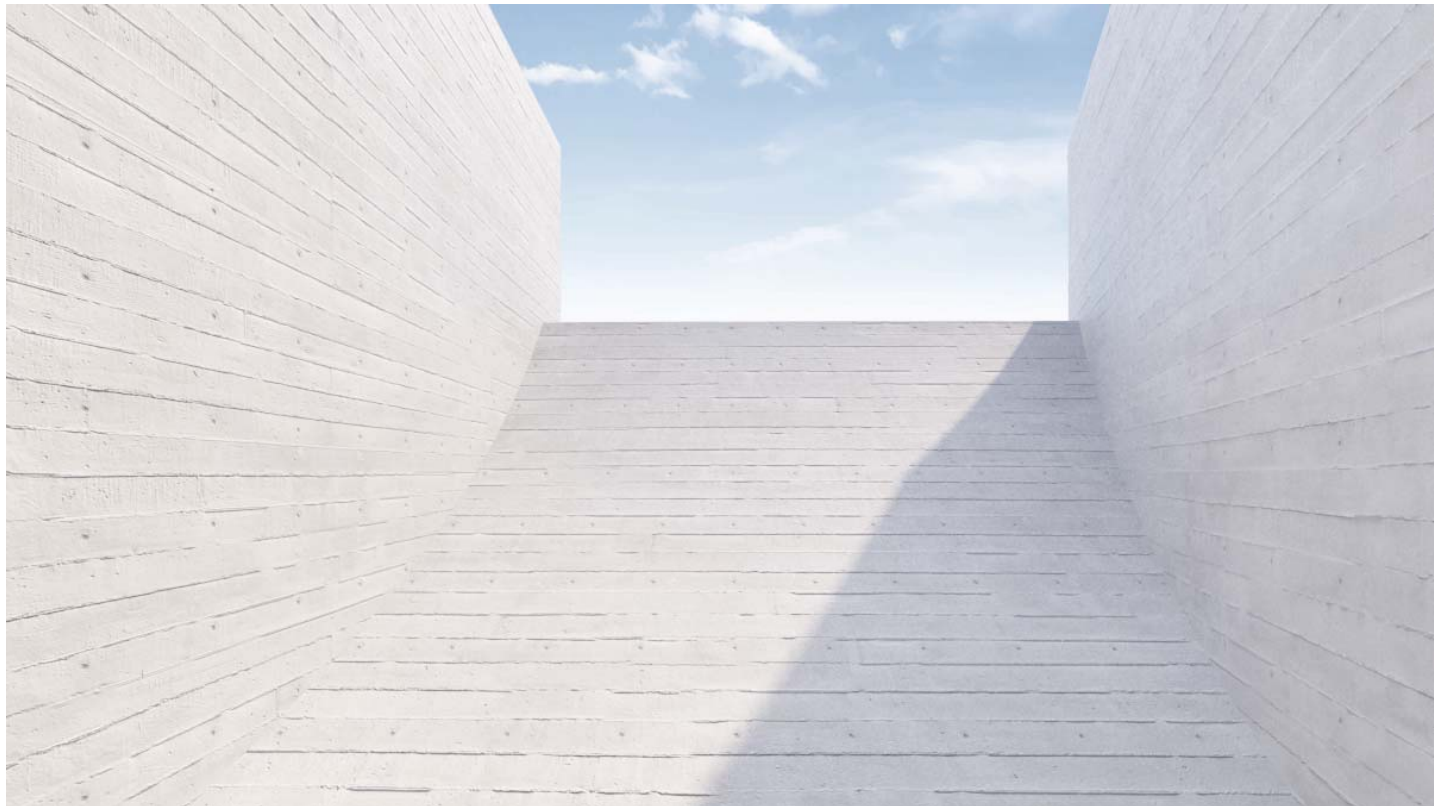


Fig. 185 Key Plan, Exterior Bridge Views



**Fig. 186** View East from Maker Space Entrance

*i*





Fig. 187 View East to Laser Cutting Room

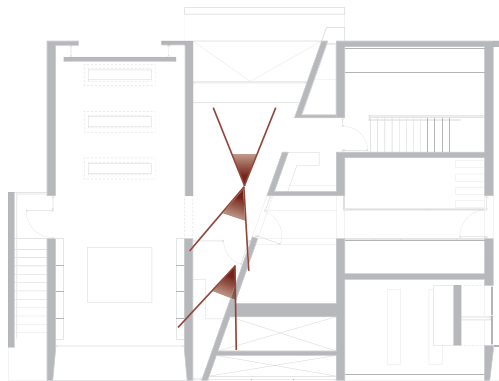


Fig. 189 Key Plan, Makerbot and Laser Area Views



Fig. 188 Close View East in Laser Room



**Fig. 190** View West Maker Bot Station

*Makerbots not shown.*

*i*





Fig. 191 View East to Laser Cutting Room

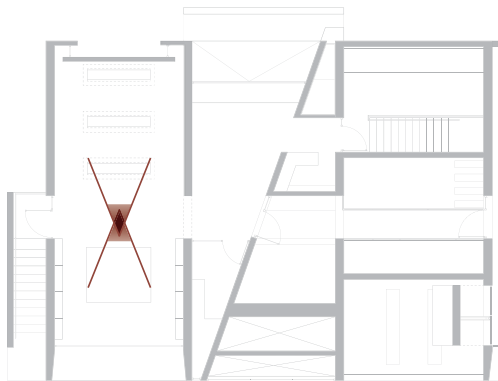


Fig. 192 Key Plan, Maker Work Area and Gallery Views



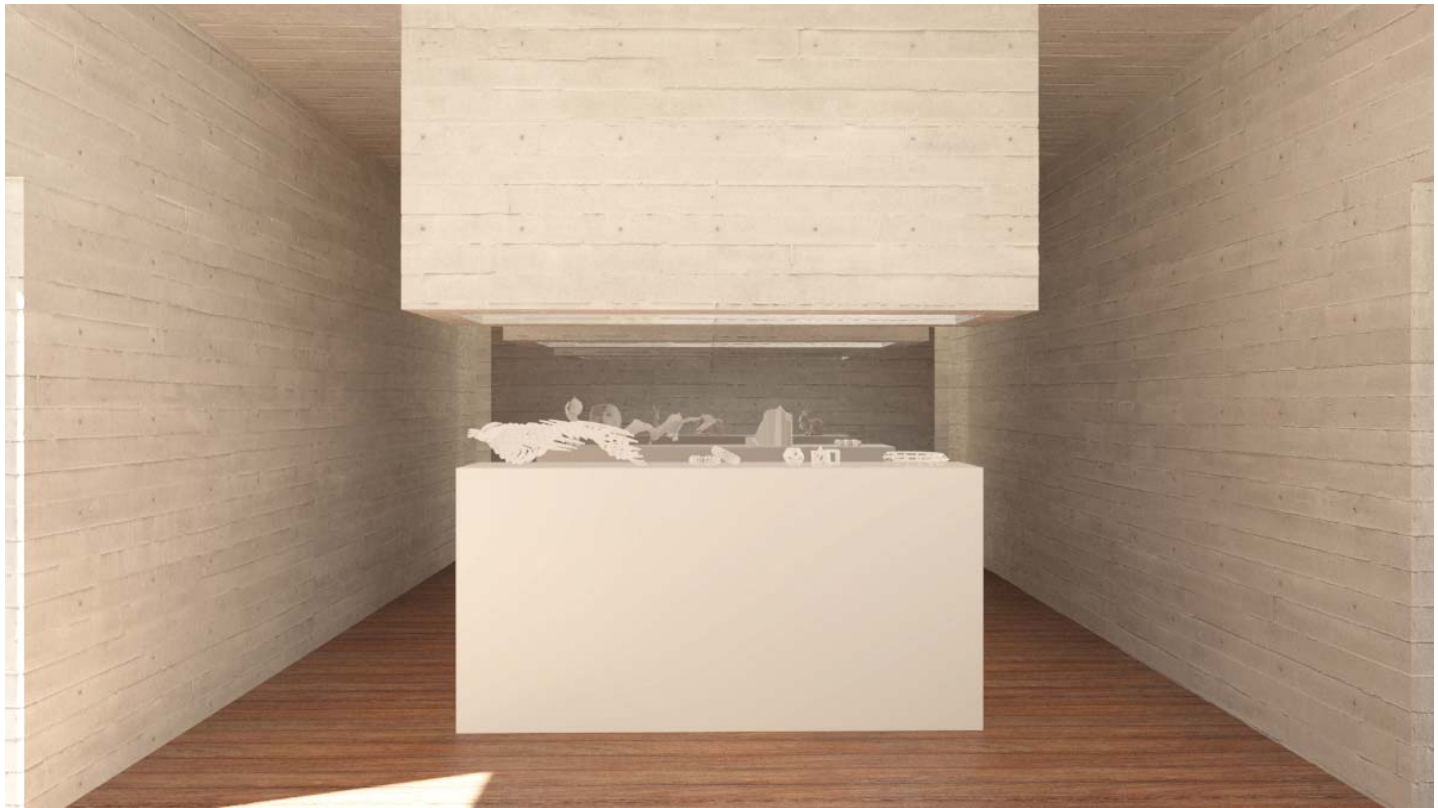


Fig. 193 View West Maker Gallery

*i*





Fig. 194 Exterior Rendering, View from West

## reflection

### APPLYING THE METHODOLOGY

---

The most difficult part of the process of applying the reference to my design work was discovering the system strategy's significance to the methodology. As a later addition to the methodology, I had initially thought of it as not much more than a necessary part of the tool's associated vocabulary. To my surprise, it proved to be an invaluable part of refining my selection and development of optic devices. The system strategy, a slit-aperture geometry that is prevalent throughout the existing building, needed to be supplemented with a preference for diffusing optic devices in order for it to be compatible with the private program of the ground floor dwelling. The choice to mirror the triangular rooms of the original design also presented complications. However, this decision was made for the arrangement's definitive alignment of tectonic strategy and [light] system strategy. Its inclusion presented an unavoidable need to address the system strategy, and produced some of the most interesting portions of design including the shower and meditation space.

Another portion of the methodology that I found myself turning to in moments of uncertainty was the compilation of archetypes. Having identified the main archetypes of effect in the existing building, I used the same archetypes and their requisite conditions to identify the issues in my progress work. The most useful archetype was the secondary source, the type of effect that diffusing

optic devices typically produce. Understanding the parameters of this archetype was an important part of knowing how to emphasise the effects that I was attempting to produce, as shown in the progress renderings of the bedroom. The role of the specular image archetype was expanded in the addition, where it was used to bring the image of the sea into the living room space. This archetype prompted me to think about the movement of the viewer in the space, as the specular image appears most clearly when the viewer's gaze is parallel with the plane of the mirror device (in this case glass). Instances of textural light that can be seen in the renderings of the proposed design are purposefully merely incidental, as the orientation of the building lends itself to the formation of this light effect.

I believe that the workflow behind the application of the methodology certainly affects the usefulness of the tool. A white diffuse material was used for most surfaces (excluding non-opaque materials) for preliminary and progress renderings to keep the workflow light and rendering times fast. Being able to relatively easily and quickly achieve a high quality, smooth rendering result is paramount to both the effective assessment of multiple tectonic solutions and the maintenance of morale as one completes a significant volume of renderings. Similarly, the creation of parametric definitions for optic devices is undoubtedly a time investment, and parametric tools like Grasshopper should only be used when necessary or productive.



Fig. 195 Julio Le Parc, *Continuous Light Cylinder*

## i conclusion

### EMBRACING POTENTIAL

---

This thesis ultimately proposes a method of applying light to architectural work as a supplemental agent. It argues that the pervasiveness of light phenomena in architectural space coupled with its potential to be transformed by tectonic intervention positions it as an optimal communicative tool. However, in order to explore the range and limits of light in this capacity, a framework for discussion and application is necessary. *The Intrinsic Agent* offers architects a framework in the form of a methodological reference, but because this thesis documents a process, I must acknowledge the difficulty of identifying the need for this framework. Architects have a keen predisposition to exploring other fields and adapting and using new tools, chief among them algorithm editors such as Grasshopper and its various plugins. The value of these tools is undeniable. In Part II of this work, the compelling form of the veil experiment was wholly derived from the use of parametric tools. However, the relevance of parametric tools to my larger intention to expand the role of light in the field of architecture remained a mystery. I simply could not understand

why applying light information to architecture using parametric tools felt insufficient as a theoretical solution.

With feelings of frustration, I took to reading Plummer's phenomenological writings on light and architecture, *Optics for Dummies* (a summary of the physics of light directed at the lay person), and another phenomenological text, Juhani Pallasmaa's *Eyes of the Skin*. The physics of light captured my attention, but I was quickly made aware of the fact that architects cannot work with this raw information. The creation of an intermediary vocabulary and set of ideas was suggested to me by my brother, an actuary, and I began to consider the prospect of developing this missing informational and conceptual bridge. But the question remained: what kind of information about light does an architect require? During a revision of the writing of Part II, I reconsidered the question of parametrics and read the introductory chapters of Robert Woodbury's *Elements of Parametric Design*. Woodbury, a professor whose research is based in computational design and visual analytics, makes the observation that architects and designers prefer to leave the development of general case solutions to experts

and instead practice a copy-and-modify, case-by-case approach to their work with parametrics.<sup>1</sup> He then details the skills that every parametric designer requires, including the ability to think abstractly.<sup>2</sup> This insight prompted a breakthrough in my own thinking about the problem at hand. I realised that architects do not have a lens through which to abstractly think about effects of light. Though basic principles of geometrical optics are a standard part of secondary school curricula and the concepts are not difficult, most students compartmentalise this knowledge and do not consider its application in architecture because it is rarely framed in such terms. This experience has shown me that it is invaluable for architects to be self-aware of the way that we engage with tools produced by other disciplines. In this case, gaining an understanding of the more effective way of programming, which is to create general, reusable pieces of code, was instrumental in clarifying the nature of the support that working with light requires: an abstract, tectonically-grounded knowledge base. My veil experiment did not satisfy my imagination of a theoretical solution because it did not exemplify a general case or general method.

Having identified the need for the framework, the second challenge became establishing the elements and hierarchy of the tool, as well as its relationship to the design process. Interestingly, it was by conducting the *Seashore Library* case study that the shortcomings of a reference that included only archetypes of light effect and optic devices were revealed. My analysis had revealed a commonality among the optic devices of the existing building, but I didn't have a complete framework with which to describe its role or significance. The idea of the system strategy was born, and I believe that it is this that transforms the methodology from a reference of aesthetic variety to a tool of communication. The system strategy drives the selection for, and integration of optic devices with, a larger design

scheme and promotes cohesion among the suite of devices. It is through this component of the methodology that light gains a voice within the project. It must be noted that the system strategy is my interpretation of an extractable, evolvable schema. I believe that it is the key to learning about the use of light in case study projects and developing and applying the observed model to new work thereafter. This methodology is not intended to replace or devalue existing pedagogical tools, but rather to complement them. I have described the proposed tool as a methodological reference because that is how I intend it to be used – as a loose methodology, to be relied upon in moments of uncertainty or experimentation. Students and architects are invited to adapt the tool to suit their needs and personal design process.

This work has been completed to celebrate and showcase light's power to convey, and to foster interest in working with light to differentiate and tune space. All that is required on the part of the architect is a willingness - architecture's intrinsic agent presents countless opportunities for engagement.

---

1 Robert Woodbury, *Elements of Parametric Design* (New York: Routledge, 2010), 9.

2 *Ibid.*, 30.



**BIBLIOGRAPHY**

---

- Al, Stefan, ed. *Villages in the City: A Guide to China's Informal Settlements*. Honolulu: University of Hawai'i Press, 2014.
- Arbib, Michael. "Toward a Neuroscience of the Design Process." In *Mind in Architecture*, edited by Sarah Robinson and Juhani Pallasmaa. Cambridge: MIT Press, 2015.
- DeLanda, Manuel. "Uniformity and Variability: An Essay in the Philosophy of Matter." Presented at the Doors of Perception 3: On Matter conference, Amsterdam, Netherlands, November, 1995.
- Deleuze, Gilles and Felix Guattari, "The Smooth and the Striated." In *A Thousand Plateaus: Capitalism and Schizophrenia*. Minneapolis: University of Minnesota Press, 1987.
- Descottes, Hervé and Cecilia E. Ramos. *Architectural Lighting: Designing with Light and Space*. New York: Princeton Architectural Press, 2011.
- Duree, Galen, Jr. *Optics for Dummies*. Indianapolis: Wiley, 2011.
- Hauser, Sigrid and Peter Zumthor, *Peter Zumthor Therme Vals*. Zurich: Scheidegger & Spiess, 2007.
- Issa, Rajaa. *Essential Mathematics for Computational Design 3<sup>rd</sup> Edition*. Robert McNeel and Associates, 2017. Accessed July 5, 2017, <http://www.rhino3d.com/download/rhino/5.0/essentialmathematicsthirdedition/>.
- Kiser, Thomas, Michael Eigensatz, Minh Man Nguyen, Philippe Bompas, and Mark Pauly. "Architectural Caustics - Controlling Light with Geometry." EPFL Computer Graphics and Geometry Laboratory. Accessed April 4, 2017, [http://lgg.epfl.ch/publications/2012/caustics/ArchitecturalCaustics\\_AAG.pdf](http://lgg.epfl.ch/publications/2012/caustics/ArchitecturalCaustics_AAG.pdf).
- Krautter, Martin and Thomas Schielke. *Light Perspectives: Between Culture and Technology*. Lüdenscheid: ERCO GmbH, 2009.
- Kuma, Kengo. *Anti-object: The Dissolution and Disintegration of Architecture*. London: Architectural Association, 2008.
- Lynch, David K. and William Livingston. *Color and Light in Nature*. Cambridge: Cambridge University Press, 2004.
- Major, Mark, Jonathan Speirs, and Anthony Tischhauser. *Made of Light: The Art of Light and Architecture*. Basel: Birkhäuser, 2005.
- Mallgrave, Harry Francis. "Ambiguity: The Architecture of Vision." In *The Architect's Brain: Neuroscience, Creativity, and Architecture*. Chicester: Wiley-Blackwell, 2010.



- Mallgrave, Harry Francis. "Hapticity: Architecture of the Senses." In *The Architect's Brain: Neuroscience, Creativity, and Architecture*. Chichester: Wiley-Blackwell, 2010.
- Marpillero, Sandro. *James Carpenter Environmental Refractions*. Basel: Birkhäuser, 2006.
- Pallasmaa, Juhani. *The Eyes of the Skin: Architecture and the Senses*. Chichester: Wiley, 2005.
- Plummer, Henry. *Cosmos of Light: The Sacred Architecture of Le Corbusier*. Bloomington: Indiana University Press, 2013.
- Plummer, Henry. "Poetics of Light." *A+U* December Extra Edition (December 1987).
- Rockcastle, Siobhan, María Lovísa Ámundadóttir, and Marilyne Andersen. "A Simulation-Based Workflow to Assess Human-Centric Daylight Performance." Presented at the annual Symposium on Simulation for Architecture and Urban Design [SimAUD], Toronto, Canada, May 22-24, 2017.
- Roudsari, Mostapha Sadeghipour and Michelle Pak. "Ladybug: a parametric environmental plugin for grasshopper to help designers create an environmentally-conscious design." Presented at the proceedings of the 13th International IBPSA Conference Held in Lyon, France, Aug 25–30, 2013.
- Russell, Sage. *The Architecture of Light*. La Jolla: Conceptnine, 2008.
- Schielke, Thomas. "Light Matters: Heightening The Perception Of Daylight With Henry Plummer (Part 2)," May 7, 2015. *ArchDaily*. Accessed July 5, 2017, <http://www.archdaily.com/627695/light-matters-heightening-the-perception-of-daylight-with-henry-plummer-part-2/>.
- "Seashore Library / Vector Architects" June 2, 2015. *ArchDaily*. Accessed July 5, 2017, <http://www.archdaily.com/638390/seashore-library-vector-architects/>.
- Whiting, Sarah, ed. *Beyond Surface Appeal: Literalism, Sensibilities, and Constituencies in the Work of James Carpenter*. Cambridge: Harvard University Press, 2012.
- Weinstock, Michael. "Morphogenetics and Emergence." In *Computational Design Thinking*, edited by Achim Menges and Sean Ahlquist. Chichester: Wiley, 2011.
- Woodbury, Robert. *Elements of Parametric Design*. New York: Routledge, 2010.
- Zumthor, Peter. *Thinking Architecture*, 3rd ed. Basel: Birkhauser, 2010.

