

Parameterizing Enterprise WiFi Networks: The Use of Wide Channels

by

Saber Malekmohammadi

A thesis
presented to the University of Waterloo
in fulfillment of the
thesis requirement for the degree of
Master of Applied Science
in
Electrical and Computer Engineering

Waterloo, Ontario, Canada, 2019

© Saber Malekmohammadi 2019

I hereby declare that I am the sole author of this thesis. This is a true copy of the thesis, including any required final revisions, as accepted by my examiners.

I understand that my thesis may be made electronically available to the public.

Abstract

We investigate the joint channel, power, and carrier sensing threshold allocation problem in IEEE 802.11ac enterprise networks in a single 160 MHz band and show that the current practice, which is to use narrower channels at maximum power when the network is dense, yields much worse performance than a solution using the widest possible channel (i.e., 160 MHz) with a much lower power. This finding is consistent with cellular networks which use a reuse factor of one. Based on these insights, we propose and evaluate an algorithm that allocates the widest channel to all Access Points, and finds the appropriate transmission power and carrier sensing threshold for each of them to provide an efficient and fair solution to a managed IEEE 802.11ac enterprise network. The performance gains with respect to the best of the two benchmarks that we consider range from 60% in not too dense deployments to more than 200% in dense deployments.

Acknowledgements

I would like to appreciate my supervisor, professor Catherine Rosenberg, for her support during my M.A.Sc program. She is indeed a knowledgeable researcher in the field of wireless communications and networking and it was my honor to do my M.A.Sc under her supervision in Electrical and Computer Engineering department of the University of Waterloo.

Finally, it is my pleasure to thank the University of Waterloo community for making such a great environment for students to make progress and reach success.

Dedication

It was one of my best experiences to study in the Electrical Engineering M.A.Sc program of the University of Waterloo. Definitely, I will not forget these two years in the future. This thesis is not definitely the only outcome of these two years. I learned a lot of valuable things that I think are to be used even in the coming years of my lifetime. I would like to dedicate my thesis to my mother, the angel of my life. I did not understand how much supportive she always was for me during my life until I started living far from her. It would not be possible for me to reach this point without her supports.

Table of Contents

List of Tables	viii
List of Figures	ix
1 Introduction	1
2 Related Work	4
3 Background and Benchmarks	8
3.1 Background	8
3.2 Benchmarks	9
4 Network Model	11
4.1 Network Topology	11
4.2 Channel Propagation and Power	12
4.3 Traffic and Overall Performance Metric	13
4.4 Coverage and Transmission Power	14
4.5 Approach	15
5 Uniform AP Settings	16
5.1 $\mathcal{L} = 40$ m	16
5.2 $\mathcal{L} = 25$ m	18
5.3 $\mathcal{L} = 15$ m	20

6	Non-uniform AP Settings	22
7	Proposed Algorithm	27
8	Conclusion	29
	References	30

List of Tables

2.1	Summary of the works done on channel allocation in the literature	5
3.1	minimum modulation and coding rate sensitivity, as defined in IEEE 802.11 ac standard	9
6.1	Performance under non-uniform AP settings for $\mathcal{L} = 15m$. $C_{poor}+$ (resp. P_{poor}) is the increment of CST (resp. increment of TX power) for poor users.	26
7.1	Performance (GM_{tot}) of the proposed and benchmark methods for random realizations of users and APs	28

List of Figures

1.1	IEEE 802.11ac channel allocation on the 5GHz band	2
4.1	The network used in the simulations. The figure depicts four floors in a building, with 16 APs deployed per floor, each located in one square room.	11
4.2	The first floor of the simulated network	12
5.1	The network overall performance vs. P_t for different channel widths and different CSTs, for a random realization and when $\mathcal{L} = 40$ m	17
5.2	The network overall performance vs. P_t^{20} for different channel widths for the default CST, for the same random realization as in Figure 5.1 and when $\mathcal{L} = 40$ m	17
5.3	The network overall performance vs. P_t^{20} for different channel widths, for a random realization when $\mathcal{L} = 25$ m	19
5.4	The network overall performance vs. P_t^{20} for different channel widths, for a random realization and when $\mathcal{L} = 15$ m	20
6.1	The GM throughput of each of the 64 APs in the network (the x-axis is the AP id, please refer to Figure 4.1), for a random realization when $W = 160$ MHz, the power yields the best overall GM and $\mathcal{L} = 25$ m	23
6.2	The GM throughput of each of the 64 APs in the network (the x-axis is the AP id, please refer to Figure 4.1), for a random realization when $W = 160$ MHz, the power yields the best overall GM and $\mathcal{L} = 15$ m. The dashed line represents half of the arithmetic mean of the GM throughput of the APs	24
6.3	The performance of each of the 64 APs in the network when $W = 160$ MHz, the power yields the best overall GM, $\mathcal{L} = 15$ m, for the same realization as in the previous figure, and the poor APs use a CST = -76 dBm	25

Chapter 1

Introduction

The evolution of usages and practices in enterprise environments, such as the increased popularity of the Bring Your Own Device (BYOD) movement, push for new solutions in the field of enterprise wireless local area networks (WLAN). The most recent evolution in this sense is IEEE 802.11ac [17], a WiFi technology that can provide high throughput thanks to its ability to use wider channels (up to 160 MHz), more MIMO spatial streams, and the addition of a dense modulation scheme (256 QAM). IEEE 802.11ac operates on the 5 GHz band. As shown in Fig.1.1, the channel planning in the 5 GHz band is such that channels are non-overlapping. Also, unlike to the 2.4 GHz band, there are different possible values for the channel bandwidth (20, 40, 80 or 160 MHz). However, the allocation of these resources is critical, especially in dense environments, to provide good performance [4].

The administrator of an IEEE 802.11ac WLAN has to select not only the channel width for each AP, but also the specific channel to use when several possibilities exist for a given width. He can also play with the transmit power of each AP, as well as with the carrier sensing threshold (CST) used by the APs. The resulting problem is a complex joint channel, power and CST allocation. While formulating and solving this problem is difficult, we try to address some related research questions that are stated below:

- Is it better, in terms of overall performance for each AP, to use wide channels in spite of the increased interference and increasing collision region, or narrow channels to reduce interference and decrease the collision region?
- Is the answer to the previous question different depending on the density of the deployed WiFi network?

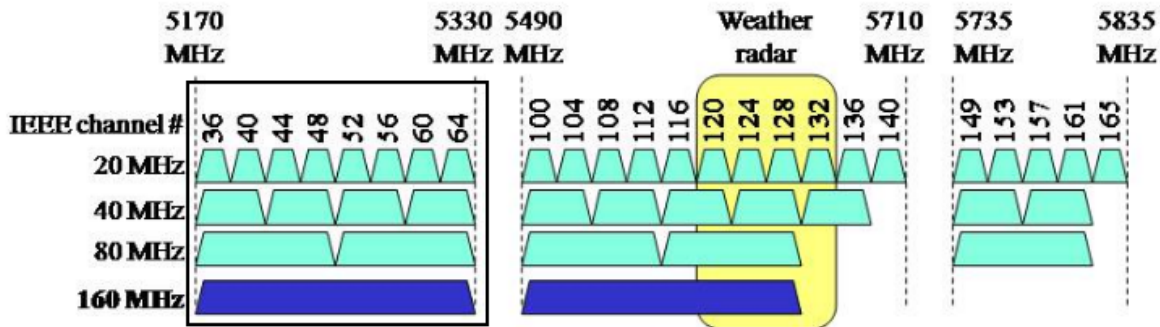

Figure 1.1: IEEE 802.11ac channel allocation on the 5GHz band

- What is the interplay between channel bandwidth, transmission power and the value of CST on the performance of the network?

The current practice in the industry is to set the transmission power for each AP to a high fixed value, usually the maximum power defined in the standard [17]. Even for advanced solutions that propose to assign dynamic power values (possibly different for each AP), obtained from a power management algorithm [6], the power values are always relatively high. Another parameter, the CST, is rarely considered for a dynamic assignment and is almost always set to a default value. Therefore, most of the solutions proposed in the literature [2] [3] [7] focus on different channel allocation schemes for the APs in the WLAN, the widely accepted approach being to allocate narrower channels as the network density (in terms of APs) increases.

Our contributions in this paper can be summarized as follows. We consider an enterprise WLAN that is managed and parameterized by a single entity (e.g., an administrator) to operate efficiently, i.e., to ensure a high overall performance. The network operates on a single 160 MHz band, which can be divided in 8/4/2/1 non-overlapping 20/40/80/160 MHz channels. We focus our study on downlink traffic, which significantly surpasses uplink traffic in enterprise scenarios nowadays. Through an extensive simulation campaign using ns-3 [5], we study the interplay between three network parameters (channel bandwidth, transmission power and CST) on the overall network performance, for different AP densities.

We show that, when all APs use the same three parameters, irrespective of the deployment density of the network, the best overall performance is *not* obtained for high values of power, but rather when each AP uses the entire 160 MHz channel with a relatively low

transmission power. We also show that this performance (obtained on the single 160 MHz channel with low transmission power) is significantly higher than the one obtained at any power close to the maximum allowed power irrespective of the channel allocation. We also show that, when all APs use a low transmission power, the value of the CST does not have much effect on the network's overall performance, as the contention and interference have already been mitigated by the choice of a low power. This is not true at high power.

We also observe that, when the network is dense, some APs see degraded performance compared to other better placed APs. Thus, we propose a simple way to reduce the unfairness among APs by clustering the APs into two sets, the "poor" and the "rich", and we parametrize poor APs to bring them up to level, by using higher transmission power and CST.

Finally, we provide two schemes to parameterize enterprise networks. Both of them allocate the entire 160 MHz channel to all APs and use a default CST. They differ on how the transmission power is adjusted: one uses an easy to compute power level that is enough for coverage (given a range that depends on the density), it is simple but provides lower performance than the second one where the administrator has to do some experiments to find the first local maximum above that power. In a second step, both schemes determine if the performance differences among APs is acceptable or not. If not, they cluster the APs into two sets, the "poor" and the "rich", and they parameterize poor APs to bring them up to level, by using (the same) higher transmission power and CST. Note that what we propose is not a dynamic and traffic dependent approach. It can be seen as the set-up an administrator should use to parametrize his network offline in an initial step. Dynamic traffic dependent solutions can be used subsequently.

Chapter 2

Related Work

Different solutions have been proposed to improve the performance of WiFi networks: user association control [13], transmission power control [11] [12], CST adjustment [27] [10], and smart channel assignment [20]. The main challenge in the channel assignment problem is that the number of available channels is limited. Therefore, they should be reused by the APs in a network. In WLANs, unlike cellular networks, the coverage areas of APs can have considerable overlapping. Although the IEEE 802.11 MAC protocol (based on CSMA/CA) can handle scenarios where two adjacent APs use the same channel, the performance is degraded, since an AP that transmits silences other APs using the same channel in its physical proximity. Specifically, an AP backs off from accessing the channel when the power received from a concurrent transmitting AP is higher than the CST.

The channel selection problem aims at choosing a channel per AP in a list \mathcal{C} of channels of possibly different widths. There are two classes of channel selection schemes. The first one includes all the schemes that are distributed and online, where an AP, when turned on (and sometimes at regular intervals afterwards), selects one channel in \mathcal{C} based on some measurements. The second class contains schemes where the channel selection for all APs is made centrally and possibly offline, to try to obtain a good overall system performance.

A common online channel selection scheme in uncoordinated networks is the Least Congested Channel Search (LCCS) [20], in which each AP looks for and selects the most lightly loaded channel in a distributed fashion. In another example, [21] models the channel assignment problem as a graph vertex coloring problem and a distributed heuristic is run on each AP. Also, [22] proposes a client-driven channel management approach based on a “conflict set coloring” formulation. However, the mentioned works, which belong to the first class of channel allocation schemes, assume fixed bandwidth and transmission power

Table 2.1: Summary of the works done on channel allocation in the literature

	Centralized/Distributed	Channel Width	Power	CST
[20] [21] [22]	Distributed	Fixed	Fixed	Fixed
[8], [25], [18]	Centralized	Fixed	Fixed	Fixed
[6]	Centralized	Fixed	Variable	Fixed
[2]	Centralized	Variable	Fixed	Fixed
[10]	Applicable to both	Fixed	Fixed	Variable
[7], [1]	Centralized	Fixed	Fixed	Fixed
Our proposed method	Centralized	Variable	Variable	Variable

for APs, while in IEEE 802.11ac different values of channel bandwidth and transmission power can be used by the APs.

The current industrial standard for enterprise WLAN management belong to the second class mentioned above, the one of centralized schemes. More precisely, the current practice assigns narrower channels to APs as the deployment density increases, fixing the transmission power to some relatively high values [7], [1]. However, measurements campaigns on small networks ([14], [28]) showed that neighboring narrow channels suffer from adjacent channel interference (ACI) and this degrades the performance of IEEE 802.11ac networks in high traffic loads. Therefore, considering the ACI effect, some studies [26] conclude that it is better not to divide wide channels into narrower channels. These studies also observed that the mutual interference between two APs decreases faster with the distance when the APs share a wide channel compared to when they share a narrow channel. The reason behind this important observation is that, when using wide channels, the used power budget is distributed over a wider channel. Other works ([19], [24]) have studied several IEEE 802.11ac features and their effect on network performance. In particular, they discuss the effect of channel bonding on fairness in networks. However, they do not provide any insights on how the combination of network density and channel configuration influences network performance. Also, [19] just considers uplink transmission, while today data traffic is mostly on the downlink.

Channel allocation, power management and CST adjustment have been studied in centrally coordinated WiFi networks. In [8] and [25], channel assignment and AP placement problems are studied for centrally managed networks. However, the works above assume the same fixed width for all the channels and fixed transmission power and CST for all APs. [18] formulates a channel allocation problem considering the traffic load at the MAC layer. It then proposes a heuristic algorithm to find a suboptimal solution for the problem and evaluates it by simulation. However, the work assumes fixed channel bandwidth,

transmission power and CST value. [10] focuses on studying the effect of the Dynamic Sensitivity Control (DSC) algorithm proposed in IEEE 802.11ax. The study shows that, by dynamically adjusting the CST threshold in a dense network, its aggregate throughput can be considerably improved. Again, it is assumed that the channels have a fixed bandwidth and transmission power values are fixed. In our proposed algorithm none of the three parameters are fixed beforehand.

The most complete solutions in the industry come from Cisco. They propose a centrally controlled power allocation algorithm (TPC) [6], and a dynamic channel assignment (DCA) algorithm [2]. In DCA, the central controller gathers information from all the APs in the network and calculates a cost metric for each channel and for each AP, based on the received signal strength indicator (RSSI). The cost metric represents the overall goodness of a channel for an AP. DCA finds the AP with the lowest throughput and tries to change its channel by assigning it the channel which has the best cost metric, among all possible choices. This process is performed iteratively by the controller. There are two proposed versions of DCA: *i)* DCA with static bandwidth allocation, and *ii)* DCA with dynamic bandwidth allocation. In the first case, the channel bandwidth is fixed and DCA only needs to select which channel in the frequency band to allocate to each AP, trying to assign different channels to physically close APs. Dynamic bandwidth DCA gathers supplementary information from the APs (e.g., load, interference, channel width, channel utilization) and selects the bandwidth to allocate to each AP dynamically. In dynamic bandwidth DCA, different APs may be assigned channels of different width. However, the general principle remains assigning narrower channels to APs in the network as the deployment density increases.

The TPC algorithm assigns (possibly different) transmission power values (P_t) to APs and aims to maximize APs coverage area and minimize their interference potential. Like DCA, TPC runs in a central controller. For a specific AP in the network, the controller sorts other APs in terms of the amount of interference they sensed from that AP, and it finds the third highest RSSI for each AP ($RSSI_{3rd}$). Having these values for all APs in the network, TPC runs as a two stage process. First, it determines what is the ideal transmission (TX) power for each AP in the network. Second, it evaluates a TX power change recommendation. In the first stage, the ideal TX power Tx_{ideal} of each AP is computed as:

$$Tx_{ideal} = Tx_{max} - (RSSI_{3rd} - TPC_{threshold}), \quad (2.1)$$

where Tx_{max} is the maximum allowed power for a given radio (for example, 14 dBm for 160 MHz channels) and $TPC_{threshold}$ is a customizable threshold with a default value of -70 dBm and a valid range of values in [-80,-50] dBm. In the second stage of the algorithm, the APs change their power level in order to reach Tx_{ideal} . Since changing the transmission

power of an AP can disrupt the service of some users, a hysteresis threshold is applied in this step, meaning that only APs using a power level far from the ideal one actually change their TX power.

DCA and TPC are executed by a central controller but independently from each other [4]. Other WiFi actors [3] use a similar method for channel allocation and power management. We argue that it is not the best approach to decide about transmission power values and channel allocation separately. Therefore, we investigate the effect of transmission power and channel bandwidth jointly.

In summary, most of the works in the literature study the effect of only one of the channel bandwidth, transmission power and CST parameters on networks performance, and, to the best of our knowledge, there is no prior work that studies the interplay of the three parameters together.

Chapter 3

Background and Benchmarks

Before discussing in detail our approach, we provide a brief background on the functioning of the MAC layer in IEEE 802.11 networks, and we present two benchmarks we use for comparison in this work.

3.1 Background

The IEEE 802.11 MAC protocol uses a CSMA/CA technique: the nodes (also called stations (STAs)) first listen to their channel before transmitting. If the preamble (a specific sequence known by all the STAs) of an ongoing transmission is heard, the Clear Channel Assessment (CCA) function declares the channel busy. The standard [17] defines a minimum receiver sensitivity, meaning that any preamble received with a power superior to this threshold must be detected by a valid STA. The minimum sensitivity depends on the modulation and coding scheme used for the transmission, as well as on the channel width (values summarized in Table 3.1).

A STA listening to the channel also measures the energy received on it. In case the preamble of an ongoing transmission is not decoded but the energy measured on the channel exceeds an energy detection threshold, the CCA function considers the channel as occupied. This mechanism is intended to protect WiFi from interference from other technologies sharing the same band. The reverse of the medal is that the energy detection threshold can be activated by transmissions in adjacent WiFi bands as well ([14], [28]). By default, the energy detection threshold is set at 20 dB above the minimum sensitivity.

Table 3.1: minimum modulation and coding rate sensitivity, as defined in IEEE 802.11 ac standard

MCS	Modulation	Rate	Minimum Sensitivity [dBm]			
			20 MHz	40 MHz	80 MHz	160 MHz
0	BPSK	1/2	-82	-79	-76	-73
1	QPSK	1/2	-79	-76	-73	-70
2	QPSK	3/4	-77	-74	-71	-68
3	16-QAM	1/2	-74	-71	-68	-65
4	16-QAM	3/4	-70	-67	-64	-61
5	64-QAM	2/3	-66	-63	-60	-57
6	64-QAM	3/4	-65	-62	-59	-56
7	64-QAM	5/6	-64	-61	-58	-55
8	256-QAM	3/4	-59	-56	-53	-50
9	256-QAM	5/6	-57	-54	-51	-48

There are a few studies focusing on the adaptation of the CST [10], also integrated in the recent IEEE 802.11ax amendment. They must be understood as a supplementary step to the CCA function. More precisely, when a preamble is correctly decoded, a STA does not directly declare the channel busy. Instead, the STA measures the signal strength of the preamble and declares the channel busy only if this value exceeds the CST. This mechanism increases the spatial reuse in WiFi networks, with the price of increased interference.

An important point about the CSMA/CA protocol is that STAs perform the carrier sense operation over each 20 MHz subchannel of their used channel, one by one. As such, an important point about using wide channels is that, when a STA uses a wide channel (for example a 160 MHz channel), the total transmitted power that it transmits gets distributed over multiple (8) 20 MHz subchannels, resulting in lower values of power being transmitted over each 20 MHz subchannel. In the next sections, we will use this point to mitigate the contention overhead in dense networks (where APs do not need to have high coverage ranges), by using wide channels and power adjustment.

3.2 Benchmarks

Our main question in this work can be formulated as follows: given an enterprise WiFi network, what is the best combination of channel bandwidth (W_j), channel identity, total transmission power (P_j) and channel sensing threshold (CST_j) to allocate to AP j ? This problem is too complex to be addressed analytically and the space of possible solutions is too large to simulate exhaustively along the three axes. Therefore, in order to address the problem, it should be first simplified to some extent. Before explaining our approach, we explain two channel allocation and power management schemes for enterprise networks that try to simplify the problem in different ways and we take them as benchmarks.

Benchmark 1 (Using narrower channels as the deployment density increases)

One common way to allocate channels is to assign narrower channels to APs in dense deployments. This way, each AP will get a narrower channel but with less contention. This has been done in [2], [3], [7] and [1]. Assuming that all APs use the same channel width, the same CST and their maximum power budget, the only parameter we need to determine is the value W of the channel width. The works above show that, under these assumptions, it is better to use $W = 20$ MHz when the network is dense while W can be larger for less dense networks. Note that none of these studies propose a clear criteria to define a dense network.

Benchmark 2 (Decoupled channel allocation and power control)

Some studies [4] simplify the (W_j, P_j, CST_j) allocation problem by assuming the same fixed CST for all APs and by performing a dynamic channel assignment (e.g. DCA [2]) and a transmit power control (e.g. TPC [6]), separately from each other, i.e., in a sequential algorithm. The two algorithms are performed by a central controller connected to all APs in the network.

However, although the two algorithms are performed independently from each other in the central controller, it is obvious that changes in power allocation brought by TPC will yield changes in the results of DCA and vice-versa. The fact is that TPC has no knowledge of the channels that are going to be assigned in the next iteration of DCA. So it assumes that two neighboring APs could be using the same channel at any time. While TPC allocates different powers to different APs, we can compute a lower bound on all the allocated powers by using the lowest possible value for $TPC_{threshold}$ (-80 dBm) and by not applying any hysteresis on power decrease so that TPC can decrease power values as much as possible.

In the next sections, we will use the combination of static DCA (with the same reuse pattern as in Benchmark 1) along with the lower bound for TPC as the second benchmark. The reason it makes sense to use a lower bound on power in this benchmark, is because we will show that around this lower bound, the network performance increases compared to when we allocate the maximum power to APs.

Chapter 4

Network Model

This section discusses the modelling approach we take in this study. We use the ns-3 simulator [5] for studying realistic WiFi networks of different densities. We only consider downlink transmissions, as this is the main use case in WiFi networks. We show all simulation results with a 1% confidence interval.

4.1 Network Topology

Specifically, we consider enterprise WiFi networks consisting of 64 identical APs located on four floors of a building. In each floor, there are 16 APs, each of which is located in one square room, as shown in Fig. 4.1. APs and users in each floor are mounted 1 m above that floor. The AP in each room is located randomly in a square of length 5 m, concentric

1	2	3	4	17	18	19	20	33	34	35	36	49	50	51	52
5	6	7	8	21	22	23	24	37	38	39	40	53	54	55	56
9	10	11	12	25	26	27	28	41	42	43	44	57	58	59	60
13	14	15	16	29	30	31	32	45	46	47	48	61	62	63	64
first floor				second floor				third floor				fourth floor			

Figure 4.1: The network used in the simulations. The figure depicts four floors in a building, with 16 APs deployed per floor, each located in one square room.

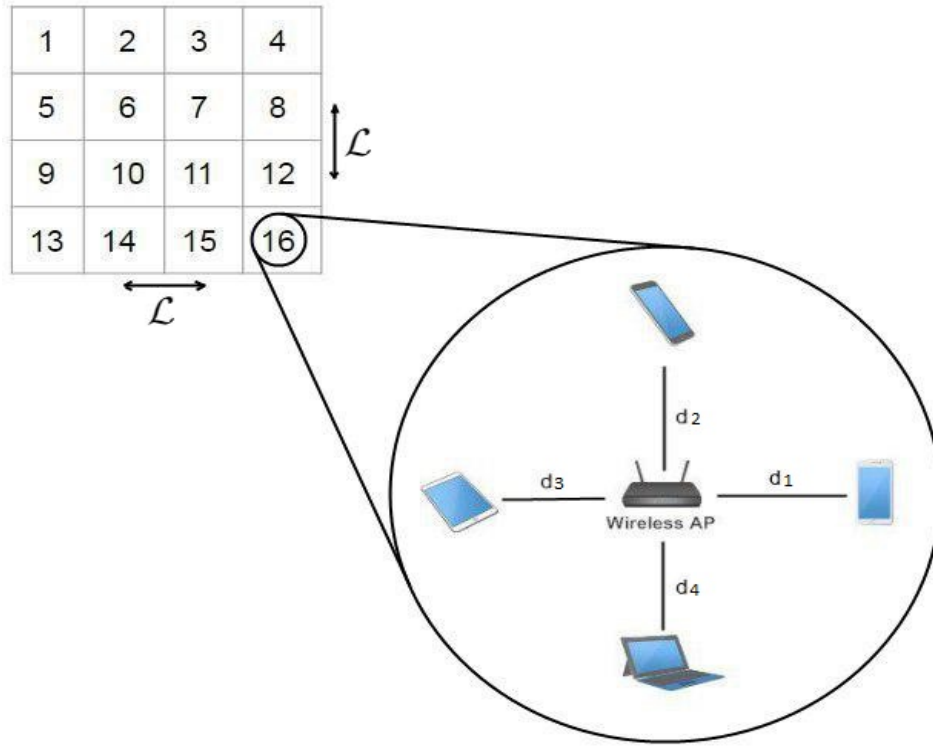

Figure 4.2: The first floor of the simulated network

with the room. There are 4 users located in each room, associated to the AP in the same room (see Fig. 4.2) and placed randomly around it. Users are located in the same room as their associated AP is located.

The distance between two adjacent floors is set to 4 m. The distance between the centers of adjacent rooms (located on the same floor) is denoted as \mathcal{L} . The density of the system can be changed by changing the value of \mathcal{L} .

4.2 Channel Propagation and Power

We use the ns-3 Log Distance Propagation Loss Model and add wall penetration loss effects on top of that by using the ns-3 Building Class. Between two adjacent rooms, there is a wall penetration loss equal to 8 dB. The APs antenna gain is equal to 12 dBi. The antenna

gain on the user side is equal to 0 dBi. In order to study the effect of channel bandwidth and power on the network performance, we have set the number of spatial streams used by the APs to one (SISO).

IEEE 802.11ac is capable of using channels with different bandwidths (multiples of 20 MHz), which is known as the channel bonding feature. The standard introduces the notion of primary channels for the scenarios using more than 20 MHz of bandwidth [17]: an AP intending to use a channel with more than 20 MHz width uses one of the 20 MHz sub-channels as its primary channel, which operates as a control channel. All beacons and management frames are sent over this channel. [16] and [23] showed that it is better for different APs, using the same wide channel, to use the same 20 MHz sub-channel as their primary channel, as it yields better fairness in throughput. This point is explicitly mentioned in [2] and [1] too. Based on this, we assign the same primary channel to APs, whenever allocating them the same wide channel.

There is a limit for the total RF power that can be radiated by antennas in the subband that is used, which is equal to 23 dBm (200 mW). Therefore, when using a channel with bandwidth 20, 40, 80 and 160 MHz, the maximum power that can be transmitted over each 20 MHz subchannel, denoted as P_t^{20} , is equal to 23, 20, 17 and 14 dBm, respectively (assuming that the power budget is shared equally across all 20 MHz subchannels). In this paper, for comparison purposes, we report results with respect to P_t^{20} . However, the relation between P_t^{20} and the total power used by the AP, P_t , is straightforward. For example, if an AP is transmitting on a channel of bandwidth 160 MHz with a total power P_t (dBm) over the entire channel, then $P_t^{20} = P_t - 9$ (dBm), as the total power P_t gets distributed equally over eight 20 MHz subchannels.

When an AP uses a transmission power P_t^{20} for transmitting data on a 20 MHz sub-channel to one of its associated users, situated at distance d from the AP, the ns-3 radio propagation model defines the power received by the user as:

$$P_r^{20}(dBm) = P_t^{20}(dBm) + G_t + G_u - 30 \log_{10} d - 46.677, \quad (4.1)$$

where G_t is the AP antenna gain and G_u is the user antenna gain.

4.3 Traffic and Overall Performance Metric

We assume a full buffer UDP traffic model with a uniform arrival rate equal to 230 Mbps; i.e., the APs have always data to transmit to their users.

The overall performance metric that we use is the geometric mean (GM) of the throughput of all the users existing in the network, $GM_{tot} = \sqrt[N]{\prod_u \lambda_u}$, where λ_u is the downlink throughput seen by user u and N is the number of users in the network. The higher the GM, the more efficient and fair is the network [15], [29]. Using this metric makes sense in an enterprise network where fairness should exist among users (it would be different in a residential setting where each AP could act selfishly).

4.4 Coverage and Transmission Power

We define the coverage range of an AP as the closest distance at which a receiver is not able to decode its transmitted signal; i.e., the received power is over each 20 MHz channel is equal to -82 dBm, according to Table 3.1. Therefore, using Equation (4.1), we can find $P_{t,min}^{20}$, the minimum power on a 20 MHz channel required for an AP to have a desired coverage range R :

$$-82 = P_{t,min}^{20}(dBm) + G_t + G_u - 30 \log_{10} R - 46.677. \quad (4.2)$$

Solving the above equation yields to:

$$P_{t,min}^{20}(dBm) = 30 \log_{10} R - 82 + 46.677 - G_t - G_u. \quad (4.3)$$

If we consider the network topology used during our simulations (Fig. 4.1), each AP needs to have a coverage range which is at least equal to the distance between it and the farthest corner of its room. We add a further 5 m margin to this required coverage range, to make sure that each AP completely covers its corresponding room and a small vicinity around it. Considering the random locations of APs, their minimum required coverage range has a maximum value equal to:

$$R = \frac{\mathcal{L} + 5}{\sqrt{2}} + 5. \quad (4.4)$$

Substituting this required coverage range in Equation (4.3), we can find $P_{t,min}^{20}$ for any value of \mathcal{L} :

$$P_{t,min}^{20}(\mathcal{L}) = 30 \log_{10} \left(\frac{\mathcal{L} + 5}{\sqrt{2}} + 5 \right) - 47.33, \quad (4.5)$$

When the distance \mathcal{L} between adjacent APs decreases (i.e., the deployment density increases), the required coverage range for APs decreases as well, according to Equation

(4.4). Therefore, the transmission power of the APs can be decreased further, following Equation (4.5). This seems reasonable, as dense networks are characterized by a large number of APs serving a small physical area. This is the key point that we use in our proposed solutions.

Given a channel of a specific width allocated to an AP, the values between the computed $P_{t,min}^{20}$ and the maximum P_t^{20} allowed in the standard (for example 17 dBm for a 40 MHz channel) represent the valid range of power values that the AP can choose from. Therefore, for given values of \mathcal{L} (deployment density) and the channel width, there is a TX power range that includes all valid power values which satisfy the coverage requirements of the APs and any regulatory demand.

4.5 Approach

To study the channel, power, and CST allocation problem, we start by allocating the same channel bandwidth, the same P_t^{20} value and the same CST to all the APs in our simulated network. We call that the “uniform AP setting”. For a given value of \mathcal{L} , we can evaluate the network overall performance for each possible channel width and for different valid power values (i.e., for the power in the valid range defined earlier). We do this for three values of CST : -85 dBm, -82 dBm (the default value), and -79 dBm. From this study, we extract the trends on W , CST and P_t^{20} for different values of \mathcal{L} . We, then, consider a simple “non-uniform AP setting” when the APs see drastically different performance.

Chapter 5

Uniform AP Settings

In this section, we allocate the same channel bandwidth, the same P_t^{20} value and the same CST to all the APs in our simulated network. When the channel width is equal to 160 MHz, there is only one available channel for all the APs to use. When the width is equal to 80 MHz bandwidth, there are two distinct channels. In that case, we allocate the channels using a reuse-2 pattern. Similarly, when the width is equal to 40 MHz (20 MHz resp.) there are four (resp. eight) distinct channels. In that case, we allocate the channels using a reuse-4 (resp. reuse-8) pattern.

5.1 $\mathcal{L} = 40$ m

We first consider the case where $\mathcal{L} = 40$ m, which corresponds to a network of low density. We expect that, in this case, a channel width of 160 MHz will be the best choice.

In the following, we report the network overall performance for a typical random realization, as a function of the power, for the four channel widths. In Fig. 5.1, we show the results as a function of the total P_t for different CSTs (we only show results for non default CST for $W = 160$ MHz), while in Figure 5.2, we show the same results as a function of P_t^{20} (i.e., the power per 20 MHz) but for only the default CST. Note that the plots in the first figure are nothing but a shifted version to the right of those in the second figure (with a different shift per width).

The first comment based on Figure 5.1 is that using the widest channel (160 MHz) provides the highest overall performance. The second comment is that the peak performance is obtained for a total transmit power of $P_t(\text{peak}) = 15$ dBm. For transmit power values

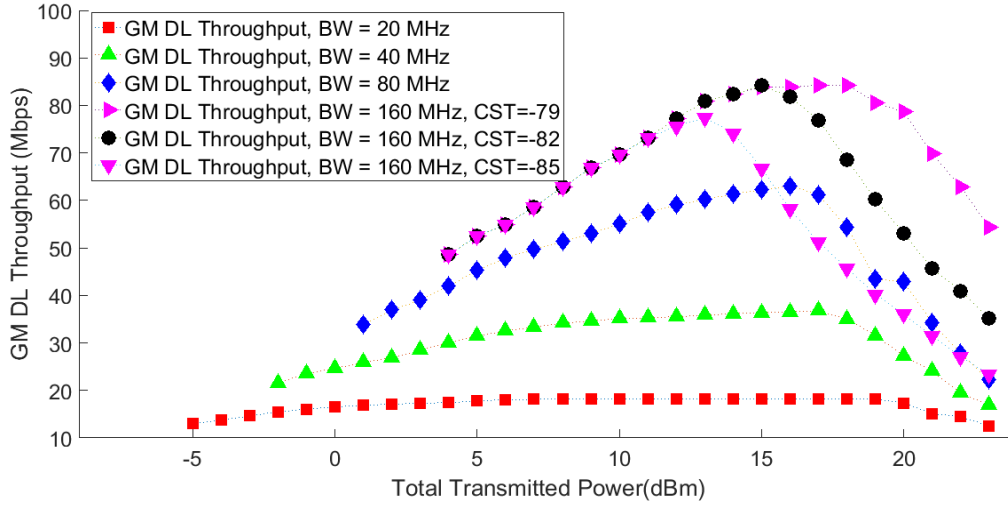

Figure 5.1: The network overall performance vs. P_t for different channel widths and different CSTs, for a random realization and when $\mathcal{L} = 40$ m

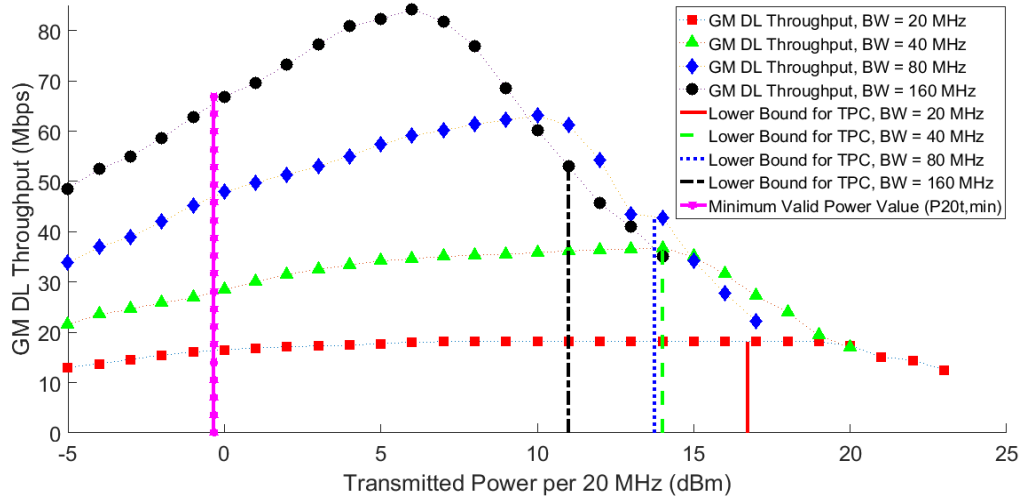

Figure 5.2: The network overall performance vs. P_t^{20} for different channel widths for the default CST, for the same random realization as in Figure 5.1 and when $\mathcal{L} = 40$ m

below $P_t(\text{peak})$, the CST has no impact while CST does have an impact at high power. The reason is that, at low power values, the APs sense each other transmissions much less. Consequently, decreasing or increasing their CST does not affect their throughput much. Since performance at lower power than the peak power is higher than performance at high power, in the following we will focus on one CST value (the default one), except when otherwise specified.

The best performance is ≈ 84 Mbps and is obtained for $W = 160$ MHz and for a relatively low power, i.e., $P_t^{20} \approx 6$ dBm (which is in the valid range of powers). Note that the lower channel widths give much lower peaks. Benchmark 1 would use the maximum power P_t and then would also select $W = 160$ MHz, but the performance would be 35 Mbps, i.e., we can obtain a gain of about 140% with respect to Benchmark 1 by selecting the power carefully.

To compare with Benchmark 2, we show five vertical lines in Figure 5.2. The leftmost one shows the minimum power value necessary for coverage, i.e., $P_{t,min}^{20}$. The four vertical lines at the right of the figure show the lower bounds for the output values of the TPC algorithm for each channel width. Note that the lower bounds in this figure are on P_t^{20} . The best possible values that could be selected by Benchmark 2 are $W = 160$ MHz and $P_t^{20} = 11$ dBm, yielding an overall performance of 53 Mbps, better than Benchmark 1 but much lower than the peak. In that case, a careful choice of power would yield a gain with respect to Benchmark 2 of 58%.

Finally, note that if we use the lowest valid power value ($P_{t,min}^{20}$), which is around 0 dBm (the leftmost vertical line), we would obtain an overall performance that is higher than the one obtained using high power values (i.e., using Benchmark 1 or 2). The reason is that, when decreasing transmission power values in such large networks, the gain obtained from contention mitigation is more than the loss due to lower reception power at users locations. At this minimum power value, the network overall performance (≈ 66 Mbps) is lower than that at the peak point, but this power value is easy to compute and just depends on the APs required coverage range. Using this power value would yield a gain with respect to Benchmark 2 (resp. of Benchmark 1) of 24% (resp 88%).

5.2 $\mathcal{L} = 25$ m

In the following, we increase the deployment density by setting \mathcal{L} to 25 m. We report the results as a function of P_t^{20} in Figure 5.2, when CST has the default value (not anymore, say something about CST). Again, we show the five vertical lines depicting the performance

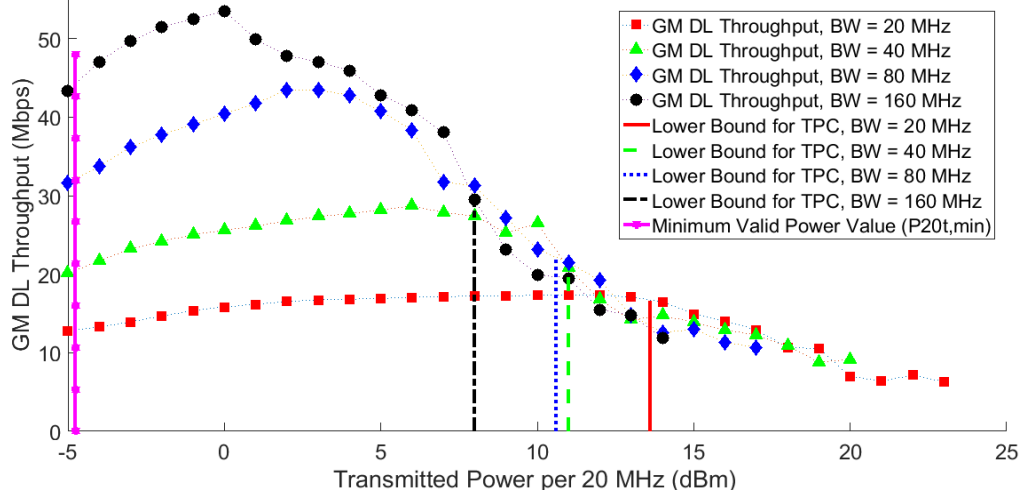

Figure 5.3: The network overall performance vs. P_t^{20} for different channel widths, for a random realization when $\mathcal{L} = 25$ m

of the two benchmark solutions, with the same meaning as in Figure 5.2. The results are even more staggering.

The best performance is ≈ 53 Mbps and is obtained for $W = 160$ MHz and for a relatively low TX power, i.e., $P_t^{20} \approx 0$ dBm (which is in the valid range of powers). Note that the lower channel widths give much lower peaks. Benchmark 1 would use the maximum power P_t and then would also select $W = 160$ MHz, but the performance would be 12 Mbps, about one third of the best achievable performance! To compare with Benchmark 2, we again look at the four rightmost vertical lines in Figure 5.3. The best possible values that could be selected by Benchmark 2 are $W = 160$ MHz and $P_t^{20} = 8$ dBm, yielding an overall performance of 30 Mbps, better than Benchmark 1 but still much lower than the peak. In that case, a careful choice of power would yield a gain with respect to Benchmark 2 of 77%.

Similar to the previous scenario, using the lowest valid power value $P_{t,min}^{20} = -4.7$ dBm (the leftmost vertical line), results in higher overall performance (≈ 44 Mbps) than Benchmark 2. Using this power value would yield a gain with respect to Benchmark 2 (resp. of Benchmark 1) of 47% (resp 266%).

5.3 $\mathcal{L} = 15$ m

This time, we increase the density of the network even more, by setting $\mathcal{L} = 15$ m. We report the results in terms of P_t^{20} in Figure 5.4. As in the previous cases, we show the five vertical lines depicting the performance of the two benchmark solutions.

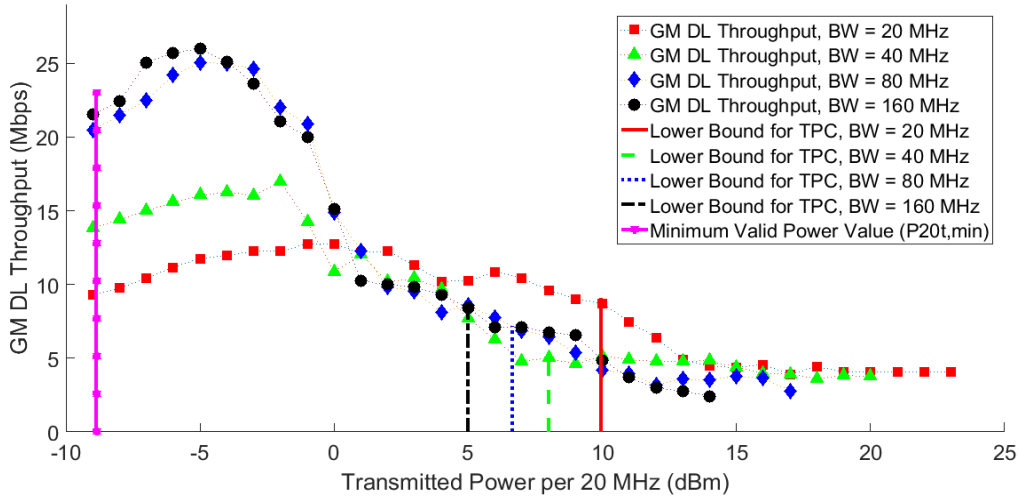

Figure 5.4: The network overall performance vs. P_t^{20} for different channel widths, for a random realization and when $\mathcal{L} = 15$ m

The best performance is ≈ 26 Mbps and is obtained for $W = 160$ MHz (though $W = 80$ MHz does almost as well in this case) and for a low power, i.e., $P_t^{20} \approx -5$ dBm (which is still in the valid range of powers). Benchmark 1 would use the maximum power P_t and then would select $W = 20$ MHz, with a performance of around 5 Mbps, about one fifth of the best achievable performance. To compare with Benchmark 2, we again look at the four rightmost vertical lines in Figure 5.4. The best possible values that could be selected by Benchmark 2 are $W = 20$ MHz and $P_t^{20} = 10$ dBm (a relatively high power), yielding an overall performance of about 9 Mbps, which is again much lower than the peak.

As in the previous cases, using the lowest valid power value ($P_{t,min}^{20}$), which is -8.87 dBm (the leftmost vertical line), results in higher overall performance (≈ 22 Mbps) than using high power values. In the previous figures, we note that the best power value (peak point) and $P_{t,min}^{20}$ depend, among other things, on the density of the network. The denser

the network, the lower the power values. Also, the performance gain with regard to the benchmarks increases with the density of the network.

Message 1: Using a wide channel with low power is significantly more effective than using a narrow channel with any power.

Chapter 6

Non-uniform AP Settings

In the previous section, we observed that, by using the widest channel along with a relatively low power (the value depending on the density of the network among other things), we can achieve a considerable amount of improvement in GM throughput. We also observed that this improvement is achievable even for deployments with high density. We now explore further the distribution of the performance among the APs. More precisely, we will show that there is an unfairness problem in high density scenarios that needs to be solved.

When we use the widest available channel (160 MHz), all the APs in the network share the same resources. Therefore, they suffer from co-channel interference and co-channel contention. What we did so far was trying to mitigate this interference and this contention by adjusting power, while keeping the same CST for all APs. In Figures 6.1 and 6.2, we show, for a typical random realization of APs and users locations, the GM of the throughput obtained on each of the 64 APs (four users associated to each AP). In these results, the APs are all allocated the widest channel (160 MHz), use the corresponding best power value (the peak point) and the default CST value, for $\mathcal{L} = 25$ m and 15 m respectively.

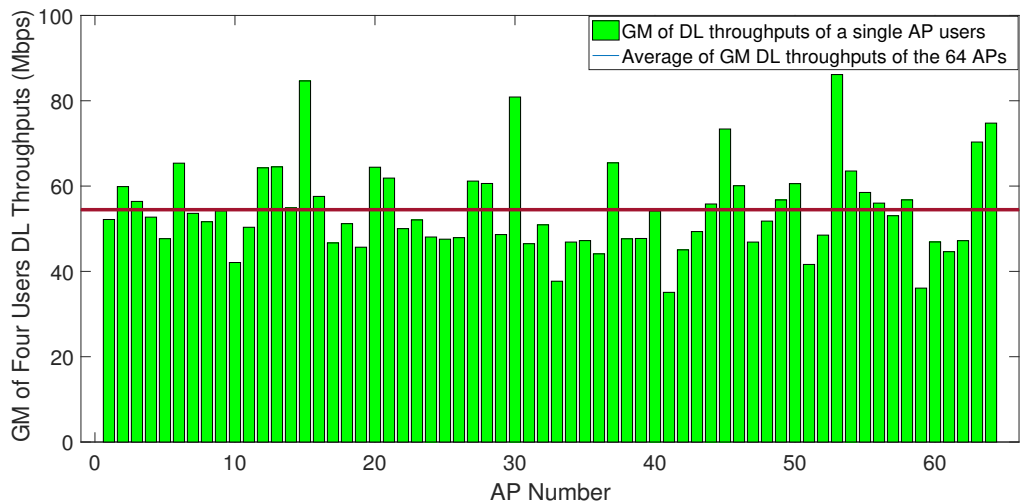

Figure 6.1: The GM throughput of each of the 64 APs in the network (the x-axis is the AP id, please refer to Figure 4.1), for a random realization when $W = 160$ MHz, the power yields the best overall GM and $\mathcal{L} = 25$ m

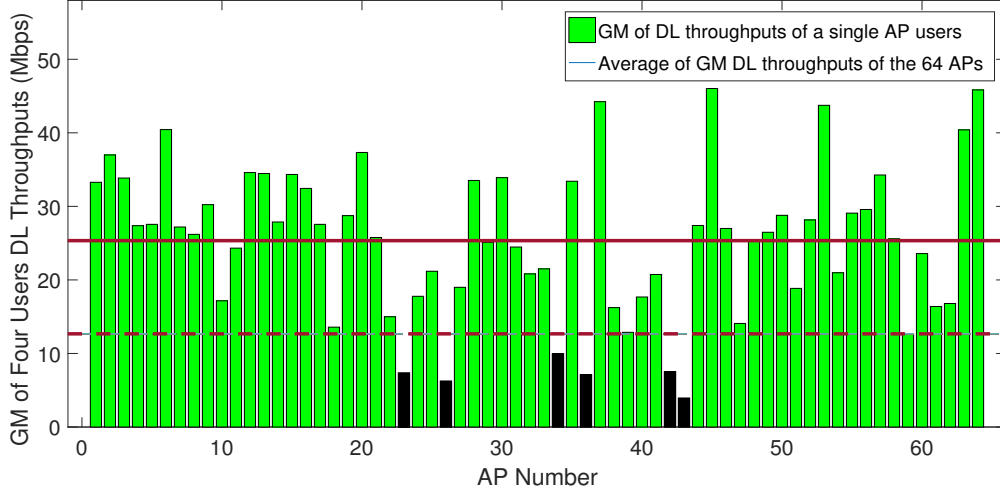

Figure 6.2: The GM throughput of each of the 64 APs in the network (the x-axis is the AP id, please refer to Figure 4.1), for a random realization when $W = 160$ MHz, the power yields the best overall GM and $\mathcal{L} = 15$ m. The dashed line represents half of the arithmetic mean of the GM throughput of the APs

As it can be seen, when the enterprise network is not very dense ($\mathcal{L} = 25$ m), the APs in the networks get more or less the same GM throughput. The small variation among them is due to the random locations of the users and the APs. However, when the network is dense ($\mathcal{L} = 15$ m), there is an unfairness problem among the APs. As it can be seen in Fig. 6.2, some APs see much lower performance than others: APs 23, 26, 34, 36, 42 and 43, i.e., those located in the middle of the network (see Figure 4.1). Specifically, we say that an AP is *poor* if it receives less than half of the arithmetic mean of the GMs of all APs (the dashed line in Fig. 6.2 shows this value).

A similar scenario of unfairness exists when we allocate $P_{t,min}^{20}$ to all APs in the network. To alleviate this unfairness problem, we propose to adjust the power and CST differently for the poor APs, as explained below. Note that CST adjustment was used in [10].

The reasons why the APs located in the middle of the enterprise network are poor are twofold. The first one is that these APs have to contend with a lot of surrounding APs, while this is not the case for APs at the edges. Therefore, one suggestion for helping the poor APs is to increase their CST so that they can get access to the shared channel more easily. The second reason is the higher amount of co-channel interference that the users

of these APs receive. This higher interference impacts the rate seen by these users and can even make the data transmission from these APs unsuccessful. Therefore, one other suggestion for improving the performance of these APs is to increase their transmission power values slightly (the other APs keep the power value determined earlier, i.e., for the case with equal parameters) so that they can combat the higher interference that they experience.

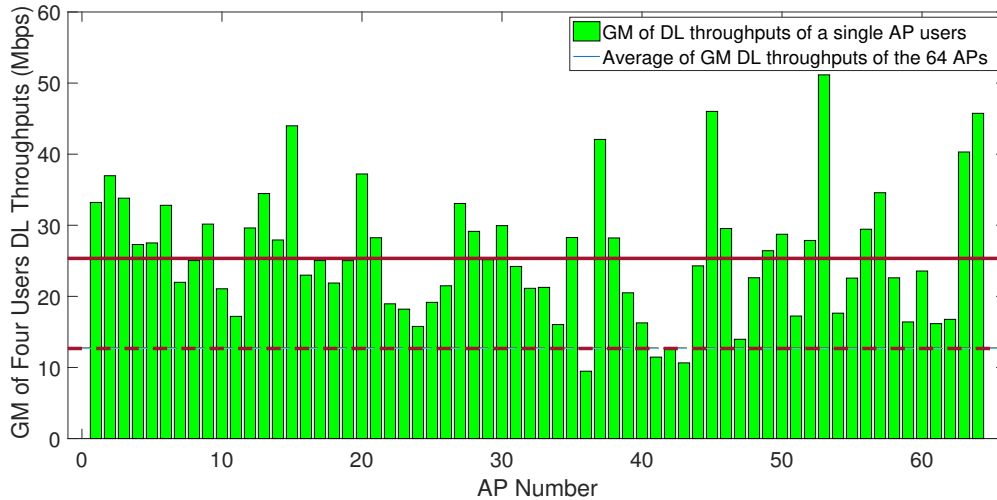

Figure 6.3: The performance of each of the 64 APs in the network when $W = 160$ MHz, the power yields the best overall GM, $\mathcal{L} = 15$ m, for the same realization as in the previous figure, and the poor APs use a CST = -76 dBm

To test these ideas, we consider two values for the CST of the poor APs: -79 dBm and -76 dBm (recall that the default value of the CST used so far was -82 dBm). We also increase their transmission power value by 3 dBm with respect to rich APs, which are allocated either the peak point power value or the $P_{t,min}^{20}$. We call the uniform settings, where all the APs use the same power value (either the power value computed at the 160 MHz peak point or $P_{t,min}^{20}$) and the same CST (-82 dBm) as the "default" setting. We consider all the possible combinations for changing the CST and power value of the poor APs. We report the results obtained from each case in Table 6.1, for a typical realization of the APs and users locations (the same as that in Fig. 6.2). For the results in Table 6.1, the default power allocated to APs is the power value computed at the 160 MHz peak point in Fig. 5.4 (a similar table could be reported for the case when we allocate $P_{t,min}^{20}$

Table 6.1: Performance under non-uniform AP settings for $\mathcal{L} = 15m$. C_{poor+} (resp. P_{poor}) is the increment of CST (resp. increment of TX power) for poor users.

C_{poor+}	P_{poor+}	GM_{tot}	AM_{tot}	GM_{min}
none	none	22.8	29.51	3.92
3	none	23.18	29.72	9.23
6	none	24.24	30.05	9.47
none	3	22.27	29.14	7.21
3	3	21.04	28.58	7.49
3	6	21.14	28.56	7.52

to APs as the default value). The table contains the overall GM throughput GM_{tot} , the overall arithmetic throughput ($AM_{tot} = \frac{1}{N} \sum_u \lambda_u$, where λ_u is the downlink throughput seen by user u and N is the number of users in the network), and the minimum of the GM throughput of each AP.

As it can be observed, although we only slightly increase the overall GM (about 6%), we significantly increase the minimum of all the GM throughput by using non equal parameters. It is better to increase the CST of poor APs, instead of increasing their power values. The reason is that increasing the CST value of poor APs allows more simultaneous transmissions in the network, improving the poor APs performance, and the aggregate throughput in the network increases (our results are compatible with those in [10]). Instead, when we increase the power value of poor APs, their throughput improves, but with the cost of decreasing the overall performance. For the realization above, increasing CST of poor APs by 6 dBm gave the best result. To better observe the impact of the non-uniform settings, we plot in Fig. 6.3 the histogram of GM throughput of the APs in the network for the same realization as in Figure 6.2, after increasing just the CST of poor APs by 6 dBm.

Message 2: Unfairness can be mitigated by clustering the APs into poor and rich, and giving an advantage to the poor APs in terms of CST.

Chapter 7

Proposed Algorithm

Based on the observations in the last two sections, we propose the following coordinated algorithm for assigning channels, transmission power values and CST to different APs in an enterprise network. To use it, the administrator needs to do some measurements on the network overall performance, as explained in the following. This algorithm can be used for scenarios where all APs do not have necessarily the same coverage range (i.e., different $P_{t,min}^{20}$).

In the first step of the algorithm, the administrator selects the largest bandwidth and the default CST to start with and also estimates $P_{t,min}^{20}$ for each AP. In the second step, two schemes can be used for power adjustment, among which the administrator chooses one: either allocating $P_{t,min}^{20}$ of each AP to it or finding the peak power value and allocating it. Finally and in the last step, the algorithm tries to help poor APs. This algorithm can be used each time there is a change in the topology, i.e., an addition or a removal of an AP. The four steps of the algorithm are described below.

Step 1 (Initialization):

1. Allocate the widest available channel (160 MHz) to all APs and the default CST.
2. Using the map of the enterprise network, find the required coverage range for each AP.
3. Find $P_{t,min}^{20}$ for each AP using its required coverage range. This gives the range of valid TX power values for each AP.

Step 2 (Power Adjustment): choose one of the following schemes for power adjustment:

Table 7.1: Performance (GM_{tot}) of the proposed and benchmark methods for random realizations of users and APs

	Benchmark 1	Benchmark 2	Peak Point	$P_{t,min}^{20}$
$\mathcal{L} = 15m$, Realization 0	5	8.72	25.98	23.1
$\mathcal{L} = 25m$, Realization 0	11.87	29.49	53.52	45.3
$\mathcal{L} = 40m$, Realization 0	35.11	53.14	84.03	67.6
$\mathcal{L} = 15m$, Realization 1	4.65	9.66	27.91	24.28
$\mathcal{L} = 25m$, Realization 1	12.96	26.47	52.52	44.4
$\mathcal{L} = 15m$, Realization 2	4.85	8.97	27.85	23.95
$\mathcal{L} = 25m$, Realization 2	13.67	25.03	52.71	44.2

- Scheme 1 (allocating $P_{t,min}^{20}$ to APs): allocate to each AP its $P_{t,min}^{20}$ (computed in Step 1).
- Scheme 2 (allocating the peak power value to APs): starting from each AP being allocated its $P_{t,min}^{20}$, evaluate the network overall performance and iteratively increase the allocated power to each AP by 1 dBm. Stop the iterative process after reaching a local maximum.

Step 3 (Helping Poor APs):

1. Cluster APs using a predetermined threshold (a reasonable one could be half of the arithmetic mean of the GMs of all APs) into poor and rich APs.
2. In order to improve the performance of the poor APs, increase their CST by +3 dBm (several iterations are possible until reaching a local maximum).

Table 7.1 reports the results obtained on several random realizations (including the ones showed above as realizations 0) of APs and users locations per density, i.e., for $\mathcal{L} = 15m$ and $\mathcal{L} = 25m$. New simulation results (realizations 1 and 2) are obtained with a 5% confidence interval. As it can be seen, we obtain very significant performance gains with respect to the best of the two benchmarks.

Chapter 8

Conclusion

We studied the channel allocation, power management and CST adjustment problems jointly in IEEE 802.11ac enterprise networks. We observed that - unlike the current practice - when allocating channels in a dense network, using the maximum allowed transmission power by APs is not appropriate. In dense deployments, there is usually no need to high coverage range for APs. By decreasing their transmission power values, contention overhead decreases and using wide channels becomes profitable, even in dense deployments. This is contrary to what most of the current channel allocation algorithms do, since they tend to allocate narrow channels with high power values in dense deployments. We also observed that using equal CST and power values for all the APs in a network yields unfairness among APs. We propose a method to select the right parameters per AP; in particular, we allocate the widest channel to all APs, and show that it yields very significant gains with respect to the state of the art.

References

- [1] *802.11 ac Channel Planning*. [Online]. Available: <http://www.revolutionwifi.net/revolutionwifi/2013/03/80211ac-channel-planning.html>.
- [2] *Dynamic Channel Assignment (DCA)*. [Online]. Available: https://www.cisco.com/c/en/us/td/docs/wireless/controller/technotes/8-3/b_RRM_White_Paper/b_RRM_White_Paper_chapter_0100.html.
- [3] *High Density Wi-Fi Deployments Guide*. [Online]. Available: [https://documentation.meraki.com/MR/Deployment_Guides/High_Density_Wi-Fi_Deployment_Guide_\(CVD\)](https://documentation.meraki.com/MR/Deployment_Guides/High_Density_Wi-Fi_Deployment_Guide_(CVD)).
- [4] *Radio Resource Management White Paper*. [Online]. Available: https://www.cisco.com/c/en/us/td/docs/wireless/controller/technotes/8-3/b_RRM_White_Paper/b_RRM_White_Paper_chapter_00.html.
- [5] "The network simulator- NS-3.". [Online]. Available: www.nsnam.org/.
- [6] *Transmit Power Control (TPC)*. [Online]. Available: https://www.cisco.com/c/en/us/td/docs/wireless/controller/technotes/8-3/b_RRM_White_Paper/b_RRM_White_Paper_chapter_0101.html.
- [7] *Very High-Density 802.11ac Networks Planning Guide*. [Online]. Available: https://www.johnlose.de/wp-content/uploads/2018/07/Aruba_VHD_VRD_Planning_Guide.pdf.
- [8] A. Hills. Large-Scale Wireless LAN Design. *IEEE Commun. Mag.*, November 2001.
- [9] B. A. H. S. Abeysekera, M. Matsui, Y. Asai, and M. Mizoguchi. Network Controlled Frequency Channel and Bandwidth Allocation Scheme for IEEE 802.11a/n/ac Wireless LANs: RATOP. In *2014 IEEE 25th Annual International Symposium on Per-*

- sonal, Indoor, and Mobile Radio Communication (PIMRC)*, pages 1041–1045, Sept 2014.
- [10] M. S. Afaqui, E. Garcia-Villegas, E. Lopez-Aguilera, G. Smith, and D. Camps. Evaluation of Dynamic Sensitivity Control Algorithm for IEEE 802.11ax. In *2015 IEEE Wireless Communications and Networking Conference (WCNC)*, pages 1060–1065, March 2015.
 - [11] A. Akella, G. Judd, S. Seshan, and P. Steenkiste. SelfManagement in Chaotic Wireless Deployments. In *ACM Mobicom*, September 2005.
 - [12] B. Alawieh, Y. Zhang, C. Assi, and H. Moustah. Improving Spatial Reuse in Multihop Wireless Networks - A Survey. *IEEE Communications Surveys Tutorials*, 11(3):71–91, rd 2009.
 - [13] Y. Bejerano, S. Han, and L. Li. Fairness and Load Balancing in Wireless LANs Using Association Control. *IEEE/ACM Transactions on Networking*, 15(3):560–573, June 2007.
 - [14] M. Dianu, J. Riihijärvi, and M. Petrova. Measurement-Based Study of the Performance of IEEE 802.11 ac in an Indoor Environment. In *IEEE International Conference on Communications (ICC)*, pages 5771–5776, June 2014.
 - [15] D. Fooladivanda and C. Rosenberg. Joint resource allocation and user association for heterogeneous wireless cellular networks. *IEEE Transactions on Wireless Communications*, 12(1), January 2013.
 - [16] M. X. Gong, B. Hart, L. Xia, and R. Want. Channel Bounding and MAC Protection Mechanisms for 802.11ac. In *2011 IEEE Global Telecommunications Conference - GLOBECOM 2011*, pages 1–5, Dec 2011.
 - [17] IEEE Std 802.11ac. IEEE Standard for Information Technology - Telecommunications and Information Exchange Between Systems - Local and Metropolitan Area Networks - Specific Requirements - Part 11: Wireless LAN Medium Access Control (MAC) and Physical Layer (PHY) Specifications - Amendment 4: Enhancements for Very High Throughput for Operation in Bands below 6 GHz. 2013.
 - [18] K. K. Leung and B. J. Kim. Frequency Assignment for IEEE 802.11 Wireless Networks. IEEE 58th Vehicular Technology Conference (VTC), 2003.

- [19] L. Kriara, E. C. Molero and T. R. Gross. Evaluating 802.11ac features in indoor WLAN: an empirical study of performance and fairness. 10th ACM International Workshop on Wireless Network Testbeds, Experimental Evaluation, and Characterization, October 2016.
- [20] M. Achanta. Method and Apparatus for Least Congested Channel Scan for Wireless Access Points. US Patent No. 20060072602, April 2006.
- [21] P. Mahonen, J. Riihijarvi, and M. Petrova. Automatic Channel Allocation for Small Wireless Local Area Networks Using Graph Colouring Algorithm Approach. In *2004 IEEE 15th International Symposium on Personal, Indoor and Mobile Radio Communications (IEEE Cat. No.04TH8754)*, volume 1, pages 536–539 Vol.1, Sept 2004.
- [22] A. Mishra, V. Brik, S. Banerjee, A. Srinivasan, and W. Arbaugh. A Client-Driven Approach for Channel Management in Wireless LANs. In *Proceedings IEEE INFOCOM 2006. 25TH IEEE International Conference on Computer Communications*, pages 1–12, April 2006.
- [23] M. Park. IEEE 802.11ac: Dynamic Bandwidth Channel Access. In *2011 IEEE International Conference on Communications (ICC)*, pages 1–5, June 2011.
- [24] R. Karmakar, S. Chattopadhyay and S. Chakraborty. Channel Access Fairness in IEEE 802.11ac: A Retrospective Analysis and Protocol Enhancement. Proceedings of the 14th ACM International Symposium on Mobility Management and Wireless Access, 2016.
- [25] R. C. Rodrigues, G. R. Mateus, and A. A. F. Loureiro. On the Design and Capacity Planning of a Wireless Local Area Network. In *NOMS 2000. 2000 IEEE/IFIP Network Operations and Management Symposium 'The Networked Planet: Management Beyond 2000' (Cat. No.00CB37074)*, pages 335–348, April 2000.
- [26] L. Simic, J. Riihijarvi, and P. Mahonen. Measurement Study of IEEE 802.11ac Wi-Fi Performance in High Density Indoor Deployments: Are Wider Channels Always Better? In *Proc. IEEE WoWMoM*, pages 1–9, June 2017.
- [27] A. Vasan, R. Ramjee, and T. Woo. ECHOS - enhanced capacity 802.11 hotspots. In *Proceedings IEEE 24th Annual Joint Conference of the IEEE Computer and Communications Societies.*, volume 3, pages 1562–1572 vol. 3, March 2005.

- [28] Y. Zeng, P. H. Pathak, and P. Mohapatra. A First Look at 802.11ac in Action: Energy Efficiency and Interference Characterization. In *2014 IFIP Networking Conference*, pages 1–9, June 2014.
- [29] Y. Özcan and C. Rosenberg. Efficient loss-aware uplink scheduling. In *2018 IEEE Wireless Communications and Networking Conference (WCNC)*, pages 1–6, April 2018.