

**Psychometric correlates of multisensory integration as potential
predictors of cybersickness in virtual reality**

by

Ogai Sadiq

A thesis

presented to the University Of Waterloo

in fulfillment of the

thesis requirement for the degree of

Master of Science

in

Kinesiology

Waterloo, Ontario, Canada, 2019

© Ogai Sadiq 2019

Author's declaration

I hereby declare that I am the sole author of this thesis. This is a true copy of the final thesis, including any required final revisions, as accepted by my examiners.

I understand that my thesis may be made electronically available to the public.

Abstract

Humans are constantly presented with rich sensory information through the environment that the central nervous system (CNS) must process to form a coherent perception of the world. While the CNS may be efficient in doing so in natural environments, human-made environments such as virtual reality (VR) pose challenges for the CNS to integrate multisensory information. While VR systems are becoming widely used in various fields, it often causes cybersickness in users. Cybersickness may be due to temporal discrepancies in visually updating the environment after a movement. We sought to assess whether individual differences in the parameters of temporal order judgement of multisensory cues are related to cybersickness. We tested 50 participants in two different tasks. The first task involved two temporal order judgements, 1) an audio-visual (AV) and 2) an audio-active head movement (AAHM) task where participants were presented with sound paired with a visual or head movement stimulus at different stimulus onset asynchronies. The second task involved exploration of two VR experiences for 30 minutes each where participants' cybersickness was quantified every 2 minutes on the fast motion sickness scale and also at the end of the 30-minute period using the simulator sickness questionnaire (SSQ). Participants' visual acuity was also assessed. Results demonstrate that there is a positive correlation between total SSQ scores and the temporal binding window (TBW) and point of subjective simultaneity (PSS) measures. These indicate that individuals with wider AV TBWs or larger PSS measures may be more susceptible to cybersickness. We also find that individuals with higher visual acuity report lower sickness symptoms which is contrary to previous studies. Results from such findings will generate a better understanding of cybersickness in VR which in turn can be used for future development of virtual environments so as to be able to minimize discomfort.

Acknowledgements

First and foremost, I would like to convey my gratitude to my supervisor Dr. Michael Barnett-Cowan for believing in me and allowing me to take on this thesis. Thank you for spending all those hours to guide and mentor me throughout this process. This thesis changed directions many times. Each time I would give up hope that anything good can come out of this. But you continuously helped put things into perspective and were really patient with me, my silly mistakes, and the numerous emails I would send you all the time. I want to thank you from the bottom of my heart for giving me this opportunity where I learned so much in every step. This would not have been easy if it wasn't for an amazing supervisor like you.

I would also like to acknowledge my committee members Dr. Ewa Niechwiej-Szwedo and Dr. Richard Staines for their constructive feedback and their insight which allowed me to look at my work from a different perspective. I am grateful to have had the pleasure to get to learn from you. Thank you for your warm and welcoming attitude and for all your support throughout this process.

Additionally, I would like to thank my lab and colleagues for their constructive feedback and their patience for sitting through my numerous practice talks. Particularly, I want to thank Mark Laylor, my friend and colleague who was always there when I needed a critical eye or just someone to share my “thesis grief” with. You will not admit this, but you’ve been a big support.

My journey throughout my MSc would not have been possible without the support of my family members; my amazing siblings and particularly my mum, Huma Sadiq. There were days when I would go home exhausted and almost ‘fed-up’ with my thesis; basically, ready to give up. She would sit there and listen to me rant or vent without hesitation. In return, she would give me a few words of encouragement and hugs which were enough for another couple of weeks of motivation. I truly love you and appreciate every little thing you’re doing for me mum.

Last but not least, I want to genuinely thank Hosai Sadiq, Aleena Naseemi and my dear partner Zubear for their constant words of encouragement, wisdom and endless love. Most importantly thank you for being there for me. You have each supported me in so many ways that I cannot be appreciative enough for.

Table of contents

Author's declaration	ii
Abstract	iii
Acknowledgements	iv
List of abbreviations	vii
List of figures	viii
List of tables	ix
Chapter 1: Introduction	
1.1 Overview	1-2
1.2 Section A: Sensory integration in time	
1.2.1 Defining integration of sensory systems	2-7
1.2.2 Central structures of sensory integration.....	7-12
1.2.3 Psychophysical estimates of perceived simultaneity	13-14
1.2.4 Temporal order judgements within auditory, visual and vestibular cues ...	14-19
1.3 Section B: Cybersickness and underlying factors	
1.3.1 Defining motion sickness and cybersickness	19-20
1.3.2 Delay between sensory events and cybersickness.....	20-21
1.3.3 The sensory conflict theory	21-26
1.3.4 Measures used to quantify cybersickness	26-27
1.4 Section C: Current study	
1.4.1. Psychometric stimuli in this study	28- 29
1.4.2 Study objectives and hypotheses	29- 31
Chapter 2: Materials and methodology	
2.1 Participants	32
2.2 General protocol	32
2.3 Psychophysical TOJ tasks	33- 37
2.4 Virtual reality tasks	38- 40
2.5 Data analysis	40- 46
2.6 Statistical analysis	46- 47

Chapter 3: Results

3.1	Normality test	48-49
3.2	TOJ results	50-52
3.3	Cybersickness results measured through the SSQ	53-54
3.4	Correlational data	55-63

Chapter 4: Discussion

4.1	General discussion	64
4.2	TOJ findings	65-69
4.3	Cybersickness severity in two VR conditions	69-72
4.4	Correlational findings	72-77

Conclusion	78-79
------------------	-------

References	80-86
------------------	-------

Appendix	87-92
----------------	-------

List of abbreviations

CNS	Central Nervous System
TOJ	Temporal Order Judgement
SOA	Stimulus Onset Asynchrony
JND	Just Noticeable Difference
TBW	Temporal binding window
PSS	Point of subjective simultaneity
AV	Audio-visual
AAHM	Audio-active head movement
SSQ	Simulator Sickness Questionnaire
FMS	Fast Motion Sickness scale
VR	Virtual reality
AD	ADRIFT
FC	First Contact
HMD	Head mounted display

List of figure

Figure 1: Schematic representation of a typical audio-visual TOJ	14
Figure 2: Sample audio-visual TOJ data from Bedard and Barnett-Cowan (2016)	16
Figure 3: Sample audio-active head movement TOJ from Barnett-Cowan and Harris (2011) ..	18
Figure 4: Sensory conflict model proposed by Reason (1978)	23
Figure 5: Model for the vertical mismatch theory by Bos et al., (2008)	24
Figure 6: Schematic representation for visual acuity program	33
Figure 7: Schematic representation of the TOJ paradigm with the auditory and visual stimuli .	34
Figure 8: This is a schematic of the audio-active head movement TOJ paradigm	35
Figure 9: Screenshots of the two VR environment as well as the VR experimental set-up	40
Figure 10: Depiction of how head movement onset was determined	43
Figure 11: Sample data from the audio-visual and audio-active head movement TOJ	44
Figure 12: Audio-visual TOJ group average data with individual data in gray and audio-active head movement TOJ group average data with individual data fits	51
Figure 13: Pearson correlations between the TBW (a) and PSS (b) measures of the two stimuli pairs, audio-visual (AV) and audio-active head movement (AAHM)	52
Figure 14: Box-plots of the SSQ scores for AD and FC	54
Figure 15: Correlations between AD SSQ scores and audio-visual TBW	56
Figure 16: Correlations between AD SSQ scores and audio-visual PSS	57
Figure 17: Correlations between AD SSQ scores and audio-active head movement TBW	58
Figure 18: Correlations between AD SSQ scores and audio-active head movement PSS	59
Figure 19: Correlations between AD SSQ and visual acuity scores	60

List of tables

Table 1: Simulator Sickness Questionnaire symptoms classified into the three subscales	45
Table 2: Shapiro-Wilk normality results for SSQ scores (audio-visual TOJ group)	49
Table 3: Shapiro-Wilk normality results for SSQ scores (audio-active head movement TOJ group)	49
Table 4: Summary of descriptive statistics of TOJ results.....	51
Table 5: Summary of descriptive statistics of cybersickness scores	54
Table 6: Correlation statistics between audio-visual TOJ and SSQ scores	61
Table 7: Correlation statistics between audio-active head movement TOJ and SSQ scores	61
Table 8: correlation statistics between visual acuity and SSQ scores	62
Table 9: The correlation confidence intervals are shown in this table for each correlation with the AD SSQ scores	62
Table 10: The correlation confidence intervals are shown in this table for each correlation with the FC SSQ scores	63
Table 11: The correlation confidence intervals are shown in this table for each correlation with the AD SSQ scores and visual acuity measures	63

1.0 Introduction

1.1 Overview

In order to form a coherent perception of the environment, the central nervous system (CNS) must solve the problem of processing and integrating incoming multisensory information. This information which can vary in the spatial and temporal domain can arise from the external environment as well as internally within the body. Solving this problem is ever more critical when the CNS is presented with discrepant multisensory information such as in human-made environments. One such example is Virtual reality (VR) which is a computer-generated simulation that largely manipulates visual surroundings that are updated when the observer moves in the real world.

While VR has great potential as a tool for entertainment, education, research and rehabilitation, it often causes sickness (known as cybersickness) in users, due to temporal and spatial discrepancies between multisensory cues from the virtual and real environments. While spatial discrepancies are largely resolved in current head mounted display (HMD) VR experiences, temporal discrepancies still persist and are often in the order of ~20 ms or more from head movement to visual updating (Raaen and Kjejlmo, 2015). In addition to hardware related temporal discrepancies, there is ever mounting evidence that there are individual differences in the way that the CNS binds multisensory information in time. Such differences have been found when measuring perceptual thresholds for the point of subjective simultaneity (PSS; temporal asynchrony at which observers perceive stimuli as simultaneous with the highest

probability) and the temporal binding window (TBW; maximal asynchrony at which stimuli may still be integrated) of multisensory events.

Here, we aimed to determine the relationship between the PSS and TBW with self-reported measures of cybersickness severity when participants were exposed to VR content that is less or more likely to induce cybersickness. Establishing whether cybersickness can be predicted from psychophysical measures of multisensory temporal perception could not only help us better understand CNS function but also reduce cybersickness.

In this thesis I first provide a general literature review related to how the CNS processes multisensory information in time with an emphasis on psychophysical measures of temporal perception. Then I provide an overview summary of the literature related to cybersickness, its possible mechanisms in relation to the sensory conflict theory, and how it is typically measured. Finally, I will propose a novel approach to understanding the possible relationship between measures of temporal perception and cybersickness using a series of experiments in VR. This thesis aimed to determine whether integration of multisensory cues in time may be potential predictors of cybersickness in VR.

1.2 Section A: Sensory integration in time

1.2.1. Defining integration of sensory systems

With constant flow of sensory cues, the CNS has a crucial role in determining which information to integrate in order to form a coherent perception of the environment. Typically, information about a single event is conveyed through multiple sensory modalities, known as sensory redundancy, to form a multisensory percept. The availability of redundant information is beneficial to human perception as it enhances the reliability of the signal about an event (King, 2005). Integration of multisensory cues occurs with stimuli that share similar spatial and

temporal properties. However, before the signal reaches the CNS, it must first be detected by the sensory organs. Each sensory modality is associated with sensory organs that transduce their respective physical energies (e.g., a photon of light) into neural signals that are then transmitted throughout the CNS to both sensory-specific and multisensory regions. The three major sensory systems emphasized in this thesis are the visual, auditory and vestibular systems which are briefly reviewed below.

Visual processing

Light energy travels at 300,000,000 m/s which effectively means that the delay between the onset of a light stimulus and it reaching the eyes is considered to be instantaneous for events occurring near the observer. Photons of light are transduced into electrical neural signals in the photoreceptors (rods and cones) of the retina due to changes in the conformation of chemical units. Each photoreceptor consists of a chromophore that is bound to an opsin receptor in the membrane. The chromophore contains retinal (aldehyde of Vitamin A) that is responsible for light absorption. When a photon enters the eye, it is absorbed by retinal which then leads to a cascade of events leading to transduction (Kandel et al., 2013, pg. 510-520). Specifically, when struck by a photon the configuration of retinal changes from 11-*cis* to all-*trans* retinal which causes the activation of transducin which is an intracellular messenger protein (Kandel et al., 2013, pg. 510-520). Activation of transducing then leads to activation of photodiesterase at the photoreceptor membrane which lowers the levels of cGMP (cyclic guanosine monophosphate; Kandel et al., 2013, pg. 510-520). Lower concentration of cGMP causes ion channels (that are responsible for Na⁺ and Ca²⁺ intake) to close leading to the hyperpolarization of the photoreceptor (Kandel et al., 2013, pg. 510-520). Unlike other sensory systems, hyperpolarization of the cell leads to conversion of the photon into neural signals.

In general, the transduction time for visual stimuli is ~15-93 ms (Kuffler, 1953). An explanation for the large range in the transduction time might be due to the impact of various factors related to the properties of the visual stimulus such as the intensity or the region of stimulation on the retina. Following the transduction of the photon, the neural signal travels within the retina to retinal ganglion cells. The retina consists of magnocellular-projecting cells (m-cells) and parvocellular-projecting cells (p-cells) which send information to either the magnocellular or the parvocellular layers of the lateral geniculate nucleus (Croner and Kaplan, 1996). M-cells typically have larger receptive fields than p-cells and respond to transient changes in luminance and motion while p-cells process colour and fine detail (Croner and Kaplan, 1996). The signal then travels along the optic nerve and optic tract towards the primary visual cortex (V1) after being relayed in the lateral geniculate nucleus (Kandel et al., 2013, pg. 555-576). Area V1 performs the cortical processing of the visual input and then sends this information to higher order cortical areas (i.e., V2-V5) devoted to visual processing (Kandel et al., 2013, pg. 555-576).

Higher order visual areas then follow along two main streams of processing: the ventral and dorsal stream. The ventral stream leads from area V4 which processes perception of object form and colour while the dorsal stream leading from V5 processes orientation and motion (Goodale, 2011; Ungerleider and Mishkin, 1982). Researchers postulate that object recognition is performed by the ventral stream and object localization and action through the dorsal stream. Visual information has been found to be integrated with other sensory signals throughout the CNS at early levels of processing in subcortical (eg., superior colliculus) as well as cortical areas (eg., V1 through higher level multisensory association areas in the parietal and temporal cortices).

Auditory processing

Sound is propagated in the external environment by changes in air pressure that travel at 330 m/s. These changes in air pressure are initially funnelled into the ear canal and travel through the external acoustic meatus leading to the vibration of the tympanic membrane (i.e., ear drum). Displacement of the tympanic membrane moves the incus, malleus and stapes that move together to amplify changes in air pressure by vibrating a smaller membrane of the oval window that in turn displaces fluid contained within the cochlea, which is the organ responsible for hearing (Kandel et al., 2013, pg. 682-710). The cochlea houses hair cell receptors that are arranged along a basilar membrane which is sensitive to vibrations at different frequencies. Cochlear hair cells transduce fluid (endolymph and perilymph) movement into neural signals specific to different frequencies through the cochlear division of the eighth cranial nerve (Kandel et al., 2013, pg. 682-710). Mechanical energy is transduced into a neural signal by bending of hair cells that causes opening of potassium ion (K^+) channels leading to K^+ influx thereby depolarizing Ca^{+2} channels. Depolarization of the Ca^{+2} channels lead to the release of neurotransmitters from the hair cell that in turn leads to an increase in the firing of the afferent auditory fibers (Corey et al., 2017). Importantly, the transduction time for auditory stimuli is 40 μs (Corey and Hudspeth, 1979). The signal is transmitted through the superior olivary nucleus, through the inferior colliculus and relayed in the medial geniculate nucleus of the thalamus. After being relayed in the thalamus, the signal is transmitted towards the primary auditory cortex located in the temporal lobe in the Heschel's gyrus which performs cortical processing of the auditory input (Kandel et al., 2013, pg. 682-710). Similar to the visual system, the primary auditory cortex transmits information to higher order association areas (i.e., dorsal and ventral streams) dedicated to auditory processing. The ventral stream is important for sound recognition which

involves the ventral premotor cortex that processes the meaning and source of the sound (Hickok and Poeppel, 2015; Kandel et al., 2013, pg. 682-710). The dorsal stream is important for action and orientation, involving the posterior parietal cortex which processes sound localization. Auditory information is integrated with other sensory modalities at early stages of processing (e.g, audio-visual integration) as well as higher order multisensory areas and subcortical structures of the brain stem (eg., superior colliculus).

Vestibular system

The vestibular system senses angular and linear (i.e., translational and gravitational) acceleration of the head. Amongst its wide variety of functions, the vestibular system signals information for body position and orientation and it regulates eye and body movement for perceptual and postural stability. It consists of five anatomical structures within each ear, the semicircular canals (anterior, horizontal, and posterior) and the otolith organs (utricle and saccule) located in the membranous labyrinth inside the bony labyrinth of the inner ear (Kandel et al., 2013, pg. 917-924). Semicircular canals sense angular acceleration while the otoliths sense gravitational and linear acceleration of the head (Cullen and Roy, 2004). The semicircular canals are organized orthogonal to each other and have bulb-like structures called ampullae consisting of sensory receptors called cristae. Cristae receptors consist of hair cells that are displaced by the movement of endolymph upon head rotation (Kandel et al., 2013, pg. 917-924). When a head rotation occurs, the semicircular canals are activated in one ear and inhibited in the other. Otolith organs have similar sensory receptors that consist of hair cells that bend upon changes in linear acceleration of the head. Otolithic hair cells are bent when an otoconia membrane (calcium carbonate deposits) is displaced in the opposite direction of the head movement (Corey et al., 2017; Kandel et al., 2013, pg. 917-924).

Hair cell bending causes opening of potassium ion (K^+) channels leading to K^+ influx thereby causing depolarization of Ca^{2+} ion channels. Depolarization of Ca^{2+} channels results in the release of neurotransmitters from the hair cell which in turn leads to an increase in the firing rate of the afferent vestibular fibers. Since there are two vestibular end organs (one in each ear), when one set of canals are activated, the other is inhibited. Hence, the semicircular canals of the opposite side are hyperpolarized (due to K^+ channel closure causing hyperpolarization of the Ca^{2+} channels) thereby leading to a decrease in the firing rate of the vestibular nerve. The vestibular system has tonic discharge of signals at all times, however during changes in head movement, the firing rate either increases or decreases. After transduction of the mechanical energy into a neural impulse, the vestibular nerve projects the information to the vestibular nucleus which either ascends towards the cortex for perception, orientation and posture or descends to other motor pathways in the brainstem (e.g., abducens nucleus for vestibular-ocular reflex). Cortical areas associated with vestibular function include Brodmann area 2v, the parietoinsular vestibular cortex (PIVC) and Brodmann area 3a (Brandt and Dieterich, 2006). Vestibular information has been found to be integrated with other sensory modalities at very early stage of processing in areas such as the vestibular nucleus as well as cortical association areas.

1.2.2 Central structures of sensory integration

It was initially thought that sensory information is first processed in their respective sensory specific cortical areas, and then it may be integrated in other multisensory cortical regions. While studies show that this is generally true, multisensory processing has been shown to affect traditionally defined modality-specific areas. This is illustrated in Calvert and colleagues' (1997) work where overlapping activation patterns in the auditory cortex are found when participants were presented with a combination of auditory speech and visual lip movements as well as lip

movements without auditory information. Regarding temporal perception of multisensory stimuli, in a reaction time task, Molholm and colleagues (2002) assessed cortical activation patterns in response to unisensory and multisensory auditory (pure tone) and visual (white disk) events using electroencephalogram (EEG) recordings. Here, audio-visual stimuli were either presented alone with stimulus onset asynchronies (SOAs) ranging from 750 to 3000 ms, or they were presented simultaneously. Participants were instructed to make speeded responses without errors as soon as stimuli from either modality was detected. Event related potentials (ERPs) demonstrated that multisensory audio-visual conditions elicited greater activation compared to the sum of unisensory conditions. More interestingly, they found early multisensory activity in primary visual processing areas 46 ms after stimulus presentation. Given the fact that the visual ERP component is observed around 40 to 65 ms after stimulus onset, this observation supports the idea that multisensory interaction between audiovisual stimuli occur before unisensory visual processing is complete. Additionally, this result suggests that auditory processing may modify early visual processing through different feedforward neural projections. This could be because auditory processing occurs much quicker than visual as shown by auditory ERP components that are observed with a latency around 15 ms.

This phenomenon is also witnessed amongst visual and vestibular interactions. Unlike primary cortical areas dedicated for visual and auditory processing, there are no defined and dedicated areas for pure vestibular processing. Rather, vestibular cues are processed in various cortical regions where it induces multisensory interactions within other sensory systems including visual, auditory and somatosensory (Angelaki and Hess, 2005). Considering the multisensory nature of vestibular function (eg., postural control or gaze control) it makes sense why its central processing areas are so dispersed and interconnected to other sensory processing

regions. Work in primates has shown that vestibular cues may be integrated in extrastriate visual areas such as the dorsal medial superior temporal region (MSTd). Gu and colleagues (2007) trained monkeys on a heading perception task where they translated them in the horizontal direction either to the right or left and had the monkeys respond to the direction they were moved in relative to straight ahead. Throughout the task, experimenters recorded from neurons in the MSTd. Psychophysical data and neuronal recordings suggested that although the MSTd area functions in perception of visual motion (through optic flow), it is also involved in heading perception based solely on vestibular (i.e., inertial) cues. To verify that activations in the MSTd neurons were in response to pure vestibular stimulation, experimenters tested monkeys who had their vestibular systems removed by labyrinthectomy and found that there were no correlations between behavioural responses and neuronal responses for heading direction. While direct neuronal recordings are rarely acquired in humans, neuroimaging techniques such as fMRI and EEG have revealed information about the neural substrates of multisensory integration in humans.

Therefore, in addition to the work by Gu et al., (2007), Nolan and colleagues (2012) conducted a similar experimental study in humans using EEG. They identified vestibular evoked ERP components in the frontal and temporal-parietal areas upon stimulation of the semicircular canals through passive body rotations in the horizontal direction (i.e., right or left). This showed that, similar to visual and auditory processing, vestibular processing also has primary ERP components even though its mechanism remains to be determined. Similar work in humans using the ERP technique and passive body-motion has also shown that cortical responses to self-motion are more delayed than other sensory stimuli. Here, vestibular-ERPs were observed about

200 ms or later after stimulus onset while the onset of the auditory- and visual-ERPs occurred less than 100 ms after stimulus onset (Barnett-Cowan et al., 2010; Varghese et al., 2017).

fMRI studies have also revealed activation of cortical areas related to eye movements in the precentral gyrus of the frontal lobe elicited by galvanic vestibular stimulation (GVS; Bense et al., 2001). Cortical areas implicated here are the frontal eye fields and an area anterior to the frontal eye fields, which are collectively responsible for torsional, saccadic and smooth pursuit eye movements. Another cortical area with ocular motor function, the prefrontal cortex, was also activated by GVS. An explanation for why vestibular stimulation elicits activation in visual processing areas may be that visual and vestibular end organs work together for functions such as gaze and postural control.

In addition to interactions seen in the primary sensory cortices, multisensory cues also interact in multimodal association cortical regions. Neuroimaging studies in humans find the common multisensory regions to be the intraparietal sulcus (IPS), inferior parietal lobule, posterior part of the superior temporal sulcus (STS), and ventral premotor cortex (Macaluso, 2006). Audio-visual integration is found in the STS areas as well as areas in the parietal and occipital cortices. Using EEG, Giard and Peronnet (1999) then later Molholm et al., (2002) assessed cortical activation patterns upon perception of audio-visual events that were either synchronous or asynchronous. They found that ERP components associated with audio-visual integration were observed with greatest activation in the occipital-parietal regions. Since EEG does not provide high resolution spatial imaging, it is difficult to determine which particular regions are associated with audio-visual integration. Nonetheless, since the posterior parietal cortex (PPC) is involved in higher order processing of both audio and visual information (through the dorsal stream), it could be speculated that the PPC would be the implicated area

with higher activation in response to audio-visual integration. Regarding vestibular cues, multisensory cortical areas have been found through fMRI showing activation in the posterior insula and the retroinsular regions. Researchers have suggested that these areas are homologues of the vestibular multisensory cortex (PIVC) previously found in the monkey. These areas have been found to respond not only to vestibular cues, but also to visual and somatosensory information.

To conclude this section on multisensory integration, I will review a study by Bushara and colleagues (2010) who illustrated connections between different levels of brain regions during multisensory integration. In their study, Bushara et al., (2010) aimed to determine associated brain regions in the detection of synchronous and asynchronous audio-visual events using the Positron Emission Tomography technique. Participants were presented with a simple visual flash and auditory beep at different SOAs and were instructed to judge whether they were simultaneous or not. Imaging results revealed that detection of audio-visual simultaneity led to activation of the right insula implicating its greater level of involvement compared to traditional association areas such as the prefrontal and posterior parietal regions. They also showed the involvement of a tectal system due to functional interactions between the superior colliculus and posterior thalamus with the right insular area suggesting a tecto-thalamo-insular pathway in the detection of audio-visual temporal synchrony. As a result, this study showed that temporal synchrony of multisensory information involves activation of large-scale neural networks that entail interactions between various cortical and subcortical structures associated with vestibular, auditory and visual processing areas.

Temporal synchrony of multisensory stimuli is a powerful cue to indicate whether stimuli belong to a common event or external object. Given the fact that there are variabilities in

extrinsic and intrinsic temporal properties of multisensory stimuli, one might expect that perception of this information from the environment could be delayed. However, it has been shown that the CNS maintains perceptual simultaneity by accounting for all these sources of delays between sensory modalities so to allow for a coherent perception of the environment (Kopinska and Harris, 2003). Possible mechanisms for maintaining simultaneity constancy have been proposed. Kopinska and Harris (2004) performed a study to measure audio-visual simultaneity constancy. They presented participants with a flash and a beep at different SOAs and at different physical distances relative to the observer and instructed them to respond to which modality occurred first. If the CNS did not account for the relative delays of audio and visual cues, which increase as the source of the stimulus increased with distance from the observer, then one would expect the perceived delay between audio and visual cues to also increase. However, if the CNS is able to account for distance and the relative timing of sensory cues, then it would be expected that audio and visual cues would continue to be perceived as simultaneous despite increased distance from the observer. The results from Kopinska and Harris (2004) as well as similar previous works (Engel and Dougherty, 1971; Sugita and Suzuki, 2003) confirmed that the perception of simultaneity is maintained as cues are presented at varying distances from the observer. Collectively work in the field provides evidence to support that the CNS maintains simultaneity constancy despite extrinsic and intrinsic temporal properties. In the section below, I will discuss methods for measuring the perceived relative timing of multisensory information.

1.2.3 Psychophysical estimates of perceived simultaneity

One of the ways that the perceived timing of multisensory information is measured is through psychophysical paradigms such as the temporal order judgement (TOJ) task. In this paradigm, a pair of stimuli are presented at different SOAs and observers are instructed to judge which stimulus occurred first (Zampini, Shore and Spence, 2003; Harrar and Harris, 2005). A sigmoidal psychometric function is fitted to the observer's probability of responses to one stimulus (eg., 'light first') as a function of SOAs. Parameters from the sigmoid function fit to the TOJ data include the point of subjective simultaneity (PSS) and the just noticeable difference (JND). The PSS represents the point at which the observer is equally likely to respond that either stimulus occurred first because at the 50% probability the SOA is nearly zero ms (Harris et al., 2010). Thus, the PSS is the SOA at which participants perceive the stimuli as occurring at the same time. The JND is a measure of the precision with which participants make their judgments and it is proportional to the slope of the sigmoidal curve between the 0.25 and 0.75 probabilities. The JND is also equivalent to one standard deviation ($\pm 34\%$) from the PSS. This is the smallest SOA at which the observer is able to correctly judge temporal order of the stimuli for 75% of trials (Zampini, Shore and Spence, 2003). The figure below schematizes these parameters. The JND is also used to calculate the temporal binding window (TBW), which can be defined as the maximal temporal asynchrony between a pair of stimuli that are unified into a single percept (Spence & Squire, 2003; Powers, Hillock & Wallace, 2009). There is however a discrepancy in the literature as to the quantitative measure of the TBW. Most typically, the TBW is calculated as $2 \times \text{JND}$ and measures a perceptual temporal interval for asynchronous stimuli that are perceived to be simultaneous (Hillock-Dunn and Wallace, 2012). It has been suggested, that the

TBW allows for the CNS to accommodate for differences in propagation and neural transduction times of sensory cues (Hillock-Dunn and Wallace, 2012).

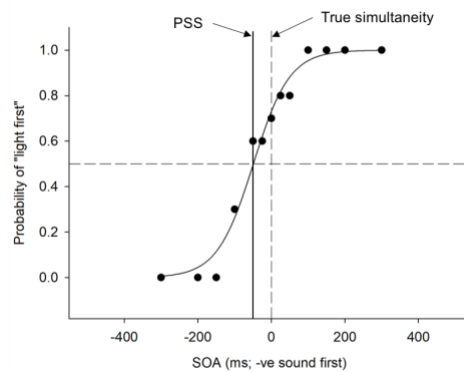

Figure 1: Representation of a typical TOJ psychometric function where the probability of responses to one stimulus (“light first”) is plotted as a function of SOAs. The dashed vertical line represents the point of true simultaneity with a zero SOA. The solid vertical line represents the PSS at the 0.5 probability. The JND is the time between the 0.5 probability and the ± 0.25 probability. The TBW can be defined as the time between the 0.25 and 0.75 probabilities.

Temporal binding window and its implications

The TBW represents temporal precision where a narrower size indicates that individuals are better able to identify sensory events that are more likely to be truly simultaneous (i.e., very small or zero SOAs). In contrast, individuals who manifest a wider TBW tend to integrate sensory events over a larger range of SOAs, which may be problematic as it can lead to the integration of unrelated sensory information. Sartora and colleagues (2017) pose that a wider TBW may lead to perceptual ambiguity and confusion due to sensory overload. However, there is not yet a definitive answer as to whether narrower TBWs are beneficial or not.

The size of the TBW has been found to change throughout human development. While younger children tend to have a wider TBW (i.e., lower temporal precision), it tends to decrease into adolescence (Hillock-Dunn and Wallace, 2012). On average, young adults have the narrowest TBWs compared to earlier or later developmental stages (Hillock-Dunn and Wallace,

2012). In later adult life, the TBW widens again as temporal precision decreases (Setti et al., 2011b; Bedard and Barnett-Cowan., 2016) which may render older adults susceptible to falls and deficits in speech comprehension due to their inability to properly integrate audio-visual information (Setti et al., 2011b; Bedard and Barnett-Cowan., 2016). Furthermore, research shows that larger TBWs are associated with cognitive disorders such as autism spectrum disorders (Foss-Feig et al., 2010), schizophrenia (Foucher et al., 2007) and dyslexia (Hairston et al., 2005). Therefore, it could be speculated that since wider TBWs are associated with perceptual ambiguities and behavioural deficits, individuals with narrower TBWs may have some advantage for processing multisensory information compared to those with wider TBWs. With respect to this thesis, it is expected that those with wider TBWs are more likely to experience cybersickness in virtual reality due to an increased likelihood for integrating multisensory cues that do not belong together in time.

1.2.4 Temporal order judgements within auditory, visual and vestibular cues

In a typical audio-visual TOJ paradigm, participants are presented with a simple visual and auditory stimulus (i.e., flash of light and beep) at varying SOAs and are instructed to make a forced choice response using button presses regarding the order of the stimuli. In general, these studies find that the visual stimulus must be presented prior to the auditory cue for perceptual synchrony to occur (Bertelson and Aschersleben, 2003; Jaekl and Harris, 2007; Bedard and Barnett-Cowan, 2016). These studies present both stimuli from distances proximal to the observer where the propagation speed of the stimuli do not play a significant role in the perceptual latencies. In these cases, the neural transduction times largely govern the temporal perception of the stimuli. Therefore, this finding may be attributed to the fact that neural transmission of sounds is faster than for visual stimuli, hence light must reach the photoreceptors

prior to the sound to compensate for its slow propagation speed. Figure 2 shows a sample data set from an audio-visual TOJ study from fifty young healthy adults conducted by Bedard and Barnett-Cowan (2016).

Here, the authors found that on average the visual stimulus must precede the auditory cue by approximately 20 ms (as measured by the PSS) in order for the stimuli to be perceived simultaneously. Additionally, they found that there are large individual differences in the temporal order perception of audio-visual stimuli in terms of the PSS and TBW. While some individuals have a PSS around the average, others have a PSS that is much farther from true simultaneity. Incidentally, there are individuals in the dataset who manifest a PSS that favours the sound to precede the light (negative PSS). Hence, individual differences are not only associated to the size of the PSS but also the direction (i.e., positive for visual preceding or negative for auditory preceding as shown in Figure 2). Similar individual variations are witnessed amongst the TBW measures (i.e., shallower slopes indicate wider TBWs). Figure 2 illustrates these variations by the differences in the slope of the sigmodal curves.

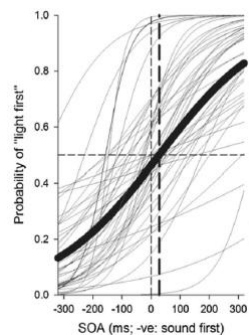

Figure 2: Sample audio-visual TOJ psychometric data from 50 participants where the dark sigmoidal data fit shows the average and gray data fits show individual psychometric data fits. The PSS in this data set is approximately 20 ms shown by the thick dashed line indicating that on average the visual stimulus must precede the auditory in order for a simultaneity percept to occur. Retrieved from Bedard and Barnett-Cowan (2016).

While the vast majority of TOJ experiments have been conducted on audio-visual stimuli, other sensory pairs have also been conducted such as audio-tactile (Zampini et al, 2005) and visuo-tactile (Spence et al., 2003). Since the focus of this thesis is concerned with the relationship between temporal processing of multisensory cues and cybersickness, here I briefly review experiments concerning temporal perception of vestibular cues in comparison to other sensory modalities. These studies have used various forms of vestibular stimulation including GVS (Barnett-Cowan and Harris, 2009), passive whole-body rotation (Sanders et al., 2011) and active head movements (Barnett-Cowan and Harris, 2011). A general finding across these studies reveal that on average participants require vestibular stimulation to precede the comparison sensory cue (e.g., auditory) in order to perceive simultaneity suggesting that vestibular processing is slow compared to other sensory modalities (see Barnett-Cowan, 2013 for a review). As noted above, the purpose of this thesis is to understand the role of active head movements since they are naturally performed in VR environments. Thus, my focus is on the perceptual timing of active head movements. Figure 3 shows the psychophysical data from a TOJ task using auditory and active head movements from 15 participants. In this study, Barnett-Cowan and Harris (2011) cued participants to execute an active head movement and presented them with a comparison auditory tone. Participants were instructed to make temporal order responses regarding the sound and the onset of their head movement. Their results elucidated two main findings. First, in line with previous literature, they found that vestibular processing is slow because on average participants required the head movement to occur prior to the sound in order for the two stimuli to be perceived as simultaneous. Second, similar to audio-visual TOJs, they found large individual differences in the PSS and the TBW measures. These individual differences are illustrated in Figure 3 below where we notice that while some individuals

manifest larger PSS measures (shown by a PSS farther from zero), others show much smaller PSS values. Note that since head movements require integration of sensory information from vestibular, neck proprioceptors and vision, during an active head movement sensory signals are integrated from vestibular as well as proprioception and motor-related signals (Cullen, 2018), therefore head movements are not pure vestibular cues. Also, note that the majority of TOJ experiments involving vestibular cues have been conducted with eyes closed to eliminate visual feedback as a confounding factor. Recently, however, Chung and Barnett-Cowan (2017) found that adding visual information during active head movements paired with auditory stimuli does not appear to significantly affect the PSS or TBW. In this study participants will have their eyes closed in TOJs involving active head movements.

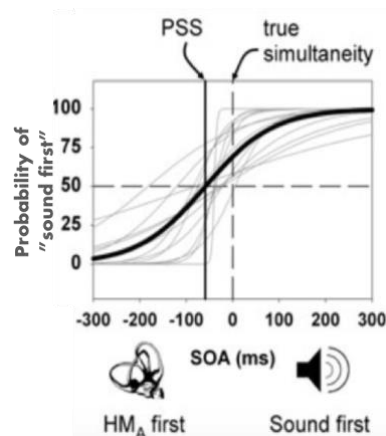

Figure 3: Sample audio-active head movement TOJ data from 15 participants. The black sigmoidal curve represents the average data fit with the individual data fits in the grey lines in the background. In this case, on average participants show that they require the onset of the head movement to occur before the sound in order for them to be perceived as simultaneous. Retrieved from Barnett-Cowan and Harris, 2011.

In the current study, I replicated the audio-visual (from Bedard and Barnett-Cowan, 2016) and audio-active head movement TOJs (from Barnett-Cowan and Harris, 2011; Chung and Barnett-Cowan, 2017). I recruited a new cohort of participants to complete both of these TOJs. Since studies have shown that delays between different sensory systems may lead to symptoms of nausea, disorientation and oculomotor discomfort when individuals are exposed to VR environments (Bertolini and Straumann, 2016), TOJ data in this study were correlated to measures of cybersickness in VR. Therefore, the goal is to not only confirm previous TOJ results, but also to understand whether there is a relationship between the PSS and TBW for these sensory pairings with cybersickness. I predicted that individuals who manifest wider TBWs and PSS measurements farther from true simultaneity will show greater discomfort as a result of exposure to VR content. Below I review the literature regarding cybersickness and methods used to measure it.

1.3 Section B: Cybersickness and underlying factors

1.3.1 Defining motion sickness and cybersickness

Motion sickness is the feeling of malaise (which include symptoms of vomiting and nausea) induced by provocative motion stimuli which typically entail passive body motion such as riding in a car or a train (Bowins, 2010; Golding, 2008; Reason 1978). While motion sickness is found to occur in several real-world scenarios, it is also found to occur in VR environments where it is known as cybersickness (Davis et al., 2014; Bowins, 2010; Reason, 1978). Cybersickness is characterized by symptoms of nausea, disorientation, headaches, sweating and oculomotor issues (Johnson, 2005; Davis et al., 2014) that occur due to exposure to VR content. In general, all healthy individuals with a functioning vestibular system are susceptible to sickness. Studies have found that cybersickness is prevalent in 80-95% of VR users (Stanney, Mourant and Kennedy,

1998; Cobbs, Nichols and Ramsey, 1999; Davis et al., 2014). While etiology of cybersickness remains to be fully understood, several studies have elucidated that delays between visual-inertial information may be an important underlying factor.

1.3.2 Delay between sensory events and cybersickness

Delays in VR entail lags that exist between a physical movement (eg., head rotation) and the moment at which the system responds through a change in the visual environment (eg., a shift in the visual field). While delays that are shorter may go unperceived, there are perceptual delays in some environments that may negatively influence user experience potentially resulting in an increase in cybersickness severity. Early findings from cybersickness research have shown that latencies between inertial and visual motion, caused by VR system lags, not only increase cybersickness incidences but also worsen symptoms severity. DiZio and Lackner (1997) instructed participants to scan a virtual harbour scene in order to develop spatial awareness of the environment. Participants wore HMDs and scanned the environment through head movements for five 2-minute blocks where varying delays between the head movement and the visual update were introduced. They found that a delay of 254 ms was enough to induce higher levels of cybersickness which led to 6 participants to dropout. Later, Jennings and colleagues (2004) found that when pilots were exposed to a flight simulator, there was an increase in the incidences of cybersickness in conditions with added delays compared to those without delays. While this experiment did not assess the impact of delays on the severity of cybersickness, it showed that system delay may be a contributing factor to cybersickness severity. Therefore, these studies collectively suggest that a temporal lag between inertial and visual motion may worsen cybersickness symptoms.

Given the fact that delays negatively influence cybersickness, researchers have demonstrated that with hardware and software advances in VR systems, delays have also been minimized. Moss and Muth (2011) reported that VR systems tend to have latencies that range from 60 to 250 ms. Since 2011, however, recent commercially available VR systems such as the Oculus Rift HMD have reported latencies as low as 20 ms or lower (Oculus VR best practices, 2015). Importantly, it has been found that latencies of 20 ms or lower offer users the most optimal experience in VR (Raaen and Kjellmo, 2015). However, despite reducing VR hardware delays to less than 20 ms, individual differences in processing multisensory information could lead to perceptual delays that exceed this fixed delay. For example, individual differences in the perceived timing of stimuli could be related to the fact that individuals may have the ability to detect latencies between stimuli as low as 3 to 4 ms while others have thresholds of around 100 ms (Raaen and Kjellmo, 2015). Although it remains largely speculative, it could be that individuals with lower perceptual thresholds for delays may experience greater cybersickness.

1.3.3 The sensory conflict theory

In order to explain why delays may lead to cybersickness, researchers typically refer to the sensory conflict theory which states that a discrepancy between signals of different sensory modalities, involved in the sense of position and movement, elicit sickness symptomology (Reason, 1978). In an HMD, there can be spatial as well as temporal mismatches between a user's movement and the corresponding change in the VR environment (Moss et al., 2011). While the mechanism for how a sensory conflict occurs is still inconclusive, it is suggested that there is a mismatch between information that the CNS expects and the actual signal it receives from these interacting sensory systems. Reason (1978) proposed a model to describe the general neural mechanism for how sickness may be induced from a sensory conflict. Figure 4, below,

illustrates this model; note that this model applies to active (i.e., self-generated) movements only. Central to this model is the comparator that matches the current afferent signals to the expected signal which is stored in the CNS on the basis of previous experiences. If incoming sensory information is incongruent, then a mismatch signal is generated which through some neural mechanism elicits brain emetic centers to induce sickness (Reason 1978; see Oman, 1990 for review). A modification of this model was later proposed by Bles and colleagues (1998) who postulated that the sensory conflict arises between senses that convey information about gravity (Bles et al., 1998), hence the name, the vertical mismatch theory. While Reason and Brand (1975) proposed that the underlying issue was a sensory mismatch between sensory organs involved in the sense of position, Bos et al., (2008) argued that the sensory mismatch is generated because of conflicting information about gravity. In their theory, they state that gravito-inertial information (deduced from integration of visual, vestibular and non-vestibular signals) is incongruent with the expected sense of gravity based on prior experiences. An example of this scenario can be illustrated when users are exposed to a microgravity environment (such as a virtual space) where inertial information from the vestibular and somatosensory organs do not correspond to visual signals about gravity. Therefore, when the afferent signals from these organs are at variance with the expected pattern, a mismatch signal is generated which leads to cybersickness.

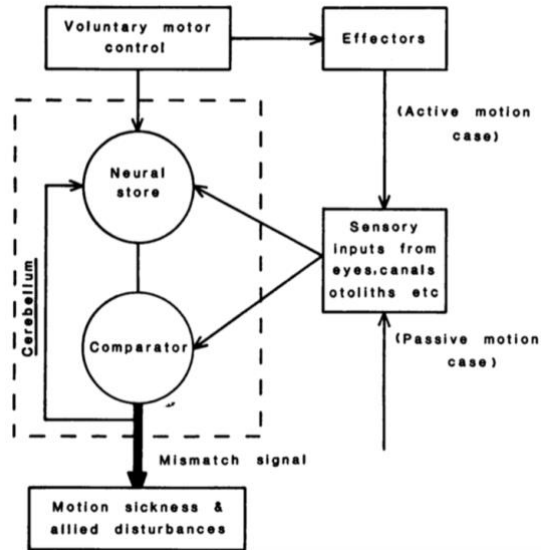

Figure 4: Sensory conflict model proposed by Reason (1978). This model simplifies one of the most accepted conceptual neural mechanisms used to explain development of sickness due to exposure to nauseogenic stimuli. At the onset of an active movement a command signal generates an efference signal that travels to the effector (eg., muscle) while simultaneously sending an efference copy to the neural store. The efference copy finds the refference trace from the neural store that very closely matches the command signal. Meanwhile, sensory inputs from the involved senses are processed and travel to the comparator. The comparator matches the current refference (from sensory organs) with the refference trace to ensure that the movement that occurred was what the CNS had expected. When information from the sensory organs are at variance relative to each other, a mismatch signal is generated.

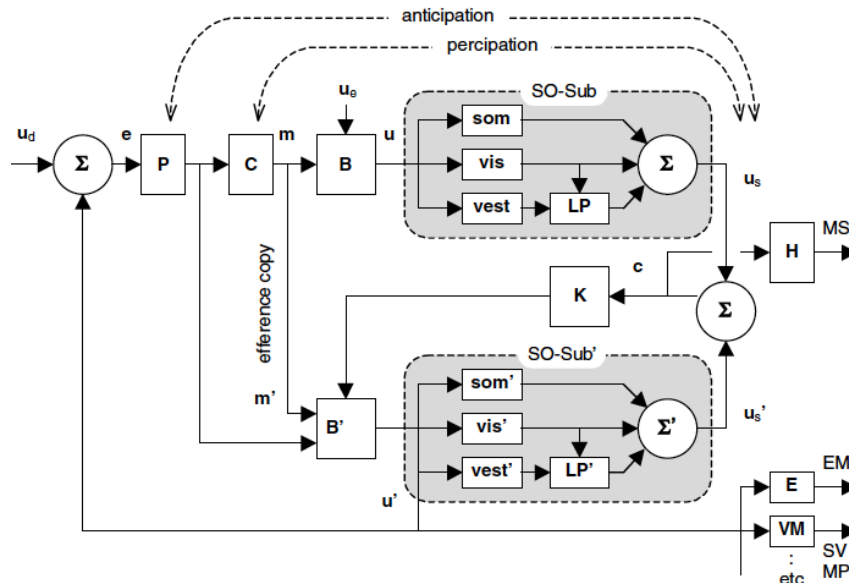

Figure 5: Model for the vertical mismatch theory by Bos et al., (2008). Briefly, this model shows that the body enters a preparatory state (P) after which a motor command (m) is generated which causes the motor action by the muscles in the body (B). This movement generates a new body state (u) which is sensed by the visual, vestibular and somatosensory organs (vis, vest, som). The integration of these signals forms a representation of the current body state (u_s). While the motor command was generated, simultaneously an efference copy was also generated by the neural store which forms an expectation of the sensory feedback regarding the desired body state (u_s'); this expectation is formed on the basis of prior experiences. The sensory feedback, u_s , is compared with the expected sensory feedback, u_s' , to generate an error signal. If the two signals are congruent then a mismatch is generated which may result in motion sickness. Retrieved from Bos et al., 2008.

In spite of the fact that the sensory conflict theory is widely accepted, a major limitation is that it provides no rationale as to why individuals experience sickness differently from one another when they are exposed to the same set of VR stimuli. In a study examining the health and safety effects of VR exposure, 148 participants were tested, and it was found that of the 80% who reported sickness symptoms, 75% of participants reported mild symptoms while 5% reported severe symptoms leading to participant withdrawal (Cobbs et al., 1999). Similarly, Hartnagel et al., (2017) and Ohyama et al., (2007) found that there were large interindividual

variations in behaviour and subjective-cybersickness severity when participants were exposed to different VR environments. Given the fact that individual differences have been acknowledged over the past several decades, individual factors contributing to cybersickness susceptibility remain ambiguous.

Nonetheless, researchers have found evidence to support that individual factors (such as age, sex, genetics, previous exposure to VR, and illnesses) are potential contributors (see LaViola, 2000 for review). For example, recent evidence from cybersickness studies suggest that older adults are more susceptible compared to children and young adults (Arns and Cerney, 2005). In addition, Munafo et al. (2017) have found that females tend to show more severe sickness symptoms compared to males. Further research has shown that certain gene polymorphisms (Finely et al, 2004) and previous motion sickness experiences (Stanney et al., 2003) may render individuals more susceptible to cybersickness. Additionally, research also shows that psychometrics of visual perception may also be related to cybersickness susceptibility. In a study by Webb and Griffin (2003) it was found that users' visual acuity measures were correlated with motion sickness severity such that those with higher acuity (which they quantified as 20/15 or better) tend to report lower sickness severity as compared those with lower acuity levels. Although these findings provide significant information about sickness susceptibility, there is ongoing research to determine factors that better predict individual differences in cybersickness.

Therefore, this thesis takes a different approach to determine factors that may predict individual differences in cybersickness. Specifically, individual differences in the temporal perception of multisensory cues will be assessed in an effort to determine whether it shares a relationship with cybersickness. As mentioned earlier, the TOJ tasks will be used to measure

psychometric parameters of perceived simultaneity while subjective reports will be employed to quantify cybersickness. In the section below, I will provide a review of the most common measures used to quantify cybersickness.

1.3.4 Measures used to quantify cybersickness

Researchers have identified several methods of quantifying cybersickness through objective and subjective measures. Objective measures of cybersickness take advantage of the physiological responses elicited due to exposure to VR. Common physiological changes include variability in heart rate, changes in gastric myoelectric activity, increase in sweating and eye blinks. The following are a list of electrophysiological techniques used to quantify cybersickness:

electrocardiogram (ECG) for heart rate measures, Electrogastragram (EGG) for measures of gastric myoelectric activity, galvanic skin response (GSR) for skin conductance and electrooculogram (EOG) for measures of eye blinks. Additional sophisticated physiological responses include changes in oscillatory brain activity measured through EEG recordings (Chang et al., 2013) and changes in hormonal levels in blood such as rise in plasma vasopressin (Shupak and Gordon, 2006). Despite the fact that physiological data has the power to provide precise, unbiased data it is typically more time consuming, costly, and requires further human ethics considerations that are not issues for subjective measures.

Although there are no gold standards to quantifying sickness symptoms, subjective measures through questionnaires (such as the Pensacola Diagnostic Index, Simulator Sickness Questionnaire or Nausea profile survey) have been the most commonly used for different forms of sickness (Gianaros et al., 2001). The primary reason for this is that questionnaires are easily administrated (quick and easy) and they are cost effective since no particular equipment is required. The Simulator Sickness Questionnaire (SSQ) originally developed for simulated

environments, is the most established in reports of cybersickness (Kennedy et al., 1993). The SSQ was derived from the Motion sickness Questionnaire (Kellogg, Kennedy, & Graybiel, 1964) which originally consisted of 25 to 30 symptoms. Kennedy and colleagues (1993) concluded that mainly 16 symptoms were relevant to simulator sickness experiences. They made this conclusion based a database consisting of approximately 1100 MSQs collected from 10 different navy simulators. At the end of completion of the simulator, participants completed the MSQ. From their work, Kennedy and colleagues (1993) concluded that of the 30 MSQ symptoms only 16 were relevant to the simulator experience. Therefore, the SSQ consists of 16 symptoms that is employed for users to report their severity on a 4-point scale. Symptoms in the SSQ are classified into three categories of Nausea, Oculomotor and Disorientation issues (Kennedy et al, 1993) which are used to calculate a total sickness score through factor analysis (more detail on this in the 'Methods' section below).

Another subjective measure recently developed is the Fast Motion Sickness (FMS) scale which is a fast and convenient measure of cybersickness during exposure to experimental conditions. The FMS is a verbal rating scale where participants rate how they feel in the environment on a scale from 0 to 20 (Keshavarz and Hecht, 2011). It has been shown that the FMS is highly correlated with SSQ scores (eg., $r = 0.785$, $p = 0.001$ for FMS correlated with the total SSQ score) when 126 participants were tested, thereby validating the FMS for cybersickness quantification (Keshavarz and Hecht, 2011). The fact that the FMS is quick and can be administered during the experiment provides it an advantage to be used over other methods. In the current study, the SSQ and FMS will be used to measure cybersickness severity.

1.4 Section C: Current study

As noted above, cybersickness and multisensory integration are well known concepts that have been extensively studied over several decades. However, no study, to our knowledge, has examined the relationship between perceptual latencies of sensory events and cybersickness severity, thus, leaving the relationship between the two fairly exploratory. This thesis aimed to determine whether there is a relationship between perceptual latencies of multisensory information (through measures of the PSS and TBW) and cybersickness in VR. To accomplish this, participant's visual acuity was assessed and then they completed two TOJ tasks followed by a VR exploration task. Measures of the TBW, PSS was calculated from the psychophysical tasks and cybersickness severity were acquired through the FMS (Keshavarz and Hecht, 2011) and the SSQ (Kennedy et al., 1993). In addition, we have assessed participants' visual acuity measures on a subset of our participants. This was added as a modification to the data that was initially proposed.

1.4.1 Psychometric stimuli in this study

The TOJ tasks will examine temporal order perception of two stimuli pairs; audio-visual and audio-active head movements. The primary reason for why these sensory modalities were investigated is because of a wealth of previous research for these sensory pairings as well as their involvement during exposure to a VR environment. While the HMD presents users with rich sources of visual and auditory information, voluntary body movements (i.e., active head movements) recruit sensory signals from additional sensory modalities including vestibular and non-vestibular organs (i.e., neck proprioceptors). As a result, integration of information from all sensory modalities must take place in order for the user to have an optimal experience in the simulated world.

Another reason why these stimuli are examined in the TOJ tasks is because of their role in cybersickness. Head movements are found to exacerbate cybersickness symptoms such that those who explore the environment through head movements or those who make rapid and frequent head movements tend to experience greater cybersickness levels (Howarth and Finch, 2010; Regan and Price, 1993).

1.4.2 Study objectives and hypotheses

The main goal in the present study is to determine whether the TBW and PSS of multisensory integration and visual acuity may be able to predict cybersickness. Specifically, I examined the relationship between the TBW and PSS measures (of audio-visual and audio-active head movement stimuli pairs) and cybersickness severity. I predicted that any abnormalities in temporal perception of sensory information (such as a wider than normal TBW) may lead to discomfort in the VR environment and hence result in greater cybersickness symptoms. In this study, we used the size of the TBW and the absolute value of the PSS as estimates of temporal precision and temporal accuracy, respectively. A PSS farther from zero either in the positive or negative direction indicates lower temporal accuracy. A wider TBW indicates lower temporal precision. To understand the relationship between cybersickness and the psychophysical measures we conducted correlations between the two entities. Correlation analysis was also conducted to determine the relationship between visual and cybersickness.

Moreover, we predicted that there may be a global mechanism governing the TBW and PSS of sensory information across different sensory modalities. To assess this, correlation between the psychometric parameters of the two stimuli pairs (audio-visual and audio-active head movement) were assessed. This would mean that there may be some shared mechanism

between the integration of sensory information of the modalities tested here and other pairs such as visual and vestibular.

Additionally, in this study we exposed participants to two distinct VR environments where they were immersed in very different settings; Adrift (AD) and First Contact (FC). While AD is known as a nauseating VR environment, FC is rated as comfortable by previous users through the Oculus Rift online user interface. The two environments differ in many ways, one of which is the way the user navigates throughout the environment. In FC, users have greater control over their movement since their physical movements in space are translated into virtual movements. In AD users have less control over their movements since they use game controllers to navigate the environment. Motion sickness studies showed that greater control over movement in the environment mitigates discomfort (Rolnick and Lubow, 1991; Dong et al., 2011) which may be why AD is a nauseating environment. Additionally, the two scenarios greatly differ in the optic flow. While there are objects floating all over the visual field in the AD environment, in FC objects are majorly stationary and only move when users interact with them. Greater optic flow may lead to greater perceived self-motion which may result in greater cybersickness severity. As a consequence, here we expected cybersickness symptoms to be greater when participants were exposed to AD as compared to FC. Therefore, the following were the main hypotheses in this study:

1. The parameters (TBW and PSS) of the two stimuli pairs share a positive correlation potentially suggesting a shared mechanism between the processing of the two sensory pairs.
2. Participants would experience greater cybersickness upon exposure to AD as opposed to FC. Hence, we expected greater SSQ scores resulting from AD compared to FC.

3. Individuals with lower temporal precision of audio-visual stimuli may be more prone to cybersickness, hence may experience severe symptoms. Therefore, we expected to see a positive correlation between audio-visual TBW size and cybersickness severity.
4. Individuals with a lower temporal accuracy of audio-visual stimuli may be more prone to cybersickness hence may experience severe symptoms. Therefore, we expected to see a positive correlation between the absolute audio-visual PSS value (farther from zero) and cybersickness severity.
5. Individuals with lower temporal precision of audio-active head movement stimuli may be more prone to cybersickness, hence may experience severe symptoms. Therefore, we expected to see a positive correlation between audio-active head movement TBW size and cybersickness severity.
6. Individuals with a lower temporal accuracy of audio-active head movement stimuli may be more prone to cybersickness hence may experience severe symptoms. Therefore, we expected to see a positive correlation between the absolute audio-active head movement PSS value (farther from zero) and cybersickness severity.

As mentioned earlier, visual acuity was added as an additional analysis to the participants collected post proposal data in order to further understand the role of vision in cybersickness severity. Hence, we presented this as hypothesis 7 where we predicted that Individuals with lower visual acuity would experience greater sickness symptoms.

2.0 Materials and Methods

2.1 Participants

50 healthy young adults who reported having no known auditory, visual, or vestibular function were recruited for this experiment. Participants ranged between the ages of 18 and 36 (23 males; mean age = 22, SD = 3.8). All participants provided voluntary written consent. The study was approved through the University of Waterloo Research Ethics Committee and complies with The Code of Ethics of the World Medical Association (Declaration of Helsinki).

2.2 General protocol

Participants first filled out the Motion Sickness Susceptibility Questionnaire (MSSQ; Appendix A). They then completed a demographic questionnaire about their previous gaming experiences (Appendix B). Participants then completed the visual-acuity assessment, audio-visual and the audio-active head movement TOJ tasks after which they completed two 30-minute VR experiences. Following each VR experience, the Simulator Sickness Questionnaire (SSQ; Appendix C) was completed by each participant. Participants were reminded that they should let the experimenter know if they feel uneasy, discomfort or sickness and that they could withdraw from the experiment at any stage.

2.3 Psychophysical TOJ tasks

Visual acuity assessment

To assess visual acuity the Freiburg Visual Acuity Test (FrACT; Bach, 1996) was used. In this task the optotype (i.e., a landolt ring) was presented in 8 different orientations. Participants were instructed to make their responses according to their judgment of the orientation in which the optotype was presented. The size of the prototype was modulated by the subject's responses using a Bayesian approach (i.e., "Best PEST" strategy; Bach, 1966). The Best PEST (parameter estimation by sequential testing) is a staircase procedure which adjusts the size of the staircase step depending on information already collected from previous trials. In this task, if the participant makes a correct response to a trial then the size of the optotype for the subsequent trial decreases. The Best PEST approach is an efficient method that rapidly and accurately determines the threshold using a lower number of measurements (in this case 18 trials) compared to other staircase procedures.

Participants were seated in a comfortable chair that was adjusted at eye level with the computer. During the task participants sat 3 meters from the computer screen. In this study a MacbookPro was used to run the visual acuity program. To make their responses, the numerical keyboard buttons were used to indicate each of the eight orientations. To make the task simpler the numbers on the keyboard were labelled with the eight designated orientations. Each participant completed the assessment three times: once for the right, left eye and both eyes.

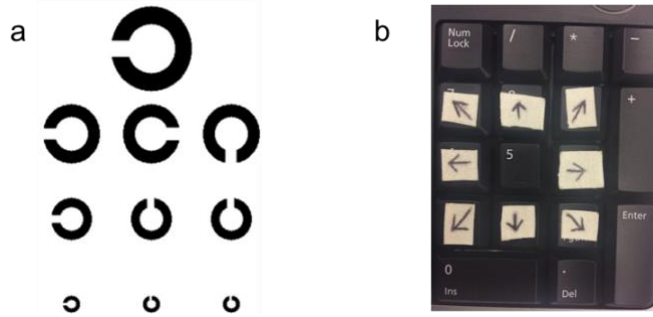

Figure 6: a) shows the landolt ring that was presented to the participant during the visual acuity assessment. b) shows the numerical keypad with the designated labels for each orientation that the participant used to register their responses.

Audio-visual Temporal Order Judgement task

Participants were seated in a comfortable chair with the height adjusted at eye level to the centre of a computer screen. During the task, participants sat approximately 57 cm from the monitor in order to maintain consistency across all participants. A MacBook pro was used to present the visual and audio stimuli. Arrow keys on the laptop keyboard were used by observers to indicate which stimulus occurred first.

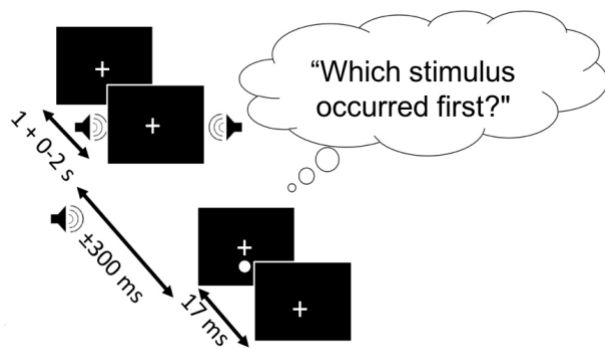

Figure 7: Schematic representation of the temporal order judgement paradigm with the auditory and visual stimuli. The boxes represent the monitor with the visual stimulus. The sizes are not to scale but the flash and the cross are located on the monitor as shown here. The SOAs between the stimuli are represented by the arrows ranging between -300 to 300 ms.

Stimuli

The visual stimulus was a white circle of 4° with an intensity of 49.3 cd/m^2 presented on a black background of 0.3 cd/m^2 intensity for 17 ms. It was presented 2° below a fixation cross. The auditory stimulus was a sound with a frequency of 1850 Hz and an intensity of 71.7 dB presented for 7 ms. The white fixation cross was presented on the screen during the entire task, and participants were instructed to fixate eyes on the cross. The auditory and visual stimuli were presented at different stimulus onset asynchronies (SOAs) which ranged from -300 ms to +300 ms, where negative SOAs represented conditions that the sound was presented prior to the flash. Each SOA was repeated 10 times with a total 130 trials. The following were the SOAs that were used: -300, -200, -150, -100, -50, -25, 0, 25, 50, 100, 150, 200, and 300 ms.

Task

Participants were asked to pay equal attention to both the sound and the light. They were also able to take their time to make a response as this was not a reaction time task. Participants used the right and left arrow keys on the keyboard to make their responses. They responded with the right arrow key when they thought sound occurred first and the left arrow key when they thought flash was first. Prior to the start of the task, every participant was given 6 practice trials to ensure they understood the task. Immediately after the participant's response, the subsequent trial began.

Audio-Active head movement Temporal Order Judgement task

In this task, participants were seated with their eyes closed while wearing a blind fold. Head movement was recorded through the YEI 3-Space Sensor: Data-logging inertial measurement

unit by Yost labs. This unit consisted of a gyroscope, accelerometer and compass and was attached to an elastic band which was mounted on the forehead. Participants also wore headphones in order to hear the auditory stimulus. The software used to run the experiment and record the data was Python v2.7 on a customized gaming PC (Aeon 3200 Gaming Desktop Computer featuring Intel Core i7-6700K Quad-core Processor) running Windows 10. Active head movements were recorded at 1000 Hz using the Python API available directly through Yost Labs (<https://yostlabs.com/3-space-applicationprogramming-interface/>). Again, arrow keys on the keyboard were used and participant responses were recorded using a custom-made python script (Sachgau, Chung and Barnett-Cowan, 2018).

Stimuli

The two stimuli in this task entailed an active head movement and an auditory tone. The active head movement was generated by the participant at the offset of a ‘go signal’ which was a 200 Hz tone that lasted between 1000 to 3000 ms. Participants rotated their head in the yaw axis to their right at ‘normal’ speed and then back to the initial head position. Head movement velocity was not strictly controlled; however, participants were shown a demonstration of a head movement at normal speed that was neither slow nor fast. Additionally, the experimenter was always watching over the participant to ensure that the speed of the movement was approximately ‘normal’. The auditory stimulus (2000 Hz, 50 ms duration) was presented either before or after the onset of the head movement at predetermined SOAs of 0 to 650 ms after the offset of the ‘go signal.’

Task

Participants were instructed to make a temporal order judgement regarding which stimulus came first. The following was the question “did the onset of the head movement occur

first or the beep?” Prior to the start of the actual trial, participants practiced sample head movements following which they were also given 10 practice trials in order to make sure they understood the task. The actual task consisted of one block of 100 trials. Keyboard arrow keys were used by the participants to respond. If they responded ‘sound first’ they would press the right arrow key and if they responded ‘onset of head movement first’ they pressed the left arrow key. Similar to the audio-visual TOJ, participants were told that this was not a reaction time task hence they could take their time to respond. As soon as participants responded the next trial began.

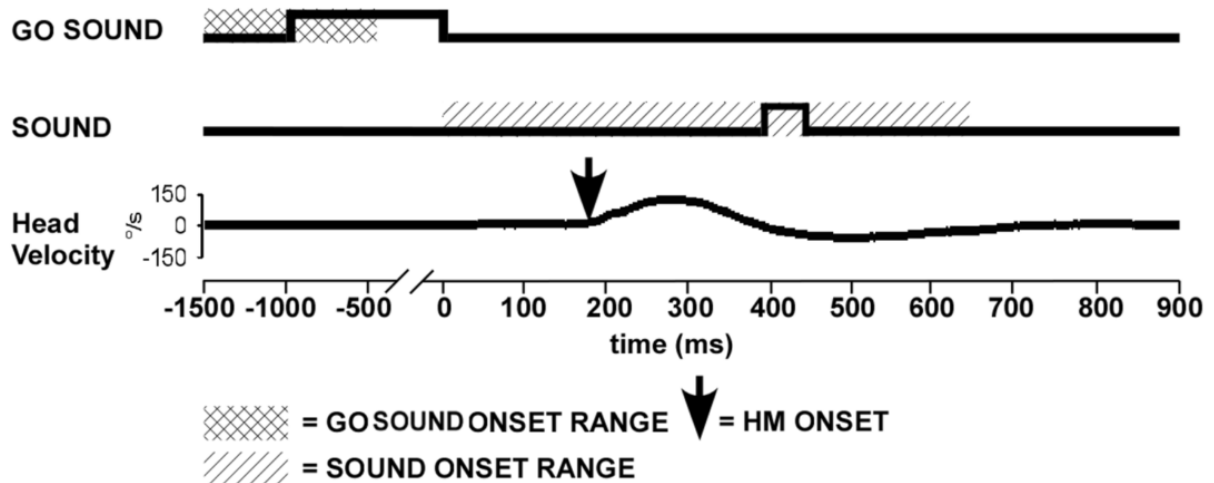

Figure 8: This is a schematic of the audio-active head movement TOJ paradigm. The trial commenced with the 200 Hz sound which lasted between 1000 to 3000 ms. As the ‘go signal’ was offset the participant commenced their head movement. The auditory stimulus onset was 0 to 650 ms after the offset of the ‘go signal.’ Image adopted from Barnett-Cowan and Harris (2011).

2.4 Virtual reality tasks

Experimental setup

The Oculus Rift CV1 head-mounted display (Oculus VR, Menlo Park, CA, USA) was utilized in the virtual reality portion of the experiment to expose participants to the VR environments. The VR hardware was running on a customized gaming PC (Aeon 3200 Gaming Desktop Computer featuring Intel Core i7-6700K Quad-core Processor) which was ran on a Windows 10. Prior to the beginning of the tasks, the Oculus Rift system was calibrated for interocular distance and the height of the participant. A virtual boundary was set to define a physical space area of 8-by-8 feet that was covered with foam mats to prevent injuries in case of falls.

Procedure

For the VR portion of the experiment, participants were immersed in two different virtual environments where they were instructed to explore each environment for 30 minutes each. Participants had at least 10 minutes of a break between the two environments in order to allow them to recalibrate to their baseline state or until sickness symptoms (if any) had ceased. The environments were selected to have low levels of sickness as reported by users of the Oculus Store: First Contact (FC; rated as "normal" or low incidence of sickness) and ADRIFT (AD; rated as "intense" or high incidence of sickness), were installed from the Oculus Rift library through the online interface and used for this experiment.

Stimuli: VR environments

In AD, participants were immersed in a virtual spaceship where they played the role of an astronaut in space. In this environment participants were able to see the body, arms and legs of

their virtual “self” (avatar). Participants could also see the outline of a virtual astronaut helmet. Cue conflict was high in this environment because in order to move around, participants had to use different buttons on an Xbox controller. Movement instructions, however, were carefully explained to all participants. Participants remained physically stationary, but they had the freedom to rotate their head. Participants were instructed to explore the environment for up to 30-minutes of immersion time. During the game, a stop-watch was started at the beginning when participants started the game. At the end of every 2 minutes subjects were asked to verbally report how they felt on a Fast Motion Sickness (FMS) scale of 0 to 20, where 0 represents no sickness at all and 20 indicates frank sickness. In order to make judgements on the appropriate symptoms, participants were cognizant of the fact that they should consider nausea, general discomfort, and stomach problems when making their judgments (Keshavarz and Hetch, 2011).

In FC, participants were immersed in a virtual office where they played the role of a first-person character. In contrast to AD, participants were able to physically move around in the environment by physically walking around within the boundary. Oculus Rift touch sensors were used to provide interactive abilities to participants through virtual hands in the environment and some degree of tactile stimulation. Participants were instructed to explore the environment by moving around and interacting with the objects. In this task, participants could only see their virtual hands but not their body. Interaction included grasping, moving and throwing objects. Similar to AD, participants in FC were asked to verbally report how they felt on the FMS scale (0 to 20 scale; Keshavarz and Hetch, 2011) at the end of every 2 minutes following the start of the game. During both, AD and FC, participants were withdrawn from the experiment if they reached a sickness score of 10 out of 20 on the FMS scale.

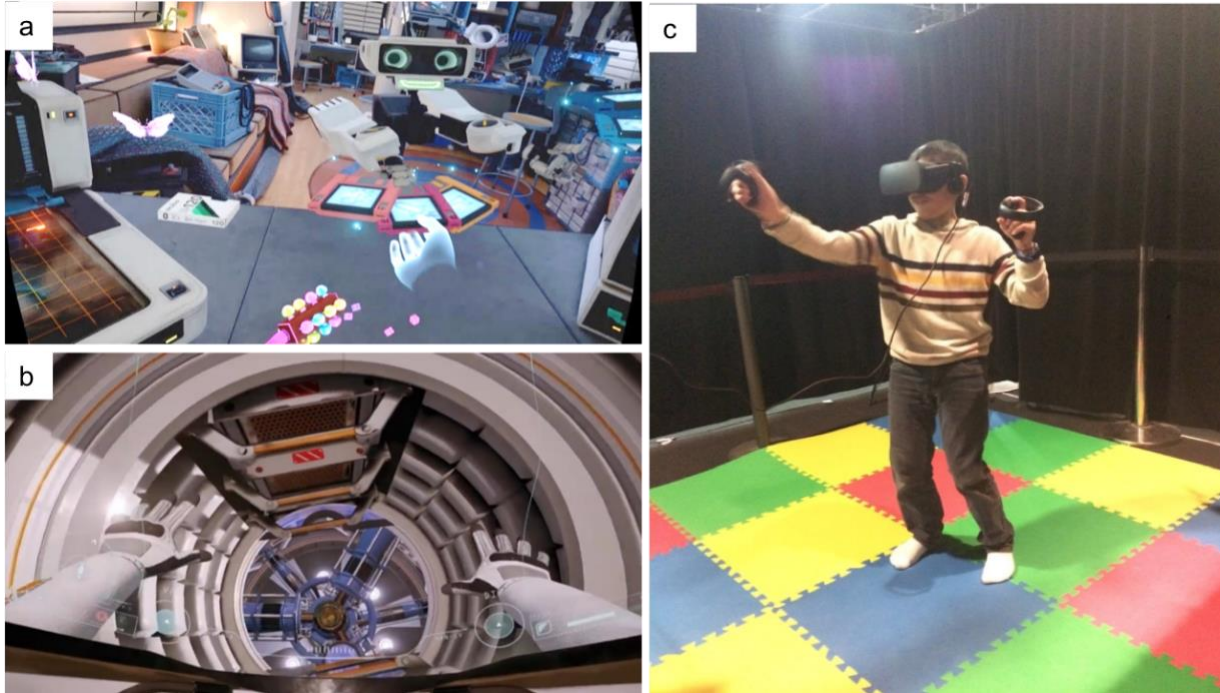

Figure 9: The two VR environments that participants were exposed to are depicted in a) showing ADRIFT and b) showing First contact. These figures are screenshots of the two environments depicting the scene that the participants saw through the HMD. The experimental setup is depicted in c) showing the participant with the Oculus Rift HMD and touch controllers used in FC.

2.5 Data analysis

This was a within subjects' design, hence the same participants completed the psychophysical tasks and VR tasks. Some participants included in the audio-visual tasks were removed from the AAHM analysis (described below). Below I will describe the methods used to analyze the data collected for the visual acuity assessment, the TOJ tasks and the VR tasks.

Visual acuity assessment

Visual threshold was estimated using FrACT which comprised of a built-in algorithm that determined visual acuity psychometrically. In brief, the psychometric function used here

estimated the visual threshold through the participants probability of correct responses and the stimulus intensity (i.e., size of the optotype; see Bach, 1996 for full description).

Audio-visual Temporal order judgement task

To measure the accuracy and precision of the participants' responses regarding the temporal order of the audio-visual stimuli, a sigmoidal psychometric function (Eq. 1) was fit to the probability of perceiving the sound as occurring first as a function of SOA using SigmaPlot 12.5.

Equation 1:

$$y = \frac{100}{1 + e^{\frac{x-x_0}{b}}}$$

where b represents the slope of the sigmoidal curve representing the standard deviation (proxy for the TBW), and x_0 is the proxy for the PSS.

As we are interested in the relationships between the TBWs and cybersickness severity, we chose to analyze the b values of these psychometric functions as proxy for the size of the TBW to avoid discrepancies in the literature that differ when defining the absolute size of the TBW.

The PSS and TBW values were determined for each participant after which an average was calculated for each measure (sample of Eq 1 fit to one participant's data for the audio-visual as well as the audio-active head movement tasks is shown in Figure 11). We set the following exclusion criteria. 1) If the judgement for the most negative SOA was greater than 0.25, or 2) if the judgement for the most positive SOA was less than 0.75, then that participant's data was discarded. Here, no participant data was discarded due to these criteria. Additionally, four study participants were excluded from analysis due poor fitness of the parameters to the psychometric function ($r^2 < 0.2$; Basharat et al., 2018). Overall, 46 of the 50 participants' data was included in

the AV TOJ analysis (this included the psychophysical data fits as well as the correlations involving audio-visual PSS and TBW).

Audio-Active head movement Temporal order judgement task

Raw head movement data was recorded in Python version 2.7 by the Yost data logger unit.

Angular velocity was recorded in volts and then converted into degrees per second for our purposes. The onset of the head movement was defined as occurring 5 ms before the point at which the head movement velocity was 3 standard deviations greater than the average angular velocity at 100 ms calculated before and after the onset of the trial (refer to Figure 10 below).

Each participant's data was visually inspected by plotting the angular velocity signal using the Matplotlib library in Python 2.7. Trials where the onset of the head movement was not accurately determined by the algorithm were discarded. For example, trials that involved erroneous head movement, such as anticipation prior to being cued to move the head or movements of the head above and beyond keeping the head in a stable position were removed from analysis. If greater than 20% of trials were removed for a participant, the participant was removed from analysis. In total, data from 17 participants were excluded for failing to meet the criteria.

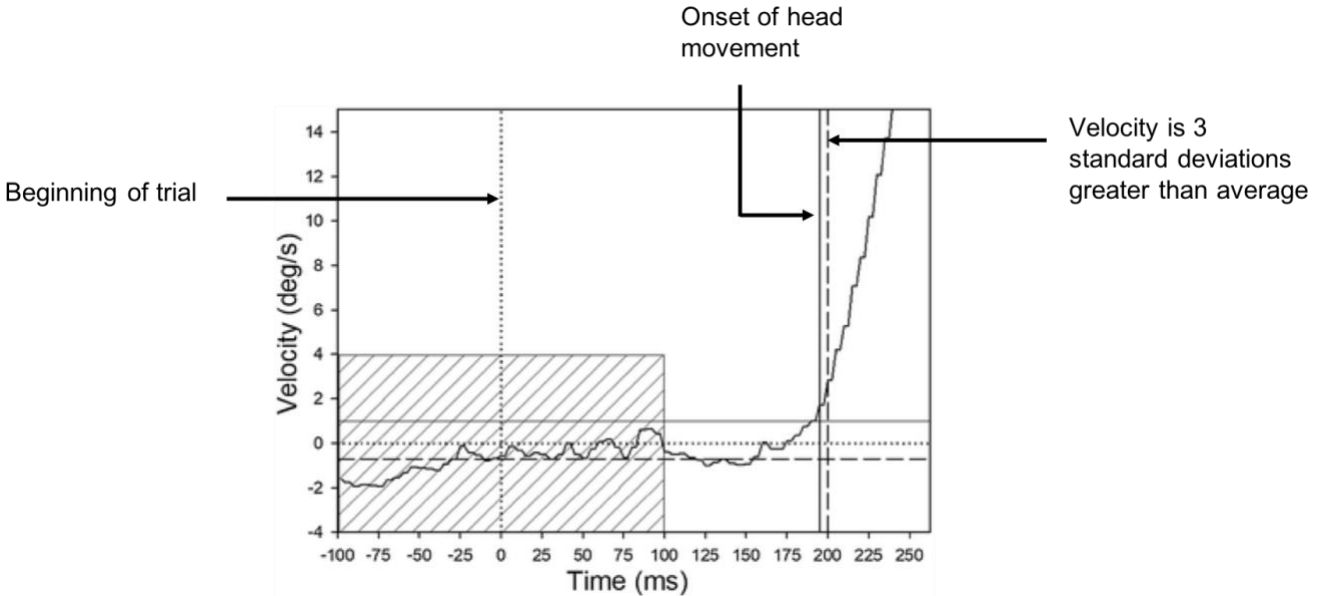

Figure 10: Shown here is the method through which the onset of the head movement was determined. The dotted vertical line represents the start of the trial. The average head movement velocity used to deduce the onset of the head movement is calculated in the shaded region which is 100 ms before and after the trial onset. The onset of the head movement is indicated here by the solid vertical line which is defined as occurring 5 ms before the velocity is 3 standard deviations from the calculated average. Image adopted from Chung and Barnett-Cowan (2017).

We then fitted a psychometric equation to the probability of each subject's responses to "sound first" as a function of SOAs using equation 1. It should be noted that in the analysis of the data for the AAHM, data from 2 participants were removed due to equipment errors where the data was not recorded completely for the 100 trials. As well, similar to the AV TOJ, if the goodness of fit was below 0.2 ($r^2 = 0.2$) then the participant was excluded from analyses. In this case data from 3 participants were excluded from analysis due to poor estimation of the parameters. Overall, 28 out of the 50 participant's data was included in the AAHM data analysis.

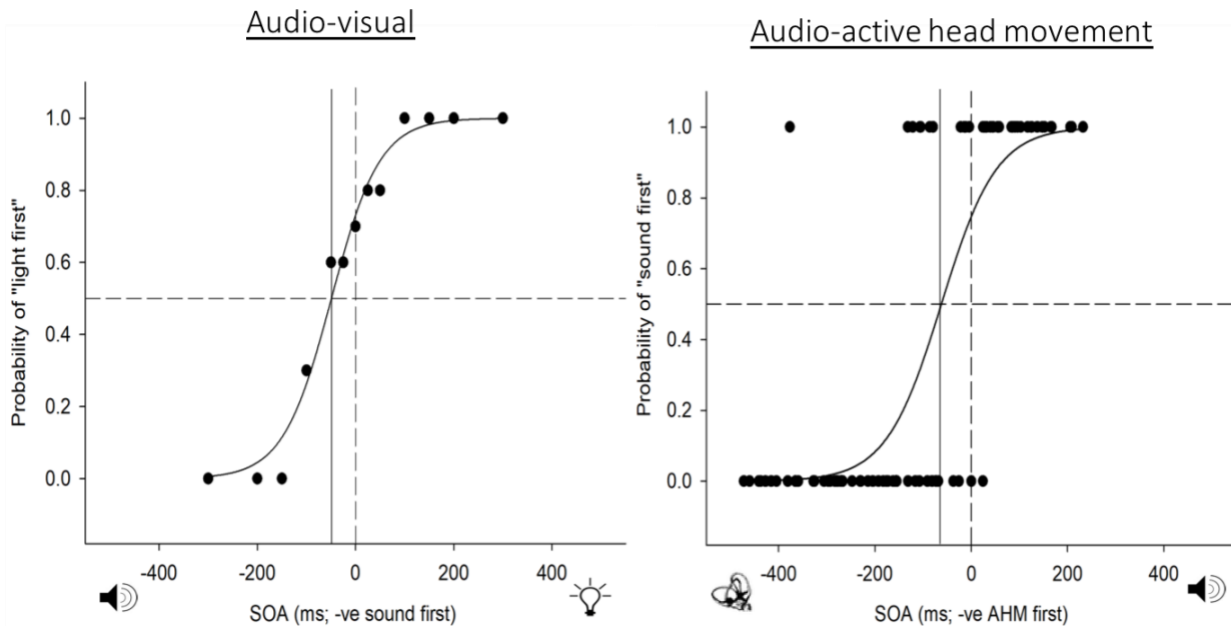

Figure 11: This figure shows an example of a typical participant’s TOJ data which was fit to a psychometric function (i.e., Eq 1). An SOA of zero represents true simultaneity where the stimuli are occurring synchronously. The solid black line represents the PSS and the slope of the curve represents the TBW. **a)** shows an audio-visual TOJ where negative SOAs represent conditions where the sound is presented first and positive SOAs represent conditions where the flash is presented first. **b)** shows an audio-active head movement TOJ data where negative SOAs represent conditions when the onset of the head movement occurred first and positive SOAs represent conditions where the auditory stimulus was presented first.

Motion Sickness Susceptibility Questionnaire (MSSQ)

The MSSQ originally developed by Golding (1998) consists of two sections, MSSQ A and MSSQ B which inquire participants about their previous motion sickness experiences during childhood and adulthood, respectively. In this study participants only completed the MSSQ B which required participants to recall their motion sickness experiences in the past 10 years in various real-world settings (e.g, car, train, boats). There were three questions in total for participants to respond (refer to Appendix A). The nominal choices of responses on each

question corresponded to a numerical value: never =0, 1 to 4 trips =1, 5 to 10 trips =2, 11 or more trips =3 (Golding, 1998).

MSSQ scores were calculated using the original method initially developed by Golding (1998). The following is the mathematical function used to calculate an MSSQ score from the participants responses.

Equation 2:

$$MSSQ\ B = \frac{2.64 * (total\ sickness\ score\ adult)}{9 * (number\ of\ transportation\ types\ experienced)}$$

The *total sickness score adult* is calculated from the question 9 and 10 on MSSQ B. The *number of transportation types experienced* is calculated from question 8.

Simulator sickness data

The raw SSQ values were calculated according to the original method developed by Kennedy and colleagues (1993). A score was first calculated for each of the three categories (Nausea, Oculomotor, Disorientation) according to the original classification shown in the table below (16 symptoms are categorized into the three groups).

	SSQ (N)	SSQ (O)	SSQ (D)
Symptoms classified in each category	General discomfort Increased salivation Sweating Nausea Difficulty concentrating Stomach awareness Burping	General discomfort Fatigue Headache Eye strain Difficulty concentrating Difficulty focusing Blurred vision	Difficulty focusing Nausea Fullness of head Blurred vision Dizziness (eyes open) Dizziness (eyes closed) Vertigo

Table 1: SSQ symptoms grouped into three sub scales. There is a total of 16 symptoms which are categorized into the 3 SSQ sub scales. Some symptoms are categorized in more than one group (i.e., nausea or general discomfort).

The raw scores were calculated directly from the participant's reports for each symptom. The responses ranged from 0 to 3 representing nominal ratings of none, slightly, moderately or severely experienced degrees of symptom severity. To obtain scores for each category or sub score, the raw scores are weighted with factors unique to each group. The weight factors are 9.54, 7.58, and 13.92 for Nausea, Oculomotor and Disorientation, respectively. The total score is obtained by calculating the product (multiply by 3.74) of the sum of the raw sub scores. These calculations were done using simple arithmetic in Sigmaplot 12.5.

FMS

The FMS (developed by Keshavarz and Hecht, 2011) scores were collected in integer form (0 to 20) from participants at the end of every 2 minutes during exposure to the 2 VR tasks. In this thesis, the FMS was collected to monitor the participant's degree of cybersickness severity to ensure that they do not experience severe symptoms thereby preventing symptoms such as vomiting. The following criterion was employed: if participants reported a score of 10 or greater, the VR task would be terminated to prevent aggravation of symptoms.

2.6 Statistical analysis

Shapiro-Wilk normality tests were first conducted on the SSQ scores and the psychometric TBW and PSS values. Data that was not normally distributed was square root transformed to attain normality. To attain a normal distribution, studies in the past have commonly used the square root transformation for the SSQ scores (Weech, Moon and Troje, 2018; Moss et al., 2011 and Sharples et al., 2008). Parametric tests were conducted to analyze normally distributed data while non-parametric tests were used for non-normally distributed data. One sample t-tests were conducted to determine whether the PSS values of the two TOJ data sets were significantly

different from true simultaneity (SOA of 0). To test hypothesis 3 through 7, correlations were carried out to understand the relationship between the psychometric parameters (i.e., TBW, PSS, and visual acuity) and cybersickness scores (i.e., SSQ scores). Pearson correlations were conducted on normally distributed data while Spearman's correlations were carried out on non-normally distributed data. Correlations were conducted for each psychometric parameter (3 parameters; visual acuity, TBW and PSS) against the SSQ sub scores (4 different scores; SSQ (N), SSQ (O), SSQ (D) AND SSQ (T)) for the two psychophysical tasks (2 tasks; audio-visual and audio-active head movement) and the visual acuity measures.

Pearson correlations were conducted to determine whether there was a relationship between the PSS and TBW of audio-visual and audio-active head movement stimuli pairs (i.e., hypothesis 1). A Wilcoxon Signed Rank test was conducted to determine whether participants' cybersickness severity as calculated through the total SSQ score was significantly different in AD compared to FC (hypothesis 2). The non-parametric significance test was chosen because the SSQ scores were non-normally distributed for the FC. As well, a two (VR conditions) by three (SSQ sub scores) repeated measures ANOVA was conducted to determine whether there was a significant difference between the SSQ sub scores of AD compared to FC (hypothesis 2).

3.0 Results

Data from 50 participants has been collected and analyzed. All 50 participants were included in the SSQ analysis which was used to test hypothesis 2 (i.e., to determine whether AD evoked greater cybersickness symptoms compared to FC). In the audio-visual TOJ analysis, 46 of the 50 participants were included. Four participant data was excluded from the analysis due to the poor estimation of the parameters (i.e., $r^2 < 0.2$ for the data fit). In the audio-active head movement TOJ analysis, data from 28 of the 50 participants were included. 20 participants were excluded from analysis due to the exclusion criteria (as noted above).

3.1 Normality test

As there were different numbers of participant data in the audio-visual group and the audio-active head movement group, normality tests for the SSQ scores and the psychophysical parameters were run separately for each group (i.e., audio-visual TOJ group and audio-active head movement TOJ group). The Shapiro-Wilk normality test failed for the SSQ scores of the participants in the audio-visual group. Normality also failed for the PSS and TBW values for this group. Hence, audio-visual TBW, PSS measures and the SSQ scores were square root transformed to attain normality. Similarly, for the audio-active head movement group the parameters were non-normally distributed. Hence, the SSQ scores, TBW and PSS values were square root transformed to attain normality. The PSS and TBW measures for the correlations to assess the relationship between the audio-visual and audio-active head movement parameters were also transformed. In this case, AAHM TBW, PSS and AV PSS were square root transformed while AV TBW was log transformed to attain normality.

Alternatively, the visual acuity measures (i.e., LogMar values) were not transformed even though the data was non-normally distributed. In this case, Spearman correlations were conducted to assess hypothesis 7. Table 2 and Table 3 below summarize the Shapiro-Wilk statistics for the TBW, PSS, and SSQ scores for participants in the audio-visual and audio-active head movement groups.

Parameter	W-Statistic	p	Passed/failed
TBW	0.966	0.192	Passed
 PSS 	0.961	0.124	Passed
AD: SSQ (N)	0.975	0.434	Passed
AD: SSQ (O)	0.965	0.174	Passed
AD: SSQ (D)	0.968	0.227	Passed
AD: SSQ (T)	0.955	0.070	Passed
FC: SSQ (N)	0.87	P < 0.001	Failed
FC: SSQ (O)	0.858	P < 0.001	Failed
FC: SSQ (D)	0.764	P < 0.001	Failed
FC: SSQ (T)	0.79	P < 0.001	Failed

Table 2: Shapiro-Wilk normality test results shown post square root transformation of the TBW, PSS and SSQ sub scores (N, O, D) and SSQ total (T) from those who completed the audio-visual task (n=46).

Parameter	W-Statistic	p	Passed/failed
TBW	0.968	0.528	Passed
 PSS 	0.97	0.590	Passed
AD: SSQ (N)	0.958	0.320	Passed
AD: SSQ (O)	0.959	0.338	Passed
AD: SSQ (D)	0.972	0.628	Passed
AD: SSQ (T)	0.963	0.412	Passed
FC: SSQ (N)	0.953	0.23	Passed
FC: SSQ (O)	0.923	0.041	Failed
FC: SSQ (D)	0.787	P < 0.001	Failed
FC: SSQ (T)	0.794	P < 0.001	Failed

Table 3: Shapiro-Wilk normality test results are shown post square root transformation of the TBW, PSS and SSQ sub scores (N, O, D) and SSQ total (T) from those who completed the audio-active head movement task (n=28).

3.2 TOJ results

Audio-visual Temporal Order Judgement

Figure 12a shows Eq 1 fit to each participant's data (thin lines) for the audio-visual task as well as an average fit (thick black line) to the data that was constructed from the average PSS and TBW values. Note the large variability of the individual fits. The range for the TBW was 20 to 419 ms with an average of 122 ms (SD = 47). The PSS range was -152 to 148 ms. A negative PSS indicates conditions where sound is required to be presented before the light for simultaneity perception. The average PSS was -7 ms (SD = 68). A one-sample t-test shows that the audio-visual PSS was not significantly different from true simultaneity ($t(45) = -0.82, p = 0.893$), meaning that participants on average did not require either stimulus to be presented prior to the other for them to be perceived simultaneously.

Audio-Active head movement Temporal order judgment

Figure 12b shows Eq 1 fit to each participant's data (thin lines) for the audio-active head movement task as well as an average fit (thick black line) to the data that was constructed from the average PSS and TBW values. Note the large variability of the individual fits. The range for the TBW is 2 to 113 ms with an average of 51 ms (SD = 27). The PSS range is -222 to 18.2 ms; note that a negative PSS indicates conditions where the onset of the active head movement occurs before the sound for a simultaneity percept. The average PSS is -78 ms (SD = 49). A one-sample t-test showed that the PSS was significantly different from true simultaneity ($t(27) = -7.96, p < 0.001$). In this case the average PSS indicates that individuals require the onset of the head movement to occur 78 ms before the auditory stimulus in order for them to be perceived as simultaneous.

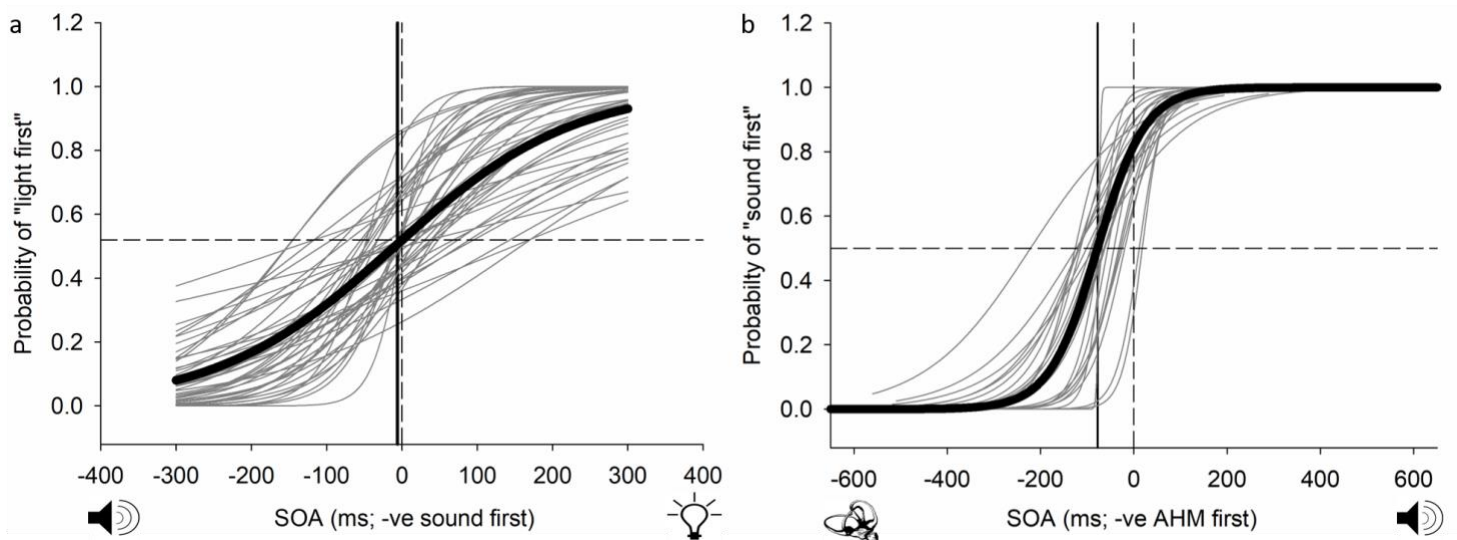

Figure 12: This figure shows the TOJ group average data (thick sigmoidal curve) with each participant’s data (in thin sigmoidal curves) for the audio-visual (a) and audio-active active head movement (b) pairs. An SOA of zero represents true simultaneity where the stimuli are occurring synchronously. Negative SOAs represent conditions where in a) onset of the sound preceded the visual stimulus while in b) onset of the active head movement preceded the sound. Positive SOAs represent conditions where in a) the visual stimulus was presented first and in b) the sound was presented first. The solid black line represents the PSS and the slope of this curve represents the TBW.

Parameters	Range (ms)	Average (ms)	Standard deviation
AV PSS	-152 -158	50	68
AV TBW	20 - 419	122	81
AAHM PSS	- 222 – 18.2	-78	49
AAHM TBW	2 -113	51	27

Table 4: Summary of descriptive statistics conducted on the TBW and PSS measures of audio-visual and audio-active head movement TOJ data.

Hypothesis 1: relationship between the TBW and PSS of the two stimuli pairs

Shown here are the correlations between the psychometric parameters (PSS and TBW) of the two stimuli pairs. Results show that there is a significant positive relationship between the TBWs of these stimuli pairs ($r= 0.551$, $p= 0.0052$). A Pearson correlation between the PSS of audio-visual and audio-active head movement stimuli ($r= 0.186$, $p= 0.385$) demonstrates a slight positive correlation that does not reach significance. Thus, in contrast to the predictions in hypothesis 1, the data does not completely support our hypothesis. Note that since this is a between subjects' analysis, data from 24 participants are used as they have a complete data set for both TOJ tasks.

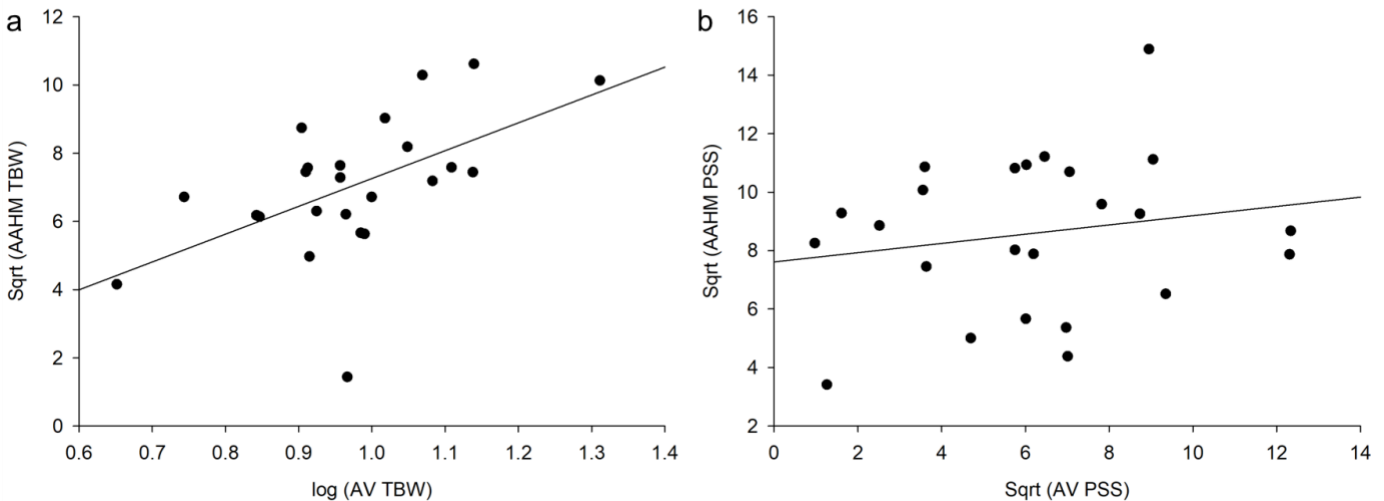

Figure 13: Pearson correlations depict the relationship between the TBW (a) and PSS (b) measures of the two stimuli pairs, audio-visual (AV) and audio-active head movement (AAHM). Note that the negative PSS values on the AV axis and positive values on the AAHM axis represent conditions where the auditory stimulus precedes the comparison stimulus.

3.3 Cybersickness results measured through the SSQ

Hypothesis 2: Statistical difference of the SSQ scores between AD and FC

Presented here are the SSQ scores obtained from both of the VR environments. Hypothesis 2 predicted that AD would induce greater levels of cybersickness compared to FC. A non-parametric Wilcoxon Signed Rank test showed that there is a statistically significant difference between the total SSQ scores of AD and FC ($Z = -5.95$, $p < 0.001$) such that AD was significantly more nauseating than FC therefore supporting our hypothesis. In addition, a repeated measures ANOVA was conducted to determine whether there was a significant difference between the SSQ sub scores of the two environments. A 2 by 3 repeated measures ANOVA demonstrates main effect of VR condition ($F(1, 49) = 61.9$, $p < 0.001$, $\eta^2_p = 0.558$) as well as a significant interaction effect between VR conditions and the SSQ subscale ($F(2, 98) = 7.06$, $p = 0.001$, $\eta^2_p = 0.125$). Post hoc comparisons between the means demonstrated that the SSQ (N), SSQ (O) and SSQ (D) scores were significantly greater in AD compared to FC. These statistics are shown below in Table 5. Cybersickness severity obtained through the SSQ are visually represented in Figure 14 showing the total SSQ (a) and the SSQ sub scores (b) resulting from each of the two VR environments.

VR environment	SSQ (N)	SSQ (O)	SSQ (D)	SSQ (T)
ADR1FT	47.9 (SD: 31.4) (SE: 4.5)	41.2 (SD: 23.4) (SE: 4.5)	61.2 (SD: 50.3) (SE: 7.2)	55.6 (SD: 33.1) (SE: 4.7)
First Contact	15.1 (SD: 19.8) (SE: 2.8)	19.7 (SD: 21.0) (SE: 3.0)	22.0 (SD: 29.3) (SE: 4.2)	21.12 (SD: 24.2) (SE: 3.4)
Paired t test results	t(49) = 7.72 p < 0.001	t(49) = 7.38 p < 0.001	t(49) = 5.96 p < 0.001	-

Table 5: Summary of the descriptive and significance statistics conducted on the cybersickness scores for each of the two environments through the SSQ. In the last row the results for the post hoc test is shown to demonstrate the significant difference in the average SSQ subscales between AD and FC.

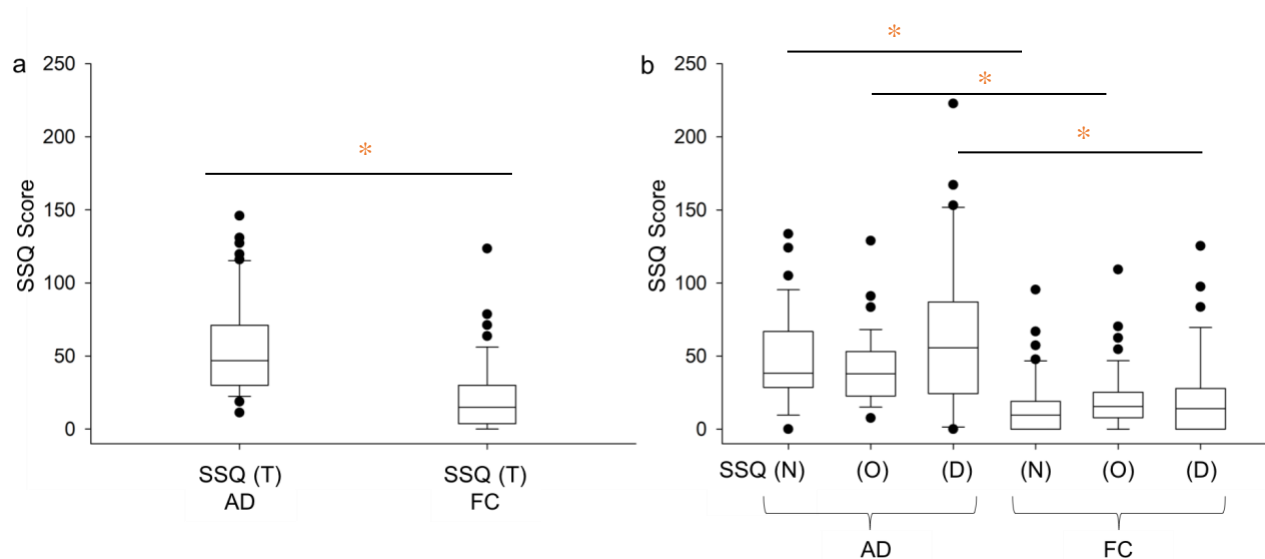

Figure 14: Box plots presented here show the SSQ scores obtained from participants after completion of AD and FC. a) shows the total SSQ score distributions for the two VR tasks, here AD showed statistically significant cybersickness severity between AD and FC in terms of the average SSQ (T). b) shows the distributions of the SSQ sub scores from AD and FC. The asterisks represent a significant difference between the total SSQ scores of the two VR conditions.

3.4 Correlational data

In this section, correlational data are presented corresponding to hypothesis 3 through 7 concerning the relationship between the psychometric parameters (visual acuity, TBW and PSS) and the SSQ scores. Data that are significant or slightly trending are shown here, while non-significant correlations are represented below in a table format. Therefore, correlations involving AD SSQ scores are visually presented below while correlations concerning FC SSQ are only summarized in Table 7 (for FC figures refer to Appendix D).

Hypothesis 3: Correlations between the audio-visual TBW and ADRIFT SSQ

Presented here are the correlations between the audio-visual TBW and the SSQ scores.

Hypothesis 3 predicted that individuals with a larger audio-visual TBW will have reported greater cybersickness symptoms for the SSQ. Although our results to date suggest that this is possible, currently the correlation for total SSQ score does not reach significance ($r= 0.216$, $p= 0.306$), nor do the nausea SSQ scores ($r= 0.156$, $p= 0.306$), or the disorientation SSQ scores ($r= 0.137$, $p= 0.364$). However, the relationship between AV TBW and oculomotor SSQ score is significantly positive ($r= 0.291$, $p= 0.05$). Figure 15 (a-d) below represents these relationships with 95% confidence intervals.

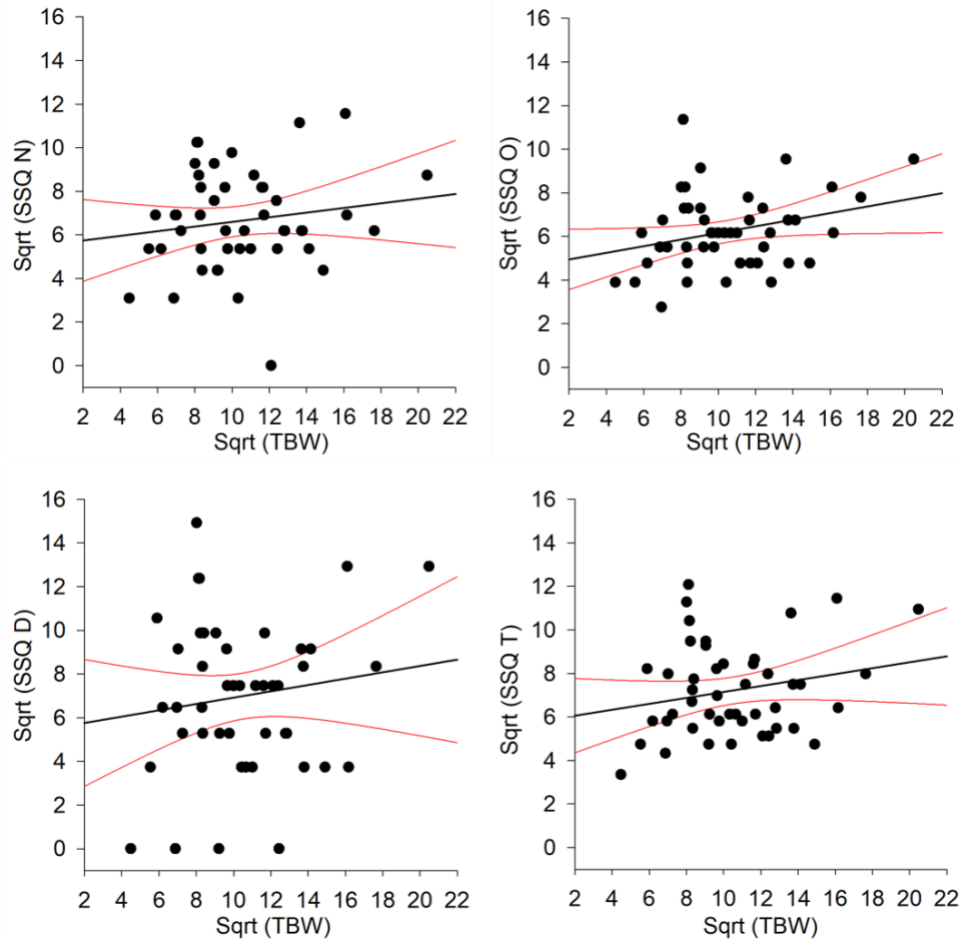

Figure 15: Correlations here portray the relationship between the audio-visual TBW and the SSQ scores. The TBW is correlated with the Nausea SSQ (a), Oculomotor SSQ (b), Disorientation SSQ (c) and Total SSQ (d). Note that in this case, both the TBW and SSQ scores are square root transformed to attain normality according to the Shapiro-Wilk test.

Hypothesis 4: Correlations of the audio-visual PSS and ADRIFT SSQ

Shown here are the Pearson correlations between the audio-visual PSS and SSQ scores.

Hypothesis 4 predicted that individuals with a PSS farther from zero (true simultaneity) will have reported higher cybersickness symptoms through the SSQ. Our results somewhat support this hypothesis as indicated by the slight positive relationships between the total SSQ ($r= 0.198$, $p= 0.188$) as well as the SSQ sub scores of oculomotor ($r= 0.256$, $p= 0.086$), disorientation ($r=$

0.114, $p=0.364$), and nausea ($r=0.209$, $p=0.163$). These relationships are visually depicted below in Figure 16 (a-d) with 95% confidence intervals.

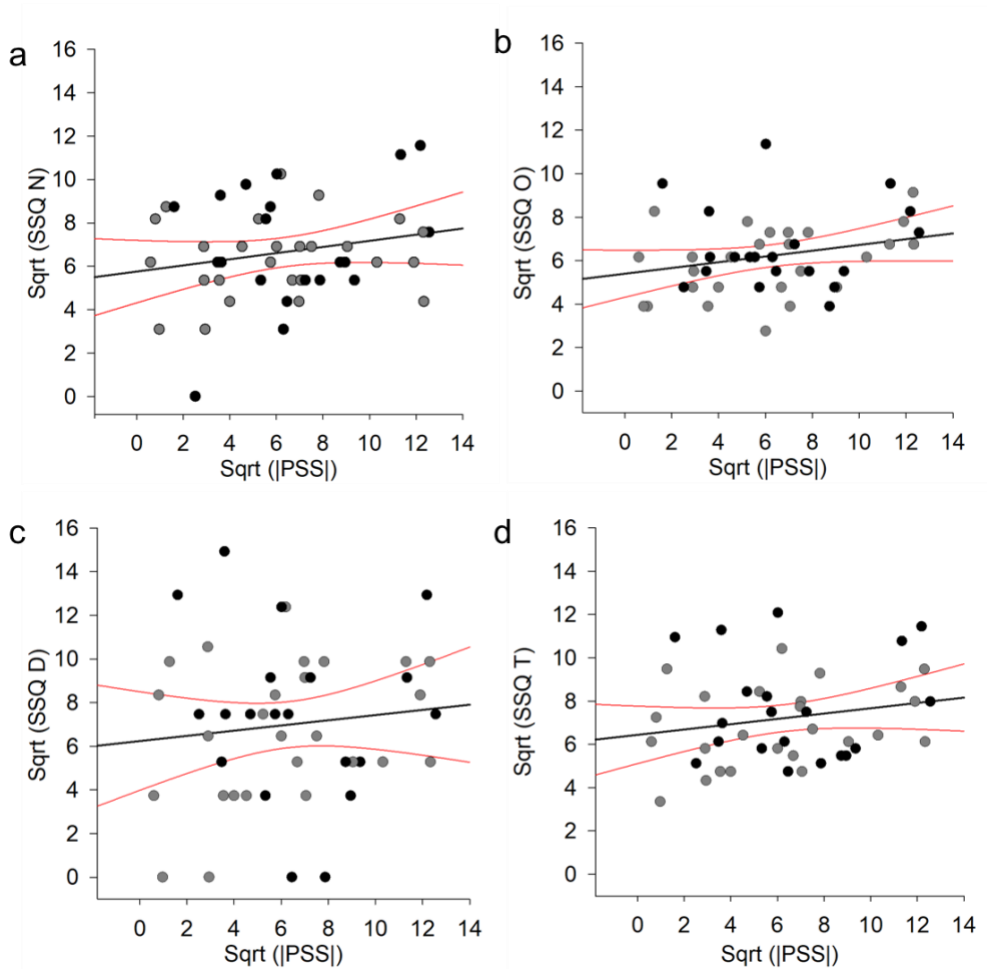

Figure 16: Correlations here portray the relationship between the audio-visual PSS and the SSQ scores. The PSS is correlated with the Nausea SSQ (a), Oculomotor SSQ (b), Disorientation SSQ (c) and Total SSQ (d). Note that the gray data points represent participants with a negative PSS indicating that they require the presentation of sound before the light in order for simultaneity to be perceived. Also note that the PSS values and SSQ scores are square root transformed to attain normality.

Hypothesis 5: Correlations of the audio-active head movement TBW and ADRIFT SSQ

Presented here are the correlations between the audio-active head movement TBW and the SSQ scores. Hypothesis 5 predicted that individuals with larger audio-active head movement TBWs will also have reported greater cybersickness symptoms through the SSQ. Our results suggest

that there is no significant correlation between the total SSQ score and TBW ($r= 0.149$, $p= 0.450$). Similarly, correlations between the TBW and the disorientation SSQ ($r= 0.186$, $p= 0.342$), nausea SSQ ($r= 0.248$, $p= 0.203$), and oculomotor SSQ ($r= - 0.04$, $p= 0.840$) do not reach significance. These relationships are visually depicted below in Figure 17 (a-d) with 95% confidence intervals.

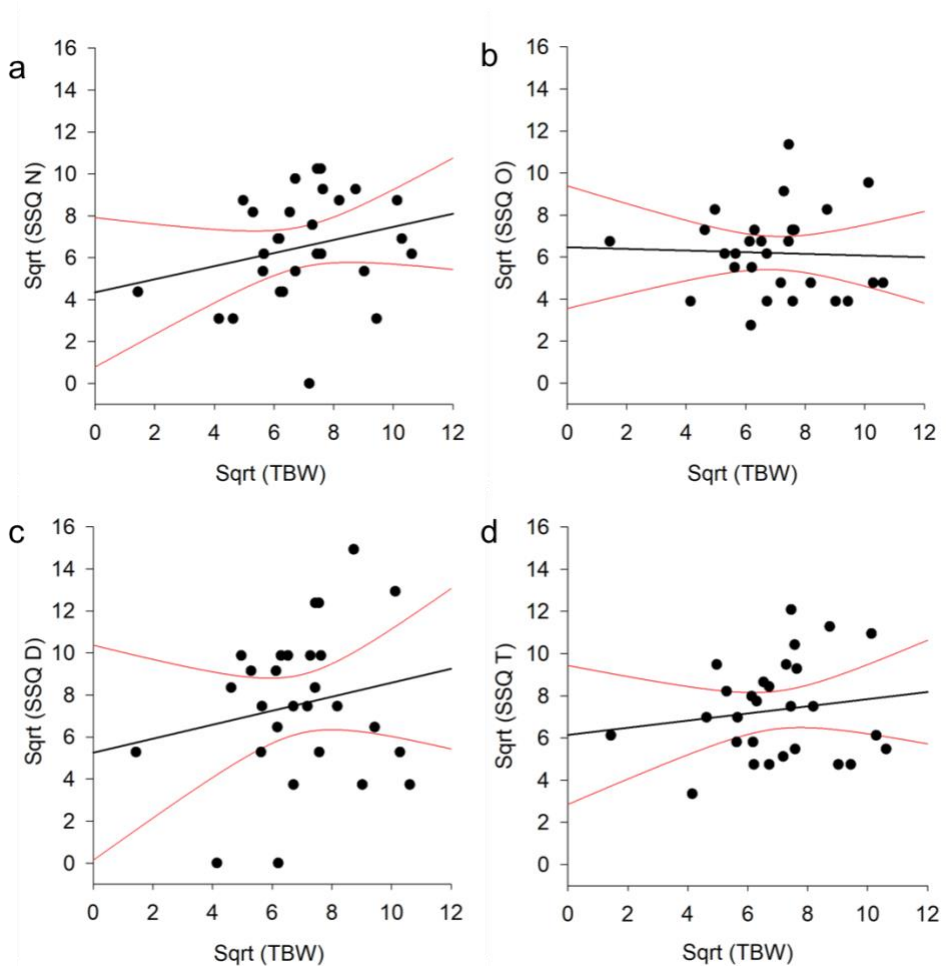

Figure 17: Correlations here portray the statistical relationship between the audio-active head movement TBW and the SSQ scores. The TBW is correlated with the Nausea SSQ (a), Oculomotor SSQ (b), Disorientation SSQ (c) and Total SSQ (d). While there is a slight positive relationship, correlations do not reach significance.

Hypothesis 6: Correlations of the audio-active head movement PSS and ADRIFT SSQ

Hypothesis 6 predicted that individuals with an audio-active head movement PSS farther from zero (true simultaneity) will have reported higher cybersickness symptoms through the SSQ scores. Our results do not support this hypothesis as all correlations between the PSS and the SSQ scores are not significant. These relationships are visually depicted below in Figure 18 (a-d) with 95% confidence intervals. The correlations are also summarized in the Table 6 below.

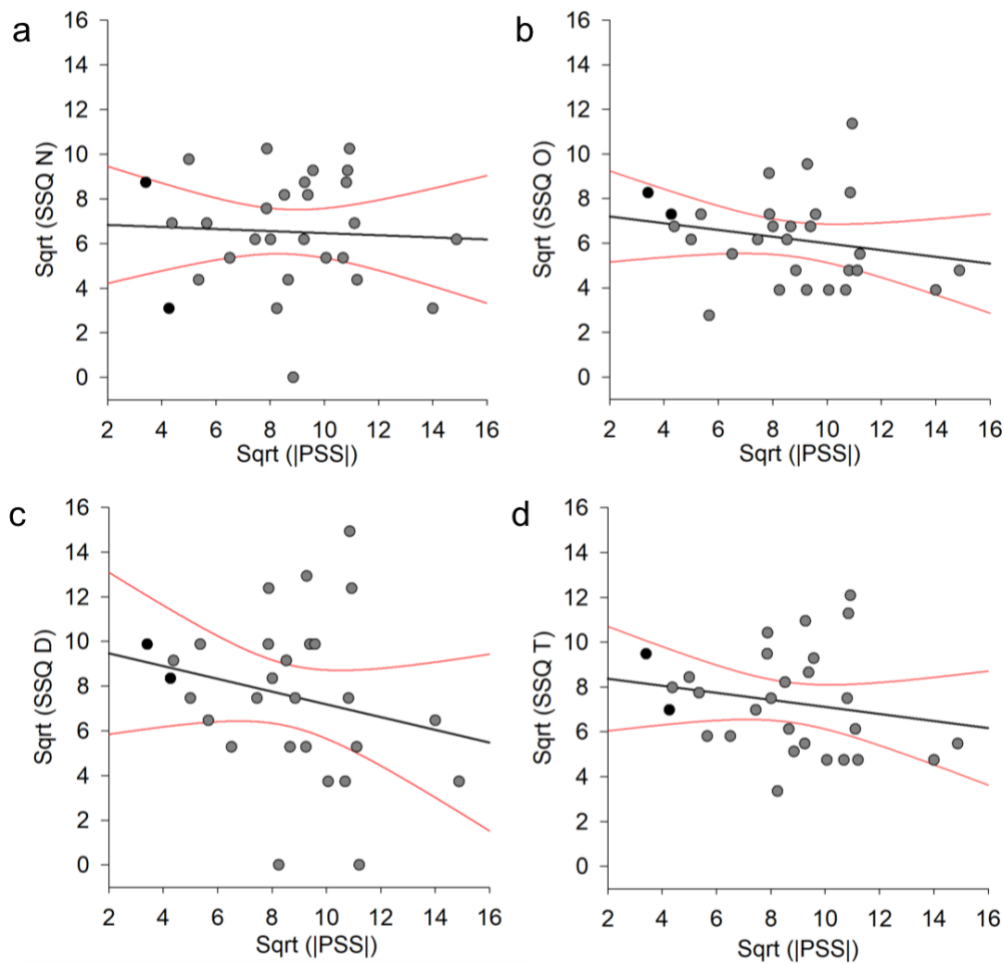

Figure 18: Correlations here portray the relationship between the audio-active head movement PSS and the SSQ scores. The PSS is correlated with the Nausea SSQ (a), Oculomotor SSQ (b), Disorientation SSQ (c) and Total SSQ (d). Again, note that the gray data points represent participants with a negative PSS indicating that they require the presentation of sound to be before the light in order for simultaneity to be perceived.

Hypothesis 7: Correlations between visual acuity and ADRIFT SSQ

Hypothesis 7 predicted that there will be a positive relationship between visual acuity and the SSQ scores such that individuals with greater visual acuity will experience lower levels of cybersickness. No significant correlations between the LogMar and SSQ were found. These relationships are visually depicted below in Figure 19 (a-d) with 95% confidence intervals. Since visual acuity assessment was done for a subset of participants, the data presented here is from 29 participants.

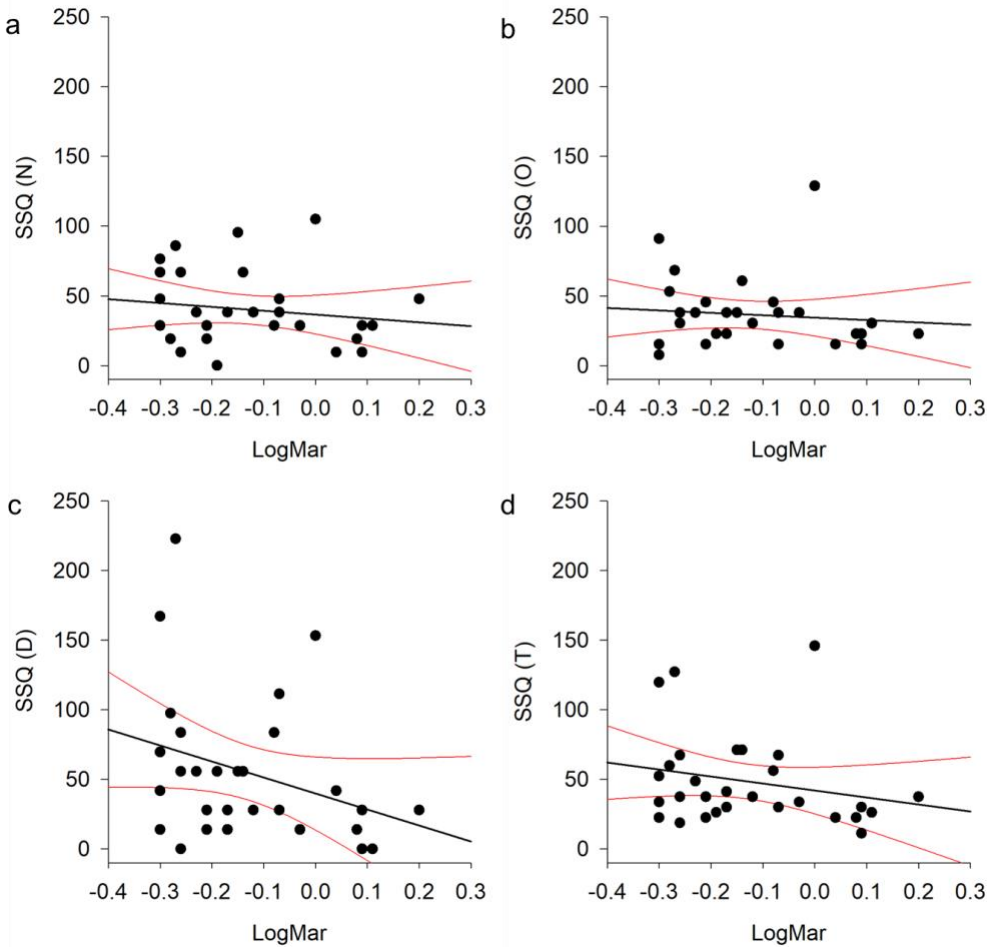

Figure 19: Correlations with 95% confidence intervals here show the relationship between the visual acuity and the SSQ scores. The PSS is correlated with the Nausea SSQ (a), Oculomotor SSQ (b), Disorientation SSQ (c) and Total SSQ (d). Note that on the LogMar scale lower values indicate better acuity.

Summary of correlations between the TBW, PSS and visual acuity measures and SSQ scores

Tables presented below summarize the correlation statistics that were conducted to understand the relationship between the psychometric parameters (TBW and PSS) and SSQ scores induced by ADR1FT (table 6) First Contact (table 7).

	Audio-visual (n= 46)				Audio-Active head movement (n= 28)			
	TBW		PSS		TBW		PSS	
	r	p	r	p	r	p	r	p
SSQ(N)	0.156	0.306	0.209	0.163	0.248	0.203	-0.05	0.796
SSQ(O)	0.291	0.05	0.256	0.086	-0.04	0.840	-0.209	0.285
SSQ(D)	0.137	0.364	0.114	0.364	0.186	0.342	-0.222	0.256
SSQ(T)	0.216	0.149	0.198	0.188	0.149	0.450	-0.192	0.327

Table 6: Correlation parameters between the TBW and PSS measures and the SSQ scores from AD. Bolded values indicate significant correlations.

	Audio-visual (n= 46)				Audio-Active head movement (n= 28)			
	TBW		PSS		TBW		PSS	
	rho	p	rho	p	rho	p	rho	p
SSQ(N)	-0.185	0.218	0.107	0.478	-0.06	0.72	-0.03	0.87
SSQ(O)	0.135	0.368	0.079	0.61	0.14	0.37	0.12	0.55
SSQ(D)	0.124	0.408	0.237	0.113	0.259	0.182	0.01	0.62
SSQ(T)	0.057	0.71	0.114	0.45	0.139	0.477	0.101	0.61

Table 7: Statistical relationship between the TBW and PSS measures and SSQ scores from FC.

Correlations are obtained through the Spearman's correlation.

Visual acuity	rho	p
SSQ (N)	-0.159	0.408
SSQ (O)	-0.115	0.550
SSQ (D)	-0.363	0.053
SSQ (T)	-0.256	0.179

Table 8: Statistical relationship between visual acuity and SSQ scores from AD. These associations are obtained through the Spearman’s correlation (for n=29) using the raw visual acuity measures (LogMar).

	Audio-visual				Audio-active head movement			
	TBW		PSS		TBW		PSS	
	LL	UL	LL	UL	LL	UL	LL	UL
SSQ(N)	-0.141	0.427	-0.087	0.471	-0.138	0.568	-0.415	0.329
SSQ(O)	0.001	0.536	-0.037	0.509	-0.407	0.338	-0.540	0.178
SSQ(D)	-0.160	0.411	-0.182	0.391	-0.201	0.523	-0.550	0.165
SSQ(T)	-0.079	0.476	-0.098	0.462	-0.237	0.495	-0.527	0.195

Table 9: Correlation confidence intervals are shown in this table for each correlation with the AD SSQ scores. The upper limit (UL) and lower limit (LL) of the confidence intervals are shown here.

	Audio-visual				Audio-active head movement			
	TBW		PSS		TBW		PSS	
	LL	UL	LL	UL	LL	UL	LL	UL
SSQ(N)	-0.451	0.111	-0.189	0.385	-0.423	0.32	-0.398	0.346
SSQ(O)	-0.162	0.409	-0.216	0.361	-0.245	0.487	-0.264	0.471
SSQ(D)	-0.173	0.400	-0.057	0.493	-0.126	0.576	-0.364	0.381
SSQ(T)	-0.237	0.342	-0.182	0.391	-0.246	0.486	-0.282	0.456

Table 10: Correlation confidence intervals are shown in this table for each correlation with the FC SSQ scores. The upper limit (UL) and lower limit (LL) of the confidence intervals are shown here.

Visual acuity	LL	UL
SSQ (N)	-0.496	0.22
SSQ (O)	-0.462	0.262
SSQ (D)	-0.643	0.004
SSQ (T)	-0.569	0.121

Table 11: Correlation confidence intervals are shown in this table for each correlation with the AD SSQ scores and visual acuity measures. The upper limit (UL) and lower limit (LL) of the confidence intervals are shown here.

According to Table 7, the correlations are not significant as indicated by the very small positive and negative correlation coefficients between the TBW and PSS and the FC SSQ scores. Therefore, hypotheses 3 through 6 are not supported by the data regarding correlations between FC SSQ scores and psychometric parameters (i.e., audio-visual and audio-active head movement TBW and PSS).

4.0 Discussion

4.1 General discussion

In the current study, we examined the relationship between perceived timing of multisensory events and the severity of cybersickness in VR. To accomplish this, participants in this study performed two TOJ tasks (involving an audio-visual pair and an audio-active head movement pair) as well as a VR task (consisting of two conditions). Participants' cybersickness severity was assessed in two different VR environments. Our data shows that cybersickness severity was greater in the more intense condition (i.e., ADRIFT). Correlation analyses were conducted between the TBW (i.e., temporal precision) and PSS (i.e., temporal accuracy) measures with cybersickness severity quantified by the SSQ. In general, our results suggest that there is a slight positive relationship between the TBW and cybersickness severity, but it does not yet reach significance. This relationship is observed for both audio-visual and audio-active head movement TBWs with the total sickness severity. As initially predicted, individuals with larger TBWs reported greater cybersickness symptoms indicating that those who have wider TBWs may be more susceptible to cybersickness. The observed relationship between the audio-visual PSS and cybersickness severity also suggests that there is a slight positive relationship with cybersickness severity. However, there is no relationship observed between the audio-active head movement PSS and cybersickness. Therefore, it could be that individual differences in TBW (i.e., temporal precision) of audio-visual integration may be a suitable predictor of cybersickness as opposed to measures of the PSS (i.e., temporal accuracy). Nonetheless, further investigation is required to

develop a comprehensive understanding of these relationships. Below I will briefly discuss the study results (pertaining to hypothesis 1 through 7) as well as limitations and future directions.

4.2 TOJ findings

Audio-visual TOJ findings

It was predicted that our findings will confirm previous audio-visual TOJ results found by Bedard and Barnett-Cowan (2016). Hence, in line with previously established results, our data suggests large individual differences in measures of the TBW and PSS (as observed in Figure 12a). Here, some individuals are observed to have PSS values nearing true simultaneity while others show extreme PSS measures that deviate significantly from zero. In addition to the large individual differences in the magnitude of the PSS, there are also individuals who show a negative PSS indicating that they require the sound to be presented prior to the light. Studies have found that on average the PSS favours conditions where the visual stimulus is presented first in order for an audio-visual event to be perceived as occurring simultaneously (Jaskowski et al., 1990; Love et al., 2013; Bedard and Barnett-Cowan, 2016). In contrast to these findings, the average PSS in the current study is measured as 3.05 ms indicating that on average individuals require the stimuli to be presented approximately simultaneously in order for perceptual synchrony to occur. Now, the question is why might there be differences in the findings between our study and others?

Researchers suggest that factors such as stimulus intensity and attention can modulate the PSS such that it is shifted due to manipulations to these factors. In general, stimuli that are more intense or attended to are detected at lower latencies relative to less intense or unattended stimuli. Neumann et al., (1992) manipulated the intensity of a sound and a visual stimulus in a TOJ task and found that higher intensity stimuli were observed earlier than lower intensities. Equally

important, Titchner (1908) theorized the law of prior entry that states that attended stimuli come to conscious quicker than those that are unattended to (from Spence, Shore and Klein 2001). Spence and colleagues (2001) found that during a visual-tactile TOJ task when observers were instructed to pay attention to the tactile stimulus, the PSS shifted such that the visual stimulus had to appear much earlier (155 ms vs 22 ms) than the tactile stimulus in order for them to be perceived as simultaneous (Spence, Shore and Klein 2001). Similar results have been found for audio-visual stimuli pairs (Boenk, Dehliano and Ohl, 2009) where a greater stimulus intensity was linked to earlier detection of stimuli. In the current study, to eliminate variability caused by the stimulus intensity, the intensity of the sound and the flash was consistent throughout the task. As well, participants were instructed to pay equal attention to both stimuli to eliminate effects caused by attention.

Related to audio-visual TOJs, similar patterns were demonstrated in the measures of the TBW (i.e., temporal precision). Our data for the average TBW is consistent with values previously reported for young healthy adults in the literature by Love et al., 2013, Bedard and Barnett-Cowan, 2016, and Wise and Barnett-Cowan, 2018. Love and colleagues (2013) determined the audio-visual TBW to be approximately 146 ms which is similar to the average TBW of 129 ms determined in the current study. This means that on average 129 ms is the maximal asynchrony between audio-visual stimuli that are still perceived as occurring simultaneously. Therefore, audio-visual events that are asynchronous by SOAs of greater than 129 ms may not be integrated.

Audio-active head movement TOJ findings

In line with results previously found by Barnett-Cowan and Harris (2011), in the current study, individual differences in terms of the PSS and TBW of audio-active head movement

stimuli were also found. Similar to audio-visual results, we found a wide distribution of participants with respects to their measure of the PSS. Nonetheless, the data suggests that on average individuals require the onset of the active head movement to occur 78 ms prior to the auditory cue in order for the stimuli to be unified into a single percept. In a TOJ task with a sound and an active head movement, Barnett-Cowan and Harris (2011) found that on average the onset of the active head movement had to precede the sound by about 80 ms in order for integration to take place. Therefore, our results confirm findings by Barnett-Cowan and Harris (2011) as well as others who also find that perception of head movement is slower compared to an auditory cue (Barnett-Cowan and Harris 2009; Sanders et al., 2011). Equally important, our data suggests that the average audio-active head movement TBW varies slightly from measures previously reported in the literature. Here, we determined the average TBW to be approximately 51 ms while previous studies find this to be in the range of approximately 65 to 95 ms (Barnett-Cowan and Harris 2009, 2011; Chung and Barnett-Cowan, 2017; Sachgau, Chung and Barnett-Cowan, 2018). Possible reasons to explain this deviation could be related to the limitations of the audio-active head movement task discussed below.

One of the major limitations of this task is that in contrast to audio-visual TOJs, the active head movement that is paired with the sound is generated by the participant. Because the head movement is self-generated, there are large variations between and within participant data due to inconsistencies in the timing and velocity of the head movement. For instance, some participants may start their head movement as soon as the cue is offset while others may take time to onset the active movement. Therefore, it could be that subjective differences in the velocity and the timing of the onset of the head movement may affect temporal perception of the audio-active head movement pair. Having acknowledged these subjective biases, in the current

study we not only instruct participants to move their head at ‘normal’ velocity, we also have them practice their head movement velocity to ensure that it is not drastically fast or slow. Although it is beyond the scope of this thesis, in the future, head movement velocity should be monitored by an external device to maintain consistency within and between participants. To be consistent in timing of the head movement, participants are instructed to move their head instantly when the ‘go signal’ is offset. Furthermore, additional to these individual variabilities, stimulus intensity and attention are other factors that may contribute to changes in temporal perception of the stimuli pair. As previously mentioned for audio-visual TOJs, these factors have similar effects on the PSS of audio-active head movement stimuli.

Correlations between psychophysical parameters of AV and AAHM TOJs

Although this has not been assessed before, in this study it is expected that since temporal precision and accuracy are general features of multisensory integration, individuals with a wider audio-visual TBW will also have a wider audio-active head movement TBW. Along the same argument, individuals with audio-visual PSS measures that deviate more from true simultaneity are also expected to have a larger audio-active head movement PSS. Thus, in addition to confirming previous TOJ results, it was predicted that there would be a relationship between the TBW and PSS of the two stimuli pairs. Correlations between the TBWs demonstrate a significant positive relationship. This could be indicative of a link between the temporal accuracy of the two sensory pairs thereby suggesting that individuals with wider audio-visual TBW also tend to have wider audio-active head movement TBWs. There may be two reasons to explain this relationship. It may be that temporal accuracy of multisensory integration is governed by mechanisms that are shared between different sensory pairs. As well, since the auditory cue is present in both sensory pairs, it could be that auditory processing is the mediating factor to drive

this relationship. According to the results found for the relationship between the PSS measures, the latter is unlikely the reason to explain the relationship.

Results from correlations between the PSS measures also show a positive relationship (although not significant) indicating that individuals with a larger audio-visual PSS tend to have a larger audio-active head movement PSS. However, it is difficult to infer conclusions about this correlation as it does not reach statistical significance. Additionally, because the stimuli used for the two TOJs are so different from each other, it is difficult to compare the TBW and PSS measures between the two. In the audio-visual TOJ, both stimuli are generated by the experimental equipment while in the audio-active head movement task, the head movement is self-generated. Self-generation of the head movement introduces several factors, as mentioned above, that may differ between and within individuals (Barnett-Cowan, Raeder, and Bultoff, 2002; Sachgau, Chung and Barnett-Cowan, 2018). For instance, while some individuals may commence the head movement quicker after the offset of the ‘go signal’ others may take longer to start the head movement. Since the timing between the offset of the ‘go signal’ and the auditory stimulus is predetermined, the timing of the head movement onset may introduce variability between the SOAs of the head movement onset and the auditory stimulus. As a consequence, the data from the two tasks are inherently different which may explain why the correlations do not show the true nature of the relationship. Nonetheless, further investigation is required to fully understand these relationships.

4.3 Cybersickness severity in two VR conditions

In this study, we assessed cybersickness severity induced by the two different VR environments. To accomplish this, we tested participants in two unique VR environments, AD and FC. As expected, cybersickness severity was significantly greater when participants were

exposed to AD. A two by three way (VR condition vs SSQ subscale) ANOVA showed a significant main effect of VR condition with a significant interaction effect between VR condition and SSQ subscale. Post hoc tests showed a statistically significant difference between the total SSQ scores ($Z=-5.95$, $p<0.001$) for the two VR conditions. The interaction between VR condition and SSQ subscales indicate that the average reported SSQ subscale scores were significantly greater for AD as compared to FC. For instance, the average reported SSQ (N), SSQ (O) and SSQ (D) are significantly higher in AD than in FC. This result aligns with the fact that in general, AD is known to be a nauseating environment as compared to FC according to users who have already explored and rated the environment on the Oculus Rift web user interface. One of the reasons why AD may be more nauseating could stem from the fact subjects are presented with visual motion even though they remain stationary. This may induce a sensory conflict between visual and inertial cues for sense of motion. In AD, a hand controller is used to float around in the virtual spaceship while in FC participants make physical movements that are translated into visual motion. Hence, FC may be less nauseating due to the fact that motion is conveyed by both visual and inertial senses which means that there is a lower chance for a sensory conflict to occur.

Additionally, in AD users are performing head movements to explore the environment which may also exacerbate cybersickness symptoms. Findings from the literature provide strong evidence to suggest that head movements may worsen cybersickness symptoms in VR. Researchers find that individuals who perform frequent, intense or rapid head movements experience greater cybersickness symptoms (Regan and Price, 1993; Howarth and Finch, 2010). Howarth and Finch (2010) demonstrated that when subjects explored a VR environment through head movements, they reported greater cybersickness symptoms than those who explored the

environment through hand controllers. In FC, although participants performed head movements, their head movements were associated with whole-body movements as opposed to AD where head movements were independent of whole-body motion. Therefore, head movements in AD may be one of the reasons for increased cybersickness severity. Other factors such as optic flow and the magnitude with which the VR environment deviates from the real world may explain why AD resulted in significantly greater cybersickness severity compared to FC. It could be that FC is less nauseating because it complies with natural human navigation through the environment. However, despite such compelling evidence, it should be noted that these cybersickness measurements may be affected by limitations linked to the SSQ that must be acknowledged.

Although the SSQ is an established sickness assessment tool, it is subject to systematic biases that may influence its efficacy as a measure of cybersickness. Since it is based on self-reports, measurements are subject to individual differences in interpretation and perception of symptom severity. Additionally, because participants complete the SSQ at the end of the 30-minute exposure period, it is possible that they misremember their experiences, or they may disproportionately weight certain symptoms. For instance, one participant's rating of 'slight nausea' may be 'moderate nausea' for another participant depending on individual differences in the perceived severity of the symptom. Another possible limitation is that participants may interpret symptom names differently in contrast to what they actually measure. For example, one of the symptoms that some participants have an issue understanding is 'fullness of head' which is a physiological term describing the phenomenon where blood pools on the upper part of the body when individuals are immersed in a microgravity environment (such as space). Although these differences in symptom reports are inevitable, in an attempt to minimize misinterpretation of the

symptoms, in the current study the experimenter describes the symptoms to the participants and asks them if additional detail is necessary. Taking this into consideration, it is important to note that previous literature shows that the SSQ is a valid measure of cybersickness because it is found to be correlated to physiological symptoms of cybersickness. One of the studies to find this effect is conducted by Kim et al., (2005) who correlated cybersickness measured through the SSQ with physiological responses (gastric tachyarrhythmia, eyeblink rate, heart rate period and different EEG bands). In their study, they demonstrated that there was a significant correlation between the two measures therefore validating the SSQ as an effective measure of cybersickness.

4.4 Correlational findings

TBW vs cybersickness severity

As the main goal of the current study was to determine whether there is a relationship between psychophysical measures of multisensory integration and cybersickness severity, we conducted correlations between the two measures. Our data suggests that there may be a relationship between the audio-visual and audio-active head movement TBW and cybersickness severity (refer to Figure 15 and 17). Although these correlations are not significant, some trend towards a positive relationship to suggest that individuals with larger TBWs may experience greater cybersickness symptoms. Intuitively, it would be plausible to deduce that individuals with a wider TBW theoretically experience less severe symptoms because visual-inertial delays would not be perceived with wider than normal TBWs. According to the literature on the association between display lags in VR and cybersickness, larger delays between the user's movement and the update of the visual display is associated with greater sickness severity and incidence (Dizio and Lackner, 1997; Jennings et al., 2004). Although this has not been tested, one would suggest that an individual with a wider TBW would not perceive the delay and therefore would integrate

the movement with the delayed visual response thereby preventing a sensory conflict (i.e., no affect in the users' sickness levels). For the reason that this hypothesis has not yet been tested, the rationale in this thesis is different. Here, we use the rationale that since a wider than normal TBW may lead to inaccurate perception of the surrounding environment, these individuals may also experience challenges in perception in VR thereby leading to greater susceptibility to cybersickness.

Studies in the past have shown that wider TBWs may be associated with various cognitive disorders. In a study by Foss-Feig and colleagues (2010) the TBW was determined for ASD and typically developing children through the beep-flash illusion paradigm. Results showed that the size of the TBW was twice as wide in ASD children compared to normally developing children (Foss-Feig et al., 2010). Furthermore, as mentioned earlier, a wider TBW indicates the tendency to integrate sensory events over a wider range of SOAs when they should actually be perceived as asynchronous therefore leading to perceptual ambiguity and confusion due to sensory overload (Sartora and colleagues, 2017). Therefore, it could be that a wider TBW may lead to lower than optimal perception and hence discomfort during exposure to VR.

In general, the data here indicates that there are slight positive associations between the TBW and cybersickness severity. However, there is a significant positive correlation between audio-visual TBW and the oculomotor SSQ score ($r = 0.291$, $p = 0.05$; refer to Figure 15b). Since the same effect is not found between audio-active head movement TBW and SSQ (O), it may suggest that audio-visual integration is crucial in VR and that it may better explain cybersickness. Intuitively this makes sense because participants are presented with largely visual and auditory information through the HMD which may suggest that audio-visual perception in time is a crucial process in VR. However, this perspective is not supported by the literature.

Studies find that cybersickness severity is not affected when auditory cues are combined with a visual scene in VR (Nichols et al., 2000; Keshavarz and Hetch, 2012 and 2014). For example, in a study by Keshavarz and Hetch (2012), subjects were split into two groups. In group 1, participants were provided with a visual scene with accompanying sounds while participants in group 2 were not presented with the auditory cues (i.e., only visual cues). Sickness was quantified in both groups through the SSQ and it was found that there was no significant difference in severity between the two. Therefore, they concluded that sound does not affect sickness severity suggesting that auditory cues may not be important in sickness severity (Keshavarz and Hetch, 2012). To combine this literature and the fact that this effect is only found amongst audio-visual TBW in our data, it could essentially be that processing of visual information is the driving factor to explain the positive correlation between audio-visual TBW and SSQ (O).

Furthermore, given that the significant correlation is seen only with the oculomotor SSQ subscale, it reinforces the idea that processing of visual information may be a crucial factor in cybersickness as opposed to other cues (such as auditory or head movements). A large portion of the literature provides evidence to show that compelling visual cues in simulated environments induce discomfort which eventually leads to sickness symptoms (Hettinger and Riccio, 1992; Palmisano, Mursic and Kim, 2017). In this study, participants in ADRIFT are also exposed largely to visual information which might be the main factor to have driven oculomotor discomfort and hence the SSQ (O) score. Although the neural mechanisms of how vision may be connected to sickness remain unknown, brain imaging techniques have found that there are connections between visual processing regions and those potentially related to sickness. Toschi and colleagues (2017) conducted a study where they assessed the functional connectivity

between visual processing areas (V1 and MT or V5) and nausea related brain regions (anterior cingulate cortex and anterior insula) through functional MRI (fMRI). Here, they presented participants with visual stimulation in the scanner and quantified sickness severity during and after stimulus presentation. Their results showed that changes in perceived nausea severity altered functional connectivity between visual processing areas and nausea regions. Specifically, they found that increases in nausea severity also resulted in increased connectivity between the right V1/MT and the anterior insula, as well as between left V1/MT and middle cingulate cortex (Toschi et al., 2017). Therefore, although further investigation is required, it may be that vision and sickness generation may be subserved by shared mechanisms.

PSS vs cybersickness severity

Correlational data regarding the PSS measures show similar results as the TBW. In general, the relationship between the audio-visual PSS and cybersickness severity are slightly positive to suggest that individuals who have PSS values that deviate most from true simultaneity experience greater levels of cybersickness (refer to Figure 16). This means that individuals who require the visual stimulus to precede the sound by a greater amount of time are also experiencing greater cybersickness symptoms in this sample.

While these correlations do not reach significance, an explanation that is likely to describe this relationship is the sensory conflict theory. Although human perception is not sensitive to small temporal offsets between modalities, the CNS may be more sensitive to these delays which may lead to a sensory mismatch signal (in this case between vision and movement) thereby eliciting cybersickness. However, this would only be true if there were shared mechanisms between audio-visual perception in time and processing of visual-inertial delays in VR. While these mechanisms are not yet fully understood, this finding could be linked to neural

correlates of audio-visual integration and motion sickness. Bushara et al., (2010) have shown that audio-visual integration amongst many other brain regions also takes place in brainstem structures such as the superior colliculus. Although it remains to be determined, researchers speculate that since eye and head movements are factors that contribute to motion sickness, brainstem structures such as the superior colliculus (Ji et al., 2005) and vestibular nuclei (Oman and Cullen, 2014) may be involved in generation of sickness symptoms. However further studies that are beyond the scope of this thesis are required to fully understand the underlying mechanisms.

Furthermore, the non-significant correlations between the audio-active head movement PSS and cybersickness demonstrate that there is no relationship between the two entities (refer to Figure 18). This finding is particularly intriguing considering the contributions of active head movements to cybersickness in VR. In a study, Regan and Price (1993) demonstrated that when participants performed more intense and rapid head movements, they experienced cybersickness levels that were significantly worse than those who made normal (or natural) head movements. Much later findings from Howarth and Finch (2010) demonstrated that when subjects explored a VR environment through performing head movements, they reported greater cybersickness symptoms than those who explored the environment through hand controllers. Therefore, to explain the absence of a relationship between cybersickness and audio-active head movement PSS it can be speculated that there are other aspects (besides temporal perception) of active head movements that are related to cybersickness. Thereby suggesting that there is no relationship between temporal perception of auditory and active head movements to cybersickness.

Visual acuity vs cybersickness severity

In contrast to our prediction, correlations regarding visual acuity and cybersickness severity share a negative relationship. Although not significant, the data suggests that individuals with greater acuity (i.e., lower score on the LogMar scale) tend to report greater SSQ scores while those with lower acuity (i.e., higher score on the LogMar scale) tend to report lower symptoms. This finding is also contradictory to the current literature which demonstrates that individuals with greater visual acuity tend to report lower sickness symptoms as compared to those with lower visual acuity (Webb and Griffin, 2003). Despite these results, there is limited literature on the association between visual acuity and cybersickness which makes it difficult to infer a strong conclusion about the relationship. Additionally, since a nonparametric test was conducted, it may be that a larger sample is required to show the true nature of the relationship between the two entities. Considering the significant relationship between audio-visual TBW and oculomotor SSQ, future studies should investigate the association between visual acuity and cybersickness to further reveal the role of vision in cybersickness. Nonetheless, it is important to note that due to the multiple comparisons conducted in this study and the fact that we did not apply a correlation correction, the results should be interpreted with caution.

5.0 Conclusion

In the current study, we examined the relationship between perceived timing of multisensory events and the severity of cybersickness in VR so as to be able to predict cybersickness severity through psychophysical measures. Overall, we were able to successfully replicate previous audio-visual and audio-active head movement TOJ results regarding the individual differences as well as the average TBW and PSS measures. However, considering the current dataset, there is no compelling evidence to suggest that psychophysical parameters of multisensory integration are ideal predictors of cybersickness in VR. It could be that the large individual differences in the psychophysical parameters and cybersickness reports are the underlying reason for the low variance explained by the predictors. Or the weak associations in the data might suggest that sensory processing of audio-visual and audio-active head movement stimuli pairs are not critical in cybersickness. To support this speculation, the significant positive correlation that was found between audio-visual TBW and oculomotor sickness reinforces the role of visual processing deficits and increased likelihood of cybersickness (see Stanney and Kennedy, 1997).

Therefore, future studies should assess the relationship between psychometrics of visual and vestibular cues with cybersickness severity. This may be a more predictive stimuli pair because of the vast majority of literature that exists on the sensory conflict between visual and vestibular signals (Reason, 1978; Oman, 1990; Bles et al., 1998; Bos et al., 2008). As opposed to other methods of predicting sickness (such as physiological measures), psychometric parameters provide for a means to predict sickness severity prior to the user's exposure to VR content. In this manner, users' cybersickness severity can be predicted beforehand which will allow for development of VR content that are tailored to deliver individuals with an optimal experience

during exposure. According to a recent report, VR market revenue is expected to reach 26.89 billion USD by 2022 (Virtual Reality Market Size & Growth, 2018) indicating that more and more individuals are exposed to VR and hence at risk for cybersickness. Therefore, it is significant to develop tools used to understand why such individual differences exist in cybersickness so as to be able to reduce or prevent symptoms.

6.0 Reference list

- Angelaki, D. E., & Hess, B. J. (2005). Self-motion-induced eye movements: effects on visual acuity and navigation. *Nature Reviews Neuroscience*, 6(12), 966.
- Bach, M. (1996). The Freiburg Visual Acuity Test-automatic measurement of visual acuity. *Optometry and vision science*, 73(1), 49-53.
- Barnett-Cowan, M., & Harris, L. R. (2009). Perceived timing of vestibular stimulation relative to touch, light and sound. *Experimental brain research*, 198(2-3), 221-231.
- Barnett-Cowan, M., & Harris, L. R. (2011). Temporal processing of active and passive head movement. *Experimental brain research*, 214(1), 27.
- Barnett-Cowan, M., Nolan, H., Butler, J. S., Foxe, J. J., Reilly, R. B., & Bühlhoff, H. H. (2010). Reaction time and event-related potentials to visual, auditory and vestibular stimuli. *Journal of Vision*, 10(7), 1400-1400.
- Barnett-Cowan, M., Raeder, S. M., & Bühlhoff, H. H. (2012). Persistent perceptual delay for head movement onset relative to auditory stimuli of different durations and rise times. *Experimental brain research*, 220(1), 41-50.
- Basharat, A., Adams, M. S., Staines, W. R., & Barnett-Cowan, M. B. C. (2018). Simultaneity and temporal order judgments are coded differently and change with age: an event-related potential study. *Frontiers in integrative neuroscience*, 12, 15.
- Bedard, G., & Barnett-Cowan, M. (2016). Impaired timing of audiovisual events in the elderly. *Experimental brain research*, 234(1), 331-340.
- Bense, S., Stephan, T., Yousry, T. A., Brandt, T., & Dieterich, M. (2017). Multisensory Cortical Signal Increases and Decreases During Vestibular Galvanic Stimulation (fMRI). *Journal of Neurophysiology*, 85(2), 886–899. <https://doi.org/10.1152/jn.2001.85.2.886>
- Bertelson, P., & Aschersleben, G. (2003). Temporal ventriloquism: Crossmodal interaction on the time dimension. 1: Evidence from auditory–visual temporal order judgment. *International Journal of Psychophysiology*, 50, 147-155.
- Biocca, F. (1992). Virtual Reality Technology: A Tutorial, *Journal of Communication*, 42(4), pp. 23–72.
- Bles, W., Bos, J. E., De Graaf, B., Groen, E., & Wertheim, A. H. (1998). Motion sickness: only one provocative conflict? *Brain research bulletin*, 47(5), 481-487.

- Bos, J. E., Bles, W., & Groen, E. L. (2008). A theory on visually induced motion sickness. *Displays*, 29(2), 47-57.
- Brandt, T., & Dieterich, M. (1999). The vestibular cortex: its locations, functions, and disorders. *Annals of the New York Academy of Sciences*, 871(1), 293-312.
- Bushara, K. O., Grafman, J., & Hallett, M. (2001). Neural correlates of auditory–visual stimulus onset asynchrony detection. *Journal of Neuroscience*, 21(1), 300-304.
- Calvert, G. A., Bullmore, E. T., Brammer, M. J., Campbell, R., Williams, S. C., McGuire, P. K., ... & David, A. S. (1997). Activation of auditory cortex during silent lipreading. *science*, 276(5312), 593-596.
- Chang, E., Hwang, I., Jeon, H., Chun, Y., Kim, H. T., & Park, C. (2013). Effects of rest frames on cybersickness and oscillatory brain activity. In *Brain-Computer Interface (BCI), 2013 International Winter Workshop on* (pp. 62-64). IEEE.
- Chung, W., & Barnett-Cowan, M. (2017). Persistent perceptual delay for active head movement onset relative to sound onset with and without vision. *Experimental brain research*, 235(10), 3069-3079.
- Cobb, S. V., Nichols, S., Ramsey, A., & Wilson, J. R. (1999). Virtual reality-induced symptoms and effects (VRISE). *Presence: Teleoperators & Virtual Environments*, 8(2), 169-186.
- Corey, D. P., Maoiléidigh, D. Ó., & Ashmore, J. F. (2017). Mechanical Transduction Processes in the Hair Cell. In *Understanding the Cochlea* (pp. 75-111). Springer, Cham.
- Corey, D. P., & Hudspeth, A. J. (1979). Ionic basis of the receptor potential in a vertebrate hair cell. *Nature*, 281(5733), 675-677.
- Cullen, K. E., & Roy, J. E. (2004). Signal processing in the vestibular system during active versus passive head movements. *Journal of neurophysiology*, 91(5), 1919-1933.
- Davis, S., Nesbitt, K. and Nalivaiko, E. (2014): A systematic review of cybersickness. Proceedings of the 10th Annual Conference on Interactive Entertainment, Newcastle, ACM.
- DiZio, P., & Lackner, J. R. (1997). Circumventing side effects of immersive virtual environments. *In HCI*, 2, 893-896).
- Dong, X., Yoshida, K., & Stoffregen, T. A. (2011). Control of a virtual vehicle influences postural activity and motion sickness. *Journal of Experimental Psychology: Applied*, 17(2), 128.

- Gianaros, P. J., Muth, E. R., Mordkoff, J. T., Levine, M. E., & Stern, R. M. (2001). A questionnaire for the assessment of the multiple dimensions of motion sickness. *Aviation, space, and environmental medicine*, 72(2), 115.
- Giard, M. H., & Peronnet, F. (1999). Auditory-visual integration during multimodal object recognition in humans: a behavioral and electrophysiological study. *Journal of cognitive neuroscience*, 11(5), 473-490.
- Goodale, M. A. (2011). Transforming vision into action. *Vision research*, 51(13), 1567-1587.
- Gu, Y., DeAngelis, G. C., & Angelaki, D. E. (2007). A functional link between area MSTd and heading perception based on vestibular signals. *Nature neuroscience*, 10(8), 1038.
- Hartnagel, D., Taffou, M., & Sandor, P. M. (2017, July). Effects of Short Exposure to a Simulation in a Head-Mounted Device and the Individual Differences Issue. In *International Conference on Human-Computer Interaction* (pp. 9-16). Springer, Cham.
- Hettinger, L. J., & Riccio, G. E. (1992). Visually induced motion sickness in virtual environments. *Presence: Teleoperators & Virtual Environments*, 1(3), 306-310.
- Hickok, G., & Poeppel, D. (2015). Neural basis of speech perception. In *Neurobiology of Language* (pp. 299-310).
- Hillock-Dunn, A., and Wallace, M. T. (2012). Developmental changes in the multisensory temporal binding window persist into adolescence. *Dev. Sci.* 15, 688–696. doi: 10.1111/j.1467-7687.2012.01171.x
- Jaekl, P. M., & Harris, L. R. (2007). *Neuroscience letters*, 417(3), 219-224.
- Jaśkowski, P., Jaroszyk, F., & Hojan-Jeziarska, D. (1990). Temporal-order judgments and reaction time for stimuli of different modalities. *Psychological Research*, 52(1), 35-38.
- Jennings, S., Reid, L. D., Craig, G., & Kruk, R. V. (2004). Time delays in visually coupled systems during flight test and simulation. *Journal of Aircraft*, 41(6), 1327-1335.
- Ji, J., So, R. H. Y., Lor, F., Cheung, R. T., Howarth, P., & Stanney, K. (2005). A search for possible neural pathways leading to visually induced motion sickness.
- Johnson. 2005. Introduction to and review of simulator sickness research. Research Report. United States Army Research Institute for the Behavioral and Social Sciences.
- Kellogg, R. S., Kennedy, R. S., & Graybiel, A. (1964). Motion sickness symptomatology of labyrinthine defective and normal subjects during zero gravity maneuvers. *Aerospace medical research labs wright-patterson ohio*.

- Kandel, E. R., Jessell, T. M., Schwartz, J. H., Siegelbaum, S. A., & Hudspeth, A. J. (2013). *Principles of Neural Science, Fifth Edition*. McGraw-Hill Education.
- Kennedy, R. S., Lane, N., Berbaum, K. and Lilienthal, M. 1993. Simulator sickness questionnaire: An enhanced method for quantifying simulator sickness. *The International Journal of Aviation Psychology*, 3(3):203-220.
- Keshavarz, B., Hettinger, L. J., Vena, D., & Campos, J. L. (2014). Combined effects of auditory and visual cues on the perception of vection. *Experimental Brain Research*, 232(3), 827–836. <https://doi.org/10.1007/s00221-013-3793-9>
- Keshavarz, B., & Hecht, H. (2011). Validating an efficient method to quantify motion sickness. *Human factors*, 53(4), 415-426.
- Keshavarz, B., & Hecht, H. (2012, September). Visually induced motion sickness and presence in videogames: The role of sound. In *Proceedings of the Human Factors and Ergonomics Society Annual Meeting* (Vol. 56, No. 1, pp. 1763-1767). Sage CA: Los Angeles, CA: SAGE Publications.
- Kopinska, A., & Harris, L. R. (2004). Simultaneity constancy. *Perception*, 33(9), 1049-1060.
- Kopinska, A., Harris, L. R., & Lee, I. (2003). Comparing central and peripheral events: compensating for neural processing delays. *Journal of Vision*, 3(9), 751-751.
- Kim, Y. Y., Kim, H. J., Kim, E. N., Ko, H. D., & Kim, H. T. (2005). Characteristic changes in the physiological components of cybersickness. *Psychophysiology*, 42(5), 616-625.
- King A. J. (2005). Multisensory integration: strategies for synchronization. *Curr. Biol.* 15, 339–341 [10.1016/j.cub.2005.04.022](https://doi.org/10.1016/j.cub.2005.04.022)
- Kolasinski, E. M. 1995. Simulator sickness in virtual environments. Technical Report. United States Army Research Institute for Behavioral and Social Sciences.
- Kuffler, S. W. (1953). Discharge patterns and functional organization of mammalian retina. *Journal of neurophysiology*, 16(1), 37-68.
- Macaluso, E. (2006). Multisensory processing in sensory-specific cortical areas. *Neuroscientist*, 12(4), 327–338. <https://doi.org/10.1177/1073858406287908>
- Mahoney JR, Holtzer R, Verghese J (2014) Visual–somatosensory integration and balance: evidence for psychophysical integration differences in aging. *Multisens Res* 27(1):17–42.
- McCauley, M. E., & Sharkey, T. J. (1992). Cybersickness: Perception of self-motion in virtual environments. *Presence: Teleoperators & Virtual Environments*, 1(3), 311-318.

- Molholm, S., Ritter, W., Murray, M. M., Javitt, D. C., Schroeder, C. E., & Foxe, J. J. (2002). Multisensory auditory–visual interactions during early sensory processing in humans: a high-density electrical mapping study. *Cognitive Brain Research*, *14*, 115–128.
- Moss, J. D., Austin, J., Salley, J., Coats, J., Williams, K., & Muth, E. R. (2011). The effects of display delay on simulator sickness. *Displays*, *32*(4), 159-168.
- Moss, J. D., & Muth, E. R. (2011). Characteristics of head-mounted displays and their effects on simulator sickness. *Human factors*, *53*(3), 308-319.
- Munafo, J., Diedrick, M. and Stoffregen, T. A. (2017). The virtual reality head-mounted display Oculus Rift induces motion sickness and is sexist in its effects. *Experimental Brain Research*, *235*(3), 889–901.
- Nalivaiko, E., Davis, S. L., Blackmore, K. L., Vakulin, A. and Nesbitt, K. V. (2015). Cybersickness provoked by head-mounted display affects cutaneous vascular tone, heart rate and reaction time, *Physiology and Behavior* *151*, 583–590.
- Nichols, S., Haldane, C., & Wilson, J. R. (2000). Measurement of presence and its consequences in virtual environments. *International Journal of Human-Computer Studies*, *52*(3), 471-491.
- Nolan, H., Butler, J. S., Whelan, R., Foxe, J. J., Bühlhoff, H. H., & Reilly, R. B. (2012). Neural correlates of oddball detection in self-motion heading: A high-density event-related potential study of vestibular integration. *Experimental Brain Research*, *219*(1), 1–11.
- Oculus, V. R. (2015). *Best practices guide*. Tech. rep., Oculus VR, URL <http://developer.oculus.com/best-practices>.
- Ohyama, S., Nishiike, S., Watanabe, H., Matsuoka, K., Akizuki, H., Takeda, N., & Harada, T. (2007). Autonomic responses during motion sickness induced by virtual reality. *Auris Nasus Larynx*, *34*(3), 303-306.
- Oman, C. M., & Cullen, K. E. (2014). Brainstem processing of vestibular sensory exafference: implications for motion sickness etiology. *Experimental brain research*, *232*(8), 2483-2492.
- Palmisano, S., Mursic, R., & Kim, J. (2017). Vection and cybersickness generated by head-and-display motion in the Oculus Rift. *Displays*, *46*, 1-8.
- Raaen, K., & Kjellmo, I. (2015, September). Measuring Latency in Virtual Reality Systems. In *International Conference on Entertainment Computing* (pp. 457-462). Springer, Cham.
- Regan, M. J., Miller, G. S., Rubin, S. M., & Kogelnik, C. (1999). A real-time low-latency hardware light-field renderer. In *Proceedings of the 26th annual conference on Computer graphics and interactive techniques* (pp. 287-290). ACM Press/Addison-Wesley Publishing Co.

- Rolnick, A., & Lubow, R. E. (1991). Why is the driver rarely motion sick? The role of controllability in motion sickness. *Ergonomics*, 34(7), 867-879.
- Sachgau, C., Chung, W., & Barnett-Cowan, M. (2018). Perceived timing of active head movement at different speeds. *Neuroscience letters*, 687, 253-258.
- Sanders, M. C., Chang, N. Y. N., Hiss, M. M., Uchanski, R. M., & Hullar, T. E. (2011). Temporal binding of auditory and rotational stimuli. *Experimental brain research*, 210(3-4), 539-547.
- Sharples, S., Cobb, S., Moody, A., & Wilson, J. R. (2008). Virtual reality induced symptoms and effects (VRISE): Comparison of head mounted display (HMD), desktop and projection display systems. *Displays*, 29(2), 58-69.
- Stanney, K. M., & Kennedy, R. S. (1997). The psychometrics of cybersickness. *Communications of the ACM*, 40(8), 66-68.
- Stanney, K. M., Mourant, R. R., & Kennedy, R. S. (1998). Human factors issues in virtual environments: A review of the literature. *Presence*, 7(4), 327-351.
- Spence, C., Shore, D. I., & Klein, R. M. (2001). Multisensory prior entry. *Journal of Experimental Psychology: General*, 130(4), 799.
- Sanders, M. C., Chang, N. Y. N., Hiss, M. M., Uchanski, R. M., & Hullar, T. E. (2011). Temporal binding of auditory and rotational stimuli. *Experimental brain research*, 210(3-4), 539-547.
- Setti A, Finnigan S, Sobolewski R, McLaren L, Robertson I, Reilly RB, Kenny RA, Newell FN (2011a) Audiovisual temporal discrimination is less efficient with aging: an event-related potential study. *Neuro Report* 22, 554–558.
- Setti A, Burke KE, Kenny RA, Newell FN (2011b) Is inefficient multisensory processing associated with falls in older people? *Exp Brain Res* 209:375–384.
- Shupak, A., & Gordon, C. R. (2006). Motion sickness: advances in pathogenesis, prediction, prevention, and treatment. *Aviation, space, and environmental medicine*, 77(12), 1213-1223.
- Spence, C., Baddeley, R., Zampini, M., James, R., & Shore, D. I. (2003). Multisensory temporal order judgments: When two locations are better than one. *Perception & psychophysics*, 65(2), 318-328.
- Stanney, K.M., Hale, K.S., Nahmens, I, and Kennedy, R.S., “What to Expect from Immersive Virtual Environment Exposure: Influences of Gender, Body Mass Index, and Past Experience,” *Human Factors*, vol. 45, no. 3, pp. 504-520, Fall 2003.

- Toschi, N., Kim, J., Sclocco, R., Duggento, A., Barbieri, R., Kuo, B., & Napadow, V. (2017). Motion sickness increases functional connectivity between visual motion and nausea-associated brain regions. *Autonomic Neuroscience*, *202*, 108-113.
- Ungerleider, L. G., & Mishkin, M. (1982). Two cortical visual systems. In D. J. Ingle, M. A. Goodale, & R. J. W. Mansfield (Eds.), *Analysis of visual behavior* (pp. 549–586). Cambridge, MA: MIT Press.
- Varghese, J. P., McIlroy, R. E., & Barnett-Cowan, M. (2017). Perturbation-evoked potentials: significance and application in balance control research. *Neuroscience & Biobehavioral Reviews*.
- Webb, N. A., & Griffin, M. J. (2002). Optokinetic stimuli: motion sickness, visual acuity, and eye movements. *Aviation, space, and environmental medicine*, *73*(4), 351-358.
- Weech, S., Moon, J., & Troje, N. F. (2018). Influence of bone-conducted vibration on simulator sickness in virtual reality. *PloS one*, *13*(3), e0194137.
- Wilson, J. R. (1997). Virtual environments and ergonomics: needs and opportunities. *Ergonomics*, *40*(10), 1057-1077.
- Wise, A., & Barnett-Cowan, M. (2018). Perceived simultaneity and temporal order of audiovisual events following concussion. *Frontiers in human neuroscience*, *12*, 139.
- Zampini, M., Shore, D. I., & Spence, C. (2003). Audiovisual temporal order judgments. *Experimental brain research*, *152*(2), 198-210.
- Zu Eulenburg, P., Caspers, S., Roski, C., & Eickhoff, S. B. (2012). Meta-analytical definition and functional connectivity of the human vestibular cortex. *Neuroimage*, *60*(1), 162-169.
- Zion Market Research. Virtual Reality Market Size & Growth 2016. Analysis: Industry Statistics & Forecast Report by 2022; 2018; Avail- able at: <https://www.zionmarketresearch.com/news/virtual-reality- market>. Accessed March 18, 2019.

Appendix A: Motion sickness susceptibility questionnaire (MSSQ)

**MOTION SICKNESS SUSCEPTIBILITY
QUESTIONNAIRE**

This questionnaire is designed to find out how susceptible to motion sickness you are and what sorts of motion are most effective in causing that sickness. Sickness here means feeling queasy or nauseated or actually vomiting.

After some background questions, the questionnaire consists of two sections:

Section A is concerned with your **childhood** experiences of travel and motion sickness, that is, before the age of 12 years.

Section B is concerned with your experiences of travel and motion sickness over the last 10 years.

The correct way to answer each question is explained in the body of the questionnaire. It is important that you answer every question.

Thank you for your help.

Background Questions

1. Please State Your Age _____ Years

2. Please State Your Sex (tick box)

Male	Female
[]	[]
1	2

3. Please State Your Current Occupation _____

4. Do you regard yourself as susceptible to motion sickness? (tick box)

Not at all	Slightly	Moderately	Very much so
[]	[]	[]	[]
0	1	2	3

Section B: Your Experience over the Last 10 Years (approximately).

For each of the following types of transport or entertainment please indicate:

8. Over the **last 10 years**, how often you **Travelled or Experienced** (tick boxes):

	Never	1 to 4 trips	5 to 10 trips	11 or more trips
Cars				
Buses or Coaches				
Trains				
Aircraft				
Small Boats				
Ships, e.g. Channel Ferries				
Swings				
Roundabouts: playgrounds				
Big Dippers, Funfair Rides				

0 1 2 3

9. Over the **last 10 years**, how often you **Felt Sick or Nauseated** (tick boxes):

	Never	Rarely	Sometimes	Frequently	Always
Cars					
Buses or Coaches					
Trains					
Aircraft					
Small Boats					
Ships, e.g. Channel Ferries					
Swings					
Roundabouts: playgrounds					
Big Dippers, Funfair Rides					

0 1 2 3 4

10. Over the **last 10 years**, how often you **Vomited** (tick boxes):

	Never	Rarely	Sometimes	Frequently	Always
Cars					
Buses or Coaches					
Trains					
Aircraft					
Small Boats					
Ships, e.g. Channel Ferries					
Swings					
Roundabouts: playgrounds					
Big Dippers, Funfair Rides					

0 1 2 3 4

Appendix B: Previous gaming questionnaire

Subject ID code: _____

Prior Gaming Experience Questionnaire:

Note: In this questionnaire, gaming refers to the action of engaging in any type of video game, could be on the computer, on a phone, on a television or any other display technology.

1. How often do you play video games?
- a. Never b. Daily c. weekly d. Monthly e. Yearly

Note: If you chose option a for question 1, then you are not required to answer the rest of this questionnaire

2. How long does one gaming session last on average?
- a. <30 mins b. 1 hour c. > 1 hour d. >3 hours

3. What types of video games do you play?
- a. First person shooter
b. First person driver/pilot
c. Sports
d. Arcade
e. Adventures (eg. Minecraft or Game of Thrones)
f. Other: _____

4. Have you had previous exposure to virtual reality technologies?
- a. Yes b. No

5. If you answered yes to question 4, how would you rate your exposure to virtual reality?
- a. Very rare (only once or twice)
b. Moderate (few times a month)
c. Often (eg., weekly)
d. Very often (eg., daily)

Appendix C: Simulator sickness questionnaire (SSQ)

No _____

Date _____

SIMULATOR SICKNESS QUESTIONNAIRE

Kennedy, Lane, Berbaum, & Lilienthal (1993)***

Instructions : Circle how much each symptom below is affecting you right now.

1. General discomfort	<u>None</u>	<u>Slight</u>	<u>Moderate</u>	<u>Severe</u>
2. Fatigue	<u>None</u>	<u>Slight</u>	<u>Moderate</u>	<u>Severe</u>
3. Headache	<u>None</u>	<u>Slight</u>	<u>Moderate</u>	<u>Severe</u>
4. Eye strain	<u>None</u>	<u>Slight</u>	<u>Moderate</u>	<u>Severe</u>
5. Difficulty focusing	<u>None</u>	<u>Slight</u>	<u>Moderate</u>	<u>Severe</u>
6. Salivation increasing	<u>None</u>	<u>Slight</u>	<u>Moderate</u>	<u>Severe</u>
7. Sweating	<u>None</u>	<u>Slight</u>	<u>Moderate</u>	<u>Severe</u>
8. Nausea	<u>None</u>	<u>Slight</u>	<u>Moderate</u>	<u>Severe</u>
9. Difficulty concentrating	<u>None</u>	<u>Slight</u>	<u>Moderate</u>	<u>Severe</u>
10. « Fullness of the Head »	<u>None</u>	<u>Slight</u>	<u>Moderate</u>	<u>Severe</u>
11. Blurred vision	<u>None</u>	<u>Slight</u>	<u>Moderate</u>	<u>Severe</u>
12. Dizziness with eyes open	<u>None</u>	<u>Slight</u>	<u>Moderate</u>	<u>Severe</u>
13. Dizziness with eyes closed	<u>None</u>	<u>Slight</u>	<u>Moderate</u>	<u>Severe</u>
14. *Vertigo	<u>None</u>	<u>Slight</u>	<u>Moderate</u>	<u>Severe</u>
15. **Stomach awareness	<u>None</u>	<u>Slight</u>	<u>Moderate</u>	<u>Severe</u>
16. Burping	<u>None</u>	<u>Slight</u>	<u>Moderate</u>	<u>Severe</u>

* Vertigo is experienced as loss of orientation with respect to vertical upright.

** Stomach awareness is usually used to indicate a feeling of discomfort which is just short of nausea.

Last version : March 2013

***Original version : Kennedy, R.S., Lane, N.E., Berbaum, K.S., & Lilienthal, M.G. (1993). Simulator Sickness Questionnaire: An enhanced method for quantifying simulator sickness. *International Journal of Aviation Psychology*, 3(3), 203-220.

Appendix D : Correlations of AV and AAHM TBW and PSS with FC SSQ scores

Due to the insignificant relationships between the TOJ parameters (TBW and PSS) and First Contact SSQ scores, these correlations were excluded from the results section and are hence depicted in this appendix.

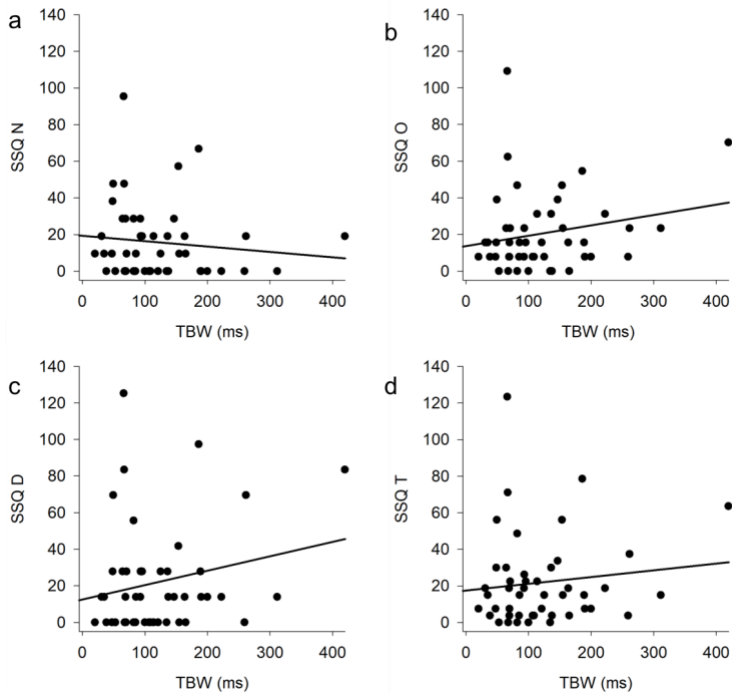

Figure A1: AV TBW vs First Contact SSQ scores

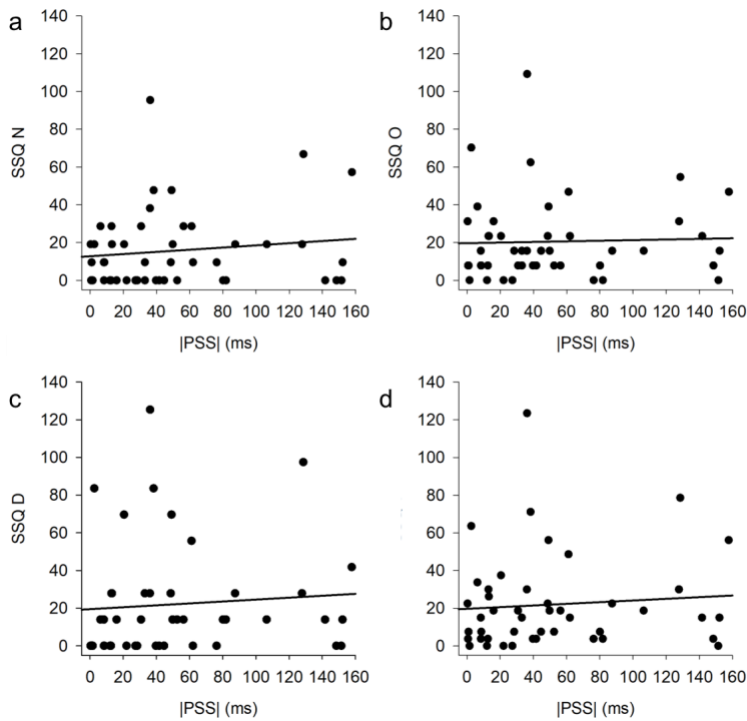

Figure A2: AV PSS vs First Contact SSQ scores

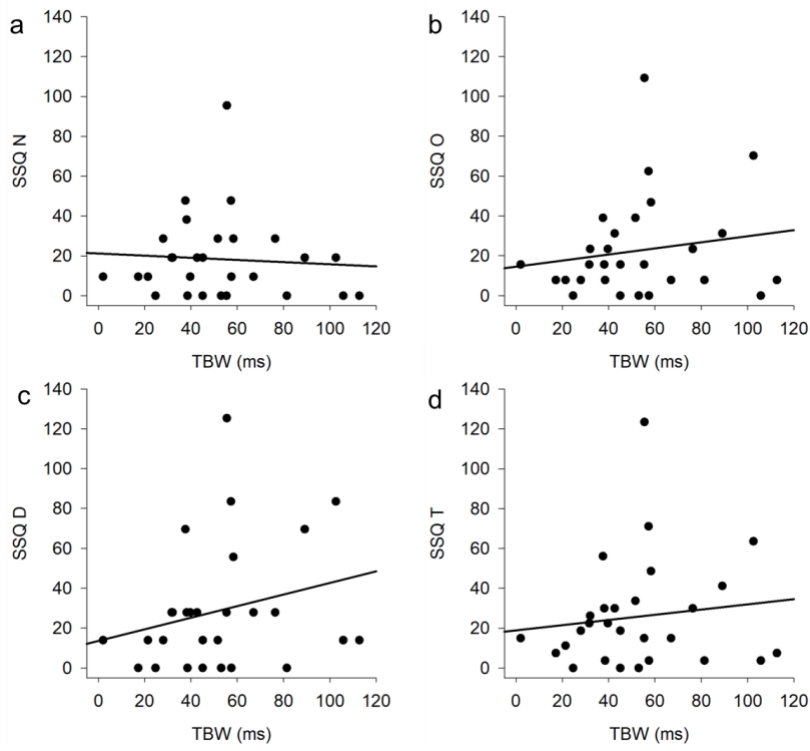

Figure A3: AAHM TBW vs First Contact SSQ scores

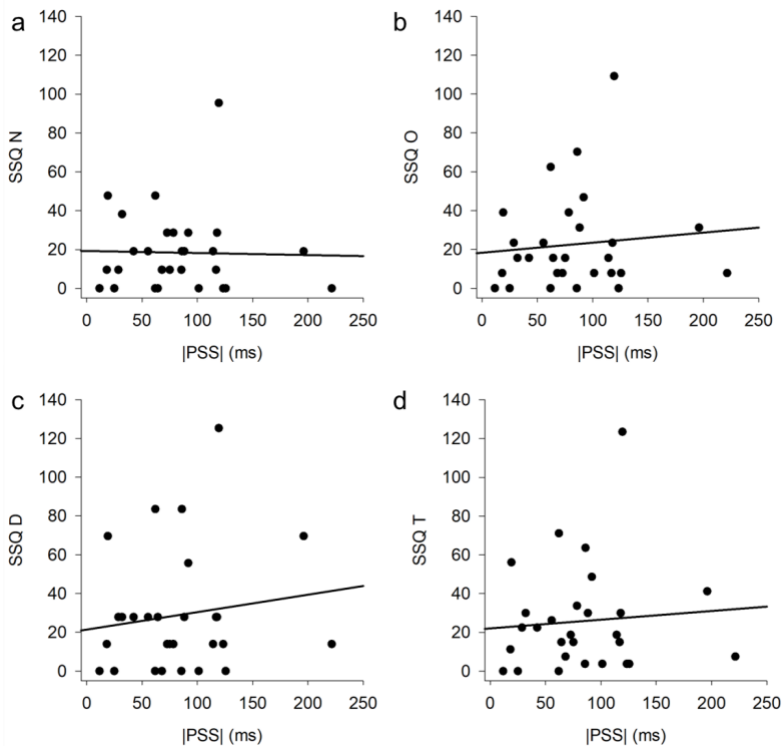

Figure A4: AV TBW vs First Contact SSQ scores