

Mediation:

Resonating between the Organic and Inorganic

by

Muhammad Tahir Pervaiz

A thesis

presented to the University Of Waterloo

in fulfilment of the

thesis requirement for the degree of

Master of Architecture

Waterloo, Ontario, Canada, 2020

© Muhammad Tahir Pervaiz 2020

AUTHOR'S DECLARATION

This thesis consists of material all of which I authored or co-authored: see Statement of Contributions included in the thesis. This is a true copy of the thesis, including any required final revisions, as accepted by my examiners.

I understand that my thesis may be made electronically available to the public.

STATEMENT OF CONTRIBUTIONS

Muhammad Tahir Pervaiz was the sole author of Chapter 1, 2, 3, 5, 6, 7 and which were written under the supervision of Professor Philip Beesley and were not written for publication.

Research presented in Chapter 2 and 3:

This research was conducted at the University of Waterloo by Muhammad Tahir Pervaiz under the supervision of Professor Philip Beesley and Professor Val Rynnimeri. These chapters were inspired by the work of Jekabs Zvilna after I investigated and documented his work and collected archival data available in the Waterloo Architecture Facility.

Chapter 4 was informed by the form language libraries at the Living Architecture Systems Group (LASG) under the supervision of Professor Philip Beesley, which I developed, designed and prototyped for a testbed installation in Cambridge, Ontario.

ABSTRACT

This thesis emerges from the desire of unity between the intuitive and empirical expressions of nature. It argues for a greater understanding of 'patterns' inherent in nature and advocates for the need to see things as a whole, rendering the world as a continuum of interconnected, interdependent fields. In doing so, the work seeks connections by deploying the element of 'play' and the search for 'process' by developing organic constructions and apply those relationships to inorganic crystalline geometries which are linked through spatial, chemical, and material, and topological relationships. The project carries with it a personal journey which resonates between intuitive play and rational modular understanding. The synthesis of the research consists of three parts: the first, situates itself in the contemplative, intuitive aesthetics of Jekabs Zvilna, created by 'domesticating' nature's forces into an ensemble of two-dimensional 'organic' patterns. The second explores crystalline geometries for relationships described in nature, and as a result produce generative modular constructions. The third part appropriates the form languages at the Living Architecture Systems Group that allow a distillation of the organic and inorganic into a singular whole. They offer an alchemical transmutation – a synthesis of polarities that serve as a testbed for evolving geometries; that apply to mediation, interpenetration and integration of the natural and the technological systems.

While there are notable differences in the works presented, there is significant common ground in their representation of form generative processes in nature. As the work offers insight into the emerging relationships between nature and technology, it invites us to reconcile the disparate aspects of arts and sciences and the practice of architecture. For this synthesis, the research resonates between poetics and ethics while speculating on the 'mediation' between the shattered demarcations: the animate and inanimate; the being and becoming; the essence and substance; and the natural and the technological. It engages past situations wherein artists, architects, art and architecture, were integral and largely inseparable creating context from Bruno Taut, Moholy-Nagy, and Jekabs Zvilna. The theoretical basis is situated in both architectural and philosophical traditions, recognizing mediation as the order of balancing the contraries, proposing the integration of systems and a new unified understanding of the world; a living world perhaps.

ACKNOWLEDGEMENTS

I owe a great debt of gratitude to my Supervisor, **Philip Beesley**, whose constant guidance and support has been invaluable. This work would not have expanded without his breadth of knowledge and passion for this field. Thank you for being Philip Beesley.

My sincerest thanks to **Val Rynnimeri** for his continuous source of encouragement, support, and consideration for all this time. It has been an absolute pleasure to have been his student throughout my time in school.

I owe huge thanks to **Tracey Winton**, for guiding me and leading me to literary traditions I wouldn't have sought otherwise. Thank you for listening to my ideas.

To the **Living Architecture Systems Group**, for inspiring me and providing me the ground and tools to test my ideas. For truly being a womb for new interdisciplinary research.

I also wish to thank **Jekabs Zvilna**, for being a master of his time – going through his work has been nothing less than an adventure for me. Thanks to **Kristjan Viger**, for sharing his grandfather's archives and taking his valuable time for interviews.

Thank you to the administration, **Emily Stafford** and **Nicole Gunther** for always being patient and supportive.

To all friends who have imparted on me their wisdom, and importantly for making life fun at school.

Ama Jan, cannot be thanked enough for her sacrifices and support; she was as great as she has ever been. **Amir** and **Sumbal**, thank you for being the best brother and Sister. My **life** partner, I am so grateful to have you. Thank you!

For Abu.

TABLE OF CONTENTS

<i>iii</i>	Author's Declaration
<i>iv</i>	Statement of Contributions
<i>v</i>	Abstract
<i>vi</i>	Acknowledgements
<i>ix</i>	List of Figures
<i>1</i>	1. Introduction <i>“One is all; all is one”</i>
<i>15</i>	2. Organic Language <i>the poetics of forces</i>
<i>57</i>	3. Dynamic Modularity <i>building-blocks</i>
<i>71</i>	4. The In-between <i>from unit to body</i>
<i>119</i>	5. Mediation <i>intuition & rational</i>
<i>124</i>	6. The state of Influx <i>towards unity</i>
<i>129</i>	7. Intersections <i>coming together</i>
<i>136</i>	Discussion
<i>138</i>	Bibliography

LIST OF FIGURES

Figures 1	4	Froebel's Gift Set <i>Source: Frobeldecade.com</i>
Figures 2	4	A metaphysical educational toy demonstrating the synthesis of the living and the inanimate. <i>Source: Friedrich Froebels Gifts, by Eugene F. Provenzo, JR.</i>
Figures 3	5	Synthesis I: The Organic Poetics <i>Source: By author</i>
Figures 4	6	Synthesis II: Dynamic Modularity <i>Source: By author</i>
Figures 5	8	Synthesis III: Towards Organicity <i>Source: By author</i>
Figures 6	9	Zvilna Block Tessellation, from the archives at the University of Waterloo <i>Source: Photograph by author</i>
Figures 7	9	Zvilna Block Tessellation, from the archives at the University of Waterloo <i>Source: Photograph by author</i>
Figures 8	10	Block Model, from the archives at the University of Waterloo <i>Source: Photograph by author</i>
Figures 9	10	Block Model, from the archives at the University of Waterloo <i>Source: Photograph by author</i>
Figures 10	10	Labyrinth Spiral of Zvilna (late 1970's) <i>Source: Scanned by the author</i>
Figures 11	11	Zvilna Block Model, from the archives at the University of Waterloo <i>Source: Photograph by author</i>
Figures 12	12	Zvilna Model Detail, from the archives at the University of Waterloo <i>Source: Photograph by author</i>
Figures 13	13	Zvilna Block Model, from the archives at the University of Waterloo <i>Source: Photograph by author</i>
Figures 14	14	Zvilna Block Model, from the archives at the University of Waterloo <i>Source: Photograph by author</i>
Figures 15	18	Be... (1 of 10) Image Series <i>Source: By author</i>
Figures 16	22	Be... (2 of 10) Image Series <i>Source: By author</i>
Figures 17	26	Be... (3 of 10) Image Series <i>Source: By author</i>

Figures 18	30	Be... (4 of 10) Image Series <i>Source: By author</i>
Figures 19	34	Be... (5 of 10) Image Series <i>Source: By author</i>
Figures 20	38	Be... (6 of 10) Image Series <i>Source: By author</i>
Figures 21	41	Be... (7 of 10) Image Series <i>Source: By author</i>
Figures 22	42	Be... (8 of 10) Image Series <i>Source: By author</i>
Figures 23	46	Be... (9 of 10) Image Series <i>Source: By author</i>
Figures 24	50	Be... (10 of 10) Image Series <i>Source: By author</i>
Figures 25	57	Helix formation from a Zvilna Module <i>Source: Scanned by author, from the archives at the University of Waterloo</i>
Figures 26	59	Form Generative Module: Type A <i>Source: By author</i>
Figures 27	60	Form Generative Module: Type B <i>Source: By author</i>
Figures 28	63	Form generation - Module Type A <i>Source: By author</i>
Figures 29	64	Form generation - Module Type A <i>Source: By author</i>
Figures 30	67	Form generation - Module Type A <i>Source: By author</i>
Figures 31	68	Form generation - Module Type B <i>Source: By author</i>
Figures 32	74	Surging Cloud Necklaces in Space <i>Source: LASG & author</i>
Figures 33	75	The Inorganic Soil - Hexagonal Geometry <i>Source: By author, base data from LASG</i>
Figures 34	76	Organic Emergence <i>Source: By author, base data from LASG</i>
Figures 35	79	Component - Arms <i>Source: By author, base data from LASG</i>
Figures 36	79	Component - Center plate <i>Source: By author, base data from LASG</i>

Figures 37	79	Component - X plate <i>Source: By author, base data from LASG</i>
Figures 38	79	Section Detail <i>Source: By author, base data from LASG</i>
Figures 39	79	Component - Fronds <i>Source: By author, base data from LASG</i>
Figures 40	80	Sargasso Spiral <i>Source: Co-authored by LASG & Author</i>
Figures 41	87	Unfolded Section of the 1200 mm Spiral <i>Source: By author</i>
Figures 42	87	Sargasso Spiral Plan: Spiral inscribed in a circle of diameter 1200mm <i>Source: By author</i>
Figures 43	88	Arms - (2mm PETG) 1200 mm Spiral <i>Source: By author</i>
Figures 44	88	Center plate (3 mm Acrylic) - 1200 mm Spiral <i>Source: By author</i>
Figures 45	88	X-plates (3 mm Acrylic) 1200 mm Spiral <i>Source: By author</i>
Figures 46	88	Section Detail - 1200 mm Spiral <i>Source: By author</i>
Figures 47	88	Fronds (0.05 mm Mylar) - 1200 mm Spiral <i>Source: By author</i>
Figures 48	91	Unfolded Section of the 900 mm Spiral <i>Source: By author</i>
Figures 49	91	Sargasso Spiral Plan: Spiral inscribed in a circle of diameter 900 mm <i>Source: By author</i>
Figures 50	92	Arms (2mm PETG) - 900 mm Spiral <i>Source: By author</i>
Figures 51	92	Center plate (3 mm Acrylic) - 900 mm Spiral <i>Source: By author</i>
Figures 52	92	X-plates (3 mm Acrylic) - 900 mm Spiral <i>Source: By author</i>
Figures 53	92	Section Detail - 900 mm Spiral <i>Source: By author</i>
Figures 54	92	Fronds (0.05 mm Mylar) - 900 mm Spiral <i>Source: By author</i>
Figures 55	95	Unfolded Plan for the 600 mm Spiral <i>Source: By author</i>

Figures 56	95	Sargasso Spiral Plan: Spiral inscribed in a circle of diameter 600 mm <i>Source: By author</i>
Figures 57	96	Arms (2mm PETG) - 600 mm Spiral <i>Source: By author</i>
Figures 58	96	Center plate (3 mm Acrylic) - 600 mm Spiral <i>Source: By author</i>
Figures 59	96	X-plates (3 mm Acrylic) - 600 mm Spiral <i>Source: By author</i>
Figures 60	96	Section Detail - 600 mm Spiral <i>Source: By author</i>
Figures 61	96	Fronds (0.05 mm Mylar) - 600 mm Spiral <i>Source: By author</i>
Figures 62	97	Unfolded Plan for the 300 mm Spiral <i>Source: By author</i>
Figures 63	97	Sargasso Spiral Plan: Spiral inscribed in a circle of diameter 300 mm <i>Source: By author</i>
Figures 64	98	Arms (2mm PETG) - 300 mm Spiral <i>Source: By author</i>
Figures 65	98	Center plate (3 mm Acrylic) - 300 mm Spiral <i>Source: By author</i>
Figures 66	98	X-plates (3 mm Acrylic) - 300 mm Spiral <i>Source: By author</i>
Figures 67	98	Section Detail - 300 mm Spiral <i>Source: By author</i>
Figures 68	98	Fronds (0.05 mm Mylar) - 300 mm Spiral <i>Source: By author</i>
Figures 69	99	Tri Spiral Connectors - forming relations between 'Hex' Spirals <i>Source: By author</i>
Figures 70	103	Periodic occurrence of different sizes of spirals <i>Source: By author</i>
Figures 71	105	Cloud formation of the spirals <i>Source: By author</i>
Figures 72	107	Quasi Periodicity <i>Source: By author</i>
Figures 73	108	Interstitial Relations <i>Source: By author</i>
Figures 74	110	Sargasso Cloud Masterplan <i>Source: By author</i>

- Figures 75** 114 Undulating Membrane Structure of The Cloud
Source: LASG & author
- Figures 76** 116 Meander: Cloud, Tapestry Hall, Cambridge, CA
Source: LASG
- Figures 77** 120 Hermann Finsterlin, "Interior"
Source: The Interpretation of the Glass Dream-Expressionist Architecture and the History of the Crystal Metaphor
- Figures 78** 120 Wassili Luckhardt (Zacken), "Cult Building," interior.
Source: The Crystal Chain Letters: Architectural Fantasies by Bruno Taut and his Circle
- Figures 79** 121 Bruno Taut's Glass Pavilion House at the Cologne Deutscher Werkbund Exhibition 1914
Source: <https://www.apollo-magazine.com/without-a-palace-of-glass-life-is-a-burdensome-task-paul-scheerbarts-utopian-fantasies/>
- Figures 80** 121 Interior of the Glass Pavilion by Bruno Taut
Source: <https://www.1843magazine.com/design/i-wish-id-done-that/eric-parry-on-the-glashaus>
- Figures 81** 126 Three Portals from the Hypnerotomachia Poliphili
Source: Division of Rare and Manuscript Collections, Cornell University Library
- Figures 82** 127 Quantity and Homogeneity
Source: By author.
- Figures 83** 128 Direction as a Qualitative aspect of space
Source: By author.
- Figures 84** 130 Kinetic Constructive System by Laszlo Moholy-Nagy
Source: Grupa o.k.
- Figures 85** 131 Detail of papmac, 1943, showing the dramatic shadow effects generated by bubbles and ripples in plexiglas.
Source: https://www.vice.com/en_us/article/3d5w9j/moholy-nagy-chemistry-experiments-conservation-lab
- Figures 86** 132 Boote am Pont Transbordeur. Marseille. 1929.
Source: Photo by Moholy-Nagy
- Figures 87** 133 László Moholy-Nagy (1895-1946), Photomontage
Source: The Face of the Century: Photographs from a Private Collection on 2 April 2019 at Christie's in New York
- Figures 88** 134 Frederick Kiesler, study for an "Endless House", New York 1959
Source: <https://archinect.com/features/article/14999936/friedrich-kiesler-architect-artist-visionary-at-martin-gropius-bau-tells-rather-than-shows-the-architect-s-oeuvre>
- Figures 89** 135 Frederick Kiesler, model for an "Endless House," wire frame structure, New York 1959
Source: <https://archinect.com/features/article/14999936/friedrich-kiesler-architect-artist-visionary-at-martin-gropius-bau-tells-rather-than-shows-the-architect-s-oeuvre>



The Intermediate Strata

A study into the works of Jekabs Zvilna & Living Architecture Systems Group

1. Introduction | *“One is all; all is one”*

Our ability to acquire knowledge from nature has always been an enigma. The modern man's understanding of nature is most often based on pure empiricism and gets translated into a rational expression, with the central thought that anything can be explained with the help of pure logic, mathematics, or science. In this thesis, I argue that the role of intuition in the concepts and ideas is necessary for establishing the natural systems and has the ability to transcend mere experience. In doing so, the work seeks to bridge and 'connect' the two contraries inherent in the nature of existence and celebrates 'correspondence' between the two, by means of mediation.

1.1 On Mediation

The term mediation identifies by emphasizing on treading the middle way between spirit and matter, between direct experience and the manifold expressions of forms that exist in nature. This work intends to develop an understanding of 'mediation' of both essence and substance that leads to a unitary order. 'Mediation' or middle by no means represents an average; on the contrary, it represents 'harmonious knitting,' an interweaving of relationships, presenting a psychophysiological image of the material and spiritual; the technological and the natural world. This study presents concepts on wholeness and integration as a way to reconcile the empirical and intuitive systems.

The work develops mediation as a way to allow intuitive play and geometry as a rational tool to investigate natural dynamism. It is the middle of the two polarities, the intuitive and the rational, that initiate a matrix of meaning and relations that leads to the conception of a rather 'natural' image than a mere 'material' image. Through mediation, man is no longer only deploying science or technology for testing of hypothesis, but it lets man manifest his courage and audacity through play and let forms flow through his hands, merge and repeat as he becomes one in the manifestation of the one. The idea of mediation calls for a synthetic representation of nature, contrary to the stratigraphic image, transforming the role of architect/designer to an active participant. It allows us not entirely to rely on the

1 Plato. 1888. In *The Timaeus of Plato*, by R.D Archer-Hind, 190-194. London: Macmillan and Co. and New York.

2 Stewart, Ian. 2018. "Encyclopedia Britannica." Number symbolism. January 2018. Accessed May 24, 2020. <https://www.britannica.com/topic/number-symbolism>.

3 Concinnitas (Latin) is from 'concinnus' which means 'skillfully put together or joined'. It refers to a harmonious 'fitting' of the parts. Caroline van Eck, Goethe and Albert: Organic Unity in Nature and Architecture. Saskatoon: University of Saskatchewan, 1995), 24.

rational faculties of the mind but also to put faith in the process of form creation and to allow play, opening up a new epoch of celebrating life while creating it.

In order to elaborate and synthesize the rational and intuitive landscapes, it is necessary to adopt an approach that is capable of encompassing the 'processes' of form creation. In this respect, the work develops a wide variety of form languages that are linked through a key premise of play, evoking 'interrelations', overlapping, and intertwining dynamics in nature, while deploying crystalline constructions of polyhedrons, that allow geometric synthesis of the inherent polarities in nature. The construction of these form languages signal a need to address both the role of geometry and play integral for the constitution of the form, which will follow with an overview of the form languages presented in this work.

1.2 Framing the Discourse of Geometry

The conception of nature is not entirely mathematical but also spiritual. In response to the translations of nature, there is a wide variety of paradigms that have appropriated and evolved the domains of geometry. Parallel to the rational and intuitive discourse, the geometric discourse, which usually relates to the rational faculty of man, has often struggled between symbolic and profane geometry. The word Geometry comes from '*ge*' meaning earth and '*metria*' as measurement, meaning the measuring of the earth or the science of measurement. The ordering of the cosmos or the divine activity has always been considered to be assimilated to geometry. In *Timaeus*, Plato postulated a cosmos made up of regular polyhedrons, geometric figures that ultimately presented triangles as the atoms of his proposed systems. The matter was categorized into the pyramid (representing the form of fire), the octahedron (the form of air), the icosahedron (the form of water) and the cube (the form of the earth), all forms corresponding to the forms of matter. The fifth form was the dodecahedron, the form nearest to the sphere, which Plato believed God used to embellish the universe with signs.¹ The Pythagoreans made significant contributions by explaining the universe through numbers and magnitude. The world was now presented as parts related to the whole, thus introducing the idea of 'proportion'. Here the numbers were associated with mystical qualities such as the number '1' denoted unity and the number '2' presented basic dualities:

male and female.² Leon Battista Alberti built further on the divine ratios and proportions by emphasizing on the harmonious knitting, which he referred to as Concinnitas³. He wrote in his book the *De re aedificatoria* (On the Art of Building):

"Just as the head, foot, and indeed any member must correspond to each other and to all the rest of the body of an animal, so in a building, and especially in a temple, the parts of the whole body must be so composed that they all correspond one to another, and anyone, taken individually, may provide the dimensions of all the rest."⁴

The idea of meaning in geometric representation became less symbolic and more absolute by the Cartesian rationalism, which reduced the entire notion of spirit to the idea of 'extension,' bringing the science of pure quantity. However, Einstein's theory of relativity in 1915, brought back the idea of dynamism of space; a heterogeneous image rendering the world as a construct of probabilities and not certainties, with time as the fourth dimension. What relativity further brought was permitting various viewpoints at once (an aspect of cubism), leading to forms that broke the rules of unity or compositional unity. Today we live in the age of technology where all kinds of forms are possible, which mostly rely on reductive working methods that resonate among the fractal, parametric and computer-generated formulations. While geometry is an essential tool for mimicking, translating or understanding the substantial nature of things, there is more to geometry that can capture the essential nature of the universe, and that can be made possible with the innate faculty of man; play.

1.3 Introducing Play

To create forms that embody both intuition and rational, essence and substance, there must be something about the process of the form itself. Man often termed as *Homo Sapien* also deserves to be equally associated with the term *Homo Luden*; man the player. Play is more than a mere physiological phenomenon or a psychological reflex. It goes beyond the confines of purely physical or purely biological activity. It is a significant function-that is to say, there is some sense to it. In play there is something "at play" which transcends the immediate needs of life and imparts meaning to the action. All play means something.⁵ Play is not to be understood as purely arbitrary or foolish rather it must be taken as something that exceeds the sensible, imparting to form 'relationships' that might first not be discovered by the intellect or by the geometrician. It lies in the domain of an irrational, into the intuitive and unknown fields of imagination that differentiates man from the rest of the species. Play is the state where man immerses into the process, observing forms, projecting expressions that sometimes his rational mind would not allow, leading to poetic manifestations. Play is at the heart of learning from nature and

4 Padovan, Richard. 1999. "Humanism and architecture." In *Proportion: science, philosophy, architecture*, by Richard Padovan, 215. London: E & FN Spon.

5 Huizinga, J. 1949. "Homo Ludens: A study of the Play-Element in Culture." In *Homo Ludens: A study of the Play-Element in Culture*, by J. Huizinga. London: Routledge & Kegan Paul.



Figure.1:Froebel's Gift Set
Building blocks for understanding
spatial relationships and the world
around

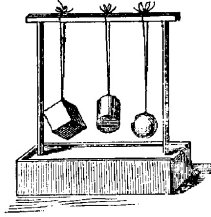

Figure.2:A metaphysical educational
toy demonstrating the synthesis
of the living and the inanimate.

6 Kindergarten means a garden of children, and Froebel, the inventor of it, or rather, as he would prefer to express it, the discoverer of the method of Nature, meant to symbolize by the name the spirit and plan of treatment. How does the gardener treat his plants? He studies their individual natures, and puts them into such circumstances of soil and atmosphere as enable them to grow, flower, and bring forth fruit,—also to renew their manifestation year after year. [Source: Mann, Horace, and Elizabeth P. Peabody, "Moral Culture of Infancy and Kindergarten Guide," Boston, 1863]

7 Rogers, Wally, 2016. Close-Up View of Froebel's Kindergarten with Frank Lloyd Wright at the Drawing Table. Xlibris Corporation.

offers significant ground in revealing the underlying principles inherent in nature. While mathematical and rationality is important to understand nature's dynamics, play is the key principle that can generate 'organicity' in the development of forms. In this work, Mediation presents the deployment of the intuitive play and the rational geometric constructions to develop forms that embody the synthesis of the two polarities. The work aims to embody the spiritual by virtue of play and the rational through the crystalline geometries. Throughout history geometry has contributed to the understanding of the higher cosmos. The attempt to construct form languages with crystalline geometries coupled with an element of play can allow the form and the maker to put faith in the process of creation and produce forms that generate and evolve into inexhaustible expressions, capturing the very essence of nature.

Form languages offer both an exploration and a meditation for seeking relations among complex concepts and ideas. The methodology of 'play' finds home in the systems of Friedrich Froebel, who evoked the idea of 'organic thinking' in developing a pedagogy which he called 'kindergarten,'⁶ encompassing adapting and learning from nature. His approach involved incorporating aspects of play, symbol and relationship between the macrocosm and the microcosm, and the natural organism as a way of understanding the universe. Froebel used a system of 'gifts' (building blocks, sticks, strings) as a way of forming relationships between parts, setting a part-whole dynamic to teach children about nature and its methods of construction. These models, mostly crystalline in their form provided imagery of simple geometric symmetries to represent the planetary systems.

"Gifts. And - "gifts" they were. Along with the gifts was the system, as a basis for design and the elementary geometry behind all natural birth of Form."⁷

Just as the models and 'gifts' were used to physically express higher spiritual ideas, the illustrations in the following research share Froebel's agenda of using abstract models to inform complex systems. What follows is an insight into the generative processes and visualizations of interrelations that may potentially connect the amorphous organic geometries to crystalline geometries – leading to a unified worldview.

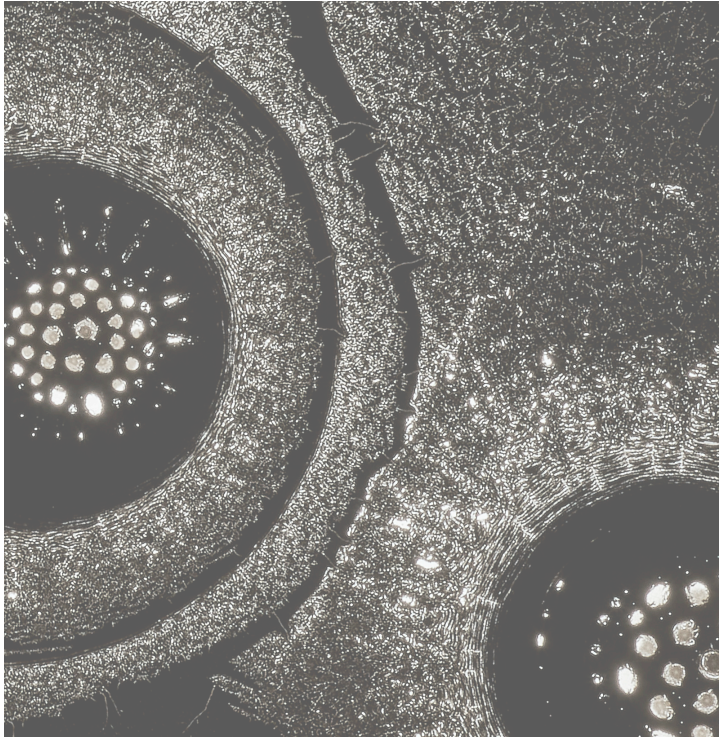

Figure.3:Synthesis I: The Organic Poetics

8 The Organic Poetics: A total of 47 studies were conducted during the course of this research. Only 12 of the 47 images are presented in this publication for reasons of precision and consistency of the development of form. The presented images in this body of work are among the consistent formations that were tested and recreated and do not reflect mere coincidences.

1.4 Research Synthesis: Form Languages

The thesis culminates into producing three form languages, which by means of their expressions, can be termed as art creations as much as scientific creations. To begin, the research develops the first body of work⁸ (Figure 3) titled 'Be...' which engulfs within itself an experience of creation, resulting from a play of carbon and oil; a reflection of a cosmic harmony while reflecting on nature's dynamism. The processes of this series are informed by the techniques of Jekabs Zvilna, a Latvian architect and an artist.

The organic tessellations offer an awareness of forces and relationships that exist in nature and are all around, shaping forms; shaping us in the process. The images present a discourse on organic reflections where the 'chemical' processes mystically identify with the psychical processes of the being, informed by play; a human image, a human force of creation. The organic constructions present dynamic patterns and symmetries tessellating out from the chemical reactions of

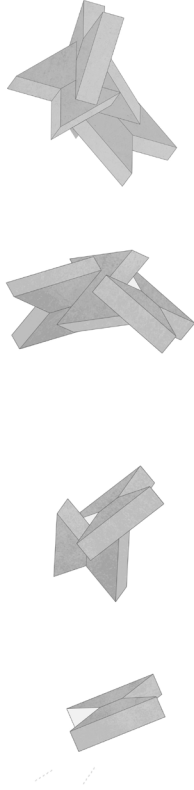

Figure.4: Synthesis II: Dynamic Modularity

⁹ Dynamic Modularity: A total of 5 models from the Zvilna archives were selected, documented and deconstructed for the purpose of this research. This chapter (Page, 5-10) will present a part of documentation and works of Zvilna that have informed this research.

the oil and the carbon and the spatial properties of the system. The form language demonstrates that all variables involved in the experiments are interconnected, and produce a theatre of manifestation of relations: Speed of rotation of the glass plate with volatility of the solvent; tilt of the plate with the viscosity of the solvent; and motion of the system with evaporation of the solvent. All properties exist in a dynamic web of 'relations' and any change in each of those variables can result in the 'reorganization' of the form. Therefore, exhibiting that the 'organic' is not merely an imagery of amorphous free-flowing forms but a distillation of the underlying dynamic web: a 'set of relations' between each of those chemical and spatial properties. The organic forms present themselves as constant 'reorganizing' and mutating, subjected to the changing spatial and chemical dynamics.

Building on the set of relations, the next study takes the existing lattice structures of Zvilna to examine the relationship dynamics in crystalline polyhedrons. Zvilna immersed himself in finding the 'One' from the many and many from the one. In doing so, he came up with the idea of developing generative crystalline geometries built from a single unit – a wedge-shaped polyhedron, which he called the 'Zvilna Block'. The second body of work⁹ (Figure 4) puts nature into investigation, but this time abstracts it into geometric forms (polyhedrons) with the assumption that underlying principles of crystals and organisms are alike. Can the crystalline geometries exhibit similar 'relations' as the organic forms? This typology is developed with pure independent geometric shapes (polyhedrons) that fuse into larger complex compositions that reflect 'hierarchical progression'. It takes the geometric relationships of symmetry, rotation, and translation to develop generative assemblies of polyhedrons that tessellate and gyrate in space forming relations through play and spatial connections. Deconstructing the Zvilna polyhedrons presents that each module carries in its shape the 'potential' to form relations. However, the potential alone do not account for the 'organicity', the reason being that organicity dwells not in the individual objects/modules but in the 'relations' they make with each other. The surfaces, edges and vertices/points of the polyhedron act as the bonding sites enabling diverse relations in the process of construction. The aggregates manifest growth as consistent 'type' of connections are followed with periodic rotations and spatial translations, yielding a continuous generative form. Here the 'set of relations' identify themselves in the 'embodied' potential of the module; its 'shape' and

its spatial properties (rotation and gyration), both factors which directly govern the dynamism or 'coming-together' of the generative form, culminating into three-dimensional lattices and spirals structures.

In response to the first two experiments where relations manifest in the two and three-dimensional form, the third body of work¹⁰ (Figure 5) ultimately leads to the synthesis of the organic and the inorganic: the recursive form language of Sargasso, which crystallize out from a manifold of relations. It presents a play of imitation, a simulacrum that captures nature's dynamics in its continuous chain of imaginary polygons. It breaks the rigid geometry of the polyhedra into flexible lace-like meshwork that fills and billows in hyperbolic shell-like structures surrounding the space. Here the relations in space manifest as a seamless whole by interlinking skeletal membrane components that emerge from a hexagonal diagrid textile structure tessellating in space. The transparent crystal nature of the skeletal arms host the projection of vine-like tentacles that radiate out normal to the curvature of the geometry, dissipating out into the spatial continuum. The relations not only manifest in the robust components but also in the interim relations between three-ways (Equilateral Triangle) and six-ways (Hexagon) that create a continuous fabric.

The crystalline geometry transmutes to an organic system with the configurations of its assemblies, as each part forms 'relations' with the other parts/components intrinsically. The entire spiral becomes a manifestation of the 'relations' between parts, as each component develops out of a 'relative' dynamism forming filamentary projections that mutate, adapt and form junctions.

Taking further the 'set of relations' investigated in the previous studies incorporating chemical, spatial and dynamic material exchanges, this study further looks into the topological relations and periodic occurrences between repetitive arrays of varying sizes. The size variants present bionic stages of growth, a lexicon that is informed by incremental and evolutionary development of the components and the spirals as a whole. With varying sizes of the spiral bodies, the extrinsic manifestation of the 'relations' occur due to two factors: one, relationships between the spirals; and two, relationships formulated due to varying 'periods.' The components demonstrate adaptation and mutation as a way of accommodating 'periodic' junctions - forming 'one-way' *Y-connections*, as compared to the 'two-way' *X-connections*. The changes in sizes, thus, lead to a change in periodicity (occurrence of the spirals over a period of time), making the system 'quasi-periodic'. Here the 'matrix of relations' manifest as dynamic topological relations or spatial periodic occurrences and material dynamism in its component assemblies. The resultant experiment provides a representation of tension, leading to the development of generative geometry and inevitably introduce a play of relations in space and time. Stemming out from

¹⁰ The Sargasso adapted from the form language libraries of LASG, was designed and developed as a part of a larger ecosystem, titled Meander, installed inside the Tapestry Hall in Cambridge, Ontario. During the course of this research, each of the components were designed, prototyped and fabricated at the LASG facility in Toronto.

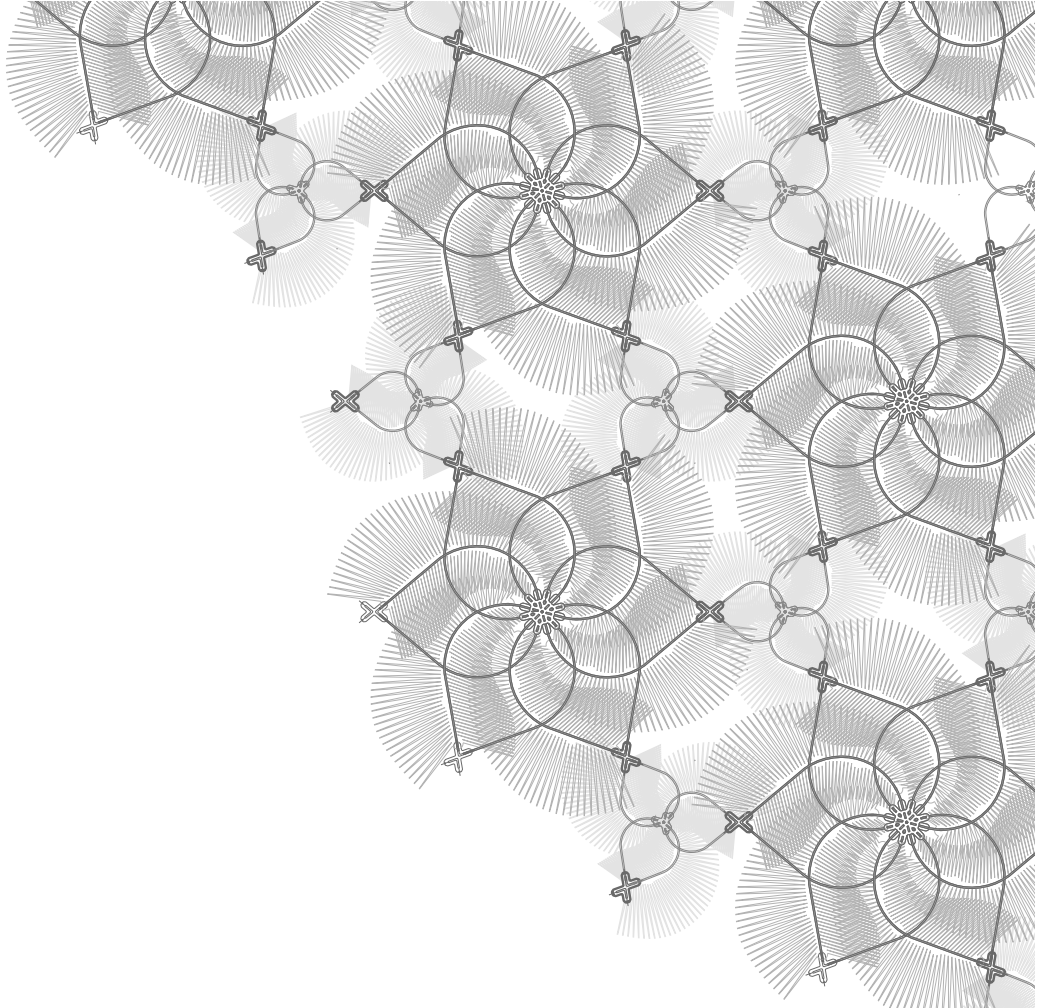

Figure.5: Synthesis III: Towards Organicity

the flexible hexagonal tiling, the body of 'spiral' becomes an imagery of a unified 'being,' a creature that dances in space celebrating the marriage of science and art.

All three form languages build and amplify the 'set of relations' and the 'matrix' of dynamism inherent in nature through play and geometric topological variations. Where the organic constructions address the spatial and the chemical relations/properties on a two-dimensional canvas, the crystalline deconstructions present the play of polyhedrons that

form relations by virtue of their surface, edges and vertices through gyration in the three-dimensional space. The Sargasso builds on those relations by emerging into antagonistic spiral filamentary projections that essentially stem out of the volume of the polyhedra. The structures manifest topological relations in periodic occurrences as a consequence of individual repeating arrays. Here the connections do not form through surfaces of polyhedron 'coming-together' or its vertices, rather it is the development of connections between filamentary components that are designed to carry the energy and launch it into the adjacent connecting spirals.

Subsequently, all geometric constructions are accompanied by 'voicings' that follow an immanent approach of dual interpretation; resonating between phenomenological direct perception and a rather hermeneutical viewpoint that seeks to listen to each of the forms as they organize and aggregate.

Following the visual projections and meditations, the thesis looks for architectural and philosophical paradigms and borrow theories as a way of highlighting conceptual parallels that inform concepts of mediation and intersections of the rational and the intuitive systems. The fifth chapter elaborates on the polarities in the architectural context by introducing Bruno Taut and the *Crystal Chain Letters*. The sixth goes back to the historical sources to Plato's *Timaeus*, *Hyperotomachia Poliphili*, both of which deal with *Chora* (the interval) and 'mediation,' followed by René Guénon, in which ideas about directionality and relation bring us again back to the richness of meaning in the heterogeneous and dynamic spatial field. The seventh chapter returns to the modern sources focusing on the organic as a process of forming relations between forms. Here the research presents examples of the works of Moholy-Nagy and Friedrich Kiesler which provide precedents on heterogeneity, relations, and continuities across scales and patterns.

In the literature above are examinations, recurring ideas and paradigms that assist contextualize the form languages created in the discourse and direct us to ways where we could understand, develop, and harness the organic synthesis and the qualities of nature. The forms created in this discourse express both scientific imagery and an artistic expression, encapsulating the 'in-between,' offering a potential connection between the substantial and the essential faculties of our world. The thesis acknowledges a debt to Zvilna's techniques and Living Architecture Systems Group (LASG) testbeds which provided a starting point to build, develop and expose relationships between diverse yet unified systems. Before diving into generative processes of form creation, the work will briefly address Zvilna's creations which have a perceivable link with the studies that will follow in the discourse.

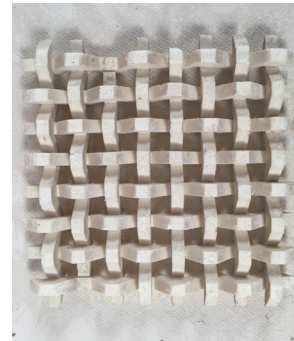

Figure.6:Zvilna Block Tessellation, from the archives at the University of Waterloo

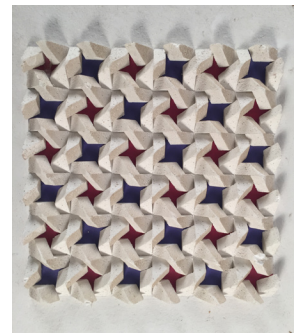

Figure.7:Zvilna Block Tessellation, from the archives at the University of Waterloo

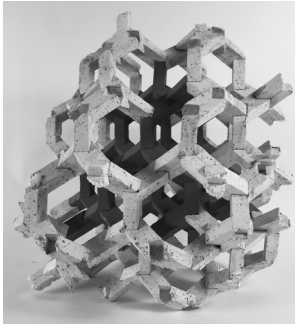

Figure.9:Block Model, from the archives at the University of Waterloo

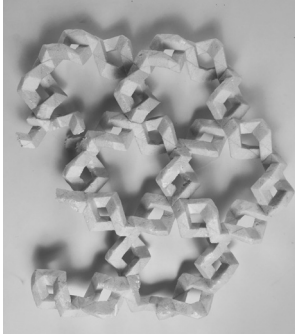

Figure.10:Block Model, from the archives at the University of Waterloo

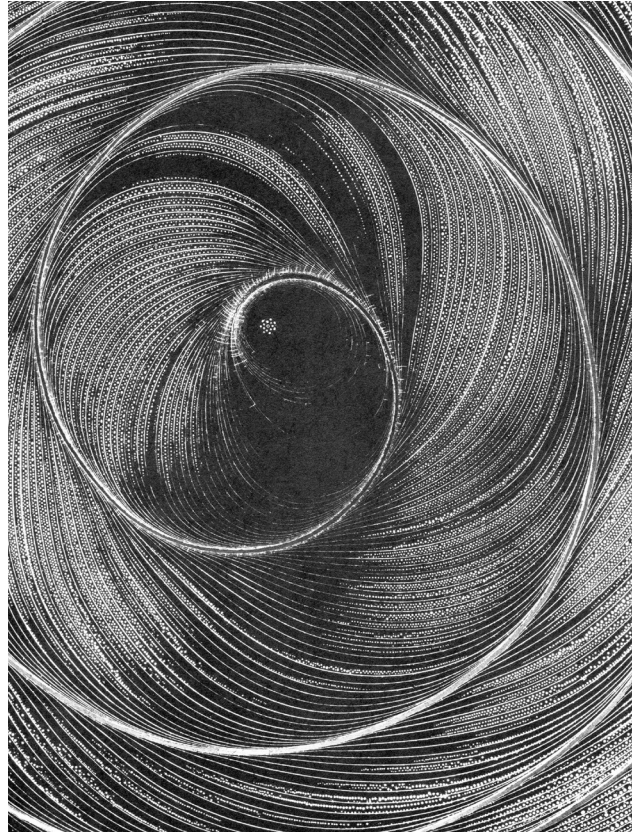

Figure.8:Labyrinth Spiral of Zvilna (late 1970's)

1.4 Investigations of Jekabs Zvilna

"a man is a man mostly when he plays" - Jekabs Zvilna

JEKABS ZVILNA (1913-1997), born in Latvia, was a creative phenomenon, encompassing the persona of an artist, an architect and an engineer at the same time. Although he remains undiscovered to the world, his work stood out for the genesis of visual form, a radical form-generating system of relationships through transformations, growth and abstractions. Zvilna's ideology was rooted in Froebel's mysticism and 'building block' constructions, and that translated in his work and teaching at the University of Waterloo. While unravelling the enigma, this research takes it further to unfold the mechanisms that directly inform the synthesis of rationality and intuition; developing cosmic patterns and



Figure.11:Zvilna Block Model, from the archives at the University of Waterloo

natural organic geometries to the construction of block-form modularity. Zvilna's doctrine unified knowledge and feeling. "Form is both deeply material and highly spiritual. It cannot exist without a material support; it cannot be properly expressed without evoking supra-material principal. Form poses a problem which appeals to the utmost resources of our intelligence, and it affords the means which charm our sensibility and even entice us to the verge of frenzy. Form is never trivial or indifferent; it is the magic of the world."¹¹ Inspired by both Moholy-Nagy and Kiesler (discussed later in the modern conceptions), Zvilna's approach was centred at looking at form as a 'result of processes' and 'rotation.' His thesis 'Doctrine of One' manipulated technology and nature to search for the ultimate reality, the 'one'. Two aspects of Zvilna will be under consideration for this work: First, two-dimensional visual investigations of form in nature, inspired by Zvilna's techniques of domesticating nature's energies that will reflect organic formative processes. Second, a study of block-form modularity as a form-generative process, which will later be used for developing the language that lies in the 'in-between.'

11 Zvilna, Jakebs. 1974. "Rotation and Form." University of Waterloo p,43



Figure.12:Zvilna Model Detail, from the archives at the University of Waterloo



Figure.13:Zvilna Block Model, from the archives at the University of Waterloo



Figure.14:Zvilna Block Model, from the archives at the University of Waterloo

2. Organic Language | *the poetics of forces*

In response to investigate the processes and forms in nature, Zvilna's organic experimentations deemed useful in providing important leads to develop techniques that could offer a great deal of insight in understanding the generation of form in nature. The experiments are at the same time intuitive representations and scientific chemical constructions. Using nature's methods of rotation and material chemistry between graphite and oil, Zvilna was able to manifest cosmic, mystical patterns. But it was still unclear whether the emergent patterns were curated/controlled or they emerged on their own under certain conditions. Was it mere chance? Or was it an actual 'process' that lead to the precise results? In the archives of Zvilna and the material found, the process of 'making' these patterns (Figure 7) was not recorded. There were no traces or remaining materials or used glass plates of any of his experiments, but only the photographs. It was a mystery - except in some sources (letters and a film) he mentioned graphite, rotation, and oil and the properties of the solvent. I took on this lead from Zvilna as a way of finding nature's ways of revealing a form. Is it a process? or something else?

This exercise started with an investigation of nature's form-generative processes; a manifestation of emerging patterns from a set of physical conditions – involving viscosity, volatility, and gravity. The technique was built further by using multiple solvents, speeds of rotation, and controlling the flow of air, and the 'nozzle sizes' for variations in the volume of the droplets. Therefore, the patterns were 'controlled' and 'curated' at the same time. As I started my experiments - I looked as the solvent started to flow and the carbon settled at places. Scientifically, the patterns would be explained as an emergent behaviour of the viscosity, speed and other variable factors. Intuitively, it was found that any change in 'variables' or the 'point of drop' for the oil would alter the output entirely, creating a new 'consistent' pattern. I was intrigued. Yes - the carbon and oil looked for their natural order; it was their stored 'potential'. Yet I stood there 'playing god' as I changed conditions. I continued with possible alterations in speed of rotation of the glass plate and gravity; the tilt of the plate. It was a revelation - in reality, none of the factors were independent. I was not merely altering variables - I was establishing 'new relations'. It was the 'relation' between these properties that lead to certain projections of the form. The patterns emerged as an outward manifestation of the marrying between the carbon and the solvent. The viscosity was integrated with the gravity tilt. Volatility was subjected to the rotation. Everything was interweaved and I was a part of the cosmic web surrounding this plate. It was not the 'process' that produced the form; rather a matrix of 'relations' that informed the process and which, as a result, created the form.

Be...

The experiments (image series titled: Be...) were carried out by coating a 2" x 3" glass plate with carbon and gently running an oil solvent over the glass. The experiments are a result of 'relations' between nature's forces: surface tension, the volatility of the liquid and viscosity; an outcome of two materials marrying together while being exposed to external factors of gravity and rotation.



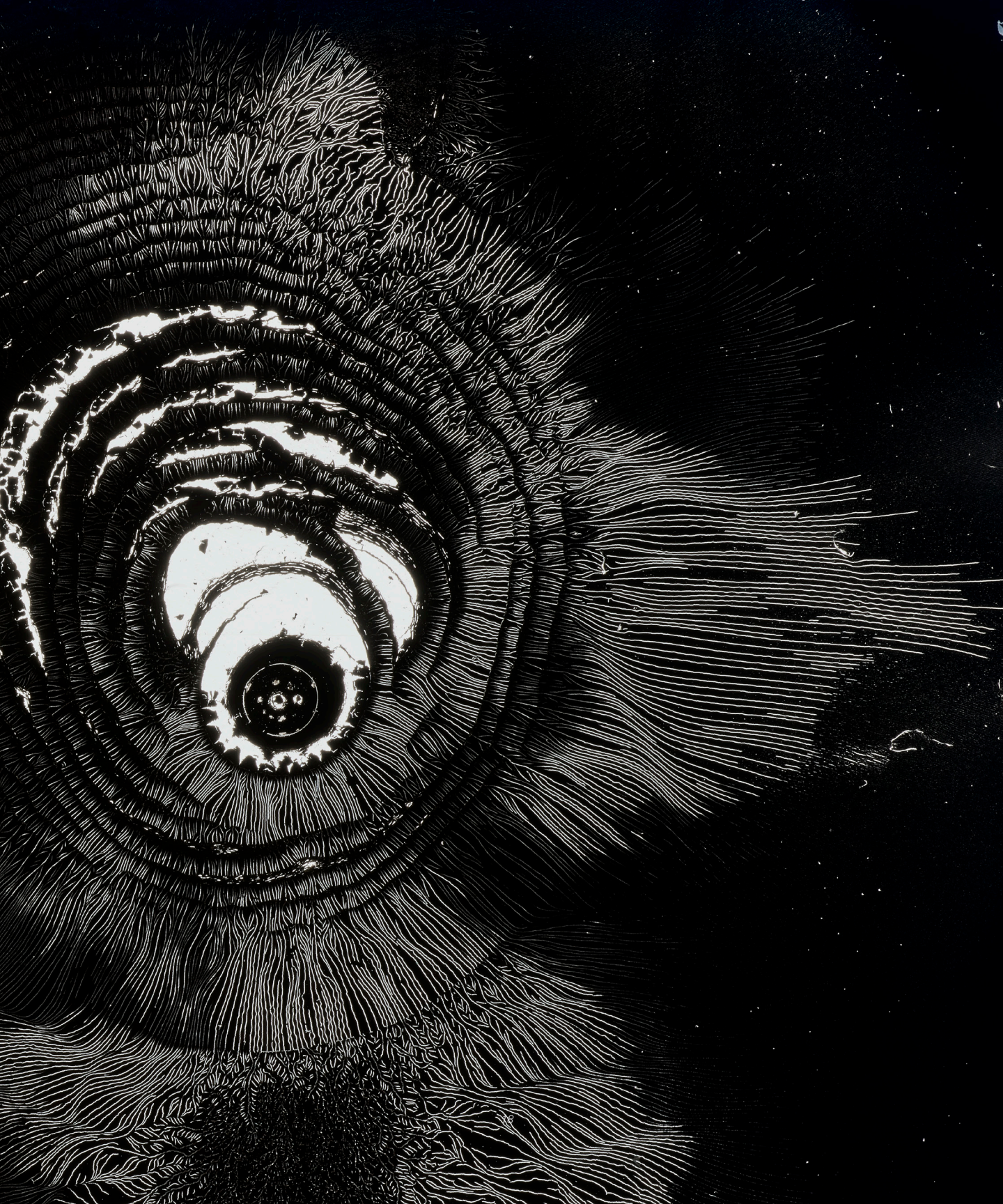

I look at the carbon – black soot as it covers the horizon of the glass plate.

*It is the prima materia, absorbing all that is, or ever will be. The canvas of life. The unknown matrix, containing all the potential;
all the consciousness; all that is in the sensible and intelligible realms...*

The black expanse of the nothingness calls to be shaped. I do not know what it is. I do not know what it will be.

I just know it wants to be discovered - it wants to be known. It wants to talk.

It asks me to initiate.

I drop the first droplet of thinner.

“Be...”

...and occurs the cosmic explosion...

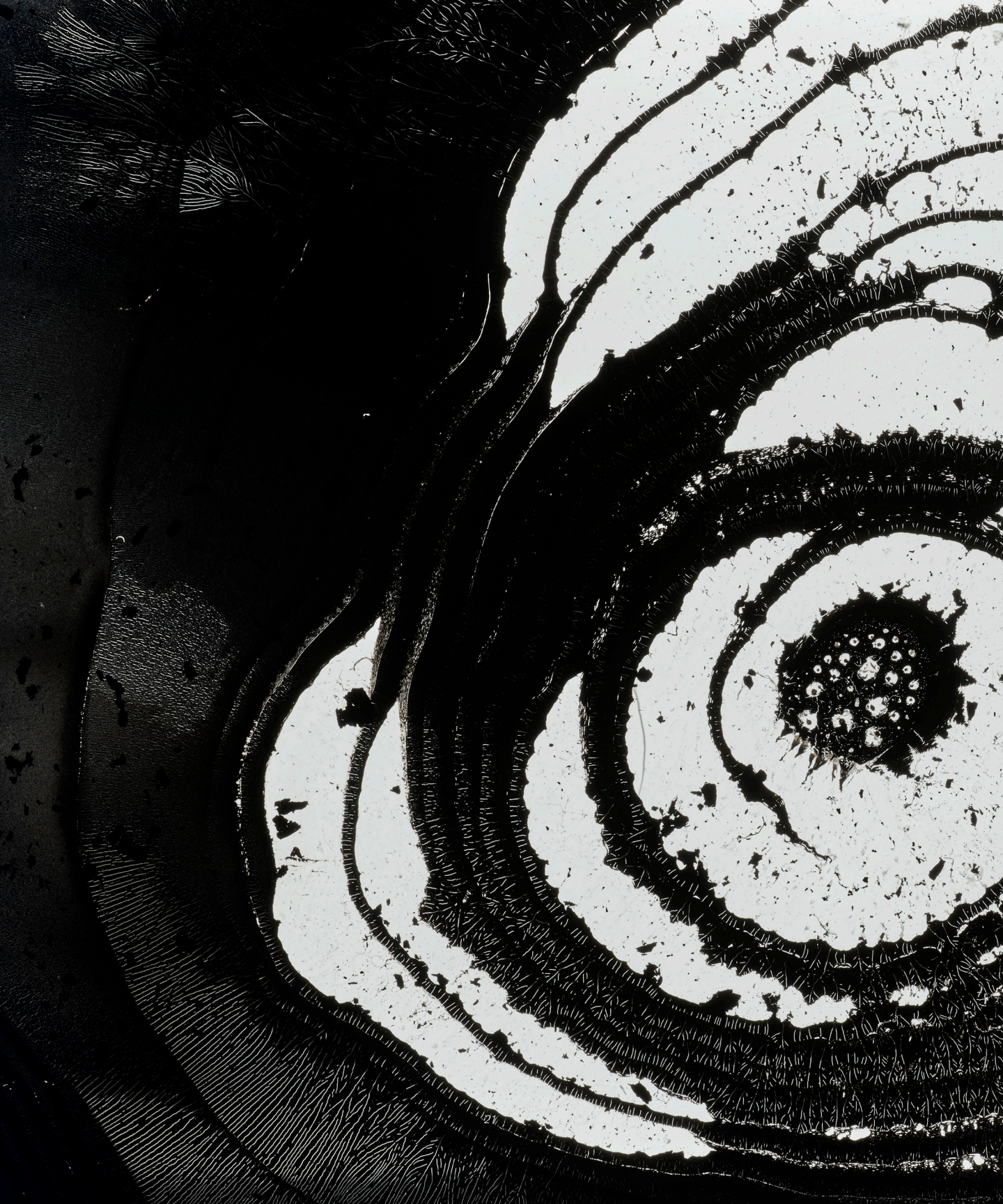



The carbon embraces the oil drop....
the droplet sits... expands into a sphere...and eventually evaporates...

As it leaves...it appears from the primordial darkness, the quintessence of life...

The glass plate held in my hands responds to the slightest of the variations. I feel blood in my veins rushing and responding, carrying life. I try to stabilize but life vibrates through me– I can not stop that. I decide not to.

The emerging world shapes itself to the rhythm of my being...presenting to me an image of my own cosmology, perhaps...

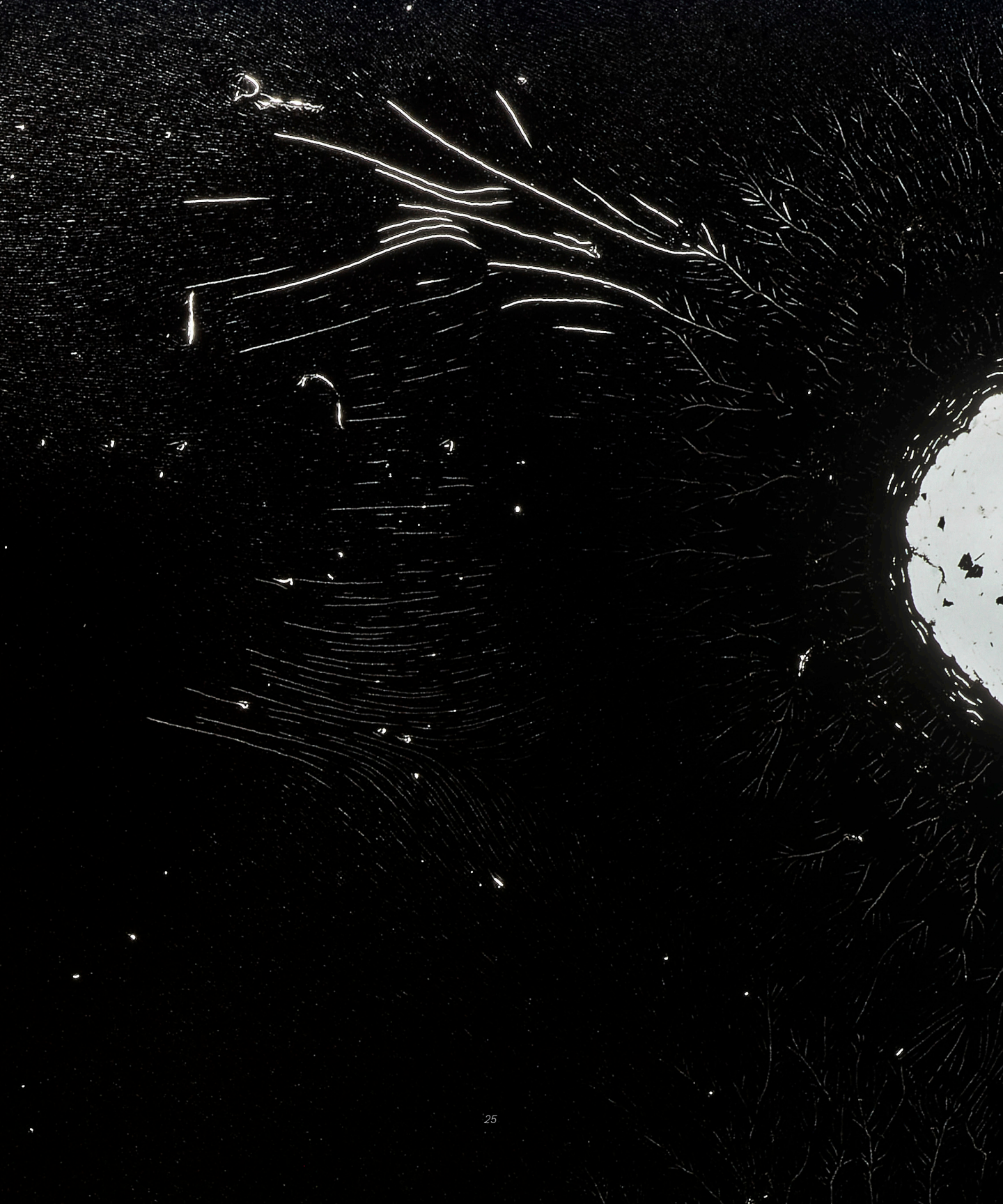

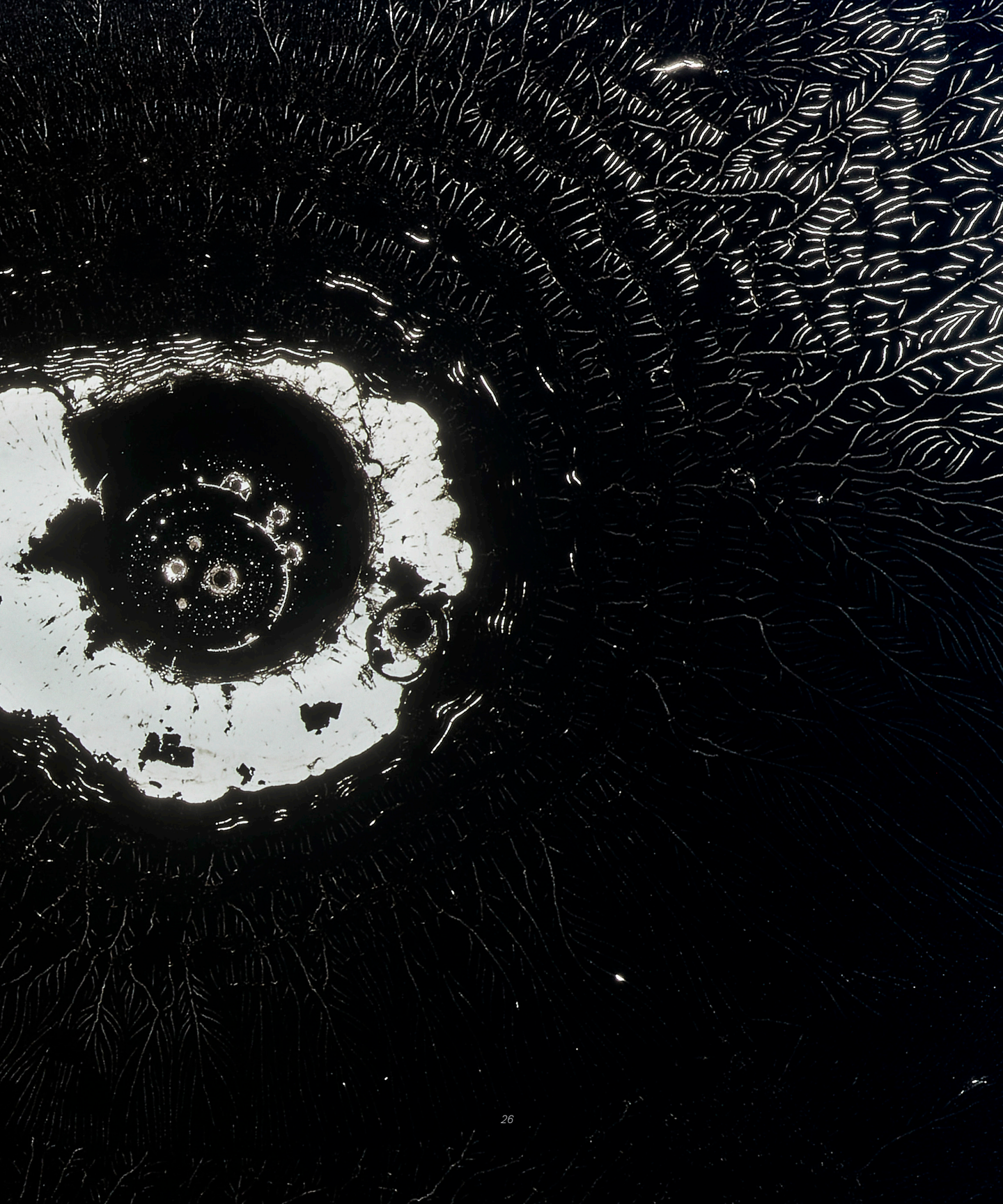

I sit there as an apprentice, looking at the world unfold.

Noticing as each carbon particle moves as if it has its own journey...longing for its destination

There are forces at work – *yes, forces.*

I notice, the air can easily pick up the thinner oil. It's highly volatile.

Perhaps, the cosmos calls for a rhythm.

I drop the thinner at successive intervals.

Drop by drop...

forms appear...like radiolarians...projecting spines

the morphology becomes more complex as I start to alter the spatial relations...

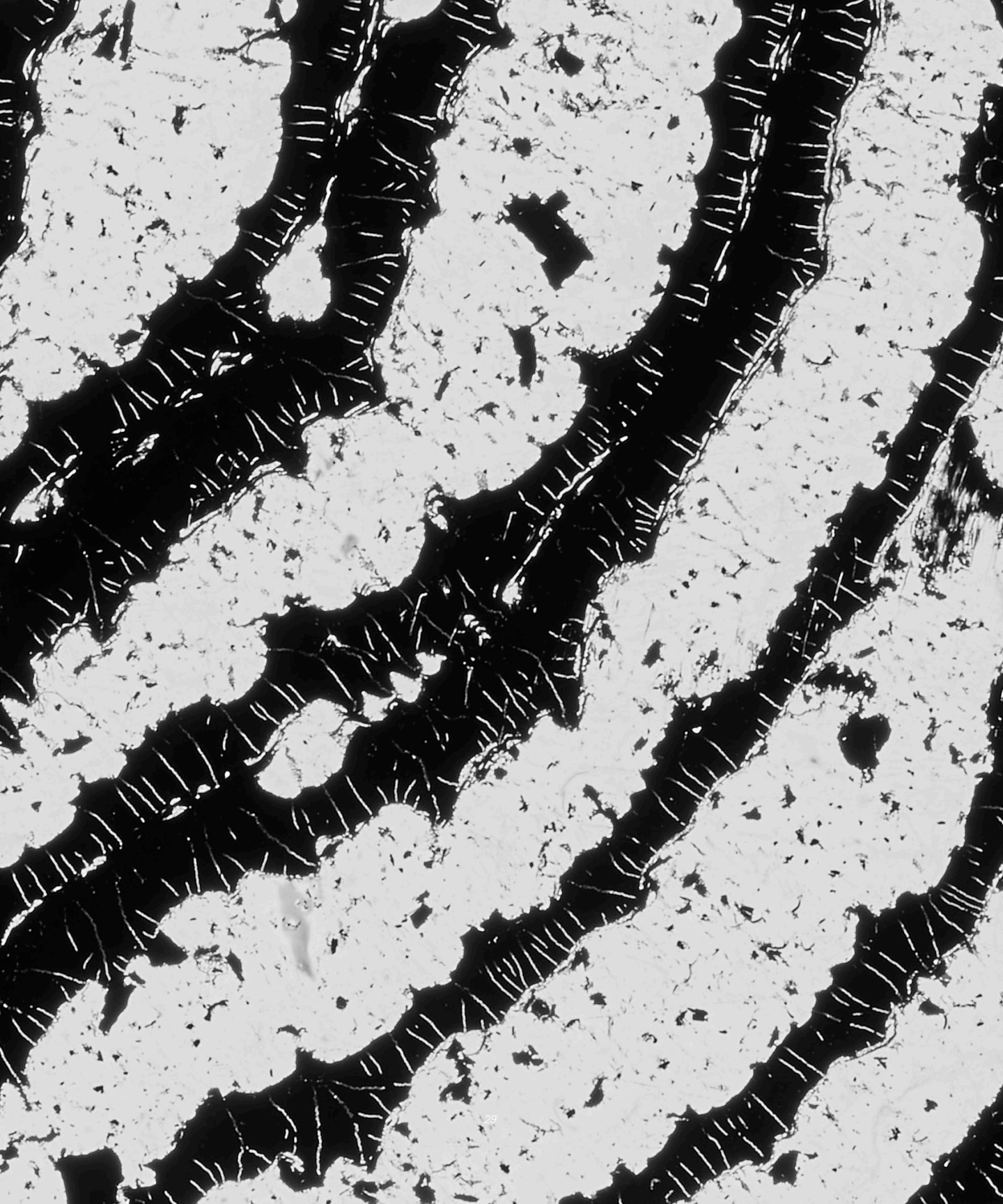

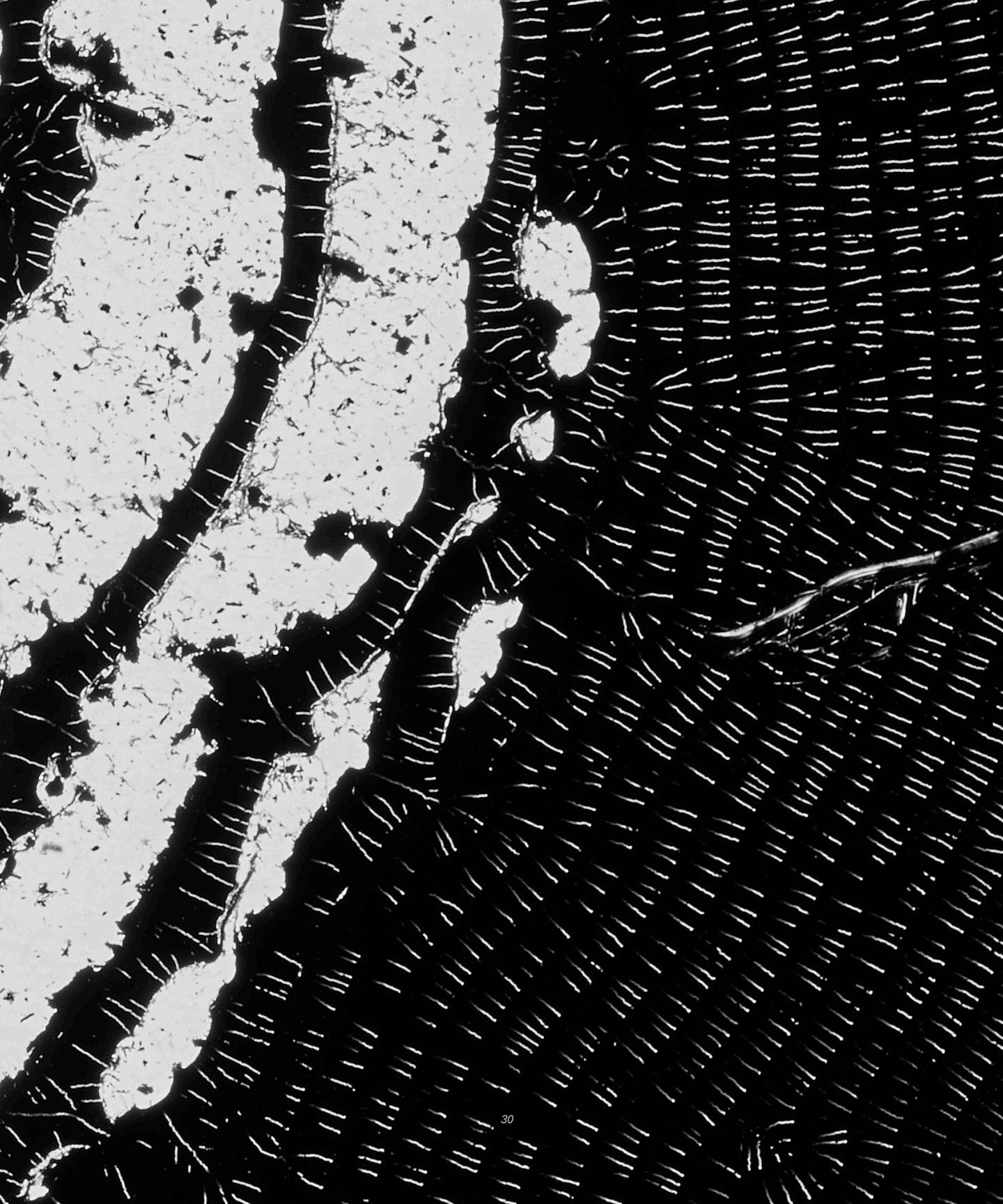

How could I control the volatility? This time I use motor oil and not the paint thinner.

Like semen...it runs, fertilizing all matter that lies in its way...

this time, air fails to lift it up...

I feel my role shift to a curator... gaining control...I tilt the plate and start to *play*

The universe recognizes my call...and I witness another force...another field...

...gravity

...which has been there all around...paying homage to the matter...

For this silent communication...I am filled with nothing but compassion and joy...

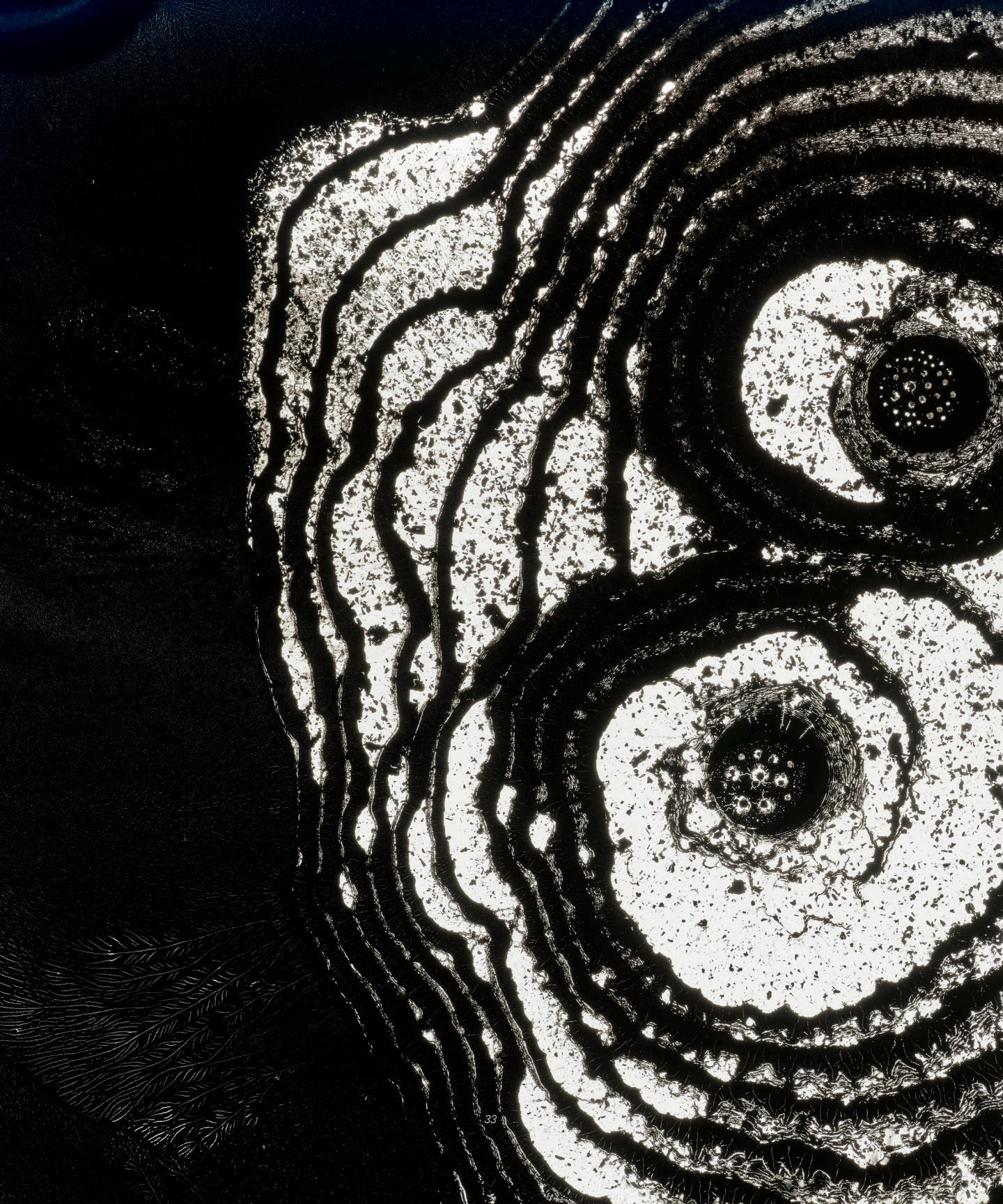

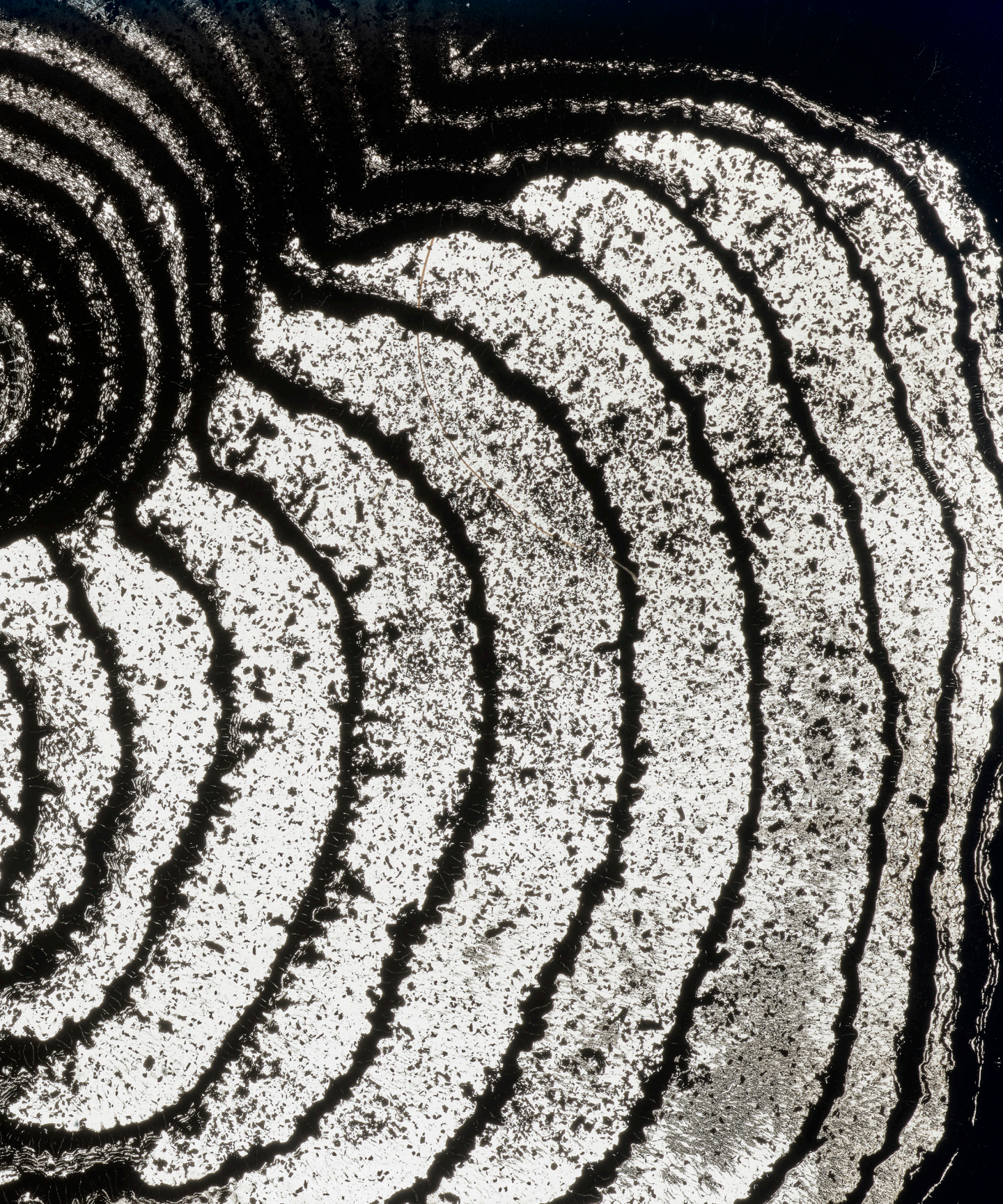

This is not enough. The system needs motion... a constant stable motion

I introduce *rotation*...

Why rotation? I ask myself.

and appears in front of me...a ceremony...a celebration of an invisible center, from which appear concentric rings....I witness a testifying of unity...a unitary order...inherent in all of the matrix: unknown to man

"Rotation", I say..

...the life-sustaining force of the macro and the microcosmos...

patterns start to emerge....

patterns....perhaps...cross-sections through spatio-temporal patterns...

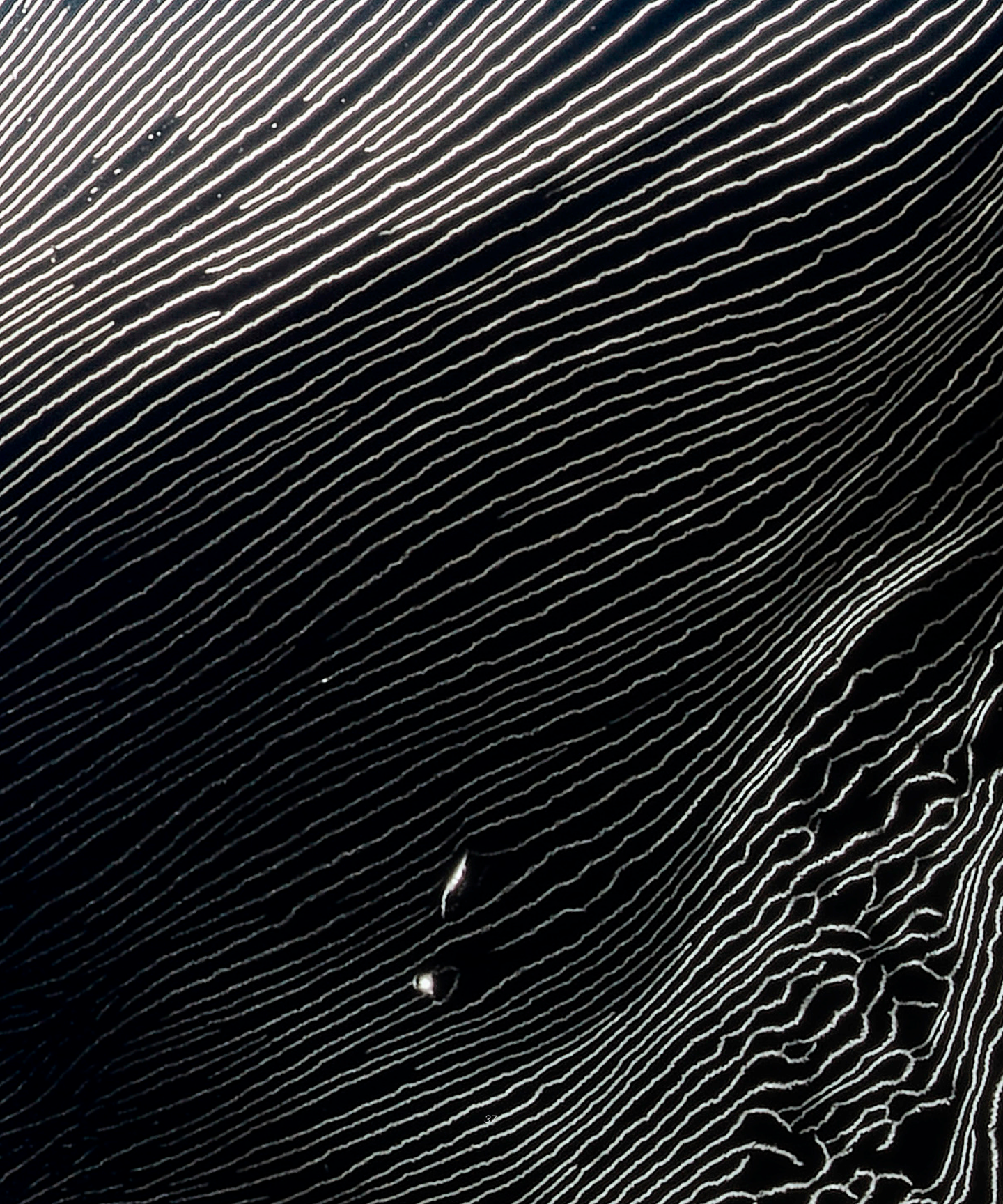

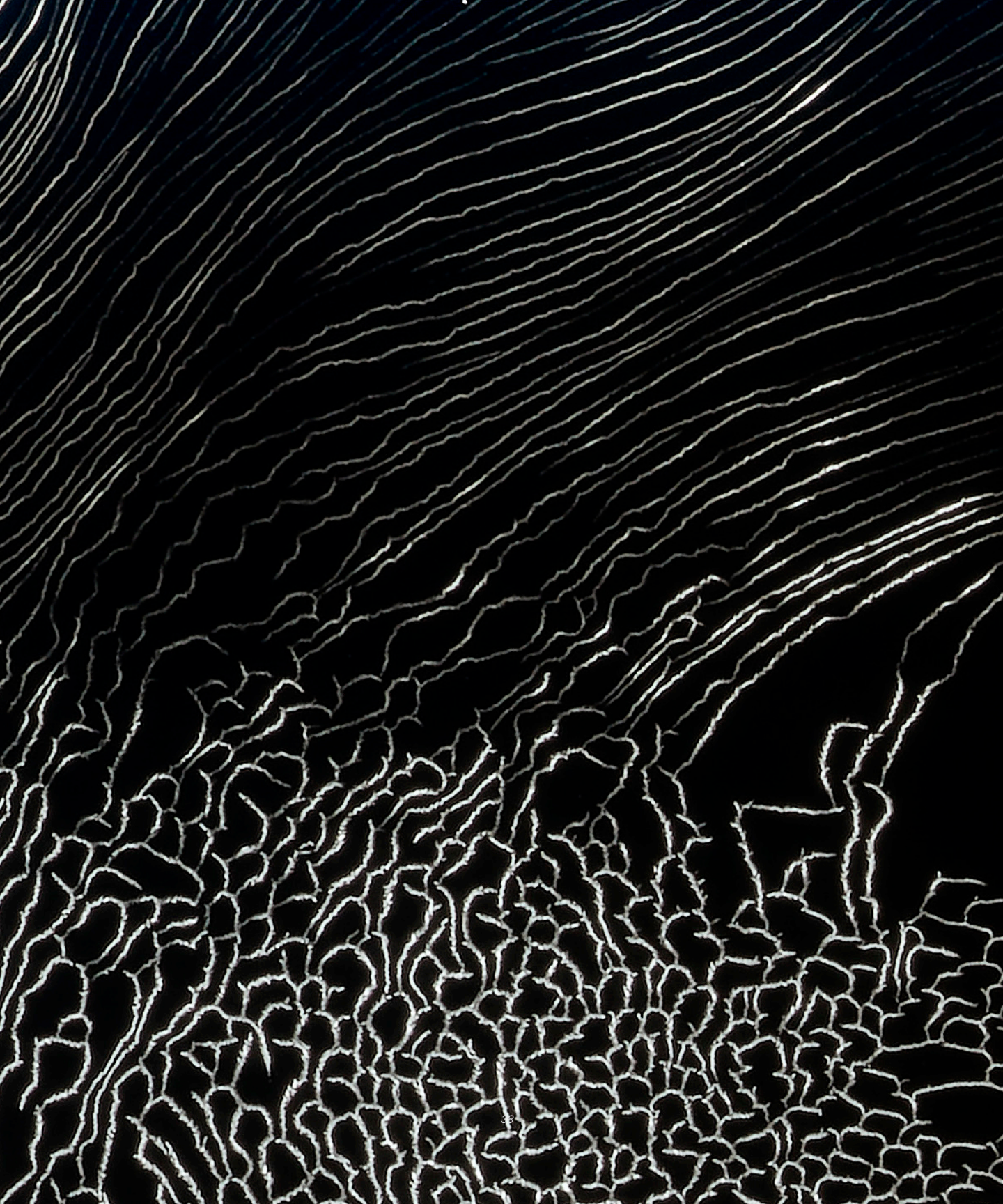

Now that a system is in constant motion...I reintroduce gravity...again.

The plate rotates while tilted...

I alter the angle...the viscosity of the oil responds...

Was gravity always communicating with the viscosity of the solvent?

As the dynamic symmetries continue to appear and dissolve...it starts to echo throughout the system.

relations...relations...relations

somewhere between those relations a tension is captured...tension between entropy and order...



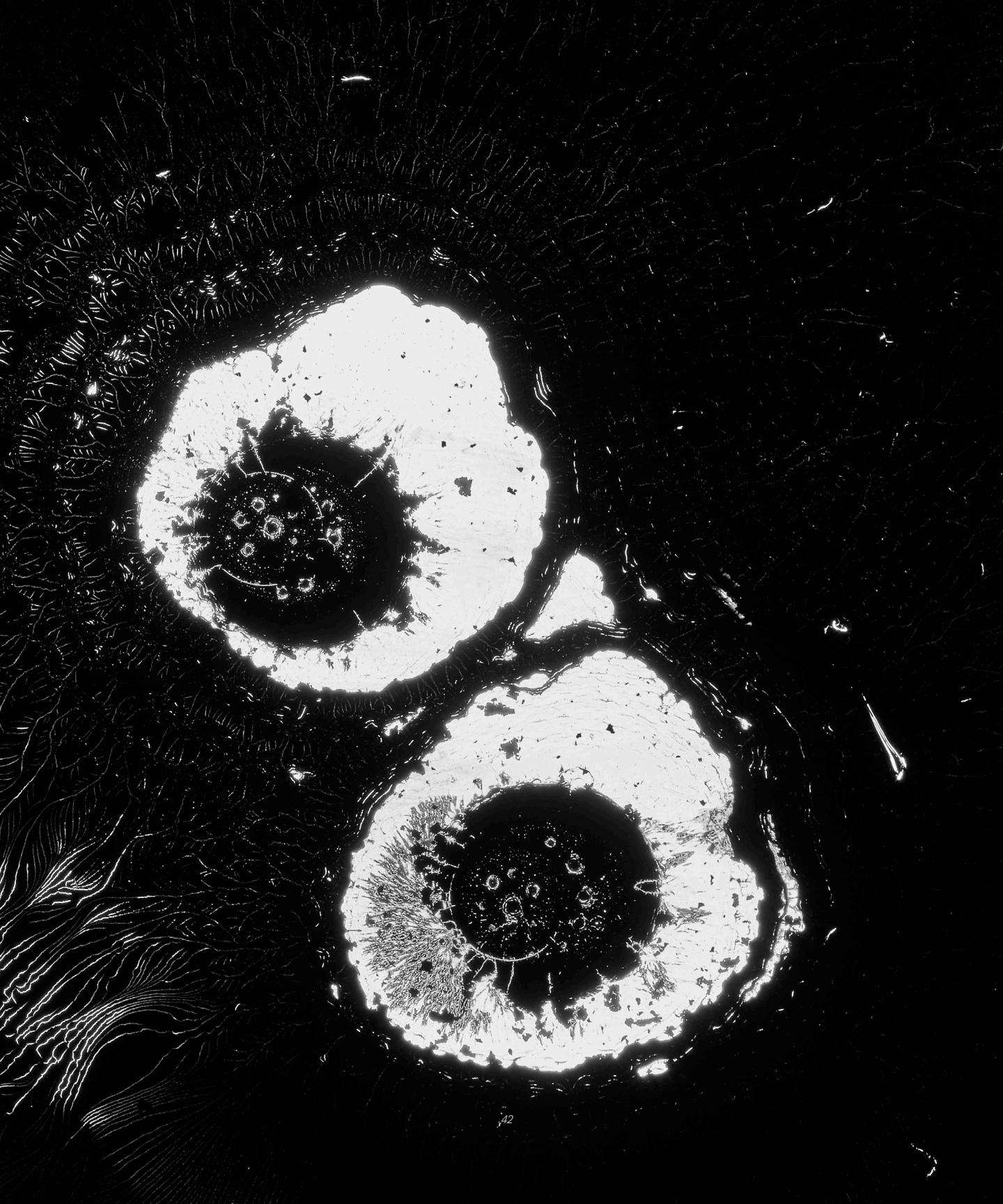

I introduce multiple dropping points of the oil

The system *revolves*...I control the speed...

How would the world unfold had the echo of “Be...” caused multiple worlds to appear?

The oil drops *submit* to the cause...

Whirling...embracing...accepting each other...

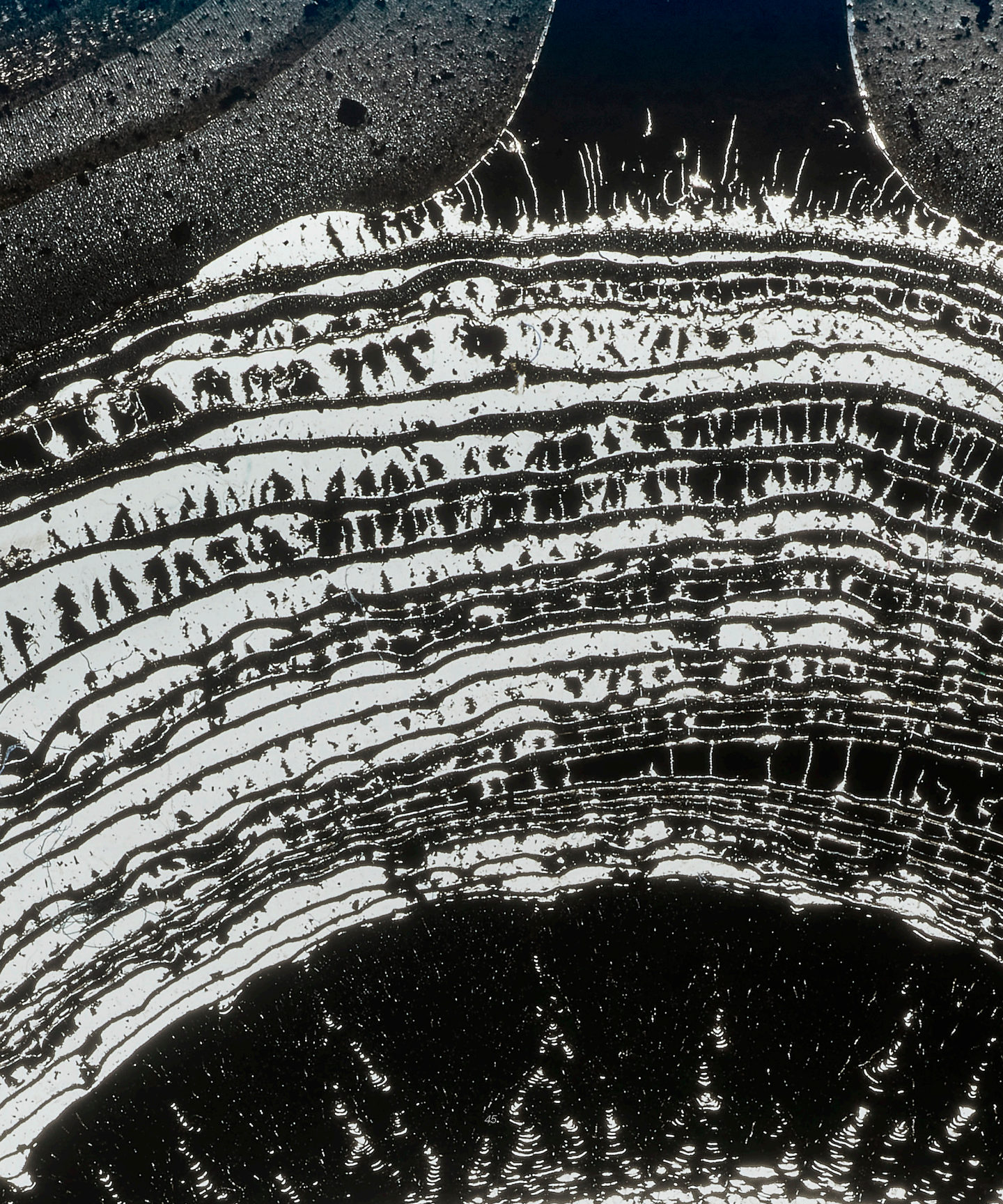

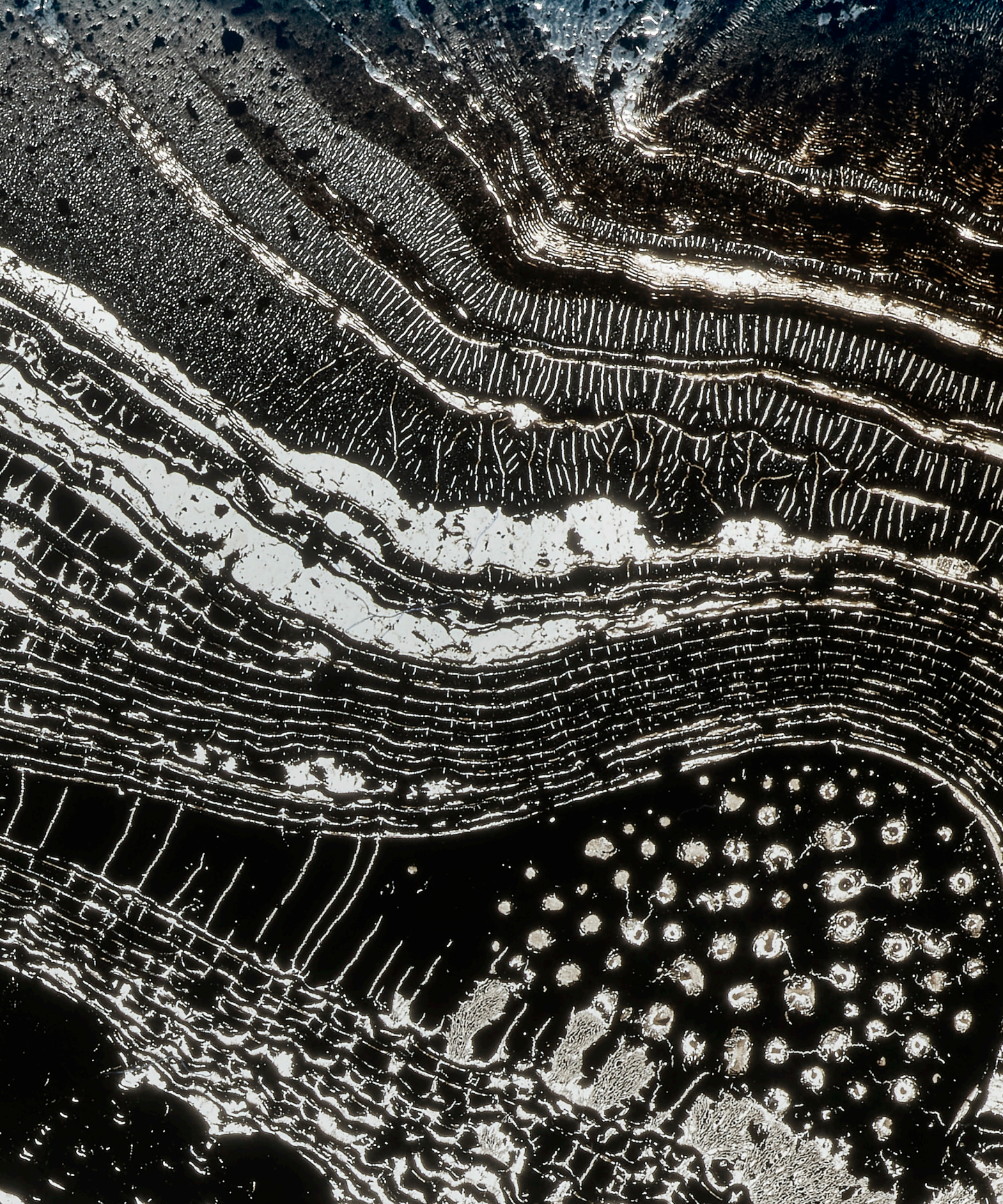

With rotation, air starts to flow...

Rotation affects volatility

...the plate is tilted...*gravity!*

...oil runs to the pull...

I introduce soft horizontal *vibrations*...*oil recedes*

For a moment I feel it doesn't know where to go...*I am mistaken.*

It adapts to the new intervention

The system moves...revolves...adapts...breathes

as it almost came *alive*...

I think - I captured a moment of longing...a longing for order and disorder at the same time...I witness patterns
in influx...resonating in ecstasy...a threshold...

What just happened?

...a cosmic orgasm...

the cycle continues...

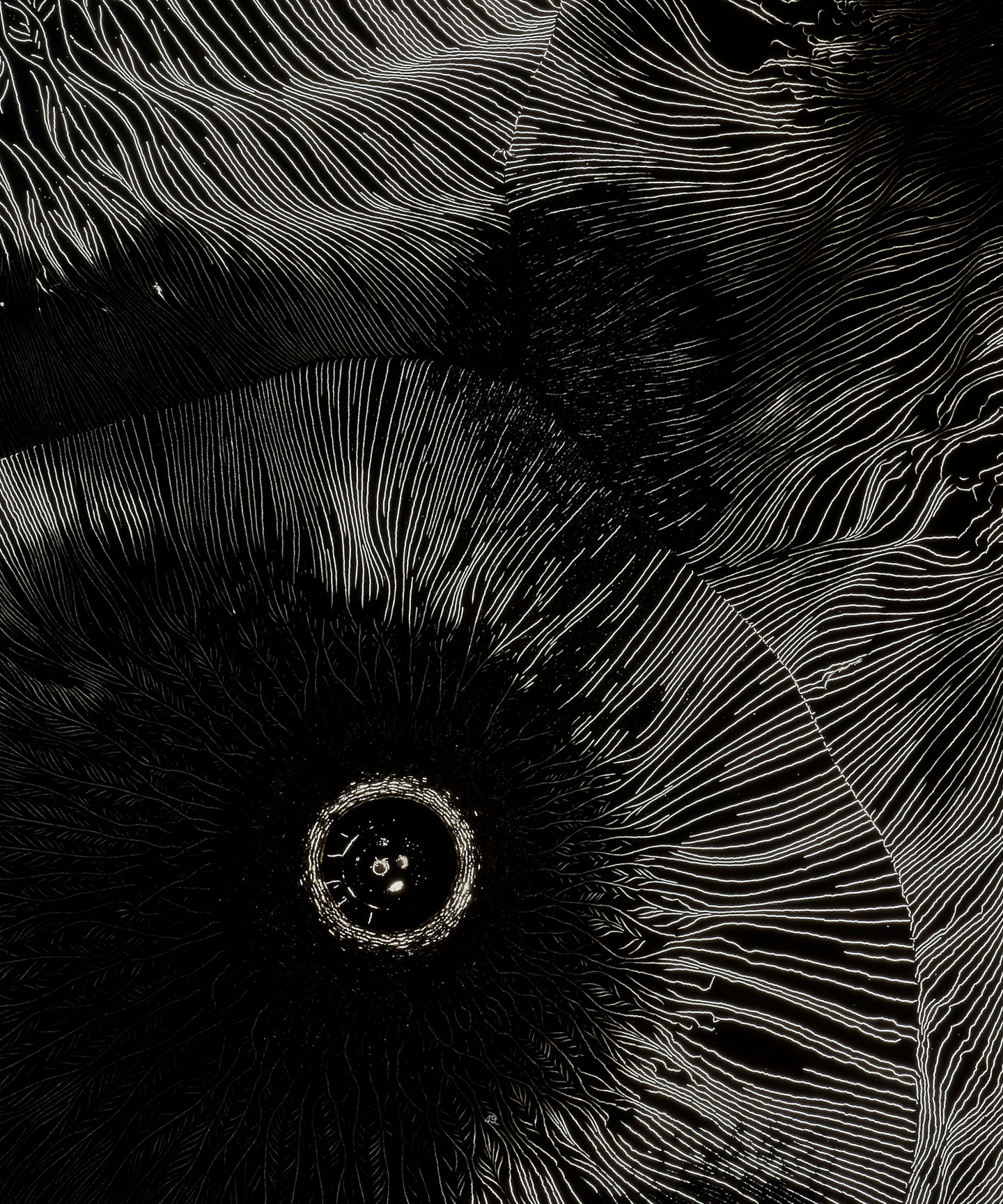



The dance of emergence continues...

Can I vary the pull of gravity? I start to use different oils – different viscosities...
Every time I get a slight change in the behaviour, in the marriage between the carbon and the oil.

I am not satisfied. The oil drop cannot just run freely on the plate. It needs to be suspended.

Held by both the sky and the earth – mediating in the 'in-between'...

I suspend an acrylic sheet over the glass plate – it never touches but *floats*. Through holes in it, I drop the oil
again.

...held between the plates...the drop experiences surface tension...while being subjected to forces of gravity and rotation...

Out of silence...a language appears...





I have stopped.

I look at the poetics...the vignettes of the cosmos...some self-portraits...some reflections...some I already washed of...

What was this? I reflect.

It seems that each variable I catered with was not independent of the other...nothing ever was...

Gravitational pull...viscosity...volatility...flow of air...rotation...surface tension...

I was immersed in a matrix of relations...a web of nature...

Who was I then? *I was another force perhaps...*

As I try to dissect...I acquire partial, perhaps novel information but lose something of the organizing vitality...

Relations...relations...relations.... I hear again.

A constant dynamism...in front of me was an imagery of a systematic whole which could not be reduced to parts...an imagery of interrelations, of continuous connections...an imagery of all that resides in the One...

My hands are covered in wax...oil and carbon...

Far beyond in the unknown realm of the universe, where there is no above or below, left or right...Zvilna smiles

3. Dynamic Modularity | *building-blocks*

Following the study of 'interrelations' informing processes in the organic studies, the interest in Zvilna's modular constructions expanded to investigate whether the concepts resonated in his crystalline geometries. In his helix-shaped modular constructions and his Styrofoam sculptural developments was a certain dynamism; an organic reflection. It was not the only manifestation due to the Zvilna Block. Instead, it was the manner in which the Zvilna Block interacted, interlocked and formed relations with another of its kind. The whole construction emerged as a result of the crystallization of the 'in-between' relationships of the units.

In his publication titled, *Doctrine of One*, Zvilna explained the Module as a composite of the rational and intuitive. He wrote: "The new shape has edges of 1, $\sqrt{2}$, 2, $1 + \sqrt{2}$ One for the One, and the rational in man, $\sqrt{2}$ for the irrational in man."¹⁰ I embarked on deconstructing the models originally made in Styrofoam and wood as a means of understanding the system of interrelations and the generative process behind them. As I deconstructed and made digital reconstructions, two things were evident— one, the potential; two, actualization. The potential was stored inside the module, its shape, its form. Its configuration gave it the potential to be able to connect, and expand, and connect again. The measurements Zvilna mentioned allowed the module to be launched into a 'continuous' process of generation, where it could multiply and expand in various ways. It is important to highlight that it was again the 'potential' between carbon and the solvent that lead to the 'consistency' of patterns in the organic experimentations.

The actuality, however, was only realized as a result of the two modules 'coming-together' and forming a distinct 'relation.' The relations were dependent on the type of connection modules formed. There were many possibilities of 'coming-together': face to face, portion of the face, edge to edge, portion of the edge, and vertice to vertice. It resonated exactly with the organic experiments in which the 'variables' (internal and external forces) were accountable for forming a new matrix of forces, and that, in turn, realized the form. Similarly, any set of relation would generate a different set of form language. The following studies show that it is possible to approach the idea of developing complex forms out of a single module, highlighting generative processes as 'units' come together in relations.

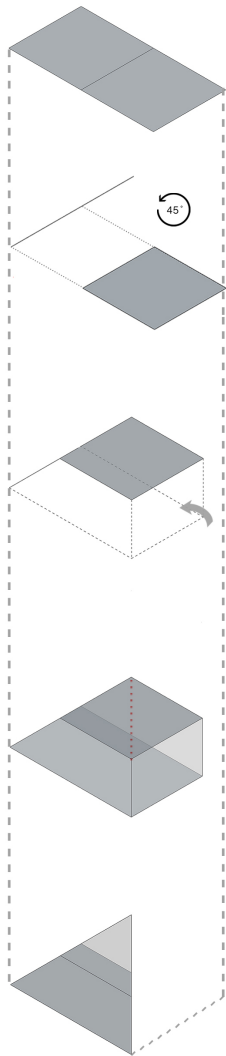

Figure 25: Helix formation from a Zvilna Module

¹⁰ Zvilna, Jekabs. 1984. "Doctrine of One: an exercise in twentieth-century synthesis" University of Waterloo p.18

Crystallizations

The experiments present deconstructions of the existing Zvilna models that resonate with ideas of interrelations and generative processes in nature. Among the models that were present in the archives, four models were adopted for this study, three of which share the same module. It will be evident that even though the module was the same for the first three experiments but differences in 'connections' or forming 'relations' altered the entire form or the synthesis of construction.



Two identical squares

Rotation of one Square at an angle of 45

Join the top edge of the inclined square with a flat square

45 Degree cut on the flat square

Wedge-shape

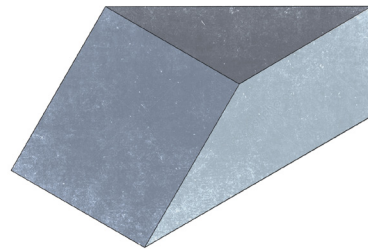

Module development

Figure.26: Form Generative Module: Type A

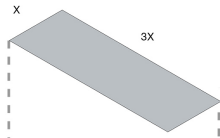

Two identical squares

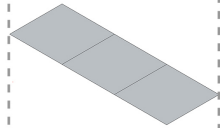

Divide the base into three squares

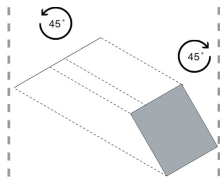

45 degrees rotation of both squares on either side

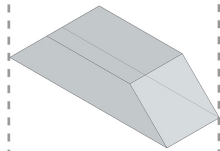

Solid wedge form

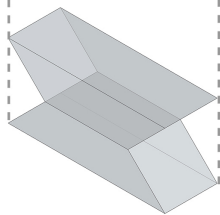

Mirror wedge to form a X-shaped module

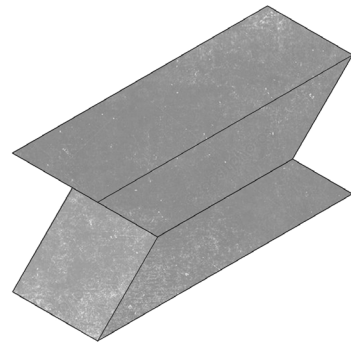

Module development

Figure.27: Form Generative Module: Type B

Its past midnight.

Time...rotation...space...earth...day...night...

I am surrounded with models...dusty old Styrofoam models, wooden block models...

I think they are models...but can't just be models...peculiar models!

Models of what?

I look –

Still flooded with the organic revelations..I ask myself.

Are these crystalline representations of nature?

Nature's principles, perhaps...

What is nature?

I start searching for the etymological meaning. . .from Latin, natura "course of things; natural character, constitution, quality; the universe; essential qualities, inherent constitution...

Constitution! Inherent constitution!

I look at the models again – they start to talk

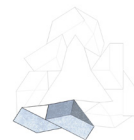
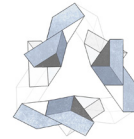
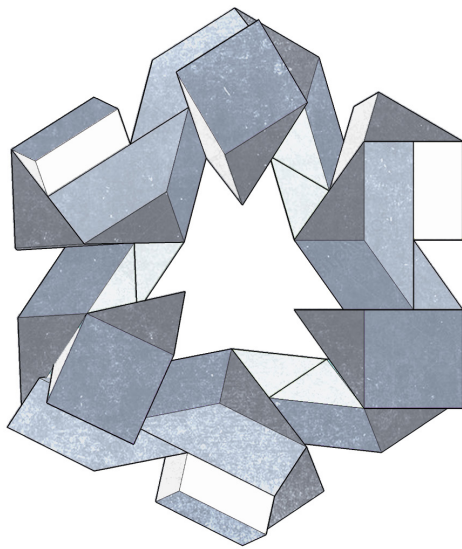

Figure.28: Form generation - Module Type A

Generative Polyhedra

Connection: Portion of the face to Portion of the face

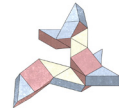
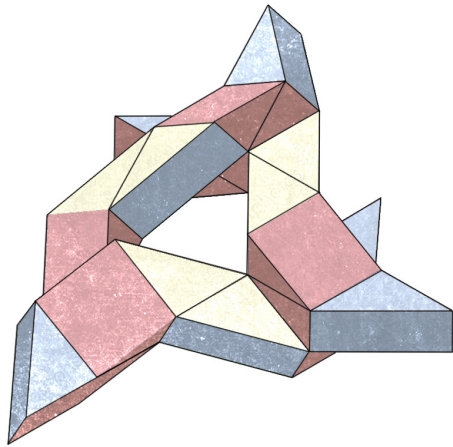

Figure.29: Form generation - Module Type A

Generative Polyhedra
Connection: Face to Face

I start from a single unit...the polyhedron...
As I build the unit...I notice the *inherent potential* of the module
Where does the potential lie? I ask.
...It is in the shape...

But all shapes have potential?

...the form of the container does affect the content...

Inherent constitution...each unit hold within it potential to multiply...*repeat, rotate and form patterns...*

I have made the module
There is something else it needs...

each side of the block wants to be known...it wants its own identity
I start to notice.
...each surface wants to be identified as a system - a system with a specific purpose...
I respond.

The surface is labelled by colors

Construction commences...
I have coded the sides...and I start to follow a system...code by code...

the faces...vertices...edges of the polyhedron...all suggestings ways of molecular connections...

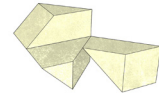
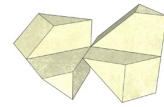
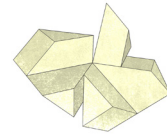
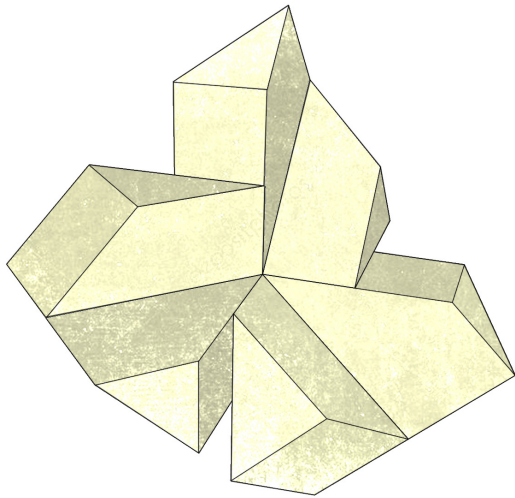

Figure.30: Form generation - Module Type A

Generative Polyhedra
Connection: Edge to Edge

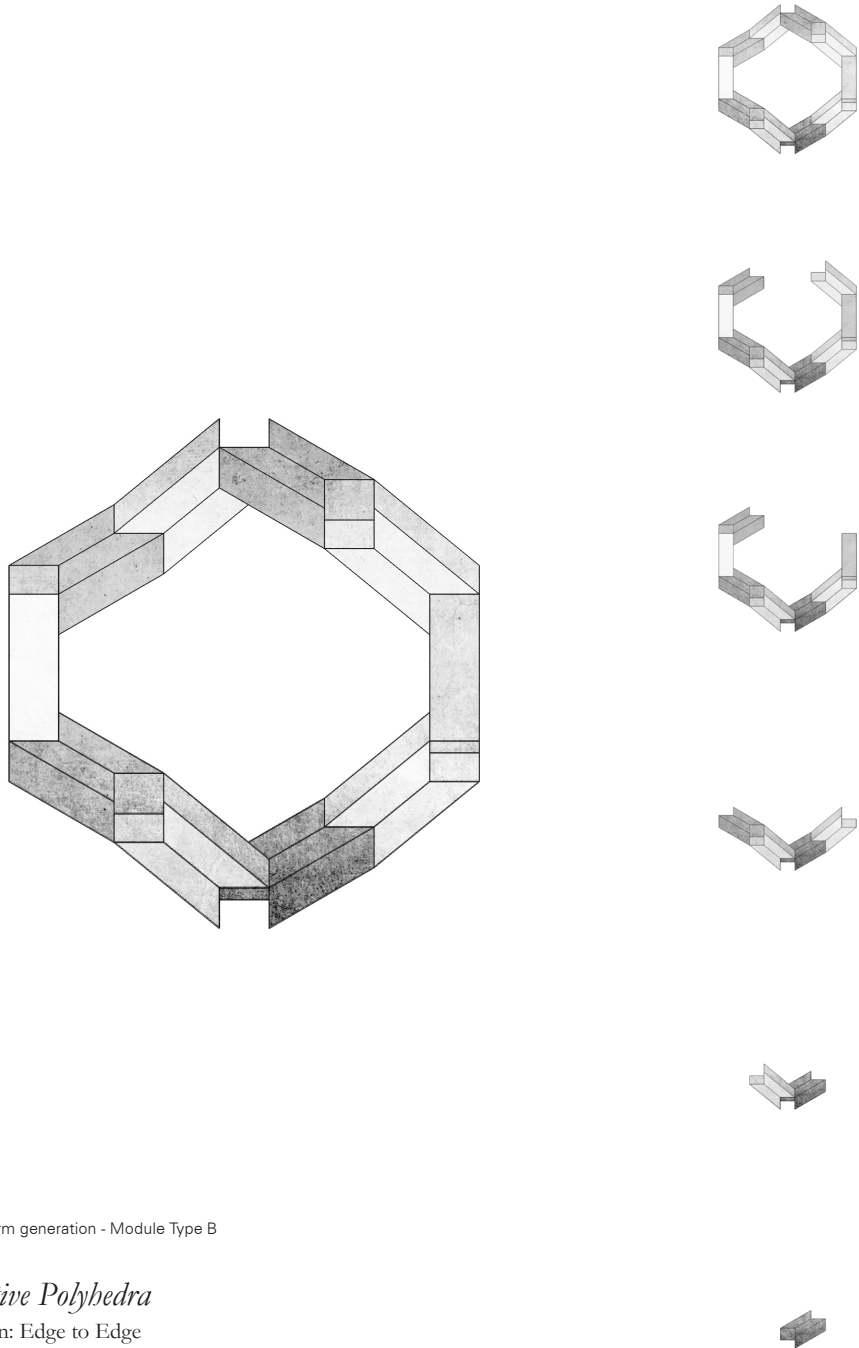

Figure.31: Form generation - Module Type B

Generative Polyhedra
Connection: Edge to Edge

a form starts to appear...multiplying...growing...reflecting the spiraling desires of the polyhedron...

...there is hierarchal progression....unit....aggregates of units....units....larger aggregates....duplication continues....

I continue to play.....*there is no static hypothesis followed or a rational nexus...yet appears forms...revealing out from the play of hands and the modules....*

Play....allows us to open ourselves for the unknown possibilites...

after a while, I stop -

It is not the first time I have dealt with this..

Relation...relation...relations...

relations appear out of play....each face of polyhedron establishes coherent relations...

It was not just the modules...It was how they *came together...corresponding to each other...*

...this identification of these correspondences goes back to Pythagoras...

The inherent constitution was actualized in the connections between the modules

...and manifested different forms if the relations were changed –

I reflect back to the organic revelations where the relations between forces altered the form

I am amazed – relations could be generated in crystalline forms

Could they come alive then? I do not know. But an organicity could be introduced...maybe..

What do I know...

Perhaps, things don't exist...only relations exist...

4.The In-between | *from unit to body*

The experimentations in the preceding chapter offered two distinctive geometries: an organic form language that presented a glimpse of nature's ordering processes where form emerged through the interaction and interrelation between forces and matter in the two-dimensional field. The organic patterns reflect an order embedded in nature. The order manifests itself with a distinct periodicity, as each pattern 'ring' or fibre corresponds to the one preceding it, highlighting a 'rhythm' that accounts for the harmony in nature. Thus, periodicity is an emphasis on 'relations' between objects, bodies and things as they 'come together' and form connections.

The second experiment dealt with form-generation processes with a single 'unit' involving aspects of play and interaction, to develop diverse patterns in the spatial field. These modular constructions provide the methodology to develop a shape grammar that based on isomorphism could be used to represent higher complex systems that resonate in mediation – a form language that is neither organic nor inorganic but hybrid in nature. Centralized on the principals of organicism, the form languages at the Living Architecture Systems Group provide that shift, transforming the module from a mere 'unit,' into a 'body.' Here the 'unit' gets characterized as a part of a larger complex, an organization of parts 'within' its system, making it a 'near-organism.'

THE SARGASSO SPIRAL comes from the floating 'sargassum,' a genus of a large brown seaweed that attaches to the seafloor, floating in islands across oceans. Its conception lies in the reverberation of the chora, the dancing space where things merge, connect, and dissolve into 'one,' reflecting the 'coming together' of technology and nature, and the intuitive and the rational. The soil from which the spiral emerges is a tessellation of hexagons, which 'float' across space reflecting the idea of 'continuity' and the understanding of space as a continuum. The organic form of the spiral emerges out from the inorganic crystalline geometry as every 'petal' grows out and anchors to each of the vertices of the hexagon - the vertices not being the end but another beginning, launching the spiral into an array of adjacent spirals, generating a continuous whirl and a transfer of energy across the spatial field. Similar to the generative potential in the Zvilna Module, each 'body' of the spiral embodies the inherent law to which the whole structure conforms. The three-dimensional body embodies 'potential' as the ability to manifest a connection at each of the vertices of the hexagon. However, in this system, 'actualization' or the possibility to form 'relations' and connect is manifested through periodic nature. It happens as a result of the system being diverse in its modular structures. Unlike Zvilna constructions, where all the modules were isomorphic, the sargasso spiral

The Sargasso

The research adapts form languages at the Living Architecture Systems Group to construct forms that synthesize the two opposites into one. What follows is the application of 'interrelations' and the development of the 'organic' image within the inorganic. The study commences from designing a spiral to developing a family of spirals of varying sizes; leading to the development of a lexicon, knitted together to form an immersive ecosystem. The process involved designing the components followed by digital fabrication and rapid prototyping and testing of each of the spirals. The process and design supplemented the language libraries at the LASG and culminated into a testbed installation titled, *Meander* in Cambridge, Ontario, Canada.

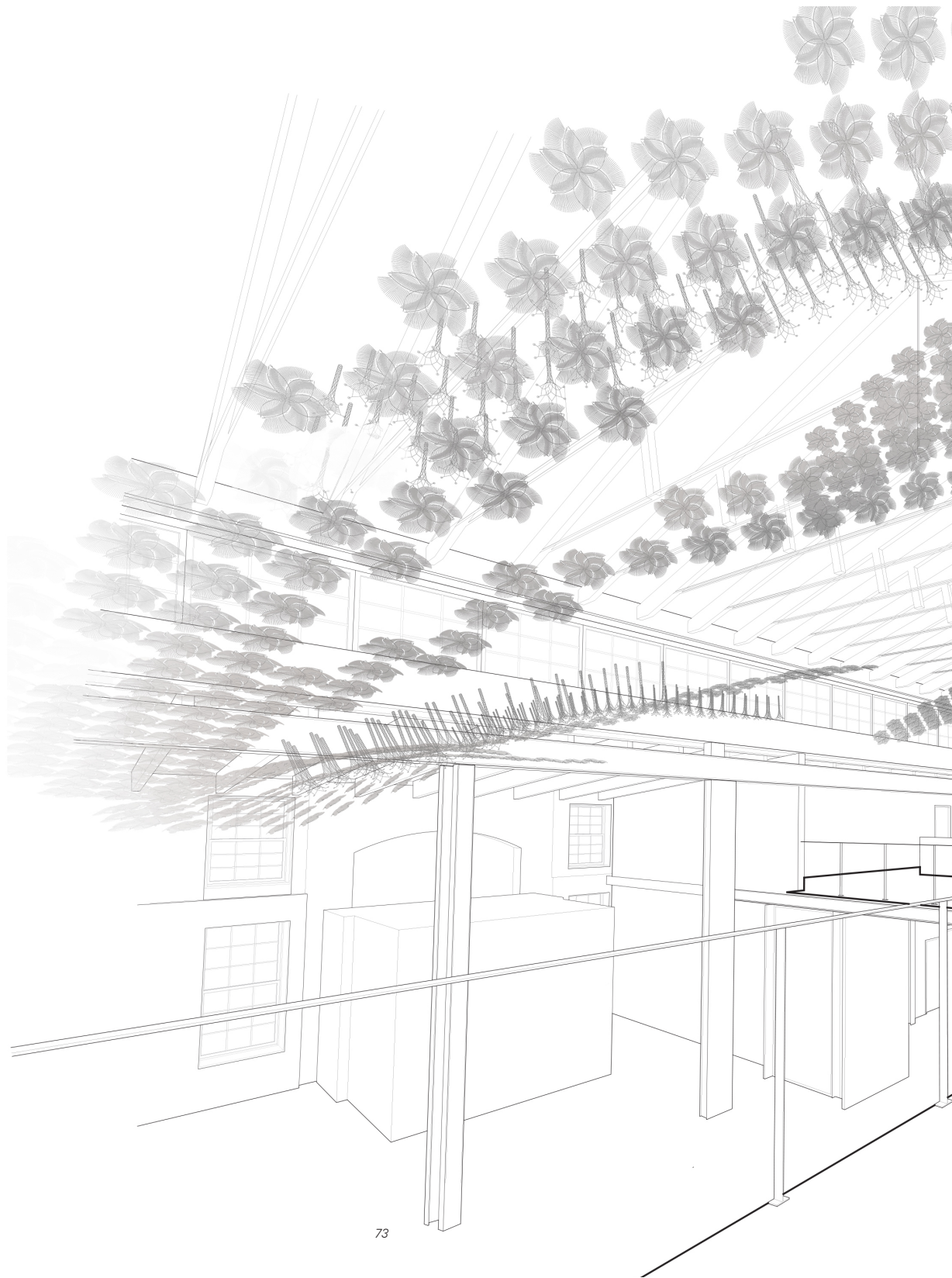

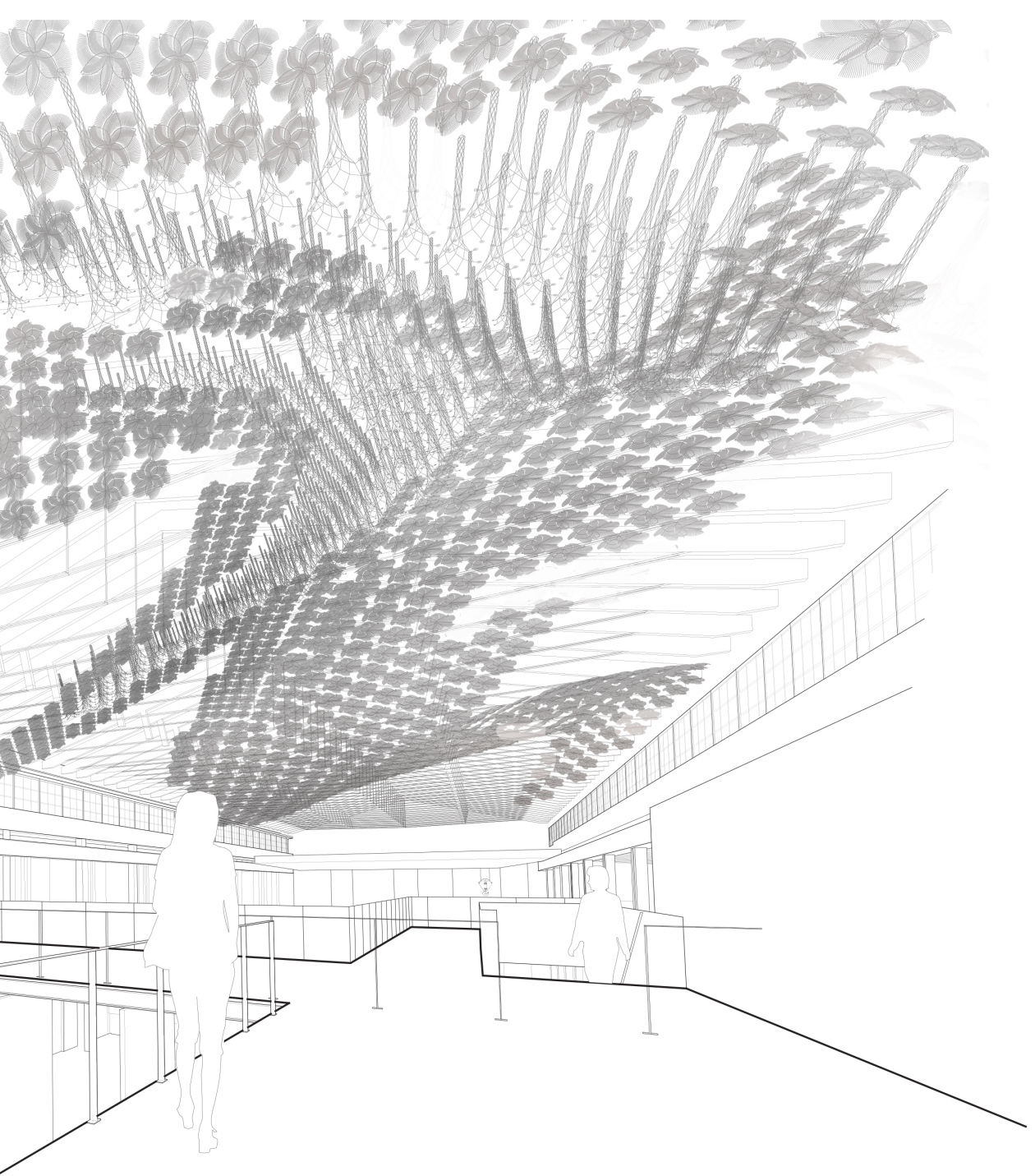

Surging Cloud Necklaces

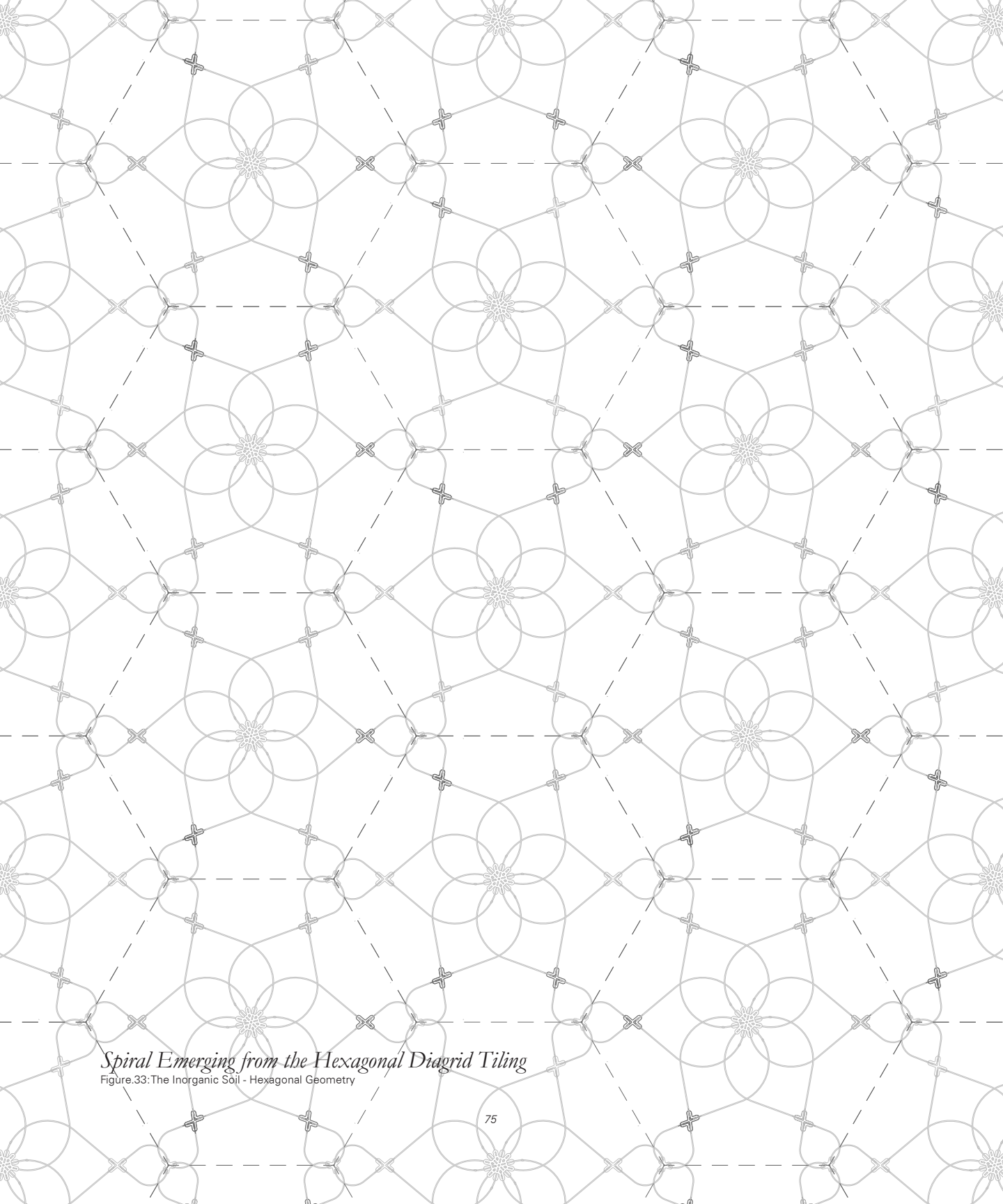

Spiral Emerging from the Hexagonal Diagrid Tiling
Figure.33: The Inorganic Soil - Hexagonal Geometry

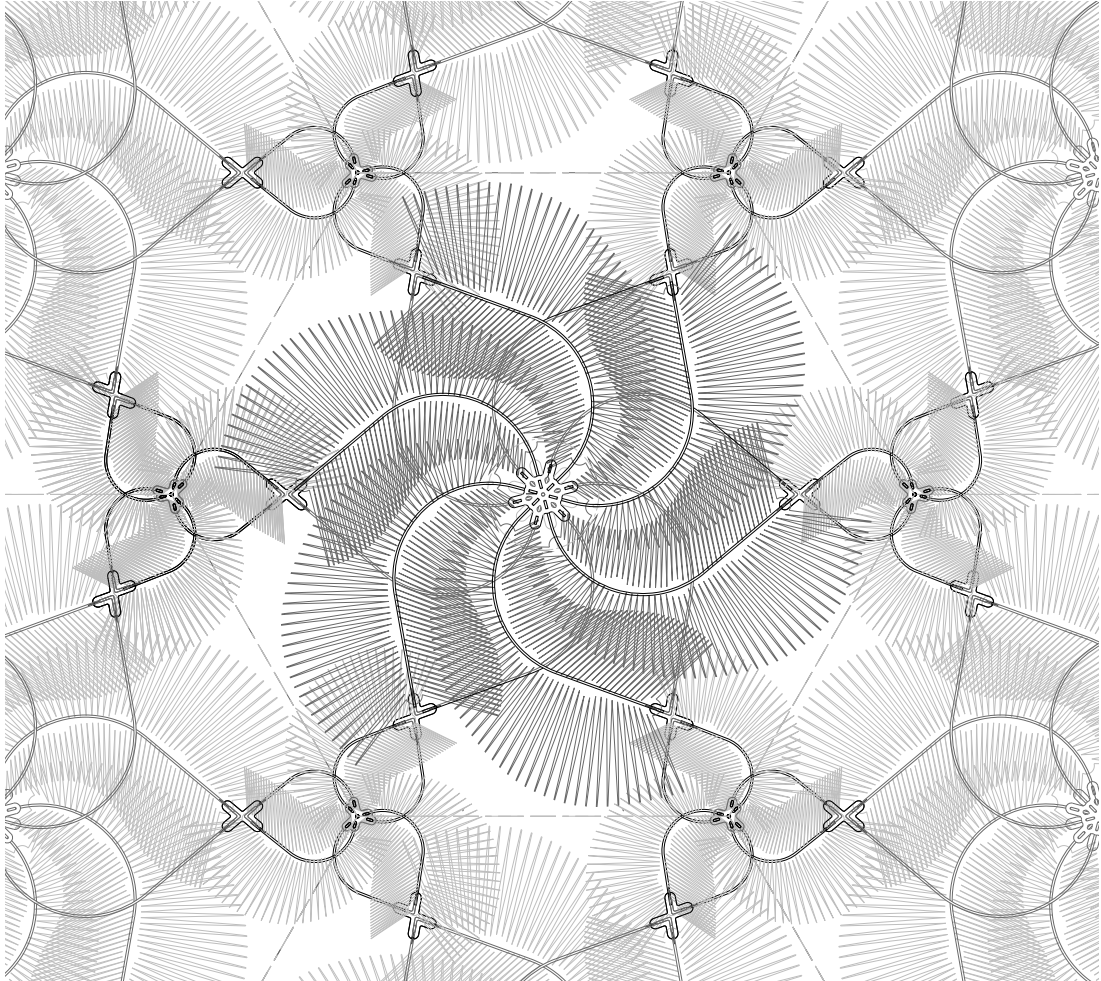

Figure.34: Organic Emergence
The Hexagonal Grid provide the basis for the construction of an organic body; the sargasso spiral

takes it further by introducing variations in its sizes. The form-generative process becomes more than repetition, an image of a gradient and growth. The analogy of the body deepens with component assemblies showing variations and adaptation to the genesis of its form (See Lexicon). It maintains its integrity of the system by growing out of the hexagonal geometry following the same condition for other sizes but offers mutations as it forms 'relations' to the system at large.

The Six-way Filamentary Spiral Formation

...crystals...leaves...nature...organic...inorganic...

*All belongs to the One...
Could then we synthesize...*

Now that I have seen a glimpse of organicity in the crystalline generative models of Zvilna...I feel
there is more to it...

*It was in late 1970's that Zvilna investigated the generative processes...almost half a century has passed...
New systems have evolved over time...technological revolution has provided new expressions...freer means...
Boundaries are getting blurred...what's living and what's not? Questions are raised...so much has changed...*

I stand now among the living systems...a simulacrum?

What has not changed?

...we can never have enough of nature...

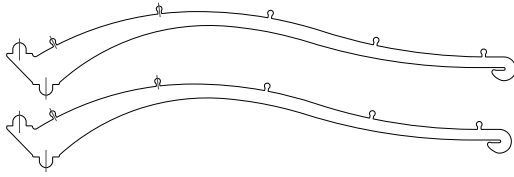

Figure.35: Component - Arms
Each arm made out of 2mm PETG (Polyethylene Terephthalate Glycol-modified), clear and less brittle form of plastic

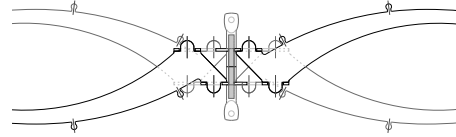

Figure.36: Section Detail
Arms knobs designed to snap fit into the spine

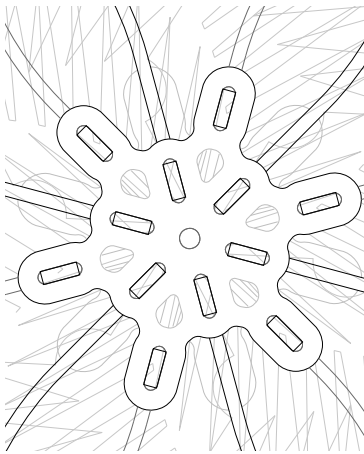

Figure.37: Component - Center plate
Made out of 3 mm Acrylic Plastic, allowing it to be more durable and stiff in comparison to the 'arms'. It acts as the central spine of the structure, holding the arms and the rest of the assembly.

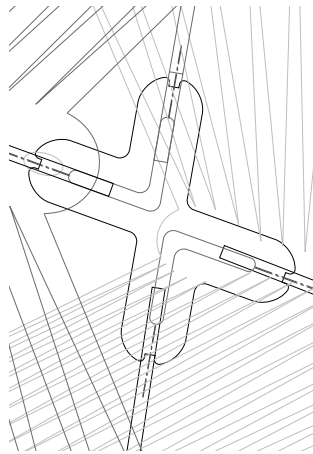

Figure.38: Component - X plate
Made out of 3 mm Acrylic Plastic, provides them higher rigidity for the interconnections of bodies. These act as the hands stretching out and holding other spirals

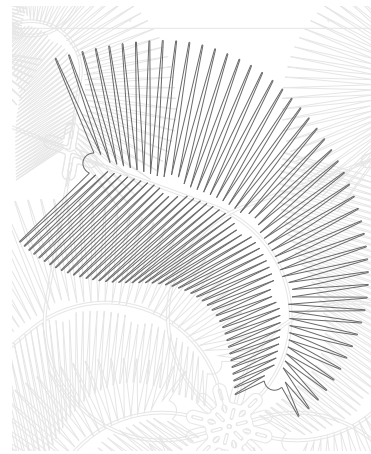

Figure.39: Component - Fronds
Made out of 0,05 mm Mylar, are light feathers that are highly responsive to the external stimulus, swaying and breathing with the movement of the air.

The Sargasso spiral emerges in an 'alchemical' construct with the representation of its 'organic' morphology yet being embedded in an 'inorganic' crystalline geometry, in its essence. It represents the desire of two things becoming one and to be separated again, and to become one again – a threshold; a 'moment' in the state of influx. The spiral draws an analogy from a biologicistic thought, constituting a skeletal system, a central spine and the outer layer of flesh, all simultaneously represented by the central core and the outer layer of fronds. Emerging from the

Components/Organs Assemblies

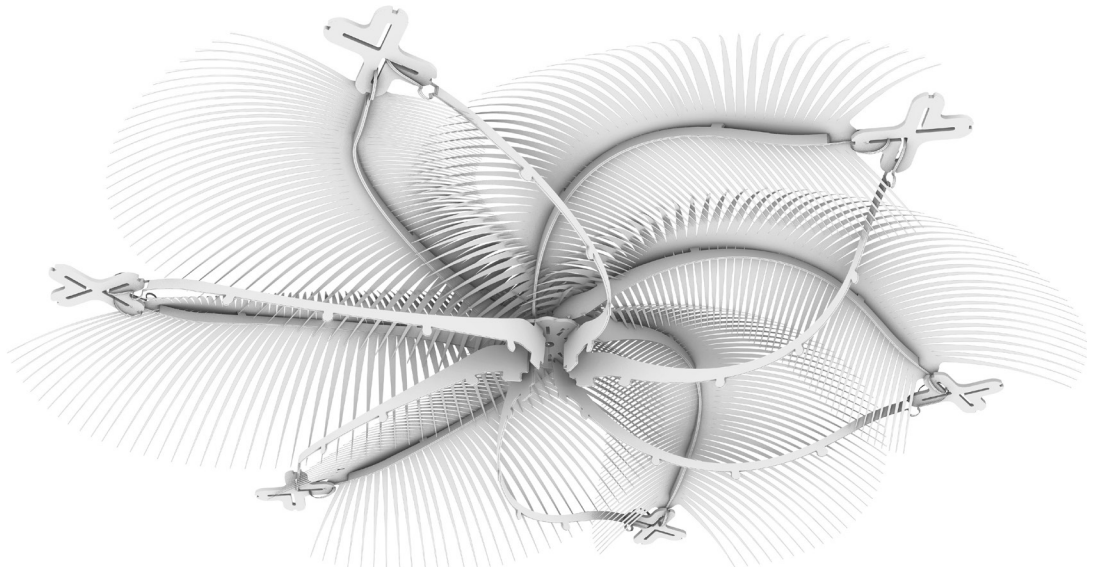

Figure.40: Sargasso Spiral

hexagonal geometric system allows it to spread across space 'continuously' into one elastic construction. Relations between components are demonstrated through the 'cavities' in the components, that work similar to a 'lock and key' hypothesis. An example can be seen that the perforations in the center plates are entirely dependent on the knobs present on the arms and vice versa. Therefore, it could be said that 'relations' between the 'arm' and the 'center plate' informed the configuration of their form. Each component of the spiral undergoes topological evolution in terms of connections and materiality. It is a constant discourse of testing and with various materials (different thicknesses of Acrylic and PETG Plastic) that allow each component to perform its 'function' effectively. The snap-fit connections between the components (center plate and arms) allow the spiral to stay intact under amplified tensile forces. For parts that compose the core, the material with higher rigidity is adapted, and for flexible components such as arms, double-layered PETG is adapted to allow for higher tensile strength.

The Sargasso Spiral

Dealing with the synthesis of polarities...there was something mysterious about the hexagon itself...

Hexagon? Why?

*hexagon... coming out of two inverse triangles...a representation of a male and female energy...positive and negative....
does it present a synthesis in its own constitution?*

It efficiently fills the space in the form of a diagrid textile structure...

Leaving no gaps...continuous....a representation of space as a continuum















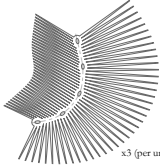



*In the hexagon are inherent codes...just like I coded the surfaces of the modules...
..each vertice of the six-way is another center point for a three-way..*

*And from the center of the hexagon emerges a spiral...a flexible meshwork stretching out in a six-way...limbs of a bird...
..an antagonistic system of clockwise and anti-clockwise arm rotation....meeting almost at each of the vertice...growing...
intervining...interlinking to the three-way....and launched into another six-way...
almost like a geotextile...inviting growth...inviting the organic...*

for a moment I thought...It could be anything

	Spiral	Arms	Center Plate	X Plate	Fronds	Washers
1200 mm		 x12 (L. Arm) x12 (S. Arm)	 x2 (per unit)	 x2 (per unit)	 x6 (per unit)	 x30 (per unit)
	Material Specification	2mm PETG	3mm Acrylic	3mm Acrylic	0.005 Mylar	1mm Acrylic
900 mm		 x12 (L. Arm) x12 (S. Arm)	 x2 (per unit)	 x6 (per unit)	 x6 (per unit)	 x30 (per unit)
	Material Specification	2mm PETG	3mm Acrylic	3mm Acrylic	0.005 Mylar	1mm Acrylic
600 mm		 x24 (per unit)	 x2 (per unit) x1 (per unit)	 x6 (per unit)	 x6 (per unit)	 x30 (per unit)
	Material Specification	1mm PETG	3mm Acrylic	3mm Acrylic	0.005 Mylar	1mm Acrylic
Large Tri-1200/900		 x24 (per unit)	 x2 (per unit) x1 (per unit)	 x6 (per unit)	 x6 (per unit)	 x30 (per unit)
	Material Specification	2mm PETG	3mm Acrylic	3mm Acrylic	0.005 Mylar	1mm Acrylic

The Sargasso Spiral Lexicon

	Spiral	Arms	Center Plate	X Plate	Fronds	Washers
Large Tri-1200/900		 x6 (L. Arm) x6 (S. Arm)	 x2 (per unit)	 x3 (per unit)	 x3 (per unit)	 x30 (per unit)
	Material Specification	2mm PETG	3mm Acrylic	3mm Acrylic	0.005 Mylar	1mm Acrylic
Medium Tri-600		 x2 (per unit)	 x6 (per unit)	 x3 (per unit)	 x3 (per unit)	 x6 (per unit)
	Material Specification	2mm PETG	2mm PETG	3mm Acrylic	0.005 Mylar	1mm Acrylic
Small Tri-300		 x2 (per unit)	 x6 (per unit)	 x3 (per unit)	 x3 (per unit)	 x6 (per unit)
	Material Specification	2mm PETG	3mm Acrylic	3mm Acrylic	0.005 Mylar	1mm Acrylic

as I occupy myself with designing each of the components...

Center plates, x- plates, arms, fronds...

...I see their topology evolutions....

each part identifies with its functional specifications...I test and adapt...

For parts stretching and turning...material typology changes to PETG...conforming to the needs of the form...

higher tensile strengths...

...creating a harmony between the character of material and its shape....

I wait...*as the laser cuts the component with a very specific distinct identity from the blank cannas...*

...out of nothing appears in front of me an organ...ready to be deployed in relations...

The components are parts...one depends on the other...

relations... it echoes again.

Each component has been detailed with small perforations...

what do the perforations represent?

potential...to connect...to come together

one change in the perforations would alter other components...

why? I ask.

They need to fit together, I hear.

fit together in harmony...

It's the reason the whole cannot be reduced to parts...

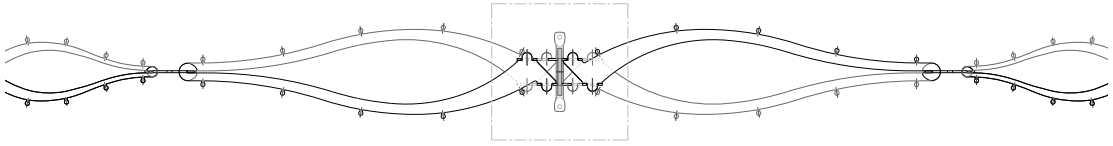

Figure.42: Unfolded Section of the 1200 mm Spiral

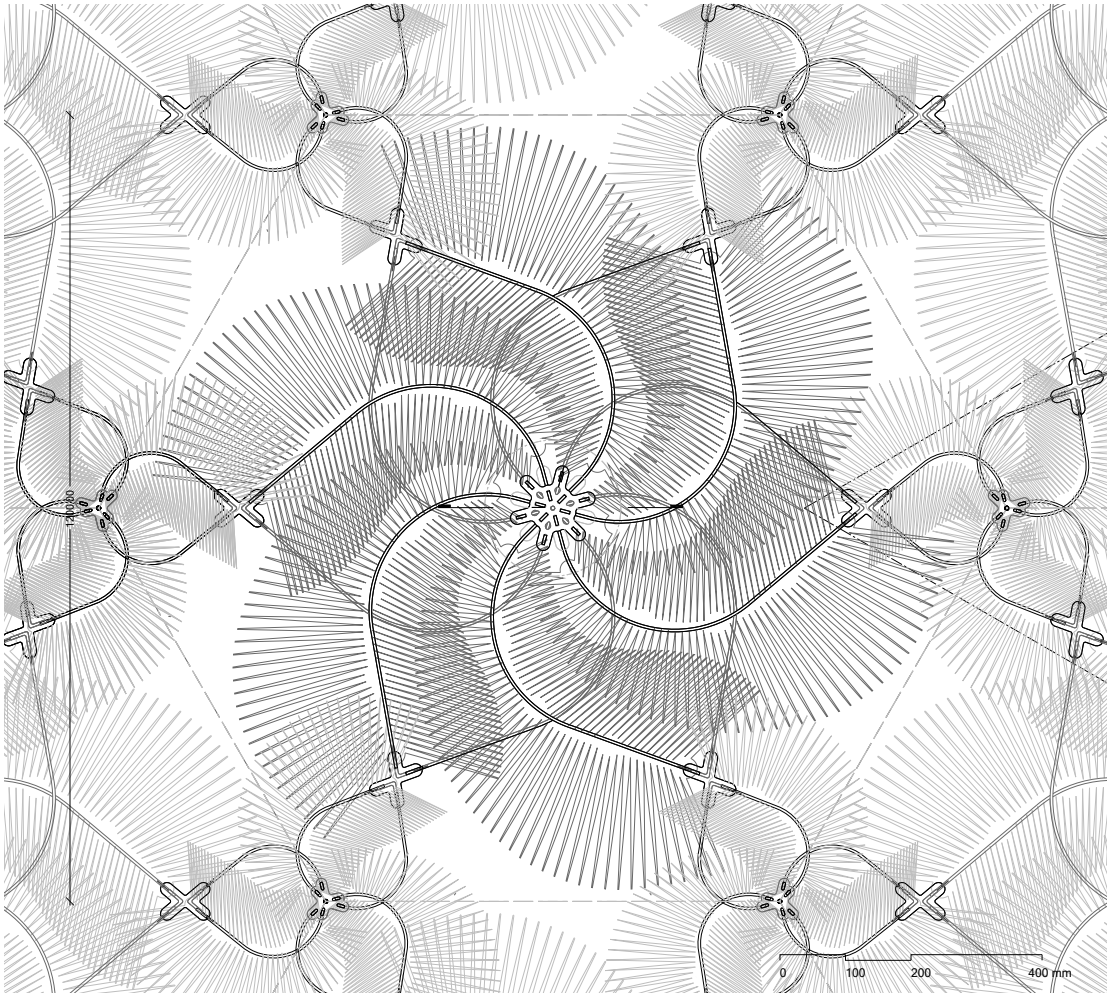

Figure.41: Sargasso Spiral Plan: Spiral inscribed in a circle of diameter 1200mm

The Sargasso Spiral - 1200 mm

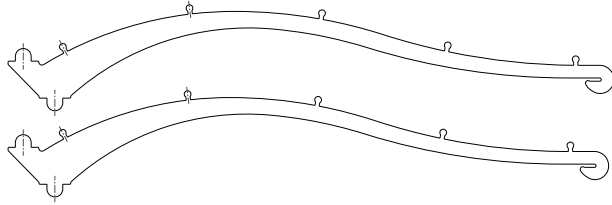

Figure.43:Arms - (2mm PETG) 1200 mm Spiral

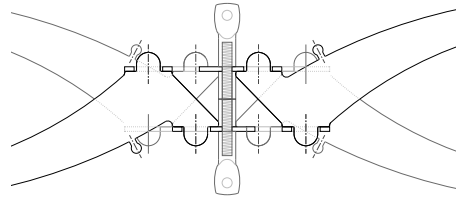

Figure.47:Section Detail - 1200 mm Spiral

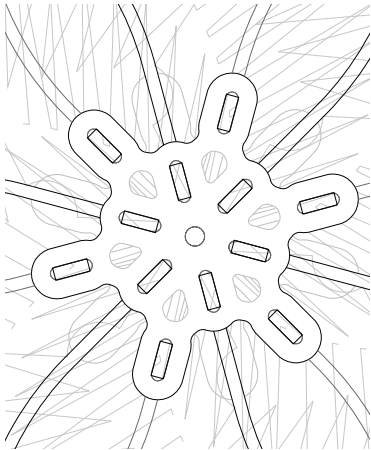

Figure.44: Center plate (3 mm Acrylic) - 1200 mm Spiral

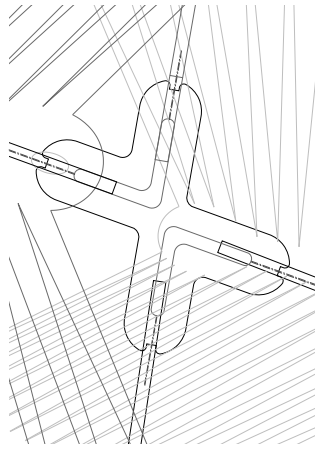

Figure.45:X-plates (3 mm Acrylic) 1200 mm Spiral

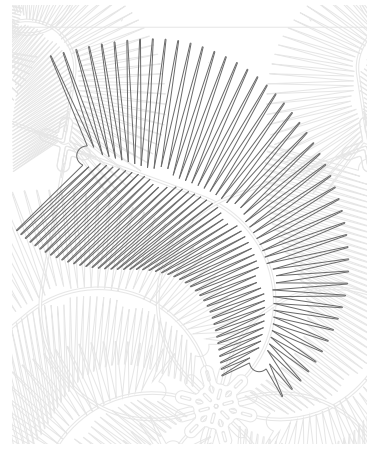

Figure.46:Fronds (0.05 mm Mylar) - 1200 mm Spiral

Component Design - 1200 mm Spiral

I start to fit together the parts..
...I realize it is more than a module...

What does it say? The more I look, the more I start to see...
A body emerging out of the hexagon, extending its arms to hold one of its other kind...knitted together...holding each other up...it is an image of weaving...like a fabric.....a geotextile...
I start to speculate...*perhaps, all values of truth and justice, resonate the same as harmony and equality,...*

I am assembling the spine
I see even the assembly has an order...stages...
Systems within systems...what does that mean?
...hierarchy of organization in nature...
Central spine, arms, flesh or frond...all interconnected...

A body...
it reveals upon me...
...the organic boundaries are permeable...

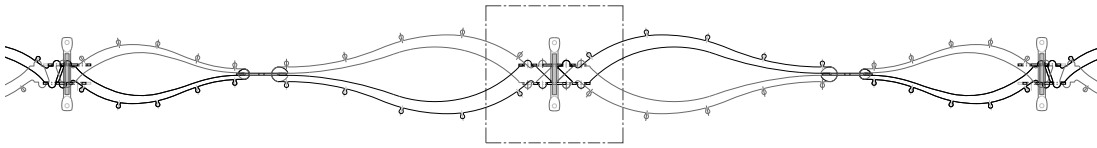

Figure.49: Unfolded Section of the 900 mm Spiral

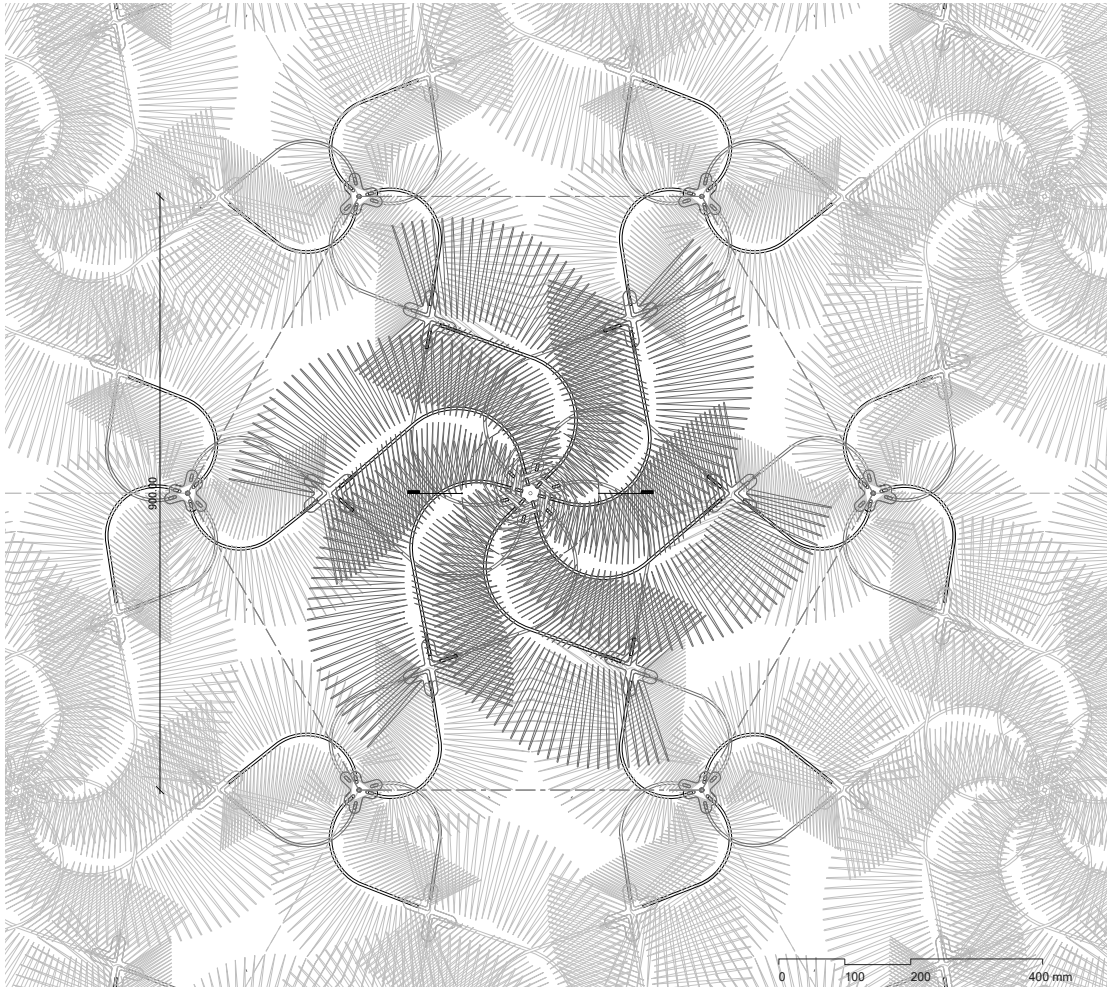

Figure.48: Sargasso Spiral Plan: Spiral inscribed in a circle of diameter 900 mm

The Sargasso Spiral - 900 mm

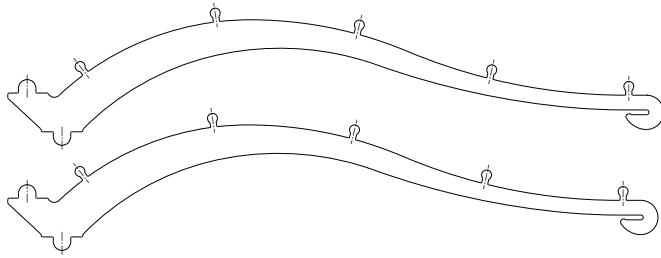

Figure.50:Arms (2mm PETG) - 900 mm Spiral

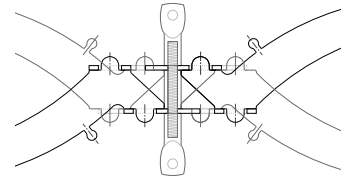

Figure.54:Section Detail - 900 mm Spiral

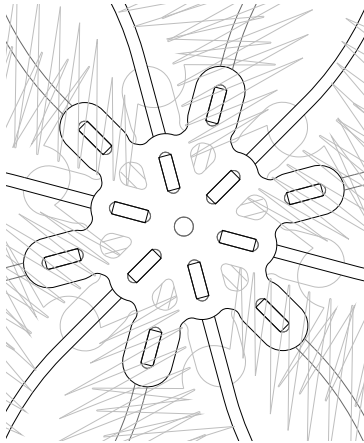

Figure.51:Center plate (3 mm Acrylic) - 900 mm Spiral

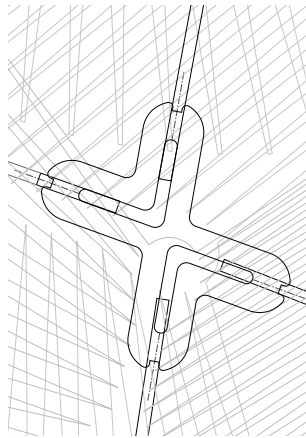

Figure.52:X-plates (3 mm Acrylic) - 900 mm Spiral

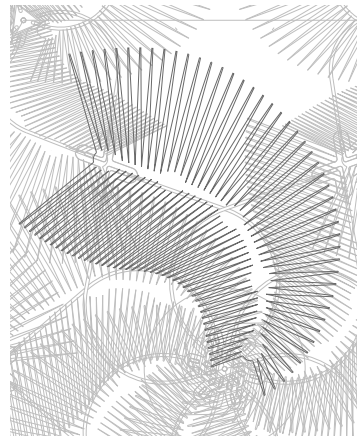

Figure.53:Fronds (0.05 mm Mylar) - 900 mm Spiral

Component Design - 900 mm Spiral

I start to develop various sizes.... *it is a vision of growth...*

I look at variations....they have scientific names...300 mm, 600 mm, 900 mm, 1200 mm...

Are those just mere sizes?

Perhaps not....

I see stages of development...

Bionic stages...

...from infancy to childhood to adolescence to adulthood...a pattern of development

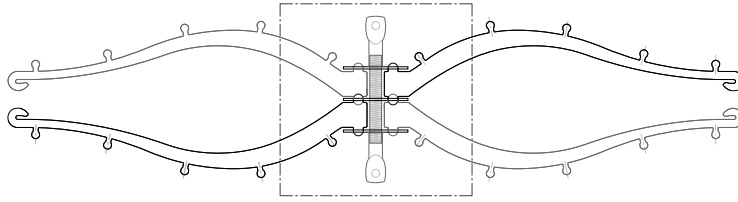

Figure.56: Unfolded Plan for the 600 mm Spiral

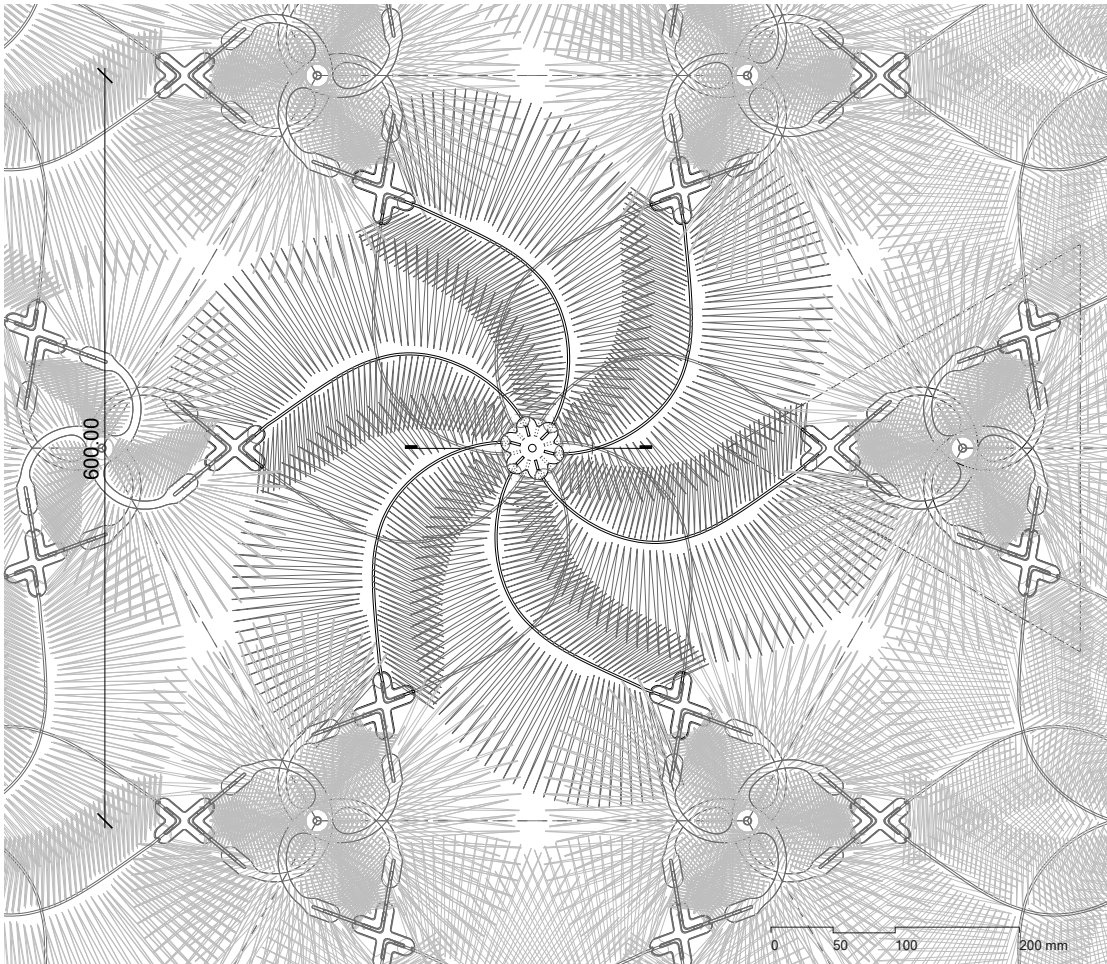

Figure.55: Sargasso Spiral Plan: Spiral inscribed in a circle of diameter 600 mm

The Sargasso Spiral - 600 mm

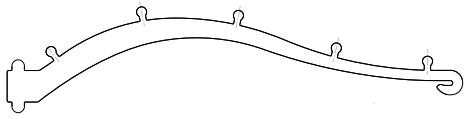

Figure.57:Arms (2mm PETG) - 600 mm Spiral

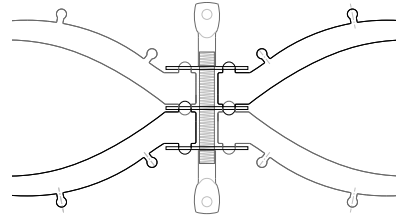

Figure.61:Section Detail - 600 mm Spiral

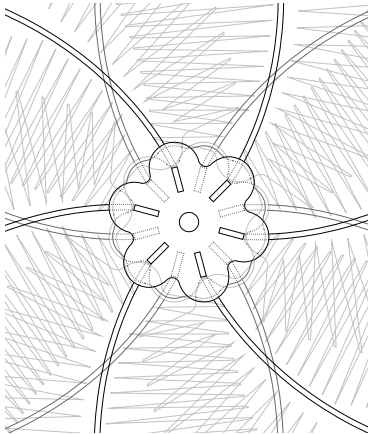

Figure.58:Center plate (3 mm Acrylic) - 600 mm Spiral

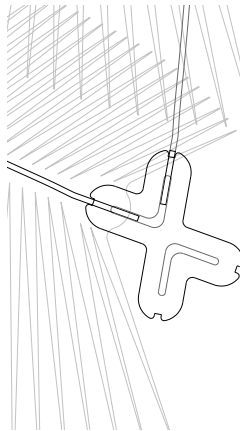

Figure.59:X-plates (3 mm Acrylic) - 600 mm Spiral

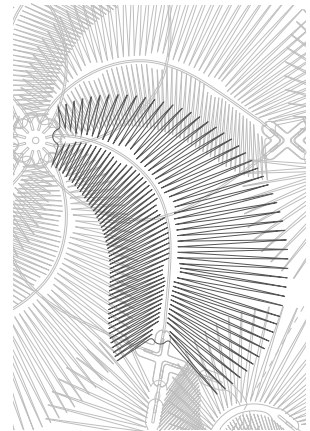

Figure.60:Fronds (0.05 mm Mylar) - 600 mm Spiral

Component Design - 600 mm Spiral

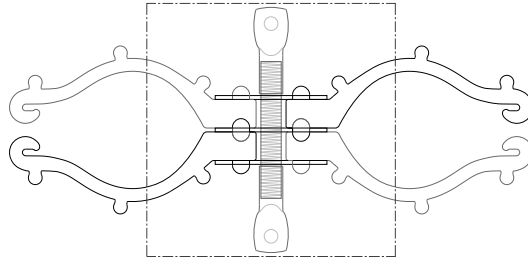

Figure.63: Unfolded Plan for the 300 mm Spiral

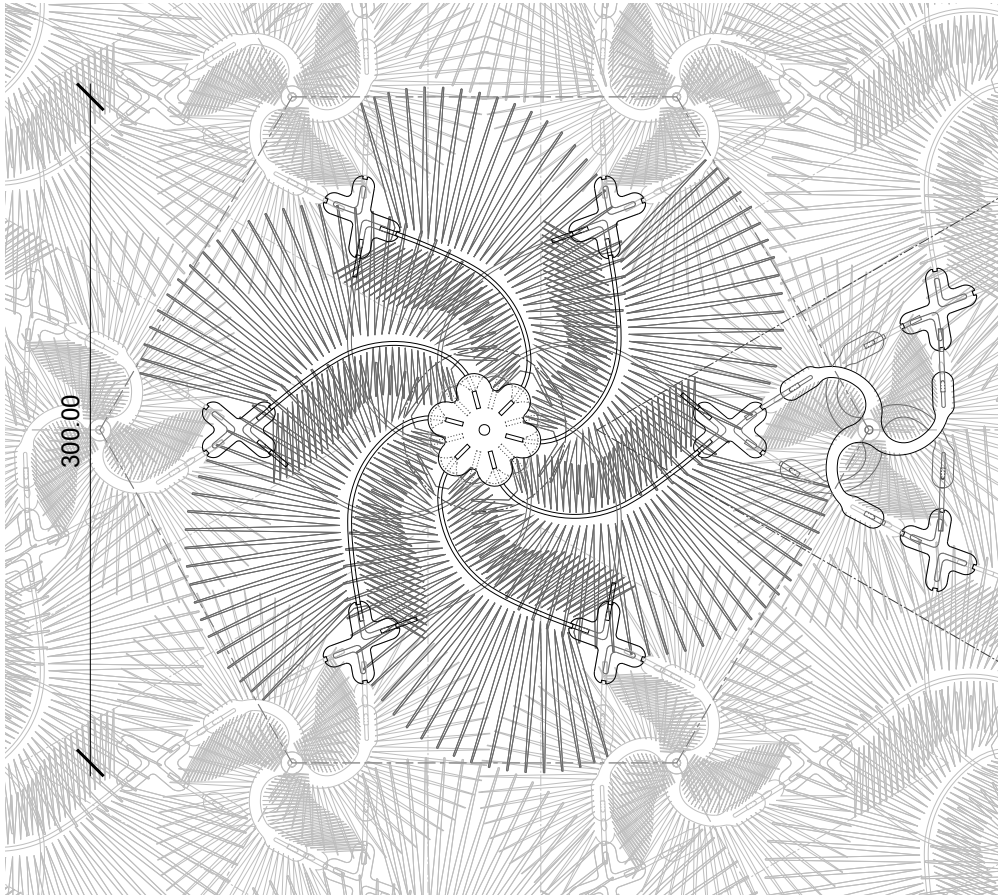

Figure.62: Sargasso Spiral Plan: Spiral inscribed in a circle of diameter 300 mm

The Sargasso Spiral - 300 mm

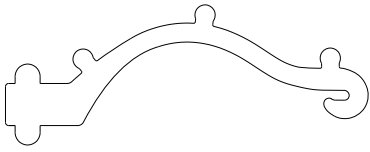

Figure.64:Arms (2mm PETG) - 300 mm Spiral

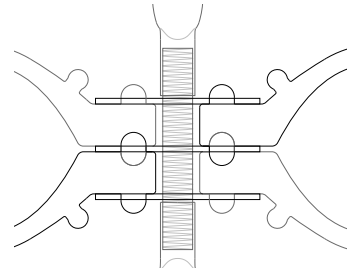

Figure.68:Section Detail - 300 mm Spiral

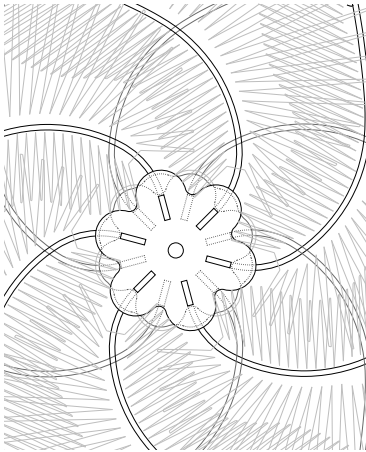

Figure.65:Center plate (3 mm Acrylic) - 300 mm Spiral

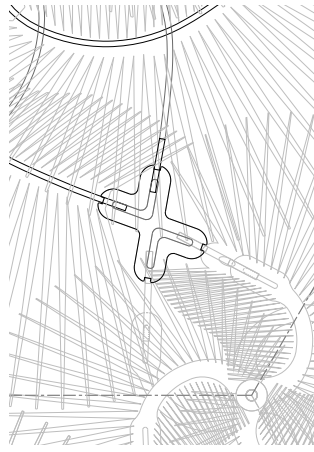

Figure.66:X-plates (3 mm Acrylic) - 300 mm Spiral

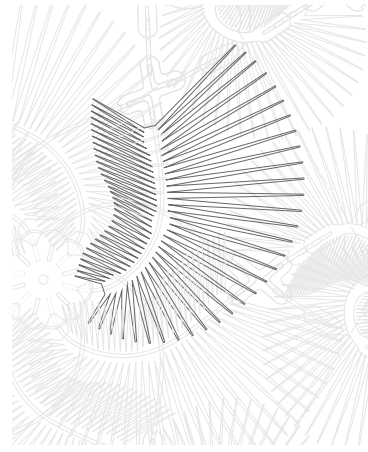
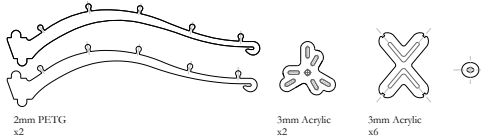
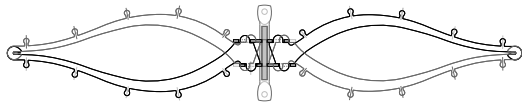

Figure.67:Fronds (0.05 mm Mylar) - 300 mm Spiral

Component Design - 300 mm Spiral

1200/900 Tri Connector



600 Tri Connector

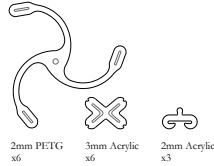
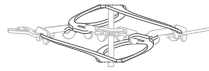

450/300 Tri Connector

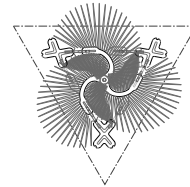
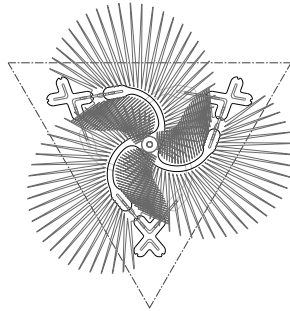
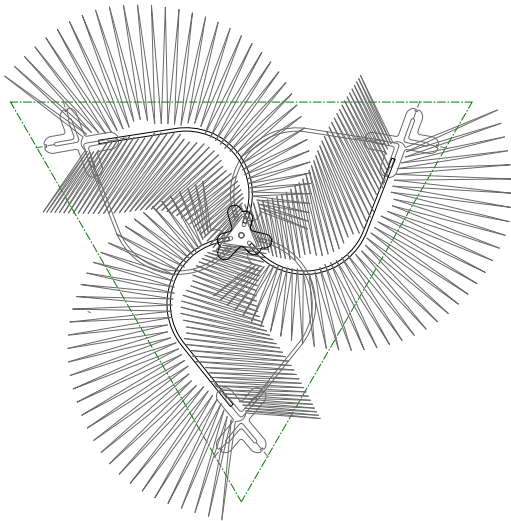
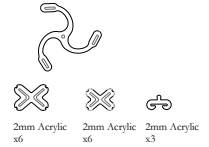

Figure.69: Tri Spiral Connectors - forming relations between 'Hex' Spirals

The Tri Spiral

All spirals are ready to be stitched...

But in what order...

Varying sizes when tessellated, resonate in different periods...

This time it's not just the relations between spirals but...relations among periods...

Relations among ethnicities...

The periods approach together...

It's like different rhythms wanting to be stitched into 'One' coherent symphony...

And appear mutations...in the components...as they adapt and embrace

There are fissures....

Pauses...

Once again...relations resonate among the cloud of spirals...as they stitch and dance in space

What do you see?

...crystallized in space is an organic melody...

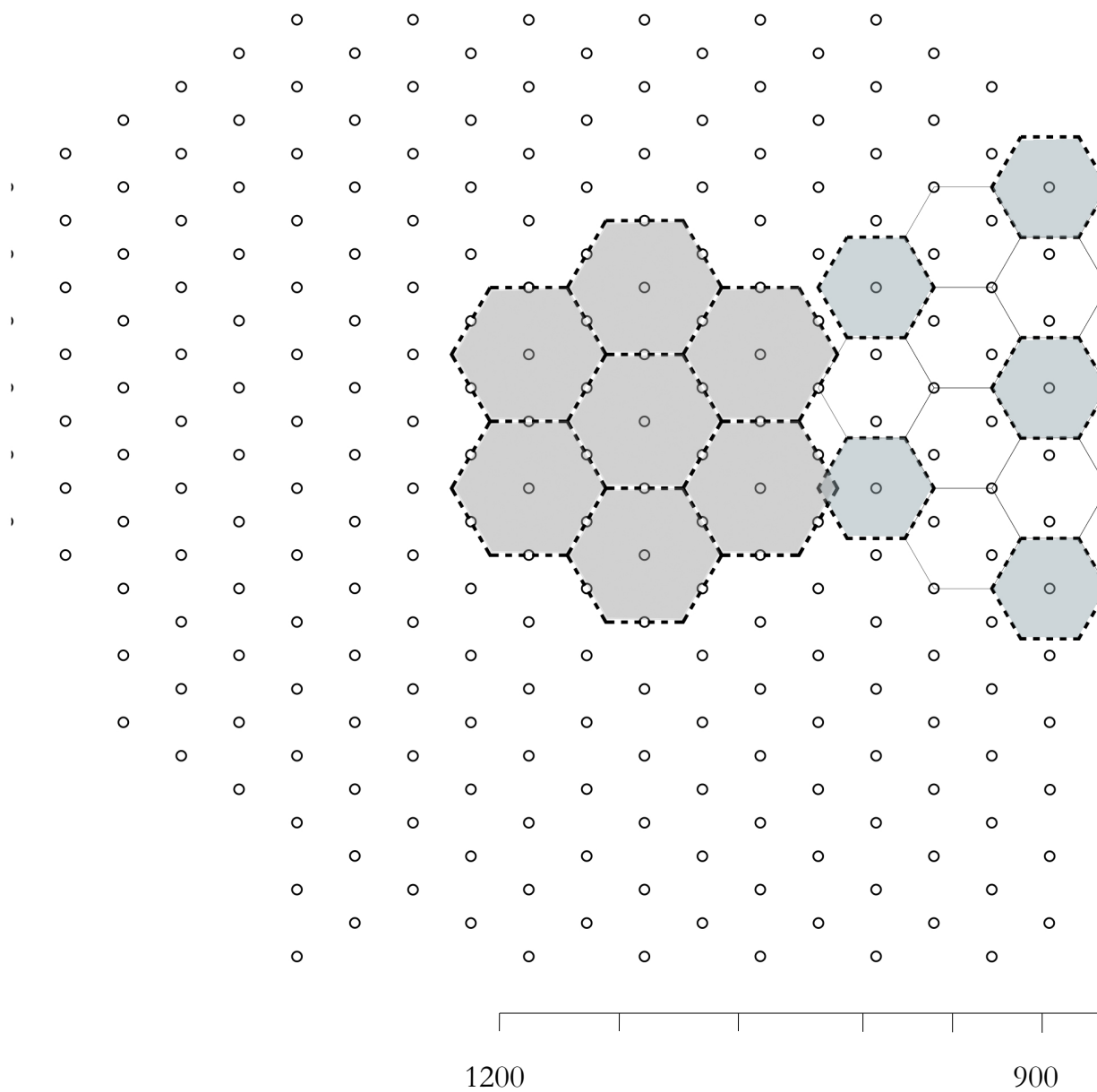

Figure.70: Periodic occurrence of different sizes of spirals

Cellular Textile Formations and Phasing - Periodic Occurrences

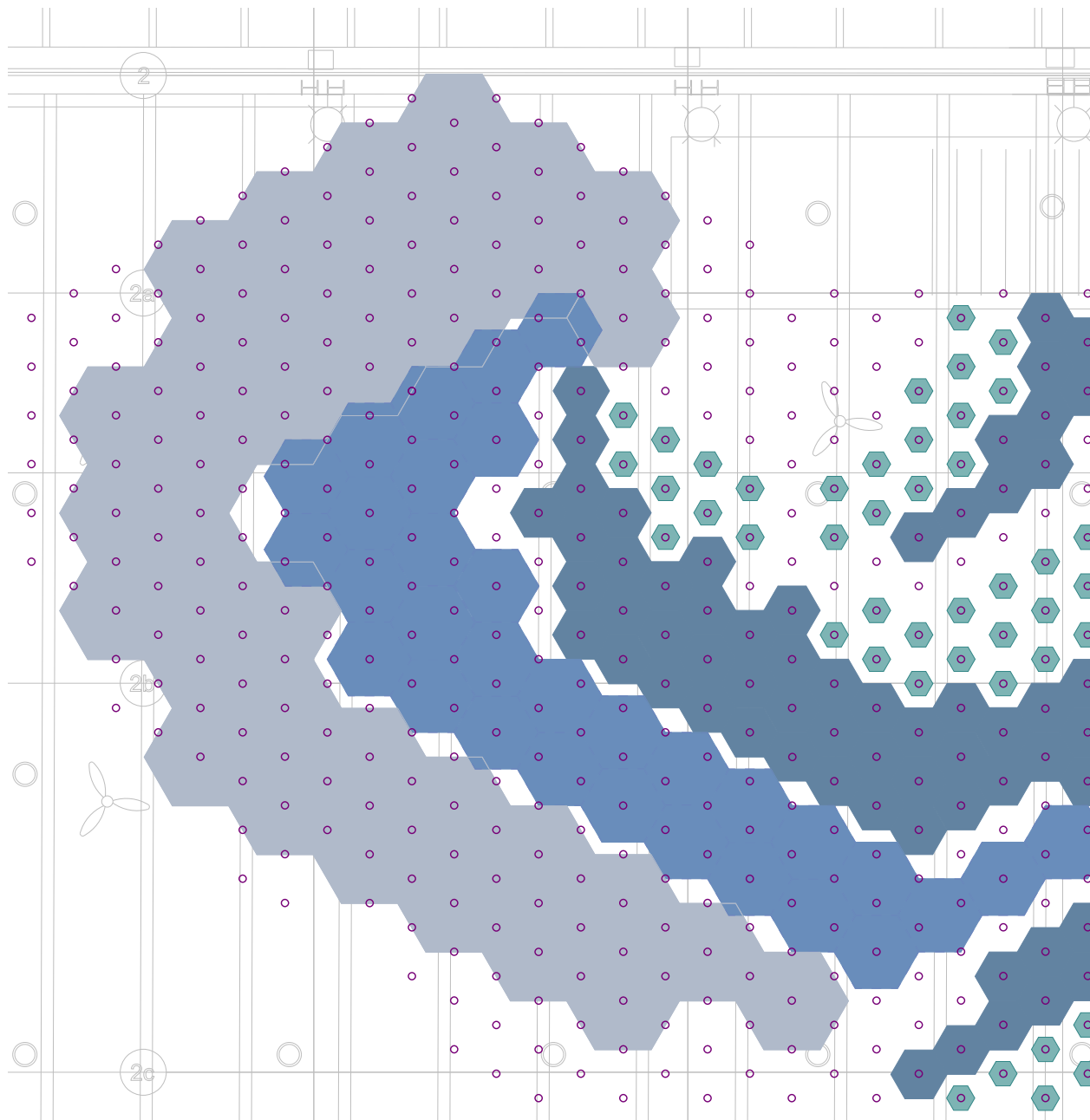
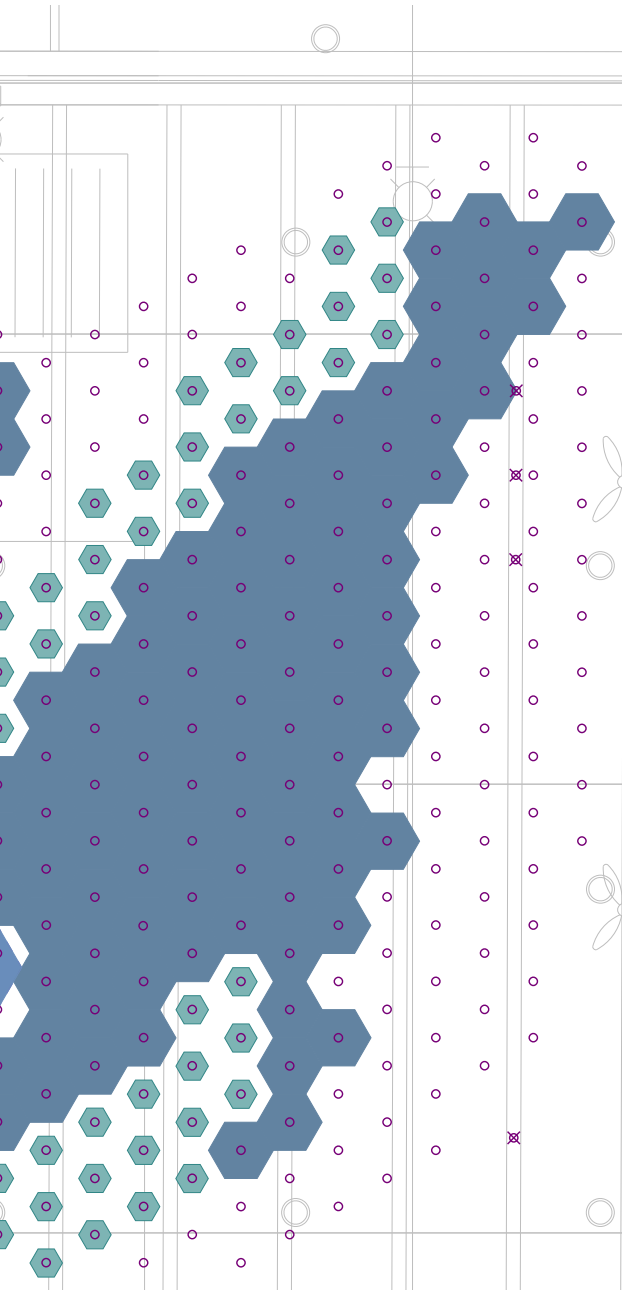

Figure.71:Cloud formation of the spirals



Tile Formation of the Cloud Fabric

The Sargasso cloud is a realization of an intrinsically dynamic cosmic web, each part carrying one another – the interrelationships and the interweaving of the spirals create an immersive ecosystem of its own. The cloud becomes a constant reflection of a moment, where it captures the periodic structure with regularly spaced spirals as in a crystal, it also renders the dynamism that is continuously building up life through its resonance of organic fronds responding to an external stimulus in the environment.

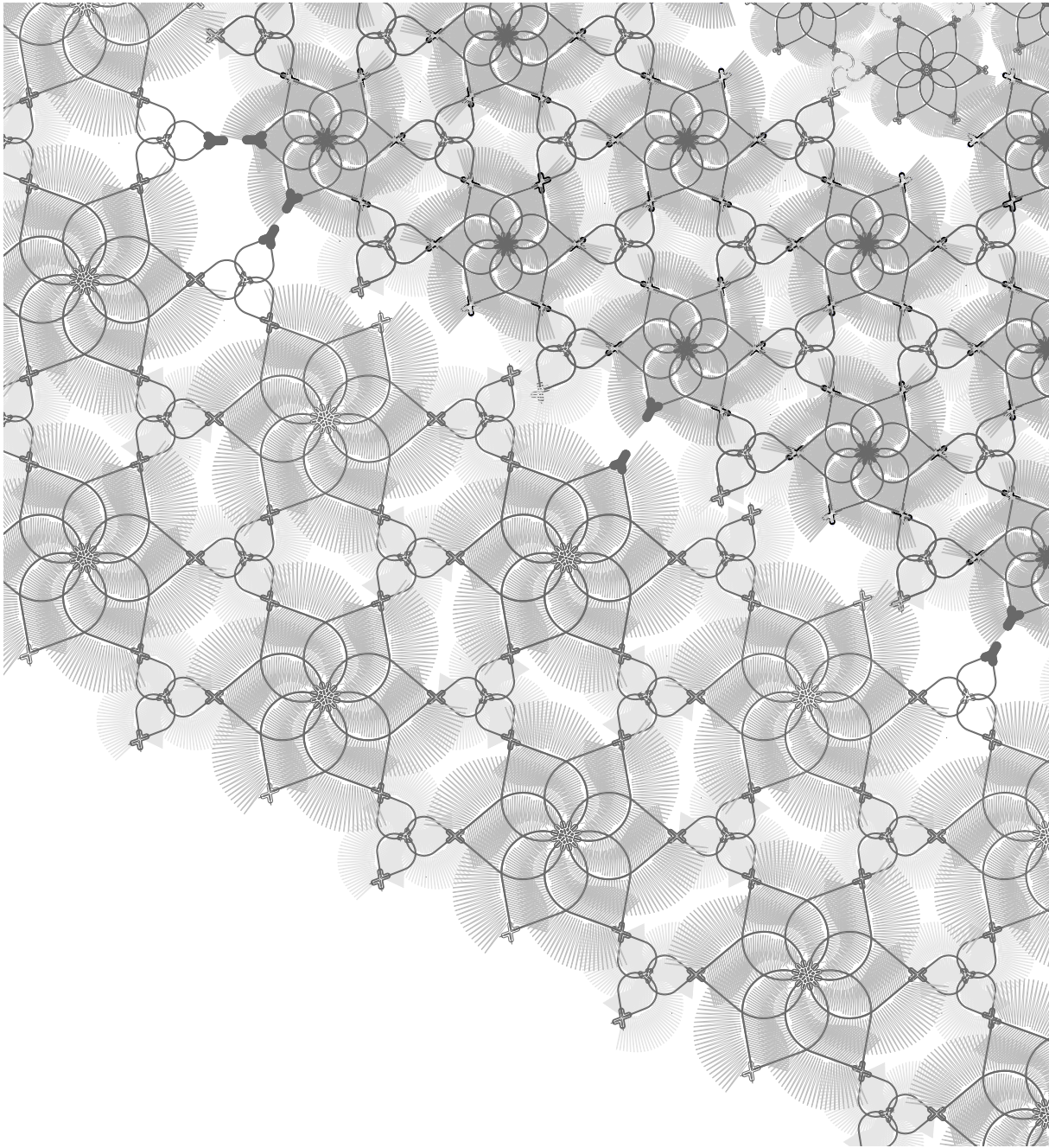

Figure.72:Quasi Periodicity
The cloud displays a quasi periodic behaviour as a result of varying sizes coming together in space - creating an ordered irregularity.

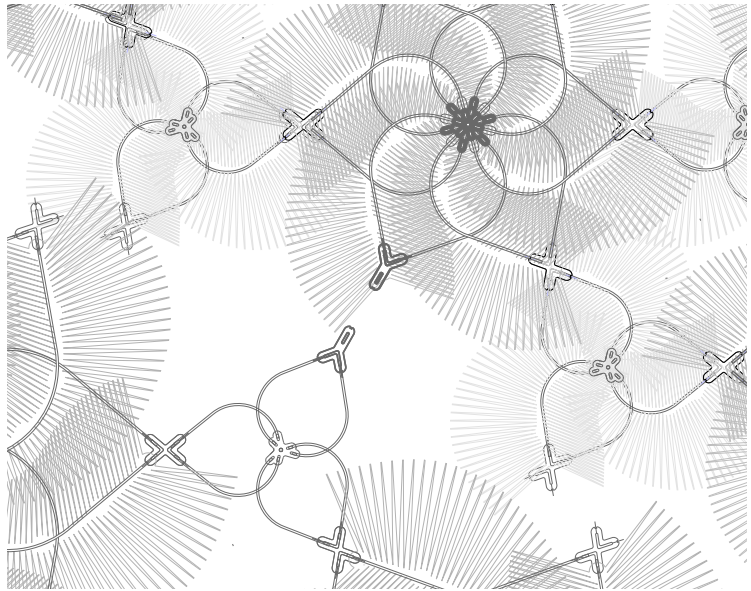
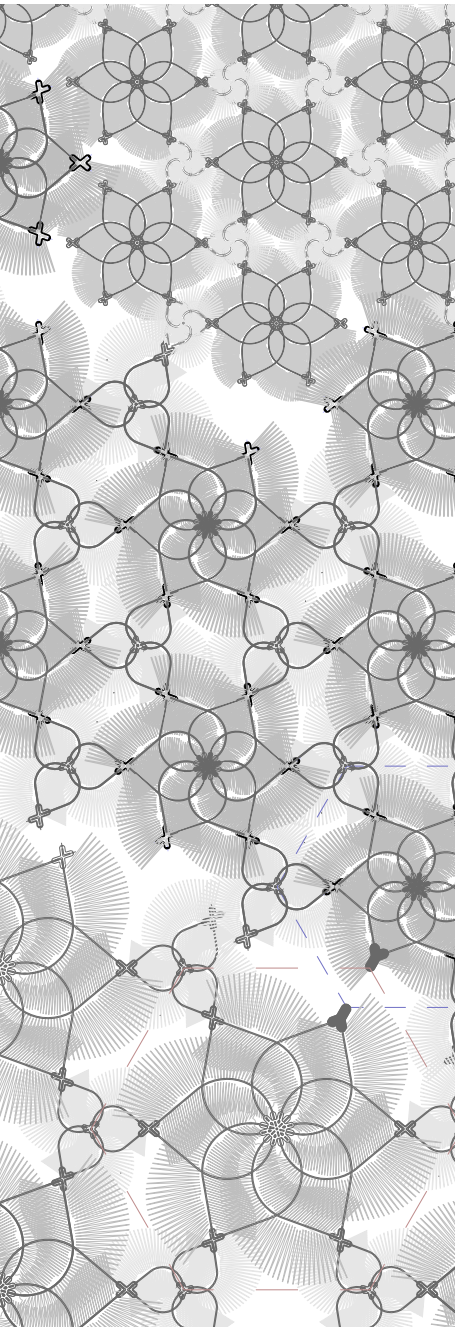
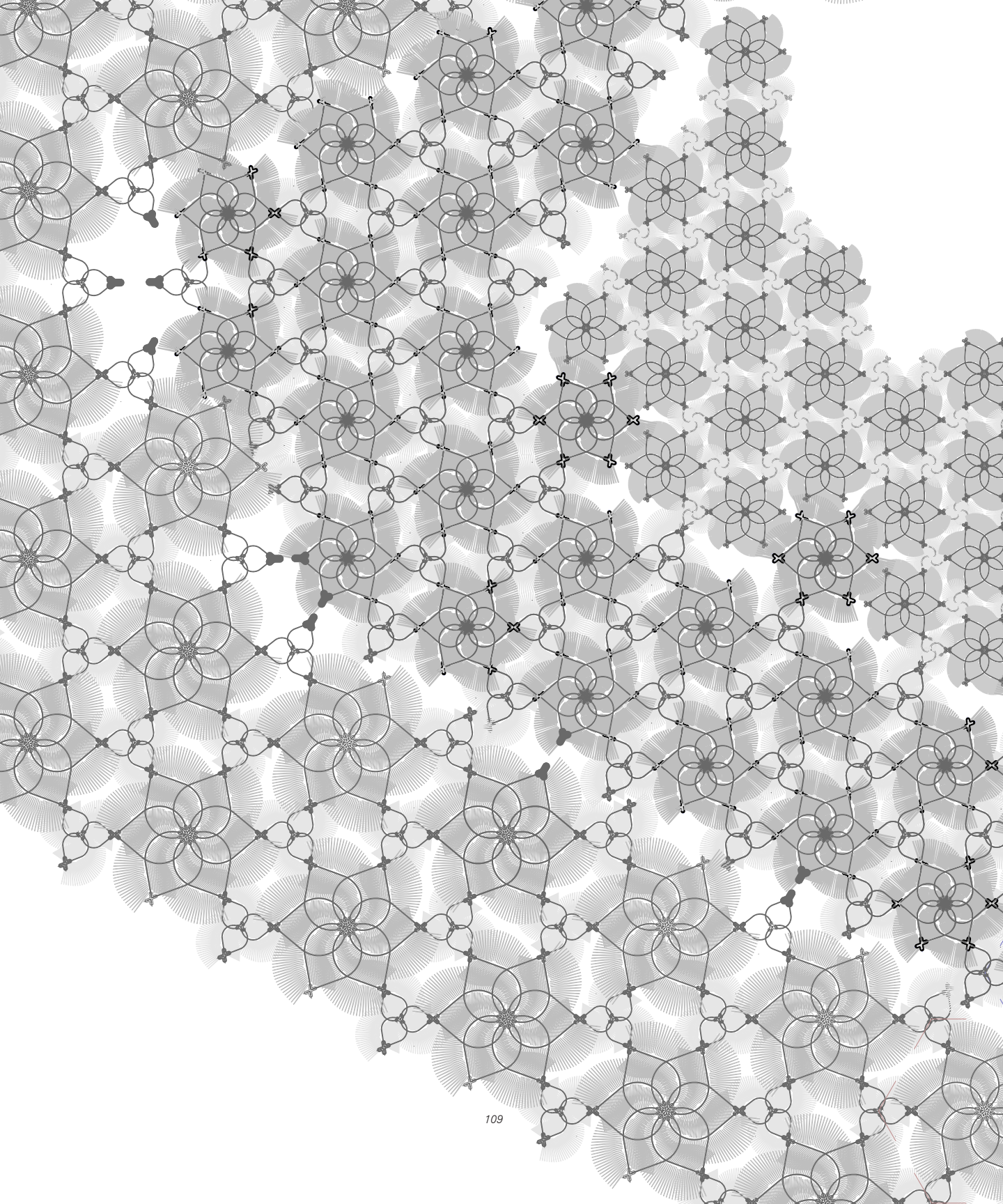
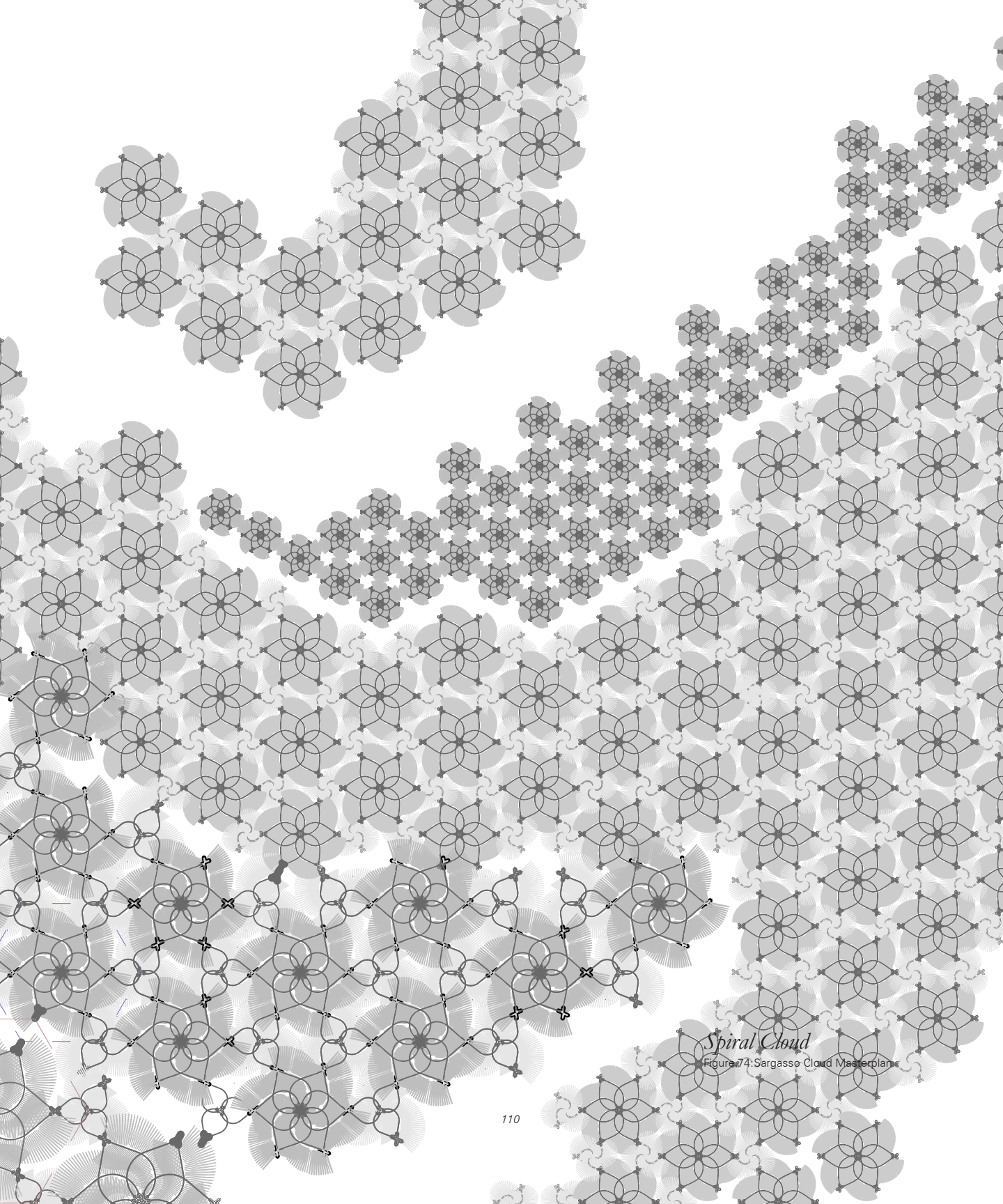

Figure.73: Interstitial Relations
 Y connections form as a result of 'mutation' at significant points stitching the cloud together

Quasiperiodic Relations

Special junctions form between individual repeating arrays representing 'age/size' groups of the family of spirals. This periodicity is established by mutation occurring at significant points in the spirals forming filamentary one-way projections, called the Y-connections. These are extensions offered as a result of periodic changes eventually making the system quasi-periodic.





Spiral Cloud

Figure 74: Sargasso Cloud Masterplan

spirals have come together...*lace-like skeletal arms...swirling...*
...*some connected...some celebrating fissures of pauses...*

spirals or molecular ripples...
..swirling...transforming...
...reminds me of the organic formations...

...ripples fuzzing crystallizing taking over the space...

I see a matrix...
...a matrix of rational organization...a matrix of phenomenological feeling...

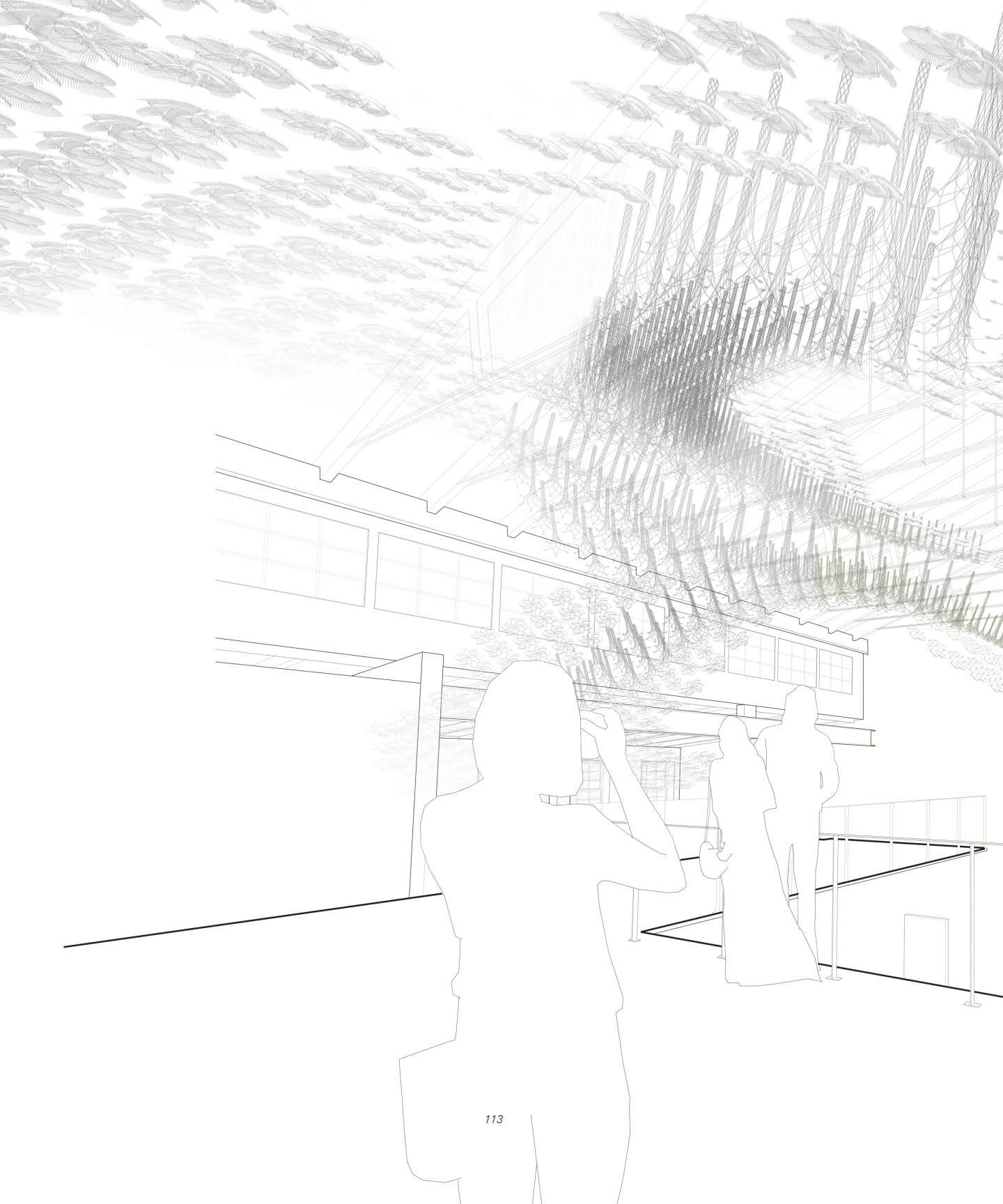

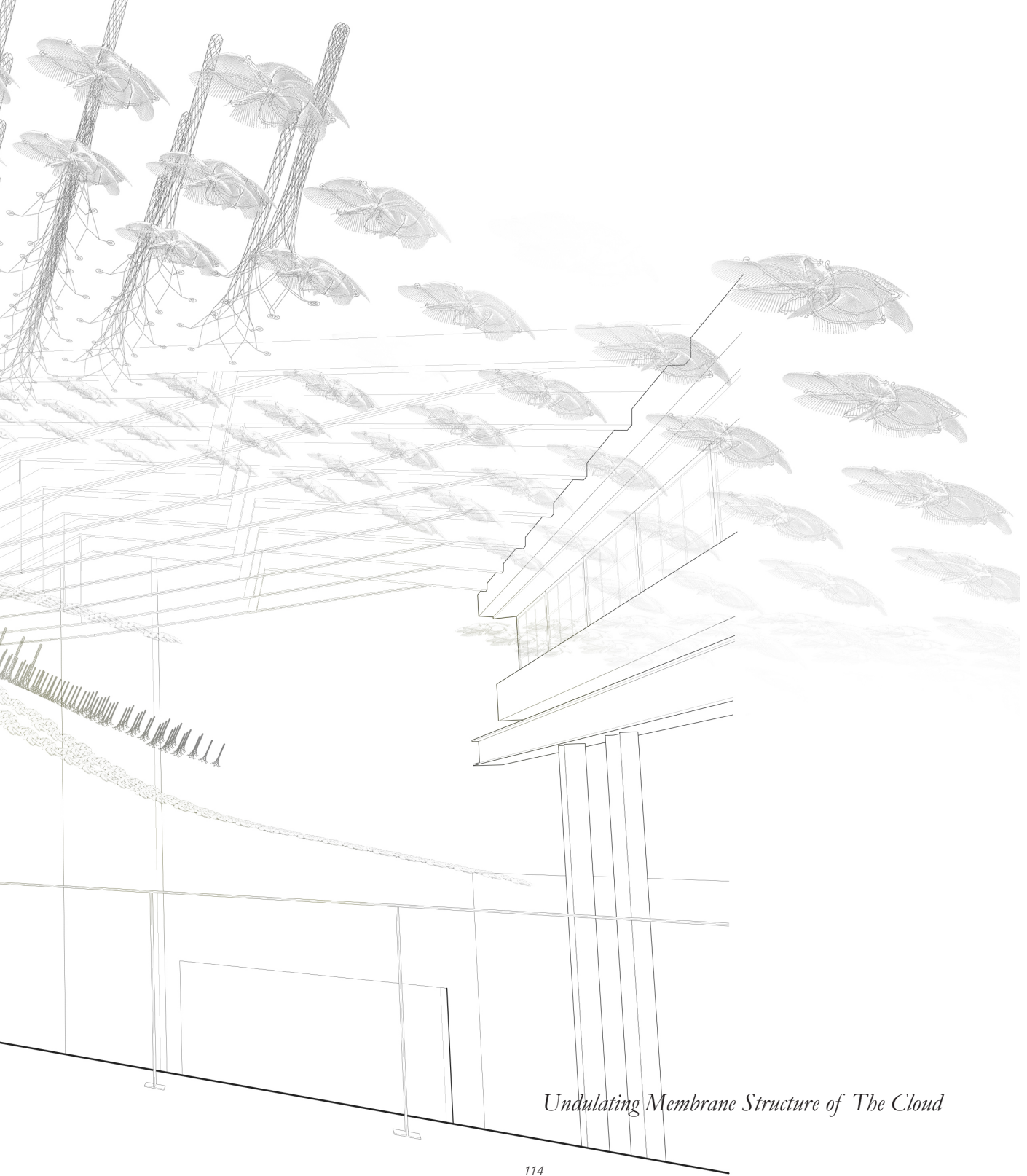

Undulating Membrane Structure of The Cloud





The cloud

...not a mere mimicry of nature lies at the threshold -
a simulacrum...in perpetual motion...contracting...expanding...an embodiment of a living textile...

staggered in time with its variations in speed as periods...*twice...thrice*
...floating in space...
inverting...jumps up-jumps down; recedes...staggers in pitch

It presents crystal materiality and reflecting light in a manifold of directions...
...becoming a metaphor for a source of life...

...a depiction of science embracing the dynamics in nature...

*with the ideal goal of surmounting the opposites...emphasizing the synthesis of rational understanding as well as the
mystical experience of unity*

5. Mediation | *intuition & rational*

Following the creative discourse, there was a need to look for parallels in the architectural context that inform this union or perhaps present an outlook into the synthesis of empirical and intuitive thought as exemplified in the geometric creations. The use of the words 'rational' and 'intuition' will be examined here in the capacity of architecture to synthesize the spiritual with the scientific world. Among the fragments of modernism, German Expressionism and Russian Constructivism offer a great deal of opportunity to re-confront and re-open the sealed doors between art, architecture and science. In the context of this study, one of the most interesting early twentieth-century figures to study is the German Expressionist, Bruno Taut, who built a series of built and unbuilt projects in affiliation with Paul Scheerbart, a literary phenomenon at that time. Taking up Scheerbart's fantasies for the utopian world and obsession for glass, Taut initiated a series of letters titled 'crystal chain,' where 'crystal' was a symbolic representation for transformation, metamorphosis and transcendence, while the analogy of the chain presented the idea of a 'fixed' connection between the human world and the divine; a 'continuum' which rendered the two as one 'merging' being.

Influenced by the ideas of the German philosopher Meister Eckhart, Taut's idea about architecture was about giving form to what Eckhart called the *Seelenfünklein*¹³ – the spark of the soul through which the mystical union of God is made possible. In Taut's belief, the intertwining of the rational domain and the intuitive domain, now often considered as quite separate and distinct, was itself the key to the understanding of the new fantastical architecture. He wrote: I believe that all spirits, the objective spirits, the spirits of the plants, animals, and men, the elementary spirits and the absolutely secret spirits are linked in greater unity.¹⁴

Over the course of these letters, the polarity between intuition and rationalism summarized in the debate over faith versus form which culminated with the following argument: form was secondary to faith and intuition and would emerge of its own accord if and when a *suitably receptive context* were to be created by the architect.¹⁵ It is worth to mention here that the Crystal Chain group in its struggle to mediate between 'practical' design and the 'unreal' imaginative utopia often overlooked 'context' in its entirety. Thereby only focusing on the imaginative representations of new materials and its explorations. Their discourse was endowed with 'expression of freedom' with no consistent language of forms, ranging from soft

13 Whyte, Iain Boyd. 1965. "The Crystal Chain Letters : Architectural Fantasies by Bruno Taut and His Circle." In *The Crystal Chain Letters : Architectural Fantasies by Bruno Taut and His Circle*, by Iain Boyd Whyte, 6. London: The MIT Press.

14 *Ibid*, p.5

15 *Ibid*, p.9

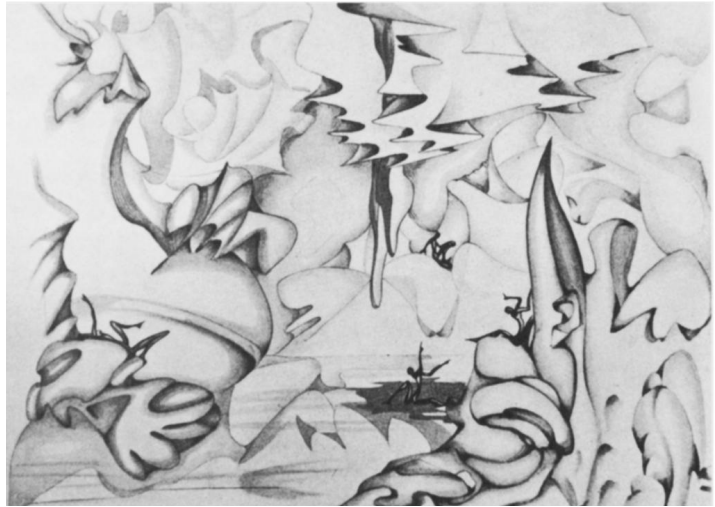

Figure.77:Hermann Finsterlin, "Interior"
(Fruhlicht, No.2, Winter 1921/22,34).

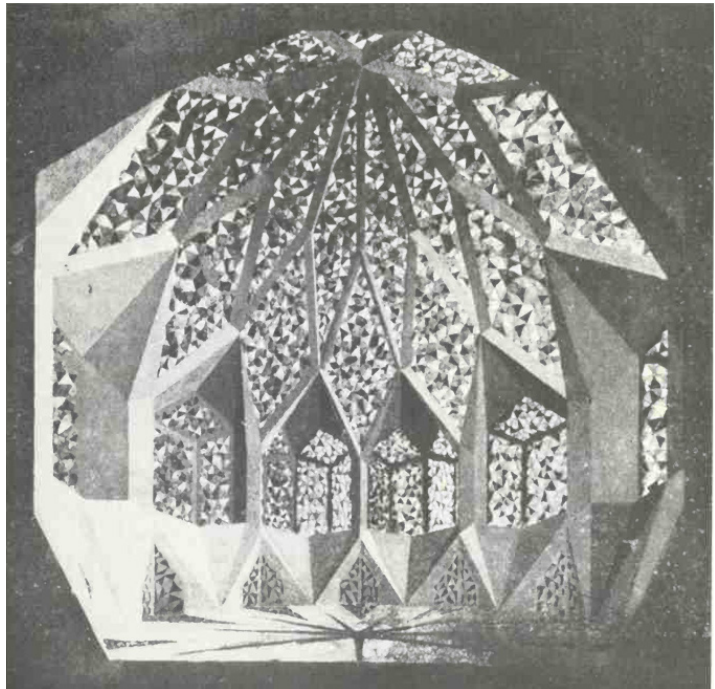

Figure.78:Wassili Luckhardt (Zacken), "Cult Building," interior.
Ruf Zum Bauen (Berlin: Verlag Ernst Wasmuth, 1920).

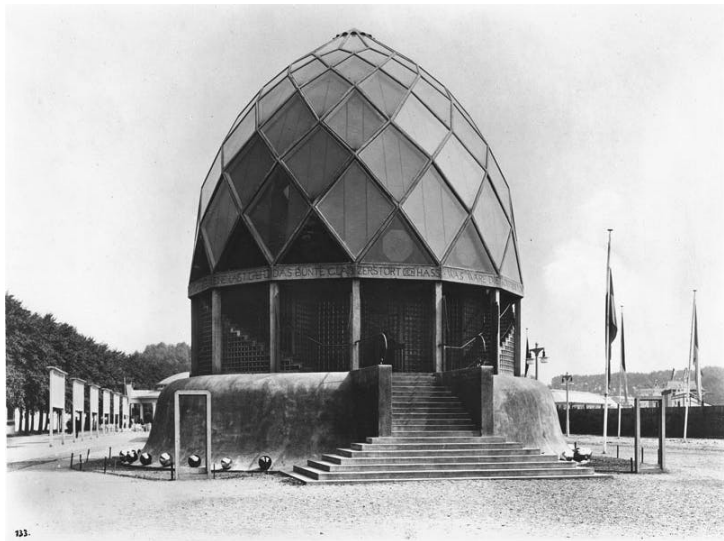

Figure.79: Bruno Taut's Glass Pavilion House at the Cologne Deutscher Werkbund Exhibition 1914



Figure.80: Interior of the Glass Pavilion by Bruno Taut
While depicting technical advancement of glass, the representation of crystal and light transcended the interior space giving it sublime quality.

16 Whyte, Iain Boyd. 1965. "The Crystal Chain Letters : Architectural Fantasies by Bruno Taut and His Circle." In *The Crystal Chain Letters : Architectural Fantasies by Bruno Taut and His Circle*, by Iain Boyd Whyte, 6. London: The MIT Press.

17 Ibid, p. 5

18 Bletter, Rosemarie Haag. March 1981. "The Interpretation of the Glass Dream - Expressionist Architecture and the History of the Crystal Metaphor." *Journal of the Society of Architectural Historians* 31.

19 Mertins, Detlef. n.d. "Glass Architecture." In *Modernity Unbound: Other Histories of Architectural Modernity*, by Detlef Mertins, 18. London : Architectural Association.

surreal forms blending into each other by Hermann Finsterlin (Figure 77) to regular crystalline geometries by Wassili Luckhardt (Figure 78) that permeated the outer world in, through its transparency.

However, the Crystal Chain letters are significant as they presented the reciprocity of the body and the soul, the physical and the spiritual being the central dogma in Taut's narrative. "Just as the body could become spirit through transfiguration, so, conversely, the spirit could be given physical, built form through the medium of the architect."¹⁶ Bruno Taut, in his quest for a new world, envisaged a 'kingdom of heaven'¹⁷ crystallized out of interpenetration (discussed later in the chapters) of mortal faith and the divine spirit. His particularly important building to mention here was the Cologne Werkbund Exhibition Glass House, an imagery of crystalline geometry that engaged the vision of Scheerbarth, evoking a new spatial mysticism. With a transparent essence to shine through and a sublime play of light and colour, Taut transcended architectural materiality in favour of a sparkling jewel, which reflected a spiritual quality, signifying a purified and changed society. It was reasonably well connected with the geometric crystal symbolism, as explained by the German architect Peter Behrens:

Crystal represented a metaphorical relationship between transformation at both the levels of macro-cosmology and the micro cosmology. Just as carbon could transform into a crystal structure under intense pressures, similarly art had the ability to transform the quotidian into a meaningful life.¹⁸

Here it is important to note that the crystalline forms and extrusions, the net and the lines became metaphors for transformation; the crystal chain group in its multi-faceted geometries suggested transformations from the inorganic to the organic world. The glimpses of biomorphic forms and crystalline fantasies with materials like glass had essentially a symbolist use of the crystal metaphor in merging the rational world with an imaginative transparent transcendence.

Detlef Mertins noted that the purpose of the Glass Pavilion was to reshape and spiritually regenerate the architectural experience while providing an immersive artistic environment. The integration of glass provided a sublime nature to the experience where boundaries and the subject dissolved and became one with the world.¹⁹ Scheerbarth and Taut's vision evoked a new sense of a technologically modified environment that changed the future paradigm of living. Mertins further summarized the 'coming-together' of the two realms:

"Glass architecture served to designate a world that was a compound – 100 percent human and 100 percent natural – the result of natural evolution and technological development rolled into one. In this world, it was understood that technologies were transparent when their technical forms were perfected so as to express their immanent logics... The geometric perfection of their morphology gave them the character of a crystal, while their capacity to perform functions and do work gave them the character of living organisms."²⁰

Later in his treatise, 'Architektur-Program' Taut insisted on the philosophical principles of 'monism' laid initially by Ernest Haeckel. "Today, there is no art. The various disrupted tendencies can find their way back to a single unity only under the wings of a new architecture, so that every individual discipline will play its part in building. There will be no frontiers between the applied arts and sculpture or painting. Everything will be one thing: architecture." Jekabs Zvilna later implied the philosophy of 'monism' and Ernest Haeckel's dissections of the natural world in his Doctrine of One and modular constructions, which will come in the later chapters.

Although the crystal chain group carried mystical thought and made an attempt to intersect the pragmatic thought with it, the later modern interpretations lacked to inherit the essential property of a 'suitably receptive' context, as quoted earlier in the study. It is evident from Taut as after the 1920s, the crystal architecture disappeared from his practice, and he abandoned the 'visionary' utopia in favour of the functionalist regime. The residue the modern society proceeded forward is left with the 'rationalist' thought, stripped of any mystical 'qualities.' To quote Scheerbart: "The surface of the Earth would change greatly if brick architecture were everywhere displaced by glass architecture. It would be as though the Earth clad itself in jewelry of brilliants and enamel. The splendour is absolutely unimaginable. And we should then have on the Earth more exquisite things than the gardens of the Arabian Nights. Then we should have a paradise on Earth and would not need to gaze longingly at the paradise in the sky."²¹

In conclusion, I pose a question; living among the immeasurable glass hills and abstract gaping meshes of steel, do these forms describe the paradise that defines beauty? Perhaps, we have gone too far in our ability to answer 'how much?' Our capacity to create has continuously been on the rise. The question of 'how to create' has been foreshadowed, as with technological advancements, we happen to transition in a time where 'anything is possible.' The need of our time is to regain and recapture the 'essential qualities' of nature and with the centric concern, "in what manner." Here, it is all the more necessary to look into the discourse of 'form' itself because this question is, in a sense, at the very root of the principal subject of this study.

20 Miller, Tyrus. 2015. "Paul Scheerbart and the Utopia of Glass." Original Scientific Article 85-93.

21 Scheerbart, Paul. 1971. "Glass Architecture." In Programs and manifestoes on 20th-century architecture, by Ulrich Conrads, 31-33. Cambridge: MIT Press.

6. The state of Influx | *towards unity*

The geometric studies emulated a synthesis of essence and substance executed by virtue of play and geometric correspondence, resulting in the manifestation of complex generative forms. This chapter will draw an analogy from various sources in the history to comment on the genesis of 'form' and the synchrony of 'mediation' between the technological and the natural world, for these are not two but integrated parts of the greater whole. The word 'nature' is from Latin 'natura,' and it is a representation of essence and quality, an image of the higher being. While technology is from 'techne,' meaning the way or skill and 'logos' which relates to reason. It is the coming together of the two terms in harmony that constitutes form. But why and in what manner?

The first case looks at Plato's *Timaeus* to provide a brief analogy, in a general sense, of the nature of the terms 'being' and 'becoming' through which the corporeal world came into existence. It is to be noted that as a whole, the platonic '*Timaeus*' provides a theory of the creation of the universe in both cosmological and theological context. As Plato describes the creation of the soul and the body and the corporeal world, there is a significant 'correspondence' of the metaphysical terms, 'being' and 'becoming,' which explains the 'process' of the creation. Being, defined as the pattern, intelligible, infinite, and indivisible and eternal, while 'becoming' as the copy of the pattern, sensible, and partible, and in time. While the two terms are significant for the emergence of the corporeal world, there is a third kind that embraces the two. The third 'state' which is the 'bridge' between the 'being' and 'becoming'; the Chora, the intermediary space or the substratum. Plato writes:

"But it is not possible for two things to be fairly united without a third; for they need a bond between them which shall join them both. The best of bonds is that which makes itself and those which it binds as complete a unity as possible...it is the receptacle, and as it were the nurse, of all becoming."²²

Chora is the soil where the realm of the intelligible or the realm of ideas merges with the realm of the sensible world. It is

22 Plato. 1888. In *The Timaeus of Plato*, by R.D Archer-Hind, 171. London: Macmillan and Co. and New York.

formless and functions similar to a mirror where the 'being' reflects itself into the world of 'becoming'; the intelligible manifests itself into the sensible. Thus the presence of 'chora' as a place of 'intermixing' or integration of the eternal matrix of ideas with the finite corporeal world is significant here; it supports the same argument set in the previous chapter which discussed the synthesis of the 'intuitive' and the 'rational.' The presence of the intermediary substratum or the interval has been highlighted throughout history. Proclus in his commentaries on the *Timaeus* described 'chora' as:

"the intellectual essence indeed is impartible, uniform and eternal, but the essence of bodies is partible and multiplied, and is consubstant with temporal representation. These, therefore, exist contrarily with reference to each other and are in want of a medium which may be able to collect them together; a medium, which is at one and the same time partible and impartible, composite and simple, eternal and generated."²³

Throughout history, whatever side one looks at these terms, one is always brought back to the same considerations and constantly sees them verified and complemented by each other. This leads us to the second case, the enigmatic *Hypnerotomachia Poliphili*, by Francesco Colonna. While carrying in it several mysteries, the treatise of *Hypnerotomachia* offers great insight in highlighting concepts of 'mediation'; rather explicit references that talk about the integration of technology and nature. This has been brought forward by Alberto Pérez-Gómez in his discourses on mediation between the 'poetics' and the 'ethics.' The treatise of *Hypnerotomachia* offers one of the earliest references in architectural discourse to 'gardens' made up of glass and fabric; a garden which is usually a representation of an organic realm transformed and depicted by inorganic materiality. This happens when *Poliphilo* (the protagonist) assisted by the two nymphs, *Thelemia* (desire) and *Logistica* (reason), travel through the organic gardens to the inorganic ones before stopping in front of the three doors that eventually lead him to *Polia* (Poliphilo's ultimate goal). One of the significant accounts of this narrative is the metaphoric projection of the three doors that present an explicit analogy of the third space; the mediating realm or perhaps the 'chora.'

In the story, the choice Poliphilo makes between the three doors (*Theodoxia* "the Glory of God" on the left, *Cosmodoxia*, "the Glory of the World" on the right, and the middle door *Erototrophos*, "The Mother of Love,") depicts a metaphorical reconciliation between the polarity of science and art, the intuitive and the rational, and the ethics and the poetics.²⁴ The middle door explains the 'mediation' which Alberto Pérez-Gómez argues, must exist for bringing the right 'order' in the modern society. It is a demonstration of the need for the reintegration of the scientific and the intuitive landscapes or perhaps an integration of the

23 Proclus. 1820. "Volume II, Book 11." In *The Commentaries of Proclus on the Timeaus of Plato*, by Thomas Taylor, 338. London: Duopage Process.

24 APPELL, J.W. 1499. *The Dream of Poliphilus: Hypnerotomachia Poliphili with an Introductory Notice, and Descriptions*. Venice: Reproduced for the Department of Science and Art in Photo-Lithography by W. Grigg - 1893.

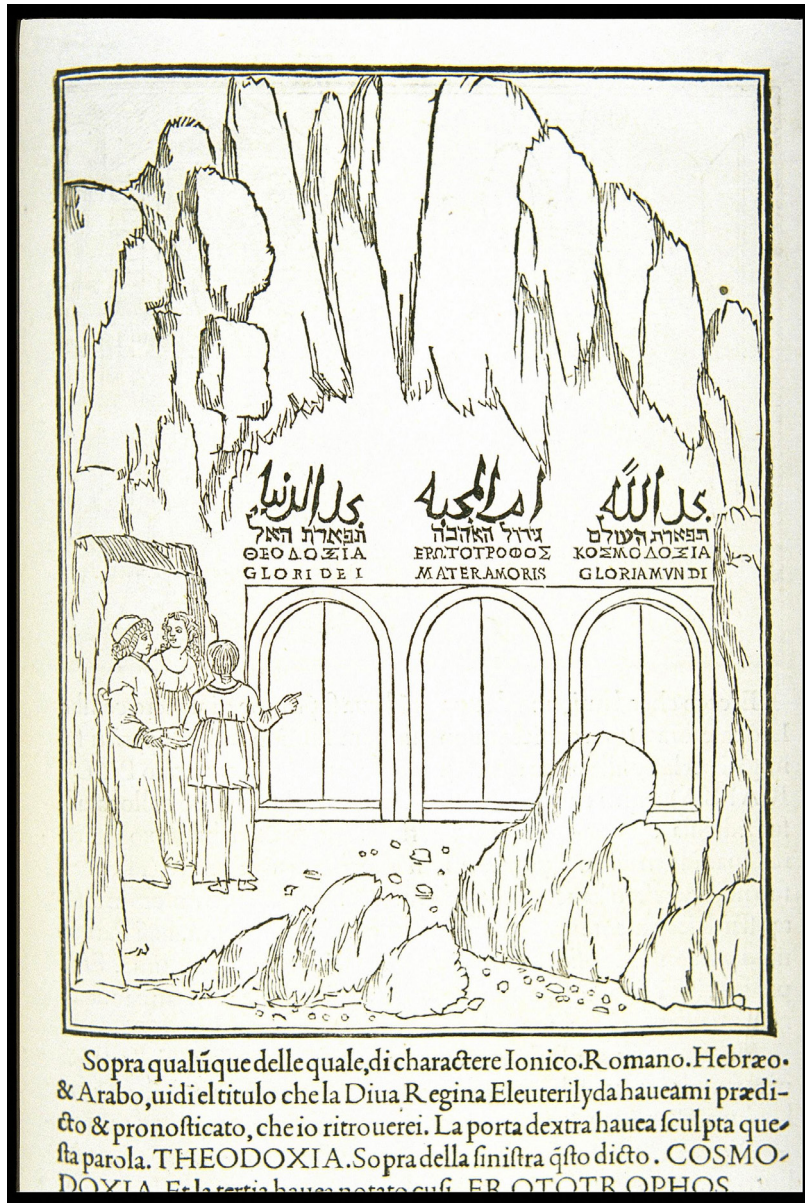

Figure.81: Three Portals from the *Hypnerotomachia Poliphili*
Poliphilo in a rocky place conducted by two nymphs to the three gates, which are cut in the living rock, with the inscriptions 'gloria dei ; mater amoris ; gloria mundi' (repeated also in Greek, Hebrew, and Arabic.)

'essence' and the substance.

Understood in the relative sense, the terms, essence and substance, and quality and quantity, are in effect the symbolic representations of the same concept as being and becoming, as discussed above. The third case offers an insight into the essential nature of form and the 'coming-together' of the two forms. It also highlights the technological reduction, which is most often the crisis of modern times, where quality is often reduced to quantity. René Guénon takes the subject further by relating the term 'essence' and 'substance' to the terms 'quality' and 'quantity' (simultaneously relate to *prima materia* and *materia secunda*) to explain form. Each manifested being is a composite of both essence and substance such that it can be said that each being corresponds to both these principles and is a resultant of their union.²⁵ Quantity directly linked with substance is the very condition of existence and relates only to the substantial side of the world. Although it is an essential dimension for anything to physically exist at all, it cannot be equated to the essential side; the foundation of a building is not to be equated with the superstructure. René Guénon writes:

"Quantity, considered by itself, is only a necessary 'presupposition,' but it explains nothing; it is indeed a base, but nothing else, and it must not be forgotten that the base is by definition that which is situated at the lowest level, so that the reduction of quality to quantity is intrinsically nothing but a 'reduction of the higher to the lower.."²⁶

If a body is to be considered purely 'quantitative,' that is to say that the volume and space it occupies is enough to describe its attributes or properties. However, that reasoning is absurd, as the essential 'nature' of the body cannot be reduced to the 'space it occupies' as it only offers quantitative elements. Therefore, it must be sought that what makes the 'body' in some way 'qualitative,' is its 'situation' or perhaps the 'relations' between two or more bodies. Now it can be argued that the distance between the bodies can be called quantitative as well, but it must be noted, that magnitude does not take into account the 'direction' in which the objects are 'situated,' for the reason that in quantitative terms the cartesian space itself is considered to be homogenous and directions are not taken into account. Therefore, it is the notion of directions that add the qualitative aspect to the bodies or how they relate or 'come together,' or better termed as the 'qualitative difference.' This idea of relations and a heterogeneous space was further shown by Einstein's theory of General Relativity in 1915, space curves around matter or mass warp space and time, explaining gravity as the curvature itself. Therefore, anything with mass would inflict any other body in space, emphasizing their relations. It is not only the mass and position but gravity or 'curvature' of space that determines the network of relations between matter and fields. It was evident in the organic

25 Guénon, René. 1953. *The Reign of Quantity & the Sign of the Times*. London: Sophia Perennis.

26 Ibid, p.20

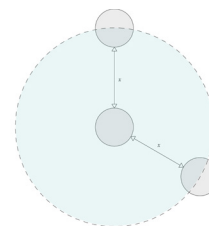

Figure.82: Quantity and Homogeneity
If two objects are at a distance of x m from each other - the distance/magnitude fails to 'situate' the relationship of the two objects, rendering the space as homogenous.

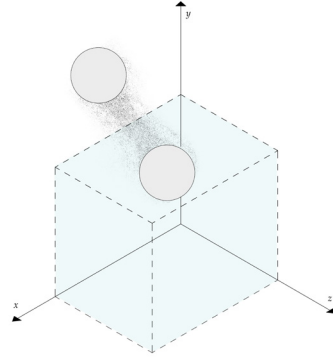

Figure.83: Direction as a Qualitative aspect of space
 Direction is qualitative and evokes spatial symbolism and a heterogeneity spatial field

form languages where the introduction of gravity had direct influence on the morphology of the form.

The above discourse resonates with two critical considerations that inform this thesis: one, the need to come to a middle ground between the intuitive/essential realm of art and the rational/substantial realm of science, such that it evokes an androgynous or hybrid nature of form. It is also important to note that any form which corresponds to that intermediary' state of influx' must then result in a constitutive process than a static preconceived thought. Second, the significance of 'harmony' within the system and the manner things 'knit together.' It is particularly important before going any further to see the application of the philosophical concepts discussed above to a more limited sphere of art and architecture. The next chapter will provide important case studies contextualizing the concepts of unifying the fields of art and science and architecture; reflecting the need for a system of wholeness; an interrelated world, which weaves together the human systems with the natural systems.

7. Intersections | *coming together*

In keeping with the contrasting studies of the organic and the polyhedra constructions, further investigation examines the contemporary traditions which inform the 'linking' of those polarities. In the 20th century, there were scientists with philosophical pretensions such as Ernest Haeckel and Raoul Francé by whom the 'bio-centric' thought propagated further into the field of art and design. It catalyzed the search for new methods of design, where artists and architects unified the animate and inanimate systems. To elucidate ideas on interpenetration, this chapter will look into well-known avant-garde precedents involving Moholy-Nagy, for his reflection on the dynamics construction of form and structural continuities, and Frederick John Kiesler, for his work on the continual interaction between man and his technological environment; both of which are relevant and informed Zvilna's ideology for a heterogeneous, interconnected world. Among the renowned architecture historians, it was Detlef Mertins who gathered these artists and architects into a staggering string of interconnected elements and coined the term 'bio-constructivism' representing a bio-logistic thought and a bio-centric world view.²⁷

LÁSZLÓ MOHOLY-NAGY (1895-1946) was known for his inclusions and intersections of various mediums of art, including painting, sculpture, and photography, and design and film. He manipulated various media of art and technology that expanded the human facility to understand and emulate nature. Technology for him was not the 'other' but a part of nature, further blurring the boundaries between nature and humans. Inspired by the new optics of scientific photography, he became fascinated with *structural continuities*, scales and material phenomena. (See Figure 85, Figure 86 and Figure 87) His work presented a wide variety of photographs of both organic and inorganic materials to human activity patterns, presenting a 'relation' as a unifying element among all.²⁸

Another relevance of Moholy to architecture was embedded in his conception of space as a *dynamic relationship of forces*. He described architecture as an 'experiential relationship to space.'²⁹ His particular works titled, *Kinetic Constructive System* (Figure 84) and the Nickel Spiraling Sculpture demonstrated space as a 'fluid' system. It transformed the observer into an active participant, blurring the lines between an object and a subject, a performer and a spectator, and the inside and outside. Detlef Mertins described it as an interweaving of spatial relationships where space was no longer conceived as empty 'homogenous space'(as described in the previous chapter) but as a phenomenological spatial field.

27 Mertins, Detlef. 2007. "Where Architecture Meets Biology: An Interview with Detlef Mertins." University of Pennsylvania, Scholarly Commons.

28 Botar, Oliver A. I. 2011. "Laszlo Moholy-Nagy and Biocentrism." Moholy Nagy in Motion 259-264.

29 Krufft, Hanno Walter. 1996. "Germany and its Neighbours: 1890-1945." In *History of Architectural Theory from Vitruvius to the Present*, by Hanno Walter Krufft, 384-388. Princeton Architectural Press.

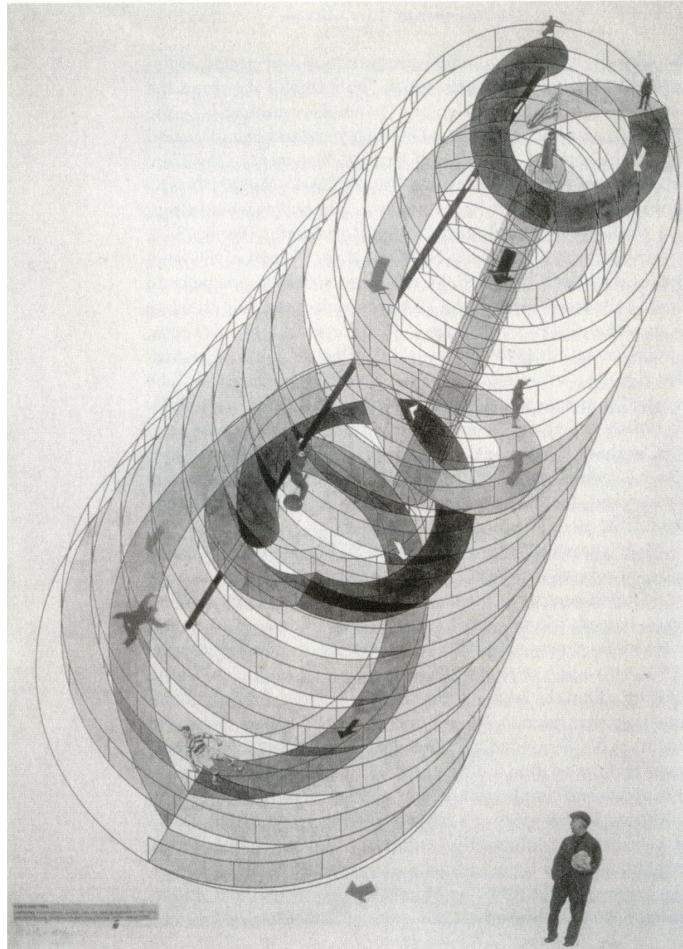

Figure.84:Kinetic Constructive System by Laszlo Moholy-Nagy
Depiction of interweaving of relationships in space



Figure.85:Detail of papmac, 1943, showing the dramatic shadow effects generated by bubbles and ripples in plexiglas. Moholy's search for the structural phenomena and materiality inspired by the microscopic scientific imagery.



Figure.86:Boote am Pont Transbordeur. Marseille. 1929.
Photographing patterns at a range of scales from microscopic imagery of materials and processes to human pattern languages at an urban scale.



Figure.87:László Moholy-Nagy (1895-1946), Photomontage
Material Intersections and patterns.

- 30 Kiesler, Frederick J. 1939. "On Correalism and Biotechnique: A Definition and Test of a New Approach to Building Design." *Architectural Record* 60-75.

- 31 Perez-Gomez, Albert. 2006. "Eros and the Poetic Image." In *Built Upon Love*, by Alberto Perez Gomez, 95-105. Cambridge: The MIT Press.

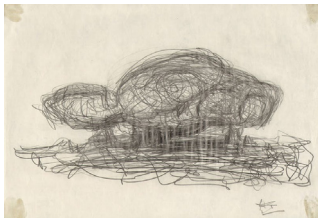

Figure.88:Frederick Kiesler, study for an "Endless House", New York 1959

FREDERICK KIESLER (1890-1965), in his quest to bridge the animate and inanimate matter brought forward the theory of 'correlation' bringing the world of art, science, and environment all together into a dynamic construct. The theory best described the 'state of influx,' an interconnection, continuity and interrelationship between a dream and a reality. In order to establish and manifest those interrelations, Kiesler argued that the manifesto' form follows function' was obsolete, and function could no longer be regarded as static. Instead, it was the product of *forces* and *actions*. For Kiesler, the technological environment was part of the greater complex of the natural environmental forces and the human systems, introducing a new collective organicism. He explained design as a negotiation of various forces collaborating and working together: He wrote: "Since the building designer deals with forces, not objects, design is therefore, in my definition, not the circumscription of a solid but a deliberate polarization of natural forces towards a specific human purpose."³⁰

Just as Moholy-Nagy searched for the 'continuities' across scales, Kiesler was able to develop an application of those relations and continuities in his project. The Endless House was a manifestation of the term 'biotechnique' and he used it as a way of examining organisms and natural forms for building economic constructions. Here the role of technology was to explicitly 'influence life in the desired direction.' This propagated his search to look for ways that nature builds and use it a paradigm for constructing human dwellings. The Endless House was an egg-shaped organic arrangement where the ceiling and roof blended into one another, presenting a *relation* and *continuity* between nature, bodies and the built environment. Continuous joints and organic form allowed it to rise out of the ground like a wave and embrace it back. Alberto Pérez-Gómez, in his critique on the haphazard 'computer-generated' blob-like forms, described it as not merely stylistic, rather a continuous fluctuation of a poetic image³¹. It was not just a dwelling but a natural rhythm captured by continuities in space. Both Moholy-Nagy and Kiesler had a significant influence on Zvilna with the central idea of continuous relations and continuities among the natural systems and potentially deploying the same in the human systems. Their works supplement the critical discourse by emphasizing the 'tensions' that exist between objects rather than the object themselves. The work presented do not only grasp the bits and pieces but the relations between the pieces which encompasses the totality and wholeness of the system.



Figure.89:Frederick Kiesler, model for an "Endless House," wire frame structure, New York 1959

Discussion

The form languages presented in this discourse lie at the intersections of polarities, the intuitive and the rational realms, suspended between art, architectural and scientific constructions. The literature that follows validated the contraries inherent in nature by drawing parallels between the experiments and concepts in architectural and philosophical traditions. The Crystal Chain reflected forms that resonated between the intuitive play and rational geometric constructions. It engaged morphologies that by virtue of their geometric perfection reflect characteristics of crystals, while their relation in space and time gave them the ability to perform functions similar to the living organisms. The literature on historical sources for the most part dealt with mediation from a broad perspective: Plato's *Timaeus* and *Hyperotomachia Poliphili* grappled with the concept of the intermediary stratum, the middle and the dancing space of chora. René Guénon's reflections on Quality and Quantity emphasized the importance of directionality and relation, rendering the space as a heterogeneous and localized spatial field. In understanding of interrelationships and abstracting qualities from nature, the research presented works of Moholy-Nagy and Kiesler, both of which developed a greater understanding of inherent continuities between nature, man and the environment.

Significantly, this work found out understood that the world is a construct of inherent polarities, ranging from the scientific atomic level polarities of protons and electrons to polarities of the faculties inside human beings (the rational and the intuitive), to theological polarities of being and becoming and to speculated unknown polarities at the cosmic level. These contraries do not suggest themselves to be problematic, but it is the 'application' of those faculties that could lead to imbalance and disharmony. The polarities are not to be exaggerated over the other but rather exist in 'harmonious' correspondence. I would quote here that the construct of human being itself calls for a 'balance'; calls for 'mediation' between the rational faculty of the mind and emotional faculties of the heart. It is the balance between those two

that may lead to the well-being of the body and others around the body. Similar case apply to the material world of forms. This discourse has existed over the centuries and holds within it values of truth. Perhaps, the 'truth,' although in its abstraction lies between those polarities, always in influx, gravitating, mediating between both. Is it something that could be materialized in the world of forms? Or will it always belong to an eternal realm as something only to be experienced?

Today technology has allowed us to capture the aspects of nature which were not perceivable before. It acts as a powerful camera, with its shutter open can assist us in drawing nature and penetrate aspects of 'imitation' evoking new responsive and near-living systems. It is worthwhile noting that although the study investigates nature and identifies processes that could lead to meaningful forms, the quest of nature alone cannot essentially lead to meaningful architecture in the pragmatic realm of the public. All technology, science and geometry are essential, ranging from the concepts of proportions of Pythagoras and Alberti's conception of 'harmonious knitting' to new differential and parametric geometries of this age, but geometry alone is not what people aspire for. We can settle on the fact that human good cannot be achieved by conflict with nature, however, translations of nature alone cannot lead to order in the human society. Human systems are multi-faceted, and another facet of that system is Culture - without which human excellence cannot be achieved. Culture can be identified as the ornament of human society; it works as an ordering tool of actions and ritual. Culture is what directs human behaviour, and without it, even if we deploy technology and science to its full potential, there can be nothing but shapeless experience. In retrospect, this study built on the importance of deploying both rational faculty of geometry and 'play' to the creation of form. Here we can start to notice that 'play' is an underlying factor that could potentially lead to cultural connection and transformation of the public sphere. Play accompanies the action and can pervade into human society as a significant form of 'social function.' It is play, perhaps, which holds the key to illuminate a culture of forms that carry within them both principle dynamics of nature and cultural connection.

Bibliography

APPELL, J.W. 1499. *The Dream of Poliphilus: Hypnerotomachia Poliphili with an Introductory Notice, and Descriptions.* Venice: Reproduced for the Department of Science and Art in Photo-Lithography by W. Grigg - 1893.

Archer-Hind, R.D. 1888. *The Timaeus of Plato.* London: Macmillan and Co. and New York.

Bletter, Rosemarie Haag. March 1981. "The Interpretation of the Glass Dream - Expressionist Architecture and the History of the Crystal Metaphor." *Journal of the Society of Architectural Historians* 31.

Bletter, Rosemarie. 1981. *The Interpretation of the Glass Dream - Expressionist Architecture and the History of the Crystal Metaphor.* New York: Journal of the Society of the Architectural Historians.

2006. *The Inner Life of a Cell.* Directed by Harvard. Performed by David Bolinsky.

Bonnamaison, Sarah. 2019. *Resurgence of Organicism.* Toronto: Riverside Architectural Press & Dalhousie Architectural Press.

Botar, Oliver A. I. 2011. "Laszlo Moholy-Nagy and Biocentrism." *Moholy Nagy in Motion* 259-264.

Charissa N. Terranova, Meredith Tromble. 2016. *The Routledge Companion to Biology in Art and Architecture.* New York: Routledge.

Eck, Caroline van. 1995. "Goethe and Alberti: Organic Unity in Nature and Architecture." *Structurist*;1995/1996, Issue 35/36 20-24.

Gibbons, Andrea. 2016. *Writing Cities.* January 12. Accessed April 03, 2020. <http://writingcities.com/2016/01/12/paul-scheerbarth-and-glass-architecture/>.

Guénon, René. 1953. *The Reign of Quantity & the Sign of the Times.* London: Sophia Perennis.

Guénon, René. 1953. "The Reign of Quantity & The Sign of Time." In *The Reign of Quantity & The Sign of Time*, by Rene Guenon, 20. London: Sophia Perennis.

Huizinga, J. 1949. "Homo Ludens: A study of the Play-Element in Culture." In *Homo Ludens: A study of the Play-Element in Culture*, by J. Huizinga. London: Routledge & Kegan Paul.

1995. In *Modernism and the Posthumanist Subject: The Architecture of Hannes Meyer and Ludwig Hilberseimer*, by K. Michael Hays, 91. The MIT Press.

Janzen, Albert. 2016. Behance. Accessed April 05, 2020. <https://www.behance.net/gallery/42656837/Lines-for-Luxembourg-Art-Fair>.

Jennifer, Noémie. 2016. The Unusual Chemistry of an Experimental Master Artist | Conservation Lab. June 08. Accessed 03 28, 2020. https://www.vice.com/en_au/article/3d5w9j/moholy-nagy-chemisty-experiments-conservation-lab.

Kiesler, Frederick J. 1939. "On Correalism and Biotechnique: A Definition and Test of a New Approach to Building Design." *Architectural Record* 60-75.

Kruft, Hanno Walter. 1996. "Germany and its Neighbours: 1890-1945." In *History of Architectural Theory from Vitruvius to the Present*, by Hanno Walter Kruft, 384-388. Princeton Architectural Press.

Lang, Andrew. Originally published in 1499. *The Strife of Love in a Dream: The First Book of Hypnerotomachia* by Francesco Colonna. London : David Nutt.

Laszlo, Ervin. 1972. "Empirical Interpretations." In *Introduction to Systems Philosophy*, by Ervin Laszlo, 70. London: Gordon and Breach, Science Publishers.

Mertins, Detlef. n.d. "Glass Architecture." In *Modernity Unbound: Other Histories of Architectural Modernity*, by Detlif Mertins, 17. London : Architectural Association.

Miller, Tyrus. 2017. "Expressionist Utopia: Bruno Taut, Glass Architecture and the Dissolution of Cities." *Filozofski vest* 107-129.

Miller, Tyrus. 2015. "Paul Scheerbart and the Utopia of Glass." *Original Scientific Article* 85-93.

Mertins, Detlef. 2007. "Where Architecture Meets Biology: An Interview with Detlef Mertins." University of Pennsylvania, Scholarly Commons.

Padovan, Richard. 1999. "Humanism and architecture." In *Proportion: science, philosophy, architecture*, by Richard Padovan, 215. London: E & FN Spon.

Pérez-Gómez, Alberto. 2006. *Built Upon Love*. Cambridge: The MIT Press.

Pérez-Gómez, Alberto. 2006. "Eros and the Poetic Image." In *Built Upon Love*, by Alberto Pérez-Gómez, 95-105. Cambridge: The MIT Press.

- Pérez-Gómez, Alberto. 1997. "Modern Architecture, Abstraction, and the Poetic Imagination." *International Journal of Architecture Theory*.
- Phillips, Stephen. 2010. "Toward a Research Practice: Friedrich Kiesler's Design-Correlation Laboratory." *Grey Room* 90-120.
- Plato. 1888. In *The Timaeus of Plato*, by R.D Archer-Hind, 254-260. London: Macmillan and Co. and New York.
- Proclus. 1820. "Volume II, Book 11." In *The Commentaries of Proclus on the Timeaus of Plato*, by Thomas Taylor, 338. London: Duopage Process.
- Rogers, Wally. 2016. *Close-Up View of Froebel's Kindergarten with Frank Lloyd Wright at the Drawing Table*. Xlibris Corporation.
- Scheerbart, Paul. 1971. "Glass Architecture." In *Programs and manifestoes on 20th-century architecture*, by Ulrich Conrads, 31-33. Cambridge: MIT Press.
- Stewart, Ian. 2018. "Encyclopedia Britannica." Number symbolism. January 2018. Accessed May 24, 2020. <https://www.britannica.com/topic/number-symbolism>.
- Taylor, Thomas. 1820. *The Commentaries of Proclus on the Timeaus of Plato*. London: Duopage Process.
- Whyte, Iain Boyd. 1965. "Introduction." In *The Crystal Chain Letters : Architectural Fantasies* by Bruno Taut and His Circle, by Iain Boyd Whyte, 5. London: The MIT Press.
- . 1965. *The Crystal Chain Letters : Architectural Fantasies* by Bruno Taut and His Circle. London : The MIT Press.
- Whyte, Lancelot Law. 1954. "What is Form?" In *Accent of Form: An Anticipation of the Science of Tomorrow*, by Lancelot Law Whyte, 14. New York: Harper and Brothers Publishers.
- Whyte, Lancelot Law. 1954. "What is Man?" In *Accent on Form*, by Lancelot Law Whyte, 122. New York: Harper and Brothers .
- Wright, Frank Lloyd. 1914. "In the case of Architecture." *Architectural Record* 406.
- Whyte, Lancelot Law. 1954. "What is Form?" In *Accent of Form: An Anticipation of the Science of Tomorrow*, by Lancelot Law Whyte, 31. New York: Harper and Brothers Publishers.
- Zvilna, Jekabs. 1974. "Rotation and Form." *University of Waterloo* 1-25

Zvilna, Jekabs. 1984. "Doctrine of One: an exercise in twentieth-century synthesis"
University of Waterloo p,18

AA School of Architecture. "Detlef Mertens - Bioconstructivism, Biotechnics and
Biotechniques: Lissitzky, Moholy-Nagy, Kiesler". YouTube. 1:38:19, January 15, 2020.
<https://www.youtube.com/watch?v=Rwe4gptNOUo>

PostNothingness. "Plato's Timaeus (63)". YouTube. 1:37:20, January 05, 2020. <https://www.youtube.com/watch?v=OZrZCE-ufoM&t=166s>

Knowledge and feeling....

perhaps, these are waves in an ocean...

what do they do?

Keep it alive....