

Transforming the Gardiner Expressway: A Vision for Personal Rapid Transit in 2015

by
Chloe Li

A thesis
presented to the University of Waterloo
in fulfillment of the
thesis requirement for the degree of
Master of Architecture
in
Architecture

Author's Declaration

I hereby declare that I am the sole author of this thesis. This is a true copy of the thesis, including any required final revisions, as accepted by my examiners.

I understand that my thesis may be made electronically available to the public.

Abstract

Urban infrastructure has long been regarded as the lifeblood to any city, essential to urban communities. A successful city cannot exist without a successful infrastructure, and as a city matures, its system must adapt.

Modern urban development and, in particular, the proliferation of urban expressways over the past half a century, has led to a greater fragmentation, and even segregation, of certain parts of the city, as well as unprecedented traffic growth that has strained the capacity of urban transportation systems. Cities around the world now confronted by the consequences of

urban expressways must begin to rectify their situations.

In Downtown Toronto stands the Gardiner Expressway. Envisioned in the 1950s as part of a larger highway network, resistance to highway planning and growing interest in public transit a decade later left the Gardiner a liability in the urban infrastructure – well traveled but disjointed, isolated from the waterfront, which is its immediate context, and congested with automobiles. On many levels, it continues to be a detriment to the city as a whole.

This thesis recognizes transportation infrastructure as vital to Toronto's overall development and looks to enhance that development by transforming the Gardiner Expressway into a viable and responsive transit interface, stimulating new, integrated systems of mobility. Conceived within the parameters of Toronto's Official Plan, the project uses a ten-year phasing strategy that involves policy planning, urban transit coordination, and includes the implementation of Personal Rapid Transportation [PRT] technology and a 7.5 km elevated bicycle path. Seamless movement is

achieved by inter-modal transit nodes and direct waterfront access. Bridging the city and the waterfront, the proposed transit initiatives specifically respond at various urban scales to increasing waterfront density, commuting patterns, land uses, and new developments. It is anticipated that the success of this revitalized system will lead other cities to reassess the capabilities of their own urban infrastructures.

Acknowledgements

I would like to thank the following advisors for their guidance, challenges, and support in the process of realizing this body of work:

Thesis Supervisor:

Donald McKay, *Associate Professor*
University of Waterloo

Committee:

Lloyd Hunt, *Associate Professor*
University of Waterloo

Val Rynnimeri, *Associate Professor*
University of Waterloo

External Reader:

Chris Hardwicke

Editor:

Eric Beck Rubin

Dedication

I would like to express my sincere appreciation to everyone who gave their time and insightful thoughts to this thesis. I am grateful for your patience and enthusiasm. This thesis is dedicated to my dear colleagues, friends, and family for their generous support and encouragement.

Table of Contents

<i>iii</i>	<i>Author's Declaration</i>
<i>iv</i>	<i>Abstract</i>
<i>vi</i>	<i>Acknowledgements</i>
<i>vii</i>	<i>Dedication</i>
<i>ix</i>	<i>Table of Contents</i>
<i>xiii</i>	<i>List of Illustrations</i>
<i>1A</i>	<i>Fred Gardiner's Vision</i>
<i>1B</i>	<i>The Gardiner's Reality</i>
<i>2</i>	<i>2015: A Commuter's Narrative</i>
<i>4</i>	<i>Title Page</i>
<i>6</i>	<i>Introduction</i>

Table of Contents

CHAPTER ONE

ON TRANSPORTATION INFRASTRUCTURE

1.1	Automobiles	10
1.2	Urban Freeways	12
1.3	Cities	14

CHAPTER TWO

ON THE GARDINER EXPRESSWAY

2.1	Toronto's Waterfront	18
2.2	Building the Gardiner	20
2.3	Enduring the Gardiner	23
2.4	Sustaining the Gardiner	25

CHAPTER THREE

ON PAST PROPOSALS

3.1	What COULD be done?	29
3.1.1	Urbanizing the Gardiner	30
3.1.2	Sinking the Gardiner	31
3.1.3	Demolishing the Gardiner	32
3.1.4	Tunneling the Gardiner	33
3.1.5	Suspending the Gardiner	34
3.1.6	Nurturing the Gardiner	35
3.1.7	Infilling the Gardiner	36
3.1.8	Recreating the Gardiner	37
3.2	What SHOULD be done?	39

CHAPTER FOUR

ON TRANSPORTATION NETWORKS

4.1	Superhighway 'A'	43
4.2	Anti-Expressways	45
4.3	Public Transit	47
4.4	Bicycle Network	49
4.5	Regional Connections	51

CHAPTER FIVE

ON NEW POLICIES AND PLANNING

5.1	Waterfront Density	55
5.2	Gardiner Expressway Toll	57
5.3	CBD Parking Levy	59
5.4	Front Street Extension	61
5.5	Congestion Charge	63
5.6	Smart Technology	65
5.7	Remove, Reduce, Retain	67

CHAPTER SIX

ON PERSONAL MOBILITY

6.1	Personal Mobility	70
6.2	Mobility Tracks	73
6.3	Personal Rapid Transit	75
6.4	T-Pods	77
6.5	PRT Capacity	79
6.6	7.5 km Bike Path	81
6.7	Integrated Transit	83
6.8	Station Types:	
6.8.1	PRT Station Type 'A'	85
6.8.2	PRT Station Type 'B'	89
6.8.3	PRT Station Type 'C'	93
6.8.4	PRT Station Type 'D'	97
6.8.5	PRT Station Type 'E'	101
6.9	Vision of Mobility	105
	RIDE GUIDE 2015	107
	<i>End Notes</i>	113
	<i>Bibliography</i>	117
	<i>Appendix A</i>	123
	<i>Appendix B</i>	125
	<i>Appendix C</i>	127

List of Illustrations

FIGURE	DESCRIPTION / SOURCE	PAGE
01	Gridlock on the Gardiner - <i>University of Toronto Institute for Environmental Studies, 2004</i>	1b
02	Under the Gardiner Expressway - <i>Photograph by Author, 2005</i>	04
03	Aerial photo of Gardiner Expressway west - <i>University of Waterloo Map and Design Library</i>	08
04	Gridlock - <i>Statistics Canada <www.statcan.ca></i>	11
05	Highway interchanges - <i>Skyscraper Page <www.skyscraperpage.com></i>	13
06	Boston boulevard (before and after) the Big Dig - <i>Mass Turn Pike <www.massturnpike.com></i>	14
07	Cheonggyecheon (before and after) the restoration - <i>KBS World <www.world.kbs.co.kr></i>	14
08	London Westway (before and after) - <i>Westway Development Trust <www.westway.org></i>	15
09	New York Highline (before and after) - <i>Friends of the Highline <www.thehighline.org></i>	15
10	Gardiner Expressway west aerial photo - <i>University of Waterloo Map and Design Library</i>	16
11	Goether Mann's plan of Toronto, 1788 - <i>Toronto District School Board <www.tdsb.on.ca></i>	19
12	Central waterfront - <i>GET Study, Architects Alliance</i>	19
13	Waterfront movement diagram - <i>Digital Image by Author, 2006</i>	19
14	Dufferin Gates entrance to CNE, 1910 - <i>Exhibition Place & CNE <www.explace.on.ca></i>	21
15	Sunnyside Amusement Park, 1949 - <i>Coaster's Enthusiasts of Canada <www.cec.chebucto.org></i>	21
16	Gardiner Expressway passes by Fort York - <i>GET Study, Architects Alliance</i>	21
17	Gardiner Expressway on-ramps and off-ramps - <i>Digital Image by Author, 2006</i>	22
18	Gardiner Expressway photo between York St. & Spadina St. - <i>Architects Alliance</i>	22
19	Jarvis Street westbound on-ramp - <i>Photograph by Korkas <www.korkas.com></i>	23
20	Gardiner Expressway under demolition, 2001 - <i>Photograph by Dave Till <www.davetill.com></i>	24
21	Gardiner Expressway closure signage - <i>U of T, Institute for Environmental Studies</i>	25
22	Gardiner Expressway eight proposals icons - <i>Digital Image by Author, 2006</i>	26
23	Gardiner Expressway current icon - <i>Digital Image by Author, 2006</i>	28
24	Wilmsdorf housing project, Berlin, 1972 - <i>Urbanizing the Gardiner, Paul Reuber Architect</i>	30
25	Upper Town, Lower Town - <i>Urbanizing the Gardiner, Paul Reuber Architect</i>	30

List of Illustrations

FIGURE	DESCRIPTION / SOURCE	PAGE
26	Residential buildings on the Gardiner - <i>Urbanizing the Gardiner, Paul Reuber Architect</i>	30
27	Houses under the highway, Tokyo - <i>Made in Tokyo <www.dnp.co.jp></i>	30
28	Gardiner submerged under the lake - <i>Digital Image by Author, 2006</i>	31
29	Gardiner 4-lane tunnel - <i>The Toronto Star, July 19, 1988</i>	31
30	Gardiner Expressway eastern terminus before demolition - <i>Digital Image by Author, 2006</i>	32
31	Gardiner Expressway eastern terminus after demolition - <i>Digital Image by Author, 2006</i>	32
32	Gardiner Expressway eastern terminus during demolition - <i>Peter MacCallum</i>	32
33	Diagram of Gardiner Expressway underground - <i>Digital Image by Author, 2006</i>	33
34	Gardiner replaced with boulevard - <i>The Toronto Star, 2002</i>	33
35	Gardiner elevated tube site plan - <i>Digital Image by Author, 2006</i>	34
36	Elevated Gardiner +15 - <i>Toronto Life Magazine, June 2002</i>	34
37	Miyashita park, Tokyo - <i>Made in Tokyo <www.dnp.co.jp></i>	35
38	Gardiner reclaimed as green space - <i>Digital Image by Author, 2006</i>	35
39	Beautify the Gardiner - <i>GET Study, Architects Alliance</i>	36
40	Commerical activity beneath the Gardiner - <i>Architects Alliance</i>	36
41	Gardiner proposed elevation - <i>GET Study, Architects Alliance</i>	36
42	Gardiner waterfront viaduct - <i>Toronto Viaduct, 2005, Jose R. Gutierrez <www.toviaduct.com></i>	37
43	Gardiner viaduct site plan - <i>Digital Image by Author, 2006</i>	37
44	Gardiner viaduct multi-lane traffic - <i>Toronto Viaduct, 2005 Jose R. Guterrez</i>	37
45	Gardiner PRT transformation icon - <i>Digital Image by Author, 2006</i>	38
46	GTA aerial photograph - <i>Canadian Nuclear Society <www.cns-snc.ca></i>	40
47	Toronto Metropolitan area Master Plan, 1943 - <i>Toronto Archives</i>	42
48	QEW merges Gardiner Expressway - <i>Missing Links, James B. Alcock <www.torontoexpwy.com></i>	43
49	Toronto expressways - <i>Digital Image by Author, 2006</i>	44
50	Anti-Expressways protestors - <i>Bernard Electronic Archive <www.beatl.barnard.columbia.edu></i>	45

FIGURE	DESCRIPTION / SOURCE	PAGE
51	Anti-Expressways demonstration, 1970 - <i>Missing Links</i> , James B. Alcock < www.torontoexpwy.com >	45
52	Toronto public transit - <i>Digital Image by Author, 2006</i>	46
53	Don Valley Parkway and GO Rail - < www.answers.com >	47
54	Bike network - <i>Digital Image by Author, 2006</i>	48
55	Cyclists Handy Roadmap, F.R. Ward, 1894 - < www.tino.ca >	49
56	Gardiner Expressway Bike for Heart Marathon, June 4, 2006 - <i>Photograph by Author, 2006</i>	49
57	GTA regional connections - <i>Toronto Urban Development Services</i> < www.toronto.ca >	50
58	Union Station multi-modal hub - <i>Digital Image by Author, 2006</i>	51
59	Downtown Toronto - <i>Frank Eigler</i> < www.web.elastic.org >	52
60	GTA Population Projection 2031 - <i>City of Toronto, 2004</i>	54
61	Toronto skyline 2010 - <i>Concord CityPlace</i> < www.cityplace.ca >	55
62	Gardiner Expressway Toll - <i>Digital Image by Author, 2006</i>	56
63	Gardiner Expressway Toll system gantry - <i>Digital Image by Author, 2006</i>	57
64	Toronto Parking Authority CBD parking spaces - <i>Toronto Parking Authority</i> < www.greenp.com >	58
65	Green 'P' logo - <i>Toronto Parking Authority</i> < www.greenp.com >	59
66	Front Street Extension and DVP improvements - <i>Digital Image by Author, 2006</i>	60
67	View of Front Street Extension from CN Tower - <i>Digital Image by Author, 2006</i>	61
68	London Congestion Zone superimposed on Toronto - <i>Digital Image by Author, 2006</i>	62
69	London Congestion Charge District - <i>Transport for London</i> < www.tfl.gov.uk >	63
70	Smart Park facilities - <i>Digital Image by Author, 2006</i>	64
71	Multi-use transponder [PPS] - <i>Digital Image by Author, 2006</i>	65
72	Retrofitted Gardiner Expressway - <i>Digital Image by Author, 2006</i>	66
73	Park and ride - <i>Digital Image by Author, 2006</i>	67
74	Personal rapid transit vehicles - <i>Digital Compliation by Author, 2006</i>	68
75	PRT track phasing - <i>Digital Image by Author, 2006</i>	72

FIGURE	DESCRIPTION / SOURCE	PAGE
76	PRT tracks typical cross section - <i>Digital Image by Author, 2006</i>	73
77	Personal Rapid Transit System - <i>Digital Image by Author, 2006</i>	74
78	T-Pods - <i>Digital Image by Author, 2006</i>	76
79	T-Pod commute patterns - <i>Digital Image by Author, 2006</i>	77
80	PRT stations - <i>Digital Image by Author, 2006</i>	78
81	Transport vehicles comparison - <i>Digital Image by Author, 2006</i>	78
82	Bike tube vignette - <i>Digital Image by Author, 2006</i>	80
83	Under the tracks - <i>Digital Image by Author, 2006</i>	81
84	Proposed section at Union Station inter-change - <i>Digital Image by Author, 2006</i>	82
85	Integrated transit - <i>Digital Image by Author, 2006</i>	82
86	Station Type 'A' - <i>Digital Image by Author, 2006</i>	84
87	2012 Waterfront Scenario - <i>Digital Image by Author, 2006</i>	86
88	Station Type 'B' - <i>Digital Image by Author, 2006</i>	88
89	2013 Waterfront Scenario - <i>Digital Image by Author, 2006</i>	90
90	Station Type 'C' - <i>Digital Image by Author, 2006</i>	92
91	2014 Waterfront Scenario - <i>Digital Image by Author, 2006</i>	94
92	Station Type 'D' - <i>Digital Image by Author, 2006</i>	96
93	2015 Waterfront Scenario - <i>Digital Image by Author, 2006</i>	98
94	Station Type 'E' - <i>Digital Image by Author, 2006</i>	100
95	2015+ waterfront scenario - <i>Digital Image by Author, 2006</i>	102
96	Metropolis vignette - <i>Digital Image by Author, 2006</i>	104
97	RIDE GUIDE 2015 - <i>Digital Image by Author, 2006</i>	107

May 3, 1954

How would you like to drive through Toronto during rush-hour at 50 miles an hour ... you would have no stoplights to contend with, no billboards to distract your attention, and no obstacle course of bottlenecks to ... fray your temper. In addition, you would have a beautiful view of the lake through most of the ten-mile trip, with miles of six-lane, gently curving landscaped highway stretching out in front of you.

Toronto Telegram Press

GARDINER MOVING SLOWLY
TO BEFORE ISLINGTON EXIT



Welcome to Smart Park. The transponder on your dashboard greets you with several familiar options. You select the Day Park as usual. Following the prompts, you drive up the ramp to Level 6, make two right turns, and continue forward until you reach the fifth bay. The screen flashes 639 and a quick glance to the asphalt on the left verifies the number. You pull into the designated parking space and switch off the engine. You put away your key, select your Smart Card and leave the car behind.

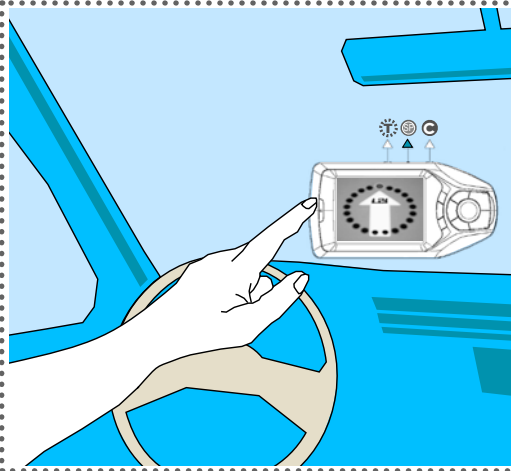

The nearest elevator takes you and several other passengers down to the Terminal Station on Level 2. You step out and follow the people to the Main Loop. Eyeing the energizer booth up ahead, you are tempted to drop by for a quick fix; after all there's no scheduled train to miss. The coffee is inhaled in one quick shot, penetrating deep and strong. The jolt of energy revives you.

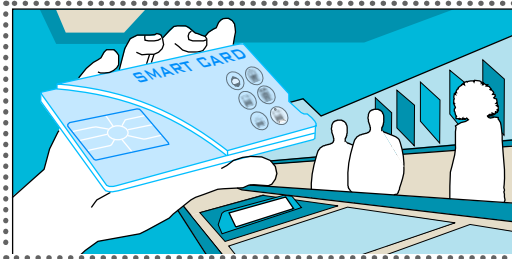

You are ready to merge with the stream of morning commuters. A larger swarm has gathered now, probably from the GO train that just arrived from the lower level. After a short escalator ride you scan the Smart Card before crossing the entry point. The station is spacious and you merge with the flow of people on the

way to the departure zone. The platform you stand on is lit up on the edge. The system detects your presence and seconds later, the T-Pod arrives. You step in, followed by a couple dressed in business attire, each carrying a yellow bicycle helmet. You suspect they are members of the city's BikeShare program, emerging from the lockers and bicycle facilities just below the escalators. They greet you and tell you about a car accident they witnessed earlier on Lakeshore Boulevard. Luckily, your car is safely parked and you've avoided the hassles of driving into the downtown altogether. The door of the pod is sealed and your anxieties are forgotten. You make your stop request on the digital screen and relax.



Floating on maglev, your pod gains momentum as it descends the guideway to merge onto the main track. You get a better view of the city from this angle. Leaving the station you cross over the mouth of the Don River. The trees are green and lush. You remember driving along this very route, where the old Gardiner Expressway used to be. Looking between the tracks you can still see the Gardiner's massive colonnades, as you pass over them. Below, the cars are backed up from the earlier accident. You can't help but feel relieved that you're up here instead of stuck down there.



On the adjacent track, pods are speeding by, mostly filled with people pressed against the window, soaking in the view of the skyline. The next lane over is the express track, with pods

secured to one another, forming a lengthy chain. You begin counting how many are in the lineup, but as they move into the distance you lose count. Pods race past one another, staggering left and right, moving faster and slower, higher and lower. Between them, you catch a glimpse of the cyclists peddling in the median lane. It's windy outside, but they are comfortably sheltered by the bike tube. All sorts of bikers share the tube; businessmen, students, couriers, athletic cyclists, and those who are just enjoying an uninterrupted, leisurely ride.

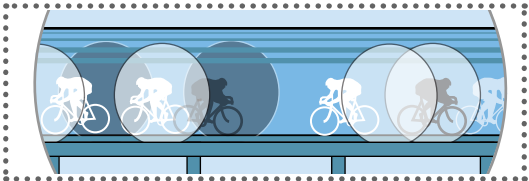

The towers gather height as you draw closer to the downtown. Your pod has passed five stations. The couple gathers their helmets and prepare to exit. As the guideway approaches, you leave the main track and enter into the station. Your pod slows, easing closer to the

platform until it reaches the arrival zone. The door opens, the couple exits, and the pod is on its way again. This time you are alone.

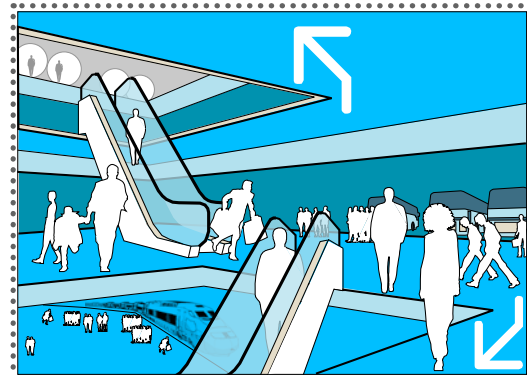

You look to the right and see a GO train pulling in. It is a tight race to Union Station. The tracks split level and you ascend into the station where all the routes converge. In seconds you are out, back in the stream of rush hour commute, and ushered down to the main concourse. *Welcome to Union Station.* The subway is a flight of stairs away, but since you are early, you skip the subway and take a nice stroll to work just over on King Street.



A black and white photograph showing a multi-level highway interchange. The foreground is dominated by the underside of a concrete overpass, with several support pillars visible. In the background, a city skyline with several skyscrapers is visible under a clear sky. A road sign with a truck icon and a diamond-shaped sign with a truck icon are visible on the right side of the road. The overall scene is industrial and urban.

Transforming the Gardiner Expressway:
A Vision for Personal Rapid Transit in 2015

Introduction

Toronto's infrastructure, involving future inter-modal transport, is a major concern. Highways are overflowing, cars stretching bumper to bumper for miles on end. New methods of conveying, channeling, and distributing commuters must be adopted if the city wants to accommodate its growing urban population, projected to reach 7.5 million by 2031, an increase of over 2.7 million over the next two and a half decades. Most of the growth will occur on the periphery, along the waterfront, spanning the length of the elevated Gardiner Expressway.

Originally conceived by Fred Gardiner in 1923 as

Toronto's symbol of progress and efficiency, over the last three decades the Gardiner Expressway has fallen on hard times. Traffic engineers, planners, architects, politicians, pundits, and the public have all criticized it as an ineffectual traffic corridor and impediment to the development of the city. Traffic on the expressway has surpassed its designed capacity almost six-fold and the City of Toronto spends in excess of \$10 million each year patching up the deteriorating roadway. Furthermore, it hinders the process of urbanization, economic development and the future of the waterfront.

One reason to retain the Gardiner is because

it serves a basic role as a grade-separated transportation corridor: it presents a remarkable opportunity to develop a responsive infrastructure for mobility along the central waterfront that will increase pedestrian interaction, residential intensification, commercial development, and economic growth.

The transformation of the Gardiner, as proposed in this thesis, would occur in phases over the next ten years. Initially drivers would be deterred from using the Gardiner by the imposition, in succession, of a Gardiner Toll, a Central Business District Parking Levy, and a Congestion Charge.



Funds generated would go towards repurposing the highway as a foundation for a network of small, fast-moving vehicles called T-Pods. The individual T-Pods serve as mobile transport units that offer on-demand service along the waterfront. With most of the Gardiner's crumbling road deck removed, magnetic levitation tracks supporting the T-Pods would be woven over the structure and extended into the urban fabric. The revised armature would be given a new itinerary, new moments of convergence, interruptions, and intersections.

In this proposal The Gardiner Expressway would be transformed into a 24-hour Personal

Rapid Transit [PRT] system and a high speed bike path for the City of Toronto. A new connection from the Gardiner to Toronto's bustling Union Station and several other proposed major stations along the route are designated as Inter-modal nodes that link passengers to all systems of the extended transit. Seamless travel through stations with bike facilities, stations directly built into future buildings, and stations with Smart Park facilities located at the major terminals to attract car commuters enhances the efficiency of the network.

The objectives: revitalize the Gardiner and to

re-envision its central role in Toronto's transport network. The PRT brings new station types that respond to commuter patterns, land uses, and new waterfront developments. The flexibility of station planning and the opportunities presented by the new bike path establish new connections within the city on many scales, effectively transforming both infrastructure and waterfront. The new Gardiner will become a highly traveled corridor, a popular attraction, and an urban destination. As the ride meanders through the waterfront, it stitches together Toronto's past, present and future.





Chapter One:

On Urban Transportation Infrastructure

The modern concept of a major street is the familiar freeway, with its divided lanes of traffic, landscaped central island and shoulders, and access only at grade-separated intersections. Traffic flows easily and enjoys a bland natural setting. Passing through a city, the road is elevated above city streets, which improves the drivers' view, but imposes even more of its noise on abutters. The division of the city is more severe, and there are dark, unusable spaces under the roadway. While the freeway in the country is often a beautiful accomplishment of modern engineering, its insertion into the urban fabric has never been properly solved.

Kevin Lynch, Good City Form

Automobiles

Currently the best-selling car in Canada, the Ford Mustang received the 2005 award as Canadian Car of the Year from the Canadian International Auto Show in Toronto. Since its release in 1965, the Mustang has been seen as the embodiment of streamlined design, high-speed travel, and personal freedom, the characteristics we most celebrate in our freeway system. Mobility and velocity seduce us, stimulating our sense of space and altering our experience, navigating the city. For better or worse, the Mustang's story is the story of our approach to travel.

It was after World War I, with the success of its Model-T, that Ford began mass manufacture

of vehicles. With the availability of affordable private cars, public transit use declined drastically. Streets, once occupied by carriages, streetcars, and pedestrians, were gradually dedicated to automobiles. The increasing variety and the length of daily personal trips spread the city beyond the bounds of public transport, and brought us the modern suburb. Providing free-flowing, high-speed, limited access automobile roads, freeways were to relieve growing congestion. Quixotically, freeway planners predicted an end to traffic jams. However, what they didn't anticipate was how car-dependent people would become, nor did they anticipate that, with new expressways there

would be more cars. They did not expect that supply would increase demand. In a 2002 critique of Torontonians, former Mayor John Sewell estimated that "Toronto's 2.3 million residents probably own a million cars."¹

The automobile once promised an enticing world of speed, freedom, and convenience, but cities and communities built around the automobile now realize that problems created by cars outweigh their benefits. Cars and their associated infrastructure consume resources and energy, and emit pollutants on a substantial scale. Unregulated roads dedicated solely to automobiles have become another over-consumed

Figure 04 opposite - gridlock

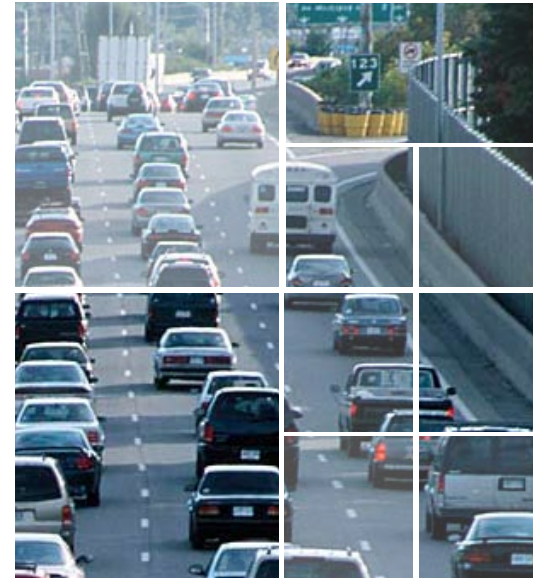
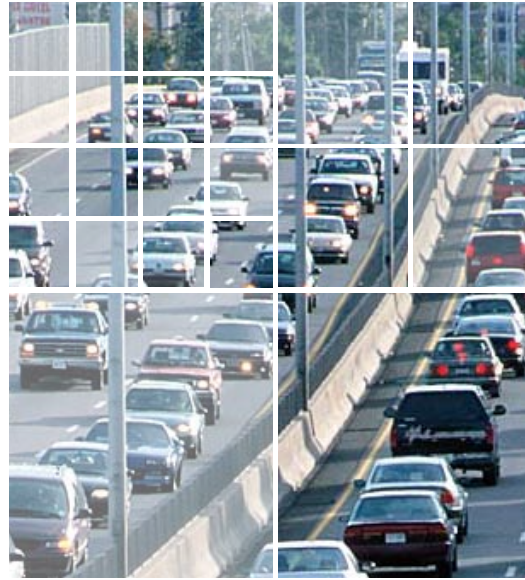
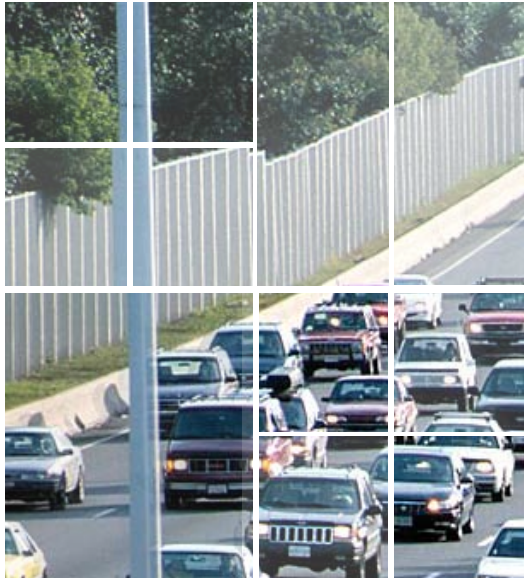

commodity in our modern world.

Downtown Toronto's most traveled and congested thoroughfare is the notorious Gardiner Expressway. After four decades of overuse, costly upgrades and maintenance, the expressway is perpetually congested and irreversibly deteriorating. Today, over 200,000 vehicles use the Gardiner daily, despite its intended daily capacity of 35,000.² Minister of Public Infrastructure Renewal David Caplan addressed the issue of congestion at the Canadian Urban Institute's Greater Toronto Area [GTA] Transit Summit in 2004: "Toronto's Board of Trade estimates that traffic congestion costs Toronto more than two

billion dollars a year, in wasted time and lost opportunity. I think it may be higher." Caplan expects that figure to increase significantly over the next generation. He cautioned Toronto on the repercussions of congestion: "In the City of London, England, traffic studies showed that the average speed of vehicles in the downtown core was lower than it had been in the 18th century. It was faster to move around London in the days of the horse and buggy than in the age of the Mini Cooper."³

The highway, a functional approach to infrastructure, has led to an undesirable segregation of mobility and culture. The Gardiner

has not evolved alongside our fascination with the automobile; it functions autonomously, and often against it. If our reliance on the car increasingly stifles movement in and around the city, what are the alternatives? Could the optimism of the 1960s, at the onset of car culture, be recaptured for the modern metropolis? Can the disconnection between mobility and culture be reconciled?

Urban Freeways

Early proponents of freeway planning regarded freeways as magnificent examples of engineering and infrastructural splendour, promoting high-speed, high-capacity, fluid transport. Moving along the expanse of road, the skyline of a city would appear as a vivid stream of impressions presented almost like a motion picture. The image of the automobile on the freeway is a symbol of our modern fascination with speed and the sensations it brings. Freeways are not mere traffic carriers; they are a form of urban sculpture, celebrations of motion that give identity to our cities.

The Bronx River Freeway, one of the first

freeways built, was intentionally curved to follow the undulations of the river and surrounding topography, landscaped to blend in with its surrounding. The approach to San Francisco over the Golden Gate Bridge was another successful freeway, designed as a portal to dramatize the drive into the city. But most other freeways, lacking urban vision, have failed the designer's original intent and inhibited the cities they were meant to serve.

From the air, the junction of highways and the ramping arabesques of busy intersections have a sinuous and graphic beauty. From the ground however, the stark sense of desolation

becomes more apparent. The construction of freeways has left behind residual spaces in the urban fabric. Over time, we have seen entire communities isolated from the city that nurtures them and entire cities blocked off from their natural surroundings. Elevated expressways have done worse; they foul the air and block light, casting shadows over large stretches of the gloomy areas below. Expressways leave us traffic-generated noise, litter, filth from dust and from polluting emissions, and often, an attendant wasteland of billboards, truck stops, and junkyards.

Architecture and the spaces along the

freeway corridors has not kept pace with the design of the freeways themselves. As evaluated by architect Bruce Webb, "The architecture which lines the freeway seems made up of capricious or desperate elements struggling to maintain a connection with the no-nonsense minimalism of the highway. The awkward spaces in between, mediated by a prosthetic architecture of signs, fail to satisfy even the most basic requirements of place-making."⁴

In 1966, Lawrence Halprin wrote the book *Freeways* to discuss the consequences of the proliferation of freeways. In his book, Halprin laments a failure to reconcile freeways with

their architectural and urban contexts: "Views have been obliterated; important landmarks have been isolated, great waterfronts have been cut off, all by freeways within cities they supposedly serve."⁵ As such, Halprin presents the challenge of making infrastructure utilitarian as well as creating a sense of place, evoking an emotion and leaving an impression on those who experience it.

Almost all citizens of Toronto regard the elevated Gardiner Expressway as anathema. Land in the vicinity of the expressway is marginalized and its looming mass keeps most pedestrians away. The structure stands as an eyesore, but more importantly, it has effectively severed the



Figure 05 - highway interchanges

city from the lake that once gave it purpose and could one day still give it beauty.

Urban elevated transportation structures can be reintegrated into the fabric of the city. Infrastructures previously seen as severe barriers have been transformed into catalysts for urban revitalization, as well as attractions in themselves. Toronto's Gardiner Expressway can be reinserted in the city as the spine of a new linear infrastructure system. The transformed Gardiner will gradually be stitched back into the city fabric to disseminate new amenities and activities, facilitating a matrix of events along the waterfront.

Cities

The advent of the automobile in the early 1900s sparked the rapid construction of new roads. Modern cities around the world were experiencing urban population growth and constructed expressways to meet the rising demands of motorists. Enthralled with the notions of speed and efficiency, many urban planners hastily erected expressways without careful consideration for the urban environment. As increasing numbers of people chose the conveniences of the car over public transit, new expressways were soon clogged with automobiles. Decades later, many cities including Toronto began to consider the implications of these urban expressways, realizing that their earlier

obsession with expressway planning had unexpected repercussions. In light of these new considerations, many cities started to make commitments to try to rectify the situation. A selection of four cities have been chosen to present opposing views on abolishing urban expressways or retaining expressways as a means of urban renewal.

At its opening in 1959, Mayor Thomas Menino hailed Boston's elevated Central Artery as "The Highway in the Sky."⁶ The Central Artery was to become one of the most notoriously congested highways in the United States. In 1991 Boston decided to build a replacement tunnel for the elevated highway, and substitute a green ribbon of



parkland aboveground. \$15 billion dollars and one decade of construction later, Boston's vision finally materialized in 2005.

In 2003, Seoul embarked on an urban renewal project to unearth the Cheonggyecheon, a buried river that bisects the capital city. Since the city's founding in the 14th century, growth has always been at odds with the path of the flooding river. Increased traffic forced the city to build a road over the stream in 1958, and again in 1971 with an elevated expressway. The simplest solution to the flooding was to cover the river, but the cost to the health of the river and the aesthetics of the city was immense. The goal of the city's new



Figure 06 opposite left - Boston Big Dig
 Figure 07 opposite right - Seoul Chenggyecheon
 Figure 08 left - London Westway
 Figure 09 right - New York Highline

Restoration Project is to preserve the ecological landscape rather than solve traffic issues. After the roadway's removal, twenty-one bridges and regenerated green space will offer urban oasis to Seoul's pedestrians.

While Boston and Seoul have invested heavily to demolish their urban expressways in exchange for green spaces, other cities have learned to live with their elevated structures. Residents in London's North Kensington district formed a committee to lobby for land to compensate the community for the disruption and damage caused by the elevated Westway. Twenty-three acres of land beneath a mile-long segment of the motorway was granted to

promote recreational facilities, using the expressway as a communal roof. The once derelict landscape under the Westway has since been reclaimed and transformed into a leisure centre.

Another project that inhabits elevated transportation infrastructure is the High Line regeneration in New York City. The High Line is an abandoned railway viaduct built to deliver goods in the 1930s. Rail traffic declined and sections of the elevated railway were rerouted or torn down to accommodate rising development in the 1950s. Over time, the High Line became nature's own renewal project, a tranquil and unobtrusive "Secret Garden." In accordance with this natural development, a new

design for the High Line includes a promenade between planted gardens, providing pedestrians with views of the Hudson River and city skyline along the way.

Demolishing the Gardiner Expressway once and for all would not solve the inadequacies of Toronto's waterfront. Considering the potential benefits of the maintaining the expressway as a right-of-way, as opposed to its costly removal and replacement, a viable option is to repurpose its function. Developed under a strategy of adaptive reuse, the Gardiner can be reinserted into the city fabric as a new and integrated transit system – the first step to re-envisioning Toronto's waterfront.





Chapter Two:

On The Gardiner Expressway

The Frederick G. Gardiner Expressway has in recent years become the most intractable problem facing anyone who wants to bring new life to the Toronto waterfront. It's the largest piece of urban furniture in the city, bigger by far than the CN Tower or the SkyDome, and its enemies see it as a blight on the cityscape. Even more than the railroad tracks, it cuts off the southern end of Toronto and creates a barrier, both visual and psychological, between Lake Ontario and everything else.

Robert Fulford, Accidental City

Toronto's Waterfront

History demonstrates the long-standing conflict between the idea of the city's waterfront as a public amenity, and its role as a major industry and transportation corridor, with the latter often winning out.

Situated on the shore of Lake Ontario, Toronto was founded as a port city dedicated to the shipping trade. When Fort York was built in 1793, several kilometers west of York, Toronto's original settlement at King and Parliament Streets, Front Street ran along the lakeshore.

In 1840, in response to public outrage over private control of waterfront lots, city governors passed a motion to create The Esplanade, a 30m-

wide carriageway set apart from the waterfront. Its purpose was to divide the active port from the commercial and residential city to the north. Creating the Esplanade, however, was the first of many gestures that would eventually separate the waterfront from the rest of Toronto.

A decade later, the Northern Railway laid tracks through the Garrison Reserve lands and along the Esplanade. The harbour became a major industrial hub. The influx of traffic, channeled by the port and rail lines, reinforces the east-west axis as the prime transportation route for people and goods.

In the second half of the 19th century,

landfill spread out and the railways expanded rapidly, further reducing public use of the central waterfront. As commerce and industry flourished along the ports, major landfills further pushed the water's edge from where the tracks run today, creating a new harbour and transforming The Esplanade into a dockyard.

It wasn't until 1925-1930 that a system of viaducts was built to elevate portions of the railroad tracks and a series of underpasses and bridges were built to ease pedestrian crossings. These meagre efforts were made in attempt to reconnect the city to the waterfront. However, the east-west axis and disconnection between

Figure 11 left - planning of Toronto, 1788
 Figure 12 right - central waterfront
 Figure 13 bottom - waterfront movement diagram

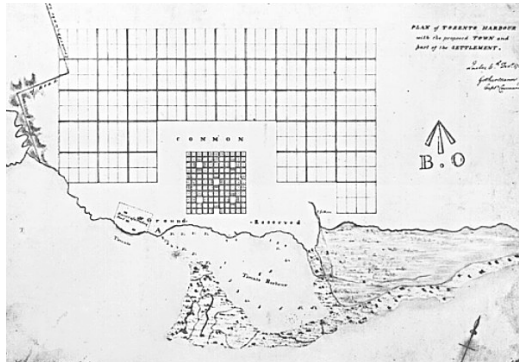

city and waterfront had been reified, and would influence infrastructure planning in the future – including the Gardiner Expressway.

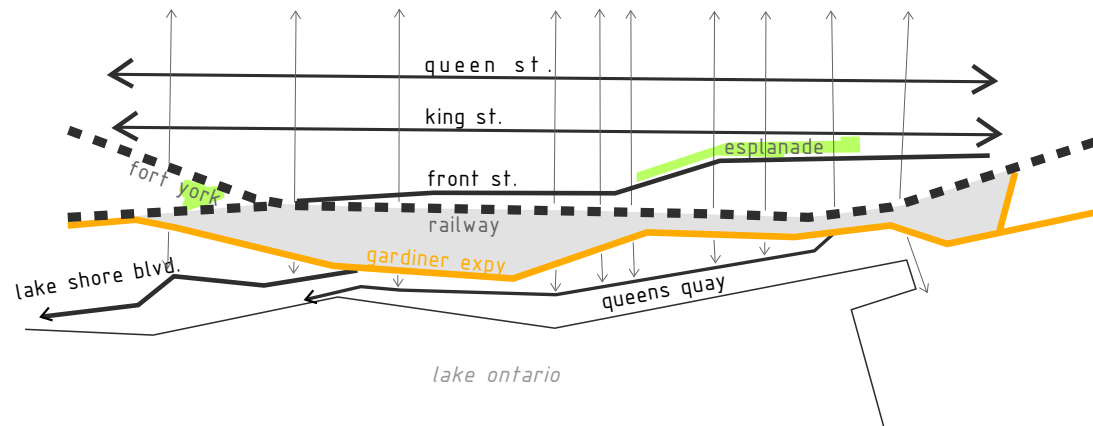

Building the Gardiner

Increase in population as well as the popularization of the automobile followed the Second World War, stressing the capacity of the city's grid. Serious discussions about a limited-access highway system to speed movement of people and goods had already begun in the 1940s, and in 1953, the Gardiner Expressway was initiated, the same years the City of Toronto joined with the surrounding twelve towns to form a federation known as Metropolitan Toronto. Eager to link the various municipalities and foster new growth, Metro's first chairman, Frederick Gardiner, championed the notion of high-speed expressways and supported the building of a

major urban highway infrastructure.

The original proposal was to run the western portion of the expressway directly along the lakeshore, but consensus could not be reached by the engineers, traffic planners, and politicians involved. Consulting engineer Norman D. Wilson, who was against the original proposal, encapsulated the prevailing criticism: "[the expressway is] a good traffic medium, but ... so contrary to the public interest, so devoid of city-planning forethought" that he could not support this proposal.⁷ However, critics of the expressway eventually reached a compromise with the proponents, placing the Gardiner at a

Figure 14 opposite left - Dufferin gates entrance to CNE, 1910

Figure 15 opposite middle - Sunnyside Park, 1949

Figure 16 opposite right - Gardiner passes by Fort York

distance from the waterfront, permitting a range of public uses for the lands to the south of the expressway, thus saving the waterfront to some degree, but still demolishing large swaths of residential areas as well as a number of historic sites in the path of the construction. The community of South Parkdale saw the destruction of 170 houses. Sunnyside Amusement Park, Toronto's "playground by the lake" since the 1920s, was closed down. The triumphal arch that marked the west entrance to Exhibition Place disappeared. Fort York was only saved by preservationists demanding the elevated expressway be routed over its southern tip,



rather than directly through the middle of the site. The result was (and is) a segregation, both physical and psychological, between the urban, social, and cultural fabric of the waterfront and the city itself.

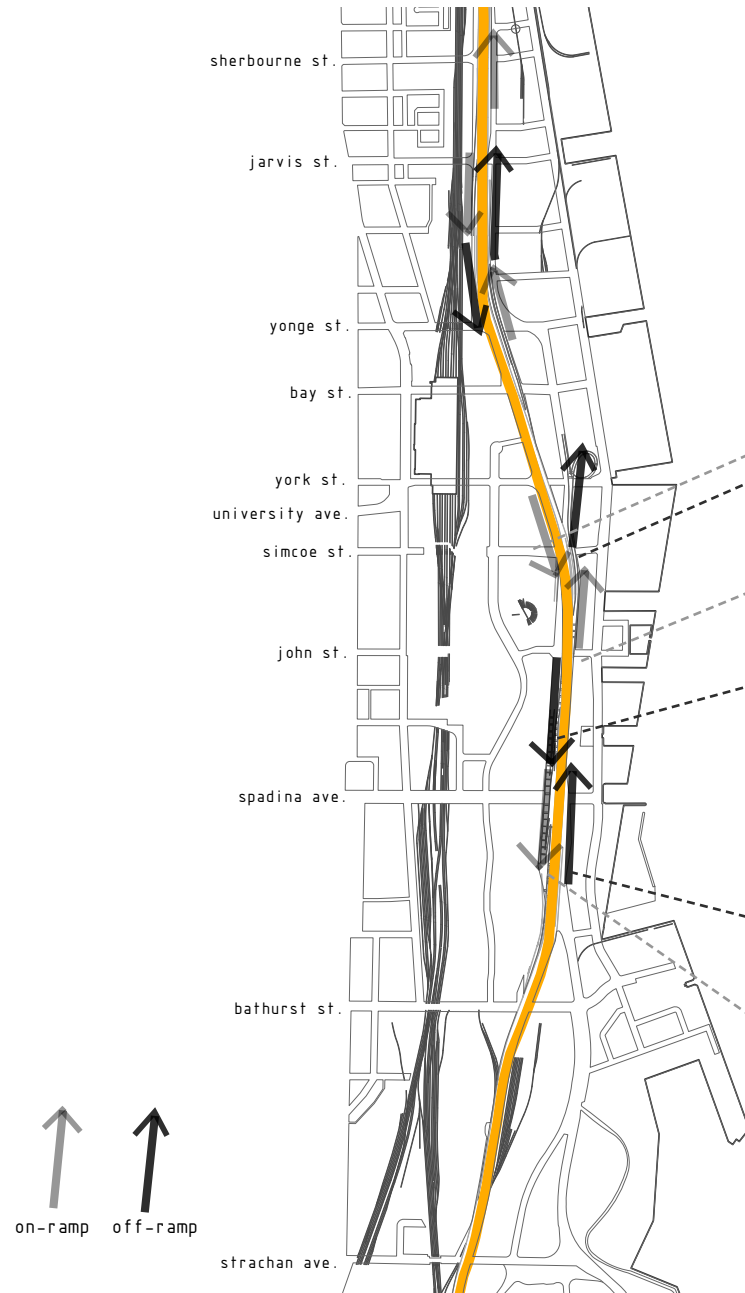

Figure 17 left - Gardiner Expressway on and off ramps

Figure 18 right - Photograph of ramps between York St. and Spadina St.

Enduring the Gardiner

The Gardiner Expressway officially opened in 1964. The total cost of construction was \$110 million – the equivalent of \$700 million today.⁸ Building the expressway was a costly venture, but perhaps the greatest cost borne by the city was the loss of its potentially spectacular and animated harbour. The Gardiner and its surrounding land – in particular the rail lines running in and out of Union Station, and the purposeless swath of land that exist between the rails and the expressway – exist as both a psychological and a physical barrier to the enjoyment of the waterfront and the development of the downtown. Pedestrians traveling south

from the downtown to the waterfront have the choice of crossing this pocked moonscape or being tunneled through dank, poorly-lit passages.

The greatest obstacle to integrating the Gardiner with the city are the numerous on and off ramps flanking the expressway. Severely deterring pedestrian movement, blocking scenic views, and obstructing the roads below, the ramps also make it unfeasible to build directly above, beside, or underneath the expressway. The cumbersome ramps cover an extensive area, limiting the use of valuable land as well as preventing urban growth.

Currently, most of the land adjacent to the



Figure 19 right - Jarvis st. west bound on-ramp

Gardiner is either undeveloped, used for parking, or serving other marginal purposes. These lands, in fact, have been identified by the city as having significant potential for future growth – if the Gardiner could only be modified.



Sustaining the Gardiner

Long-term maintenance and renovations of the Gardiner Expressway, started in the 1980s, cost taxpayers in excess of \$10 million per year. In 2000, in an effort to reduce the burden on taxpayers, the City spent \$44 million to dismantle and re-landscape 1.3 kilometers of the expressway. In spite of this, maintenance costs continue to increase.

According to Canada's News Wire, in 2005 the City of Toronto devoted \$80 million of its \$300 million dollar road repair budget to the Gardiner alone. And none of the above figures account for externalities such as pollution and lost hours of productivity due to traffic

gridlock.⁹ On-going maintenance and closure on the expressway is a severe inconvenience to motorists facing an already congested Gardiner. Sustaining the expressway is an accumulating financial and mental burden that will only grow in the next decade.*

The estimated price of removing the Gardiner altogether, an oft-proposed solution, runs between \$1.2 billion and \$1.8 billion. However, without additional measures to control traffic, the independent re-routing of roads would not solve the imminent problems of razing the Gardiner Expressway.

Figure 20 opposite - Gardiner Expressway 1.3 km demolition

Figure 21 right - Gardiner and DVP closure signage



* Of the estimated 200,000 vehicles that travel on the Gardiner Expressway daily, only 20% actually use the expressway as a thoroughfare to bypass the downtown core. The other 80%, not using the Gardiner as a thoroughfare, contribute to extreme congestion particularly during peak travel hours. Frequent accidents on the expressway bring added stress to already impatient drivers and cause extreme delays that have rippling effects. Idling cars with their unproductive motorists and toxic emissions become an increasing economic burden and environmental hazard to Toronto. The Canadian Urban Transit Association has estimated that congestion costs about \$2 billion annually in lost productivity in the Toronto Region – a figure that will rise to \$7 billion a year within twenty years.¹⁰

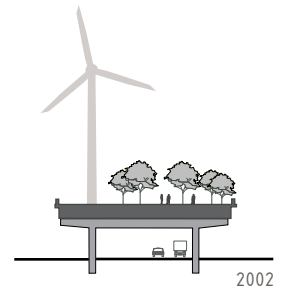
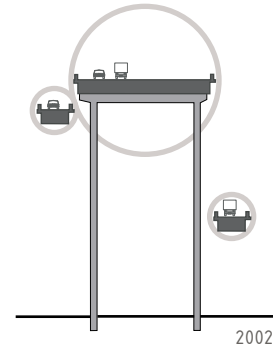
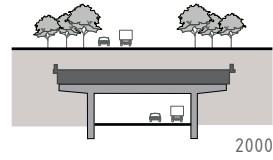
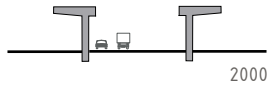
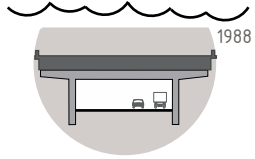
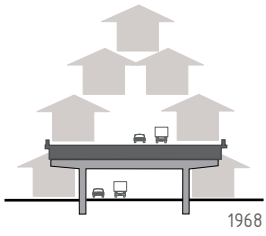

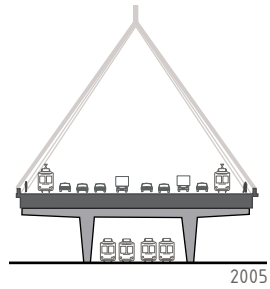
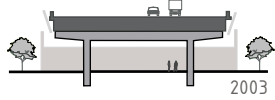

Chapter Three:
On Past Proposals

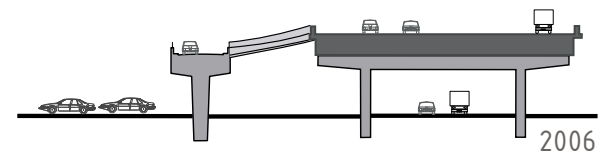

What COULD be done?

In the 1995 book *Accidental City: The Transformation of Toronto*, author Robert Fulford refers to Toronto's Gardiner Expressway as "The largest piece of urban furniture in the city," and as "one generation's dream, another generation's nightmare."¹¹ Fulford's perception on the Gardiner reflects a sentiment shared by many Torontonians – that the Gardiner is a dilapidated monument. As early as the late 1960s, the City of Toronto considered transforming the Gardiner Expressway; today most stakeholders agree it requires some type of immediate remediation.

Proposals have been made to address the Gardiner's deficiencies. Some argue we must

rehabilitate the deteriorating expressway, others call for a radical new function for the structure, others still, razing the structure altogether.

All have merit. But what effects would these proposals have in regards to Toronto's increasing congestion? What do they offer to the economic, environmental, and transit concerns of the city? How do they address the lost waterfront? What can Torontonians gain from these ideas, and from altering the Gardiner?

Contain IT?

URBANIZING THE GARDINER

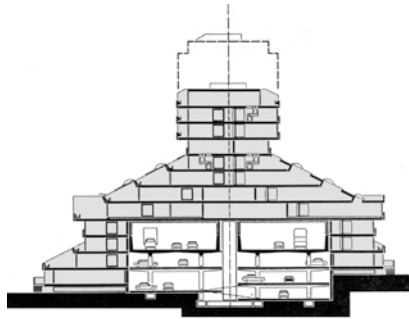

Figure 24 top left - Wilmersdorf Housing Project, Berlin, 1972

Figure 25 top right - Upper Town Lower Town

Figure 26 bottom left - Gardiner contained with housing

Figure 27 bottom right - Tokyo, houses under the highway

In 1986, Toronto architect Paul Reuber put forward a proposal for the City of Toronto entitled, *Urbanizing the Gardiner*. Drawing inspiration primarily from Berlin's Wilmersdorf housing development, Reuber proposed the integration of housing developments into the expressway infrastructure.

Built in the early 1970's, the Wilmersdorf completely encased an existing elevated expressway with residential units. Seven housing blocks, each sixty meters in length, spanned and covered the roadway. These blocks were staggered around the expressway and provided terraced housing units that abutted the structure

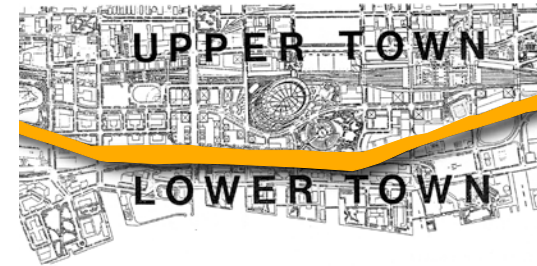

on both sides.

Basing further development on this scheme, Reuber's vision called for housing to wrap below, beside, and above Toronto's elevated expressway. He proposed building housing along the Gardiner to form a walled city that divided Toronto into an "Upper Town" and a "Lower Town". Rather than reconnect the city to the waterfront, Reuber's scheme created a massive barrier that physically and psychologically divided the city.

Submerge IT?

SINKING THE GARDINER

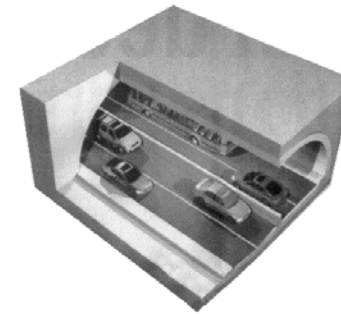
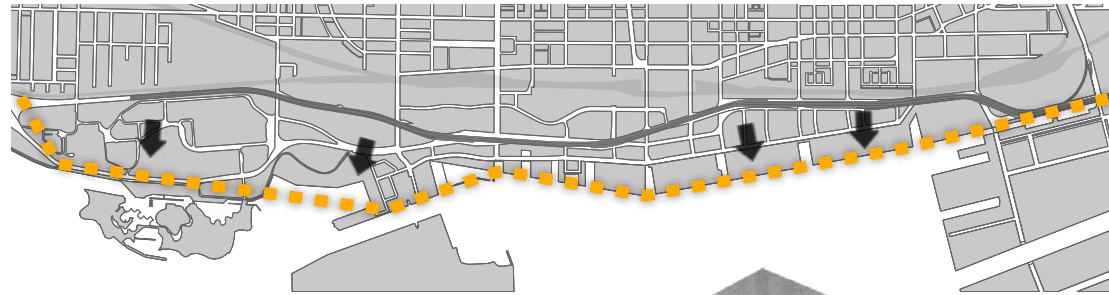

*Figure 28 top - Gardiner submerged under Lake Ontario
Figure 29 right - Gardiner traffic inside 4-lane tunnel*

In 1988, government planners studied a proposal to relocate the Gardiner Expressway into Lake Ontario. A shallow tunnel would be dug just offshore to carry twelve lanes of traffic between the west end of Exhibition Park and the Don Valley Parkway. The path of the tunnel would follow the periphery of the lakeshore, separating through traffic from the city roads. The roof of the tunnel would be planted to provide a landscaped pedestrian walkway over the expressway.

Private developers would offset the cost of building the tunnel by selling the approximately 48 hectares of land under the existing Gardiner,

worth an estimated \$2 billion, enough to cover the cost of building the tunnel four times over.¹² Once redeveloped, the footprint of the Gardiner could then be used for housing developments, commercial activity, green space, and generous parkland.

While running the Gardiner under the lake may be profitable for some developers, its relocation will involve unprecedented traffic re-routing in an already congested downtown. In addition, the potential costs of long-term maintenance of the watertight tunnel pose serious concerns.

Dismantle IT?

DEMOLISHING THE GARDINER

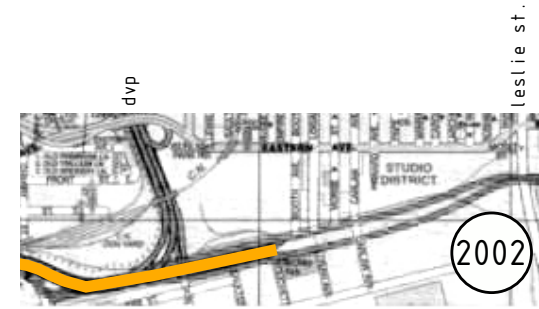

Figure 30 top left - Gardiner's eastern terminus, 2000

Figure 31 top right - Gardiner after demolition, 2002

Figure 32 right - Gardiner under demolition

If the complete demolition of the Gardiner is not feasible, can a long-term process of dismantling be adopted in which parts of the city are slowly stitched back together? Consider the events of 2000. The City concluded, on the basis of long-term savings to taxpayers, redevelopment opportunities, and urban design considerations, the best solution was to dismantle the expressway from the Don River to Leslie Street. The planning policy changes in the early 1970s ceased all expressway construction, including the Scarborough Extension, leaving the east end of the Gardiner in doubt. The removal of the eastern road deck in 2000 not only brought

an end to years of deterioration along the 1.3-kilometer stretch, but also freed up land.

On the north side of Lake Shore Boulevard, a wide pedestrian walkway and bike path exist in place of the ramps previously there. The new walkway is linked to cycling paths in Toronto's Beach community, connecting to the Don Valley park system on the west and the Martin Goodman trails on the eastern waterfront. While removing the expressway in phases would be beneficial in small-scale planning projects, as a larger urban vision, it would delay necessary long-term developments of the waterfront.

Bury IT?

TUNNELING THE GARDINER

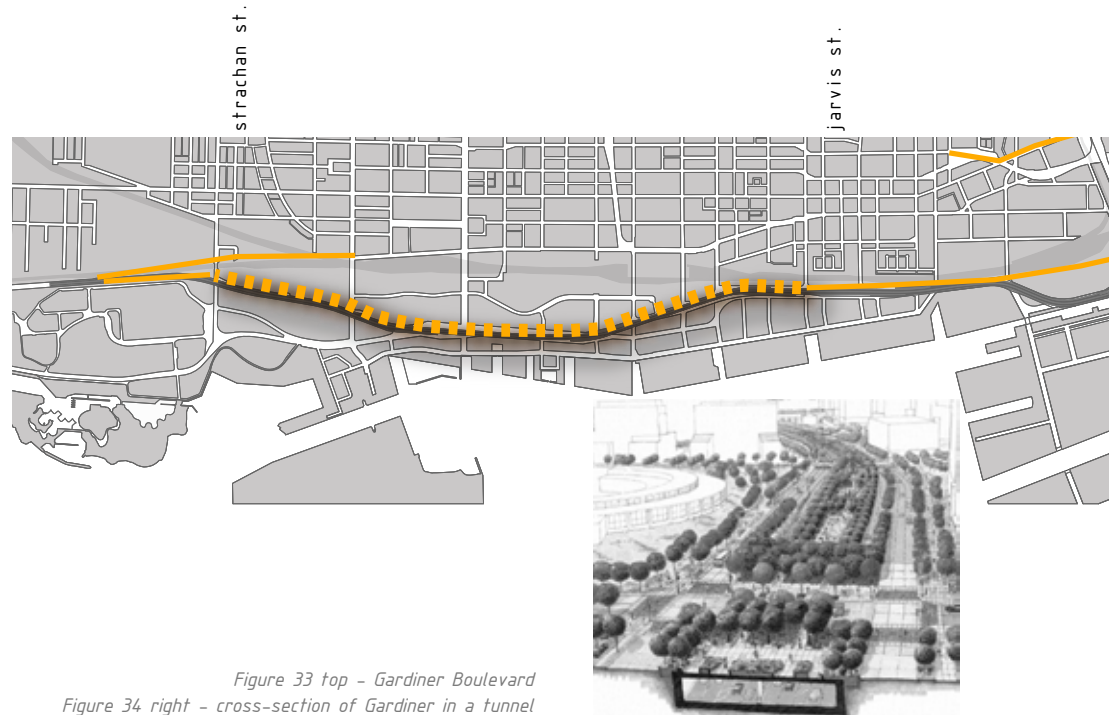

Figure 33 top - Gardiner Boulevard
Figure 34 right - cross-section of Gardiner in a tunnel

The Gardiner Expressway is the primary access point for cars entering the downtown core of Toronto. Because removing it altogether would overwhelm the surrounding grid, most transportation experts agree that plans to alter the Gardiner's carrying capacity can only be realized in conjunction with the proposed Front Street Extension, a new road over the rail lands to connect the QEW with Front Street.

Since 2000, two major dismantling plans have been examined by the Toronto Waterfront Revitalization Corporation, both of which propose to demolish the entire structure and relocate large segments of the highway underground. The cost is in the range of \$1.2 billion to \$1.8 billion. The more costly option is

to run a three-kilometer tunnel under Lake Shore Boulevard between Strachan Avenue and Jarvis Street, and replace it with a landscaped surface boulevard. Because of the enormous costs (again, not taking into account any externalities), neither option is presently seen as plausible.

Burying the Gardiner would involve a complex network of broad boulevards and buried sections, with ramps linking the surface and subsurface roads. If Toronto looks to Boston's "Big Dig" for inspiration, the City should beware of the enormous financial burden – and a host of other, unforeseeable calamities – that it will face.

Raise IT?

SUSPENDING THE GARDINER

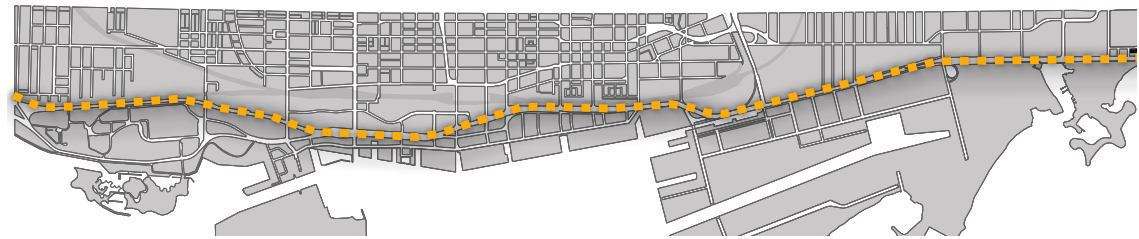

Figure 35 top - Gardiner tubular strand
Figure 36 right - raised Gardiner in tube



Toronto Life magazine published an issue in June 2002 on "Reinventing the Waterfront," and challenged seven design experts to imagine the possibilities in transforming Toronto's waterfront. One visionary designer proposed to "raise" the elevated Gardiner Expressway. "It may sound scandalous," says Bruce Mau, "but raising the Gardiner ... would be more pragmatic and cost-effective than burying it."¹³ Mau reminds Torontonians of the spectacular view of the skyline when we approach the city on the Gardiner Expressway. He argues that the real barrier separating the city from the lake is the row of towering condominiums that have lined the

waterfront. One way to improve sightlines would be to raise the Gardiner up fifteen storeys, and encase it in a transparent tube. The raised Gardiner would resemble a network of floating tubular ribbons, with exit and entrance ramps as smaller ribbons meandering down between the towers of the city.

Mau's fantastical scheme of transforming the Gardiner is driven for spectacle in the urban cityscape. It is one of the first proposals that have allowed the Gardiner to be imagined without an inhibited agenda, a refreshing view far from the concerns of logistics and feasibility.

Reclaim IT?

NURTURING THE GARDINER



Figure 37 top - Miyashita Park, Tokyo

Figure 38 right - Gardiner reclaimed as green space



City worker Barry Lipton worked on repairing the deteriorating Gardiner Expressway for five years. In that time, he envisioned a lush garden park and an incredible pedestrian walkway. He also imagined large wind generators running along the course of the path. The Gardiner would be converted into a citywide green machine, utilizing the lake breeze to generate electricity and effectively reducing greenhouse emissions in the downtown.

This was not the only plan to envision the Gardiner transformed into a piece of 'green infrastructure', a promenade connecting major green spaces such as at Fort York in the west

and the Don River Park in the east along a sinuous passage parallel to the harbour. While such visions make for appealing vignettes, their single-minded approach to dealing with the issues of the Gardiner make them untenable. Simply overlapping a park on one of the most congested roadways in the city ignores the traffic situation. Nor will wind generators account for the costs of maintaining the crumbling structure. Before any of these plans can go beyond the daydreams of eco-friendly designers, a more comprehensive study is required.

Use IT?

INFILLING THE GARDINER

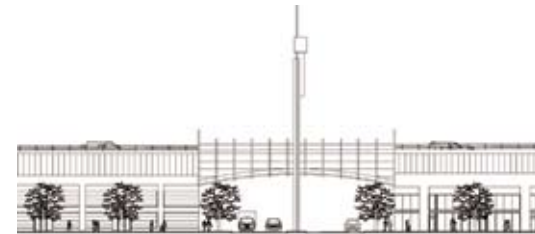

Figure 39 top left - beautify the Gardiner
Figure 40 top right - commercial activity under the Gardiner
Figure 41 right - Gardiner proposed elevation

In 2003, The Toronto Waterfront Revitalization Corporation [TWRC] commissioned Toronto architects Jon Van Nostrand and Brook McLroy to examine the possibility of retaining the Gardiner Expressway. The result was *The Gardiner Expressway Transformation* [GET] study, which concludes that the Gardiner is a barrier to the city and makes recommendations incorporating it into the urban fabric through a series of interventions that promote north-south permeability.

The major recommendation is to realign Lake Shore Boulevard from its current location directly beneath the expressway to provide space for

new amenities, public spaces, outdoor markets, and recreation areas beneath and beside the expressway structure. Accepting the reality that the expressway is not going anywhere in the near future, the GET develops and reprograms Gardiner's site, making the large-scale infrastructure inhabitable at a pedestrian scale; the criticism, however, is that in focusing on the context, the authors of the report have failed to address the Gardiner's current inadequacies as a major thoroughfare.

Rebuild IT?

RECREATING THE GARDINER

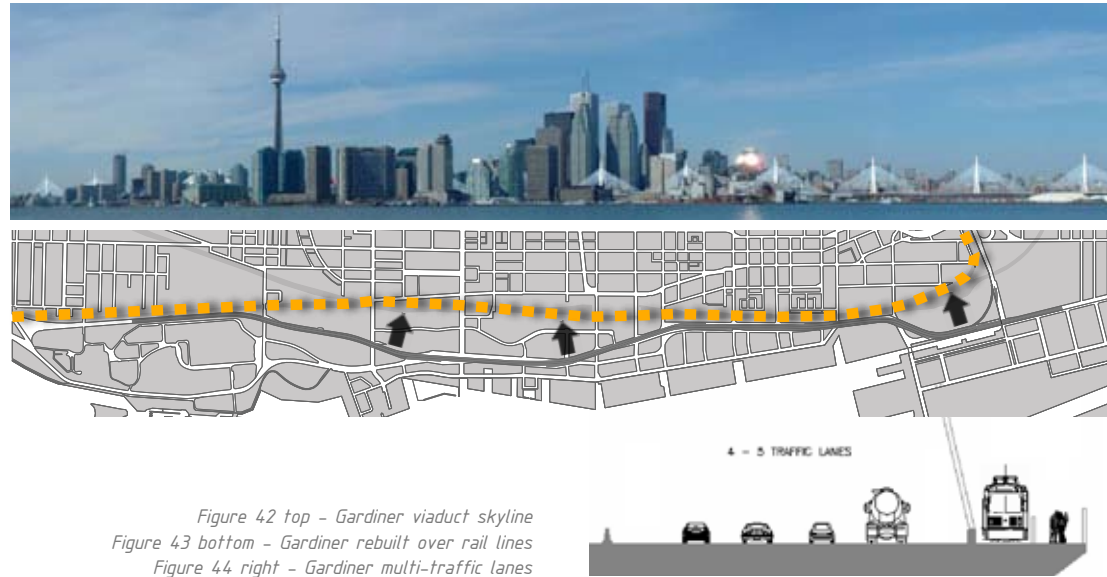
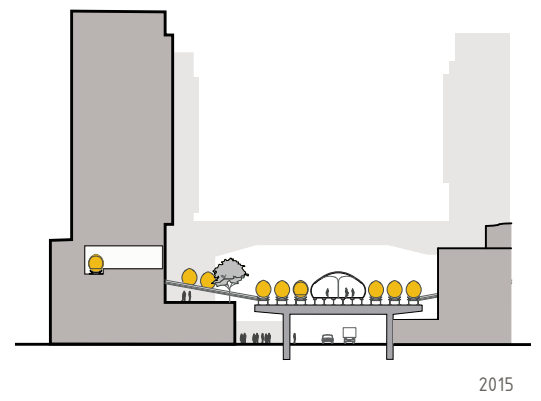
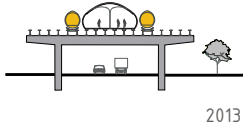
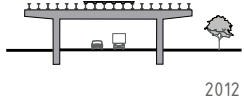
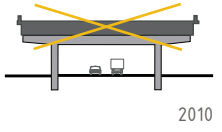
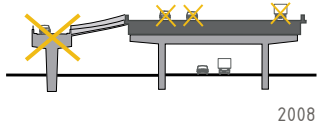

Figure 42 top - Gardiner viaduct skyline
Figure 43 bottom - Gardiner rebuilt over rail lines
Figure 44 right - Gardiner multi-traffic lanes

In April 2005, Toronto engineer Jose R. Gutierrez put forth what he called a “unique right-of-way” to replace the Gardiner Expressway. Gutierrez proposed a new transportation corridor along the existing railway lines just north of the Gardiner, which would consolidate several modes of transportation. Over the rail line, a new ten lane cable-stayed viaduct would include vehicle lanes, a light rail transit line, and pathways for bicycles and pedestrians. The viaduct would carry double the current capacity of the Gardiner, eliminating congestion previously experienced on the expressway. The plan would involve no new land acquisition and would merge the two major

transportation corridors, the railway and the expressway, into one. Once the new viaduct is set in place, the obsolete Gardiner Expressway would be completely demolished.¹⁵

Gutierrez’s superstructure would bring engineering splendour to Toronto’s skyline, but not without financial repercussions. The \$1.65 billion new Gardiner would require major constructions of ramps and roads, bringing with them the same problems caused by the Gardiner’s current system of ramps. Furthermore, doubling car capacity will only feed more cars into the downtown core, merely shifting congestion problems (and not that far) as opposed to eliminating them.



What SHOULD be done?

The most important reason to retain the Gardiner Expressway is because it serves as a grade-separated transportation corridor. Within the city core, Toronto has decided to not expand the current road network to meet increasing automobile use and urban density. Instead, the city will use hydro corridors and existing right-of-ways for future transit development. (A more in depth analysis of Toronto's past, present and future transit initiatives is discussed in the following chapter).

Therefore, in view of the complications and expense of developing a new grade-separated, right-of-way transit corridor at some point in the

future, this thesis advocates the transformation of the Gardiner itself into a new transportation infrastructure along the central waterfront. The proposed ten-year, phased project sets various milestones: eliminating cars on the expressway, implementing a Personal Rapid Transit [PRT] system, with the ensuing stimulation of pedestrian interaction, commercial development, residential expansion, economic growth, and waterfront activity, etc. The rejuvenated Gardiner will become a highly traveled corridor, an engaging trajectory, a popular attraction, as well as an urban destination to enliven the spectacle of Toronto's waterfront.





Chapter Four:

On Public Transport

But if neither more highways and cars, nor more subway lines and rapid rail as we know them today seem to fit our needs, then we either have to alter living habits that have matured over a century, or reconsider the transportation infrastructure so essential to supporting our mobile lives. In either case, we face a profound poverty of vision in planning for our cities.

Moshie Safdie, The City After the Automobile

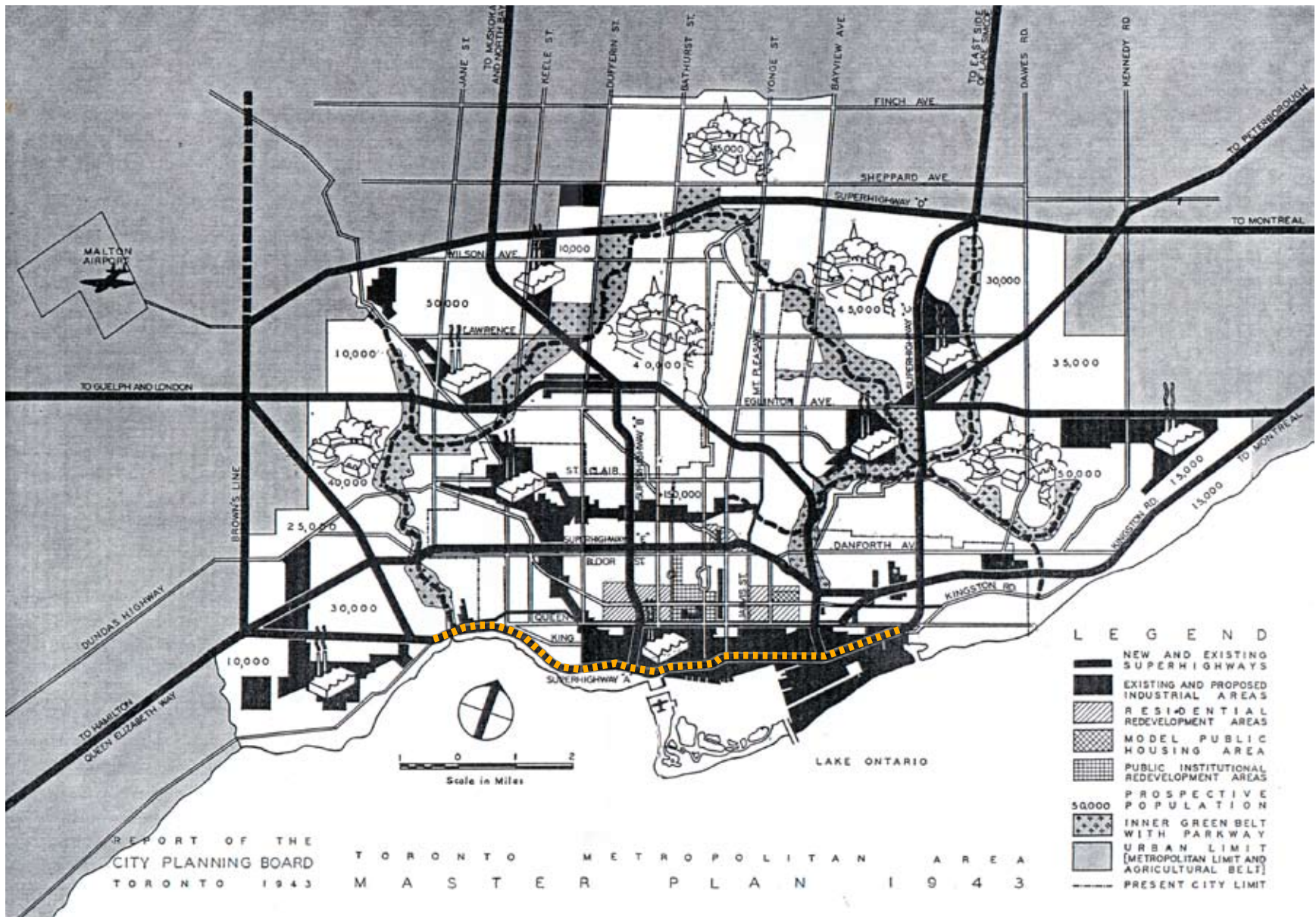

Figure 47 - Toronto Metropolitan Area Master Plan 1943

Superhighway "A" [The Gardiner Expressway], , Superhighway "B" [Highway 400], Superhighway "C" [Don Valley Parkway] , Superhighway "D" [Highway 401], Superhighway "E" [not built]

Superhighway 'A'

The Gardiner Expressway was conceived as part of a larger highway infrastructure, a "Superhighway" system that would connect Toronto's rapidly expanding residential suburbs with its busy downtown. Beginning in the 1940s, increasing numbers of people were living in the suburbs and commuting to work in the downtown area. The configuration of the Superhighway was intended to create a web-like system to ease the flow of traffic into and out of the city. The highway system would be a grided network radiating outward from the downtown core.

The initial point of focus was the entrance to the Queen Elizabeth Way at Lake Shore

Boulevard. Traffic transferring onto the QEW caused congestion back to Kingston Road on the eastern portion of the waterfront. The absence of a high-speed route connecting the two was a major problem. As a result, in the Master Plan of 1943, city planners decided a "Superhighway A" would link the two roadways.

In 1956, Superhighway A, the first component of the Toronto's Superhighway system, was set in place. Later renamed Lake Shore Expressway, and known today as the Gardiner Expressway, it would accommodate traffic passing through the central core, from the QEW in the west to Leslie Street in the east, and, eventually, onto

Figure 4.8 - QEW merges with the Gardiner



Highway 401 in eastern Scarborough; a seamless system transporting commuters to and from the peripheries of the city.

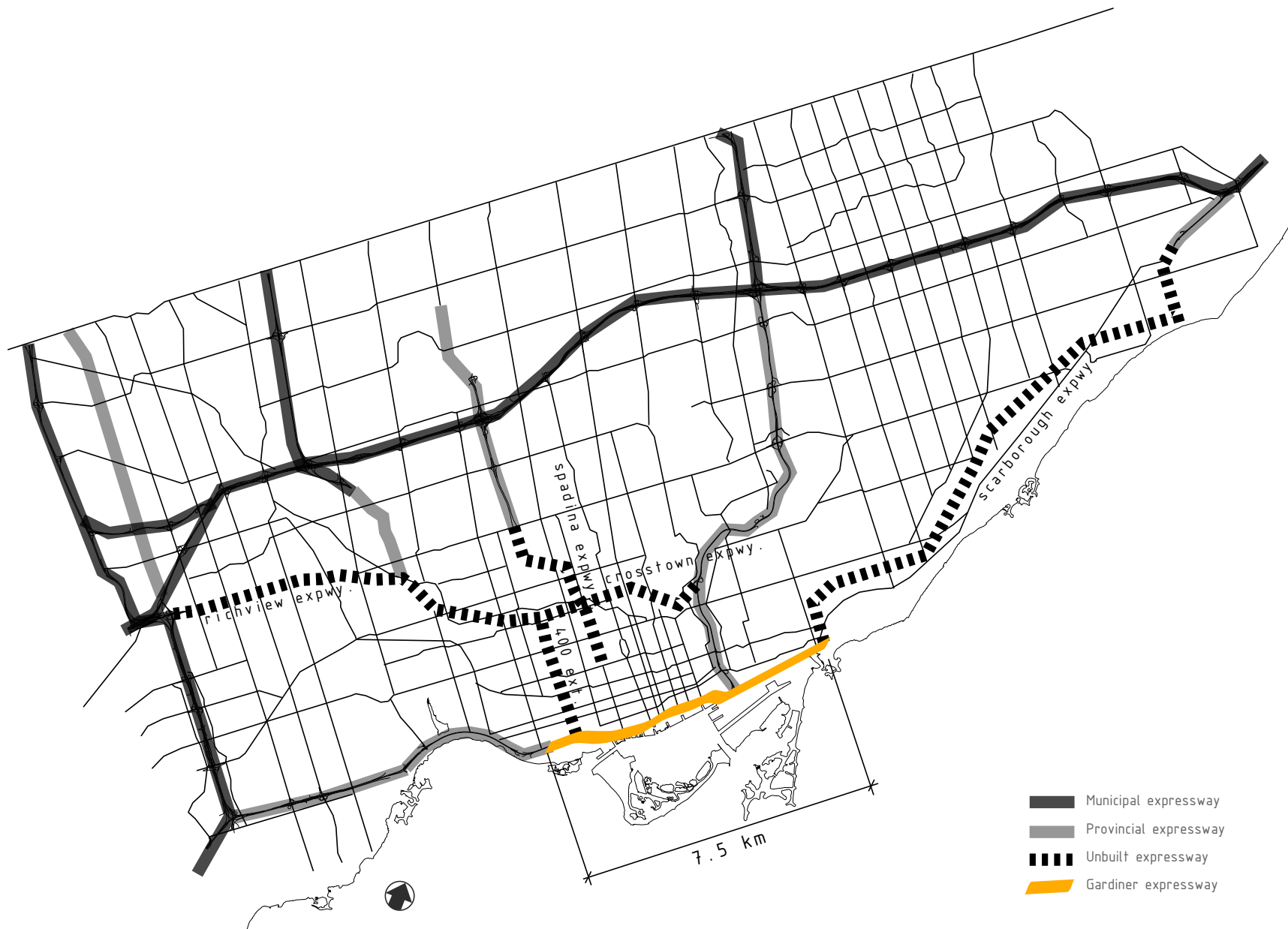

Figure 49 - Toronto expressways

Anti-Expressways

Municipal highways continued to be built from 1954 to 1976, but planners only succeeded in erecting fragments of the originally planned system. The Gardiner Expressway was the first completed segment. A Spadina Expressway was to connect the Gardiner to the north, and a Scarborough Expressway was to extend it to the east. By the early 1970s, both projects were cancelled, leaving the Gardiner as a dangling conduit rather than a citywide east-west highway carrying through traffic. The cancellations were a result of budget constraints and, more importantly, public resistance, which sought to save such iconic Toronto neighbourhoods as

Forest Hill, Rosedale, and the Annex from the fate that had befallen Parkdale.*

The highly controversial Spadina Expressway was intended to connect central Toronto with the rapidly growing suburbs in the northwest, as the Don Valley Parkway [DVP] connected with the northeast. Never completed, the Spadina Expressway was abbreviated as the Allen Expressway, running from north of Wilson Avenue to Lawrence Avenue, mainly to serve Yorkdale Plaza. The failure of the Spadina Expressway sounded the death knell to all subsequent expressway building and planning. Toronto's "Superhighway" system was never completed,



*Figure 50 top - anti-expressway protestors
Figure 51 bottom - demonstration at City Hall, 1970*

the ideal of a composite highway infrastructure abandoned.

* The 'Stop Spadina and Save Our City' group voiced the disapproval of the number of homes relinquished by expressway routes, and the increasing cost to build them. Urban sociologist Jane Jacobs led rallies against the construction of expressways at City Hall, campaigning to preserve the value of urban neighbourhoods in the downtown. Jane Jacobs saved areas such as Forest Hill, Rosedale and the Annex from falling to the similar fate of Parkdale, the once affluent neighbourhood by the waterfront that was destroyed by the arrival of the Gardiner Expressway. Parkdale was spliced from its lakeside parkland, and became one of the poorest areas in Toronto – its land expropriated to erect social housing.

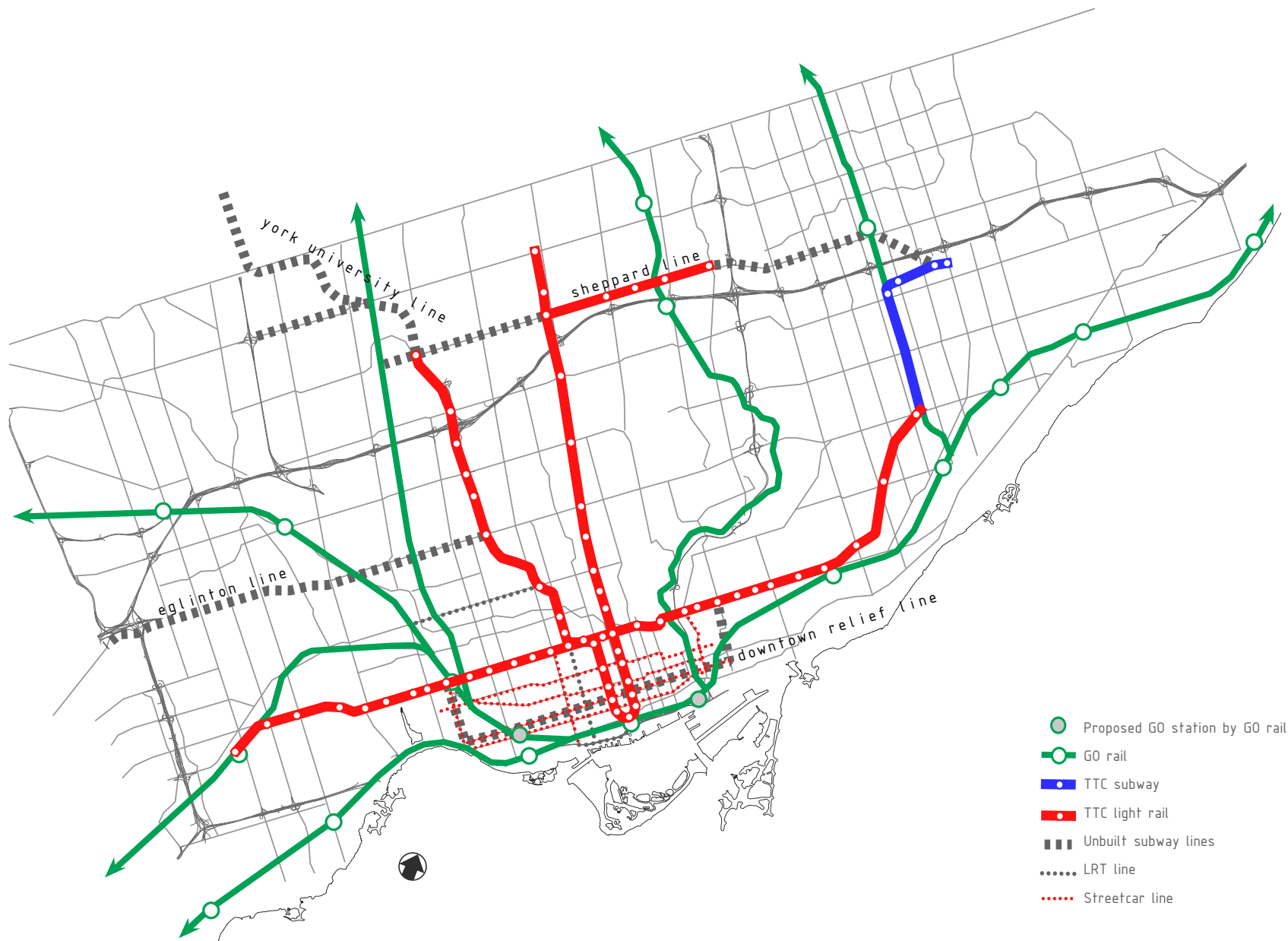

Figure 52 - 2006 Toronto Rapid Transit & GO Rail

Public Rapid Transit

Expressway opponents have long argued Toronto should promote public transit to save neighbourhoods, minimize car use, and reduce pollution. The Spadina Expressway dispute in the early 1970s represented a watershed in the City's attitudes towards planning and infrastructure. By 1980, the proposed Superhighway system was discarded in favour of a strictly public transit-oriented system. The City's two major subway lines were near completion, establishing a framework within the core of Toronto that would eventually extend to regional commuter lines serving the growing suburbs.

In 1985 Metro endorsed an ambitious subway

expansion plan called "Network 2011." The expansion included the Sheppard Line, the "Downtown Relief" Line (operating south from Pape Station to Union station and continuing west and up to Dundas West station), and an Eglinton Rapid Transit Line, linking together developing neighbourhoods and going all the way to Pearson Airport. The latter two have not at all been realized; the former only in part: a short, costly segment of the proposed Sheppard Line was completed in 2002 – eight years after the scheduled opening of the entire line.

While billions have been invested in subways and other forms of urban mass transportation



Figure 53 – elevated GO Rail over the Don Valley Parkway

with positive results, the expansion of such systems – which are already strained by inadequate maintenance funding – is disruptive and costly. Nonetheless, transit planning remains a priority for Toronto's future growth. Focusing on new technology and transit strategies, the three levels of government committed in 2004 to invest \$1.2 billion to improve, modernize, and expand the GTA's transit infrastructure.¹⁶

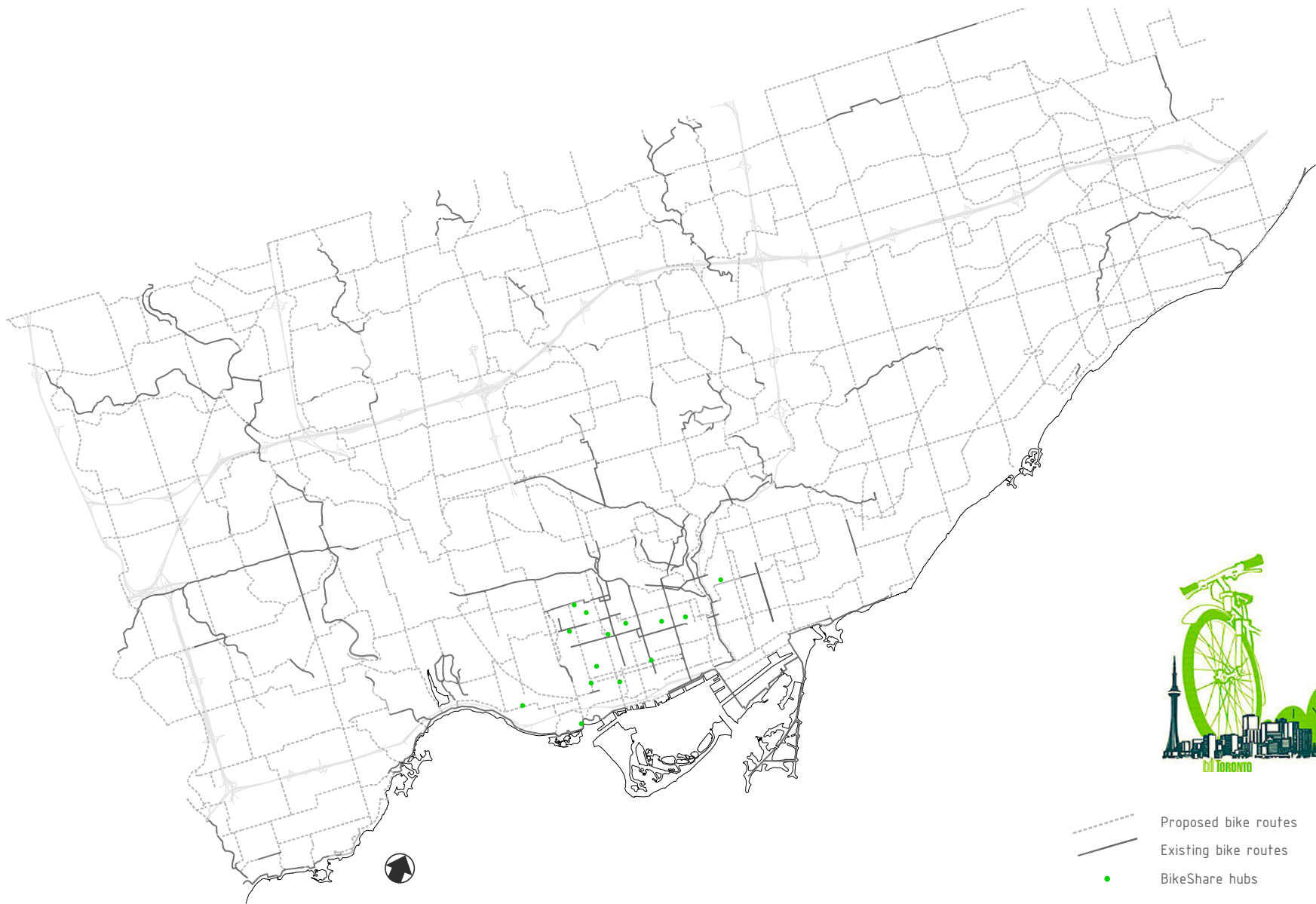

Figure 54 - Toronto proposed bicycle network

Bicycle Network

Traditional transportation planning tends to focus on the demand for motorized travel and public transit. Alternative travel modes, however, are becoming more prevalent, and are encouraged in Toronto's latest Official Plan and the Toronto Waterfront Revitalization Initiative.* A major objective in the field of bicycle transportation planning is to "actively stimulate increased use of bicycles for routine trips." A cycling survey, conducted by the City of Toronto in 1999, revealed that approximately 62 percent of households in Toronto own a bicycle, and that there are over 939,000 adult cyclists within the City.¹⁷

Envisioned in 1894, cycling activist F.R.

Ward conceived of a 60 mile bicycle trail that extended across the core of the city, urging the use of bicycles as an integral part of Toronto's transportation network. Yet only in year 2001 has the City of Toronto adopted a 1,000 km citywide bike plan to include 495 km of dedicated bike lanes – of which 59 km are built to date.¹⁸ Even over a century after Ward's proposal, Toronto is still lacking the immediate infrastructure to accommodate urban cyclists. However, the plan strives to provide a comfortable and safe cycling infrastructure that will assist cyclists across highways, rail corridors, and ravines, with better links to transit services and convenient bicycle

Figure 55 top – Cyclists Handy Road Map, F.R. Ward, 1894
Figure 56 bottom – Bike for Heart marathon, June 4, 2006

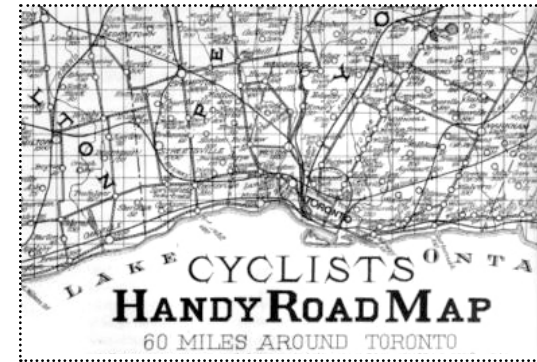

parking facilities to stimulate future "bike and ride" trips within the city.

* Many community programs and cycling events have been initiated to promote cycling as a cost effective and healthy alternative to the car. BikeShare is a Toronto bike-lending program launched in 2001 by the Community Bicycle Network, offering its members the use of bikes for up to three days at a time. There are currently fifteen hubs downtown that provide rentals and biking amenities. Another organization, The Heart and Stroke Foundation of Canada, hosts an annual one-day bike marathon along the elevated Gardiner Expressway and a section of the Don Valley Parkway. In June, 2006, over 13,000 cyclists traveled on a completely car-free Gardiner Expressway – a transient example of a dedicated cycling infrastructure.

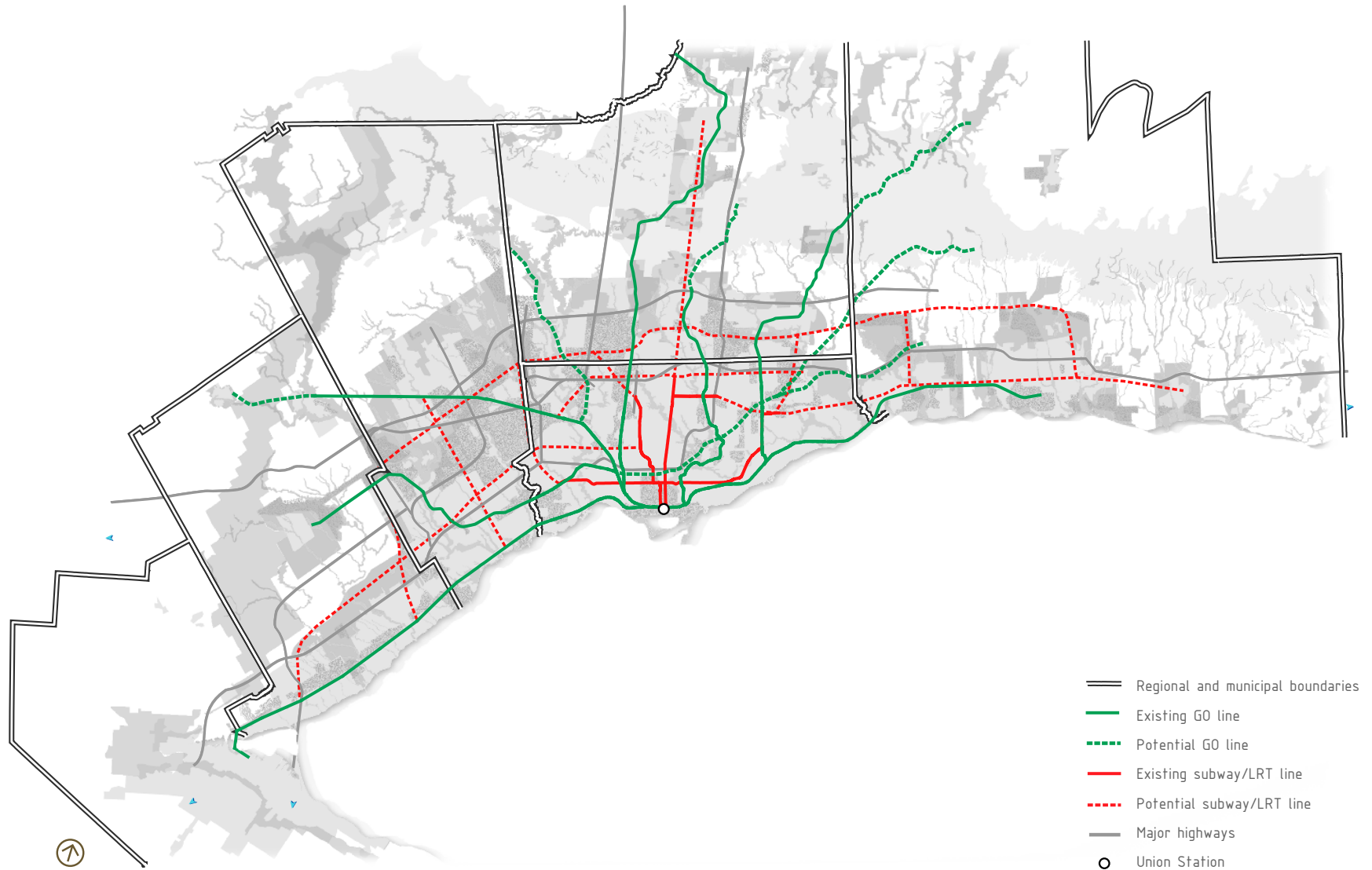

Figure 57 - GTA regional connections

Regional Connections

Toronto depends on an integrated regional transportation system to move people and goods efficiently into and around downtown. Many of these feeder routes and transit modes converge at Union Station, making it Toronto's largest and most dynamic urban transit hub. GO Transit has become one of the foremost regional transit operators, carrying over 190,000 commuters to Union Station daily. Operating on seven routes, the inter-rail line reaches towns up to 100 kilometers from Union Station. Within the Greater Toronto Area, the TTC services 1.3 million commuters daily on its various bus routes, streetcar lines, subway lines, and rapid

transit line, many of which also pass through Union Station.*

In the coming decades, investing in transit will be the first priority for a growing Toronto. The City will seek to integrate various networks to increase transit ridership, manage congestion, reduce commute time, and provide accessible transport alternatives to the automobile. The commitment to boost transit will also focus on "intensification corridors" to develop rapid transit routes with advanced technological systems that are cost effective and environmentally sustainable.²⁰ Union Station will expand its current facilities to accommodate a waterfront transit

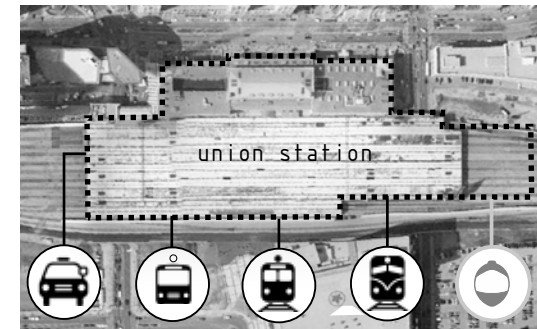
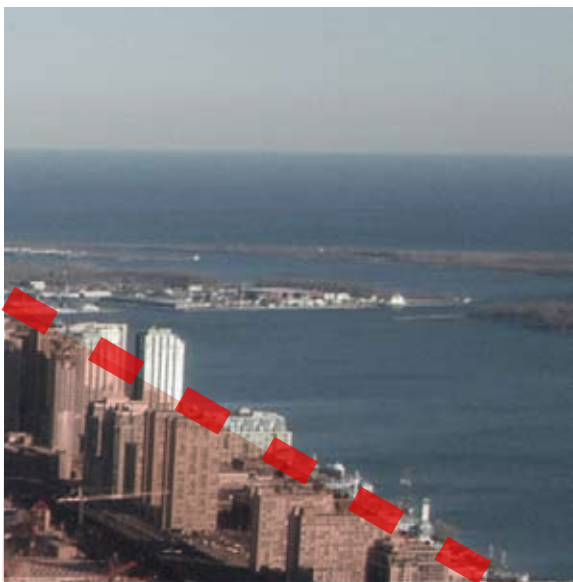

Figure 58 - Union Station multi-modal hub

infrastructure. The expansion will accommodate future passenger flows, which the City expects to increase 80 to 90 per cent by 2021. The future of Toronto's downtown and the success of its waterfront redevelopment will be depend largely on improved transit interventions that are innovative and well integrated into the current system at both local and regional scales.

* The number of passengers is expected to double over the next 20 years. If these riders were to drive motor vehicles, 48 lanes of highways would need to be implemented to accommodate the increase traffic volume.¹⁹





Chapter Five:

On New Policies and Planning

A transportation plan for the future of Toronto must above all address the unacceptable level of congestion experienced throughout the city. It must also address how we can cope with the anticipated growth in population and the increase in travel demand that growth will create.

Sam Cass, Commissioner for Roads and Traffic Engineering

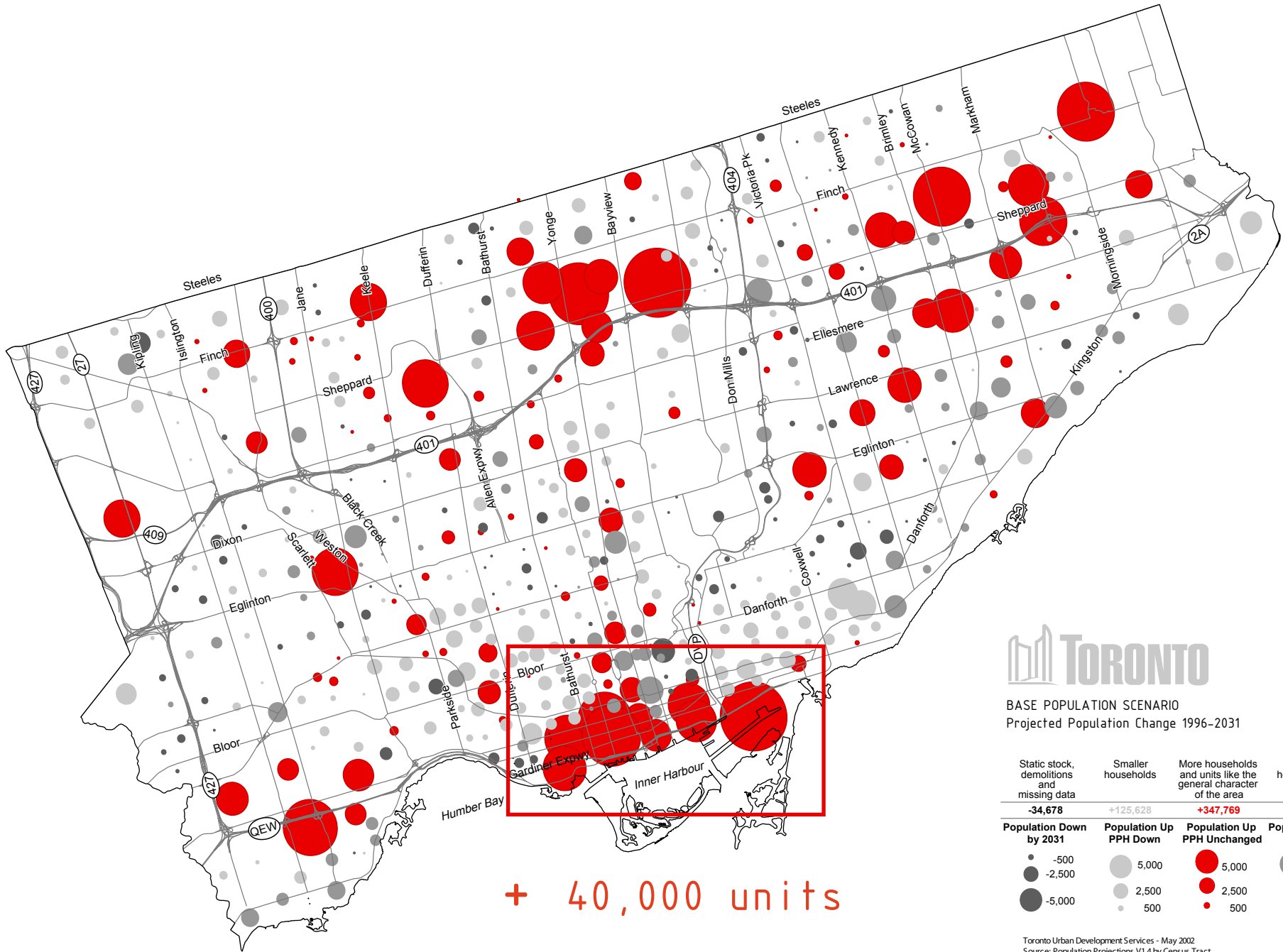

BASE POPULATION SCENARIO
Projected Population Change 1996-2031

Static stock, demolitions and missing data	Smaller households	More households and units like the general character of the area	Larger households
-34,678	+125,628	+347,769	+82,971
Population Down by 2031	Population Up PPH Down	Population Up PPH Unchanged	Population Up PPH Up
<ul style="list-style-type: none"> ● -500 ● -2,500 ● -5,000 	<ul style="list-style-type: none"> ● 5,000 ● 2,500 ● 500 	<ul style="list-style-type: none"> ● 5,000 ● 2,500 ● 500 	<ul style="list-style-type: none"> ● 5,000 ● 2,500 ● 500

Toronto Urban Development Services - May 2002
Source: Population Projections V1.4 by Census Tract

Figure 60 - GTA Population Projection, City of Toronto

Waterfront Density

The 2002 Toronto Official Plan predicts the Greater Toronto Area's population will grow from 4.8 million to 7.5 million by 2031. Toronto will receive 20% of the increase (537,000) and 30% of the employment growth (544,000 additional jobs). To accommodate demands on the downtown transportation infrastructure, the City will rely on a twofold strategy: allocate more housing in the central urban area, thereby reducing the need for long-distance commuting, and improve transit services during peak-travel from beyond the central core.²¹

Responding to the plan, The Toronto Waterfront Revitalization Initiative is planning

40,000 new housing units in the Port Lands, East Bayfront, and West Don Lands districts.²² Other mixed-use waterfront developments are taking place as well in Liberty Village, St. Lawrence neighbourhood, and the Distillery District. In the central waterfront area south of the rail tracks, condominium construction is rapidly increasing, led by a substantial development known as Concord CityPlace – a \$1 billion community development.

The condominium is becoming the preferred form of urban dwelling, attracting suburbanites back to the city. Considering the density of this kind of setting, car travel becomes impractical. If walking, biking, and transit are to be the new

Figure 61 – Concord CityPlace, 2010



alternatives, however, major improvements must be in order. The proposed Gardiner Personal Rapid Transit system will respond to the influx of density along the waterfront corridor.

URBAN relates to an intensively developed area and is used synonymously in the text referring to "downtown."
CITY is the inhabitants of an urban community considered as a group.
[CITY of] TORONTO is the city proper created by the amalgamation of six former municipalities to form one government.
GREATER TORONTO AREA [GTA] is the metropolitan area which encompasses the City of Toronto as well as its surrounding regional municipalities.

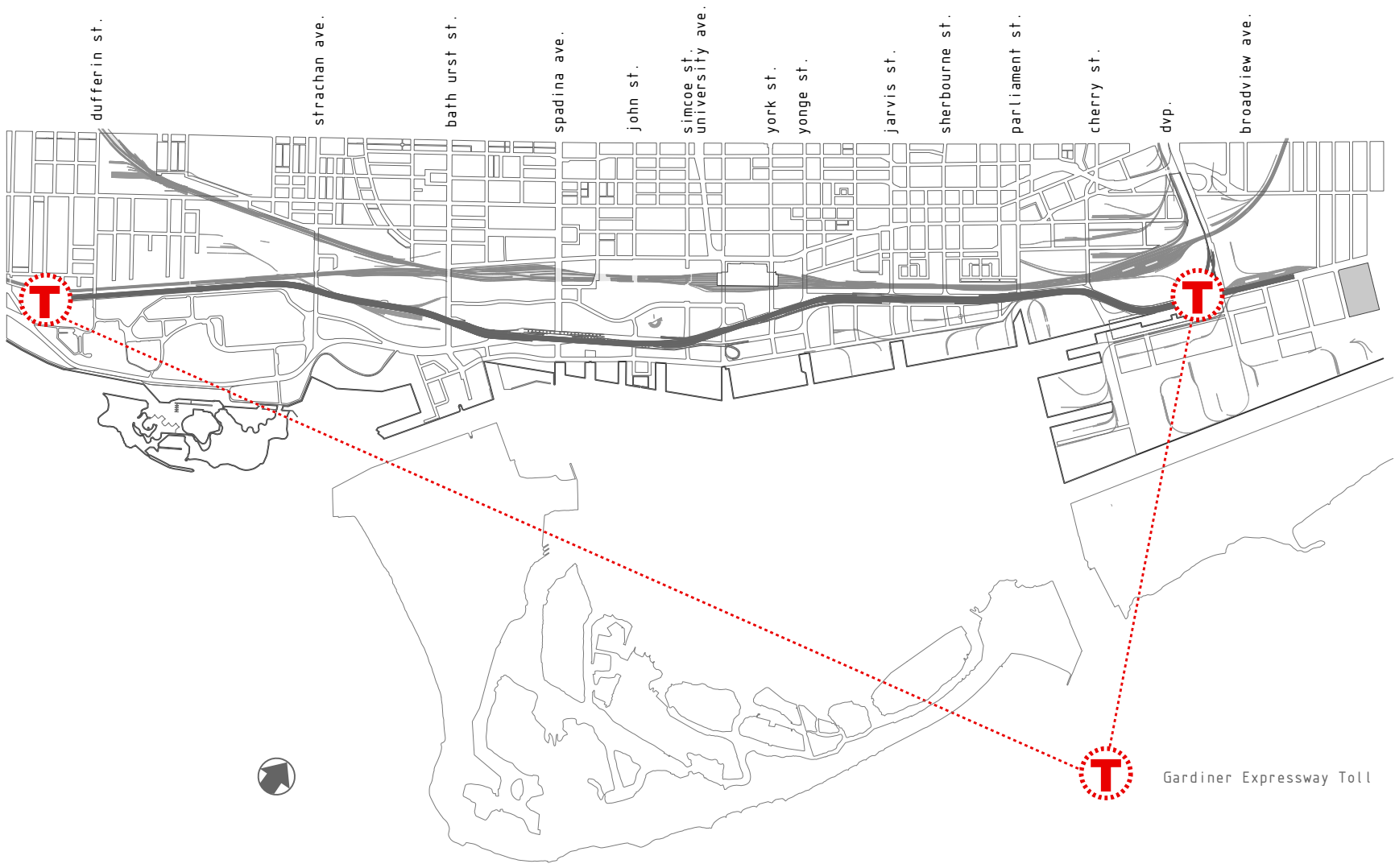

PHASE 1 - 2006

Figure 62 - Gardiner Expressway Toll

Gardiner Expressway Toll

The Gardiner Expressway is the main vehicular link on the waterfront, delivering traffic to downtown Toronto. Though it was originally planned as a thoroughfare, it is now regularly congested, with high volumes of traffic during most hours of the day: 200,000 vehicles travel on the Gardiner Expressway daily, 6,000 per hour on average in each direction.²³

The first measure to control congestion in downtown Toronto is to impose a Gardiner Expressway Toll, based on the successful example of the Highway 407 Express Toll Route.* Using a similar transponder system, drivers will be able to coordinate the Toll routes as

well as future collection systems pertaining to motor transport. The transponder is activated by electronic sensors located at entry and exit points on the Gardiner Expressway. Major overhead gantry structures will be installed at the east junction point with the QEW, and at the west junction point with the DVP. Vehicles without transponders will have their trips logged using a license plate recognition system.

Without hiking fuel tax, governments cannot expect congestion problems within downtown Toronto to improve in the coming decades. Imposing the road toll is an initial strategy to deter commuters from entering downtown

Figure 63 - Gardiner Expressway Toll System gantry



Toronto by car. The objectives of the Gardiner Toll are to reduce traffic during peak hours and to generate funds for implementing the Front Street Extension.

* The 407 ETR uses a system of cameras and transponders to levy a toll on vehicles. Over 725,000 transponders have been distributed to motorists in the GTA, indicating that many motorists are familiar with the concept of a highway tolling system. The open road tolling system generated \$383 million in 2004.²⁴

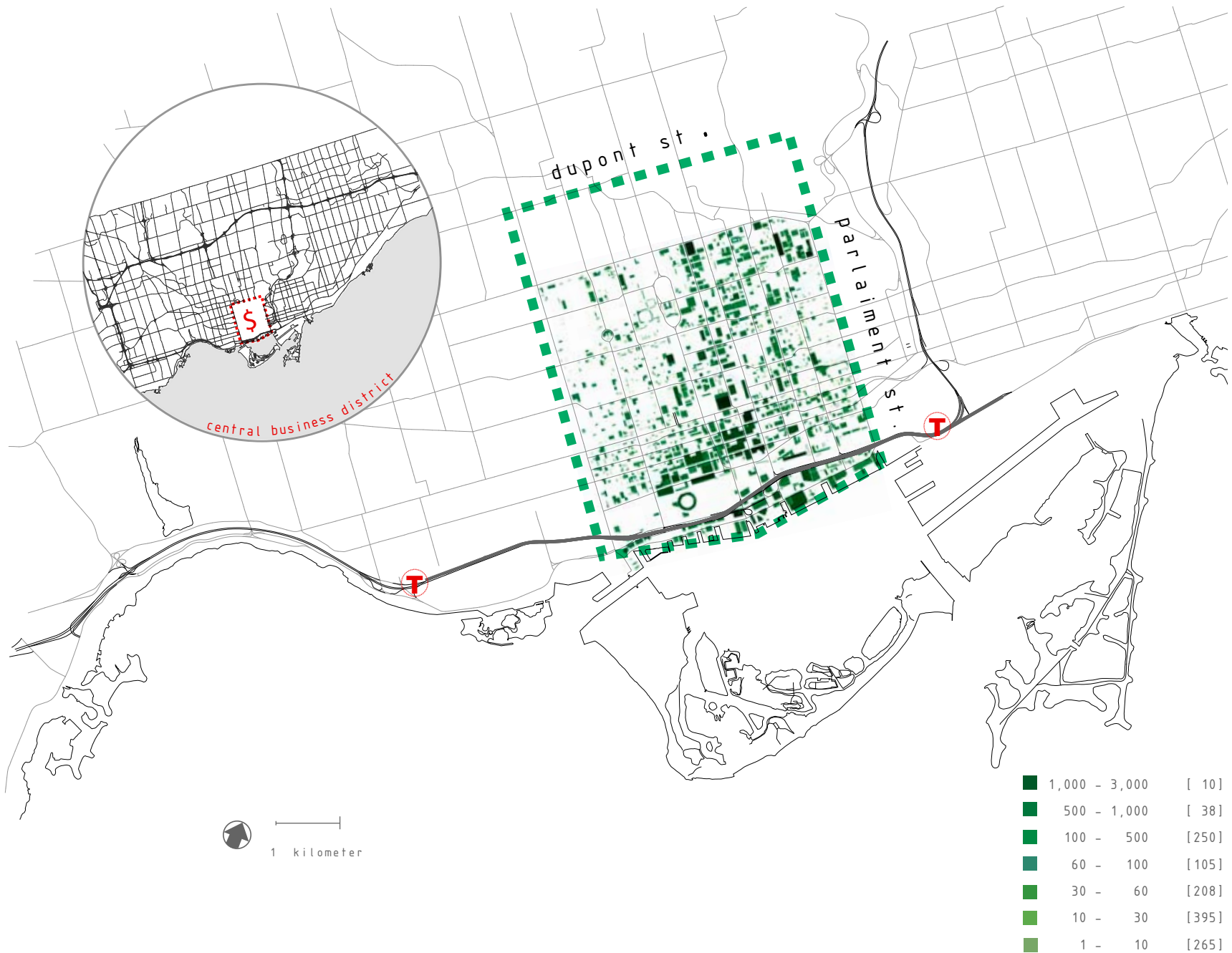

PHASE 2 - 2007

Figure 64 - Toronto Parking Authority
CBD parking spaces

CBD Parking Levy

Despite widespread belief to the contrary, Toronto is still an inexpensive place to park a car. Chicago, a city slightly larger than Toronto (2.9 million to 2.5 million), has a median daily parking rate of \$25 US; Toronto's is \$16 CAN.* One reason for the discrepancy is the existence of the City's regulating body, the Toronto Parking Authority [TPA], the largest Municipal Parking operator in North America. The TPA provides about 50,500 parking spaces in surface lots, garages, and on-street parking. The Authority also manages, on behalf of the TTC, 12,500 spaces at its park-and-ride facilities, and other spaces on behalf of the City's Parks and Recreation Department.

The mandate of the TPA is to be self-financing from parking revenue, rather than to rely on a municipal tax base to fund its development or operation. Since 2001, 75% of the yearly net profit has been returned to the City's general reserves, to be allocated to improving roads and expanding transit. For the 2005 fiscal year alone, the City of Toronto received \$34.3 million from the TPA.²⁶

After the Gardiner Toll is in operation, the next measure in controlling congestion is to impose surcharges on parking in Toronto's Central Business District, enforced by the TPA. Surcharges dependent on time of day and



Figure 65 - Toronto Green 'P'

locations within the downtown zone will influence parking habits. Decreases in traffic will ease congestion within the downtown, and drivers will pay their share for road infrastructure. The Parking Levy and Gardiner Toll will promote car-pooling, and put a dent in the city's sprawl by providing one more incentive for commuters to move into the city.

* Colliers International's 2005 Parking Rate Survey indicates that parking garages in North America are, on average, increasing the charge to park. The survey included 58 markets across North America (48 in the U.S. and 10 in Canada).²⁵

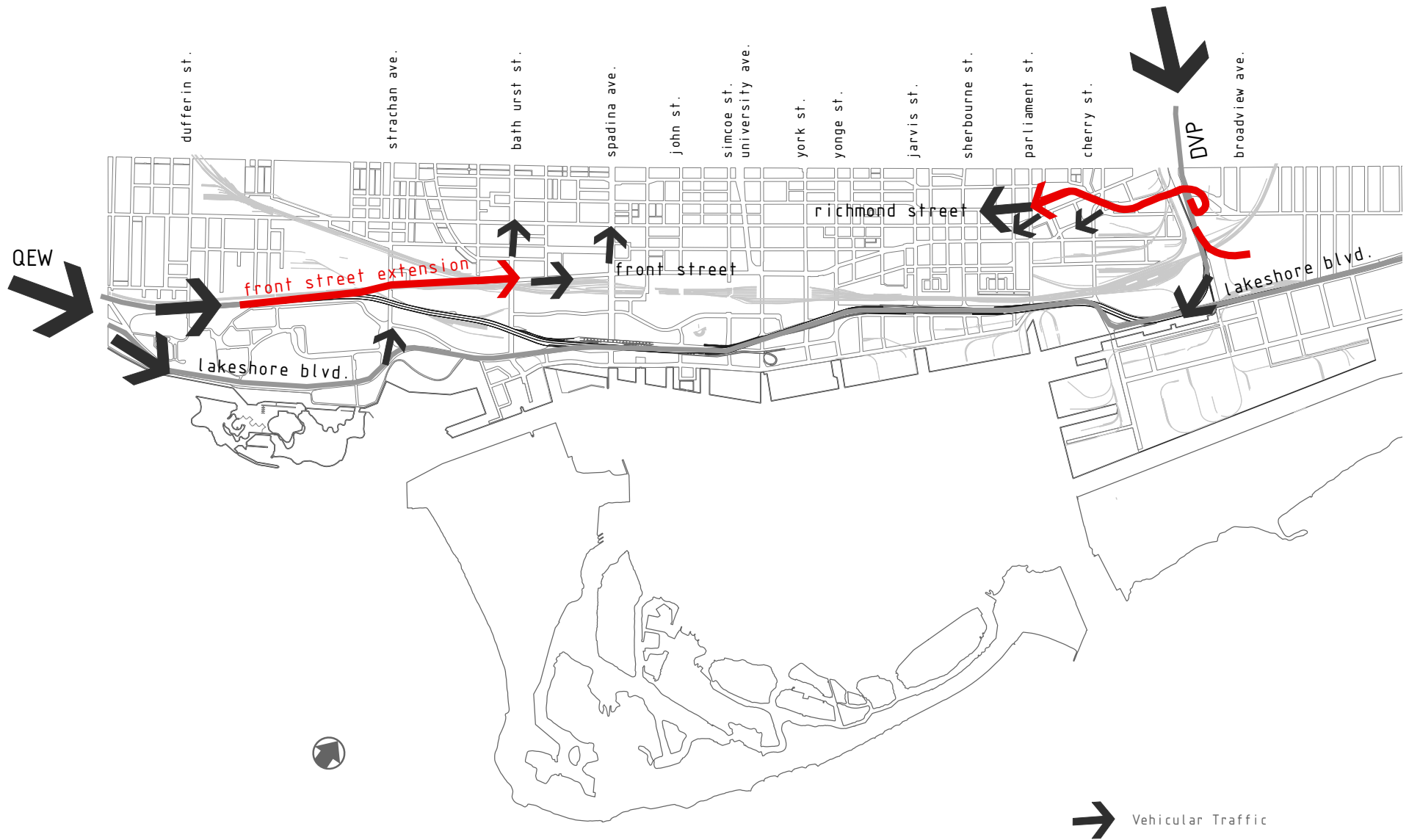

PHASE 3 - 2008

Figure 66 - Front Street Extension & Don Valley Parkway Improvements

Front Street Extension

If the Gardiner is not to carry vehicles in the future, measures must be taken to divert the traffic entering from the west and from the north. Traffic planners and engineers propose the Front Street Extension plan, a two-kilometre extension of Front Street west from Bathurst Street to Dufferin Street, merging with the Gardiner Expressway in a new interchange adjacent to Exhibition Place.

The extension would provide a direct entrance to downtown and better access to emerging development areas in the vicinity. The path of the extension is designed to minimize disruption of the urban fabric by running over the hydro

right-of-way and under existing rail tracks. The estimated \$265 million cost, which for years was the major obstacle to realizing the project, is to be fully funded by the revenues from the Gardiner Toll and parking surcharges.

From the north, the transition of traffic from Don Valley Parkway [DVP] into downtown must also be improved. The DVP interchange at Richmond Street and Adelaide Street will be expanded to accommodate the increase in traffic and further south, at the lower East Don Lands, new on and off ramps will be built to provide a smooth transition from the parkway to the arterial roads and new parking facility.

Figure 67 - Front Street Extension

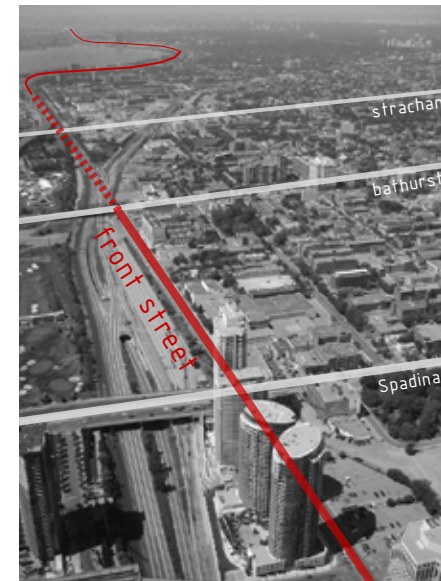

Apart from the aforementioned road improvements, Lake Shore Boulevard will remain the waterfront's main artery. All these initiatives will be taken to divert traffic from the waterfront; reducing car traffic will enable more public open space for pedestrians and cyclists.

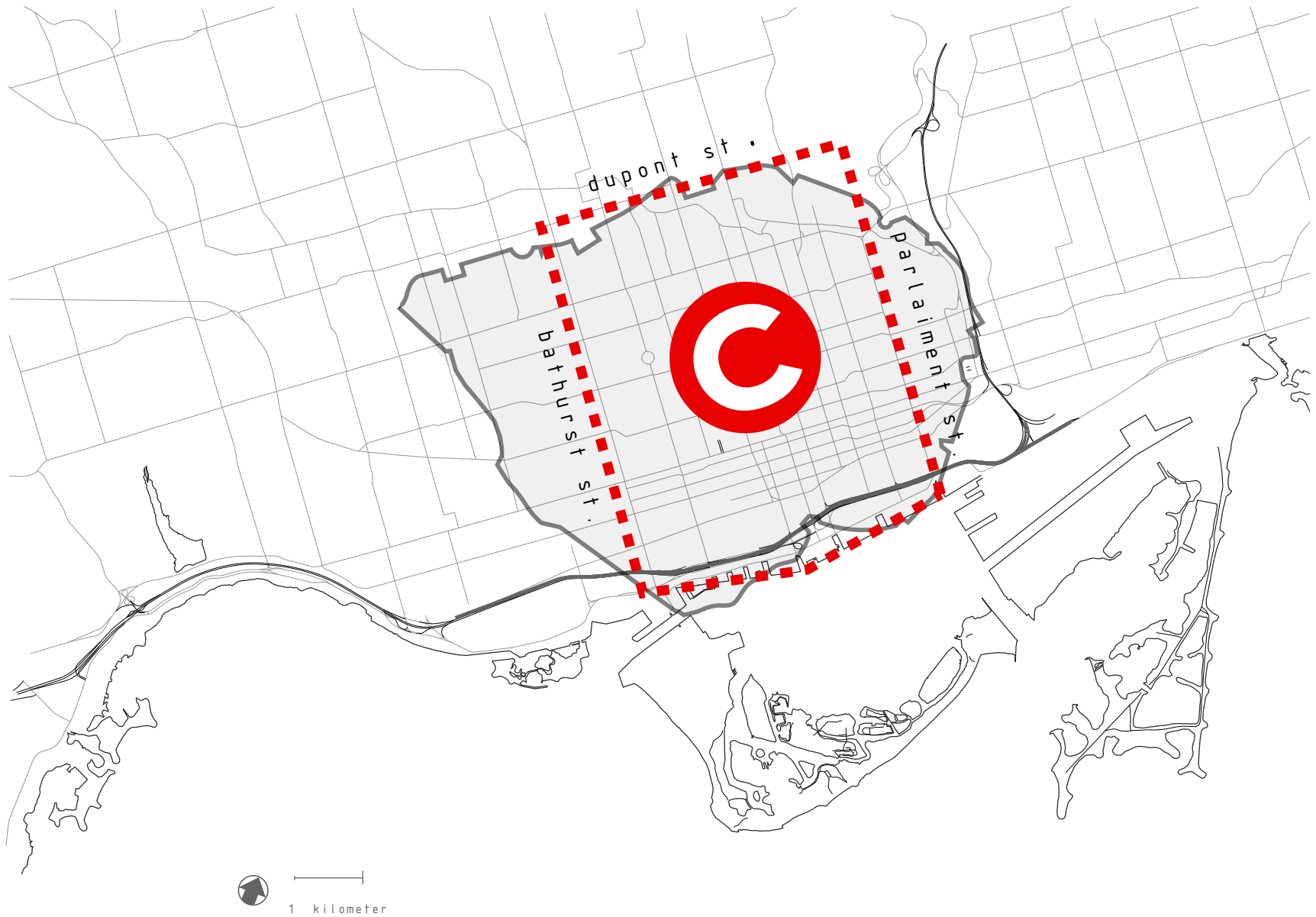

PHASE 4 - 2010

Figure 68 - London CC-Zone superimposed on Toronto's Central Business district

Congestion Charge

In efforts to control congestion, cities around the world are beginning to adopt the idea of Congestion Charge zones. Singapore, in 1998, was the first city to implement an Electric Road Pricing Scheme. In February 2003, London imposed the similar Central London Congestion Charge on the 200,000 cars entering the city each weekday.* London's system tracks car plates via closed circuit cameras. During the toll's scheduled hours of operation, motorists are charged £8 (16 CDN) to drive in central London.²⁷

Each weekday morning, 110,000 cars come into downtown Toronto, most use the Gardiner Expressway. Gridlock is a constant problem, and

this will only worsen in the next decade. Delays caused by traffic congestion are estimated to cost GTA businesses over \$2 billion/year, increasingly becoming an economic burden and an environmental threat.

After the Front Street Extension is built, using money from the Gardiner Toll, the Toll would be replaced by a broader Congestion Charge to cover the Central Business District. The charge is expected to reduce traffic congestion in the downtown, ensuring that motorists consuming valuable road space make a financial contribution back into the transport system – specifically a new waterfront transit system.

Figure 69 – London Congestion Charge zone

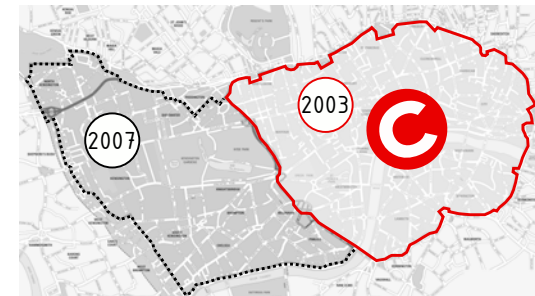

* The Congestion Charge, originally opposed by the public, has greatly improved the quality of life for commuters, businesses, and residents, decreasing congestion inside London's charge zone by 30%, with as many as 50,000 fewer vehicles entering central London. Most former car commuters have switched to either public transit or car pooling. The city plans to double the current zone area in 2007, predicting the expanded will raise more than £1.3 billion over the next ten years – all of which will be allocated to improve London's transport infrastructure.

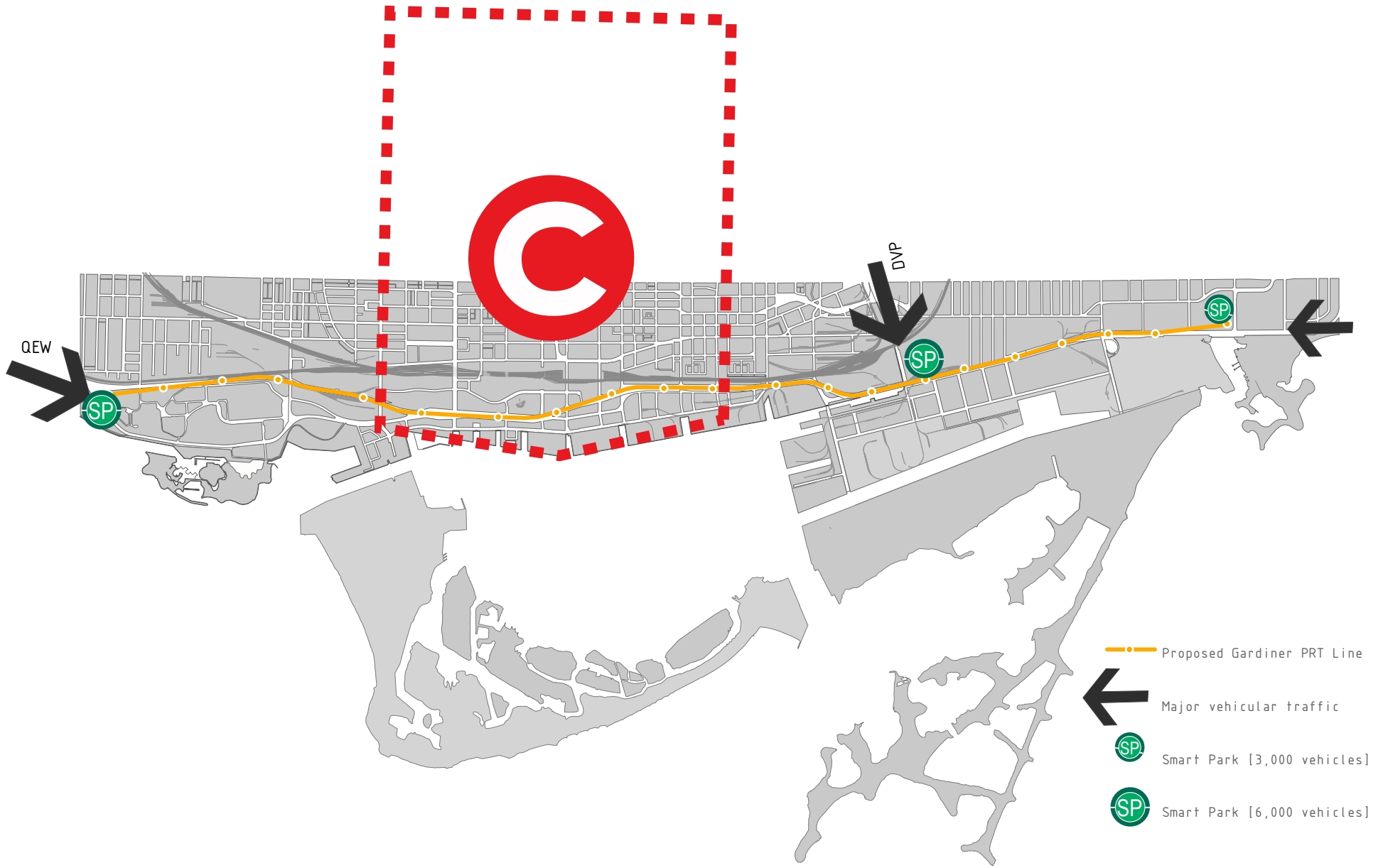

PHASE 5 - 2010

Figure 70 - Smart Park facilities

Smart Technology

People commute from home to office, office to gym, gym to club, and club to home. A culture of continuous, “seamless” travel would demand the same of its public transportation. Hence the Smart Card, a single electronic fare collection system for all public transit across the GTA region by 2010.* The ability to transfer effortlessly from one mode to another will increase the frequency of travel and to a large extent shape the experience of mobility in Toronto.²⁸

As long-distance commuters approach the downtown, transit systems should also respond to the shorter intervals of travel required. In the heart of the city, commuters could skip from

one vehicle mode to another, and on to another again. The smooth transition between each interface is vital to the success and fluidity of the transit system as a whole.

“Smart Parks,” which direct cars to the nearest parking spaces, will be implemented at the west end of CNE, the lower East Don Lands site, and the Beaches, with direct access for drivers arriving from the QEW and DVP. Smart technology complements the transponder system previously introduced by the Gardiner Toll. The transponder is activated when a vehicle enters the Smart Park, and uses a “Park Positioning” technology to help drivers efficiently navigate.

Figure 71 - Multi-use Transponder [PPS]

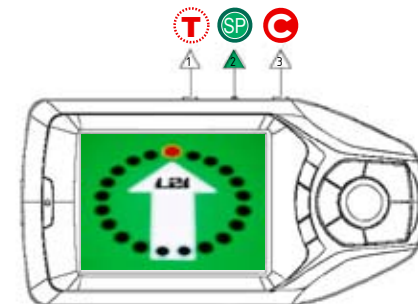

The objective of the Smart Park is to persuade car commuters to park and save on parking and congestion surcharges inside the CBD. Major PRT stations and terminals are connected to Smart Park facilities and provide express services that carry peak-hour commuters to Union Station without stops. Just swipe the Smart card.

* Under the leadership of The Ontario Ministry of Transportation (MTO), the first phase of the GTA Farecard (Smart Card) will be implemented in 2007 into Mississauga Transit, GO Transit’s Milton rail line and TTC Union Station subway turnstiles. The Farecard will provide customers access to ride on any GTA transit vehicle without tickets, passes or exact cash fare.

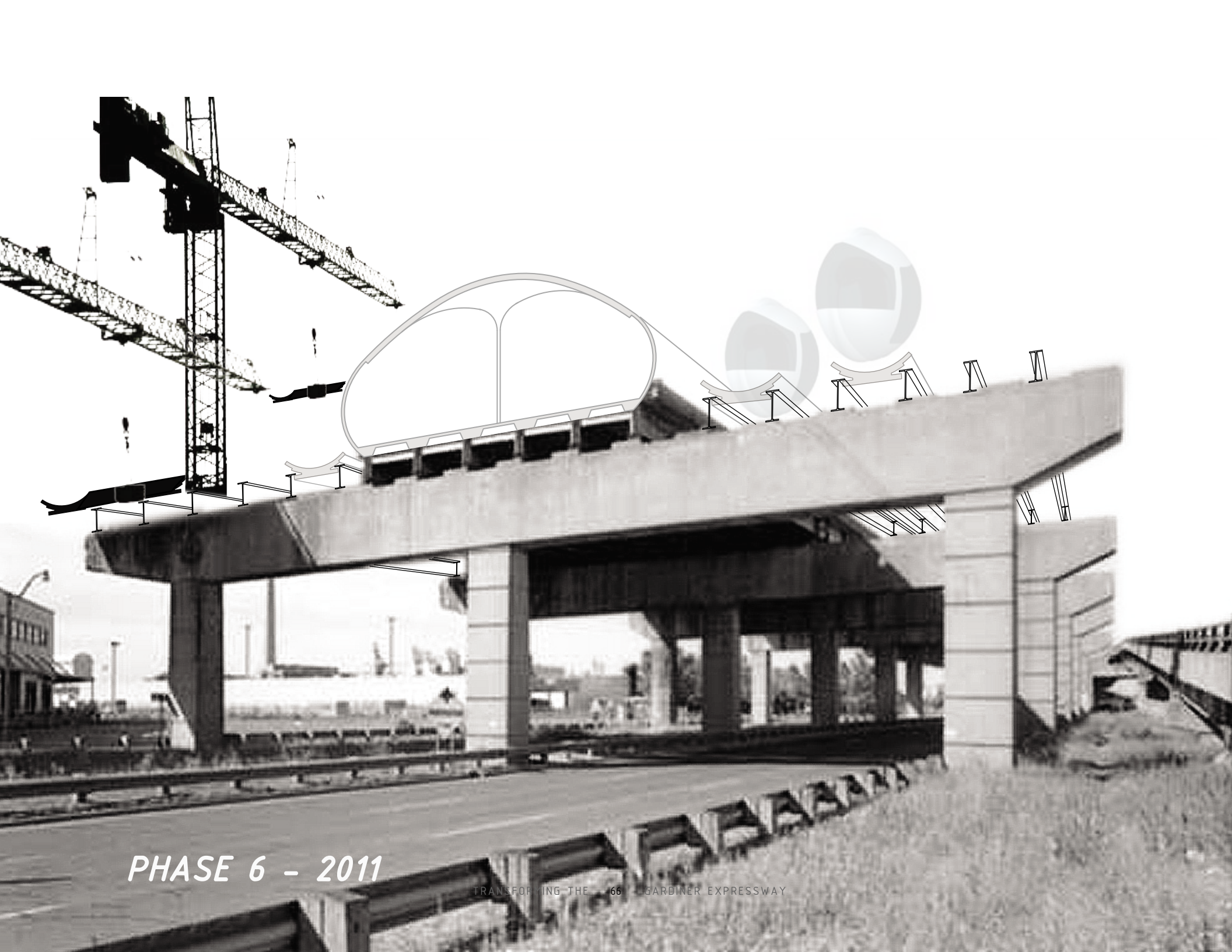

PHASE 6 - 2011

Remove, Retain, Replace

Once the Front Street Extension is built and the Congestion Charge is initiated, the Gardiner Expressway can be physically altered. The proposed transformation combines three strategies: removing the ramps and road deck, retaining the colonnades and girders, and replacing the expressway with a bike path and transit tracks.

Eliminating the ramps, which have been identified as the major obstruction to pedestrian movement, will streamline the meandering form and free up land for development. The second modification – removing the Gardiner road deck – allows natural light to shine down onto

pedestrians, reduces noises that had previously been amplified by the concrete structure, and improves safety for pedestrians and drivers below. Salt use during winter damages the Gardiner’s surface and seeps into the structure, deteriorating concrete, and causing chunks of the deck’s underside to rain down on Lake Shore Boulevard below.

With most of the concrete deck eliminated, the existing structural steel girders can be exposed and retrofitted, in phases, with magnetic levitation tracks to guide a system of “T-Pod” vehicles. The T-Pod is the essential mobile unit that transports passengers along the new,

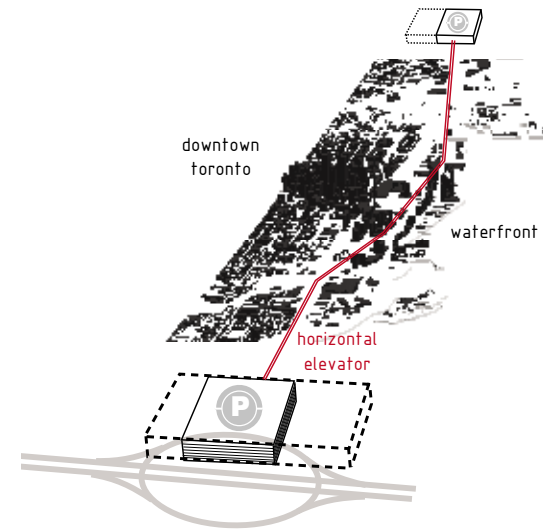
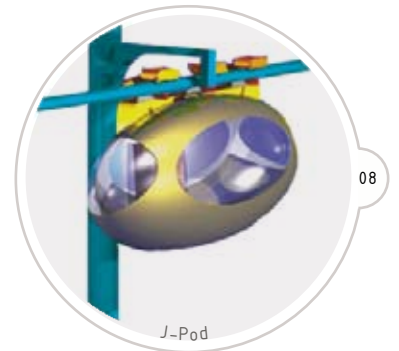
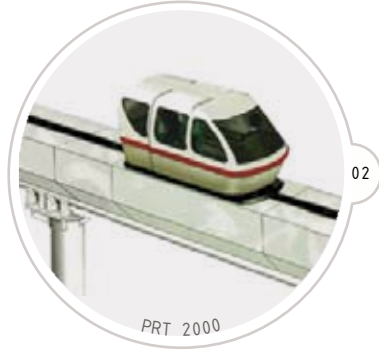
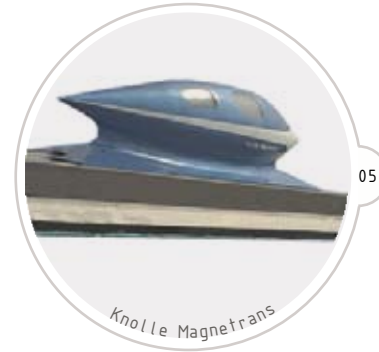

Figure 72 opposite – transforming the Gardiner
Figure 73 right – park and ride diagram

elevated guideways. The colonnade supports the tracks, as well as a sheltered bike path that runs down the centre of the Gardiner’s passage. Bike ramps connected to the path are suspended off the colonnade structure and reached from specific PRT stations.



01 Cabinentaxi
1975 Germany, 3 passengers @ 35km/hr
Electric Motor Propulsion

02 PRT 2000
1996 USA, 3-4 passengers @ 50km/hr
AC Electric Motor

03 Sky Web Express
2000 USA, 4 passengers @ 80km/hr
Electric Motor Propulsion

04 ULTRA
2003 UK, 4 passengers @ 50km/hr
Electric Motor Propulsion

05 Knolle Magnetrans
2003 USA, 2 passengers @ 320km/hr
Hydro Maglev Technology

06 Modular Automated PT
2004 Italy, 4 passengers @ 140km/hr
Electric Motor Propulsion

07 Unimodal Skytrain
2004 USA, 2 passengers @ 160km/hr
Maglev Technology

08 J-Pod
2005 USA, 1 passenger @ 80km/hr
Solar + Wind Augmentation

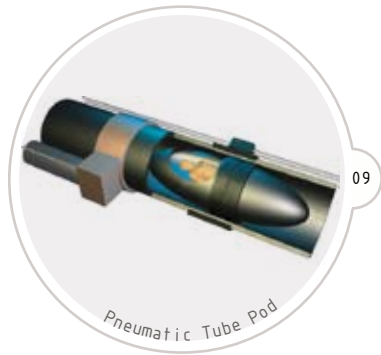

Pneumatic Tube Pod

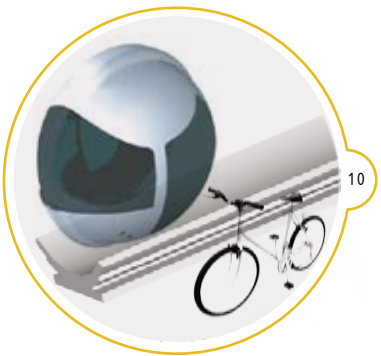

- 09 Pneumatic Tube Pod
2005 USA , 1 passenger @ 600km/hr
Pressurized Air Tube Technology
- 10 T-Pod
2015 Canada , 4-5 passengers @ 80km/hr
Maglev Technology + Opto-Proximity Sensor
- Bicycle
1 passenger @ 2.5 km/hr
Human Powered

Chapter Six: *On Personal Mobility*

Mobility has an enormous impact on city culture and urban development. Cities are primarily perceived from a moving perspective. Our experience of the city is to a large extent determined by infrastructure and traffic flows. Mobility is not solely a logistical or tecnocratic challenge in the modern city, but also a key conditioning factor in urban development.

Paul Meurs and Marc Verheijen, In Transit

Personal Mobility

Mass transit is designed for the collective welfare of citizens. The welfare of individual citizens who use mass transit, however, could definitely be improved. As it stands, large groups of commuters are expected to congregate in constricted spaces for the sake of maximum efficiency. Functionalism neglects individuals, who, within the mass of commuters, are conditioned to feel isolated and mechanized by the mundane environment. The control of an individual's freedom is inhibited by this type of conventional transport system.

With rapid urbanization and developments in other forms of mass technology – most notably

mass communication – users have come to expect more of public transit. Rising demand for public transit has strained Toronto's current system, particularly at peak hours. Suffering from financial cutbacks, TTC service is notorious for being over-crowded – a symptom of truncated schedules and a limited coverage of a vast area. The malfunction and maintenance to ageing transit vehicles frequently cause delays to commuters, resulting in tardiness and the loss of productivity. One disruptive subway incident can set off a ripple effect that burdens the rest of the system.

The City is committed to developing new

transit innovations to address these immediate concerns. The newly re-configured Gardiner would support a Personal Rapid Transit System, a multi-faceted system that will adapt to individual time schedules, route itineraries, and travel demands.

If walking is the most common example of personal mobility, pedestrian movement illustrates the most basic mode of transportation while providing an intimate relationship between the individual and the community. At the next scale of personal mobility, the bicycle negotiates the distance between walking and driving, thereby promoting a connection between the individual, the community, and nature. In consideration



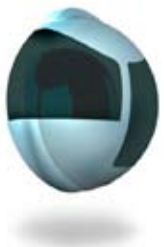

of longer distances, the personal economy and speed can be improved by PRT, merging personal convenience with increased travel distance, linking the individual, the city, and the waterfront.

Replacing fixed schedules with personalized ones, PRT is inclusive, interactive, and integral. Its inherent flexibility in construction and expansion allows the system to be inserted in manageable stages into the urban fabric. Users ride in small vehicles that are designed with the intimacy of a car moving at an exhilarating speed through the cityscape, facilitating an attractive and efficient commute system that incorporates the mobility we value in cars as well as the capacity expected of

mass transit.

Adopting a new mode of transportation doesn't necessarily mean abandoning an old one. The new system is more effective because it accommodates and enhances the individual's needs on a number of levels. Responsive transit infrastructures also respond to, and thereby support, cultural developments. By interacting with buildings, public spaces, and other programmatic amenities, they reconcile disconnections within the city. Instead of isolating parts of the city, the Gardiner will merge systems of personal mobility, old and new, and initiate new social and spatial interaction on the waterfront.



PHASE 0

Semi-enclosed bike path in place.

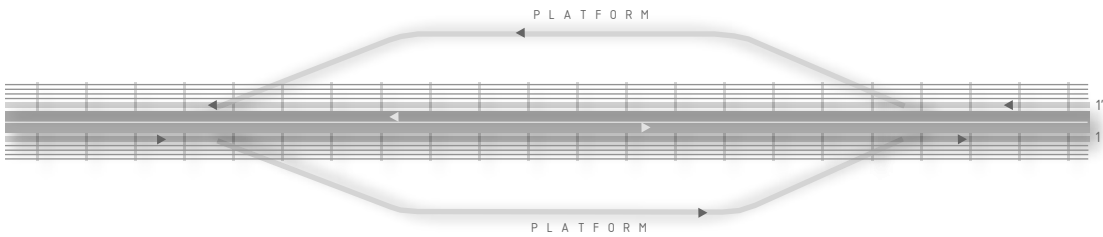

PHASE 1

Maglev track '1' in place.
Major terminals and stations built.

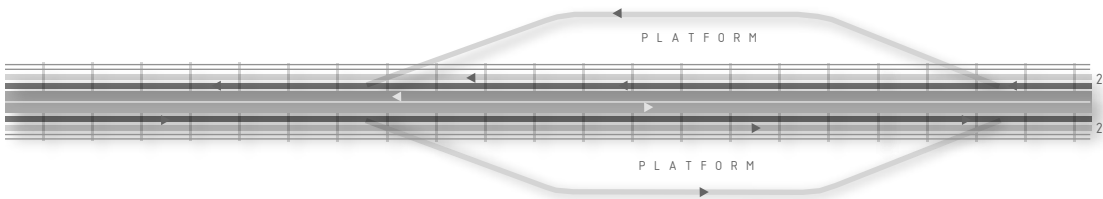

PHASE 2

Maglev track '2' in place.
Inner Maglev tracks run express.
GO stations and Bike friendly stations

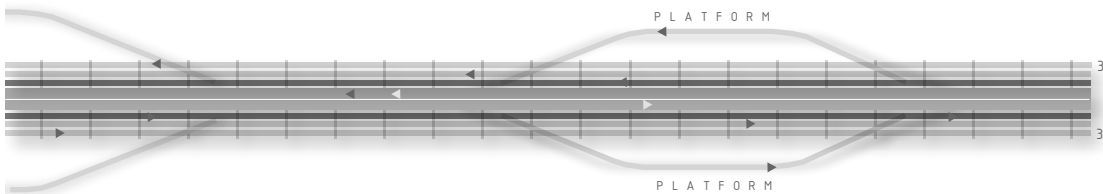

PHASE 3

Maglev track '3' in place.
Middle and outer tracks run local.
Neighbourhood stations built.

Mobility Tracks

The PRT tracks and stations are planned in phases in anticipation of waterfront growth and development over the next decade. The initial phasing locates a semi-enclosed, sheltered bike path along the entire length of the Gardiner. As the central artery, the bike path reinforces the initiative to promote the most sustainable personal transport in a dense, urban community.

Flanking the bike path on either side are bi-direction PRT magnetic levitation tracks, retrofitted between existing girders. PRT tracks are less cumbersome than typical monorail guideways since they support considerably lighter vehicles. The tracks are implemented in

three phases to accommodate new stations and increasing commuters.

Phase One functions with a single track that connects the four major PRT terminals and interchange. The track makes a continuous loop to allow T-Pods to circulate throughout the system, recycling passengers as they move along.

Phase Two adds a secondary track that deviates from the main Gardiner track to serve new stations; the inner track is designated express and the outer track local. The new stations are planned according to commuter demand and accessibility.

Phase Three incorporates a third local track

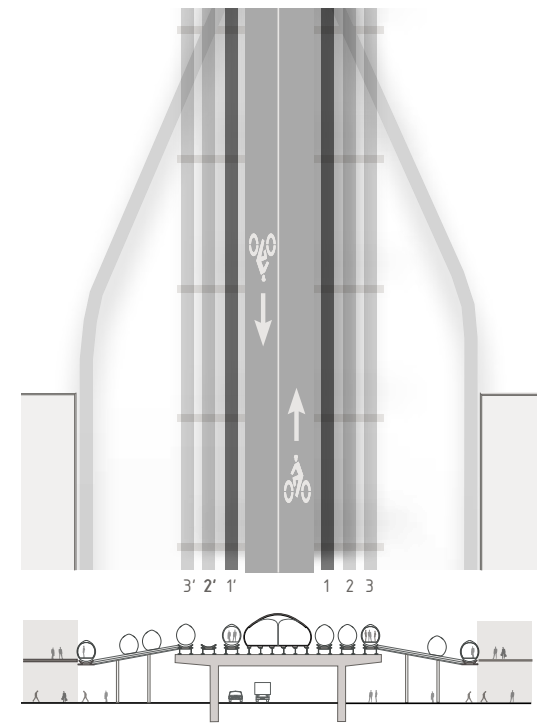

Figure 76 - PRT tracks typical cross-section

to accommodate the projected capacity of the PRT system once it has been fully implemented. The tracks operate to sustain a continuous flow of T-Pods, allowing the system to function at its most efficient.

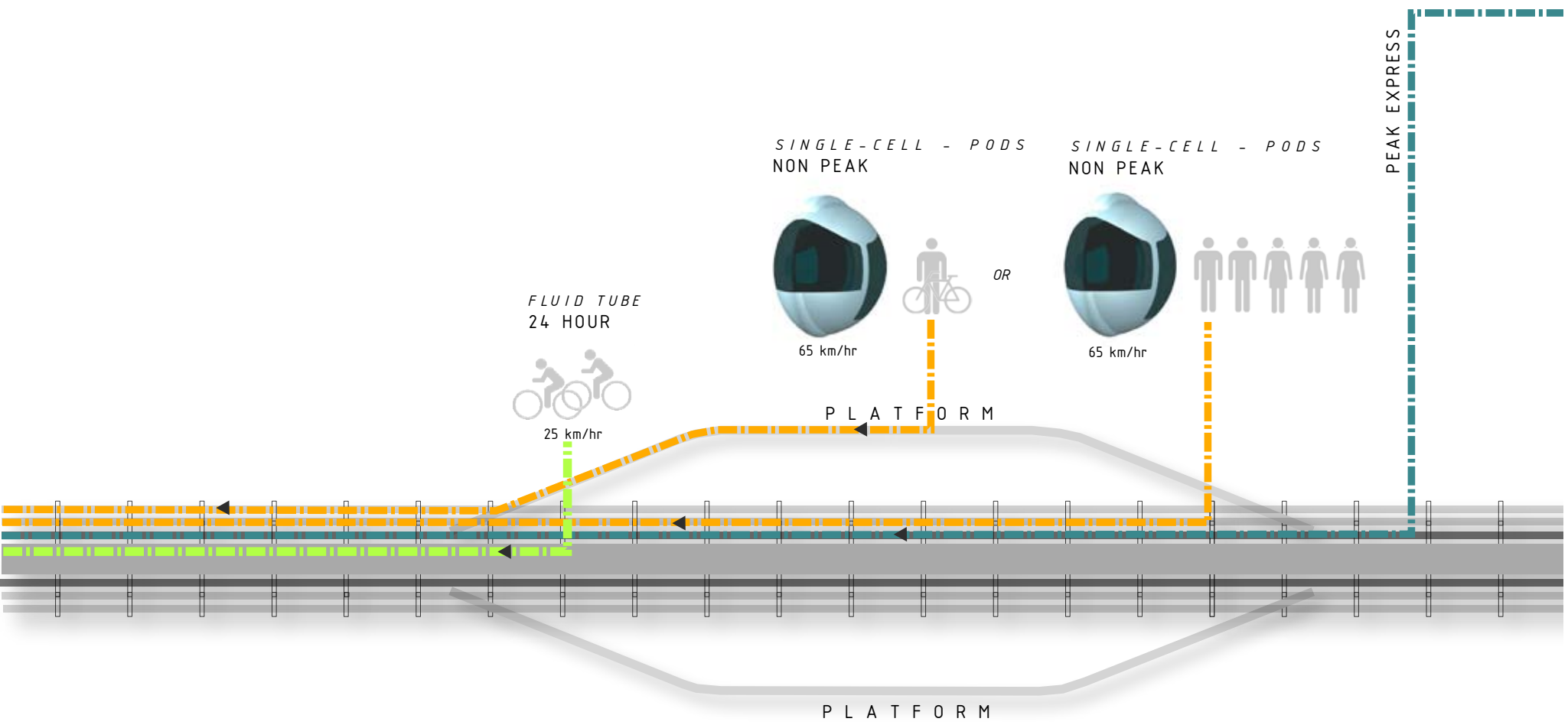

Figure 77 - Personal Rapid Transit System

MULTI-CELL - PLATOONS
PEAK EXPRESS UNION STATION

06:30 - 08:30



16:30 - 19:00

Personal Rapid Transit

Personal Rapid Transit, an “automated people mover” transit system in which vehicles are automatically controlled over an exclusive right-of-way, is a kind of horizontal elevator. PRT offers on-demand, non-stop transport between two points on a network of elevated guideways. The network is monitored by an advanced computer system that controls and optimizes the performance and availability of transit pods. The vehicles run on linear magnetic levitation technology to reduce the level of noise and air pollution on the waterfront. The T-Pods offer a hybrid between the convenience of cars and the social and environmental advantages of public transport.

The main advantage of PRT over conventional mass transit is its flexibility in design, planning, and implementation. Current patterns of urban development and transit usage form the basis of the system’s layout. Concerns over a PRT’s capacity are addressed by a modified system that runs 24 hours a day and makes provisions for high traffic periods. During peak hours, T-Pods form linear chains known as “platoons” that run on the express track, making stops at only four major terminal stations. The express and local tracks split levels at these stations to efficiently distribute and collect passengers. When the system switches to non-peak mode, the T-Pods



break off and resume individual circulation on the local tracks. After midnight, most of the vehicles are stationary and stored on the express track to conserve energy.

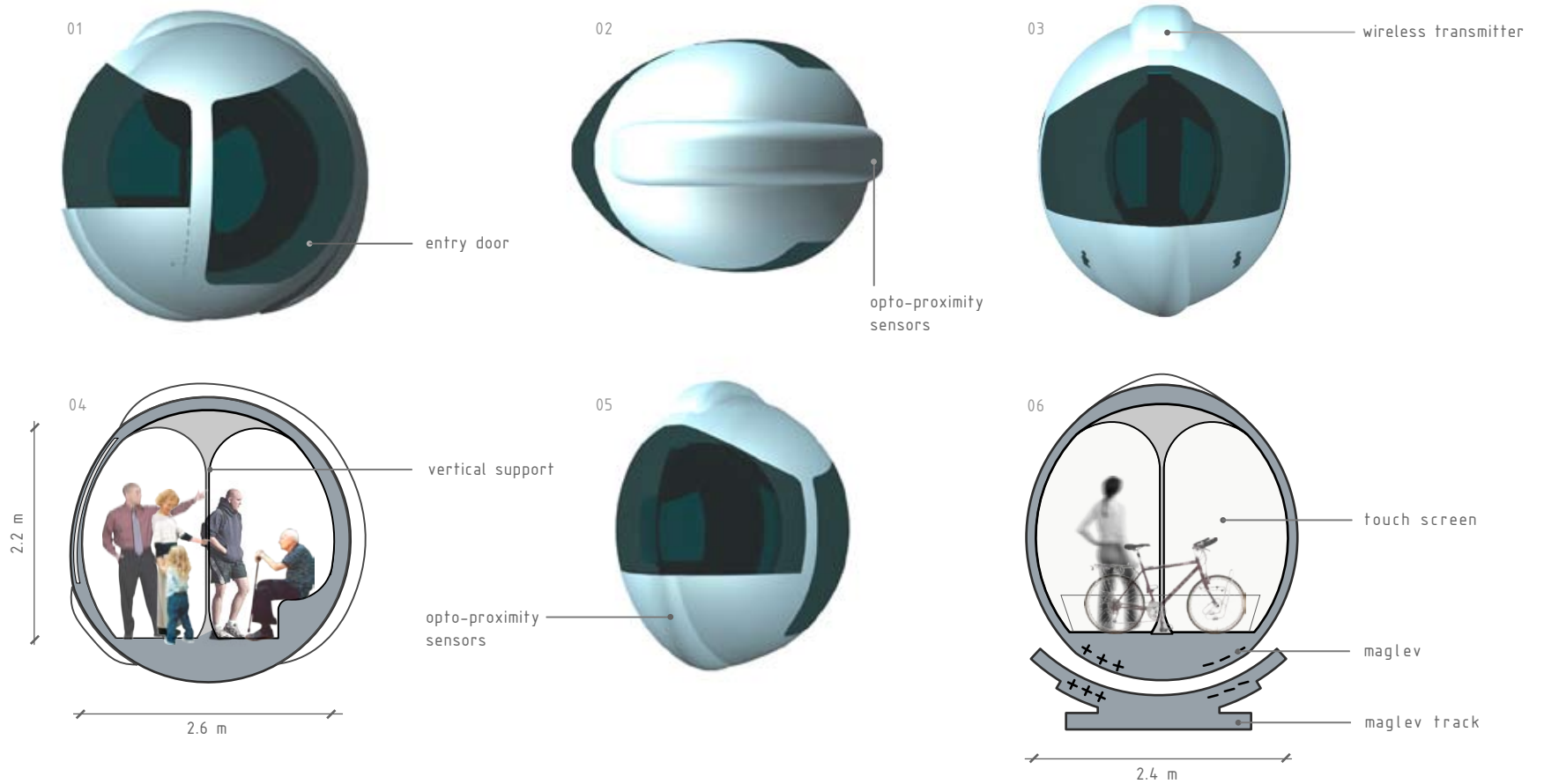

01 side elevation
 02 top view
 03 front elevation
 04 long section
 05 perspective view
 06 cross section

Figure 78 - T-Pods

T-Pods

The Gardiner PRT operates a fleet of unique and responsive mobile units to cater for individual needs as well as fulfilling the demands of a mass transit system. Passengers waiting at a station are detected by a sensor on the platform and the next available vehicle is automatically dispatched. Once inside the T-Pod vehicle, commuters choose their destination on a digital touch screen. The system will then automatically route the vehicle to the desired destination within the shortest possible time and without making additional stops. PRT provides a taxi-like service and is comparable to the speed of a car travelling at 65 km per hour. Additionally, measured against the

average car, PRT indicates an energy reduction of more than 60%.²⁹

T-Pods operate on maglev technology and are controlled by an advanced central computer through wireless transmitters, which guide the direction and destination of each vehicle. Sensors located on the front and back of the vehicle determine safe headway between one T-Pod and another. The sensors are also programmed to link vehicles together in platoons during peak hours.

Individual T-Pods are designed to hold one person with a bicycle, or five standing passengers. During express service, a line-up of 60 T-Pods

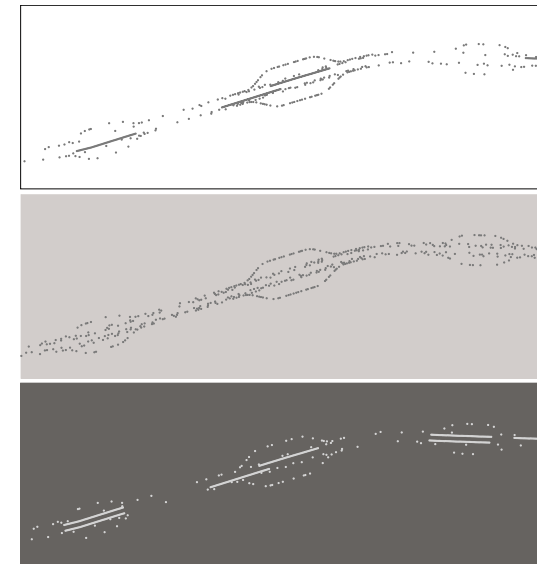
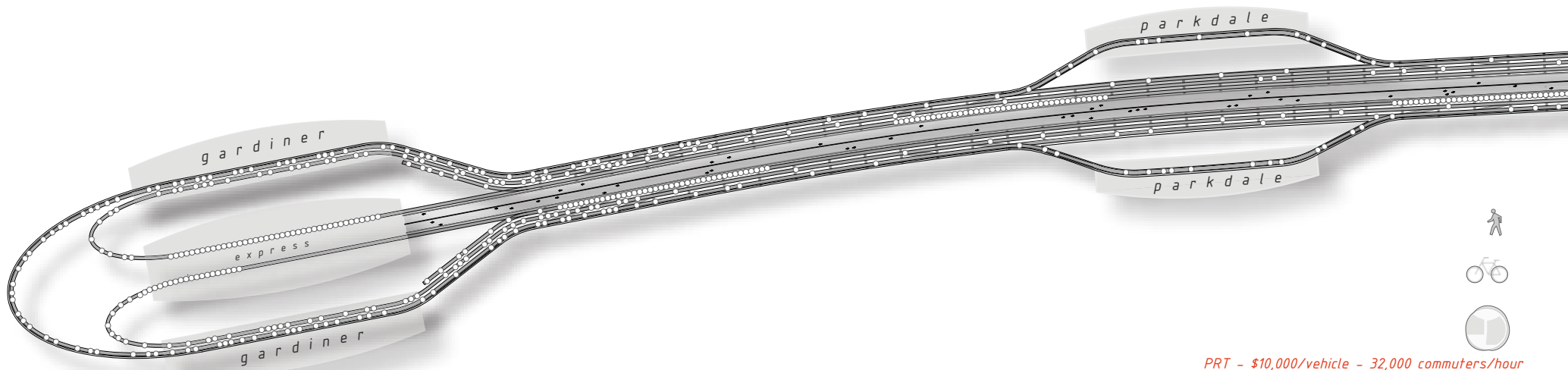
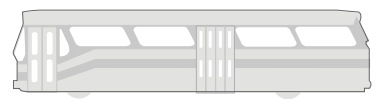

Figure 79 - T-Pods commute patterns

will form a platoon, carrying approximately 300 passengers. The platoon transports a relatively small number of passengers compared to other forms of rapid transit. However, the direct trip from one destination to another make up the carrying capacity by their total trips per hour.



PRT - \$10,000/vehicle - 32,000 commuters/hour



Bus - \$650,000/vehicle - 3,000 commuters/hour

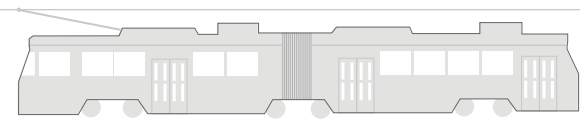

Streetcar - \$1 million/vehicle - 4,000 commuters/hour



Rapid Transit - \$3 million/vehicle - 8,000 commuters/hour

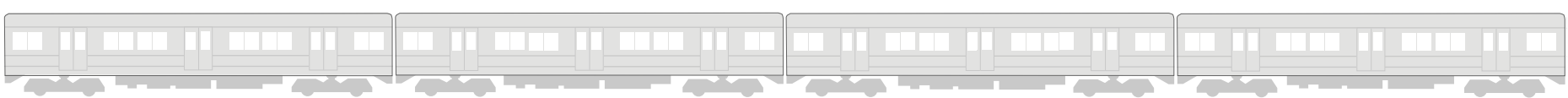

Subway - \$2.5 million/vehicle - 30,000 commuters/hour

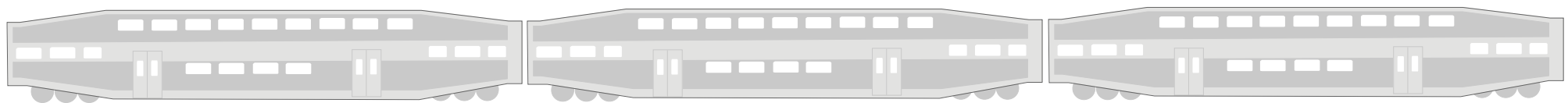

GO Rail - \$1.8 million/vehicle - 15,000 commuters/hour

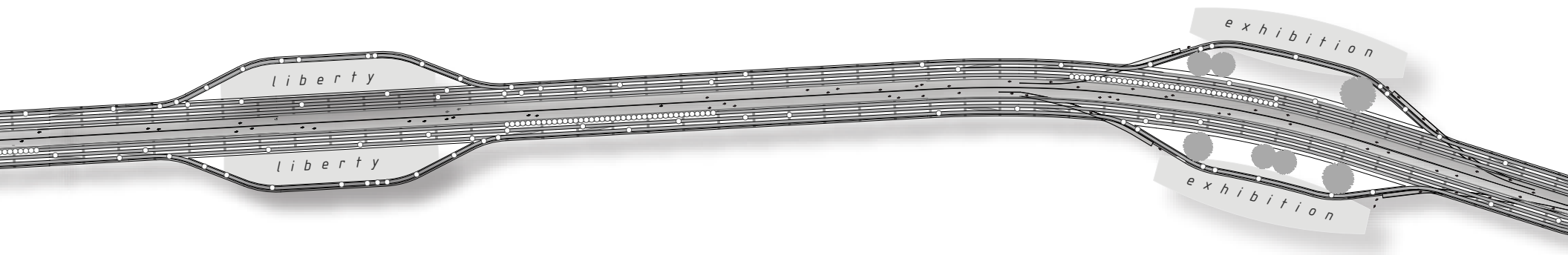

PRT Capacity

Changes in urban development and lifestyle trends have led to the scaling down of rapid transport vehicles, changing their overall design and capacity. Future transit innovations will be expected to deliver state-of-the-art performance with spatial efficiency.

PRT maintains the high capacity of mass transit while being as compact and streamlined as a modern car. The entire PRT system operates a fleet of 3,000 automated T-Pods that can make up to a combined 32,700 trips per hour.* The TTC subway system currently services 30,000 passengers in one hour.³¹

The capital costs of PRT are governed by

the economies of mass production. The cost of PRT infrastructure and vehicles is significantly lower than that of light rail: a T-Pod, which can be easily maintained and replaced, would cost an estimated \$10,000, compared to \$4 million for a light rail car. Light rail, in metropolitan areas, can cost as much as \$30 million/km, whereas PRT is estimated to cost \$10 million/km – even less with the reuse of the Gardiner’s existing structure. Smaller vehicles weigh less and infrastructure is thereby minimized. Construction is also less disruptive, as excavations are not needed to build foundations. PRT operation and maintenance costs have recently been estimated

to be less than four bus lines, which are currently considered the cheapest form of conventional public transport.³²

* The combined trip assumes an average passenger per trip of 1.8 and the average duration of 5 minutes + .5 minute reloading [(60 minutes/5.5 minutes = 10.9/vehicle/hour) x 3,000 = 32,780 trips/hour]²⁹ Refer to Appendix B for more detailed calculations.³⁰

Figure 80 top – PRT stations
Figure 81 opposite – transport vehicle comparison



7.5 km Bike Path

Of the 383,000 people who work in the central part of downtown Toronto, 54 per cent take public transit to work, 12 per cent walk, and 8 per cent cycle. Close to 30,000 bicycle trips are made to and from the central business district on a typical day and it is expected that this figure will greatly increase over the next decade as Toronto implements the citywide bike plan.³³

Sharing a common infrastructure with the PRT system, the Gardiner's dedicated urban bike path runs east-west across the length of the downtown, and would serve as a major cycling corridor through the central waterfront.

The proximity of the corridor to waterfront neighbourhoods, community parks, and bike trails would make it an ideal central artery in Toronto's cycling network. Elevated three-storey high, the semi-enclosed path is opened twenty-four hours and provides a safe cycling infrastructure for daily transportation and enjoyment.

The route supports a combination of cycling and transit by providing links to transit services and access to bicycle parking facilities. Varying station typologies featuring bike amenities promote a new transit paradigm of "bike and ride." The bike ride is a sublime journey. Cyclists traveling in the meandering strand enjoy

Figure 82 opposite - semi-enclosed Bike Path
Figure 83 right - light study model under the tracks

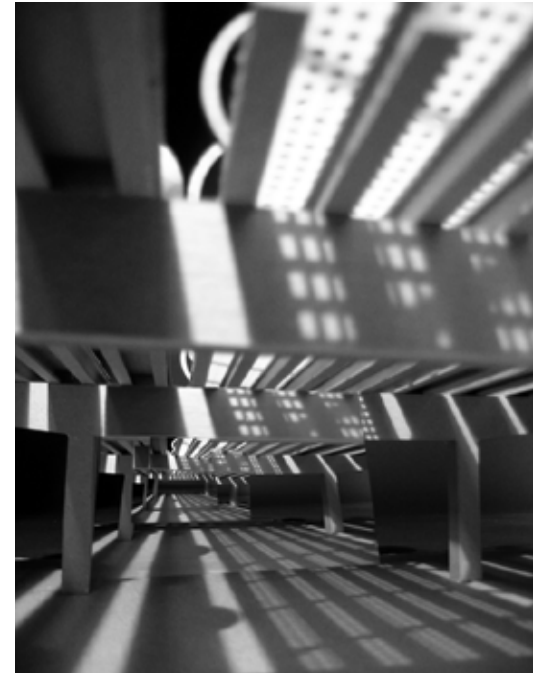

the oblique views of the cityscape and snapshots of Lake Ontario. At nightfall, the bike path is illuminated to guide cyclists and the vehicles below through the myriad of the metropolis.

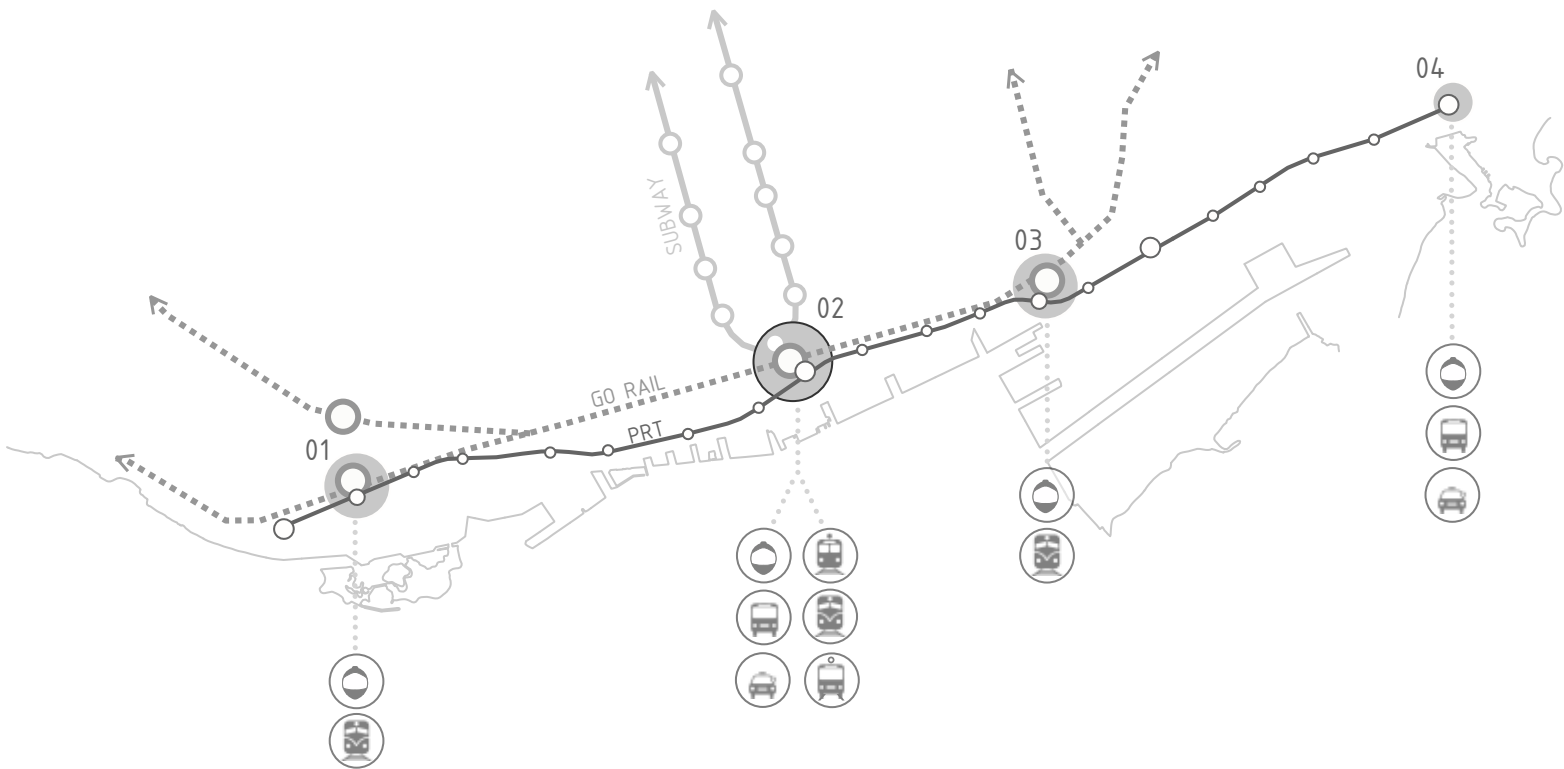
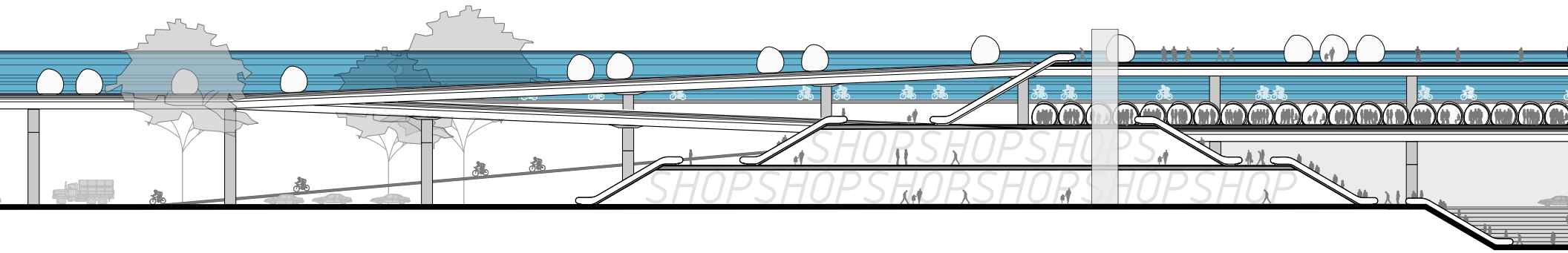

- 01 Parkdale Interchange
- 02 Union Interchange
- 03 Don River Interchange
- 04 Woodbine Interchange

Figure 85 - Interchange transit modes

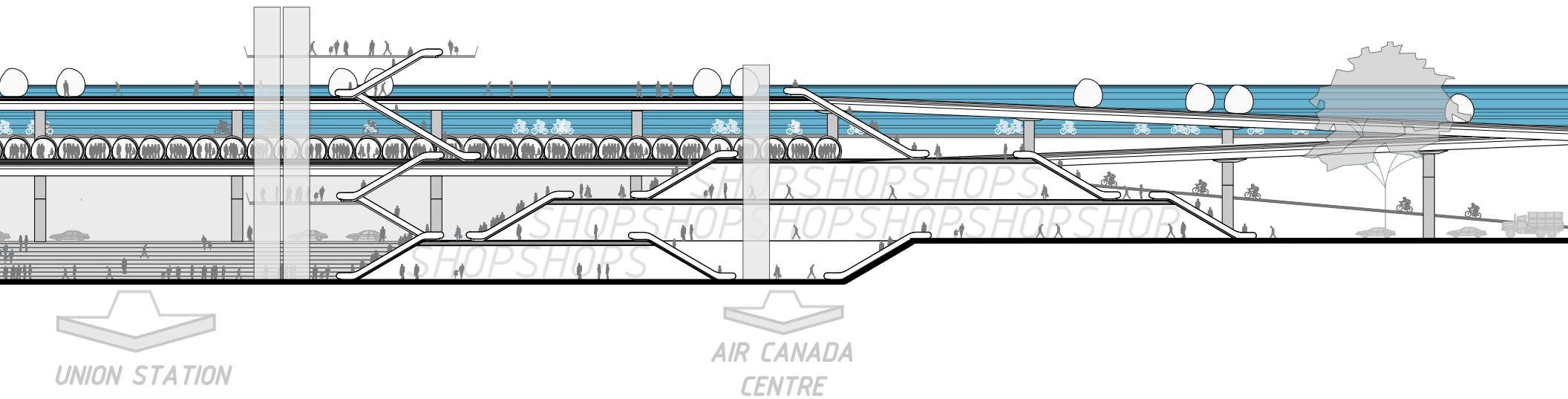
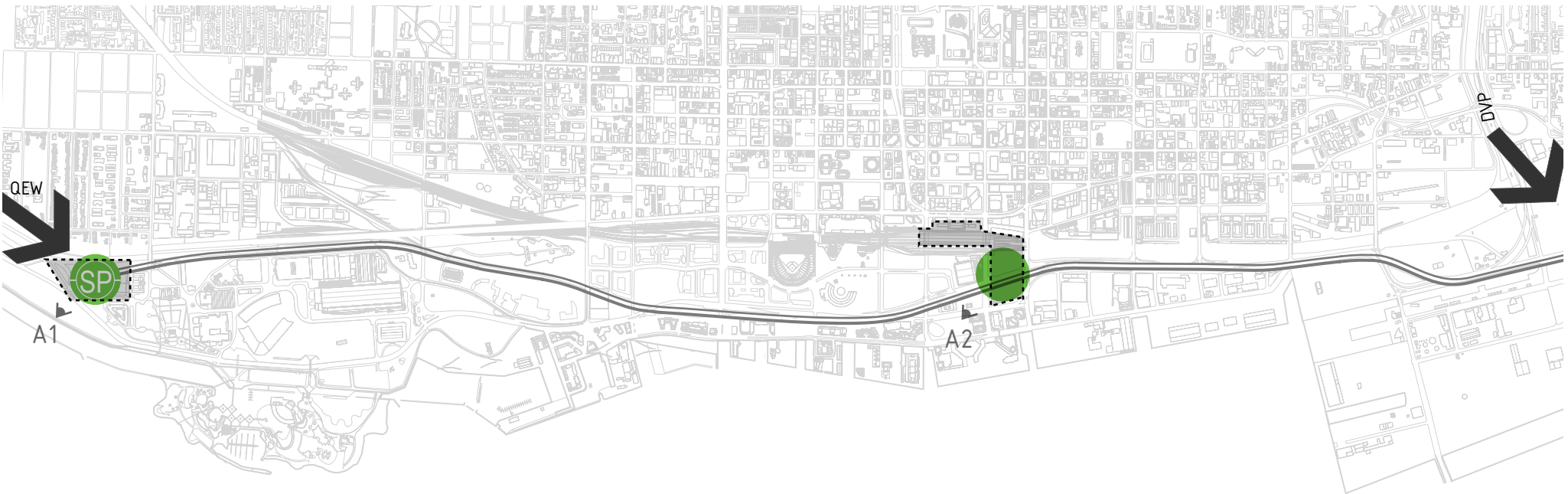

Figure 84 - proposed Union Station Inter-change section

Integrated Transit

A well integrated transit system involves the coordination of different transit modes to create seamless service and support the various needs of a growing population. The application of Smart Card technology better links a wide range of urban and inter-city transportation options. The convergence of transit systems creates large-scale interchanges, inter-modal stations, terminals, and transit hubs that circulate thousands of commuters, and often becoming destinations in themselves. Each station represents a critical piece of infrastructure that determines the character and experience of the urban environment.

Gardiner PRT stations fall into five categories, each with specific layout guidelines explaining how it is to be inserted into the system. The logistics of PRT allow station typologies to reflect the projected commuter demand. The stations are built in phases to correspond with the implementation of the PRT tracks and the waterfront's urban growth. Each phasing sequentially adds a mixed selection from the five station typologies to ensure a functional and user-responsive PRT system.



A1 - GARDINER STATION

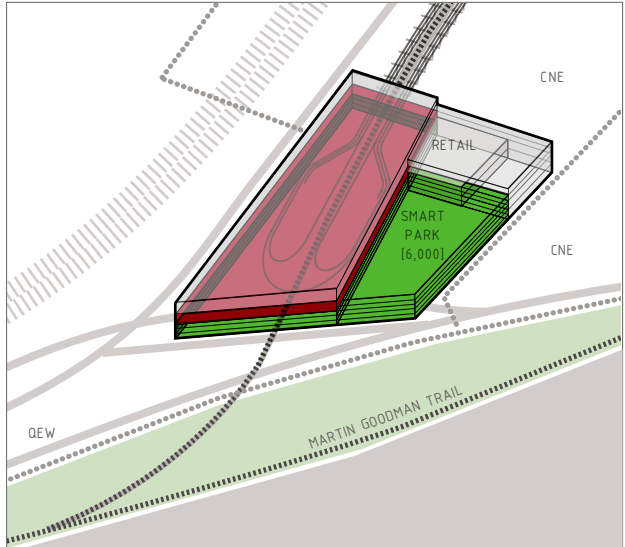

A2 - UNION STATION

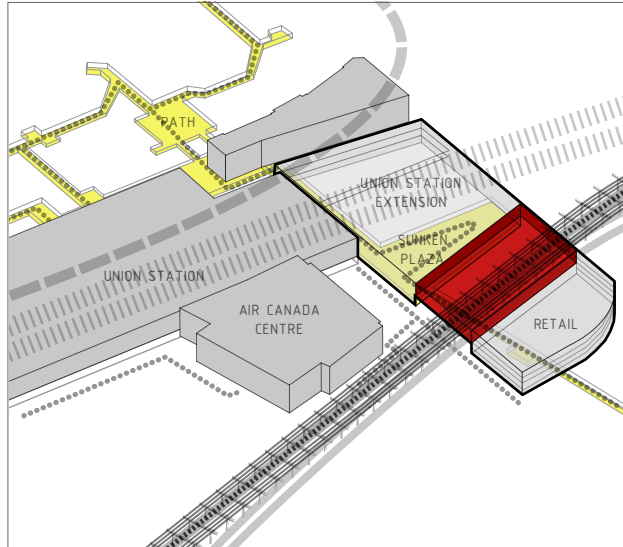

A4 - WOODBINE STATION

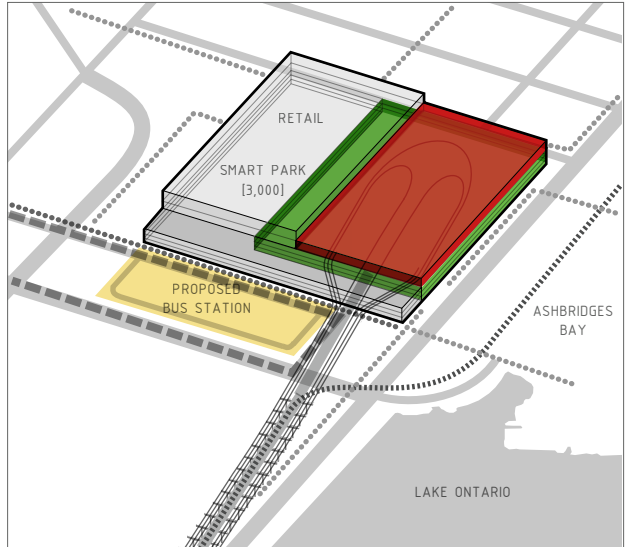

- CAR |||| RAILWAY — SUBWAY == PRT - - - BUS BIKE PATH PEDESTRIAN
- UNDERGROUND PATH ■ PLATFORM ■ PRT STATION ■ SMART PARK ■ BUILDING □ PROPOSED

Figure 86 - Station 'A' located on site plan
 Station 'A' Union Station cross-section
 Station 'A' massing & movement study

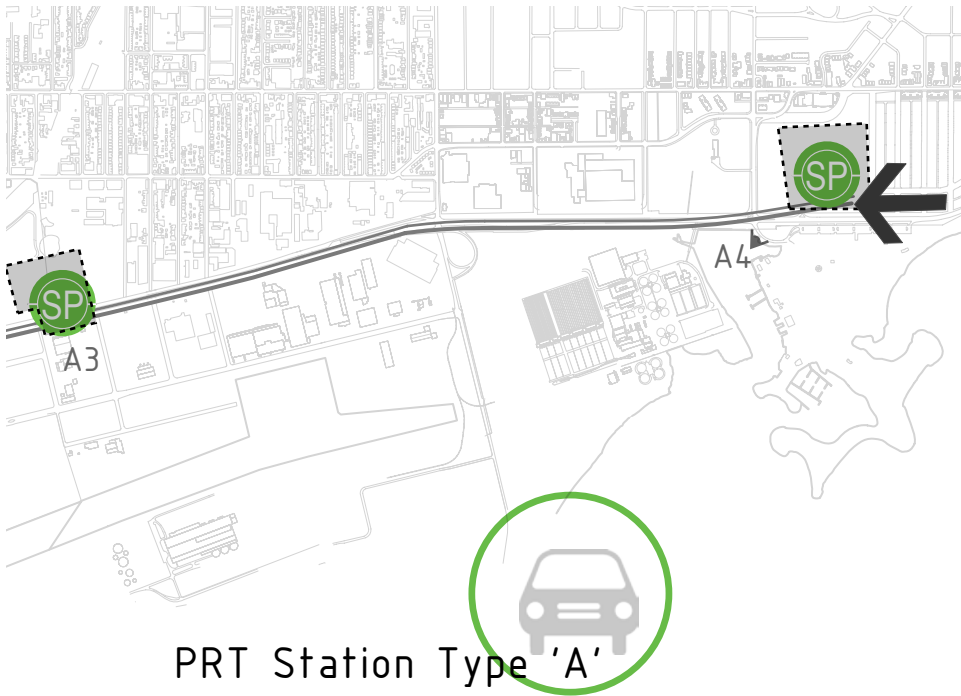

PRT Station Type 'A'

PRT Station Type 'A': two major Inter-modal stations and two terminal stations, incorporating transit services, commercial, and other urban amenities, a vibrant, mixed-use complex. In the case of Union Station, where 35,000 commuters pass through per hour during a typical workday, a sunken plaza will connect the elevated station of the PRT to the underground platforms of the subway below.³⁴ The stratification heightens the sensation of movement and the thrust of transitions. Union Station nearly bisects the length of the PRT line, and functions as the heart of the entire network, distributing a constant flow of people to be circulated around the city.

Type 'A' stations are large buildings that anchor the PRT system in the waterfront fabric. The four major stations are built in conjunction with the first "express" phase of the PRT tracks (the other two tracks to be implemented later). Union Station and the PRT east terminal, Woodbine Station, both connect to the TTC system providing commuters with easy transition to rail, subway, streetcar, bus, and taxi services. Woodbine Station also supports a new bus terminal that consolidates the bus routes on the east waterfront vicinity. Plugging into the existing transportation system, and with three of the four housing SmartPark facilities

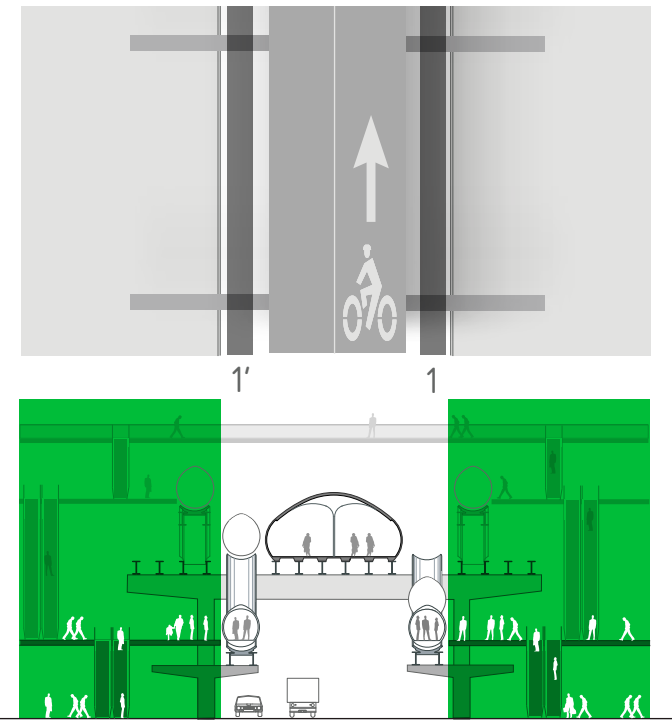

(except Union Station), the new PRT stations pumps commuters into the city and along the waterfront.

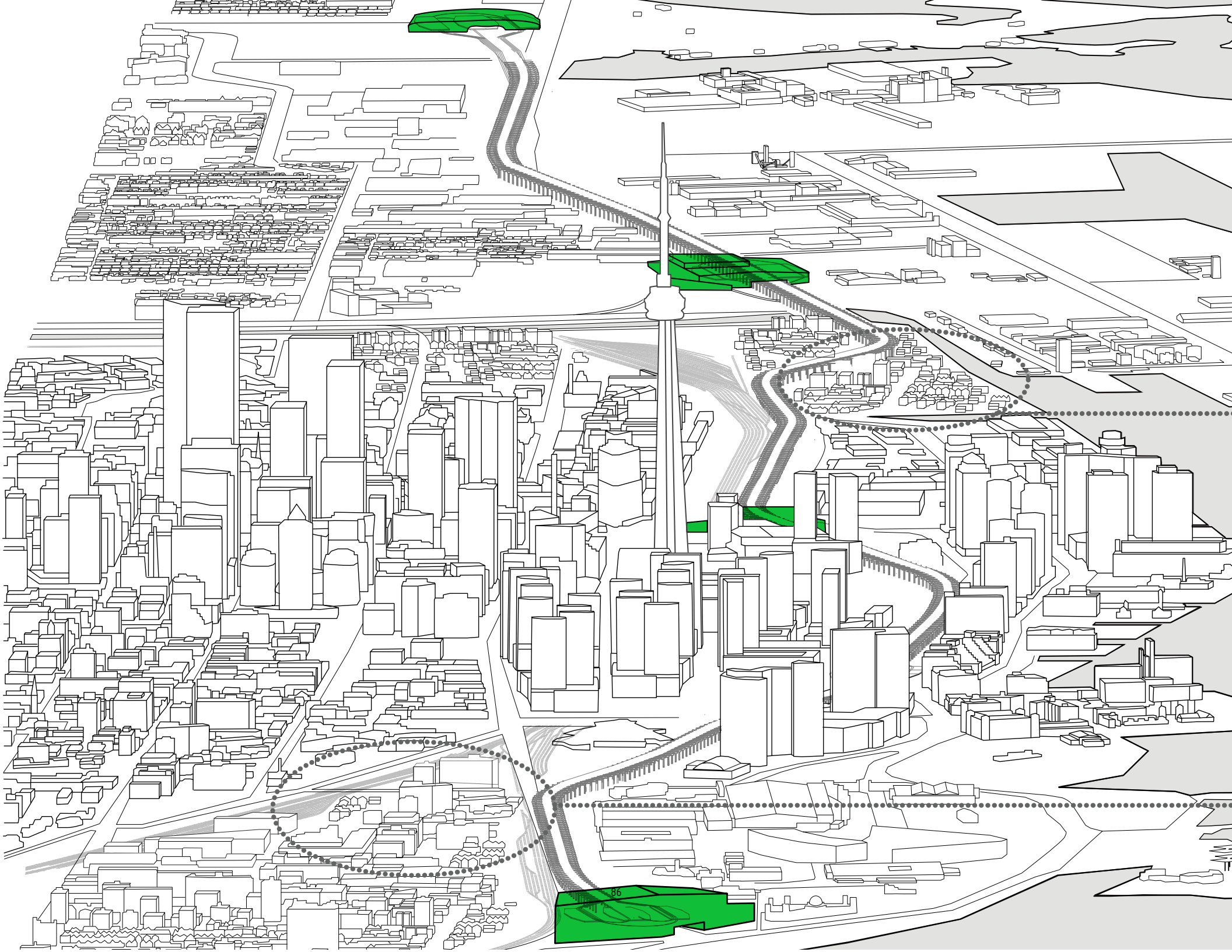

2012

WOODBINE STATION

DON RIVER STATION

EAST BAYFRONT [2011]
7,100 RESIDENTIAL UNITS

UNION STATION

LIBERTY VILLAGE [2010]
4,000 RESIDENTIAL UNITS

GARDINER STATION

TRACK PHASE 1
1,500 T-PODS
150,000 RIDERS/DAY

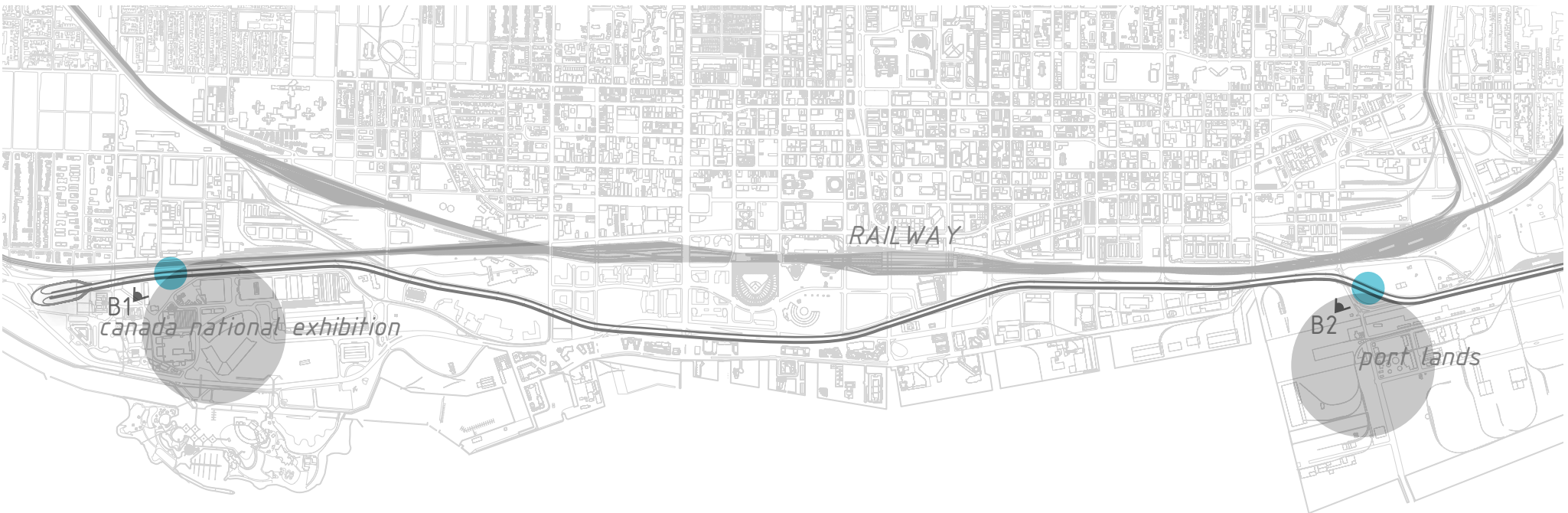

B1 - PARKDALE STATION

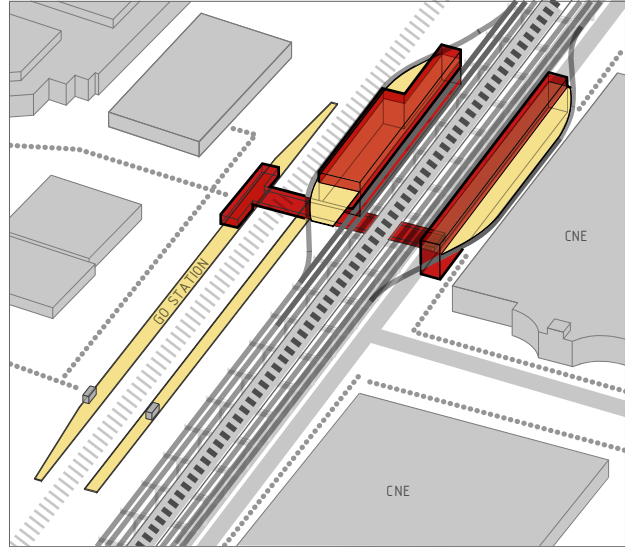

B2 - PORT LANDS STATION

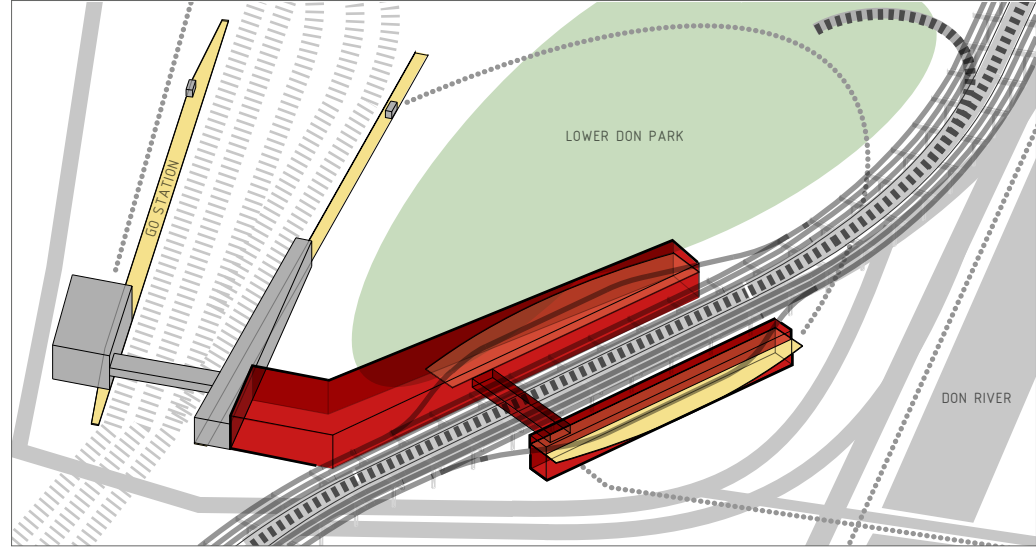

- CAR |||| RAILWAY == PRT - - - STREETCAR ■■■ BIKE PATH PEDESTRIAN
- PLATFORM ■ PRT STATION ■ BUILDING ■ PARK □ PROPOSED

Figure 88 - Station 'B' located on site plan
 Station 'B' typical cross-section
 Station 'B' massing & movement study

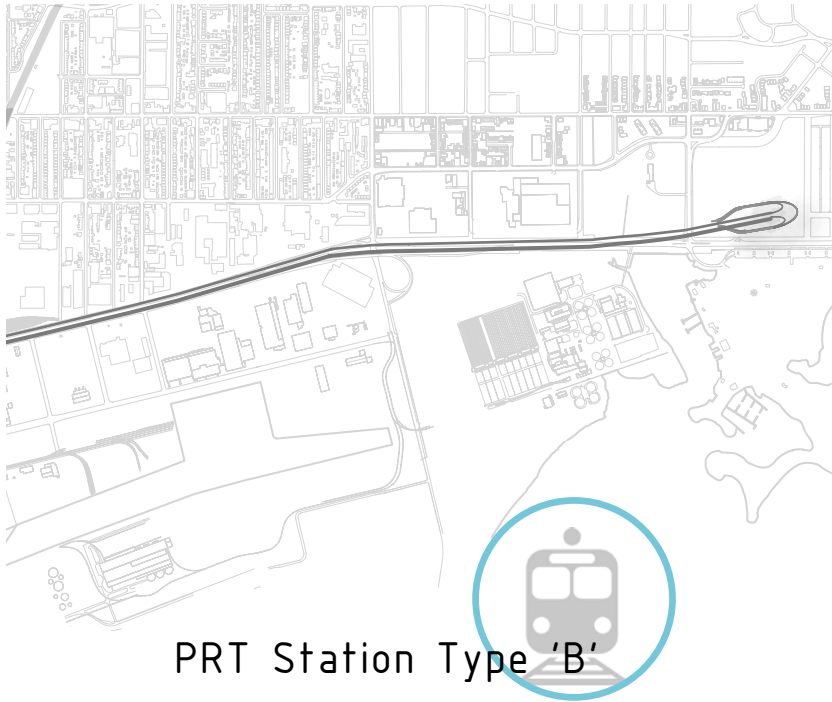

PRT Station Type 'B'

PRT Station Type 'B': three user groups, two GO rail Interchange stations. The existing GO station is located north of Exhibition Place in the vicinity of Liberty Village, and the proposed GO station is located directly south of the West Don Lands community adjacent to the Don River. The two stations are bounded by neighbourhoods designated for immediate revitalization. Although both Liberty Village and the West Don Lands are in close proximity to downtown, they are off the TTC subway line and are not well-served by the GO train, deterring local residents from using public transit. While the railway tracks once created a strong edge condition, the

implementation of PRT Interchange stations will allow the neighbourhoods to gain direct access to on-demand transport along the waterfront corridor.

The Gardiner PRT recognizes the importance of regional connections, catering to the needs of long-distance commuters entering downtown. GO transit carries over 200,000 daily commuters from as far as 100 km away from downtown.³⁵ The two Interchanges provide shower and changing facilities, as well as commercial services, on horizontal platforms that bridge the gap between the PRT system to the GO transit platforms.

A third user group, tourists visiting Toronto

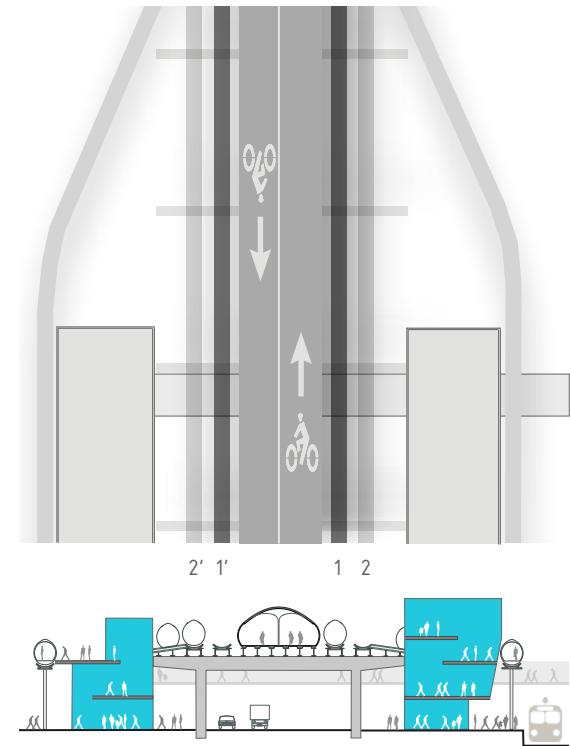

to participate in short term city-wide events such as the Canadian National Exhibition or the Toronto Expo 2015, are also accounted for. The two PRT Interchange stations are forecast to handle high volume of commuters who will frequent sites just south of the stations at the Ex and the Port Lands.

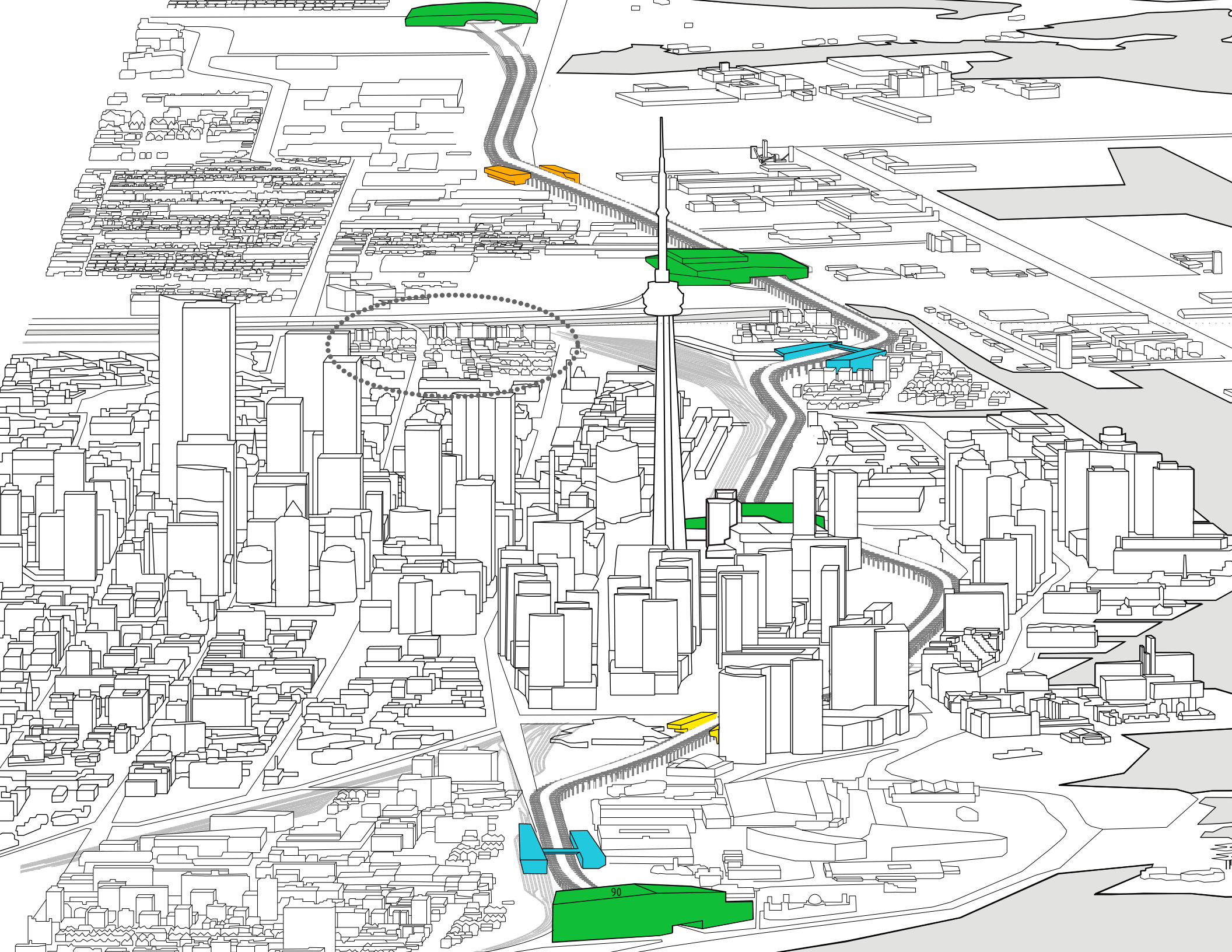

90

2013

KEATING STATION

FORT LAND STATION

WEST DONLANDS [2012]
5,800 RESIDENTIAL UNITS

DON RIVER STATION

UNION STATION

FORT YORK STATION

PARKDALE STATION

GARDINER STATION

TRACK PHASE 2
2,000 T-PODS

200,000 RIDERS/DAY

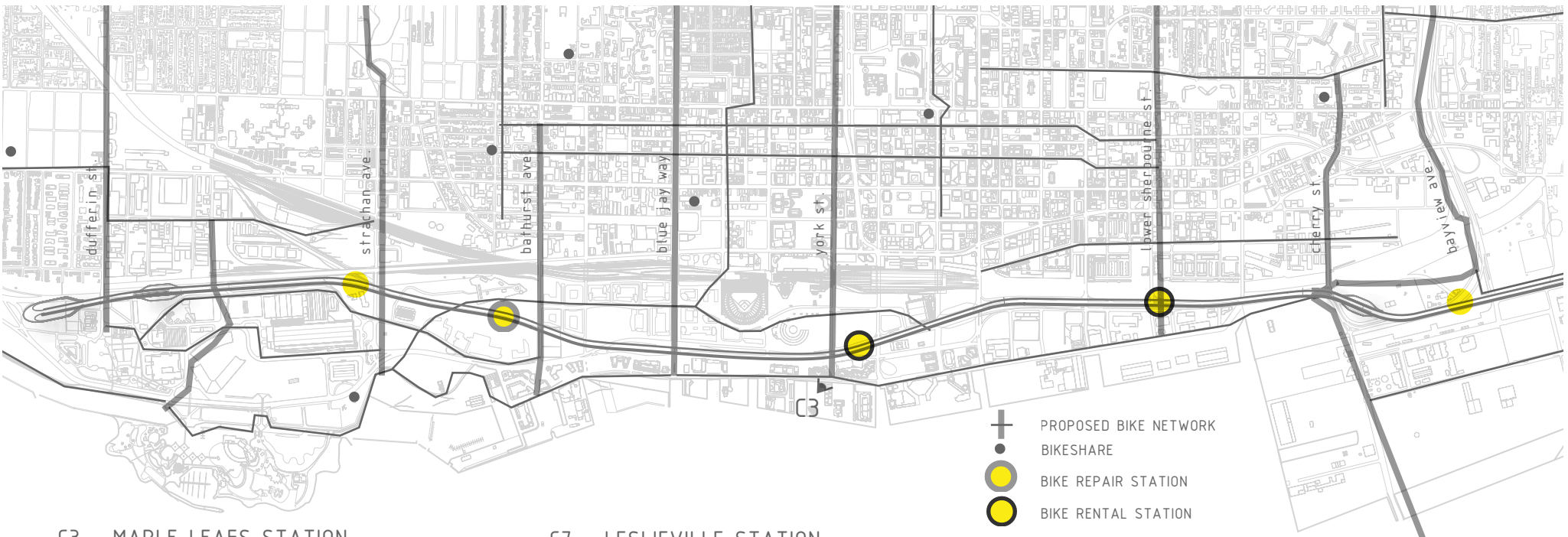

C3 - MAPLE LEAFS STATION

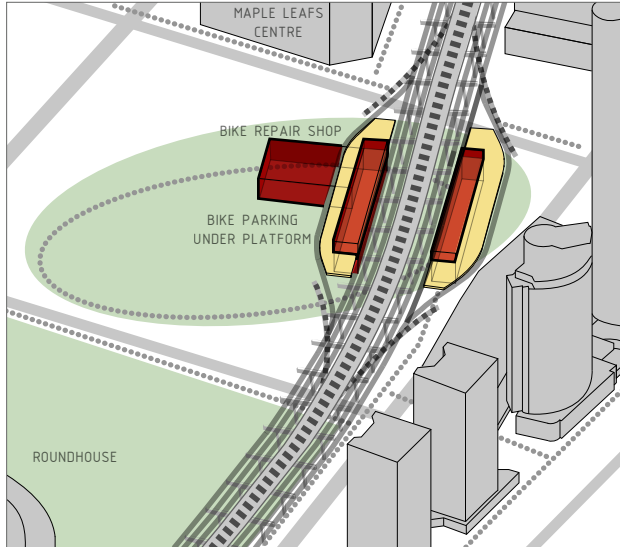

C7 - LESLIEVILLE STATION

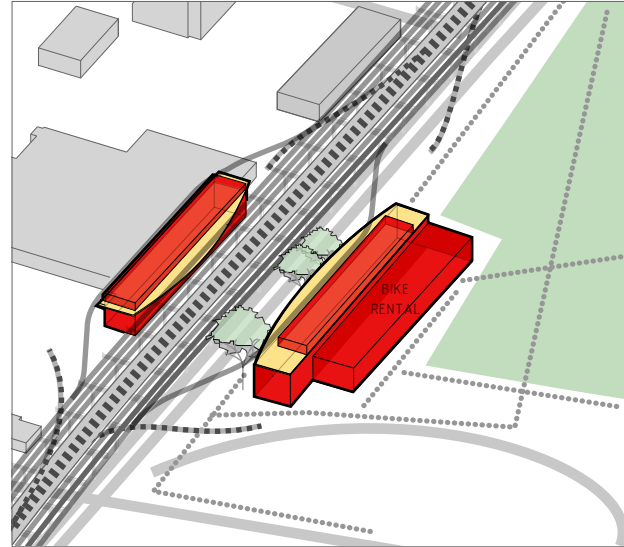

- CAR
- |||| RAILWAY
- ==== PRT
- STREETCAR
- ||||| BIKE PATH
- PEDESTRIAN
- PLATFORM
- PRT STATION
- BUILDING
- PARK
- PROPOSED

Figure 90 - Station 'C' located on site plan
 Station 'C' typical cross-section
 Station 'C' massing & movement study

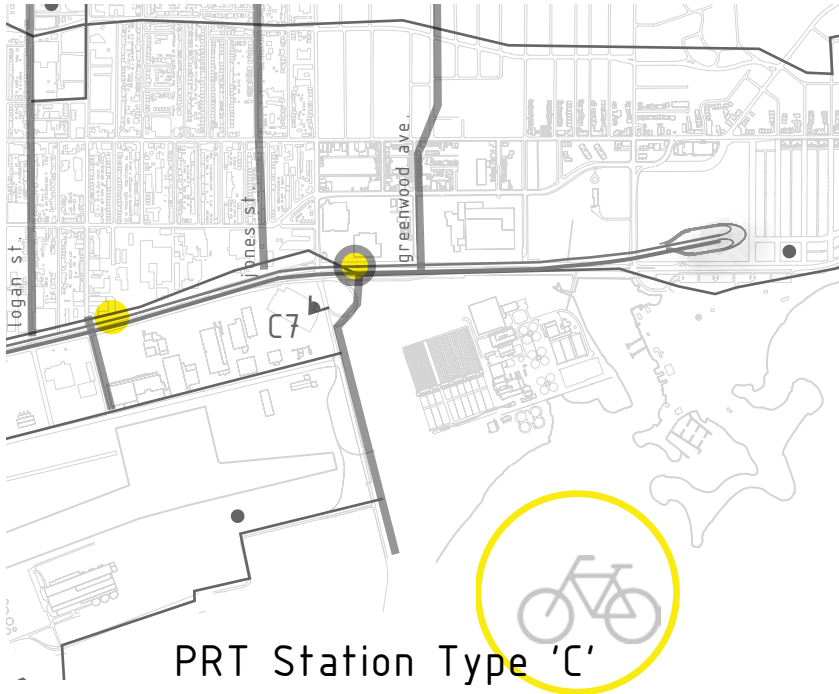

PRT Station Type 'C'

PRT Station Type 'C': bicycle friendly stations, located at major north-south streets designated by the Toronto Bike Plan to yield to on-street cycling lanes. Ramps descending from the Gardiner's colonnade structure provide access to the street and PRT stations. The routes create new connections between the city and the waterfront, encouraging cyclists to bike to work or to the water's edge (where they will find the Martin Goodman, Don River, and Leslie Street Spit trails) for leisure.

Cyclists who choose to carry their bikes on the PRT are accommodated by T-Pods designed to hold a passenger with a bicycle. The two

centralized stations inside the business district provide rest areas, showers, and change room facilities for cyclists who commute to work or bike couriers in between delivery shifts. Bike storage for up to two hundred bicycles is offered on the ground level at every station. The stations located closer to recreational areas in the vicinity of Fort York and Leslie Spit provide repair shops, air pumps, and rental amenities for local residents and active tourists. Bicycle organizations and riding clubs are welcome to congregate outside the station for group meets and organized bike rides. The stations are not mere functional transit hubs but rather

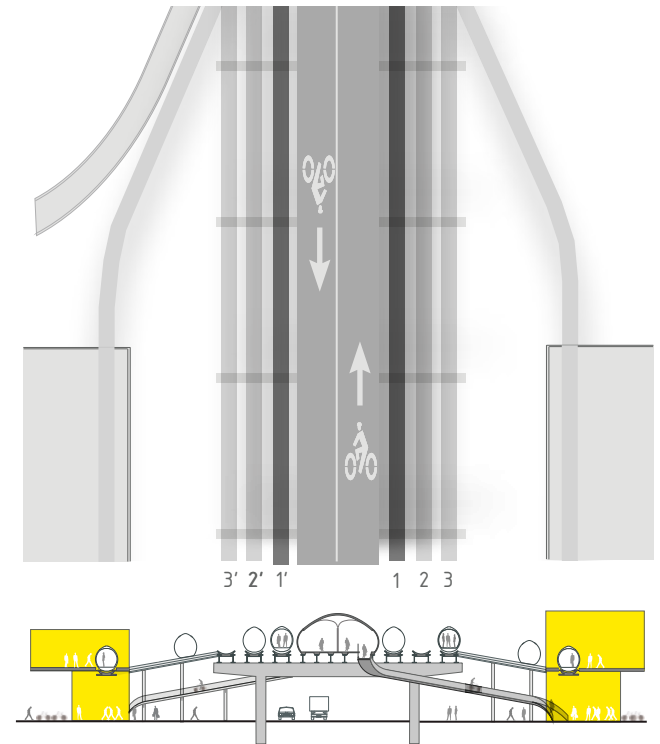

community centres where the culture of cycling is celebrated.

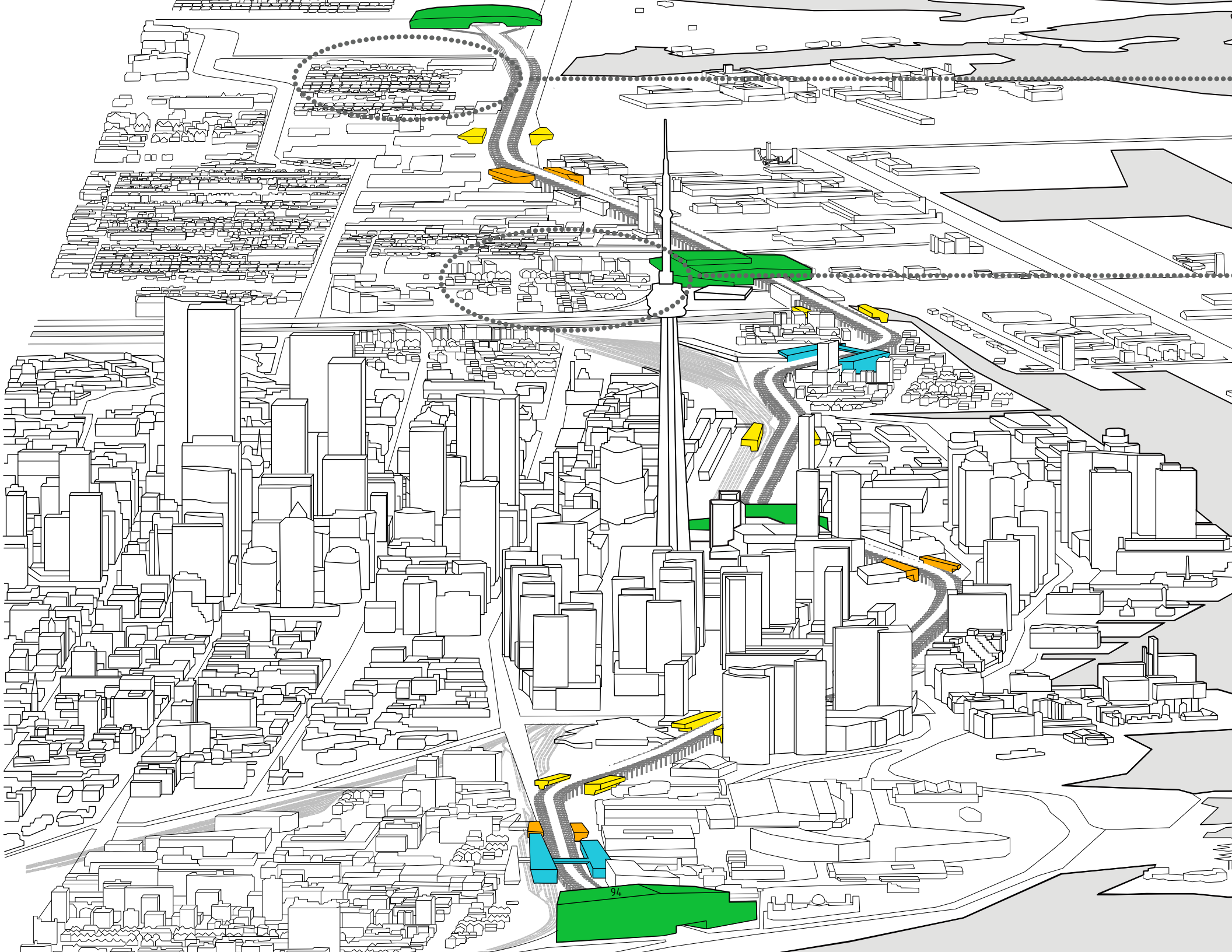

2014

WOODBINE TERMINAL

BEACHES [2013]
2,000 RESIDENTIAL UNITS

LESLIEVILLE STATION

KEATING STATION

DON RIVER STATION

EAST DONLANDS [2013]
5,800 RESIDENTIAL UNITS

COMMISSIONERS STATION

PORTLANDS STATION

DISTILLERY STATION

UNION STATION

ROGERS STATION

FORT YORK STATION

EXHIBITION STATION

LIBERTY STATION

PARKDALE STATION

GARDINER TERMINAL

TRACK PHASE 3
2,500 T-PODS
250,000 RIDERS/DAY



D2 - CITYPLACE STATION

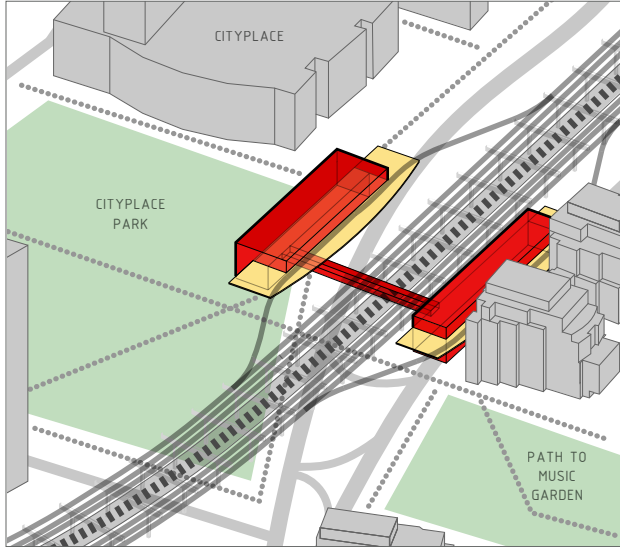

D5 - DISTILLERY STATION

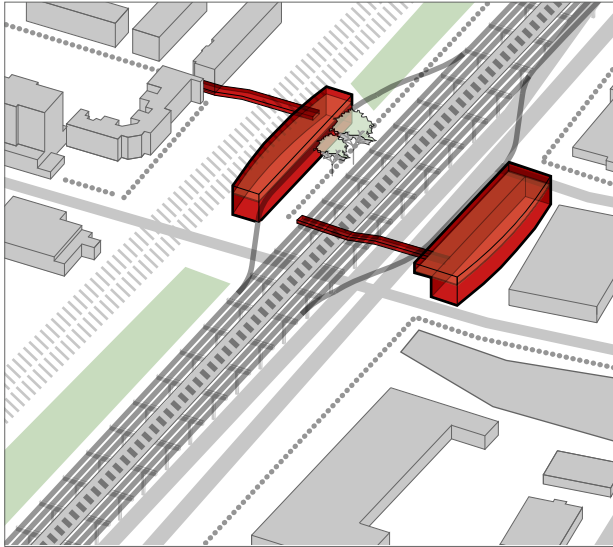

- CAR |||| RAILWAY === PRT - - - STREETCAR ■■■ BIKE PATH PEDESTRIAN
- PLATFORM ■ PRT STATION ■ BUILDING ■ PARK □ PROPOSED

Figure 92 - Station 'D' located in site plan
 Station 'D' typical cross-section
 Station 'D' massing & movement study

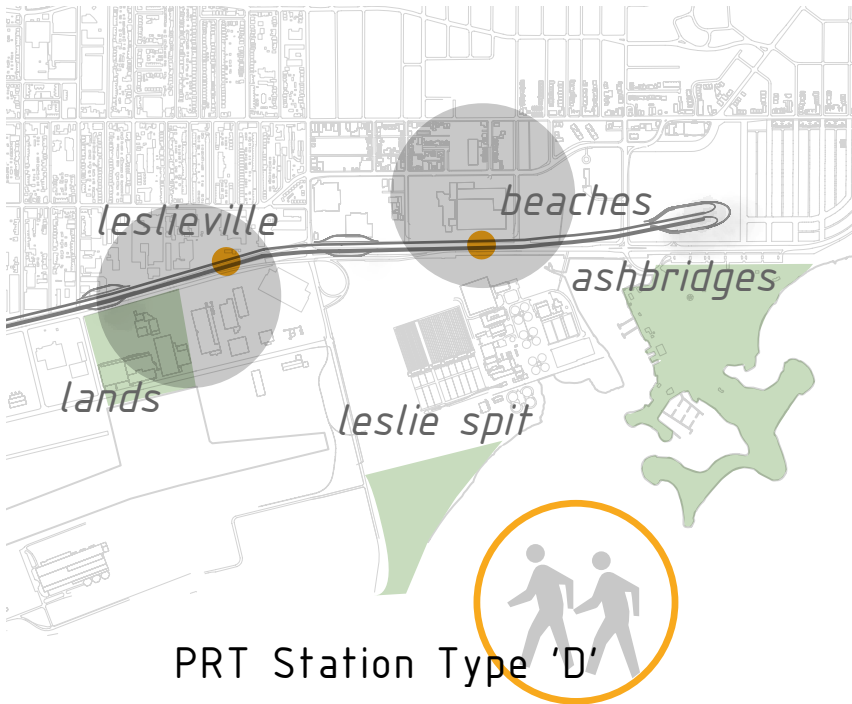

PRT Station Type 'D'

PRT Station Type 'D': mid-size stations that cater to pedestrians and the culture of the waterfront; stations are designed by residents according to their specific needs. Neighbourhoods included are Liberty Village, CityPlace, Harbourfront, St. Lawrence, East Bayfront, Distillery District, Leslieville, and the Beaches. Waterfront residents will be no more than a 5-minute walk away from their nearest PRT station. Station Type 'D' also operates in close proximity to many of the major attractions in the city, dropping passengers off at the doorstep of the CNE, Fort York, Music Gardens, Rogers Centre, CN Tower and Ashbridges Bay.

Clusters of shops, cafes, and retail outlets sustain the populated stations. New amenities and increased pedestrian activity create a vibrant streetscape that was once overshadowed by the Gardiner's vehicular ramps. The bulky ramps are replaced by an assortment of bridges, weaved under, over, and around the colonnade structure to ease pedestrians crossing from one side of the Gardiner to the other.

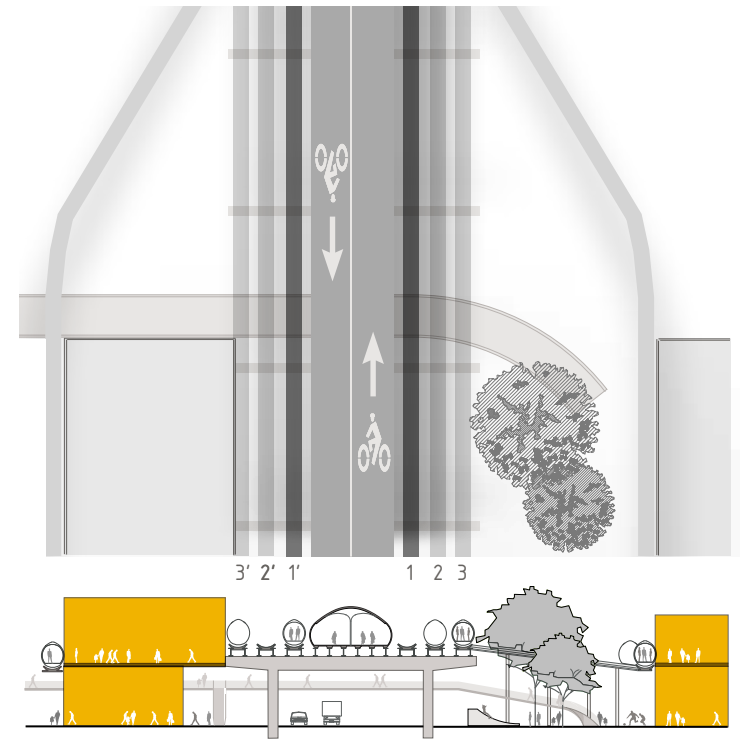

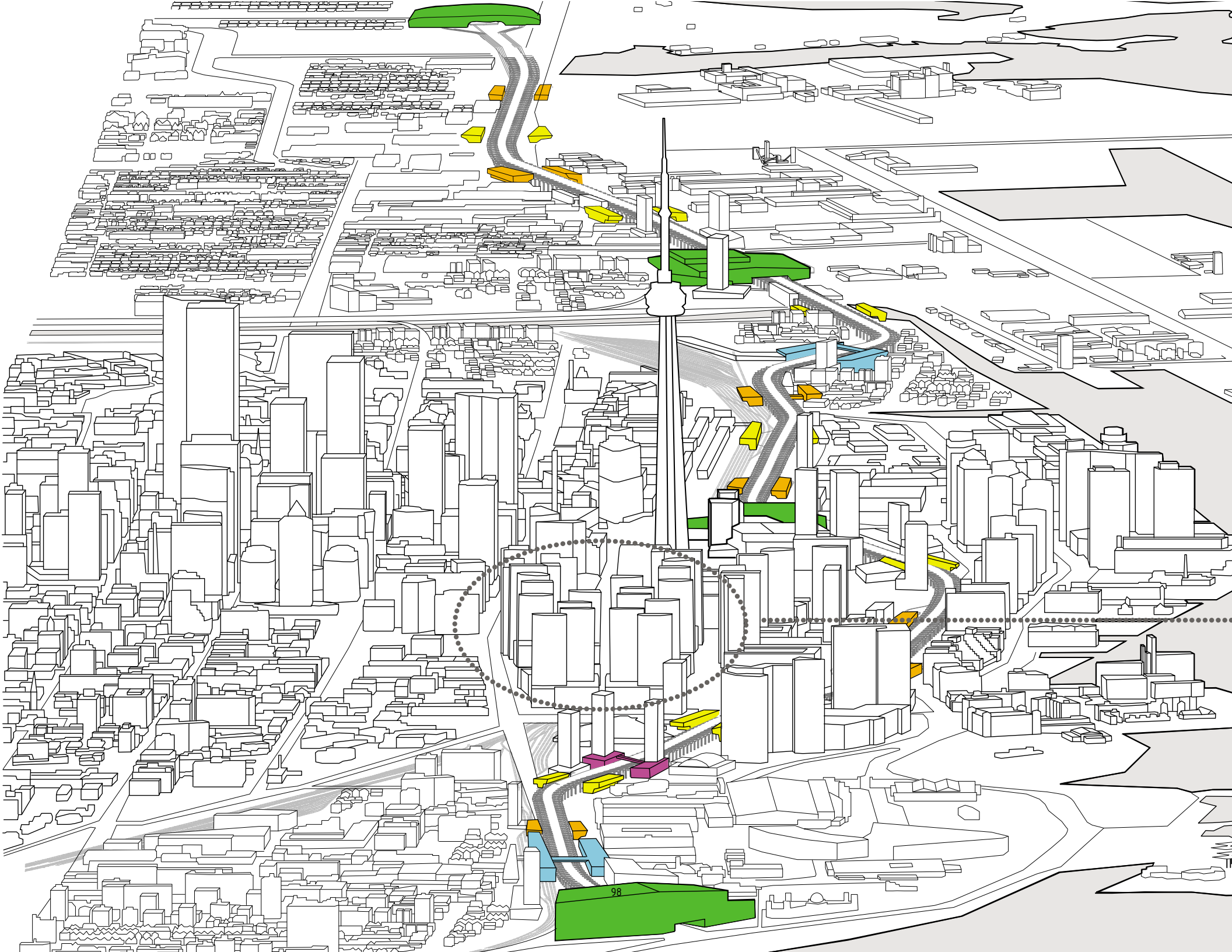

2015

WOODBINE STATION

ASHBRIDGES STATION

LESLIEVILLE STATION

KEATING STATION

CARLAW STATION

DON RIVER STATION

COMMISSIONERS STATION

PORTLANDS STATION

DISTILLERY STATION

EAST BAYFRONT STATION

ST. LAWRENCE STATION

UNION STATION

MAPLE LEAFS STATION

ROGERS STATION

CITYPLACE [2014]
7,500 RESIDENTIAL UNITS

CITYPLACE STATION

FORT YORK STATION

STATION TYPE 'E'

EXHIBITION STATION

LIBERTY STATION

PARKDALE STATION

GARDINER STATION

TRACK PHASE 3
3,000 T-PODS
300,000 RIDERS/DAY

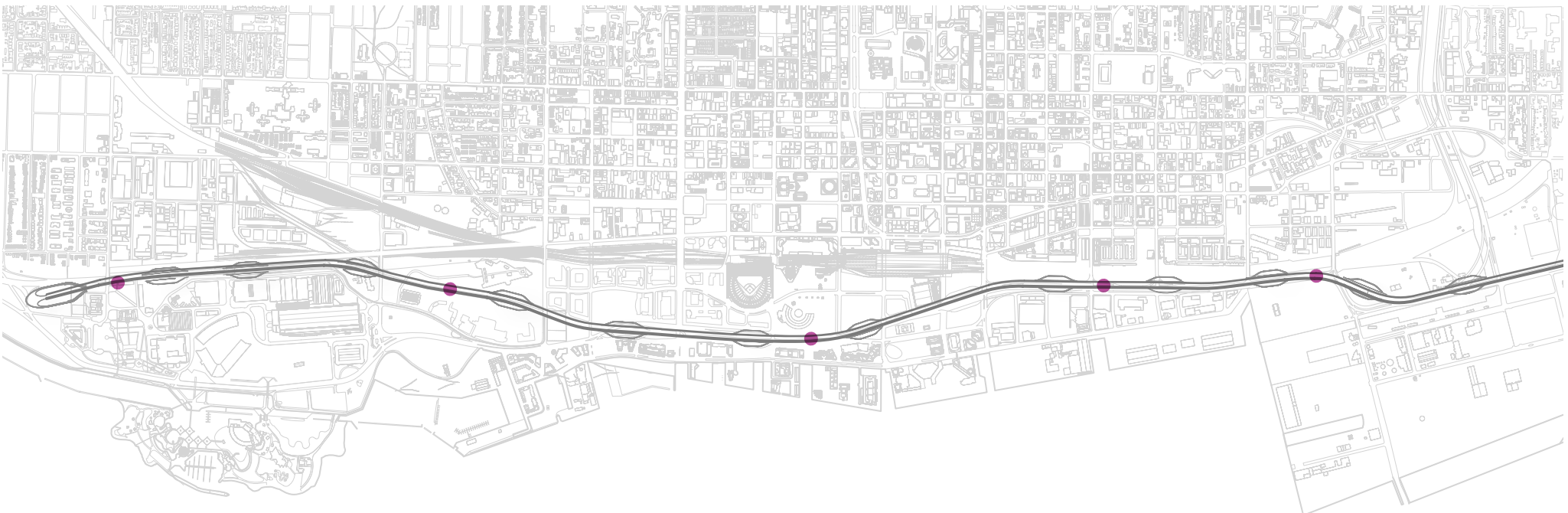

E - TYPICAL STATION

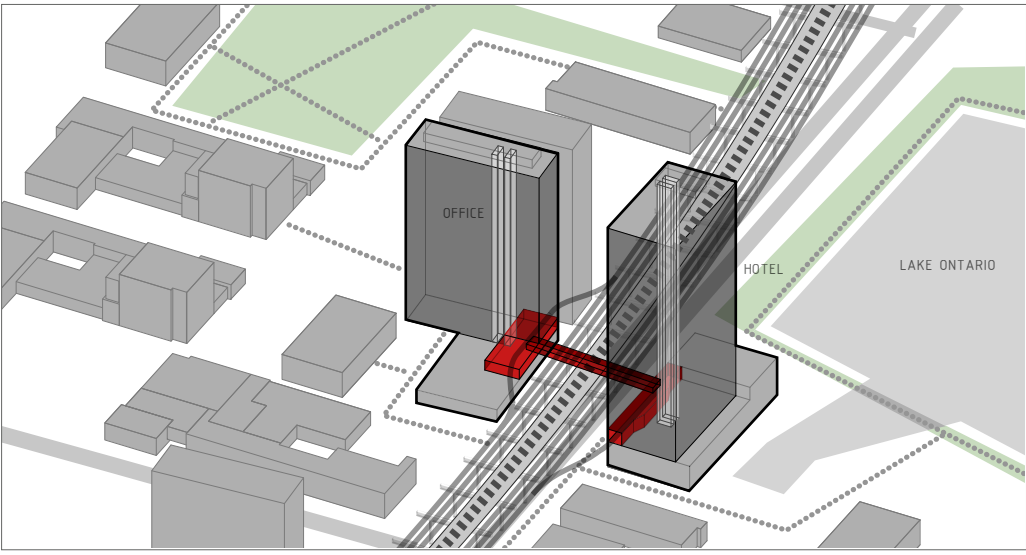

- CAR |||| RAILWAY |||| PRT - - - STREETCAR ■■■ BIKE PATH PEDESTRIAN
- PLATFORM ■ PRT STATION ■ BUILDING ■ PARK □ PROPOSED

Figure 94 - Station "E" located in site plan
 Station "E" typical cross-section
 Station "E" massing & movement study

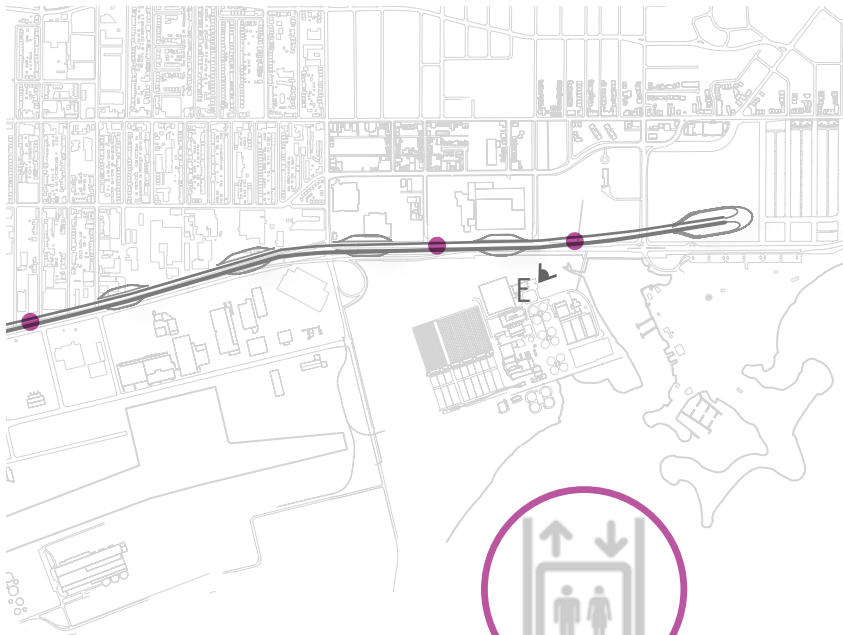

PRT Station Type 'E'

PRT Station Type 'E': implemented in the later phases of PRT system construction, most likely after 2015. The station is a compact unit assembled with pre-fabricated components and inserted into a specific building type, namely condominiums, hotels, or office towers. Planned intermittently along the PRT system, the stations (within their buildings) create a rhythm of vertical punctuations along the Gardiner's path.

Station Type 'E' is perhaps the apex of PRT, delivering perfectly uninterrupted travel for the individual. Tenants of the building are provided with direct access to the PRT platform and its proximity to the building's elevator core

encourages the seamless transition between the horizontal and vertical motion of personal mobility.

As a whole, the five PRT station types establish responsive transportation infrastructure integrated at various urban scales with Toronto and its waterfront. Connected to the city on multiple levels, the adaptive reuse of the Gardiner revives the infrastructure into a vital transport system to animate both the immediate waterfront and the urban context beyond.

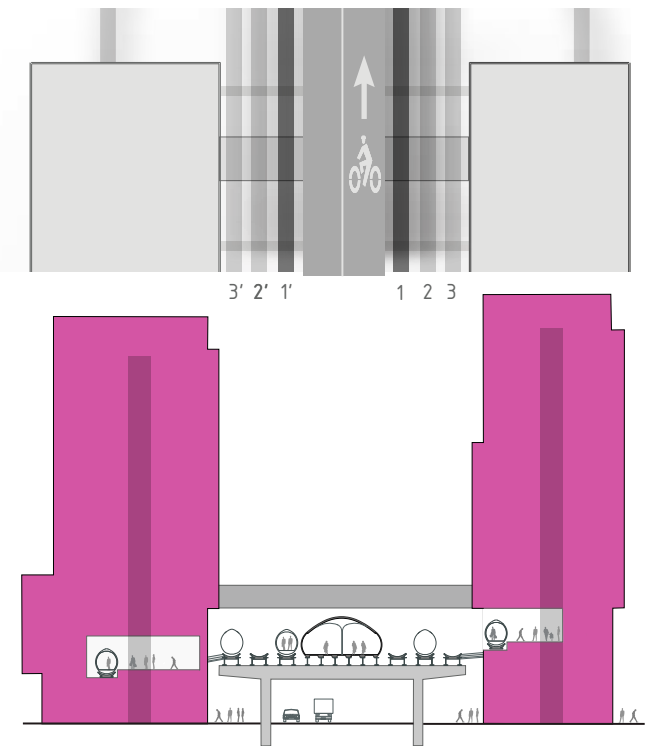

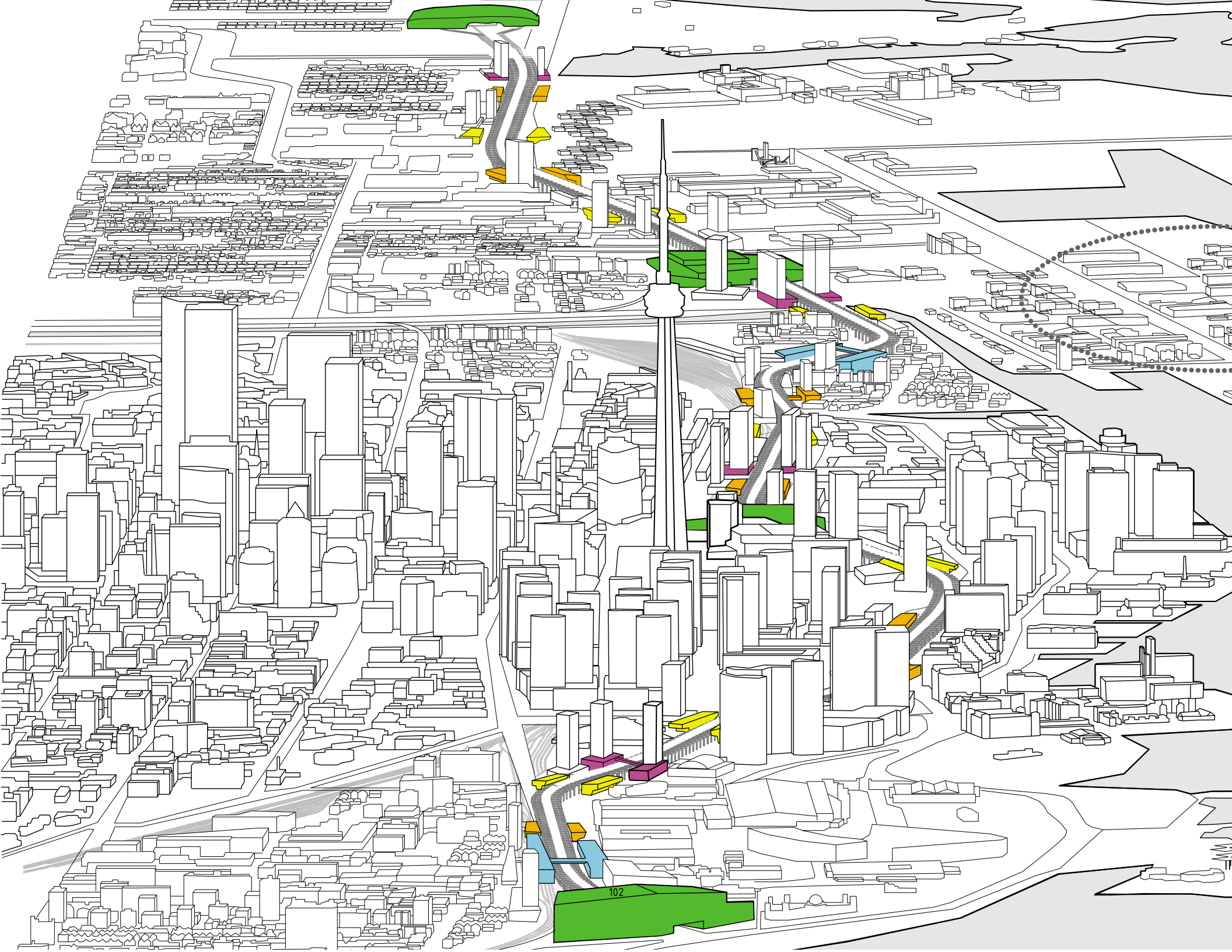

102

2015+

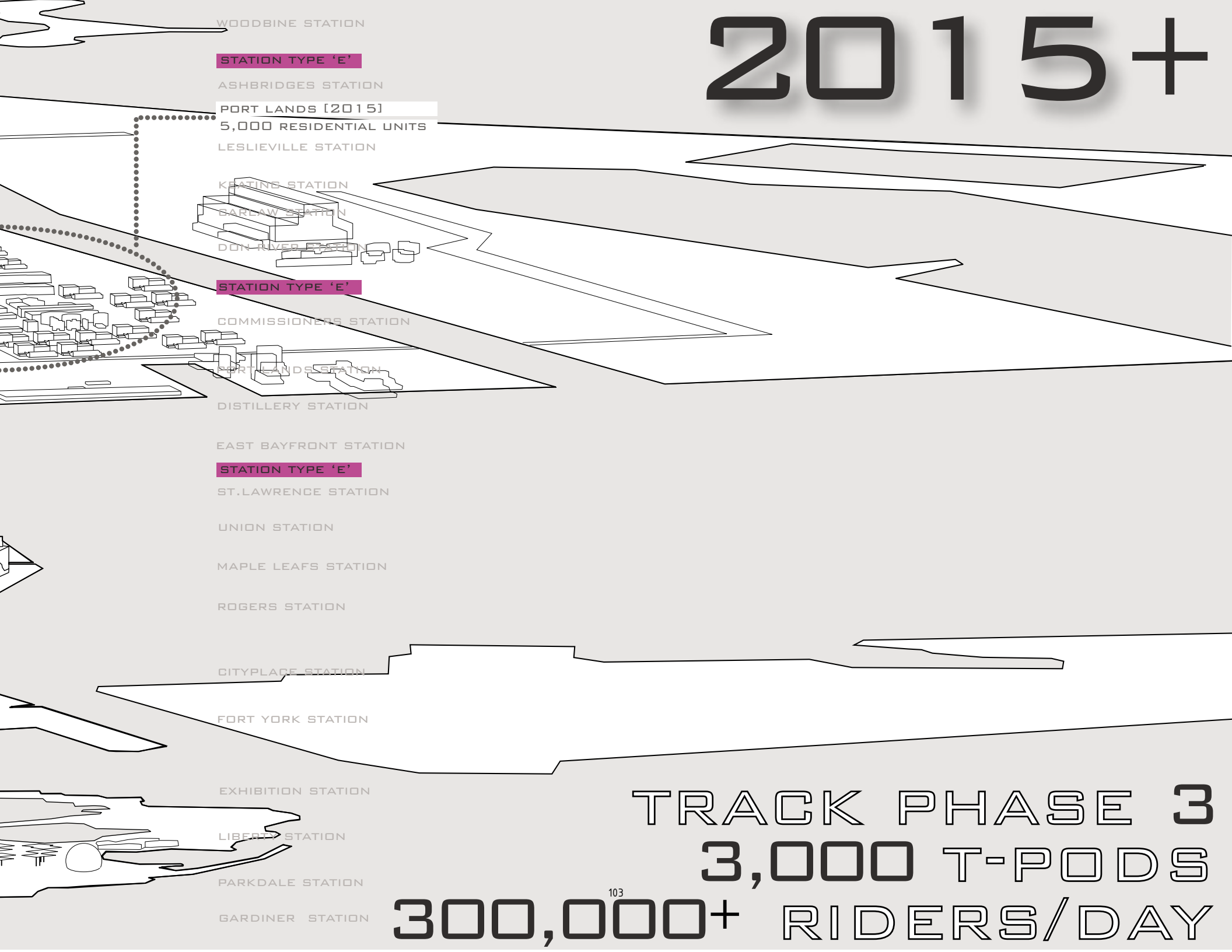

STATION TYPE 'E'

PORT LANDS [2015]
5,000 RESIDENTIAL UNITS

STATION TYPE 'E'

TRACK PHASE 3
3,000 T-PODS
300,000¹⁰³+ RIDERS/DAY



Vision of Mobility

Pods move passengers fluidly through the city, each ride unique and engaging. The journey from origin to destination is a continuous episode; departure, acceleration, and arrival blur into a mesmerizing trance. Impressions of the city shift from built forms to abstracted objects and shapes.

From the CN Tower looking down, a pattern of dots and lines outline the path of the Gardiner. Clusters form around stations; patterns emerge and dissolve, forms appear then evaporate. The peak hour elapses and a moment of release liberates hundreds of pods that speckle the city. An intense glow illuminates a meandering stream,

receding into the distance, stitching together the array of pods.

The elevated pod offers the individual new vantage points above the city streets. The traveller takes in sweeping views of Toronto's Don River, then encounters the city's looming towers. Building surfaces flicker like pixelated billboards.

The pods trickle through the city, staggered alongside the silhouettes of the bike tube. As the momentum of one pod slows down to dispatch, another one accelerates to trace a new trajectory through the city.

Figure 96 opposite - night rendering

RI

GWII

Z

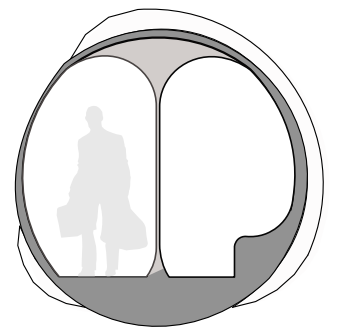



SUBWAY/RT/PRT ROUTE MAP

Ride the Rocket.



THE BETTER WAY

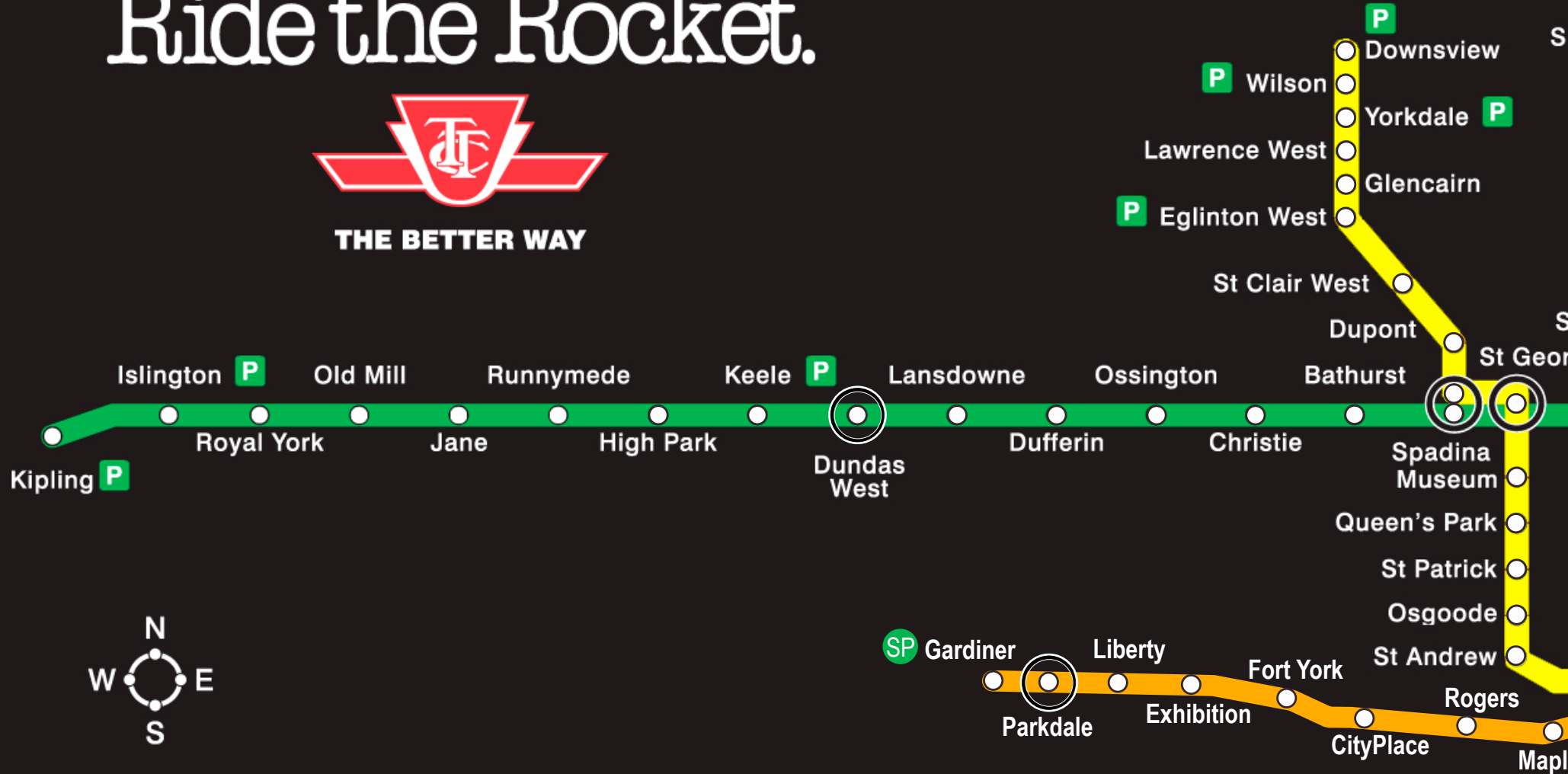

● Yonge-University-Spadina
 ● Bloor-Danforth
 ● Scarborough RT
 ● Sheppard
 ● Gardiner PRT

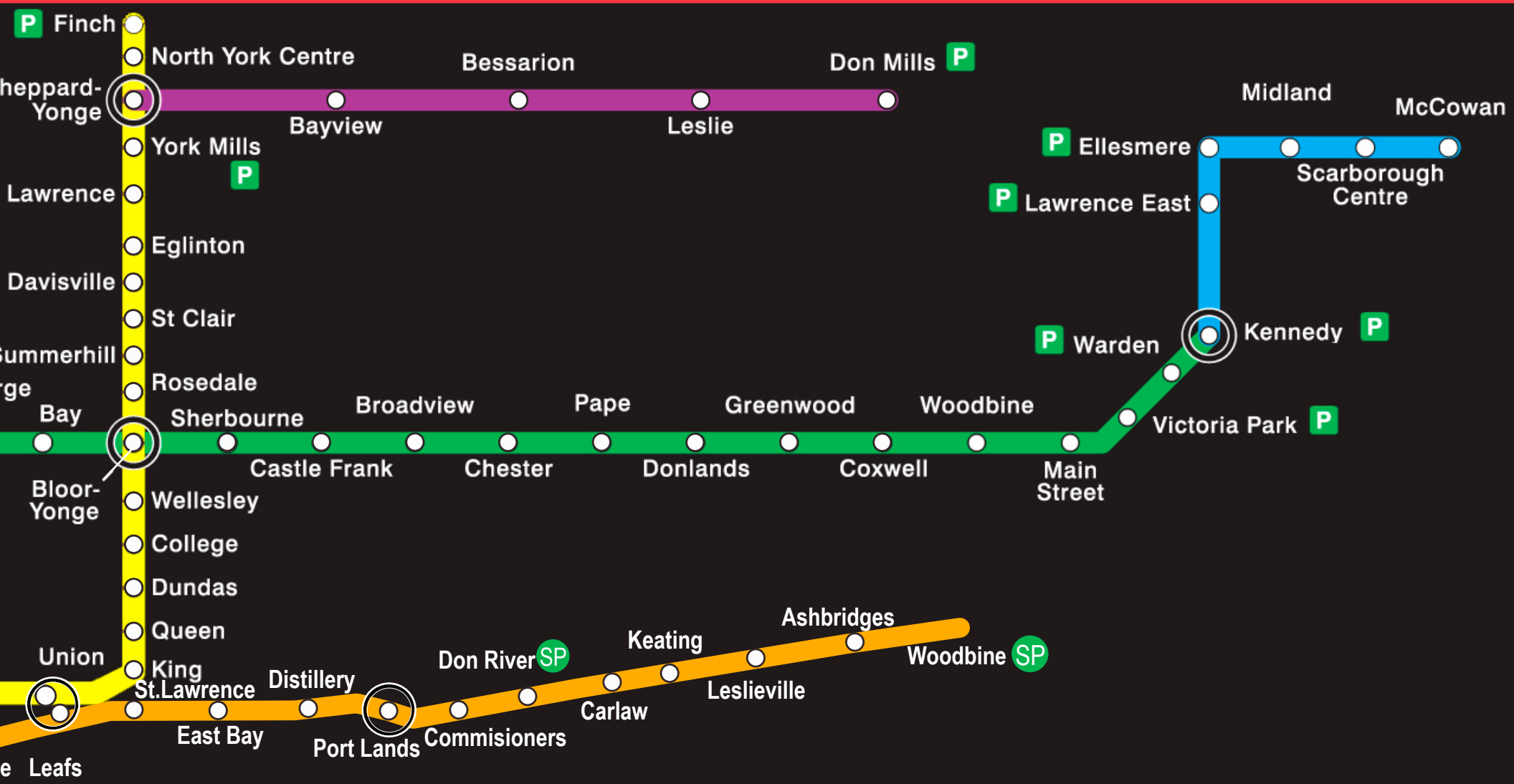

⊙ Interchange

SP Smart Park

P Parking

DE

DE

15

End Notes

NUMBER	SOURCE
01	Sewell, John. <i>Our Four-lane Fetish</i> . Eye Weekly. February 14, 2002.
02	Ferguson & Ferguson. <i>Guiding the Gardiner: A Plan for the Expressway's Place in the City</i> . October 1986. p 29.
03	Caplan, David. Canadian Urban Institute's GTA Transit Summit. February 6, 2004.
04	Webb, Bruce. <i>Engaging the Highway</i> . A+Y, vol. 289, October 1994. Tokyo, Japan.
05	Halprin, Lawrence. <i>Freeway</i> . New York, Reinhold Pub. Corp, 1966. p.24
06	Menino, Thomas. <i>Big Day for 'Big Dig'</i> . CBC News, December 20, 2003.
07	Ferguson, p. 8
08	Wikipedia. <i>Guiding Expressway</i> . August 31, 2006.
09	Canada NewsWire. <i>Safer Roads for a Safer Toronto</i> . September 13, 2005.
10	Transport Canada. <i>The Cost of Urban Congestion in Canada</i> . March, 2006.
11	Fulford, Robert. <i>Accidental City: The Transformation of Toronto</i> . 1995
12	Ghenu, Mike. <i>Tunnel Vision</i> . March 28, 2006.
13	Mau, Bruce. <i>Raise the Gardiner</i> . Toronto Life. June, 2002.
14	Van Nostrand * McIlroy, Brook. <i>Gardiner Expressway Transformation Study</i> . Toronto Life. June, 2002.
15	Gutierrez, Jose R. <i>The New Gardiner Viaduct</i> . April 2005.
16	Ministry of Finance. <i>Strengthening Ontario's Transportation Infrastructure</i> . March 23, 2006
17	City of Toronto Cycling Study, Marshall Macklin Monaghan Limited and Decima Research, 1999
18	NOW Web news. <i>The Bike Plan is going backwards</i> . January 4, 2006.
19	Statistics on Union Station retrieved from the City of Toronto World Wide Web: <www.toronto.ca>
20	Toronto Official City Plan. <i>Chapter Two: Shaping the City</i> . November, 2002. p. 20
21	Toronto Official City Plan. <i>Toronto's Growth Prospects</i> . November, 2002. p. 17
22	Toronto Waterfront Revitalization Corporation anticipates over 40,000 new housing units for over 68,000 people in the Central Waterfront. <i>Toronto Central Waterfront Plan "Making Waves"</i> . 2002.
23	University of Toronto, <i>F.G. Gardiner Expressway 24-Hour Volume Study</i> . 2004.
24	Statistic retrieved in 2006 from the <i>407 ETR World Wide Web</i> : <www.407etr.com>
25	Colliers International. <i>North America CBD Parking Rate Survey</i> . 2006.

End Notes

NUMBER	SOURCE
26	Statistics retrieved in 2006 from the <i>Toronto Parking Authority</i> World Wide Web: <www.greenp.com>
27	Statistics retrieved in 2006 from the <i>Transport for London Congestion Charging</i> World Wide Web: <www.cclondon.com>
28	Ministry of Transportation. <i>The GTA Farecard: A seamless Fare Collection System</i> . World Wide Web: <www.mto.gov>
29	Statistics retrieved in 2006 from the <i>ULTra PRT Advanced Transport System</i> World Wide Web: <www.atsltd.co.uk>
30	Calculation based on Kinetic Network cost estimates for a Seattle PRT System retrieved in 2006 from the <i>Kinetic Network PRT</i> World Wide Web: <kinetic.seattle.wa.us>
31	Statistics retrieved from the <i>Transit Toronto</i> World Wide Web: <transit.toronto.on.ca>
32	Statistics retrieved in 2006 from the <i>Kinetic Network PRT</i> World Wide Web: <kinetic.seattle.wa.us>
33	City of Toronto. <i>City of Toronto Bike Plan: Shifting Gears</i> . June, 2001. p. 24
34	Statistics on Union Station retrieved from the <i>City of Toronto</i> World Wide Web: <www.toronto.ca>
35	Statistics retrieved from the <i>GO Transit</i> World Wide Web: <www.gotransit.com>

Bibliography

HARDCOPY REFERENCES

- Colton, Timothy J. *Big Daddy : Frederick G. Gardiner and the Building of Metropolitan Toronto*. Toronto: University of Toronto Press, 1980.
- Ferguson & Ferguson. *Guiding the Gardiner: A Plan for the Expressway's Place in the City*. October 1986.
- Fulford, Robert. *Accidental City: The Transformation of Toronto*. 1995
- Halprin, Lawrence. *Freeways*. New York, Reinhold Pub. 1966.
- Lynch, Kevin. *Good City Form*. Cambridge, MIT Press, 1981 June, 2002.
- Mau, Bruce. *Raise the Gardiner*. Toronto Life. June, 2002.
- Meurs, Paul and Verheijen, Marc. *In Transit: Mobility, City Culture and Urban Development in Rotterdam*. Rotterdam NAI Publishers, 2003.
- Reuber, Paul. *Urbanizing the Gardiner*. October 1986.
- Richards, Brian. *Future Transport in Cities*. London ; New York: Spoon Press, 2001.
- Safdie, Moshe. *The City After the Automobile: An Architect's Vision*. Colorado: Wesview Press, 1998.
- Schwarzer, Mitchell. *Zoomscape: Architecture in Motion and Media*. 1st ed. New York: Princeton Architectural Press, 2004.
- Webb, Bruce. *Engaging the Highway*. A+Y, vol. 289, October 1994. Tokyo, Japan.

Bibliography

ELECTRONIC REFERENCES – OFFICIAL PLANNING REPORTS, STUDIES, STATISTICS

- 407 Electronic Toll Road. 2006. Statistics. <http://www.407etr.com/about/about_highway_story.asp> (accessed September 2006).
- Architects Alliance. 2003. *Gardiner Expressway Transformation [GET] Study*. PDF. (accessed September 2005)
- City of Toronto. 2002. *Front Street Extension*. <http://www.toronto.ca/waterfront/front_extension.htm> (accessed September 2006).
- City of Toronto. *Toronto Official City Plan*. November, 2002. <http://www.toronto.ca/planning/official_plan/pdf_chapter1-5/chapter1-5_toc.pdf> (accessed September 2006).
- City of Toronto. 2001. *City of Toronto Bike Plan: Shifting Gears*. <http://www.toronto.ca/cycling/bikeplan/pdf/bike_plan_full.pdf> (accessed September 2006).
- Colliers International. 2004. *North America CBD Parking Rate Survey*. <http://www.colliers.com/Content/Repositories/Base/Corporate/English/Market_Report_Corporate/PDFs/ColliersParkingRateSurvey2004.pdf#search=%22Colliers%20Parking%20Survey%202004%22> (accessed September, 2006).
- Ministry of Finance. 2002. *Strengthening Ontario's Transportation Infrastructure*. <<http://www.ontariobudget.ca/english/bk1.html>> (accessed September 2006).
- Toronto Parking Authority. 2006. *Toronto Parking Authority Annual Report 2004*. <<http://www.greenp.com/tpa/publications/annualreport/2004/TPA%20Annual%20Report.pdf>> (accessed September, 2006).
- Toronto Waterfront Revitalization Corporation. 2006. *East Bayfront & West Don Lands Planning*. <<http://www.towaterfront.ca>> (accessed September, 2006).
- Transport Canada. 2006. *The cost of Urban Congestion in Canada*. Environmental Affairs. <<http://www.tc.gc.ca/programs/Environment/EconomicAnalysis/docs/summary.pdf>> (accessed September, 2006).

ELECTRONIC REFERENCES – RESEARCH & STATISTICS

- Alcock, James B. 2005. *Missing Links: A Complete History of Toronto's Controversial Expressway Systems*. Get Toronto Moving. <<http://www.gettorontomoving.ca/missinglinks22.html>> (accessed September, 2006).
- Canada NewsWire. 2005. *Safer Roads for a Safer Toronto*. Arrive Net Press. <<http://press.arrivenet.com/business/article.php/692466.html>> (accessed September, 2006).
- Caplan, David. 2004. *Canadian Urban Institute's GTA Summit*. Minister of Public Infrastructure Renewal. <http://www.pir.gov.on.ca/userfiles/HTML/cma_4_35637_1.html> (accessed September, 2006)
- CBC News. 2003. *Big Day for 'Big Dig'*. Mayor Thomas Menino. <<http://www.cbsnews.com/stories/2003/12/20/national/main589677.shtml>> (accessed September, 2006)
- GO Transit. 2006. *GO Transit*. <<http://www.gotransit.com/PUBLIC/aboutgo/whatisgo.htm>> (accessed September, 2006).
- Gutierrez, Jose. 2005. *The New Toronto Viaduct*. Toronto Waterfront Viaduct. <<http://www.toviaduct.com/Home.html>> (accessed September, 2006).
- Ministry of Transportation. 2006 *The GTA Farecard*. <<http://www.mto.gov.on.ca/english/traveller/farecard>> (accessed September 2006).
- NOW Magazine. 2005. *The Bike Plan is Going Backwards*. <http://www.nowtoronto.com/issues/2005-12-29/news_story.php> (accessed September, 2006).
- Sewell, John. 2002. *Our Four-lane Fetish*. Eye Weekly. <http://www.eye.net/eye/issue/issue_02.14.02/news/citystate.php> (accessed September, 2006).
- Transport for London. 2006. *Congestion Charging*. <<http://www.cclondon.com/>> (accessed September, 2006).
- University of Toronto. 2004. *F.G. Gardiner Expressway 24-Hour Volume Study*. PDF. (accessed December 2005).

Bibliography

ELECTRONIC REFERENCES – PHOTOGRAPHS & DIGRAMS

Bernard Electronic Archives <www.beatl.barnard.columbia.edu>

Canadian Nuclear Society <www.cns-snc.ca>

CityPlace <www.cityplace.ca>

Coaster's Enthusiasts of Canada <www.cec.chebucto.org>

David Till Photographs <www.davetill.com>

Frank Eigler <www.webelastic.org>

Highline <www.thehighline.org>

KBS World <www.world.kbs.com>

Korkas <www.korkas.com>

Made in Tokyo <www.dnp.co.jp>

Mass Turn Pike <www.massturnpike.com>

Skyscraper Page <www.skyscraperpage.com>

Statistics Canada <www.statcan.ca>

Tino <www.tino.ca>

Toronto District School Board <www.tdsb.on.ca.com>

Transport for London <www.tfl.gov.uk>

Westway Trust Fund <www.westway.org>

ELECTRONIC REFERENCES – PRT ILLUSTRATIONS & STATISTICS

Carbon <www.carbon60.com>

Kinetic Network <www.kinetic.seattle.wa.us>

Knolle Magnettrans <www.knollemagnettrans.com>

Modular Automated Individual Transport <www.trasporti.ing.unibo.it>

SkyWeb Express <www.taxi2000.com>

ULTra <www.atsltd.co.uk>

Unimodal <www.unimodal.com>

University of Washington <www.faculty.washington.edu>

SkyTran <www.skytran.net>

Zapato Productions <www.zapatopi.net>

Appendix A

Gardiner PRT Policy, Planning and Cost Estimation

- 2006 - PHASE 1 *Gardiner Expressway Toll* [see Chapter 5.2] +\$100 million revenue/year
In 2006, 200,000+ daily vehicles travel on the Gardiner Expressway, 80% of the vehicles enter downtown Toronto. Vehicles are required to pay a \$2 toll. Based on studies that predict a DVP & Gardiner Toll to generate \$150 million/year, the Gardiner Expressway Toll alone is estimated to generate one third of the \$150 million.
- 2007 - PHASE 2 *Central Business District Parking Levy* [see Chapter 5.3] +\$40 million revenue/year
The parking surcharge is managed by the Toronto Parking Authority. The average daily parking rate of \$16 CAN. increases to \$20 CAN. (raising the revenue by 25%). For the 2005 fiscal year, the City of Toronto received \$34.4 million from the TPA to be reinvested in transit. After the Parking Levy is implemented, it is anticipated that the TPA can contribute \$40 million/year towards new transit initiatives.
- 2008 - PHASE 3 *Front Street Extension* [see Chapter 5.4] -\$265 million
The Front Street Extension is built from a combination of resources: government funding (as part of the \$1.2 billion approved by the three levels of government in 2004 to improve transit infrastructure) and revenue from the Gardiner Expressway Toll.
- 2010 - PHASE 4 *Congestion Charge* [see Chapter 5.5] +\$32.9 million revenue/year
The Gardiner Expressway Toll is replaced by a broader Congestion Charge to cover Toronto's Central Business District. During the toll's scheduled hours of operation, motorists are charged \$15 to drive in central Toronto. London uses a similar congestion charge and predicts that after its expansion of the system in 2007, it will raise more than £1.3 billion over the next ten years. Based on London's estimate, Toronto can expect a revenue of over \$30 million/year from Smart Parks. [Assume \$6 all day parking x 15,000 parking spaces x 365 days = \$32.9 million/year].
- 2010 - PHASE 5 *Smart Parks* [see Chapter 5.6] +\$2.6 million revenue/year
The Smart Parks facilities are built from the revenue generated by the Parking Levy. The Smart Parks provide 15,000 parking spaces in total. Parking in these structures cost significantly less than parking inside the CBD. Construction of the Smart Parks begins with the two facilities that attract the drivers entering the downtown from the QEW and DVP. The Smart Parks are scheduled to be in operation with the first phase of the PRT tracks. The facilities are estimated to generate \$100,000/day.
- 2011 - PHASE 6 *Remove and Retain the Gardiner Expressway* [see Chapter 5.7] -\$186 million
The ramps flanking the expressway and the concrete road deck are eliminated. [In 2002, 1.3 kilometres of the Gardiner Expressway was dismantled at a cost of \$41 million.] The concrete piers and steel girders are retained. The estimated cost of renovating the Gardiner is \$186 million [6.2 kilometres x \$30 million = \$186 million].

Appendix B

Gardiner PRT Track Phasing and Ridership Estimates

- 2012 A semi-enclosed bike path is built along the median of the Gardiner above the existing concrete piers.
TRACK PHASE 1 implemented. *Station 'A'* all implemented.
1,500 T-PODS in operation → 150,000 riders/day.
Based on a similar PRT scenario calculation by Kinetic Networks, the Gardiner PRT assumes:
The average passenger per trip is 1.8 [Kinetic Networks assumes 1.2, similar to the statistic of passenger per vehicle. The Gardiner PRT assumes 1.8 due to the increase of passengers during express service.]
The speed of the T-Pod is 65 km/hour. The length of the PRT line is 7.5 km. The average distance traveled by a passenger is assumed at 5.0 km. At a speed of 65 km/hr it takes 5 mins to reach 5.0 km.
The average duration of a passenger in a T-Pod is 5 minutes plus 0.5 minute reloading at a station.
Therefore, in one hour, one T-pod can make 10.9 trips. [60 minutes/5.5 minutes = 10.9/vehicle/hour].
1,500 T-Pods can make 16,350 trips/hour. [1500 T-Pods x 10.9 = 16,350 trips/vehicle/hour].
A 24-hour estimate including peak and non-peak service for 1,500 T-Pods is 150,000 trips.
- 2013 *TRACK PHASE 2* implemented. [+500 T-Pods] *Station 'B'* all implemented. Selected *Station 'B' & 'C'* implemented.
2,000 T-PODS in operation → 200,000 riders/day.
84,000 new waterfront residents since 2006.
[Toronto is forecast to accommodate half a million people by 2031. The waterfront is anticipated to house 350,000 of the half a million over the next 25 years. 350,000 residents/25 years x 6 = 84,000 residents/year.]
- 2014 *TRACK PHASE 3* implemented. [+500 T-Pods] Selected *Station 'C' & 'D' & 'E'* implemented.
2,500 T-PODS in operation → 250,000 riders/day.
+14,000 waterfront residents.
- 2015 *TRACK PHASE 3* continued. [+500 T-Pods] Selected *Station 'C' & 'D' & 'E'* implemented.
3,000 T-PODS in operation. (Gardiner PRT reaches T-pod capacity) → 300,000 riders/day.
+14,000 waterfront residents.
- 2015+ *TRACK PHASE 3* continued. Selected *Station 'E'* implemented.
3,000 T-PODS in operation → 300,000+ riders/day.
+ waterfront residents.

Appendix C

Personal Rapid Transit Projects

PRT Predecessors

- 1975–1978 Hagen, Germany. *Cabintaxi*. A test track was built with 24 operating vehicles. The system logged a total of 17,500 hours.
- 1975–current West Virginia, U.S.A. *Mogantown Personal Rapid Transit*. A 6-kilometer PRT track was built in the University of West Virginia campus. A fleet of 70 vehicles run on the tracks and each carry up to 20 passengers. Its ridership hit a record number of 31,280 passengers on August 21, 2006. <http://www.nis.wvu.edu/Releases_Old/wvu_beats_disney.html>
- 1990 Minneapolis, U.S.A. *SkyWeb Express*. Vehicle carries 3 passengers. <<http://www.taxi2000.com/>>
- mid 1990s U.S.A. *UniModal SkyTran*. Vehicle carries 2 passengers. <<http://www.unimodal.com>>

PRT To be Implemented

- 2008 London, U.K. *ULTra [Urban Light Transport]*. A PRT system is to be built at London's Heathrow Airport to transport 11,000 passengers per day from remote parking lots to the central terminal area. Vehicles have four seats and travel at 40 km/hr. <<http://www.atsltd.co.uk/prt/spec>>
- 2010 Uppsala, Korea. *Vectus*. A test track is currently in construction in Sweden to evaluate PRT's operation in a demanding winter climate. Vehicle carries 4–5 passengers and travel at 45 km/hr. <http://vectus.se/eng_index.html>