

# **Experiences with Prefabrication and Habitat for Humanity**

by

Carolyn Mary Bilson

A thesis  
presented to the University of Waterloo  
in fulfillment of the  
thesis requirement for the degree of  
Master of Architecture

Waterloo, Ontario, Canada, 2007

© Carolyn Bilson 2007

## **Author's Declaration**

I hereby declare that I am the sole author of this thesis. This is a true copy of the thesis, including any required final revisions, as accepted by my examiners.

I understand that my thesis may be made electronically available to the public.

## **Abstract**

This thesis chronicles my experiences with developing a panelized wall system for use by Habitat for Humanity and with testing that system in the design and construction of a house. Presented as a series of narratives, it follows the progress of the project from August 2003 to December 2005. Described is my motivation to test my theories through design and construction, the applicability of prefabrication to Habitat for Humanity's use of unskilled volunteer labour, the incorporation of panelization into the design of a house for the Waterloo Region affiliate of Habitat for Humanity, the prefabrication of preclad wood framed wall panels for this house by students at the University of Waterloo School of Architecture, the erection of these wall panels on-site, and the completion of the house to a weathertight state. The thesis concludes with discussions of the understanding I gained through my experiences, the necessity for further development and testing of the panelized wall system, and the future use of prefabrication by Habitat for Humanity.

## Acknowledgements

Many thanks go to my supervisor Terri Meyer Boake and to my advisors Mike Elmitt and John Straube.

Special thanks go to Olivia Keung, to Professors Rick Haldenby, Donald McKay, and Lloyd Hunt, and to my external reader Miljana Horvat.

I would also like to thank:

Terry Petkau, Habitat for Humanity Canada;

Mark Salerno, Canada Mortgage and Housing Corporation;

Brian Thornton, Habitat for Humanity Toronto;

Cathy Lyons, Habitat for Humanity Northumberland;

Julie Coley and Ted, Habitat for Humanity London;

Ken Stewart and Ralph Totman, Habitat for Humanity Edmonton;

Robert Lanoue, St. Clair College;

Teresa Domingues, York Communications;

Pat McLean, Sherry Dubue, Janice Tessman, Richard Davison, Ella Schmidt, and Doug Freure, Habitat for Humanity Waterloo Region;

Bryan Bruce and Keith Reycraft, Orchard Design;

Doug Craig, the Mayor of the City of Cambridge;

Laurie, Sean, Keven, Dustin, Kayla, and Tyler Baker;

Amanda Scott, Meritech Engineering;

Arjan Arenja, Royal Group Technologies;

John Debrone, UWSA Shop Manager;

UWSA Graduate students: Keith Button, Mark Cichy, Heather Fitzpatrick, Mike Garforth, and Natalie Soranno;

UWSA undergraduate students: Elaine Catane, Eugenia Chevtchenko, Miklos Conti, Jordan Darnell, Marianna Decola, Alex Fernandes, Vera Guo, Caroline Howes, Timea Jakab, Alan Kobayashi, Carmen Lau, John Lee, Jessica Lief, Michael Lin, Veronica Lorenzo-Luaces, Carlos Medina, Sarah Nejad, Angie Ng, Ping Pai, Sylvia Pawlowski, Matthew Peddie, Kasia Piernicka, Jelena Porovic, Prithula Prosun, Lisa Rendely, Ben Schumacher, Maneu Tataryn, Emily Tong, Cindy Tse, Gillian Tyrrell, John Williamson;

Doug; Andrew; Wendy; and Hogie, Gentek Building Products Limited

David Durnford, City of Cambridge Building Department;

Linda and the drivers at Active Towing;

Fernando, Tampa Hall Limited;

Glenn, Steve, Don, Jude, and the other countless volunteers who built with me.

## **Dedication**

To David A. Fair  
my unsung hero.

## **Disclaimer**

This work contains descriptions of real persons and actual events. While factual, these descriptions are influenced by the point of view of the author. Portrayals should not be considered the only interpretation possible.

## Table of Contents

Author's Declaration	ii
Abstract	iii
Acknowledgements	iv
Dedication	v
Disclaimer	vi
Table of Contents	vii
<b>Introduction</b>	<b>1</b>
<b>Ideas</b>	<b>3</b>
Conception	4
Case Studies	10
Design Guidelines	30
<b>Reality</b>	<b>41</b>
Land	42
Prototype	54
The Family	66
House Design	82
In The Shop	92
On The Site	166
Wall Panel Erection	184
Weathertight	196
<b>Reflections</b>	<b>221</b>
On Dedication	222
On Prefabrication	228
<b>Conclusion</b>	<b>234</b>
Notes	236
Illustration Credits	238
Bibliography	242





## Introduction

This thesis chronicles my experiences with developing a panelized wall system for use by Habitat for Humanity and with testing that system in the design and construction of a house.

Initially the motivation for this project developed from an on-site construction experience I undertook with a Habitat for Humanity affiliate that exposed the incomplete knowledge of construction practices I had acquired from my undergraduate education in architecture. The disconnection I found between my knowledge and reality resulted in a desire to produce a thesis which did not conclude with the development of theories and designs, but which proceeded to test those theories and designs through construction.

The first section of this thesis — titled Ideas — begins with a description of that initial construction experience. It proceeds to recount further on-site construction experiences I undertook with several Habitat for Humanity affiliates to evaluate their conventional construction practices and their use of prefabrication. These experiences combined with research into prefabricated products and systems contribute to a discussion of the applicability of prefabrication to Habitat for Humanity's use of unskilled volunteer labour. The result is a set of guidelines for the design of a preclad wood framed wall panel system which is to be prefabricated in-house by Habitat for Humanity affiliates using conventional construction materials and methods.

The second section — titled Reality — begins with an agreement between the University of Waterloo School of Architecture and the Habitat for Humanity Waterloo Region affiliate to work together on the panelization and construction of a single family detached house in Cambridge, Ontario. The section ends with the completion of that house to a weathertight state. In between, the progress of the project — from the design of the wall panels, through the construction and refinement of a prototype, the incorporation of panelization into the design of the house, the prefabrication of exterior and interior wall panels by students in the workshop at the School of Architecture, the erection of these wall panels on-site, the construction of the roof, and the completion of the cladding — is described through my experiences.

The third, and final, section — titled Reflections — discusses the effect of reality on my initial ideas, including the effects of both the people involved and the panelization of the walls on the outcome of the project. It concludes with a discussion of the necessity for further development and testing of the panelized wall system.

All three sections of this thesis are presented as a series of narratives, which serve to detail the development of the panelized wall system, expose the multitude of factors that influenced the outcome of the project, and impart the understanding that I gained from my experiences.



## **Ideas**

Conception	4
Case Studies	10
Design Guidelines	30

## Conception

August 2003: I stand before the front desk of the Building Division at Kitchener City Hall. Patches of dirt, grass, and sweat cover my tee shirt, shorts, and bare skin. My nose and cheeks are red from the sun and my hard hat has left an indent in the centre of my forehead. As I shift my weight I grind the sand from my steel-toed boots deeper into the carpet. To my left stands a similarly dressed, but somewhat less dirty, middle-aged man. Dave is the Building Project Coordinator for the **Habitat for Humanity** Waterloo Region Affiliate. In his hand is a building permit application. We both have on our best, “Hi I’m wondering if you can do us a favour,” smiles.

This is the fourth summer that Professor Terri Meyer Boake has arranged an elective course where students work for two weeks in August on the construction of a Habitat for Humanity house. On Monday forty-five of us arrived at the site on Inge Court in Kitchener to a dry, sun soaked field of weeds. We expected to build a pair of semi-detached houses, but instead we cut weeds and picked up garbage. On Tuesday the aforementioned Project Coordinator, Dave, announced that the work at the site could not proceed until the surveyor’s draftsman returned from vacation and drafted the survey for the building permit. He then assigned the day’s work of cleaning the warehouse. Shortly afterwards, I informed Dave that any of the forty-five students in the room have the ability to draft a survey. Shortly after that I was driving to the surveyor’s office.

On Wednesday, with the prospect of a permit in the near future, the excavation of the site began without one. Dave and a couple of other men took turns relocating dirt with an excavator and a skid steer. My initiative had earned me the position of Dave’s assistant and I found myself supervising the other students. The task was to preassemble the **insulating concrete forms (ICFs)** in large sections on the vacant lots behind the site. The idea was to have them ready for quick assembly on the footings and to keep us occupied. Some students sought out patches of shade and complained that the task was “busy work.” Others, like myself, tried in whatever way we could to do what we were there for.

It is now Friday afternoon. We spent the morning grading and laying sod at another site in Cambridge. I used any spare moments to fill out the permit application. Our site is now one big hole and we need a building permit, today. We are shown to the plans examiner; he is a student from Conestoga College. Dave chats him up. I smile at him and try my best to look more attractive than dirty. After a cursory review of the plans he says that he does not see any obvious problems, but he needs to have a closer look before issuing a permit and that will not happen today. Dave knows the Director of Building and asks to see him.

The Director shakes my hand despite its filth. Dave expresses to him the importance of the cause and the plight of the students.

## Habitat for Humanity

From the web site of Habitat for Humanity Canada:

“Habitat for Humanity is an independent, non-profit, ecumenical housing program dedicated to the elimination of poverty housing by building homes in partnership with families in need. The ministry of Habitat is to provide simple, decent, affordable housing to those who would not qualify or be able to afford a conventional mortgage. The Habitat program is about home ownership, a long-term solution designed to break the poverty cycle.”

“Habitat for Humanity International was founded in 1976 in Americus, Georgia by Linda and Millard Fuller. The program developed from the concept of “partnership housing”, based on Christian principles, where those in need of adequate shelter work side by side with volunteers from all walks of life...”

“Through volunteer labour, efficient management and tax-deductible donations of money and materials, Habitat builds and rehabilitates simple, decent houses with the help of the homeowner (partner) families. Habitat houses are sold to partner families at no profit and financed with affordable, no-interest mortgages. The homeowners’ monthly mortgage payments go into a revolving fund, which is used to build more houses.

Habitat for Humanity is not a give-away program. In addition to mortgage payments, each homeowner invests hundreds of hours of their own labour, called “sweat equity”, into the building of their house and the houses of others.”

“Habitat for Humanity has built more than 200,000 homes in 100 countries around the world. A new home is dedicated worldwide every 24 minutes.

Habitat for Humanity Canada has dedicated more than 940 homes from coast to coast since its inception. There are currently 67 affiliates in all 10 provinces and two territories...”<sup>1</sup>

## Insulating Concrete Forms (ICFs)

From the web site of the Insulating Concrete Forms Association (ICFA):

ICF are basically forms for poured concrete walls, that stay in place as a permanent part of the wall assembly. The forms, made of foam insulation, are either pre-formed interlocking blocks or separate panels connected with plastic ties. The left-in-place forms not only provide a continuous insulation and sound barrier, but also a backing for drywall on the inside, and stucco, lap siding, or brick on the outside.<sup>2</sup>



1.1 Insulated concrete forms

I easily manage to look disappointed. The Director's annoyance is palpable as he lectures Dave. This is apparently not the first time. We leave shamed, but triumphant.

On Saturday morning the work begins in earnest. The formwork for the footings has to be constructed, levelled, and inspected before the concrete truck arrives at noon. As the arrival of the truck becomes more imminent even the Building Inspector grabs a shovel.

I begin to realize just how much I don't know. As the footings are poured the wet concrete forms itself to the uneven surface of the excavation and seeps out from beneath the bottom edges of the formwork. It looks nothing like the clean, straight-edged footing that I have been drawing in my wall sections. Then there is the key in the footing; the perfect inverted trapezoid of my drawings is in actuality made by dragging a two-by-four through the approximate centre of the hardening concrete. I balk at the disparity between what I thought I knew and reality.

Despite my growing acknowledgement of my own ignorance I maintain my position as Dave's assistant. What I cannot reason out I fake. When that fails I ask Dave carefully worded questions in an attempt to maintain the deception of my competence.

Over the next week the work progresses. I organize the transfer of the preassembled ICFs into the hole and onto the footings. We brace the forms, place the concrete, and allow it to set overnight before removing the bracing. The realizations keep coming. I *know* the function of weeping tile. I did not know that it is the coil of black tubing I have been sitting on during breaks, and it is not until we lay this same tubing around the perimeter of the foundation and connect it to the sump pit, that I *understand* its function.

It is the end of our two weeks on-site. We have two damp proofed foundations supporting two-by-four knee walls, two six-hundred-pound steel beams, and an incomplete installation of floor joists. I have more questions than answers. What will happen next? How will it differ from what I know? The house is incomplete and so is my knowledge. Can I design intelligently without it?

At this same time I am trying to determine what to do my Master's thesis on. I am not yet accepted into the program, but I am looking for funding. My interests have always been in housing so my best bet looks like a grant from the Canada Mortgage and Housing Corporation's (CMHC's) External Research Program. The deadline is two months away. I pour through CMHC reports, guides, and news releases for something that they want to know and which will hold my interest for two years.

My two week experience of building with Habitat for Humanity has made a purely theoretical thesis unpalatable. How will I know



**1.2** Carrying preassembled insulating concrete forms into the excavation.

**1.3** Set-up and bracing of the insulating concrete forms.

that my theories are sound? How will I know that it really works? I have to test it. I have to not only design, I have to build.

From an e-mail to Terry Petkau, Vice President of Building and Housing Programs for Habitat for Humanity Canada, September 12, 2003:

As you know I have been investigating grants with the CMHC in order to secure funding for my graduate work. Discussions with Dave Fair during my recent experience with Habitat for Humanity in Waterloo broadened this investigation to include the possibility of involving Habitat for Humanity in this work. My initial thoughts on this subject involved a thesis where research would be undertaken to solve a problem or test a theory. The results of this research would then be tested through its application in a Habitat for Humanity house. Ideas concerning the development of new housing prototypes, sustainability, and the testing of new building technologies came quickly to my mind. Of course I realize that the nature of the research and the theory to be tested would need to be determined by mutual interest.

Eleven days later Terry and I meet to discuss topics of mutual interest. He is a friendly man with a measured, but infectious, enthusiasm. We determine that controlled environment and modular manufacturing, adaptable housing, and zero-waste construction all have potential. Which will CMHC pay me to know more about?

I search for holes in their research on these subjects. I read more reports, more guides, and more news releases. The best hole I can find is with controlled environment and modular manufacturing (prefabrication) for **self-build** housing. CMHC is promoting both self-build and prefabrication as affordable housing solutions, but not in combination. Habitat for Humanity, a community self-build organization, has a few Canadian affiliates that are experimenting with prebuilding or the use of prefabricated products and many more that are interested.

The title of my hastily written grant proposal becomes: Applying Commercial Prefabrication Techniques to Self-Build Housing. The idea is that this research, along with an examination of Habitat for Humanity's practices, will influence my design for a Habitat for Humanity house. This design will then be tested through its construction.

With Professor Terri Meyer Boake as my Team Leader I submit the grant proposal and I wait. I think about the house I will build. I think about my ideas becoming reality, about the knowledge I will gain, about how it will make me a better designer. I think about making architecture, about the skills I will learn, about the sweat I will shed, about the tan I will get.

Six months later the grant recipients are announced. I am not one of them. It no longer matters. I think about the house I will build.



## **Self-Build**

From the CMHC Research Report, Comprehensive Analysis of Self-Build Housing Experiences:

“...any range of housing activities in which there is an element of participation by future occupants, specifically including the physical act of building, site acquisition and financing, architectural design and contracting (Crosbie, 1993).”

“A critical element in self-build is the procurement of affordable housing, that is, the provision of housing at reduced cost through the reduction or elimination of paid labour. Participation in the self-build process is also expected to generate a variety of ancillary benefits, including development of skills expertise and improved self-esteem, stronger social networks and community cohesion, and an increased sense of belonging and interdependence.”<sup>3</sup>

## Case Studies

Summer 2004: It is Habitat for Humanity *build* season and I look for construction sites to work on. I need to know how different affiliates are using prefabrication; I need to find where this prefabrication is successful and where it is not; I need to compare prefabricated construction to conventional construction; and along the way I need to gain enough experience on-site to build a house.

My first stop is the Toronto affiliate. The project is **Breakthrough Build Phase II**, “Canada’s Biggest Build.” The goal is to frame forty townhouses in three weeks. To accomplish this they are combining in-house prefabrication — volunteers worked throughout the winter to preframe sections of floor and interior wall panels in large numbers — with the use of a prefabricated product — commercially built structural insulated panels (SIPs) for the exterior walls.

My first day on site is June 26th. It is also the first day for several hundred other people. Many, like myself, are given a white tee shirt that signifies the lowest rank of volunteer, crew member. Crew leaders are wearing orange shirts, block leaders are wearing yellow, paid staff are wearing blue, and the largely female group of volunteer coordinators are wearing pink.

While I wait for things to get started I take a walk around the site. There are seven blocks of townhouses in various stages of construction. One block has a complete floor deck, two have the beginnings of a floor deck, one has complete foundation walls, one has only footings, and the sites of the remaining two are not even excavated. Across from the townhouses sit a pair of site offices, two open cargo containers where tools and hardware are stored, and a row of tractor trailers. Inside the trailers are the preframed walls and other materials. Beside the trailers are stacks of floor sections (1.4), SIPs, laminated veneer lumber (LVL), dimensional lumber, and oriented strand board (OSB) floor sheathing.

I am assigned to a crew leader. He puts me to work with two men completing the first floor deck of a townhouse unit. A prefabricated floor section has already been installed at each end of the unit. The floor sections are constructed of engineered wood I-joists, OSB rim boards, and OSB sheathing. They span the width of the unit and are eight feet deep to coordinate with the length of the sheathing. The space between the two floor sections has been partially framed with site installed engineered wood I-joists and LVL beams to support the stair opening (1.5). We are to install the remaining I-joists and complete the OSB sheathing.

We measure and cut the I-joists to length before nailing them to the sill plates. Two sill plates have been installed to eliminate interference between the anchor bolts and the prefabricated floor sections (1.6). Installing the I-joists goes well, installing the OSB sheathing does not. If we align the new sheathing with the

## Breakthrough Build Phase II

Affiliate: Habitat for Humanity Toronto

Location: Neilson Road and Tapscott Road, Scarborough

Architect: Arsenault Architect Inc.

Unit Type: Townhouses

Number of Units: 40 in 7 blocks of 5 or 6 units

Site Area: 4,101 s.m., 92, 914 s.f.

Development Gross Floor Area: 3,273 s.m., 35,231 s.f.

Unit Gross Floor Areas: From 81 s.m., 871 s.f, (two bedroom unit) to 121 s.m., 1307 s.f. (four bedroom unit)<sup>4</sup>

Floor Framing: A combination of prefabrication by volunteers and on-site using engineered wood I-joists

Exterior Wall Framing: Structural Insulated Panels by Thermapan

Interior Wall Framing: A combination of prefabrication by volunteers and on-site using dimensional lumber

Roof Framing: On site using engineered roof trusses



Above Left: **1.4** Stacks of premade floor sections.

Above Right: **1.5** LVL beams and engineered wood I-joists are installed between floor sections.

Left: **1.6** A double sill plate is installed to eliminate interference between the anchor bolts and the floor sections.

sheathing on the floor sections it runs at a considerable angle to the side walls and crosses the gap required between units at the party wall. The floor sections are either out of square or placed crooked on the foundation. We look to our crew leader for his advice. He is nowhere to be found. It soon does not matter; our chalk line and circular saw are borrowed by other volunteers and are not likely to be returned.

While we wait for direction I watch the work on the neighbouring block. A blue shirt is using a truck with a boom on it to carry floor sections across the site to the foundation. Unfortunately, the excavation around the foundation and several piles of dirt are causing access problems for the truck. The boom cannot reach many parts of the foundation and the floor sections have to be set wherever it can reach (1.7). Volunteers perched precariously on the top of the foundation wall are slowly moving floor sections by hand from the back of units to the front (1.8). Others are sliding the floor sections over from neighbouring units.

Although there is still no sign of our crew leader we are able to borrow some tools. We do our best to finish the floor sheathing, but it is far from perfect. Without work and with no direction forthcoming I leave my small group and walk two blocks over, to where SIP panels are being installed for the exterior walls.

Labels on the SIP panels indicate that Thermapan is the manufacturer. The panels consist of an expanded polyurethane (EPS) core laminated between two sheets of OSB sheathing. They are four feet wide, eight feet tall, and 4.5 inches thick. Volunteers are carrying panels across the site and up the ramp onto the floor deck; two volunteers carry one panel. A continuous two-by-four plate has been nailed around the perimeter of the floor deck. Two crews are working to install panels along this perimeter. The two-by-four plate fits into a groove across the bottom of the panels. There are similar grooves on the other three sides of the panels. A double two-by-four spline is inserted into the vertical grooves to join one panel to the next (1.9). Two-by-four plates will later be installed across the top groove and will connect the panels to intersecting walls. Several panels have to be cut and a hot knife is used to recreate a groove by removing the EPS in the cut edge (1.10).

I am quickly absorbed into one of the crews and I am put to work spraying the panel grooves with expanding adhesive foam before the splines are inserted (1.11). The panels act as air barriers; the expanding adhesive maintains this air seal at the joints. I also work to drive nails through the OSB of installed panels into the splines and plates. On the outside of the panels several volunteers work on this same task from long ladders (1.12).

My second day on site they find out that I can read plans. I am assigned to direct a group of three young men. We are to correct an error; the mechanical chases have not been framed out in all



Above Left: **1.7** A floor section is placed where the boom can reach.

Above: **1.8** Volunteers moving a floor section from one end of a unit to the other.

Far Left: **1.9** Inserting a spline in the edge of the SIP wall before installing the next panel.

Left: **1.10** Using a hot knife to create a groove in the edge of a cut panel.



Far Left: **1.11** Spraying the groove in a SIP with expanding adhesive foam.

Left: **1.12** Working from a ladder to drive nails through the OSB of the panel into the spline.

of the first floor decks. If we are lucky the sheathing is not glued down yet. More often our first step is to cut out the sheathing and pry it off the joists. Then one of us has to cut off the joists that cross the opening from the underside while standing on a ladder in the gravel-surfaced basement. New joists are cut to frame out the opening but before they can be installed we have to hammer joist hangers between the existing joists and the glued-down sheathing. The work is awkward and time consuming. We move from unit to unit repeating the task (**1.13, 1.14**).

I spend sixteen days over the next two months building on this site. Each block is at a different stage. I work one day erecting SIPs, the next day setting floor sections, and the day after that installing interior wall panels. These wall panels have been conventionally framed with two-by-four studs at sixteen inches on centre. Not all of the walls have been premade. Many are to be framed on-site. Panels for the party walls have been prefabricated at eight foot and twelve foot lengths. When we install three of these panels down each side of a unit a space remains. We frame the remaining section of wall to fit the space. This allows for inaccuracies in both the existing construction and the length of the panels. Similarly, we install prefabricated side walls for the front hall closet and then frame the header for the closet opening to fit. There are prefabricated panels for the single wall that divides the kitchen from the living room (**1.15**), but we site frame the walls for the kitchen broom closet.

To satisfy fire separation requirements gypsum board is required between the party walls that separate units (**1.16**). A continuous layer of gypsum board is also needed on the party walls towards the interior of each unit. Interior partitions which meet the party wall are either installed after this layer of gypsum board or a gap is left between the two for the gypsum board to be inserted later. Inserting the gypsum board later is more difficult and leaving partitions unattached to the party wall makes their correct installation problematic. Installing the gypsum board before the partitions takes the chance that it will be exposed to rain. Although tarps are used in places, much of the gypsum board gets wet. Either approach is used, neither works well.

I feel that the work is progressing slowly. There are many problems. A number of the prefabricated floor sections do not fit on the foundations. I am told that the professional contractors have poured the foundations of the end units too wide. To increase the width of the floor deck to that of the foundation walls an additional section of framing has to be built next to the floor sections, insulated, and covered with another rim board (**1.17**). Then to support the floor sections for the second floor, additional stud walls have to be framed along the interior of the first floor SIP walls. Other floor sections are found to be out of square or too



Far Left: **1.13** A mechanical chase cut out of the floor sheathing.  
Left: **1.14** A mechanical chase that was corrected before the installation of the floor sheathing.



Above Left: **1.15** An erected kitchen wall panel.  
Above: **1.16** An erected party wall panel complete with gypsum board for fire separation.  
Left: **1.17** Additional framing is needed to make up the difference between the width of the foundation and the width of the floor panels.



long. I work at partially disassembling some of these and repairing them. However, I shy away from problems with the SIPs. The exterior wall has to be broken at every party wall. The four foot width of the panels does not coordinate well with the width of the townhouse units and spaces in the wall are created that are too small to fill with a piece of SIP (1.18). Less of a problem than a hassle are the door openings in the panels. After the opening is cut out with a chainsaw grooves need to be created around the opening for the insertion of a two-by-four frame. Using the hot knife to cut grooves is time consuming; using it to create grooves in erected panels is even more time consuming and difficult, especially at the corners.

I find that I have a penchant for locating errors, although it may be that they are not hard to come by. I soon learn that older male crew leaders do not appreciate it when a young woman points out an error. I appeal often to the site superintendent, a blue shirt named Brian. We figure out solutions together. When I discover that a number of the basement windows have been poured into the wrong part of the foundation, Brian and I discuss what design changes are needed to the affected units.

Brian gives me an orange tee shirt and promotes me to crew leader. He then assigns me and my crew to completing first floor interior partitions. The units we work on are all partially framed. The party walls have been completed and a random selection of interior partitions have been erected. Although the units are designed to be largely identical, what we find in each varies greatly. The rough openings for closet doors are different in each unit. Preframed closet walls have been installed upside-down so that the blocking for the closet rod is near the floor (1.19) or backwards so that the blocking is toward the outside of the closet rather than the inside. Preframed kitchen walls are in the wrong place. Chases and washrooms are not the right size. Nothing is consistent. My tools are sledge hammers, crowbars, the claw of my hammer, and when I get desperate, a reciprocating saw. I am unsure whether it is the instruction of the crew members, the directions given to the crew leaders, or the supervision of both that is the problem, but we are involved in far more demolition and repair than in straight construction.

An error in one stage of the construction reverberates through others. The interior partitions are found to be a different height than the SIP walls. The height difference is inconsistent and it is unclear whether this is the result of inaccuracies in the height of the wall panels or another component of the construction. We have to shim up the top plate of many walls (1.20); others have to be planed down.

Weeks after I worked to frame the missing mechanical chases into the first floor deck I venture over to a block of townhouses with newly installed second floor decks. I climb up to take a look and find that the mistake has been repeated; the chases have been





Above Left: **1.18** Additional framing inserted to fill the gap between a SIP and the gypsum board break at a party wall.

Above Right: **1.19** A closet wall that was installed upside-down and to which a second set of blocking has been added.

Left: **1.20** Installing shims along the top of the party walls.

missed here as well. Although the project is far from complete, I leave the site.

My next stop is at the Northumberland affiliate for their **Warkworth Build**. The project is a single bungalow on a sizable lot on the edge of town. It is a conventional on-site build. I arrive at the site for the first day of the framing *blitz*. The foundation has been poured by professional contractors, the site is backfilled, and the floor deck is partially framed with engineered wood I-joists.

There are about twenty people on-site. A group of older men are discussing how to frame the stair opening with LVL beams. Others are installing I-joists and blocking. I get work holding wood for the man running the saw. As soon as I can I trade tasks with someone who is tired of installing blocking. That keeps me busy all morning.

In the afternoon I attempt to infiltrate the group installing the I-joists. They are friendly, but they seem wary of my abilities and I am watched closely. Late in the afternoon I find my calling when I am recruited to help install the floor sheathing. Everyone is happy that I am willing to apply the glue. No one else wants to lean out over the joists.

My job applying glue is waiting for me the next day. I work just ahead of the two groups that are installing the sheathing and I jump between them. We complete the floor deck by mid morning. Work then begins on framing the exterior walls with two-by-six lumber and OSB sheathing. After some discussion on who knows what to do, two men take charge of measuring and marking the wall plates. They grumble about the lack of dimensions on the drawings. Most of us just hammer. Another man walks around, inspects our work for twisted studs and orders corrections. We have two exterior walls erected by the end of the day (1.21).

First thing in the morning we are given a lecture on repetitive strain injury. We continue framing and within an hour my right forearm cramps up from hammering. We erect two more walls by mid morning. We then switch to framing interior partitions. I continue to hammer. The grumbling over the drawings increases and changes are made to the plans. A closet in one bedroom is changed into a walk-in closet without incident. However, when the layout of the bathroom fixtures is changed the corresponding change is not made to the framing. The wrong wall is framed with two-by-sixes, which leaves the fixtures against a two-by-four wall that is insufficient for the required plumbing. It is also discovered that the front door was overlooked and it has to be framed into the erected exterior wall. The men in charge are clearly not professional builders. They need drawings that give a better indication of what needs to be built and perhaps even how things should be built.

The next day I continue to hammer. I nail walls and capping

## Warkworth Build

Affiliate: Habitat for Humanity Northumberland

Location: Harlbut Road, Warkworth

Designer: Jeremy Nicholls B.Arch

Unit Type: Single detached bungalow with three bedrooms

Number of Units: 1

Unit Gross Floor Areas: 1056 s.f., 98.1 s.m.<sup>5</sup>

Floor Framing: On-site using engineered wood I-joists

Exterior Wall Framing: On-site using two-by-six dimensional lumber

Interior Wall Framing: On-site using two-by-four dimensional lumber

Roof Framing: On-site using engineered roof trusses

Below Left: **1.21** Two exterior walls erected at the end of day two.

Below: **1.22** Installing cripples in an erected interior partition.



plates in place. The work progresses quickly, but it is perhaps rushed. Cripples for some door headers are forgotten and with greater difficulty are framed into the erected interior partitions (1.22, page 19). Polyethylene vapour barrier is repeatedly forgotten between the interior partitions and the exterior walls. The interior partitions have to be detached and reinstalled with the polyethylene. All of the mistakes are soon overcome. We finish erecting and capping all of the walls by the end of the day (1.23).

In four days the goal has been achieved and the house is ready for roof trusses. Unfortunately, the delivery of the trusses is delayed and the site shuts down. I leave them waiting patiently.

I move on to the London affiliate. They have purchased an odd shaped group of lots in an existing neighbourhood complete with plans and permits for three two-storey semi-detached houses. I arrive during **Smith Street Build Phase 1**, which involves the construction of the first house. The foundation has been constructed from the same ICF system that I worked with in Waterloo. It is a meticulous looking job. It was completed by the Construction Supervisor and a dozen experienced volunteers. They have also completed the first floor deck. All of the wall framing has been panelized and donated by Akupanel Building Systems Inc. There are several stacks of their two-by-four open wood framed wall panels near by. Two pairs of panels have been erected on the rear outside corner of each unit (1.24). They already hold electrical panels.

On the ground a short distance away sits the roof. The entire gable pitched roof has been preassembled in four sections by tying engineered roof trusses together with bracing, fascia boards, and OSB sheathing (1.25). The plan is to complete the framing for the two houses in two days. The last step involves lifting the roof sections onto the top of the second floor walls with a crane.

There are about sixty volunteers on site, far too many to be framing. Many are unskilled and seem happy to help in whatever way they can. Some are assigned to grading, some to assembling scaffolding, and many to building a fence around the perimeter of the entire site. The rest of us begin to erect the wall panels.

The locations for the wall panels have been marked on the floor deck. The work goes quickly. We finish erecting the first floor exterior walls by mid morning. At first we nail rigid insulation to the panels before we erect them (1.26). That step is soon dropped. There is plenty of labour available to do the job later. The panels fit together well. There is only trouble with the party wall; when the panels are erected the wall is half an inch too long. We finish erecting and capping all of the first floor walls shortly after lunch.

The framing of the second floor deck starts with installing a framework of joists and rim boards that a group of volunteers has assembled on the ground. The assembly is large and awkward. It



**1.23** All walls are erected and capped by the end of day four.

### Smith Street Build Phase 1

Affiliate: Habitat for Humanity London

Location: Smith Street, London

Designer: Devos Design & Drafting

Unit Type: Two storey Semi-detached with three bedrooms

Number of Units: 2

Unit Gross Floor Areas: 1300 s.f., 121 s.m.<sup>6</sup>

Floor Framing: On-site using dimensional lumber

Exterior Wall Framing: Prefabricated open wood frame panels by Akupanel Building Systems Inc.

Interior Wall Framing: Prefabricated open wood frame panels by Akupanel Building Systems Inc.

Roof Framing: Prefabricated on-site by volunteers into four sections using engineered roof trusses



Above Left: **1.24** A pair of panels erected at the rear outside corner, complete with an electrical panel.

Above: **1.25** The preassembled gable pitched roof.



Left: **1.26** Erecting an exterior wall panel after installing rigid insulation.

is lifted on top of the first floor walls (1.27) and set in place. From there the work proceeds in two waves. The first wave of workers installs the joists. After a significant period of standing around and waiting for enough joists to go in, the second, less skilled wave of workers installs the OSB floor sheathing and cross bridging. I work between the two waves and apply the glue for the sheathing. From this position I am able to observe the progress of both groups. Most of the second floor joists and half of the sheathing are installed by the end of the day (1.28). The sheathing is immediately covered by the arrival of the next set of wall panels. They are lifted in stacks onto the floor deck with a crane on the delivery truck.

It is late morning on day two. All of the joists are in, most of the floor sheathing is down, the installation of the exterior doors is underway, and the wall panels are just starting to go up. The crane is to lift the roof into place at three this afternoon. The erection of the wall panels proceeds slower than it did on the floor below. More time is needed for organization as the locations of the panels are not marked out on the floor deck. There are at least a dozen eager pairs of unoccupied hands, including mine. Those in charge are doing the work themselves instead of directing others.

We are still erecting walls when the crane arrives at twenty to three. Some of the walls have to be persuaded into place with a sledge hammer. The party wall is once again half an inch too long and has to be trimmed. Meanwhile, the crane moves into position and its cables are secured to the first roof section. By three-thirty all of the panels are erected and capped. We are evacuated from the house. The neighbours quickly set up lawn chairs from which to witness the spectacle.

The crane begins to lift (1.29). Two men on the ground hold guide ropes and attempt to control the swinging of the large and awkward assembly. Up on the second floor there are two other men on step ladders. With the section over their heads they grab onto it to control its exact placement. Everyone else stands back and watches. I take pictures.

The first section touches down (1.30). In a few minutes it is secured, the cables are released, and the crane swings back for the next section. As the crowd of onlookers grows the procedure is repeated three times (1.31). It takes one hour to install the entire roof. At the end of two days the framing is complete.

I work on-site for the next four weeks. I want to discover what effects the prefabrication has on the construction that follows. I surreptitiously apprentice myself to a grumpy professional carpenter named Ted. He has a short term paid position to help move things along. He is effectively the second in command under the Construction Supervisor. I do whatever Ted says. He often



Above Left: **1.27** Lifting a framework of joists and rim boards on top of the first floor walls.

Above: **1.28** The end of day one.



Left: **1.29** The crane lifts the first of four roof sections.

Below Left: **1.30** The first roof section touches down on the second floor walls.

Below: **1.31** Installing the last roof section.



does not say much, so I watch what he does and then I copy him.

On our first day together I assist him with installing and sheathing the small wall panels that have been provided for above and below the bay windows. The panels do not fit together well and Ted trims the panels for each window with a circular saw (1.32). On the second day volunteers from the window manufacturer install the bay windows. They have difficulty and use a large number of wood shims. After they leave Ted and I uninstall the windows, replace many of the shims with two-by-fours, and reinstall the windows. They are more secure, but they still do not fit well in the openings; the angle of the bay window is different from the angle of the prefabricated framing.

Ted shows me how to install vinyl siding and soffit. We spend many days high up on scaffolding. While we work away on the back façade he expresses his dissatisfaction with the fascia boards. The roof sections were installed so their respective fascia boards line up across the front façade of the houses; however, they do not line up across the back façade. Ted's revision to the preassembly of the roof sections is to not nail the sheathing to the fascia board so that the fascia board can be adjusted after the roof sections are installed. Once I have the hang of installing the vinyl Ted leaves me to guide the other volunteers in cladding the rear and side façades.

A day and a half later Ted returns with the Construction Supervisor. It is time to install the aluminum fascia and eavestrough. I am unsure whether I am one of the few that are trusted to handle this delicate material or simply one of the few who are willing to climb so high on the scaffolding.

The aluminum completes the rear and side façades. Ted and I move on to the front façade. We work high up on the scaffolding for days on its vinyl siding and soffit. More work is required than the other three façades combined. The articulation of the façade creates odd shapes and awkward spaces that are time consuming to finish (1.33, 1.34). The result is attractive, but it is not easy for the unskilled to construct (1.35). The houses were not originally designed to be built by Habitat for Humanity and it shows in the complexity of the front façade. I feel that the time saved through prefabrication is lost here.

I follow Ted from sheathing and siding inside to cabinetry and trim. Ted cuts and I nail the trim. We run into trouble at the bay windows again. We have to shim the trim around the windows because of the differences in angle between the windows and the walls. Whether we are working out a problem or not, everything is cut to fit. It was the same with the exterior cladding and I'm sure it must have been the same with the drywall. I begin to realize how rarely architectural drawings are used after the framing is complete. I receive all my instructions verbally. I know from my other experiences that if there are not enough knowledgeable people on site to give instructions then things can easily go wrong. Luckily





Top Left: **1.32** Ted trims a prefabricated wall panel for the bay window.

Top Right: **1.33** Articulation of the front façade.

Above Left: **1.34** A small and awkward section of soffit.

Above: **1.35** The completed front façade.

here I had Ted.

Build season is over, but there are two more Canadian affiliates that are using prefabrication: Edmonton and Windsor-Essex. I contact the Edmonton affiliate and enter into an e-mail conversation with prominent volunteer Ralph Totman. He tells me that the affiliate owns a building which contains offices, a ReStore (a store for the sale of new and used building materials), and a prefabrication shop where they construct wood framed wall panels for their houses. Ralph is responsible for preparing the drawings for the houses and diagrams of the wall panels to be built. He also designed and, with assistance, built their prefabrication shop (1.36). Ralph and I discuss their methods and their difficulties.

From an e-mail from Ralph Totman, October 13, 2004:

The sketch of the prefab shop shows the size and the layout and it has worked quite well. Even with such a large shop we have had storage problems. We stack half of the 2x6 walls for a house on four wheeled dollies and move the stack to a remote corner until ready to ship to site. So one house requires two stacks of walls, both external and internal. When ready to ship, we push the stack to our 12x12 roll-up door and a cherry picker outside picks it up and places it on a low-loader. The vehicle we have been using is a self loader that can pick and carry two stacks of walls per trip, ie one complete house. At the site it places the two stacks of walls on the prepared main floor deck directly. We try to arrange the order in the stacks so that the top frame is the first to be erected and so on. Fortunately we have a very large, fenced parking lot outside which serves the ReStore as well as our shop and offices so we can also store some finished walls outside under tarps. It is not as good as inside because frames warp if left too long before erection and we can't wheel the dollies over the parking lot so it means extra picking and placing.

Originally we clad our wall frames with 3/8" OSB projecting over one end by a stud spacing (usually 16") and starting in at the other end of the frame by a similar amount. This was to tie the sections together more positively when erected. However, shipping the frames with 16" of OSB projecting out one side led to breakage of the OSB and handling problems. Also, if the overlap was a fraction too much it meant cutting off in the field before the section could be joined to the adjacent walls. We now just clad the frames edge to edge with no overlap or underlap. We also used to ship with the top plate attached and also projecting over one end by 16" or whatever was appropriate. (5 1/2" at corners) but this also led to handling problems so we now install top plates in the field. One extra job but probably works out the same if corrections have to be made.

When I contact the Windsor-Essex affiliate I am directed to Professor Robert Lanoue at St. Clair College. Robert explains to me that he runs a course for first year students entitled Life and Employability Skills where part of the course work involves constructing wood framed wall panels for the Windsor-Essex affiliate.

**Habitat Centre - Construction Group**

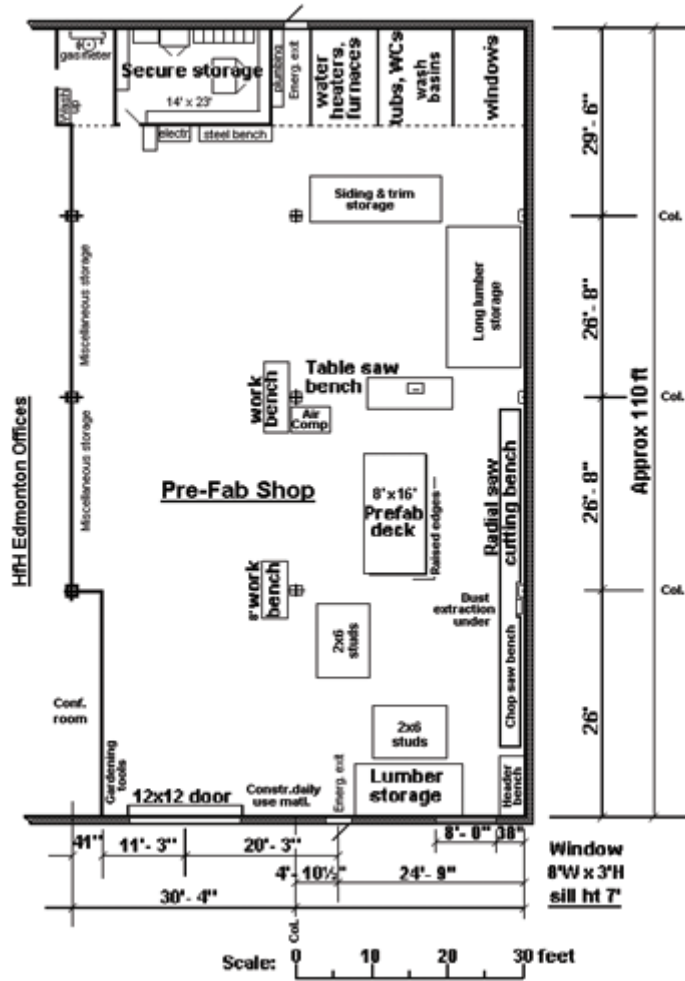

1.36 Layout of the Edmonton affiliate's prefabrication shop.

From an e-mail from Professor Robert Lanoue, November 9, 2004:

We use 2 adjoining labs that are located conveniently to an outside court yard where we store the walls for transportation. One lab is the carpentry lab at approx. 5800 sf and the other is a general purpose lab at approx. 1600 sf and used for the other components of my course such as electrical, plumbing, drywall, siding, roofing and ceramic flooring.

All pre built components are built during March and April and if we have to during May. Every week we take the pre built components and move them to a storage facility until the actual build.

The communications for the students is from the architectural drawings that I work on and then produce framing drawings for all components.

The benefits for Habitat are:

- they get accurate wall components that are built in a controlled environment which produces a higher quality product instead of building the walls on site when you have 30, 40 or maybe 50 people trying to read drawings and sometimes not really knowing what they're doing
- the speed of the 1st day build by having all walls up and usually part of the roof framing system in place makes the volunteer feel real good and gives the project a positive outlook for the remaining build period

The draw backs for Habitat are:

- that if they want any changes most of the time the walls are already built and that may require some modifications to already built walls or the changes can't go ahead
- pre-planning is very, very important
- the planning stages start immediately after we finish one build for the following year

The benefits for my students are:

- they get real life experience with the hands on for the prebuild and the on site construction at the time of the build
- students really feel good in helping the community

I value both Ralph Totman and Robert Lanoue's comments. By combining their observations with my own experiences I form for myself a picture of how Habitat for Humanity affiliates are using prefabrication. I now realize that each affiliate has its own distinct personality. They come in different sizes and have different resources, skills, and goals. I now understand that with prefabrication mistakes can be harder to repair. Although, whether construction is prefabricated or conventional, many mistakes are caused by inadequate organization and communication. I am now convinced that for prefabrication to be successful a complete commitment is required — one that extends beyond prefabrication to incorporate design and execution — and I firmly believe that since this commitment to prefabrication necessitates better organization and communication, it has the potential to solve some of the difficulties that Habitat for Humanity is experiencing.



## Design Guidelines

December 2004: I walk slowly through the crowded exhibit hall. In each hand I carry a plastic bag full of product brochures. I amble from booth to booth and search for more brochures to add to my collection. The event is Construct Canada, a massive trade show for the building industry at the Metro Toronto Convention Centre. I am searching for information on prefabricated products and systems that might be useful to Habitat for Humanity.

I have spent the last several months indoors, reading about prefabrication. I read about the potential advantages of prefabrication: greater quality control; easier management and training of labour; fewer delays due to weather; less on-site waste; and faster project completion. I read about potential barriers to prefabrication: factory start-up and running costs; the greater precision required; higher transportation costs; inflexibility in design and with on-site changes; the need for additional skills or tools; and difficulty in acquiring acceptance from builders, tradesmen, inspectors, and consumers. I read about movements and trends involving prefabrication; the Bauhaus; post war housing; Archigram and the capsule architecture of the 60's and 70's; and contemporary 'modernist' and shipping container houses. I read about the stigmas tied to prefabrication: left by poorly constructed post war housing; and proliferated by the aesthetics and low cost of mobile homes. I read about what are considered the successes of prefabrication: its wide spread use in Sweden and Japan; the standardization of building components in North America; and the large quantities of **Sears Roebuck and Company's Mail Order House Kits**, Quonset huts, geodesic domes, and contemporary modular housing that have been erected. I read about what are considered the failures of prefabrication: the multitude of designs that have not proceeded past the creation of a prototype, including Buckminster Fuller's Dymaxion House and John Prouvé's Tropical House; and companies that have collapsed before producing their intended quantities of housing, such as **The General Panel Corporation** and The Lustron Corporation.<sup>11</sup> It is a large topic, yet much of what I read is of little use to me. The proponents advocate the same advantages; the naysayers raise the same objections. There is much speculation by third parties as to why a venture succeeded or failed, but few answers. Of greatest irritation is the lack of details on the design of these prefabricated systems and products.

I stop at several booths to pick up brochures on steel joists and girts, light gauge steel framing, open web wood joists, and flexible plastic plumbing. These are all prefabricated products, although they belong to the least complex of the **divisions of prefabrication**, components. Bricks are prefabricated components, so is lumber (both conventional and engineered), plywood, gypsum board, siding, shingles, eavestroughs, and the nails, screws, or bolts that hold it all together. More complex components are roof trusses, doors,

## Sears Roebuck and Company's Mail Order House Kits

From the book *Houses By Mail: A Guide to Houses from Sears, Roebuck and Company*:

"Its sales reaches 30,000 houses by 1925 and nearly 50,000 by 1930, more than any other mail order company. In fact, its 1939 homes catalogue claimed that "over one hundred thousand families, or approximately half a million people, are living in Honor Bilt Modern Homes today."

"One of the reasons for the popularity of Sears houses was that they consciously reflected popular American taste of the period; designs were selected for their broad appeal and acceptance."

"Another reason for Sears's early success in the housing market was its reputation for quality at a reasonable price. Sears was committed to and took great pride in the products it manufactured and sold."

"A third reason was the speed and ease with which sears houses could be constructed. Sears provided precut lumber at a time when power tools were almost unknown, as well as a complete set of specifications and instructions to aid in construction. Because owners were directly involved with the design selection and actual construction, they were especially proud of their Sears houses once they were erected."<sup>7</sup>

## The General Panel Corporation

From the book *The Dream of the Factory-Made House: Walter Gropius and Konrad Wachsmann*:

"The main product of this production line was the basic universal panel of the system: 8 ft high and 3'4" wide, wood framed and stressed skinned, with doors or windows where required, which was both structure and enclosure. This modular panel, which gave the scheme its flexibility, was an elegant but wasteful element, with a high degree of structural redundancy in the timber frame, and of a size which necessitated special 40" sheets of plywood instead of the standard 48"."<sup>8</sup>

"Sales were also going slowly, due not to resistance to the product per se, but rather to its high cost. This went against all predictions of the great savings to be made (15 percent "across the board") by industrial production. But the hard fact remained that, until full production was achieved, materials costs were out of all proportion and the overheads (deriving from the expensive plant installation) prohibitive."<sup>9</sup>

"As a commercial venture the Packaged House of the General Panel Corporation was a resounding failure. A decade of dedicated work, an investment of \$6 million, resulted in a trifling number of houses... being produced."<sup>10</sup>

## Divisions of Prefabrication

**Components:** The least complex and most flexible prefabricated products. They often replace just one part of the construction process. Bricks made off-site replace those made on-site. Trusses replace dimensional lumber roof framing. Components integrate easily into the construction process.

**Pre-engineered Systems:** Commonly referred to as pre-cut systems. They involve the on-site assembly of individual building elements which are delivered to the site after being cut or manufactured to their final size. Timber frame homes, log homes, and geodesic house kits are all easily identified pre-engineered systems.

**Panelized Systems:** Sections of walls, floors, and/or roofs which are constructed in a factory and delivered to the site in panels for erection. Panels are either open, which allow access to their interior from at least one side, or closed.

**Modular Construction:** The construction of three-dimensional enclosures in a factory which are delivered to the site to be stacked onto foundations and each other. Manufactured housing is modular construction where the majority of construction is completed in a factory and can include the installation of interior finishes (paint, trim and flooring), fixtures (lights, appliances, washroom and kitchen fixtures and cabinetry), and large portions of the exterior finishes (cladding and roof shingles).

windows, and stairs. These components are themselves assembled off-site from less complex components. On-site house construction is largely the assembly of components.

I think of the wood framed wall panels and floor sections which were built by the Habitat for Humanity Toronto affiliate as components. Although they were in the form of panels, they were simple in their construction and the development of multiple units allowed them to be standardized. There were floor section components, party wall components, and closet wall components. The wood framed wall panels used by the other affiliates, while also simple in their construction, were each different and were constructed for a specific place in a specific house. For that reason I consider these to be part of a panelized system rather than components. However, they are the simplest of panels.

The brochures that I collect say little about the simplicity or complexity of the prefabricated products. Many of them say much about simplicity of installation. They say that installation is “faster, taking less time with fewer people,” or “easier with less skills required than conventional construction.” These qualities are desired as they reduce labour costs for builders. One of these products is **Novabrik**. A concrete brick siding system, Novabriks are nailed to the wall and require no mortar. Bricks are prefabricated components; Novabriks are prefabricated components that are designed to be faster to install by less skilled people. This distinction is an important one for Habitat for Humanity. As the labour that Habitat for Humanity uses is largely volunteer, reduced labour costs are not a concern. However, this volunteer labour is largely unskilled. The work needs to be easy to do and understand. This helps to ensure that the work is completed correctly and that the volunteers have the satisfying experience necessary to keep them engaged and coming back. Many of the prefabricated products that promote simplicity of installation have these potentials. Some products, including Novabriks, are marketed to both builders and the unskilled.

I slide these newest brochures into my bags and continue walking. People are gathering at the end of the aisle. As I approach a man starts to talk; his voice is amplified above the noise of the crowd. I reach the scene and peer through the onlookers. A man is giving a demonstration of an ICF system. I have already collected brochures from half a dozen ICF manufacturers. He enthusiastically informs us of all the features that differentiate his system from its competitors. I listen for a few minutes before my attention drifts to the display behind him. A large sign proclaims it to be a “House Under Construction”. It is a pitched roof timber framed structure. Large SIP panels have been installed on top of the roof timbers. I pick my way through the audience to the structure and find a brochure for Riverbend Timber Framing. Their pre-engineered packages include precut timber framing and SIP panels which are



## Novabrik

From the Novabrik web site:

“Novabrik is a patented mortarless brick siding system. The high strength concrete bricks overlap and interlock to create a strong, water resistant brick veneer.”

“All the inconveniences of mortar have been eliminated. Novabrik can be installed in freezing temperatures without the additional costs usually incurred in winter with conventional masonry installation. There is no variation in the mortar joint color or thickness and no height limitation for installation in a single day. There is no mortar joint to maintain over the life of the building.

Because Novabrik can be installed by workers without masonry skills, the installed cost of the mortarless brick system is less than that of conventional brick walls. In fact, most homeowners with some basic construction skills can install Novabrik themselves.”<sup>12</sup>



1.37 A Novabrik

also precut and include window and door openings. I have found it common for pre-engineered packages to include panelized elements, especially with timber framing. I gaze up at the SIP roof panel (1.38). It is considerably thicker and longer than the SIPs I have worked with and I wonder how much it weighs. I admire the economy of SIPs. In one product they encompass structure, insulation, air barrier, and vapour barrier; four steps in one.

Unfortunately, like many nonconventional prefabricated products, SIPs are more expensive to purchase than the materials that they replace. Through reduced labour costs these products can become cost competitive with conventional construction. With Habitat for Humanity the labour is free. Most of these prefabricated products are thus unaffordable. Products are donated to Habitat for Humanity, as were the SIPs that the Toronto affiliate used and the ICFs used in Waterloo and London. However, this generosity is at the discretion of the donors. The only stable and cost effective way I see for Habitat for Humanity to use nonconventional prefabrication is to manufacturer the prefabricated pieces themselves from conventional materials.

In-house prefabrication is not only the most cost effective solution, it also has the benefit of extending the Habitat for Humanity building season. The use of volunteers largely limits on-site construction to the warm weather months. Building indoors during the off-season keeps volunteers engaged year round and allows for the construction of more houses.

While it is the most cost effective solution, it will still cost more than on-site construction due to enclosure and transportation needs. Maintaining a dedicated warehouse, as the Toronto affiliate does, is beyond the means of most affiliates. Edmonton's method of combining a space for prefabrication with a Restore and Windsor's partnership with St. Clair College are both good options. Costs for tools can be kept low by using the same tools that are used on-site during the summer. In order to make use of conventional materials and tools, construction methods should also be kept close to conventional.

As I look up at this large SIP roof panel I think that there should be more return on an affiliate's efforts in acquiring volunteers, space, materials, tools, and transportation. Simply replacing the single on-site activity of framing with preframed components or panels is not enough. Walls have the greatest potential for an increase in prefabrication due to the number of layers that they contain. The SIP shows me this. To open wood frame wall panels can be added cavity insulation, sheathing, windows, air barriers, vapour barriers, and even exterior cladding and interior gypsum board. The methods are conventional; the challenge is in the accuracy of the prefabrication, and in the connection of panels to each other and the rest of the building. Nevertheless, I believe that Habitat for Humanity could manufacture their own closed insulated wall panels



**1.38** House Under Construction  
Demonstration Area by Riverbend  
Timber Framing at Construct  
Canada 2004.

using conventional materials, methods, and tools. Someone just needs to figure out how to do it and that is what I will do.

I walk up and down the aisles and grab brochures as I go. I end up in a section that seems to be more services than products. I pass by most of the booths, but I pause at one with a large sign that reads, “NRC-IRAP: Helping Companies Navigate The Road To Success.” There are two brochures laid out on a countertop. The first tells me that NRC-IRAP stands for The National Research Council Industrial Research Assistance Program. The second advertises two products: the StuccoBase Panel, which is advertised as “One Complete Building Envelope Solution...One Panel” and the Advantec Panel, a “Non-Combustible Building Design Solution.” Before I can read more a man approaches from the opposite side of the counter.

“Hello there,” he says and I slowly look up to meet his gaze. “I see that your badge says that you’re from the University of Waterloo. We’ve been consulting with a professor from there on the development of these products. Maybe you know him?” I give him a polite, but doubtful look. “His name is Dr. Straube.”

“Yes I do,” I reply with a smile. “Actually, he’s on my thesis committee.”

“Really? You’re doing your thesis in Engineering? What’s it on?”

“Actually, I’m doing my Master’s thesis in Architecture. I’m going to develop a panelized wall system and test it in the design and construction of a Habitat for Humanity house,” I state.

“Well then you’ll be interested in the process that we’re going through with this company,” he says as he taps the brochure in my hand with his finger. “We’re helping them to get **CCMC** approval for their products.”

“I’m not sure that I need CCMC approval, or even **BMEC** approval. They will be closed panels, but they’ll be conventionally constructed.” I look at him hopefully, but he shakes his head.

“If the required building inspections can’t occur on-site then you need either CCMC approval or BMEC approval. For both you’ll need to have the product tested by an independent agency. You’ll also need to pass a plant inspection and provide quality control manuals and installation manuals for review. It can take a lot of time and cost a lot of money.”

“Uh...” The thought of needing a lot of time and a lot of money makes me start to sweat. “I was hoping that I could build a test house... and get approval from that?”

“No, but if it’s been used somewhere else then you can use on-site testing to acquire BMEC approval.”

A smile spreads across my face. “So, I need to have built with it to get approval, but I can’t build with it until I have approval?” He looks slightly confused, but he nods. I thank him for his time and

### **CCMC (Canadian Construction Materials Centre)**

From the CCMC website:

“The Canadian Construction Materials Centre (CCMC), a part of the National Research Council’s Institute for Research in Construction, offers the construction industry a national evaluation service for new and innovative materials, products, systems and services in all types of construction.”

“...by evaluating construction products with respect to their suitability for intended use and conformance to applicable codes and standards. Its focus is on providing information that supports innovation, safety and health in the built environment.”<sup>13</sup>

### **BMEC (Building Materials Evaluation Commission)**

From the web site for the Ontario Building Code:

The Building Materials Evaluation Commission (BMEC) is a regulatory agency authorized under the Building Code Act (BCA). It has a mandate to conduct or authorize the examination of materials, systems and building designs for construction. When approving a product, the BMEC may attach certain conditions for its use. The BMEC may also make recommendations to the Minister regarding changes to the BCA or OBC.<sup>14</sup>

walk away.

I wander through the aisles. I do not stop to pick up any more brochures; I barely notice what I pass. What am I going to do? I do not have a lot of time, I do not have a lot of money, and I certainly do not have a factory to be inspected. This is supposed to be an idea that Habitat for Humanity can use now and that I can test now, not something that is years away. So much for making SIPs.

I find a chair at a vacant demonstration area. I sit down. How much can I do? Is there a worthwhile middle ground between simply preframing and prefabricating a closed panel, or is Habitat for Humanity already doing as much as they can do? Alright, if I cannot circumvent the required building inspections I'd better work with them. Typically for a house there are first footing and foundation inspections. Then there is a framing inspection prior to the installation of cavity insulation, which also includes inspections on the installation of doors, windows, electrical, heating, plumbing, and any insulating sheathing. Next there is an inspection of the complete cavity insulation and the polyethylene air and vapour barrier. Then there are no more inspections involving the building enclosure until the inspection for the occupancy permit.

Alright, if I start with the basic preframed wall panel, the minute I install insulation into the cavity the framing cannot be properly inspected. If I work from the framing towards the inside I can install the polyethylene and the gypsum board, but the former hides the latter from inspection. If I work towards the outside I can install sheathing (as long as it is not insulating sheathing that needs to be inspected), building wrap, doors, windows, and cladding. The panels will be completely open to the interior. There will be no interference with the framing inspection or the insulation and air and vapour barrier inspection. The electrical, heating, and plumbing can be installed on-site. The panelization will not affect the work of these tradesmen, nor will it affect the finishing of the interior. This just might work.

I rise from my chair and weave my way back through the crowd. I realize that the municipality of each affiliate can have their own rules and require different inspections. Flexibility is needed. Layers should be easily subtracted from the prefabricated panels or replaced by different materials to accommodate an affiliate's needs. These needs might include additional inspections or differences in resources, including shortages of time and volunteers.

My test, however, must be complete; it must test the extent of my theories. I need to work with an affiliate to prefabricate these panels all the way from the framing through the cladding using materials that are available to that affiliate and likely available to other affiliates nationwide. I have determined my **design guidelines**. Now all I need is to find an affiliate that is willing to give this a try. I will then turn my ideas into reality. I leave the exhibit hall and ride the escalators up to the street.

### **Design Guidelines**

Design for ease of construction. The work required needs to be easy to do and understand for unskilled volunteers.

Design with conventional construction methods. Use readily available materials and conventional tools to keep costs low and to help integrate the panels into conventional construction processes.

Design for today. Work within existing building code and inspection requirements.

Design for flexibility. Accommodate the differing abilities and needs of affiliates. Allow different amounts of prefabrication.





## **Reality**

Land	42
Prototype	54
The Family	66
House Design	82
In The Shop	92
On The Site	166
Wall Panel Erection	184
Weathertight	196

## Land

December 13, 2004: In a news release the Region of Waterloo announces that they have reached an agreement for the sale of land in Cambridge to the Habitat for Humanity Waterloo Region affiliate (2.1).

From an e-mail from Terri Meyer Boake to Pat McLean, Executive Director of Habitat for Humanity Waterloo Region, and Volunteer Coordinator Sherry Dubue, December 28, 2004:

Pat and Sherry

I am making contact to let you know that I am again interested in having my students partake in a blitz build this coming summer. We are keenly excited, since our school has moved to Cambridge as of September 2005, in being involved in one of the three builds that we see have been announced for Cambridge. The City of Cambridge has been so generous and welcoming to our school, and we are very interested in showing our appreciation through our participation in a Cambridge build.

Again, the timing would need to be mid-August in order for the students to be finished with their classes and able to participate for the full two weeks of the blitz build. I might have anywhere between 30 and 40 students looking to participate.

On another note that may or may not prove to be connected to the above plan, I am supervising a masters student whose thesis is centred on the idea and method of the Habitat build. She has been studying build techniques through her participation in a number of different regional builds (she was our key person on the Inge House build 2 years ago) and tactics and is hoping to become more fully involved in one of the area builds this summer, including potential for specialized design of one (or more) of the dwellings. Her area of specialization deals with making this type of housing “easier” to build, including some aspects of prefabrication. This involvement is intended to be the final piece of her thesis work.

Carolyn and I would be interested in arranging a meeting with you in the new year, if possible, to sit down and discuss any and all of this!

February 7, 2005: Sherry Dubue e-mails Terri to say that they are prepared to meet with us. Terri is going out of town. After waiting so long for a meeting we agree that we cannot wait for her to return. I am to meet with them by myself. I am to pitch my project and represent Terri’s concerns for involving students in a Cambridge build.

February 16, 2005: I meet with Pat McLean, Sherry Dubue, and the Construction Project Coordinator, Janice Tessman, at the Waterloo affiliate’s office. Pat, a middle aged woman in a business suit, takes a seat at the head of the table. Sherry sits down across from me; a large pink flower adorns the front of her shirt. Janice, in a sweatshirt and jeans, sits down to my left and immediately reclines. Her blond



# News Release

Region of Waterloo

December 13, 2004

## **Region of Waterloo and Habitat for Humanity collaborate to build affordable housing in Cambridge**

**Waterloo Region** — Regional Council and [Habitat for Humanity](#) are pleased to announce a partnership that will help build more affordable housing in the Region. After a difficult search for a suitable development site, Habitat will construct three homes on a site at 130 Schlueter Street in Cambridge.

"This partnership is another example of our commitment to provide affordable housing throughout the Region," said Ken Seiling, Regional Chair. "Our arrangement with Habitat builds on Council's Affordable Home Ownership Pilot Program and will give families with moderate incomes the opportunity to own their own home."

In addition to the land agreement, Council will provide Habitat with assistance with development charges as well as loans to assist with the construction of the homes.

"We are very excited about this opportunity," said Pat McLean, Executive Director of Habitat for Humanity. "The partnership with the Region will allow us to fulfill our commitments of assisting families in need and building homes in Cambridge."

The prospective owners of the homes will be selected from the Region's Coordinated Housing Application List or from eligible residents of community housing. Typically, the Region of Waterloo centrally co-ordinated waiting list for affordable housing contains 4,000 households.

Habitat for Humanity is an independent, charitable, faith-based housing program dedicated to the elimination of poverty housing by building homes in partnership with families in need.

2.1 Habitat for Humanity Waterloo Region acquires land in Cambridge from the Region of Waterloo.

hair is cut short and boyish.

I give them my pitch: I tell them that my thesis is to develop a system of prefabrication for Habitat for Humanity for use in Canada; I tell them about the building I have done with other affiliates to see where they are succeeding and where they are failing; I tell them about the problems I found with communication, organization, execution, and design; I tell them that I want to design and build a house that addresses these problems in partnership with an affiliate this summer; I tell them that I would like to involve the students of the school in both the prefabrication and the on-site work; I tell them that this makes their affiliate the perfect choice; I tell them that the prefabrication will be based on conventional wood frame construction and that I would like to clad most of the exterior wall panels before erection; I tell them that the details depend on their resources and needs; and I ask them if they are interested in working together on this.

They are interested. Pat talks about the merits of the affiliate and their history of initiating programs in Canada such as the first women's build and the first student build. She speaks of my project as another of those opportunities. She seems to value innovation and its promotional potential. I point out the marketing possibilities of this joint venture. The School of Architecture's recent move to Cambridge has made it popular with the community. Habitat for Humanity has been trying to build more houses in Cambridge. The School's popularity can help increase the affiliate's profile in the city.

They seem surprised that the school is now in Cambridge. They give me a copy of their build schedule (2.2). It shows them working on a build in Kitchener in mid-August. Two of the three Cambridge houses are scheduled to be built in June; the third house is scheduled for October.

This schedule does not work at all. The students have to be in class during the Cambridge builds in June and October. They are available in mid-August, but it is too difficult for them to travel to the site in Kitchener. Besides, the August build is for five townhouses and I am just looking for one. Pat says that they cannot change the schedule because sponsorships of money and labour for many of the houses have already been arranged.

I ask about the sponsorships for the Cambridge builds. The October build is an Adopt-A-Home by the Ontario Provincial Police Association. As such they are providing the money, the labour, and supervision for the build. One of the Cambridge builds is sponsored by a group of Cambridge churches. They are providing the money and the labour, the affiliate is providing the supervision. This build has already been scheduled for June. The other Cambridge build is sponsored by the Lions Club specifically for a family of six with two disabled children. The Lions Club is only providing the money for the build. There is no labour included in their sponsorship.

**PRELIMINARY 2005 BUILD SCHEDULE**

DATE		MONDAY	TUESDAY	WEDNESDAY	THURSDAY	FRIDAY	SATURDAY	ACTIVITY	LOCATION(S)	
Beginning	End									
March 7	April 1	8am-4pm	8am-4pm	8am-4pm	8am-4pm	8am-4pm		Pre Build	Everglade	
April 4	April 22	8am-4pm	8am-4pm	8am-4pm	8am-4pm	8am-4pm		Pre Build	Cherry	
April 25	April 29	8am-4pm	8am-4pm	8am-4pm	8am-4pm	8am-4pm		Pre Build	Schlueter	
May 2	May 13	8am-4pm	8am-4pm	8am-4pm	8am-4pm	8am-4pm		Pre Build	Schlueter	
May 16	June 3	8am-4pm	8am-4pm	8am-4pm	8am-4pm	8am-4pm		Pre Build	Schlueter, Cherry	
June 6	June 17	8am-4pm	8am-4pm	8am-4pm	8am-4pm	8am-4pm		Pre Build	Schlueter	
June 20	June 25	7am-4pm	7am-4pm	7am-4pm	7am-4pm	7am-4pm	8am - 4pm	Blitz Build	Schlueter	
		4:30-8pm	4:30-8pm	4:30-8pm	4:30-8pm	4:30-8pm		Blitz Build	Schlueter	
June 27	June 30	7am-4pm	7am-4pm	7am-4pm	7am-4pm	holiday		Blitz Build	Schlueter	
		4:30-8pm	4:30-8pm	4:30-8pm	4:30-8pm			Blitz Build	Schlueter	
July 4	July 8	ADOPT-A-HOME BUILD, ST.FRANCIS OF ASSISSI								Everglade
July 11	July 15									
July 18	July 22									
July 25	July 30	7am-4pm	7am-4pm	7am-4pm	7am-4pm	7am-4pm	8am - 4pm	Blitz Build	Schlueter	
		4:30-8pm	4:30-8pm	4:30-8pm	4:30-8pm	4:30-8pm		Blitz Build	Schlueter	
August 2	August 6	holiday	7am-4pm	7am-4pm	7am-4pm	7am-4pm	8am - 4pm	Blitz Build	Schlueter	
			4:30-8pm	4:30-8pm	4:30-8pm	4:30-8pm		Blitz Build	Schlueter	
August 8	August 12	7am-4pm	7am-4pm	7am-4pm	7am-4pm	7am-4pm	8am - 4pm	Blitz Build	Cherry	
		4:30-8pm	4:30-8pm	4:30-8pm	4:30-8pm	4:30-8pm		Blitz Build	Cherry	
August 15	August 19	7am-4pm	7am-4pm	7am-4pm	7am-4pm	7am-4pm	8am - 4pm	Blitz Build	Cherry	
		4:30-8pm	4:30-8pm	4:30-8pm	4:30-8pm	4:30-8pm		Blitz Build	Cherry	
August 22	August 26	7am-4pm	7am-4pm	7am-4pm	7am-4pm	7am-4pm	8am - 4pm	Blitz Build	Cherry	
		4:30-8pm	4:30-8pm	4:30-8pm	4:30-8pm	4:30-8pm		Blitz Build	Cherry	
August 29	September 2	7am-4pm	7am-4pm	7am-4pm	7am-4pm	7am-4pm	8am - 4pm	Blitz Build	Cherry	
		4:30-8pm	4:30-8pm	4:30-8pm	4:30-8pm	4:30-8pm		Blitz Build	Cherry	
September 6	September 9	holiday								
September 12	September 16	ADOPT-A-HOME BUILD, MANULIFE, 2 HOUSES								Everglade
September 19	September 23									
September 26	September 30									
October 3	October 8									
October 11	October 14	ADOPT-A-HOME, ONTARIO PROVINCIAL POLICE ASSOCIATION								Schlueter
October 17	October 21									
October 24	October 28									

Pre Build = footings, foundation, knee walls, floor deck  
 Blitz Build = framing to completion from floor deck up

**Site Location Guide**

Everglade 61 Everglade Cres., Kitchener  
 Schlueter Schlueter St., Cambridge  
 Cherry 170 Cherry St, Kitchener

**2.2 Habitat for Humanity Waterloo Region Preliminary Build Schedule for 2005.**

They tell me that the school can be involved in the Lions Club build, but constraints on their time and resources mean that the house has to be built at the same time as the church group build. There is a house for me to build, but it has to be built in June. I have to make this work.

I tell them that we can start prefabricating at the school the first week in May, that the students can do the work as part of a weekly class, and that these same students can work on-site over two long weekends during the scheduled blitz build. I have no authorization to say these things.

They are sold. We discuss how to proceed. The drawings for the house need to be submitted to the city by the first of April as they are scheduled to start the on-site work on the twenty-sixth of April. They tell me that a design company has donated their services to prepare permit sets for all of their houses this year and that an engineering company is providing the site surveys. I propose that since it is essential to incorporate the prefabrication into the design that I prepare the drawings for the house. They find that to be reasonable. I ask about the family and the disabilities of the children. Pat tells me that she knows that the one child is in a wheelchair and that they can provide me with more information. She says that they built two accessible houses last year. I ask for copies of the drawings for those houses as well as the costs of any similarly sized houses that they built last year. Janice agrees to look for both. Finally, we arrange a follow-up meeting with myself, Janice, and Richard Davison, the Building Project Manager, for the following week.

The whole schedule is much sooner than I was expecting and the disabilities of the family complicates things, but I have a house to build.

February 24, 2005: Early in the morning I meet Richard and Janice at the site in Cambridge. The affiliate has purchased three of five soon to be vacant lots. Large men with large trucks are arriving to continue demolition of a former daycare centre. The land is relatively flat with a gradual slope away from the street (2.3). It is an existing residential neighbourhood within the community of Preston (2.4-2.6). After a quick look at the site we adjourn the meeting briefly to regroup in a nearby Tim Hortons. There we take shelter from the cold, acquire hot drinks, and sit down to talk.

I have come prepared with a list of information that I need to proceed: the site survey and zoning information; details about the family, especially the disabilities of the children along with their current and future needs; permit sets and costing information from similar houses that they have built; and a list of materials that they prefer to use or which are donated. However, I am unprepared for the conversation that takes place.



Above: **2.3** The site (after demolition of the day care).

Left: **2.4** North of the site.



Below Left: **2.5** Across the street from the site.

Below: **2.6** South of the site.



Janice is enthusiastic that I tell Richard about prefabricating the walls. I tell him, but his attitude is hostile. He insists that the panels will warp before they are erected. He then demands to know how I am going to provide a weathertight enclosure — with framing and exterior finishes complete including doors, windows, siding, and shingles — by the end of the two week blitz build. I say that it should not be a problem as the walls will be largely finished when they are erected. I estimate that we need a maximum of two days to erect the wall panels, cap the walls, and complete their exterior finish. The remaining time on-site can be spent constructing the roof. It is obvious that Richard does not believe me. I then make the mistake of talking about roof prefabrication. At first the methods I describe from London seem to interest them; Janice talks about it being useful for their townhouses, but Richard soon decides that it is a very bad idea. He says that it would double volunteer needs, double space needs, and double management needs. I drop the subject. I want to concentrate on the walls, anyway. I just thought that we could discuss the potentials of prefabrication. Although, after rejecting prefabrication for the roof Richard now seems more accepting of the wall panelization.

I try to move things along by asking for the things that I need to proceed with the design. Richard interrupts and tells me that I have to understand that I am not going to design the house. He insists that the design company which has donated their services, Orchard Design, design the house and produce the permit set. His reasoning is that they are certified designers. By this I believe he means that they have written the exams recently introduced by the Ministry of Municipal Affairs and Housing (MMAH) that are meant to test competency in applying the Ontario Building Code. Later this year **qualification and registration with the MMAH** will be required to acquire a building permit. He attacks my capabilities and he seems convinced that the city will not approve of any design that I propose. As I argue my case I realize that, while I consider us to be working together on this project, he does not. He ends the conversation by saying that he needs to talk to Pat about all of this and that he may talk to Orchard Design about me having some input into the design. I am to call him in one week.

Over the next week Terri and I send off e-mails to the Waterloo affiliate describing my capabilities, the credentials of my advisors, and the necessity of my **involvement in the design** of the house. I also order a study manual for my first MMAH building code exam.

When I talk to Richard again he requests a letter confirming the School's involvement, the use of the School's facilities for the prefabrication, and our ability to complete the required work. He then says that his contact at Orchard Design has agreed to meet with me.



## Qualification and Registration with the MMAH

From the Ministry of Municipal Affairs and Housing website for the Ontario Building Code:

“O.Reg. 305/03 requires certain building practitioners to successfully complete an Examination Program of their knowledge of the Building Code Act, 1992 and Ontario Building Code by July 1, 2005. The Examination Program policy applies to building officials, designers, on-site sewage system installers, and staff of registered code agencies.”<sup>1</sup>

“In general, designers that engage in the following “design activities” are required to meet the qualification/registration requirements under the Building Code:

- Preparing a design as part of a building permit application;
- Giving information or an opinion concerning whether a building or part of a building complies with the Building Code if the information or opinion is to be submitted to a chief building official in connection with a building permit application; and
- Preparing a written report for submission to the chief building official based on a general review, where a general review is required by the Building Code.”

“The qualification requirements... include:

- Successful completion of the Ministry of Municipal Affairs and Housing Examination Program, which includes passing a legal/process examination, as well as technical exam(s) in the designer’s area(s) of practice;
- Filing qualification information with the Director of the Building and Development Branch...
- Maintaining Building Code knowledge.”<sup>2</sup>

## Involvement in the Design

From an e-mail from Terri Meyer Boake to Pat McLean, February 28, 2005:

Carolyn is extremely familiar with residential building practices, particularly Habitat builds, having participated in a wide range of builds in various regions over the past two years... Her proposal arises as a means to solve some of the problems she sees with the builds. One of these has to do with a deficiency in both the drawings and the ability of the people on site to read the drawings -- so lack of coordination, mistakes, things don't fit, re-orders, demolition, etc. It is extremely important that Carolyn prepare the drawings for this house as it is the only way she can properly and accurately coordinate the prefab parts to the plan and build process. It will not work to have her adapt her parts to a “normal” design. She needs to be able to identify dimensions, modules, etc to make this work properly. This type of design proposal works to regularize some of the shapes and dimensions to take advantage of production techniques. The house will look like others in the end, but its dimensions and layout will be slightly different. Given that this house must be modified for the disabled children that will be living there, it makes sense to allow her to modify it from the other plans regardless.

March 9, 2005: I meet with Bryan Bruce at Orchard Design. I discover that he is a graduate of the School of Architecture. We talk about the professors he knew and whether they are still at the school.

Bryan is receptive to my ideas. He says that they have considered developing a panelized system themselves for the housing developers that they work with. He shows me the design he has been working on for the Cambridge Habitat for Humanity houses. He has sketched an elevation and a plan for the two houses that will be three bedroom bungalows (2.7, 2.8). Based on this plan he has sketched a plan for an accessible four bedroom bungalow (2.9). The hallway and bathroom are wider, there is a three-foot-wide door for one of the bedrooms, and there is a carport at the front of the house. He does not have any information on the family. He gives me copies of these drawings and requests that, where possible, I coordinate my design with theirs. They have been asked to make the three houses look the same.

I ask Bryan about the site survey. He phones the engineer's office and is told that the survey is not ready yet. He gives me a copy of a Plan of Survey, provided to him by the city, which shows that the lots are between forty and forty-five feet wide and eighty feet deep (2.10, page 53). I request a digital copy of a complete permit set for one of their house designs. This will enable me to develop the design on the computer using their office standards.

I am to acquire more information on the family's needs; he is to send me the survey once it is available. We agree to meet in two weeks to review my work on the design.

From an e-mail to Janice Tessman, March 11, 2005:

There is some information I need and I am hoping that you can direct me to the person in your organization who can help me.

I need more information on this family of 6 and the disabilities that the two children have.

You had mentioned that you had costing information for past builds. It would be great if I could get a set of plans for a similar sized house you've done in the past and the costs associated with it. For this information to be for a bungalow is necessary, for it to be for a 4 bedroom is great, for it to be for an accessible house is the best situation.

Also, are there any materials that are donated to your affiliate specifically Or are there any materials (i.e. window manufacturers) that you prefer to use or get a discount on?

March 14, 2005: I request the information again.

March 15, 2005: Richard Davison phones me and asks me to clarify my requests and to justify my need for the information. I reiterate

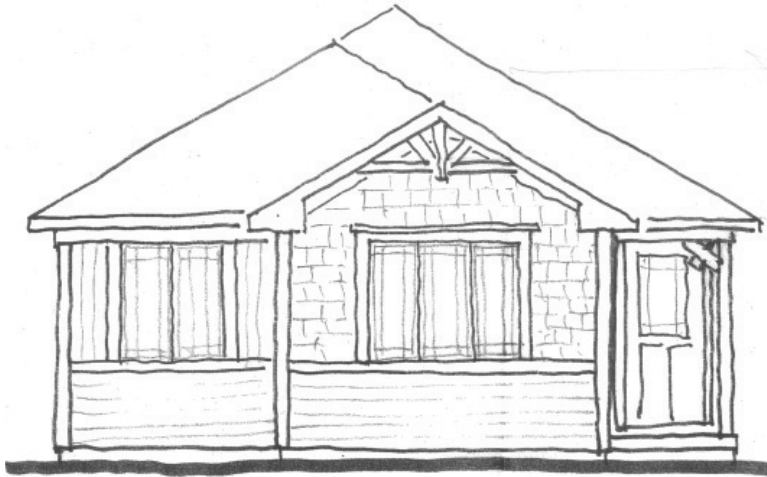

HABITAT FOR HUMANITY  
SHELTER COTTAGES.

Left: 2.7 Preliminary elevation of a three bedroom bungalow by Orchard Design.

Below Left: 2.8 Preliminary plan of a three bedroom bungalow by Orchard Design.

Below Right: 2.9 Preliminary plan of an accessible four bedroom bungalow by Orchard Design.

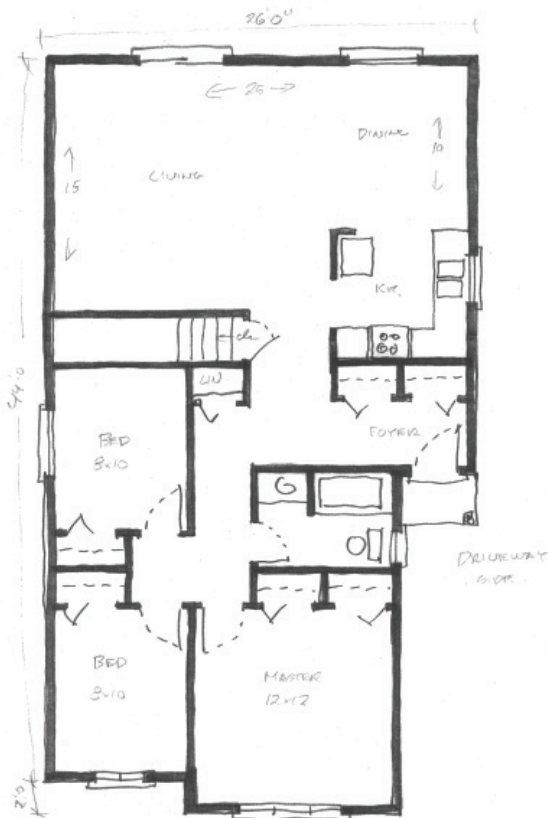

HABITAT FOR HUMANITY  
SHELTER COTTAGES. 1110 sq. ft.

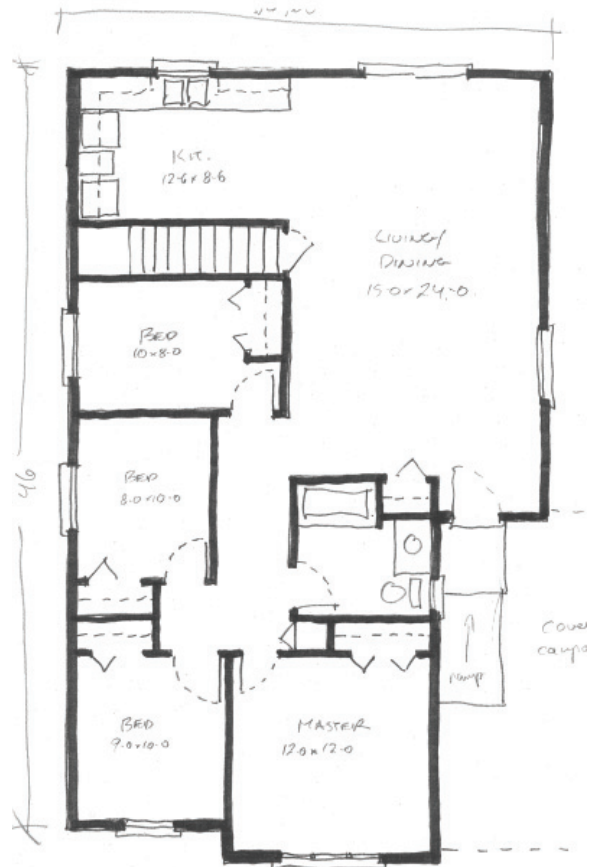

REVISED SHELTER - BARRIER FREE

the information I requested and my reasoning for it. This confuses me. They have already agreed to make this information available to me. He does not agree that I need information on the family. I try to express to him the importance of considering the disabilities of the children in the design of the house. I describe how their needs can affect the allocation of space and the layout of the house. How does the wheelchair bound child get on and off of the toilet? How does he get in and out of bed? Does he have a stronger side? Does he require lifting devices? Are there particular space needs for the children or for their equipment? What are their future needs and is the house adaptable to those needs? Without considering the family's needs we are in danger of building a house that is unlivable for the family. Richard concedes to providing me with information on the family. He says that all other requests for information should be directed to Janice.

I request the information again from Janice.

I hear nothing from Richard or Janice.

Richard 441 533

PLAN OF SURVEY  
SHOWING LOTS 32, 33, 34, 35 AND 36  
REGISTERED PLAN NO. 188  
TOWN OF PRESTON  
SCALE 1 INCH = 50 FEET

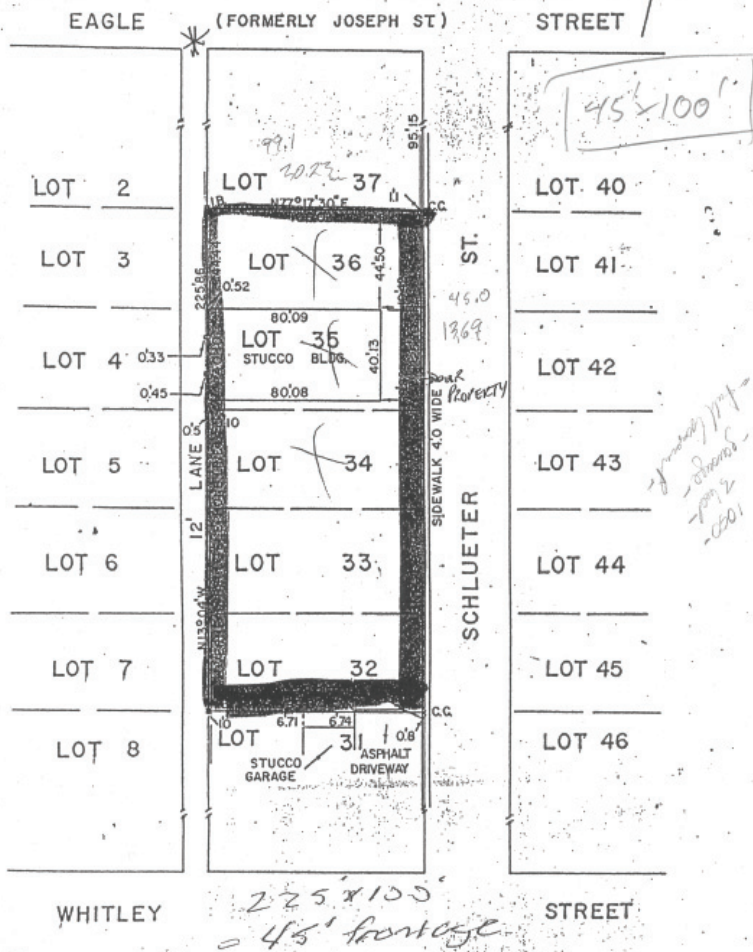

END  
B. - 5/8" SQUARE IRON BAR  
:C. - CUT CROSS

ALL LOTS ARE REFERRED TO SCHLÜTER ST.  
555 LOTS 30 TO 36 R.P. 188 IT BEING  
BMEED N13°00'W

Wayne D. Bullock  
ONTARIO LAND SURVEYOR  
JULY 11, 1966  
WATERLOO, ONT

2.10 Plan of Survey showing the lots (34-36) acquired by Habitat for Humanity Waterloo Region in Cambridge.

## Prototype

March 16, 2005: In sixteen days we need to apply for a building permit. My requests for information are unfulfilled. No information means no design for the house. No design means no drawings for the permit application. Time is already short and it is getting shorter.

I hurry down a hallway in the School of Architecture. I am literally going nowhere fast, but for a moment I feel as though I am accomplishing something. I am stopped by Professor Donald McKay. He greets me cheerfully and asks about my progress. I tell him about the difficulty I am having acquiring the information I need and their incongruous attitude towards providing it. I tell him about the antagonism that I am feeling from Richard and his obvious belief that I know nothing and am incapable of doing anything. I tell him about our attempts to communicate my abilities and the support that I have behind me. I tell him that my usual approach to dealing with men like Richard is to gradually apprentice myself to them, to prove my worth, and that I do not have that opportunity here.

Donald says that I need to show them who is behind me. He says that I should bring Richard to the school and show him that we have the ability to mobilize three-hundred people to get this project done. He also says that I should get the Mayor of Cambridge, Doug Craig, involved to show them our close relationships with the civic authorities and the community. His idea is to invite them to the school for lunch with the Mayor and the Director of the School, Rick Haldenby. He is enthusiastic about it. I see no harm in trying to impress them and I think it is a subtle way to say, “everyone else is on board, why aren’t you?”

The arrangements begin. I bide my time. I evaluate the merits of different building materials and calculate the effect their weight and cost would have on a wood framed wall panel. Terri sends Pat **the letter confirming the school’s involvement**. I research designing for accessibility with the hope that this information will help me to make quick design decisions once I receive the information on the family. Janice sends **their reply** (page 57) to Terri’s letter with “additional questions and comments”. She has not sent me the information I need. I postpone my meeting with Bryan Bruce because I have no design for us to discuss. I then study for, and write, my first building code exam. It tests little of my knowledge of the code and much of my ability to look things up quickly to confirm their exact wording. I pass.

The lunch is arranged for Thursday, March 31st. Pat has requested that not only her and Richard attend, but Janice as well. In my court will be Terri, Rick Haldenby, and the Mayor. Considering the difficulty the Waterloo Affiliate has had developing land in Cambridge I think Pat will revel in the opportunity to have

## The Letter Confirming the School's Involvement



School of Architecture  
7 Melville Street South  
Cambridge, Ontario, N1S 2H4

Tel. 519-888-4567  
Fax. 519-622-3525

Terri Meyer Boake BES B.Arch M.Arch LEED AP  
Associate Professor  
Associate Director  
Undergraduate Academic Officer

17 March 2005

Pat McLean  
Habitat for Humanity  
Waterloo Region Inc.  
120 Northfield Dr. E.  
Waterloo, ON N2J 4G8

**Re: School of Architecture Cambridge Build 2005**

Dear Pat

I am writing to confirm the participation of the University of Waterloo School of Architecture in the Cambridge Habitat Build this coming summer. I understand that you need a letter of confirmation of our participation in this event.

It is my understanding that our Masters student, Carolyn Bilson, will be leading one of the Cambridge builds. The build is being modified from the normal method to include a high degree of prefabrication of panels that will be used to construct the house. This involvement would include leading/organizing the students during the prefabrication sessions, ensuring that the panels are ready for the blitz build, as well as on site organizational responsibility during the blitz build. She is presently working with Brian Bruce of Orchard homes on the specialized design of the house, that will not only include prefabrication, but accommodate a special needs family.

Carolyn has confirmed with me that the prefabrication will take place in our shop at 7 Melville Street and involve approximately 30 of our students (ranging from 2<sup>nd</sup> to 5<sup>th</sup> year). The panels will be constructed on Friday afternoons starting May 6 and concluding June 3. The blitz build will occur over two weekends: June 17, 18 and 19, and June 24, 25 and 26. We will have approximately 30 students working for all six of the blitz build days. At this point our student volunteers have completed the number of requisite hours for their Habitat related coursework. The balance of the completion of the house (post blitz) will be out of our undergraduate students' hands, but will likely see Carolyn's involvement.

I understand that there are numerous details that have yet to be worked out. We have the capacity in our wood shop to construct the panels, but do not have adequate interior space to store the panels until such time as they are required on site. The school is not in a financial position to supply materials, so we are anticipating that all materials will be supplied by Habitat, and that Habitat will be responsible for shipping the panels to the site. Carolyn will be preparing a list of requirements/supplies over the next few weeks as she finalizes the design of the house.

All of our students have completed a mandatory university WHMIS course in order to have shop privileges. Either Carolyn or our shop manager will be in a supervisory capacity during the entire time of the prefabrication. All of the panels will be sizes such that they will not require other than manual lifting equipment in the shop.

Our students, as is normally done, will provide transportation to and from the Cambridge site build. I will make sure that they complete all of the appropriate forms, waivers, and such as soon as they arrive at the school at the beginning of term in May. Carolyn will be organizing an orientation meeting with these students prior to the commencement of the prefabrication process, during which we can make sure that all forms are completed. A representative of Habitat would be more than welcome at this session. You should coordinate this with Carolyn.

As the faculty supervisor for this course (and as Carolyn's masters thesis supervisor), I will also be frequenting both the prefab and blitz build days to make sure that things are in order.

I am not sure what more you require from either myself, or the school. I am away March 12 through 17, (back for most of the 16<sup>th</sup>) but can answer any questions upon my return. Things are somewhat time-sensitive as the contract documents must be completed in order for permits to be filed.

If you have any further questions, please do not hesitate to contact me. I am on sabbatical this year, so it is best to call me at home – 416-636-0031.

Thank you very much, and we are really looking forward to this exciting endeavor!

Sincerely

Terri Meyer Boake

cc Rick Haldenby, Director, School of Architecture  
Carolyn Bilson



## Their Reply

From an e-mail from Janice Tessman to Terri Meyer Boake, March 23, 2005:

Janice Tessman here – once again responding on behalf of both Richard Davison and Pat McLean.

Thank-you for your response to our request for information emailed to you on 14 March. Pat, Richard and I have a few additional questions and comments that we would like to pass along to you.

1. Early in your letter you indicate that Carolyn will be leading the build. We would like to know specifically which responsibilities Carolyn will be assuming on site. We understand that she will be responsible for developing a project schedule, monitoring daily progress, supervising the student team, correctly installing the panels, and assuring the overall quality and completeness of the finished product, but will she, for instance, arrange for all on-site technical and safety training required by the team, be responsible for monitoring site safety, plan materials flow and assess tools requirements.

2. Your letter does not directly address our question relating to which tasks the student team will complete. As you know, this house is scheduled to be built in two phases of construction that are each two weeks long (20 June – 01 July and 25 July – 05 August). This schedule is relatively inflexible because it corresponds to the schedule that we have developed to build another of the Schlueter Street homes. It is our understanding that the student team will be completely replacing our regular volunteer team for the first portion of the work (i.e. no other volunteers will help with the construction process). Because Habitat must be able to lock the doors on the house and leave it until 25 July (when the finishing of the house will commence) knowing that it is weather proof and secure, the student team must plan on ‘closing in’ the house. This means that the following tasks must be complete prior to the students’ departure from the site:

- Interior and exterior walls erected,
- All exterior wall cladding (sheathing, rigid foam insulation, siding) installed,
- Soffit and fascia mounted,
- All roofing components (framing, OSB, shingles, vents) installed, and
- All windows and doors installed, and door hardware installed.

3. In your third full paragraph you state that the student team is planning to blitz build the house in six working days that are spread over the weekends of 18 and 25 June. Firstly, Habitat does not work on Sundays (contravenes Habitat’s faith-based principles and local by-laws, and upsets the neighbours), so the build site will be shut down on two of those days. This leaves four working days. Secondly, Richard feels that it is likely that the students will need seven or more full working days to completely close in the house. Accordingly, the student team will need to arrange to be on site during some of the regularly scheduled blitz building time. According to our existing schedule, the pre-build components of the house (floor joists and decking) are scheduled to be constructed during the week of 13 June. For this reason, the students cannot commence their building tasks until their proposed date of 17 June. Another weekend cannot be added to the schedule because of the statutory holiday that falls on 01 July.

4. In your fourth paragraph you state that the school does not have adequate space to store the prefabricated panels until they are needed on site. Habitat also does not have room for the panels in our storage facility and has no additional funds earmarked to rent secured storage space. We are hoping that the university can access the additional resources required to overcome this hurdle. When the time comes to transport the panels to site we are proposing that the university contract one of our regular suppliers to transport the panels at Habitat’s expense and that the university supply the labour to load and unload the truck.

5. Richard and I are very interested in the process that the students will be developing to manufacture the panels. Consequently we are hoping that one or both of us can be granted access to the school’s woodworking shop on Friday afternoons to observe the panels being assembled.

Once again, thank-you very much for your interest in helping Habitat for Humanity Waterloo Region build a home in the Cambridge area this summer. Pat, Richard and I look forward to ironing out these details so the project can proceed as quickly as possible.

Thanks,

Janice

the Mayor's ear. Richard will not care, but he is the one that I most need to impress.

I need to show him that I know what I am talking about. I have been working on the design of a wall panel system for use by Habitat for Humanity. Although I do not have the information to tailor the design to the affiliate's needs and resources, I decide to build a full scale prototype. I will show Richard that I can build.

I dig out my hammer, pull on my steel toed boots, and drive to Home Depot to get building material. The basic wall panel has four layers: wood framing, house wrap, wood sheathing, and wood battens (2.11). I acquire two-by-six lumber for the framing. Using two-by-sixes allows all of the required insulation to be installed on-site, which eliminates the need to use insulating sheathing. It also allows the spacing of studs to increase from sixteen inches on centre to twenty-four inches on centre. This reduces the number of studs required and helps to compensate for the double stud created where two panels meet (2.12, page 60). Both the use of two-by-six framing and a stud spacing of twenty-four inches on centre are promoted by the CMHC as **advanced framing** techniques.

The panels for the house will be fabricated on tabletop jigs in the School workshop. For now I work on the concrete floor in the student lounge adjacent to the workshop. I start by building a four-foot-wide panel. I gather three precut two-by-six studs and one two-by-six eight feet long, which I cut in half to make one top and one bottom plate. Using wood screws three inches long I attach this wood together into a frame (2.13, page 60).

After making sure that the wood frame is square I cover it with house wrap, which I staple to the frame (2.14, page 60). This layer of house wrap will allow rain that penetrates the exterior surface of the panel to drain away. At the same time it is a highly vapour permeable material and will allow moisture trapped within the wall cavity to escape to the exterior of the building. I wrap the house wrap around the top and side edges of the panel and I staple it down. Sealant applied on-site along the edges of the panels will prevent water from penetrating between panels. I leave the bottom edge of the house wrap loose. When the panel is installed this flap will overlap and be taped to the house wrap which covers the edge of the floor assembly below (2.15, page 61). Sealed this way the house wrap will not only prevent rain penetration, but it will also be a second air barrier to the polyethylene which will be installed on the interior surface of the wall framing after the panels are erected and insulated.

Next, I maneuver a full sheet of exterior grade plywood sheathing on to the top of the house wrap, and I nail it to the framing (2.16, page 61). This sheathing will ensure that the wall panel stays square during storage and transportation. Typically, house wrap covers

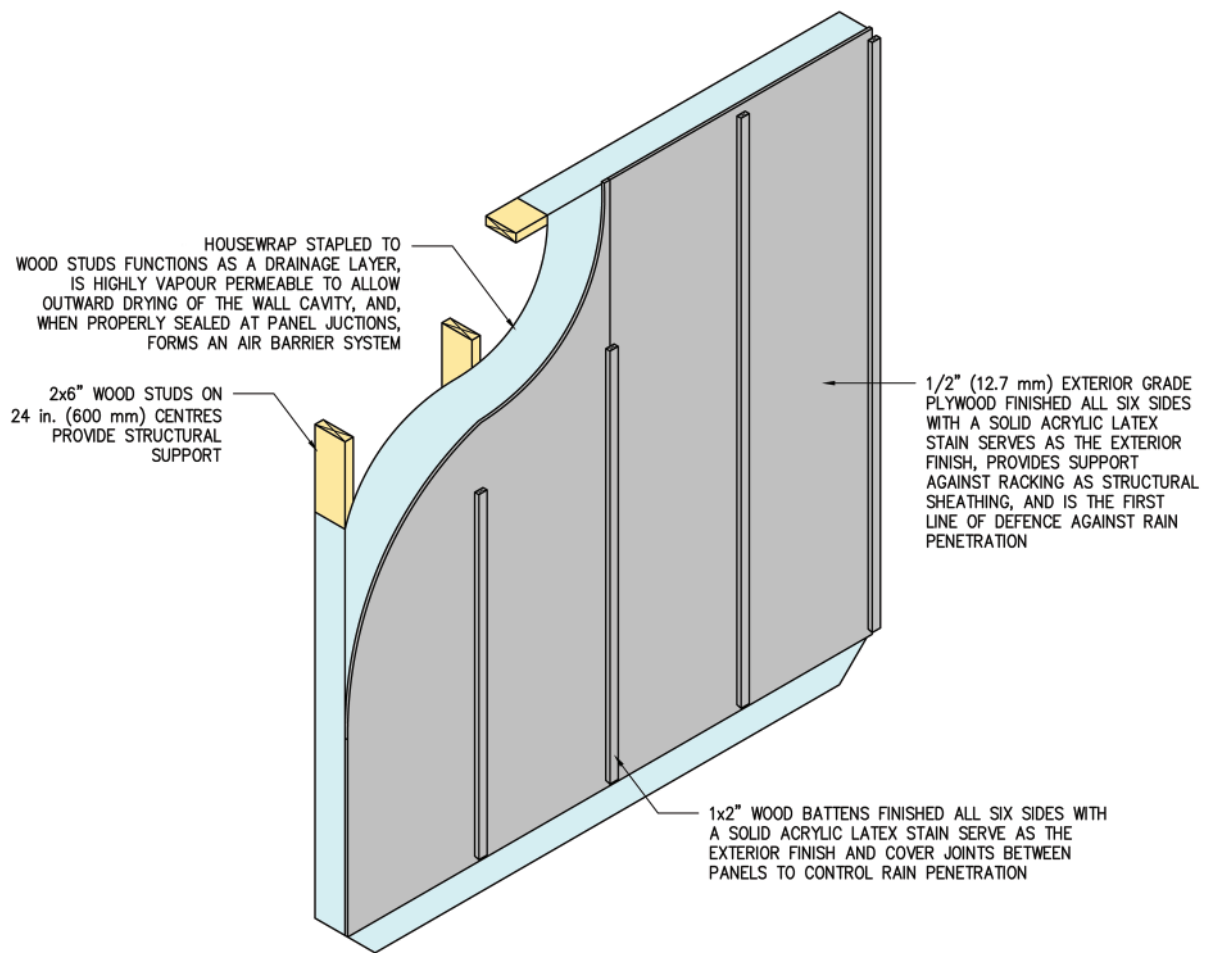

2.11 Diagram of a basic wall panel.

### Advanced Framing

From the CMHC Better Buildings Advanced Framing Case Study:

“Advanced framing is the optimum use of wood framing; both from a cost and building science perspective.”<sup>3</sup>

“Advanced framing spaces framing materials at their most cost effective spacing—all studs, joists and roof members at 600 mm (24 inches) on centre consistently throughout the house structure.”

“A 38 x 140 mm (2 x 6) wall at 600 mm (24 inches) uses no more lumber than a 38 x 89 at 400 mm (2 x 4 at 16 inches), but is structurally superior and allows for more insulation.”

“When the location of door and window openings in the exterior wall is coordinated with the modular stud spacing, it can eliminate or reduce the use of cripples and jack studs, regardless of whether the walls are loadbearing. Where it is possible to use window sizes that fit between the studs, no added cripples or lintels are required.”<sup>4</sup>

“The advanced framing approach is to use flat horizontal blocking, using cut-offs, spaced at 600 mm (24 inches), between the adjacent studs of the exterior walls, to which the interior framing can be attached, and also as a backing for interior drywall.”<sup>5</sup>

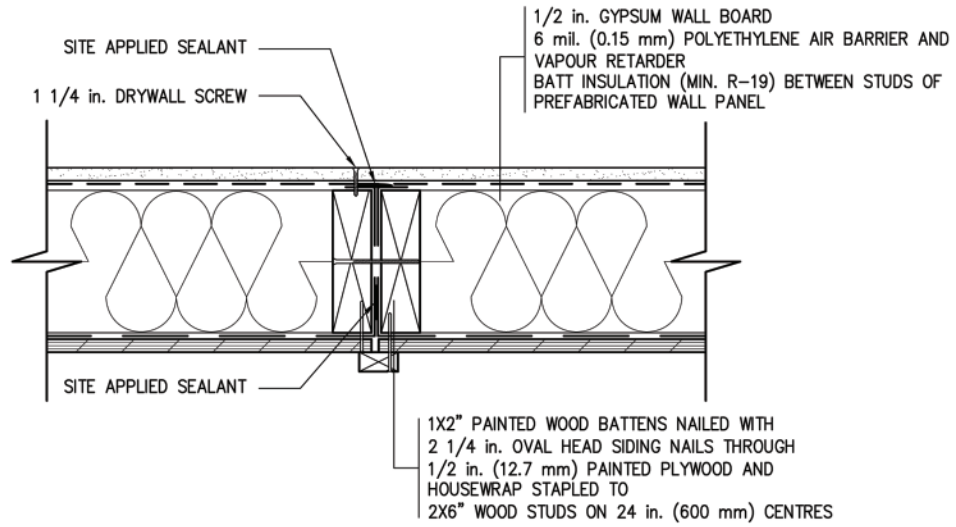

Top: **2.12** A double stud is created where two panels meet.

Right: **2.13** The panel framing is complete.

Bottom: **2.14** The framing is covered with a layer of housewrap.

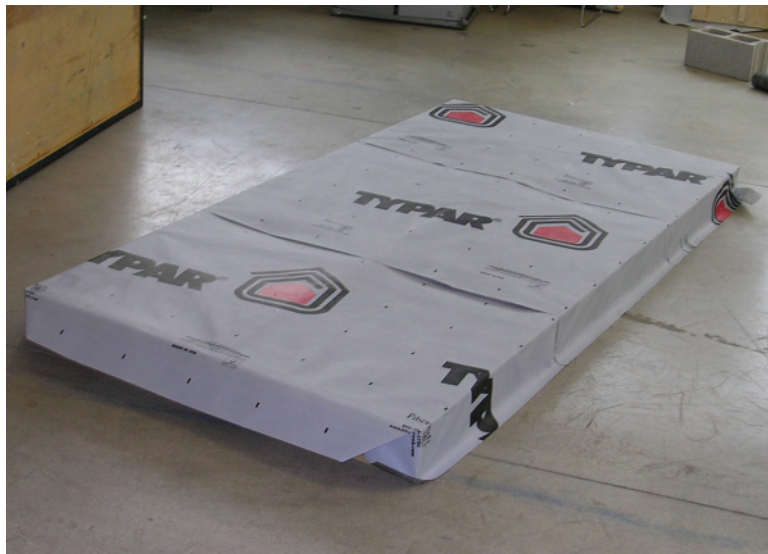
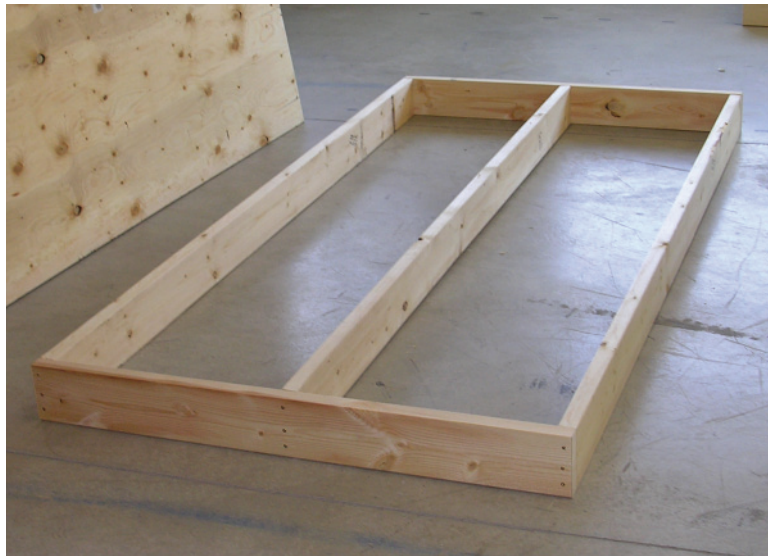

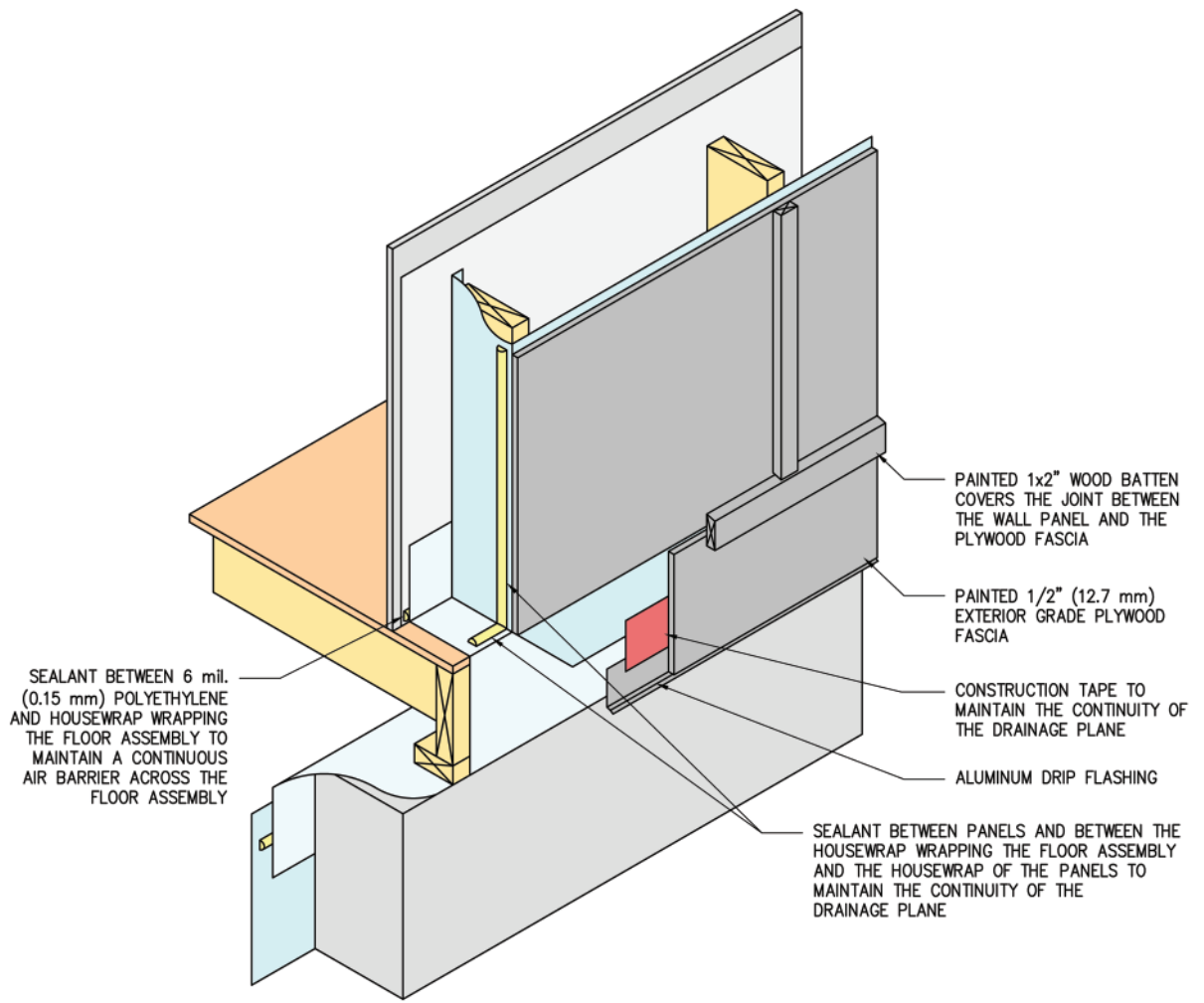

Above: **2.15** Diagram of the connections between a wall panel, the subfloor below it, and the foundation below that.

Left: **2.16** Plywood sheathing is nailed through the housewrap and to the wood framing.

exterior sheathing, but in this case the sheathing is also going to be part of the exterior cladding. This secondary function reduces the number of layers in the wall panels which in turn reduces both the weight and the cost of the panels.

The final layer consists of four one-by-two wood battens. I nail them to the plywood twelve inches apart (2.17). The last batten overhangs the edge of the panel; it is to cover the vertical joint between panels to resist the penetration of wind and rain. The other battens are purely aesthetic. I am using unfinished battens and “Sheathing” grade plywood for my prototype. In the final product the plywood needs to be “Good One Side”<sup>6</sup> grade, which will be free of knots. Both the plywood and the battens need to be finished on all six sides to resist moisture penetrating into the wood. Using a solid acrylic latex stain will hide minor imperfections in the wood and will both resist moisture penetration and allow any moisture within the wood to escape.

Other materials, such as engineered wood and fiber cement panel products, may be used to brace and clad the panels. These products tend to come in the same four-foot-by-eight-foot size sheets as the plywood and thus, like the plywood, would not have to be cut to be used in the panels. I have chosen to use plywood and one-by-two battens because of the ready availability of the materials, the simplicity of the detailing at the joints, and the tolerance for error allowed by the battens. The use of these materials as an exterior cladding by Habitat for Humanity is not unheard of; the neighbouring Wellington County affiliate has clad a semi-detached house in Elora this way (2.18).

I now have one complete panel. I build one more four-foot-wide panel and one two-foot-wide panel. The panels go together quickly. With three panels I can test an inside corner and an outside corner. I build a floor deck, which I raise on a ‘foundation’ of concrete blocks. With the help of a friend I erect the panels on this floor deck (2.19). As I expected the four-foot-wide panel is easily carried by two people.

I still need to cap the panels to tie them together, sheathe the rim board, and complete the battens at the inside and outside corners. I hammer late into the evening. Sometimes I hit the nails, sometimes I hit the battens, and once I hit my thumb. In the end I have one large prototype and one large blood blister; both are ready for lunch with the Mayor the next day.

March 31, 2005: It is ten minutes after twelve noon. I have just met the Mayor and to my embarrassment Pat, Richard, and Janice are late. Terri, Rick, and the Mayor have gone ahead to the café in the school where we will have lunch. I pace at the front door of the school. Richard and Janice arrive with a story about a computer virus at the office. Pat arrives a short time later.



Left: 2.17 Wood battens nailed to the plywood completes the panel.



Above: 2.18 Plywood and batten clad Habitat for Humanity house in Elora.



Left: 2.19 The completed and erected wall panels.

We all sit down to lunch. I have asked Terri, Rick and the Mayor to discuss the importance of the project to both the school and the community; to emphasize cooperation rather than an attitude of us versus them; to express confidence in me; to show them the support structure that I have behind me; and to convey the importance of accommodating the needs of the family. They do just that. Pat talks to the Mayor about the difficulty in acquiring land in Cambridge. I concentrate on not dropping my food on my dress clothes.

After lunch the Mayor excuses himself and Rick gives a short tour of the school that passes through the workshop and ends at my prototype (2.20). I then stumble my way through a short digital slide presentation on the construction of the prototype and the intentions behind the design.

They like the panels; they do not like the cladding. They want the panels to be clad prior to erection, but with a material that requires less maintenance for the family. Richard wants to set up a meeting with Bryan Bruce for us to discuss alternative claddings.

The discussion turns to other matters. They reiterate that the house needs to be weathertight and secure by the end of the School's involvement. We state that we will erect all of the wall panels our first day on-site and that we will begin erecting the roof trusses the following day. They specify that there can be no construction on Sundays, which reduces the number of days the students can work on-site from six days over two long weekends to four days. We pledge graduate students to work the other days of the two-week-long blitz build, with myself acting as house leader. We agree to provide all of the tools for the prefabrication; they agree to provide all of the tools at the site. They will provide the materials; we will store the built panels; they will arrange for transportation of the panels to the site. They will provide contact information for the family and I will ask the family about their needs.





2.20 The completed full scale prototype.

## The Family

April 4, 2005: I acquire the phone number for the family from Pat's assistant, Ella Schmidt. Soon afterwards I am speaking on the phone with Laurie Baker. She is friendly and she is willing to tell me about her family. Her husband's name is Sean. They have four children: Kevin, who is thirteen years old; Dustin, who is twelve; Kayla, who is eleven; and Tyler, who is ten. Their son Kevin has **cerebral palsy, autism, hydrocephalus**, and he is legally blind. He uses a wheelchair much of the time and he has a seeing eye dog. Their daughter Kayla has hydrocephalus and **osgood-schlatter disease**, which affects her knees, and which she is expected to grow out of.

We talk about Kevin's needs and equipment: the seven-foot-long ramp that he uses to enter and exit the side door of their minivan; the addition to the toilet seat that he uses and his ability to transfer to the toilet from the side or the front; the current ability of his Father to lift him onto the toilet seat and the expectation that, with therapy, he will not need lifting equipment in the future; the need for a bathtub rather than a roll-in shower and their desire to install a therapeutic tub; the need for ground floor laundry facilities as he cannot be left unattended; the custom-made bed that facilitates his therapy and dressing; the need for his bedroom to be close to his parents; the video monitor that is required to monitor his seizures; and the need for wide doorways, equipment storage, and grab bars. Laurie also requests a second full bathroom and space for the future installation of a vertical lift as they intend to finish the basement.

From an e-mail to Ella Schmidt and Pat McLean, April 13, 2005:

Thank you for the Baker Family contact information. I was able to speak with Laurie Baker about their wants and needs for the house. I am trying to accommodate what I can, however some requests they have are things Habitat doesn't usually provide. Some things just won't fit into the house.

For instance, they have requested two full bathrooms to a) deal with the morning rush, and to b) provide privacy as there is toileting equipment needed for their oldest child. I am currently working with the compromise of one full accessible bath complete with a closet for the storage of equipment.

They have also requested:

- laundry space on the main floor, since that same child cannot be left unattended while laundry is being done in the basement. Their current living conditions have laundry machines located in a closet in their kitchen. They believe that this is not ideal.
- enclosed storage space for two wheelchairs and a ramp that is used for loading into their van.
- space allocated for the future installation of a lift as they would like to finish the basement.

What are you willing to accommodate?

## Cerebral Palsy

From the Ontario Federation for Cerebral Palsy website:

Cerebral Palsy (CP) is a term used to describe a group of disorders affecting body movement and muscle coordination. The medical definition of cerebral palsy is a “non-progressive” but not unchanging disorder of movement and/or posture, due to an insult to or anomaly of the developing brain. Development of the brain starts in early pregnancy and continues until about age three. Damage to the brain during this time may result in cerebral palsy.

This damage interferes with messages from the brain to the body, and from the body to the brain. The effects of cerebral palsy vary widely from individual to individual. At its mildest, cerebral palsy may result in a slight awkwardness of movement or hand control. At its most severe, CP may result in virtually no muscle control, profoundly affecting movement and speech...<sup>7</sup>

## Autism

From the Autism Society Canada website:

“Autism Spectrum Disorder (ASD), also referred to as autism, is a neurological disorder which causes developmental disability. Autism affects the way the brain functions, resulting in difficulties with communication and social interaction, and unusual patterns of behaviour, activities and interests.”<sup>8</sup>

“Children and Adults with ASDs have Challenges with:

- Social interactions
- Verbal and non-verbal communication
- The ability to learn (in the usual settings)
- Repetitive behaviours
- Unusual or severely limited activities and interests”

“Autism varies tremendously in severity. At its most severe, individuals with autism have symptoms of extremely repetitive and unusual behaviours which may include self-injury and aggression... Living or working with a person with severe autism can be very challenging, requiring tremendous patience and understanding of the disorder. In its mildest form, however, autism is more like a personality difference due to difficulties in understanding social conventions.”<sup>9</sup>

## Hydrocephalus

From the Spina Bifida and Hydrocephalus Association of Canada (SBHAC) website:

“Cerebrospinal fluid or CSF is a watery substance containing proteins, salts and sugars which protect and nourish the brain and spinal cord tissues. Our brains contain four interconnecting cavities called ventricles in which CSF flows. CSF also flows between the surface of the brain and the skull and acts as a cushioning agent for the brain. CSF is continually being produced, and absorbed by the body. When CSF can not circulate properly, excess fluid builds up in the brain causing intracranial pressure. The accumulation of excess fluid in the brain is called hydrocephalus...”<sup>10</sup>

## Osgood-Schlatter Disease

From the The A.D.A.M. Medical Encyclopedia:

“The disorder is typified by a painful swelling just below the knee on the front (anterior) surface of the lower leg bone. The area is tender to pressure, and swelling ranges from minimal to very severe. Running, jumping, and climbing stairs cause discomfort. Symptoms occur on one or both legs.”

“This disease is probably caused by microtrauma (small, usually unnoticed injuries caused by repetitive overuse) that occurs before the complete maturity of the anterior tibial tubercle attachment.”<sup>11</sup>

While I wait for a response I work on refining my wall panels. I meet with Dr. John Straube, a member of my thesis committee and a professor of building science. I show him my prototype. His concern is, “Does it work?” He walks over to a nearby vending machine, buys a bottle of water, and to my astonishment, he pours the water into the wall between the house wrap and the plywood. Some of the water pours out of the wall onto the concrete floor below; much of the water becomes trapped inside the wall at the base of the panel. The house wrap is sandwiched too tightly between the sheathing and the framing. Rain that penetrates the sheathing could similarly become trapped. To fix the problem John suggests I try a product called StuccoWrap, which is a special wrinkled house wrap. The wrinkles create drainage channels.

I try to locate a local supplier of Tyvek StuccoWrap. I have difficulty. While I am on the Tyvek website I read through the StuccoWrap installation guidelines. They are much the same as those for their regular house wrap. One of the analogous instructions catches my attention.

From the Tyvek StuccoWrap Installation Guidelines, Step 3A:

Secure Tyvek® weather resistive barrier every 12”-18” on vertical stud line. With wood, insulated sheathing board or exterior gypsum board, use large head or plastic washer head nails (such as Tyvek® WrapCaps or Wrap Cap Screws), as a best practice. Wide staples with 1.0 inch minimum crown can also be used.<sup>12</sup>

I have been stapling the house wrap to the studs, but what if I use plastic washer head nails instead? Can I use their thickness to create a drainage space?

I easily find nails with plastic washers for sale by the pound at a nearby lumber yard (2.21). From my prototype I remove one of the four-foot-wide wall panels and lay it on the floor. I remove the battens, the plywood, and the stapled-down house wrap. I roll out new house wrap, but this time I secure it with plastic washer head nails (2.22). I lay the plywood on top of the plastic washers and I nail it down. These nails I keep close to the plastic washers to avoid drawing the plywood in tight to the house wrap. I replace the battens and, with the help of a friend, I re-erect the wall panel. I also remove the plywood rim board fascia and drive some plastic washer head nails into the rim board to create a drainage space there as well (2.23).

The space that I have created looks good (2.24), but does it work? I grab a bottle of water and pour it into the wall. Much of the water pours out at the bottom of the floor assembly and runs down the concrete block foundation; some of the water pours out at the bottom of the wall panel and runs down the front of the rim board fascia; all of the water does pour out (2.25). It does work.

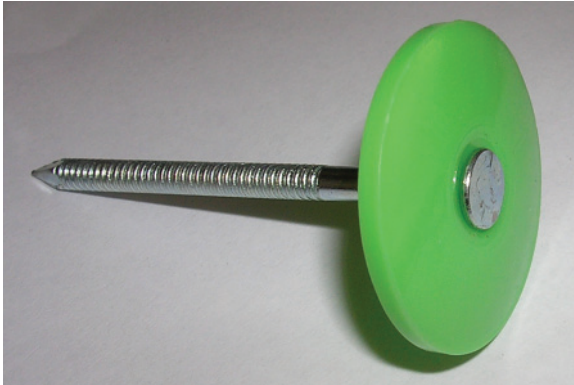

Above Left: **2.21** A nail with a plastic washer.

Above: **2.22** Housewrap secured to the wood framing with plastic washer head nails.

Left: **2.23** A drainage space created at the rim board with plastic washer head nails.



Below Left: **2.24** The space created between the housewrap and the plywood.

Below: **2.25** A successful water test.

April 19, 2005: I receive a phone call from Bryan Bruce. He is calling to confirm my e-mail address. He wants to send me a copy of the permit set for the house. Shortly afterwards I receive an e-mail from Pat McLean. She is responding to my question as to what of the family's requests they are willing to accommodate.

From an e-mail from Pat McLean, April 19, 2005:

Richard and I discussed their requests and feel that we can probably accommodate some of them. However, we felt it would be better to meet with Laurie Baker asap and discuss them further. Richard has the draft plans so we can figure out how to fit the changes.

Will you arrange a meeting with her and if possible at her house so that we can see the wheelchairs etc?

What is all this talk about a set of drawings for the house? This design cannot possibly incorporate the panelization. I have not yet discussed the specifics of the panelization with Bryan. It is completely useless for my project to prefabricate a design that does not take prefabrication into account. Besides, how can there be a permit set if the cladding has not been decided? What about the family's needs? As far as I know Bryan does not know anything about the family — about Kevin. I had no idea that they were working on the design. I am supposed to be designing the house. It was agreed.

From an e-mail from Terri Meyer Boake to Pat McLean, April 19, 2005:

I just received a fairly unsettling email from Carolyn. I am not sure what is happening, but Bryan Bruce from Orchard was trying to send Carolyn the permit set that they had developed for the house that Carolyn is designing the prefab panels for. This seems utterly strange as it was our understanding that Carolyn was developing this set... This house is to respond to the specific family needs for which Carolyn was interviewing the family. None of the technical needs for the prefabrication, nor the family needs could have possibly been incorporated into the Orchard permit set... Can you please let us know what is going on? We still do not have a site plan as far as I know.

If you do not wish Carolyn to be involved in this building, please let us know. We have Carolyn, her thesis, and 30 undergraduate students arranged for this build. All of their other courses have been realigned to make this happen. If it is not to take place in the manner that we think we have agreed upon, we need to know very soon as we will have to make alternate arrangements for many things.

From an e-mail from Terri Meyer Boake to Pat McLean, April 20, 2005:

I met with Carolyn yesterday and had a look at the Orchard permit set (2.26-2.28, pages 71-73). The plan is more or less the same as the initial sketch, with the exception of a few more 36" wide doorways. There has been little done to accommodate the barrier free requirements of this family. There is no wheelchair storage. The bathroom is not

Facing Page: 2.26 The main floor plan from the set of permit drawings prepared by Orchard Design.

TOTAL FLOOR AREA = 1266 sq.ft.

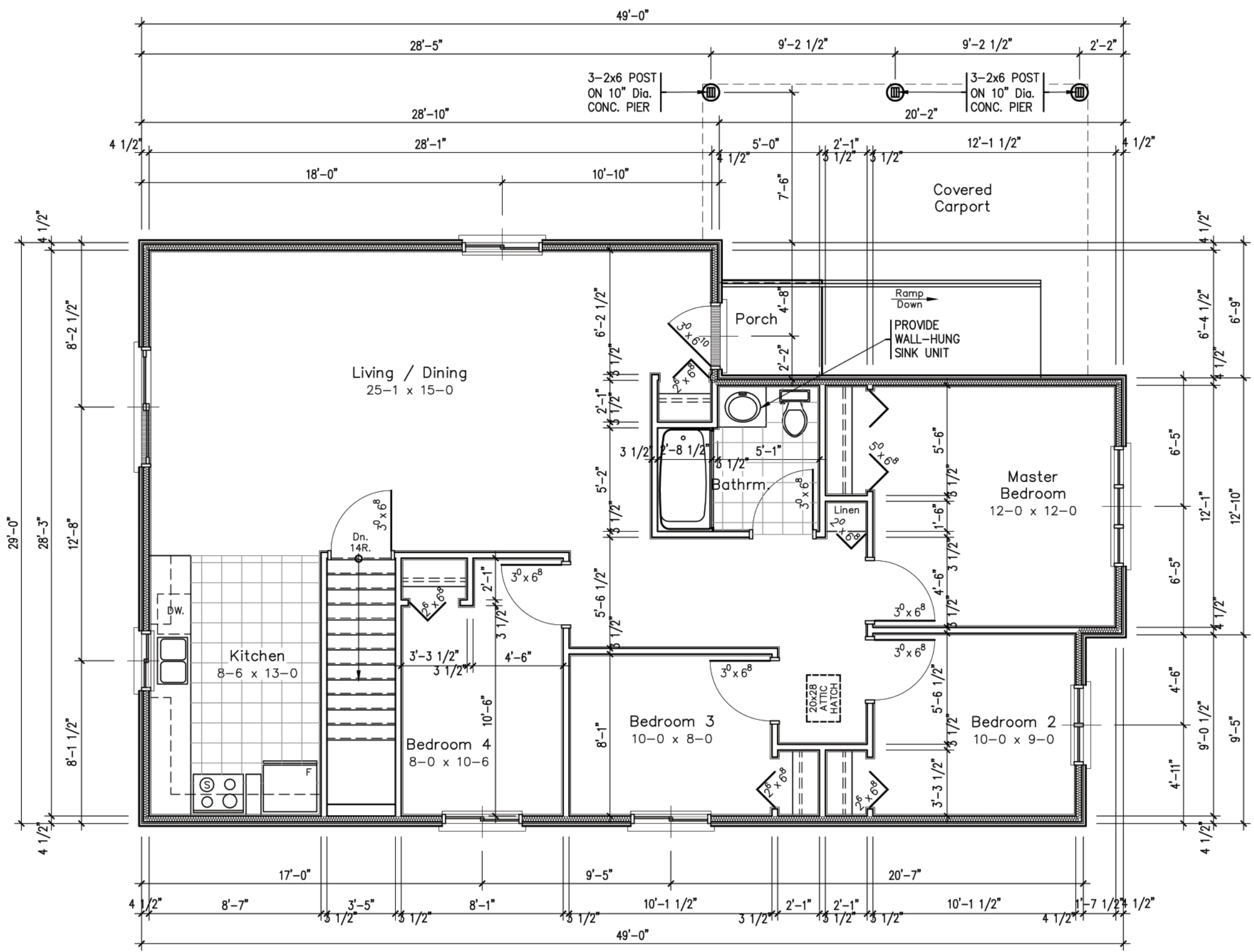

**NOTE:**  
 4 1/2" EXTERIOR WALL DIMENSION INCLUDES 1" OF INSULATED SHEATHING (OUTSIDE FACE IN LINE WITH FOUNDATION WALL BELOW)

**NOTE:**  
 PROVIDE BUILT-UP WOOD STUD POST EQUAL TO STUD DEPTH x WIDTH OF BEAM, AT BOTH ENDS OF STEEL OR WOOD BEAM.



ORCHARD DESIGN STUDIO INCORPORATED (519) 620-0411  
 These drawings are the sole ownership of Orchard Design Studio (ODS). Any reproduction of these drawings without written request to ODS is strictly prohibited.  
 ODS is not responsible for errors and omissions to these drawings. All construction shall conform to the Ontario Building Code Latest Edition. The Owner / Constructor must verify all dimensions, structural components and details and report any discrepancies to ODS prior to construction.



STATUS: BUILDING PERMIT
PLOTTED: 4/11/2005 8:53 AM
SCALE: 3/16"=1'-0"
DWN BY: CDP
DATE: APRIL 2005
REV.

PROJECT: HABITAT FOR HUMANITY BARRIER FREE BUNGALOW  
 TITLE: MAIN FLOOR PLAN

SHEET No. 6 OF 12

These drawings are the sole ownership of Orchard Design Studio (ODS). Any reproduction of these drawings without written request to ODS is strictly prohibited.  
 ODS is not responsible for errors and omissions to these drawings. All construction shall conform to the Ontario Building Code Latest Edition. The Owner / Constructor must verify all dimensions, structural components and details and report any discrepancies to ODS prior to construction.

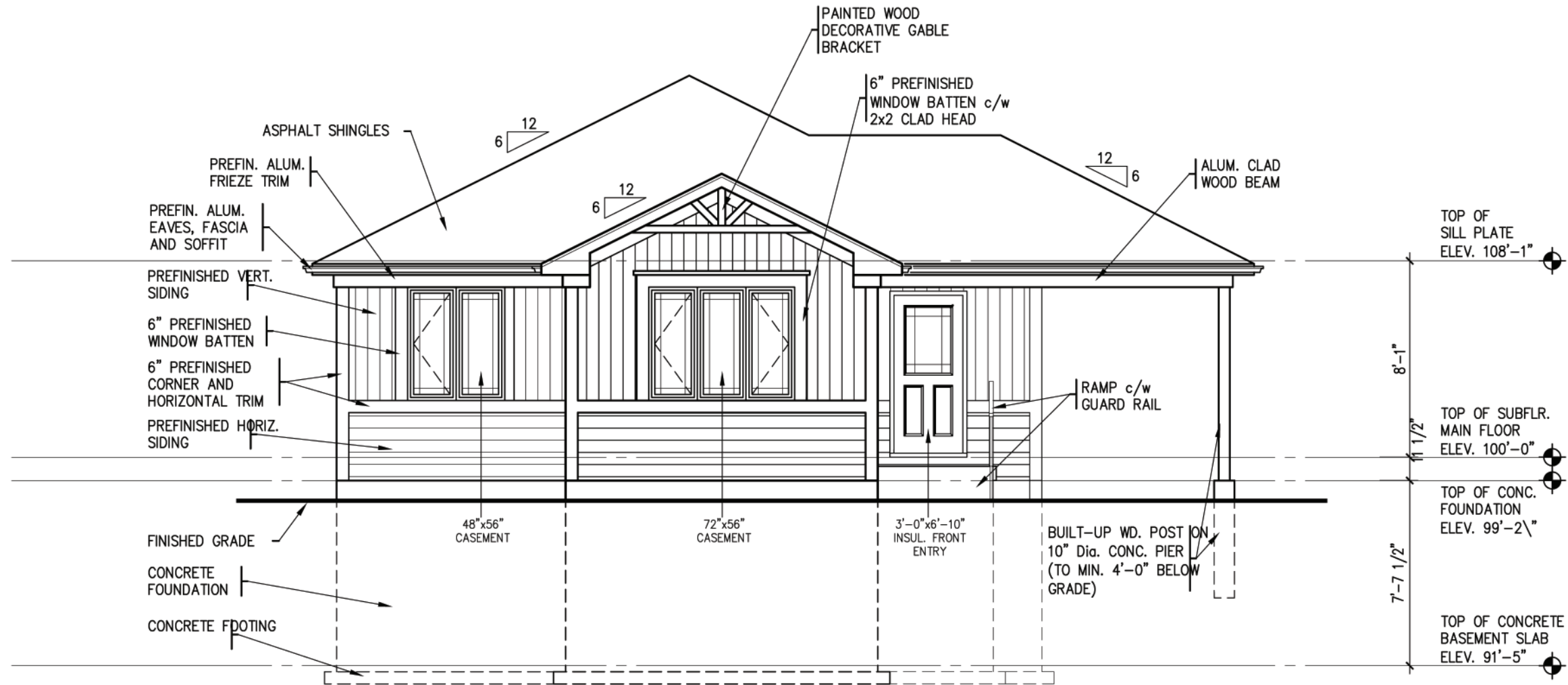

STATUS:	BUILDING PERMIT
PLOTTED:	4/11/2005 8:53 AM
SCALE:	3/16"=1'-0"
DWN BY:	CDP
DATE:	APRIL 2005
REV.	

PROJECT: HABITAT FOR HUMANITY BARRIER FREE BUNGALOW  
 TITLE: FRONT ELEVATION

NOTE: WINDOW SIZES SHOWN ARE APPROXIMATE. EXACT ROUGH OPENINGS TO BE DETERMINED BY WINDOW MANUFACTURERS SPECIFICATIONS.



These drawings are the sole ownership of Orchard Design Studio (ODS). Any reproduction of these drawings without written request to ODS is strictly prohibited.  
 ODS is not responsible for errors and omissions to these drawings. All construction shall conform to the Ontario Building Code Latest Edition. The Owner / Constructor must verify all dimensions, structural components and details and report any discrepancies to ODS prior to construction.

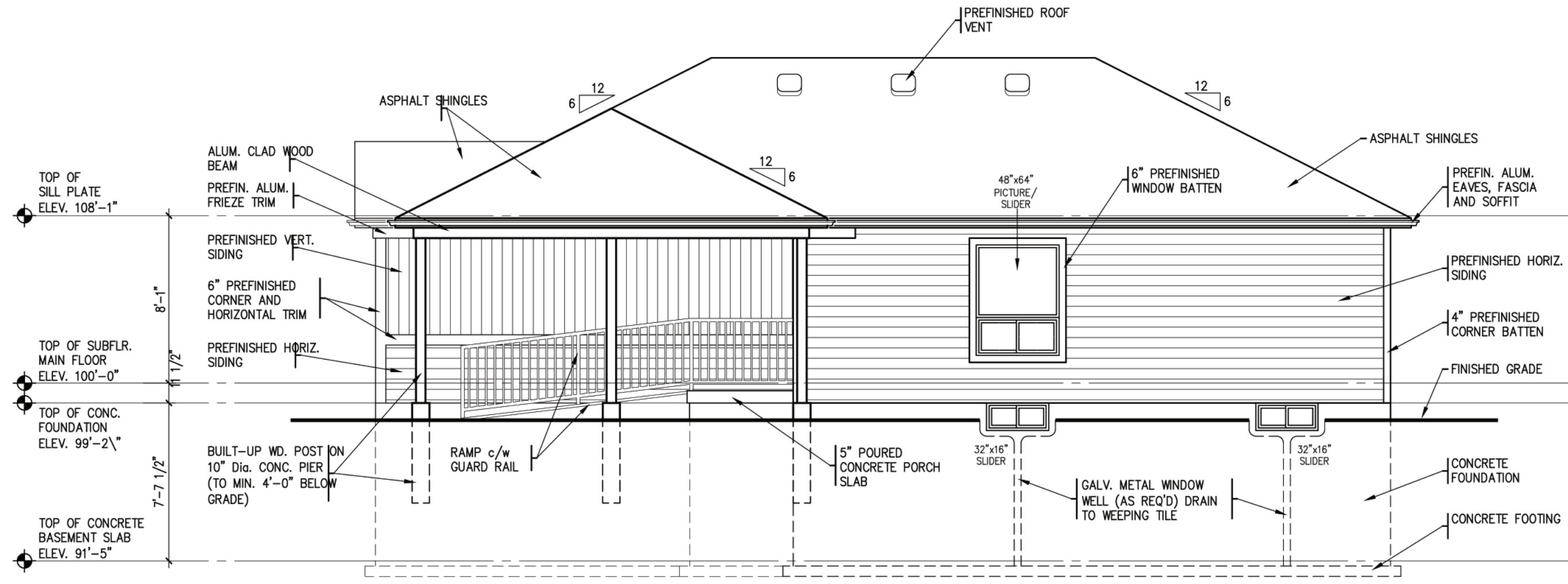

STATUS: BUILDING PERMIT	DATE: APRIL 2005
PLOTTED: 4/11/2005 8:53 AM	REV.
SCALE: 3/16"=1'-0"	
DWN BY: CDP	

**HABITAT FOR HUMANITY**  
**BARRIER FREE BUNGALOW**

PROJECT TITLE

**RIGHT SIDE ELEVATION**

NOTE: WINDOW SIZES SHOWN ARE APPROXIMATE. EXACT ROUGH OPENINGS TO BE DETERMINED BY WINDOW MANUFACTURERS SPECIFICATIONS.

Page 72: **2.27** The front elevation from the set of permit drawings prepared by Orchard Design.

Page 73: **2.28** The right side elevation from the set of permit drawings prepared by Orchard Design.

nearly accessible enough. It will be difficult to transfer someone from a wheelchair to the toilet. There is the 5' turning radius, but the door needs to open out into the hall in case someone falls. The ramp to the front door is too steep. Once it is made long enough (1:12 max slope), it will extend far out into the driveway, making someone take the child out into the rain and snow to get from the car into the house. Storage is a general issue as the increase to 36" doors has reduced all of the closets to the point of being unable to accommodate the children's clothes, let alone their equipment.

I am not sure if Habitat has done many barrier free homes in the past, but there are quite a few specific things that need to be incorporated. We are concerned that the family, which is currently living in a well designed, generous (2 bathroom) barrier free unit, will be quite unhappy to find that their needs have not been met. There is presently, and will be in the future, a high level of equipment that must be housed, as the children grow and their health declines. If this is not accommodated, it will reflect badly on our involvement in the project...

The house design has made absolutely no accommodation for the panelization process. Although one theoretically can panelize and prefabricate any building, the idea behind the process is to regularize the panels so that you are maximizing the number of units that are exactly the same. This way we set up tables/jigs and can greatly reduce the waste. It reduces building time and potential "non fit" situations when the panels are brought to site. The way the plan sits now, almost every panel will be a different size... there will be a lot of wasted material (studs as well as plywood sheathing) as they are cut to much smaller sizes to make it work around the window locations. This makes no sense to me at all. With such specialization, I am not even sure that we have allocated adequate time for the students to manufacture the panels.

For handling, stability and insulation requirements, Carolyn was using 6" studs @ 24" o.c. Orchard has laid out 4" studs @ 16" o.c.

It was our understanding that the house was to be similar in both style and appearance to the Orchard designed house next door, but that Carolyn was to be producing the permit set so that it was designed around the panel sizes, as well as the family's specific needs.

Thursday, April 21, 2005: Pat, Richard, and I meet with Laurie Baker at her house in Waterloo. As we all sit down at the kitchen table Pat pulls out the set of drawings from Orchard Design. She tells Laurie that the drawings are very close to how the house will be; that Habitat for Humanity does not usually accommodate requests; and that it is only because of the child's disability that they are even considering it.

They will not consider making provisions for the future installation of a vertical lift. Richard says that doing so would be a lot of work and that a lift would require a space of at least ten-feet by ten-feet. He is wrong. I have plans for a raised bungalow with a vertical lift that is currently under construction by the London affiliate. The lift and its enclosure fit in a space that is four-feet-eight-inches by five-feet-three-inches (**2.29**). I have no proof of

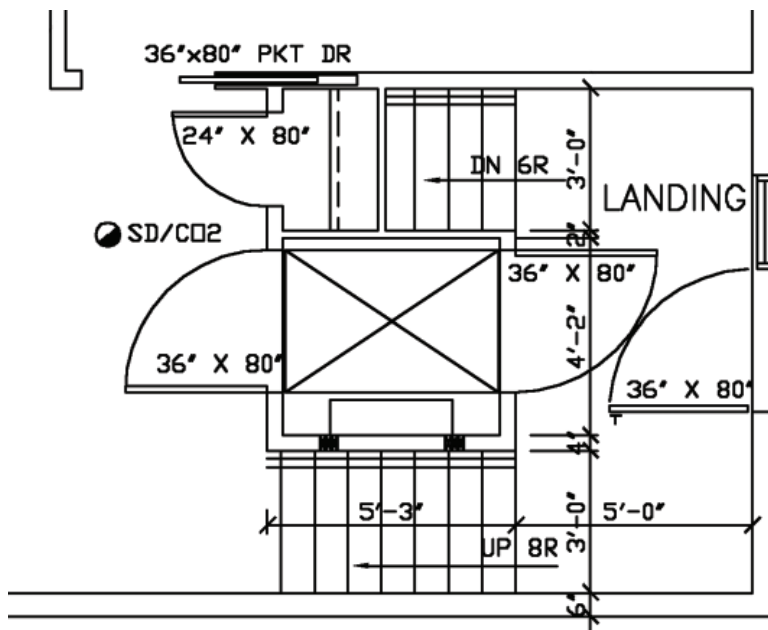

2.29 Partial upper floor plan of the raised bungalow under construction by the London affiliate showing a vertical lift.

this with me so I say nothing. Richard does offer to widen the basement stairs and reinforce its wall to allow for the installation of a stair lift. Laurie rejects this offer. She says that not only would it be difficult for Kevin to sit on the chair lift, but it would still require carrying his wheelchair down the stairs. Laurie shows us one of his two wheelchairs. It is electric and has a thick base. It looks heavy and it will only get larger as he grows older.

They will not provide a second washroom. They will rough-in the plumbing for a sink and a toilet in the basement. I show them a series of washroom layouts that I have drawn in an attempt to accommodate Kevin's needs (2.30). Each plan has greater access to the toilet, a transfer bench at the end of the bathtub, and a small closet for the storage of toileting equipment. The layouts go over well.

They will not provide additional space for a laundry area on the main floor. I mention that in my preliminary work with trying to adapt Orchard's design for panelization and to better accommodate the family's needs I have found that an area for laundry and the storage they require can be accommodated on the main floor within a similar footprint if one of the bedrooms is moved to the basement. Laurie says that their children would not like to be separated. Pat grants Laurie the choice between a laundry area on the main floor and all of the bedrooms on the main floor. Pat gives Laurie a copy of the main floor plan. She tells Laurie to discuss it with her husband and to give her their decision tomorrow morning. As Laurie begins to cry Pat tells her what a great opportunity this is for her and her family. Pat and Richard then stand up to leave. As I follow them out Pat suggests that we go to the affiliate's office to discuss things further.

At their office Pat tells me that they are making some concessions for this family because they need the sponsorship money from the Lions Club that goes with them. That answers my question as to why they took on the responsibility of housing this family. That the Lions Club sponsored this family because of their needs tells me that they intended to fund a house which accommodates their needs. I understand that sponsorships and donations help to finance the cost of the house at the time of construction and the cost of providing an interest free mortgage, however a family does have to pay for their house; the house is not a gift. I say none of this. The set of drawings from Orchard Design has made it clear that I first need to look after my own interests.

Pat expresses to me confusion over Terri's e-mails. I tell them that I was expecting us to meet with Bryan at Orchard Design to discuss cladding options and suddenly they are sending me a permit set for the house which does not incorporate the panelization and the family's needs. Pat says that they requested the plan from Orchard, because they want to have something that they can use

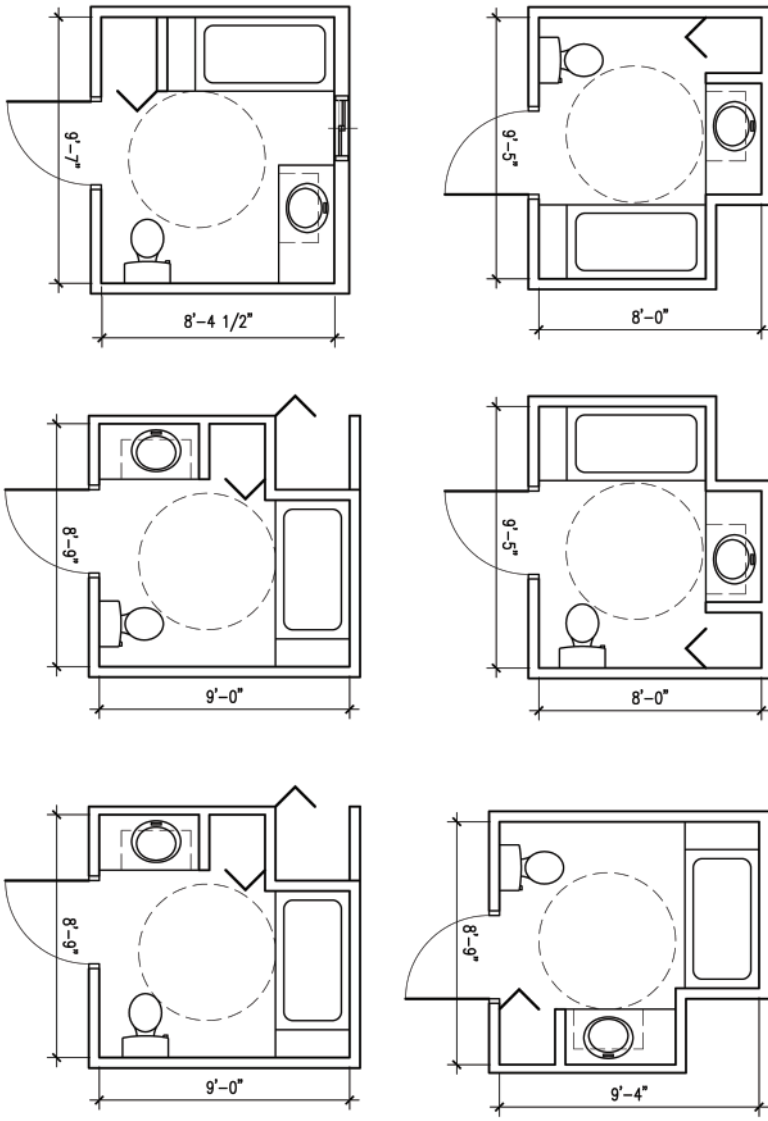

**2.30** Six of a series of washroom layouts designed to accommodate Kevin's needs.

again. She talks about having two sets of drawings in the end: one set that they can use to build the house conventionally; and one set that they can use to panelize the house. I say that the two need not be different, that the panelized design could be built conventionally. Pat tells me how important it is to them to make this house work for me in terms of the panelization, but that there is no point in making changes to the design until she hears from the family. She says that tomorrow she will e-mail the family's decision to both Richard and I.

We talk again about setting up a meeting with Bryan to discuss cladding options. Richard and Pat both want to use vinyl siding. I say that it would be difficult to use vinyl to preclad the panels because of how the vinyl is connected together and the small tolerances of its connections. Pat suggests that the siding on the front façade be installed on-site. She wants to maintain the switches from horizontal to vertical vinyl siding of Orchard's cladding design. She thinks that the city will like three almost identical houses better. I say that the detailing of the joints, which is inherent to the panelization, will provide an aesthetic that makes the changes in the siding unnecessary, and if combined with them will look too busy. Richard says that Bryan knows what we should be doing about the cladding. He wants him and I to meet with Bryan on Monday.

From an e-mail to Terri Meyer Boake, April 21, 2005:

If they live up to what they've said they'll do during the next couple of days then we should be able to get something done. I don't trust them. I'm just realizing that they are trying to do this project without really doing it - in terms of the design, in terms of the construction system, and in terms of precladding. In my world the prefabrication, the design, and the aesthetics all influence each other. In their world they want a vinyl sided house that looks exactly like every other habitat house, the work for which is done elsewhere by someone else who's concerns they can ignore.

Friday, April 22, 2005: It is late in the afternoon and I have heard nothing from Pat on the family's decision and nothing from Richard on a meeting with Bryan on Monday. I phone Pat. Her answering machine says that she will be out of the office until Monday. I phone Bryan. We arrange a meeting for ten o'clock Monday morning. I phone Richard. I tell him that we are meeting with Bryan on Monday. I ask him what the family's decision is. He says that the family dropped off a sketch of a floor plan for the house at their office and that he gave it to Bryan. He says that everything has changed, that everything is different.

Monday, April 25, 2005: Terri Meyer Boake and I meet with Richard Davison and Bryan Bruce at the office of Orchard Design.

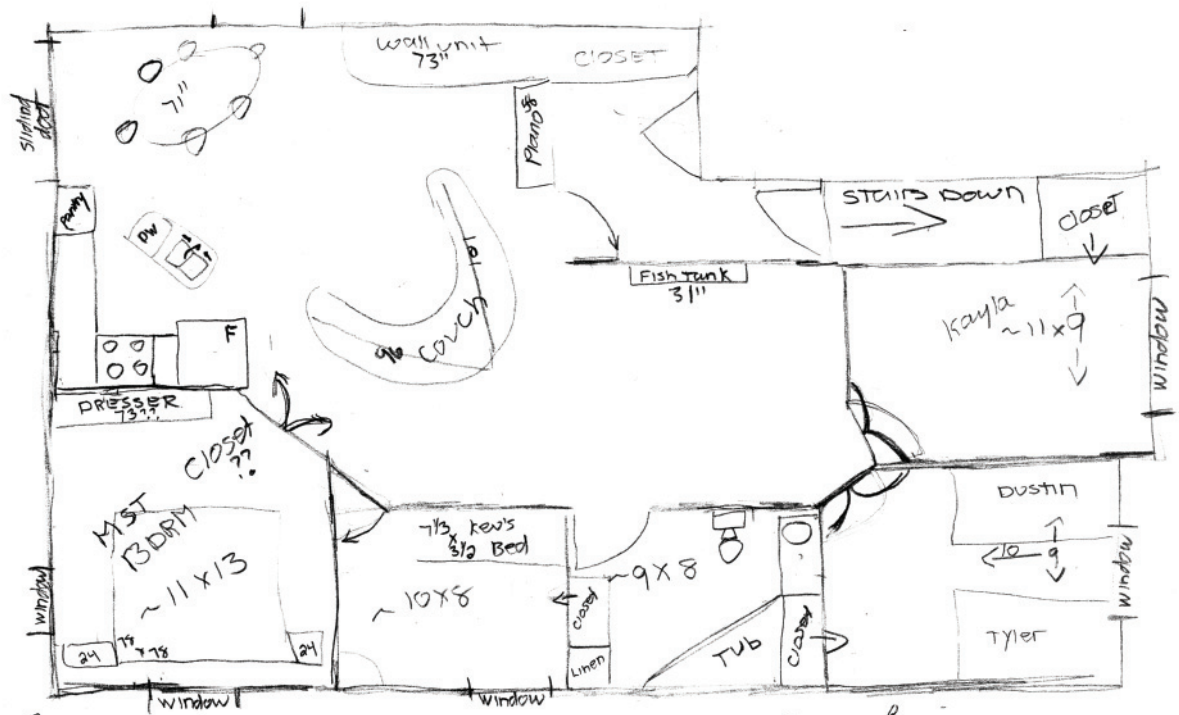

Issue  
 - Sight lines to see Keren while in kitchen

- 1st choice
- Laundry in bsm
- stairs standard width

2.31 The family's floor plan sketch.

From meeting notes I transcribed at Orchard Design, April 25, 2005:

Topics:

1. Accommodation of the special needs of the Baker family;
2. Cladding options;
3. Date for submission of permit drawings;
4. Product incorporation.

Discussion:

1. BB was in receipt of a sketch given to RD that the family had done in which they revised the floor plan of the house. BB provided CB with a copy of that sketch (2.31, page 79). Revisions to the sketch to make the plan workable were discussed. All agreed that the design sketch provided by the client created a lot of wasted and unuseable space. TMB noted that the Baker family's request for the visibility of the bedroom for their special needs child from the living areas of the house (specifically the kitchen) was the intent of their sketch, it was not achieved in their sketch, and that their sketch needed further development to achieve this. RD suggested that pocket doors be incorporated; between the master bedroom and the bedroom of the special needs child, at the entrance to the bedroom of the special needs child, and at the entrance to the bathroom. CB is to develop a working floor plan incorporating the family's needs and the prefabrication of the house.

2. CB discussed pre-finished siding options that would work with the panelization of the house. Vinyl siding was chosen to meet the low maintenance needs of the family. The vinyl siding is to be vertical board and batten to coordinate with the panelization. CB noted that the detailing of the joints for vinyl is not simple and would need to be developed. Different options for the panel joints were discussed. RD to forward information he has on siding accessories. CB is to contact **Royal Group Technologies** to discuss the use and detailing of their products in this application.

3. RD stated that he has met with a surveyor and is expecting to have a survey of the site complete next week. TMB noted that 30 students will need to begin prefabricating the house next Friday, so that the designs of the house would need to be finalized by then. BB indicated that he would need a few days time to finalize the permit set once the design is finalized. RD requested a plan and wall section of the final design as soon as possible to have the heat loss calculations redone. All agreed that it would be most expedient to have CB produce the building permit submission set given the tight time frame. She will send the set to BB for printing on their sheets as well as checking. This set will also be sent to RD to resubmit for mechanical heat loss takeoffs and design.

4. RD noted that the flooring for the house is to be laminate with vinyl tile in the bathroom. RD indicated that they are receiving a donation of windows, potentially from Bonneville. RD is to confirm company. CB is to acquire Bonneville product information.



## Royal Group Technologies

From the Royal Group Technologies Limited website:

Royal Group Technologies is a world leader in advanced polymer processing and design. As North America's largest pvc extruder we manufacture a complete line of high-quality, low maintenance building & home improvement products and materials including: custom profiles & extrusions, vinyl siding, roofing, decking, fencing, railing, columns, moulding & trim, window coverings, pipe & fittings and more.<sup>13</sup>

From the website of Royal Building Products, a member of the Royal Group of Companies:

For homeowners interested in an accent panel or in creatively exploring design options with vertical siding, Board & Batten is an excellent choice. Because of the vertical configuration, the panels make wall surfaces look higher. Board & Batten vertical panels are virtually maintenance-free and won't dent, peel, rust, flake or corrode, for a lifetime of beauty and performance.<sup>14</sup>

From the website of Royal Mouldings Limited, a member of the Royal Group of Companies:

Readi Finished® Trim Plank Adds Instant Value

Low maintenance, no rot, moisture proof Cellular PVC, adds a unique touch for any fascia, window, and siding trim application. Available Sizes: 1x2, 1x4, 1x6, 1x8, 1x10, 1x12. Variety of colors and textures available up to 18' lengths.<sup>15</sup>

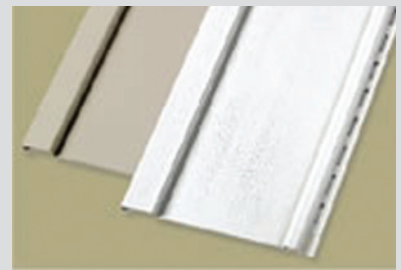

2.32 Board & Batten vertical vinyl siding.



2.33 Vinyl Trimplank boards.

## House Design

April 26, 2005: In the thirty-six hours since our meeting at Orchard Design I requested, but have not received, information from Bonneville Windows and Doors and Royal Group Technologies (again); I requested from Bryan Bruce any restrictions on the design of carports; I finished the course outline and the construction schedule for the undergraduate students who will be building the house; I offended two professors over scheduling conflicts between their respective courses and the construction schedule; and I made the first two attempts at developing the family's sketch into a workable floor plan.

My first attempt at the floor plan is close to the family's sketch (2.34). It includes many of the same wasted and unuseable spaces; it still lacks a closet in the master bedroom; and at 1420 square feet it is too large.

My second attempt at the floor plan is simply a downsizing of my first attempt (2.35, page 84). At 1220 square feet it is just below the affiliate's target area of 1250 square feet and it is even less useable. Although, the carport is four feet wider to accommodate the ramp from their van. In both attempts I have prepared the design for efficient panelization by making the length of every exterior wall divisible by two feet. Each exterior wall is also divided into panels, most of which are eight-feet wide. Neither attempt provides a line of sight from the kitchen into Kevin's bedroom.

The next morning I have a response from Bryan Bruce.

From an e-mail from Bryan Bruce, Wednesday, April 27, 2005:

There are no rules as to the size of carport, except as a minimum, it has to fit a parking space (2.9m x 5.5 m). It must also be within the setbacks. These lots are 45' x 100' and the set backs are 6.0m front, 7.5m rear and 1.2m sides. The house and carport must fit in that envelope.

Late the following day, due to a proficiency born largely of desperation, I have a workable floor plan for the house and carport which fits into that envelope (2.36, page 85). The design centres around the location of Kevin's bedroom (Bedroom 2). It is bordered on one side by his parents' bedroom and on the other side by the washroom. The unenclosed circulation space is wider outside Kevin's bedroom and the bathroom to ease maneuvering. There are similar spaces on both sides of the main entrance door. There is also a direct line of sight from the kitchen into Kevin's bedroom.

With this floor plan I have succeeded in amalgamating the family's needs with the constraints of the site, the generic design produced by Orchard Design, the target square footage dictated by the Habitat for Humanity affiliate, and my own requirements for

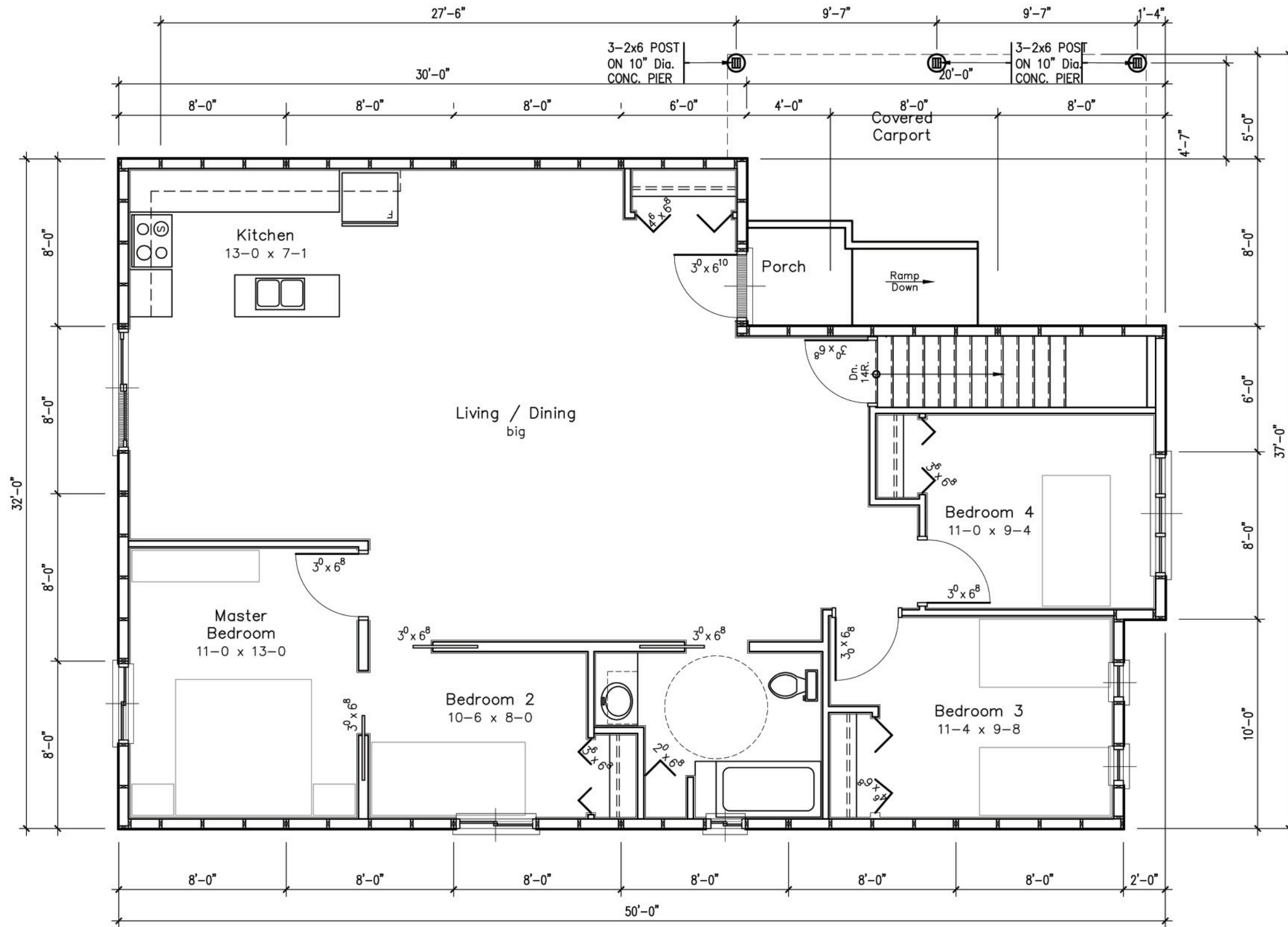

FROM BAKER FAMILY SKETCH  
1420 sf (TARGET ~1250 sf)

2.34 First floor plan attempt.

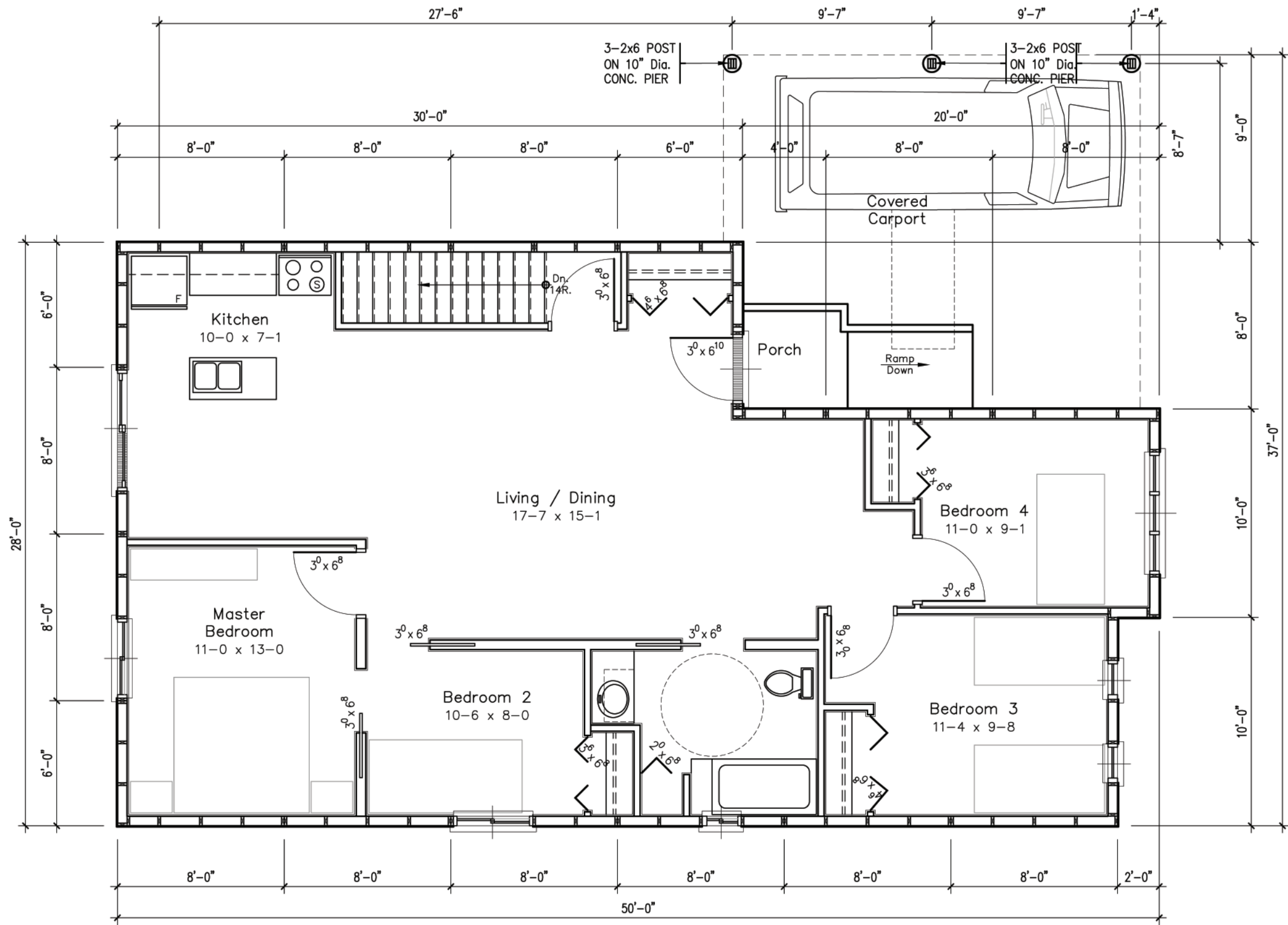

FROM BAKER FAMILY SKETCH  
1220 sf (TARGET ~1250 sf)

2.35 Second floor plan attempt.

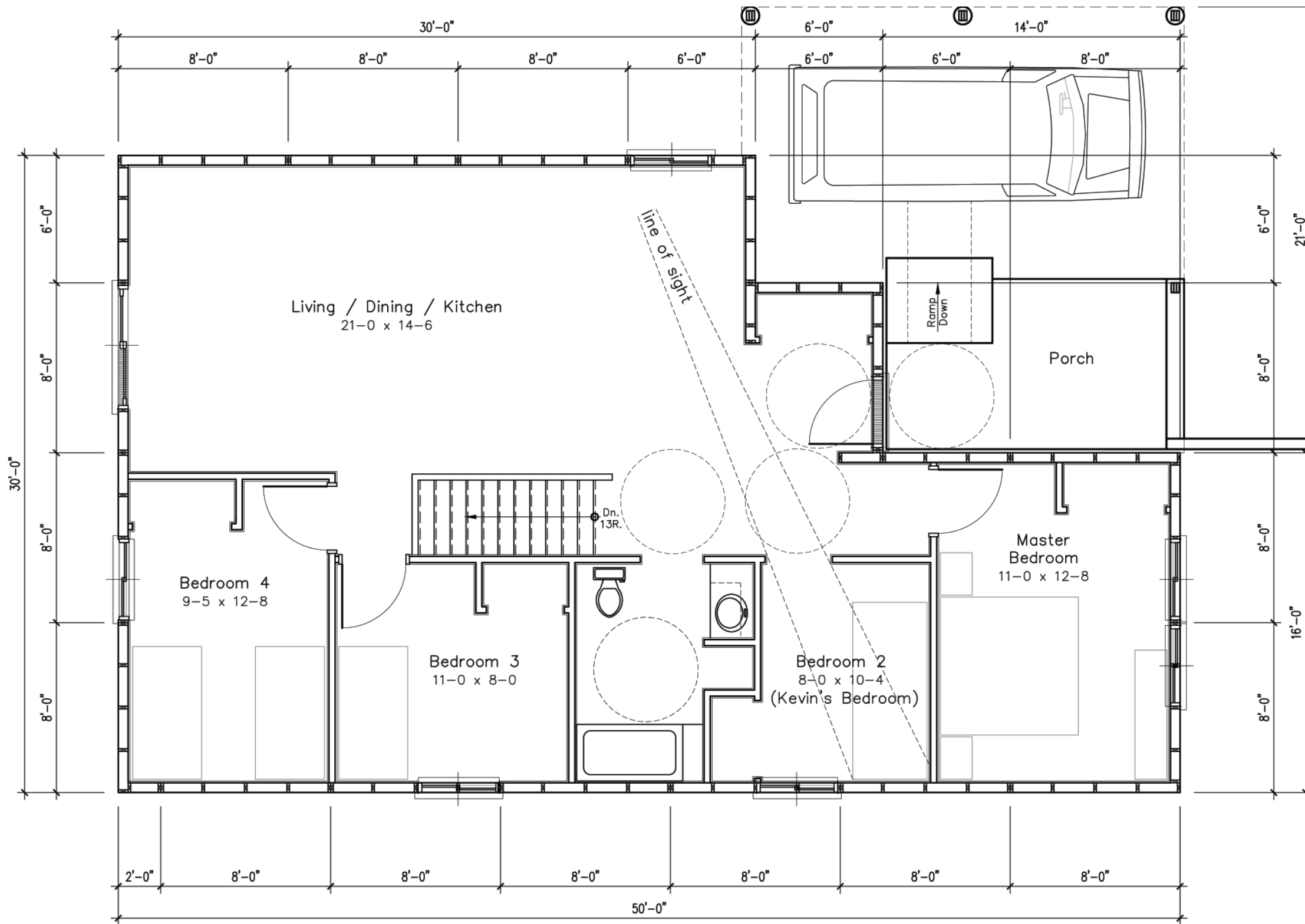

REDESIGN OF BAKER FAMILY SKETCH  
1268 sf (TARGET ~1250 sf)

2.36 A workable floor plan.

efficient panelization. At 1268 square feet the floor plan is over the target area of 1250 square feet; yet it is only two square feet larger than the plan by Orchard Design. Removing a few inches from the exterior envelope of the building, as is commonly done during the design process to force a plan into a limiting square footage, would sacrifice both the functionality of the plan — into which I struggled to fit both closets and stairs — and the efficiency of its construction. Building a seven-foot-eight-inch-wide wall panel not only uses as much material as an eight-foot-wide panel, it uses more labour.

It is Thursday night and I have a workable floor plan three days after I received the family's sketch.

From an e-mail from Richard Davison, Thursday, April 28, 2005:

With your construction starting next week I need a material list by Mon. In order to ensure delivery also would you e-mail me your ph #.

Friday, April 29, 2005: after a morning meeting with a group of professors over scheduling conflicts, I sit down with my new plan. I am intent on making sure that the panelization will work. I refine the layout of the exterior panels; I make all sections six or eight feet long. I ensure that one edge of every window is at a panel joint: I want to use the double stud that results where two panels join to satisfy the double stud required at the edge of a window. Then I consider further the efficient panelization of the interior partitions.

Friday night Laurie Baker calls me in a panic. Pat has told them that they will be able to change the floor plan, but Richard has told them that they will not be able to. I try to reassure her. I tell her that they will like the design. I tell her that I am meeting with Richard on Monday for him to review the floor plan and that I will meet with them afterwards to show it to them.

I spend the weekend hastily developing the other drawings for the permit set. A mistake in one part of the design can reverberate through the entire construction process. I must anticipate, and incorporate into the design, every effect that the prefabricated panels and the on-site construction will have on each other. First I prepare a basement plan, for which I determine the spacing of the floor joists and the size of the steel beam that supports them. Then I prepare a roof plan. It is sketchy on the roof line. I am unsure how to reconcile emulating the cottage roof design of the other two houses with the unskilled volunteers who will be constructing the roof. Next I prepare a wall section. It is sketchy on the cladding material. Last I draw the elevations. They are sketchy on the roof line and sketchy on the cladding. Things shift a little here and a little there, but there are no major changes to incorporate into the floor plan (2.37).

Sunday night, confident that I have failed to anticipate numerous

Facing Page: 2.37 The refined floor plan with an Orchard Design title block.

TOTAL FLOOR AREA = 1268 sq.ft.



These drawings are the sole ownership of Orchard Design Studio (ODS). Any reproduction of these drawings without written request to ODS is strictly prohibited.  
 ODS is not responsible for errors and omissions to these drawings. All construction shall conform to the Ontario Building Code Latest Edition. The Owner / Constructor must verify all dimensions, structural components and details and report any discrepancies to ODS prior to construction.

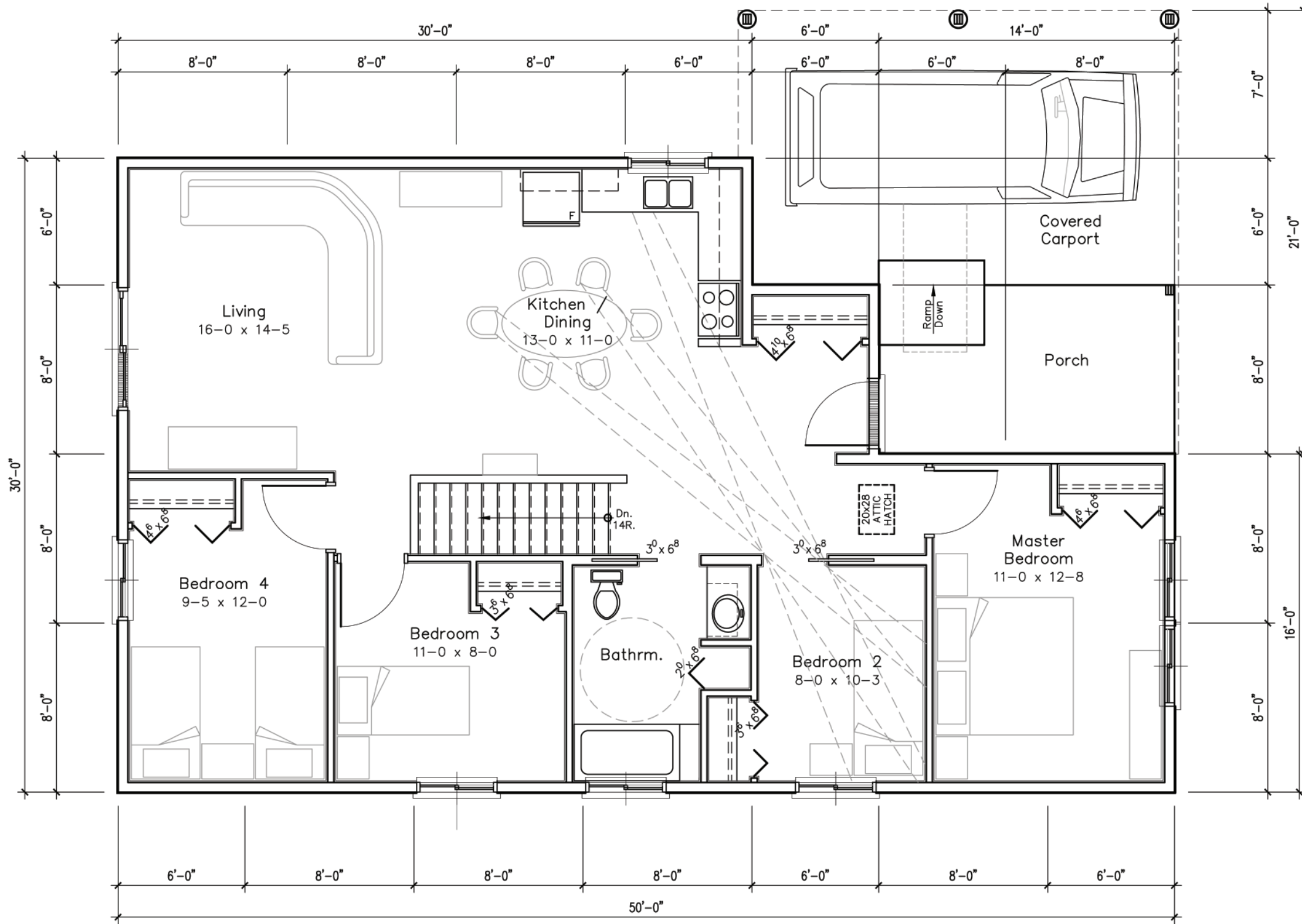

STATUS:	BUILDING PERMIT
PLOTTED:	5/02/2005 9:00 AM
SCALE:	3/16"=1'-0"
DWN BY:	CMB
DATE:	MAY 2005
REV.	

PROJECT: HABITAT FOR HUMANITY BARRIER FREE BUNGALOW  
 TITLE: MAIN FLOOR PLAN

SHEET No. 6 OF 12

**NOTE:**  
 PROVIDE BUILT-UP WOOD STUD POST EQUAL TO STUD DEPTH x WIDTH OF BEAM, AT BOTH ENDS OF STEEL or WOOD BEAM.

things, I do a take-off for the materials needed for the prefabrication of the wall panels. For a take-off you typically add an additional ten percent to the calculated amount that you need. I add twenty percent.

From an e-mail to Richard Davison, May 1, 2005:

Materials List:

48 sheets standard spruce sheathing (4'x8'x3/8")

150 pieces 2"x4"x92-5/8" precuts spruce K.D.

40 pieces 2"x4"x8' spruce K.D.

20 pieces 2"x4"x10' spruce K.D.

160 pieces 2"x6"x92-5/8" precuts spruce K.D.

90 pieces 2"x6"x8' spruce K.D.

10 pieces 2"x6"x10' spruce K.D.

20 pieces 2"x8"x8' spruce K.D.

30 pieces steel wind bracing

2 rolls 9'x150' Tyvek HomeWrap

1 box, Approx. 1500 pieces, #8 x 3" standard deck screws

50 lbs. 2" bright standard spiral nails

5 lbs. #8 x 2 1/2" wood screws

I also need some tarps to keep the materials and panels dry. I was thinking poly or that black builder's plastic which may be better because it will hide the material from view. What do you suggest? I need about 1000 s.f.

They can deliver to the southeast corner of the School of Architecture at 7 Melville Street South. Let me know when they are coming so I can meet the truck and block off the parking in the driveway.

Monday, May 2, 2005: First thing in the morning I call Richard. I ask when we can meet; he tells me to call him back at two o'clock to arrange a meeting. I tell him that the family wants to see the floor plan; he forbids me to show them.

From an e-mail from Amanda Scott, Meritech Engineering, May 2, 2005:

Bryan Bruce asked that I forward this topographic survey to you (2.38).

I will be doing the site grading plans for the houses, please let me know of any special requirements that you have. Also when it is complete, please forward me a digital copy of the house footprint. Thank-you.

The survey shows that the land is largely characterless and has a gradual slope towards the back of the lots. It does not affect the design of the house.

Via e-mail I send to both Terri and Bryan a drawing package for their review. The package contains the floor plan, the basement plan, the roof plan, and the wall section. Terri has already seen the floor plan, Bryan has not. Neither of them find any major problems with the design.

3:15 pm: I meet Richard at a Tim Hortons in Cambridge. He orders himself a coffee and he buys me a bottle of water. We sit

Facing Page: 2.38 The topographic survey provided by Meritech Engineering (not to scale).



PLAN SHOWING EXISTING ELEVATIONS OF  
 LOTS 34, 35 AND 36, REGISTERED PLAN 188  
 CITY OF CAMBRIDGE,  
 REGIONAL MUNICIPALITY OF WATERLOO  
 SCALE 1:300



MacDONALD-TAMBLYN SURVEYING LTD.

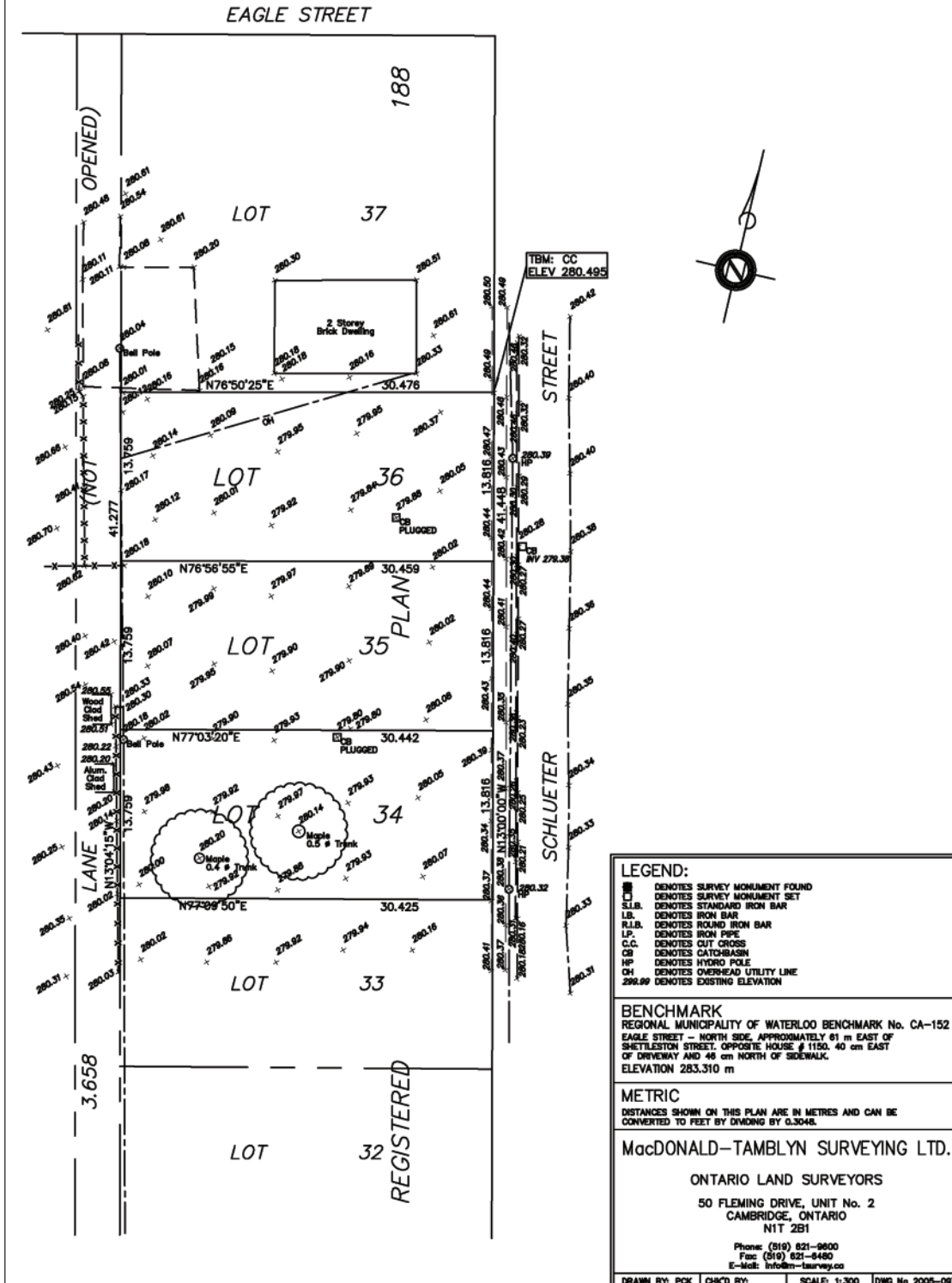

down and I show him the drawing package. He is surprised that the floor plan is different from the family's sketch. I tell him how their sketch made the floor plan too large and that it was difficult to accommodate the wheelchair accessibility in the space allowed. He says that he will have to see what the family thinks about it. I show him the lines of sight from the kitchen into Kevin's bedroom. He is disturbed by the articulation of the front wall of the house, because it will not look exactly the same as the other houses. I show him the ramp needed to get the wheelchair into their van. He says that he would not have bothered with that. I show him some sketches of the elevations (2.39). He says that the roof will be difficult to frame. I tell him that it is the same cottage style of roof as the design from Orchard Design and I ask him for suggestions to simplify it. He does not offer any. He says that he will have Pat meet with the family to show them the floor plan and to tell them that it is what they are getting. Then he stands up and he leaves.

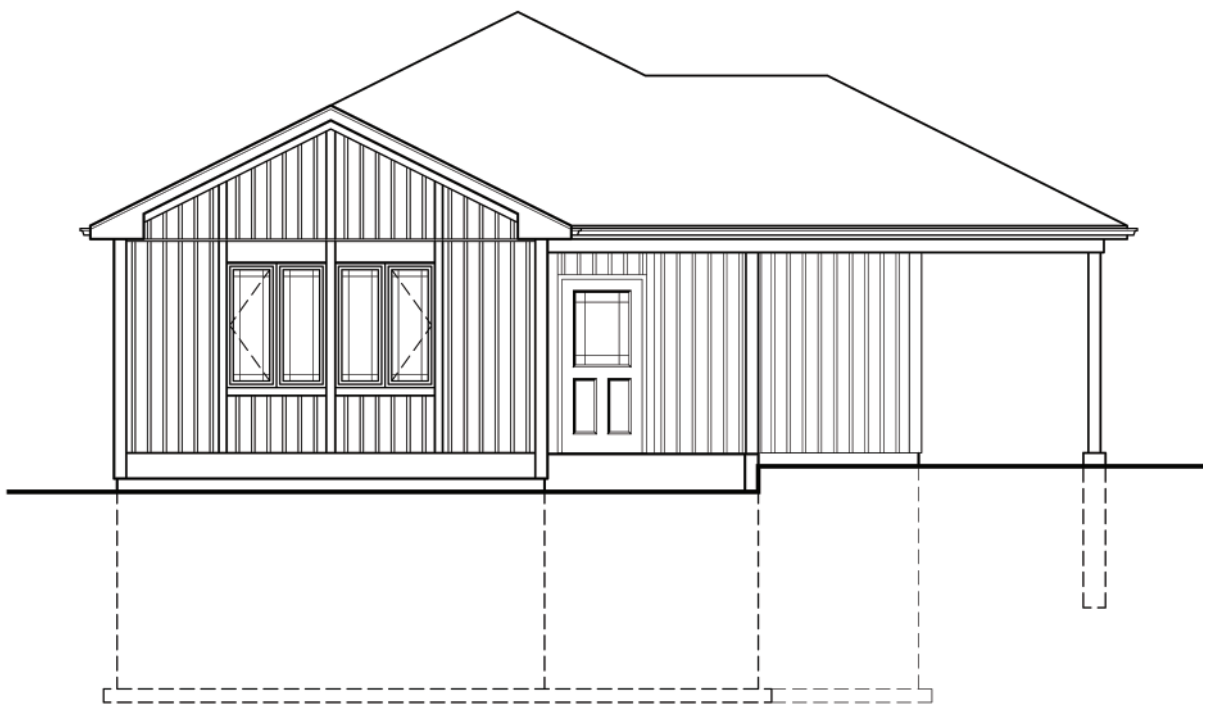

2.39 A sketch of the front elevation.

## In The Shop

Wednesday, May 4, 2005, 9:35 am: In twos and threes the students have entered the workshop. Each has picked up a course outline with a construction schedule (2.40). They now sit on stools and tabletops. These thirty-one undergraduate students and five graduate students will help me build the house. They are all waiting for me to say something intelligent and meaningful. What have I gotten myself into?

This meeting is an introduction to the course. We will build the first wall panels on Friday afternoon. Before then, myself and the other graduate students must construct the jigs to build the walls panels on. For both we need the materials to be delivered. I expected them yesterday.

After repeated calls to the affiliate's Materials Manager, Doug Freure, I was finally able to reach him yesterday afternoon. Doug did not return my calls because he thought that my phone number was strange. I explained to him that, while my cell phone has a Toronto number, I am in Cambridge and I am awaiting the delivery of the materials. He said that I should expect the delivery some time today.

I am also expecting a call from Royal Group Technologies. I have called them numerous times. Every time I call, no matter who I talk to, I am told that I need to talk to Rocco. Every time I call I leave a message for Rocco. He has not called me back. Yesterday one of my advisors, Dr. John Straube, gave me the contact information for Arjan Arenja, a "big shot at Royal." I am waiting for him to return my call.

Terri Meyer Boake arrives. I begin to address the class. "Um..." I tell them about Habitat for Humanity: its goals, its processes, and its faith based mission. I request religious tolerance from the students when dealing with the affiliate's staff and volunteers. "Um..." Terri tells them about the history of the School of Architecture's involvement with Habitat for Humanity. She then introduces my own work with Habitat for Humanity. "Um..." I tell them that prefabrication is supposed to decrease the time needed on-site and therefore increase the number of houses that Habitat for Humanity can build in their short build season. I tell them about my dissatisfaction with the organization and the quality of work that I found on Habitat for Humanity sites — whether prefabrication was involved or not. Then I tell them that it is our job to do better. "Um..." I go over their equipment list and I tell them not to wear clothes that they like, especially when we are on site. "Um..." John Debrone, the Shop Manager, gives a talk about the workshop rules and the proper use of a hammer. "Um..." I tell them that at the end of each class they must each fill out a task sheet by detailing and commenting on what tasks they performed that day. "Um..." A flat bed truck loaded with lumber drives slowly by the workshop

Facing Page: 2.40 The construction schedule from the course outline for ARCH 384: Habitat for Humanity.

## Schedule

An introductory session for all will be held the morning of Wednesday May 4<sup>th</sup>. During the prefabrication portion of the build, the class will be split into two sessions, A and B. Session A will attend class Wednesday mornings from 9:30 am to 1:30 pm. Session B will attend class Friday Afternoons from 1:30 pm to 5:30 pm.

Your full participation is essential to the successful construction of the house and a requirement for receiving a credit in this course. If you must be absent for a class, advance notification must be given to the course coordinator. This time must be made up on site the morning of Wednesday June 22<sup>nd</sup>.

Month	Day of the Week						
	Monday	Tuesday	Wednesday	Thursday	Friday	Saturday	Sunday
May	2	3	<b>4</b> Everyone 9:30 - 1:30 Workshop	5	<b>6</b> Session B 1:30 – 5:30 Workshop	7	8
	9	10	11 2B Field Trip	12	13 2B Field Trip	14	15
	16	17	<b>18</b> Session A 9:30 - 1:30 Workshop	19	<b>20</b> Session B 1:30 – 5:30 Workshop	21	22
	23	24	<b>25</b> Session A 9:30 - 1:30 Workshop	26	<b>27</b> Session B 1:30 – 5:30 Workshop	28	29
	30	31	<b>1</b> Session A 9:30 - 1:30 Workshop	2	<b>3</b> Session B 1:30 – 5:30 Workshop	4	5
June	6	7	<b>8</b> Session A 9:30 - 1:30 Workshop	9	<b>10</b> Session B 1:30 – 5:30 Workshop	11	12
	13	14	<b>15</b> Session A 9:30 - 1:30 Workshop	16	<b>17</b> Everyone 8:00 – 4:00 Site	<b>18</b> Everyone 8:00 – 4:00 Site	19
	20	21	<b>22</b> Make up 8:00 - 12:00 Site	<b>23</b> Everyone 8:00 - 4:00 Site	24 Toronto Co-op Interviews	<b>25</b> Everyone 8:00 - 4:00 Site	26

windows. I gratefully dismiss the class.

From an e-mail from Amanda Scott, Meritech Engineering, May 4, 2005:

I am working on the lot development plans for the Habitat houses on Schlueter Street. Bryan Bruce told me that you were working on the Barrier Free unit. I need the floor plans so that I can show a building envelope on the grading plans. Also please let me know of any special grading requirements you have.

From an e-mail to Amanda Scott, May 5, 2005:

Please find attached the floor plan for the barrier free bungalow (2.41). I have made some notes on it concerning the grading. We are trying to bring the grading up at the front of the house to minimize the ramp required. We are also going to pour a curb on the foundation wall the height of the subfloor (11 3/8") beneath the carport. Any suggestions that you may have would be appreciated.

I finally hear back from Royal Group Technologies. Arjan Arenja returns my call. He says that I need to talk to Rocco. I tell him that I have been trying to do so. He agrees to talk to Rocco and ask him to call me.

I do not hear from Rocco. I give up on Royal.

Friday, May 6, 2005, 2:32 pm: Within a cloud of saw dust, amongst the piercing squeal of a saw and the loud buzz of drills, I sit hunched over my laptop. I send three pages to the printer. On each is a basic elevation and a plan of a wall panel (2.42, page 96). Around me three groups of students — five undergraduates led by one graduate student — are assembling the first three wall panels for the house (2.43, page 97). These new pages show the next three wall panels to build.

They build on three new tabletop jigs (2.44, page 97). Constructed this morning by myself and the other graduate students, these jigs are simply a large flat surface of five-eighths-of-an-inch-thick plywood that is bordered with a low raised edge of two-by-fours. A grid of lines drawn with marker show the correct locations for studs, closet headers, and horizontal blocking.

The jigs are basic, the diagrams are basic, and the wall panels are basic. We are starting with the interior wall panels. Without the added layers of the exterior wall panels they are simpler to construct and mistakes are easier to fix. The construction of these first walls will test the utility of the jigs and the clarity of the diagrams. I hope to discover what in addition to the basics is needed for each.

This afternoon we began with the basics. I directed the class to practice driving screws into two-by-fours with a drill (2.45, page

Facing Page: 2.41 The floor plan with notes for grading.

TOTAL FLOOR AREA = 1268 sq.ft.



ORCHARD DESIGN STUDIO INCORPORATED (519) 620-047

These drawings are the sole ownership of Orchard Design Studio (ODS). Any reproduction of these drawings without written request to ODS is strictly prohibited.

ODS is not responsible for errors and omissions to these drawings. All construction shall conform to the Ontario Building Code Latest Edition. The Owner / Constructor must verify all dimensions, structural components and details and report any discrepancies to ODS prior to construction.

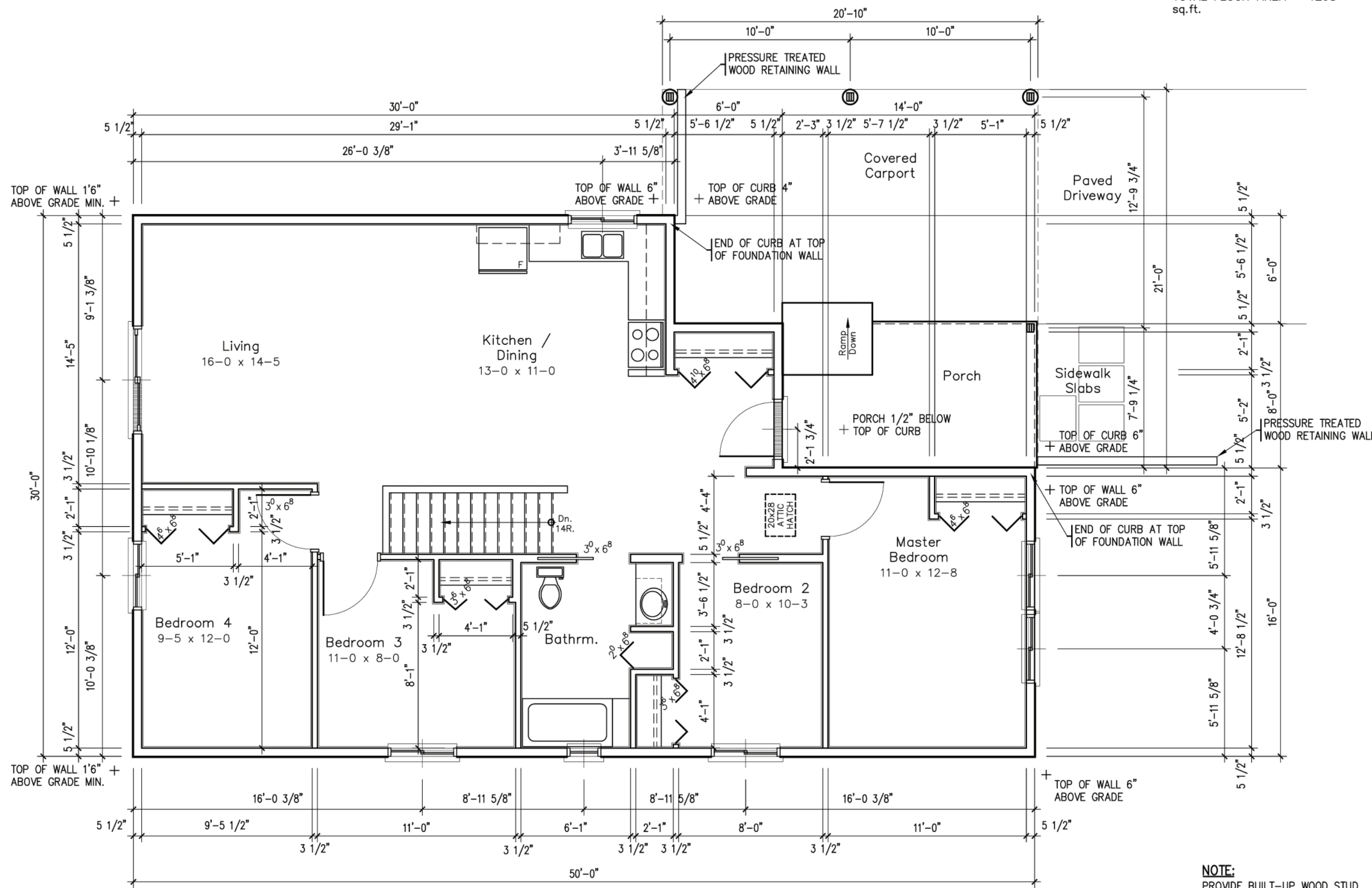

STATUS:	BUILDING PERMIT
PLOTTED:	5/05/2005 5:00 PM
SCALE:	3/16"=1'-0"
DWN BY:	CMB
DATE:	MAY 2005
REV.	

PROJECT: HABITAT FOR HUMANITY BARRIER FREE BUNGALOW

TITLE: MAIN FLOOR PLAN

SHEET No. 6 OF 12

**NOTE:**  
 PROVIDE BUILT-UP WOOD STUD POST EQUAL TO STUD DEPTH x WIDTH OF BEAM, AT BOTH ENDS OF STEEL or WOOD BEAM.

F2-6

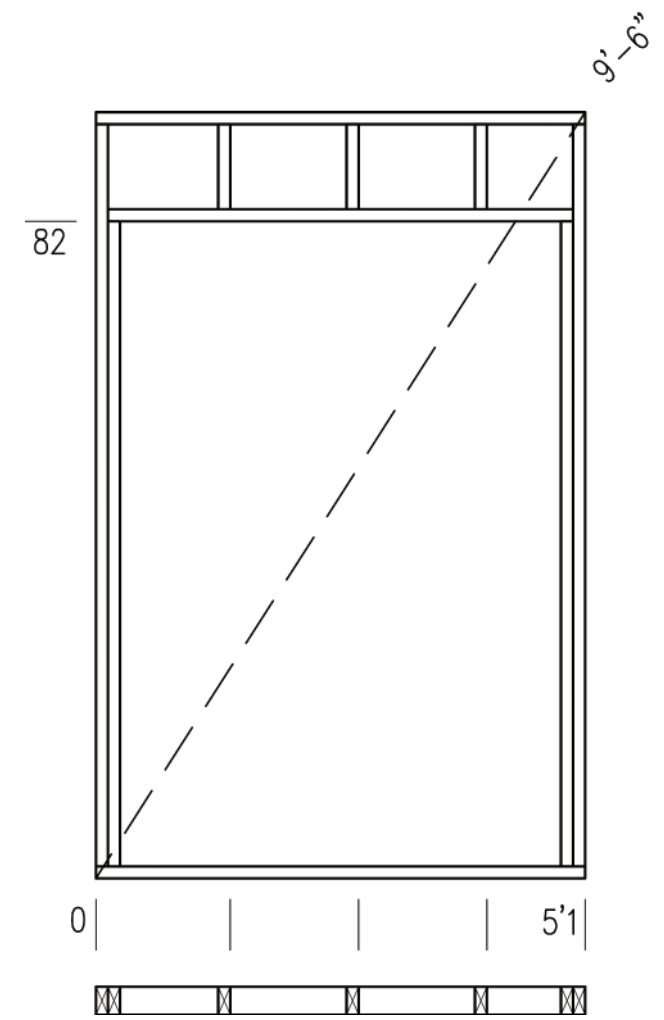

2.42 A basic elevation and plan of a wall panel.





Above: 2.43 Assembling interior wall panels.



Left: 2.44 A tabletop jig.



2.45 Practicing to drive screws into two-by-fours with a drill.

97). A couple of the graduate students scoffed at the idea; some of the undergraduates rolled their eyes. Then they tried to do it... and tried again... and again. Half an hour later, when I instructed them to start framing the first wall panels, some of those same students looked nervous. Despite knowing that the screws they were about to drive could easily be removed if they made a mistake, I was nervous.

From where I sit I watch them work: I watch them carry lumber in through the doors of the workshop from the piles outside; I watch them cut the lumber to length under the guidance of a graduate student that I have stationed at the saw; I watch them arrange the lumber on the jig to match the diagram that they have been given; I watch them check the crown on each length of lumber (2.46) and even rearrange the lumber to place the least warped studs at the edges of the panel; I watch them trying to drive the screws in properly; I watch them preparing to make the saw cut for the diagonal brace without first making sure that the wall panel is square!

“Square the wall.” I almost shout as I emerge from behind my laptop. They freeze. I approach. “Is the wall square?” I ask. They look at their graduate student leader. He looks from the wall panel to me and back again. Then he reaches for the tape measure on his belt.

I stand nearby as they measure the wall panel diagonally from corner to corner (2.47). The wall panel is not square. While they knock the panel into square with a hammer I check the assembly of their wall panel against its diagram. It looks correct. After they assemble the wall panel, and ensure that it is square, they are to use a chalk line to mark the location of the diagonal brace. Once the mark is made they are to call over the graduate student who is assigned to the circular saw to make a shallow cut along the mark (2.48). This saw cut will allow a T-shaped steel brace to be let in to the wood and lay flat against the face of the wall panel. After hammering the steel brace down to seat it in the saw cut, the students will punch holes in the steel with an awl (2.49, page 100). Through these holes they will hammer nails, driving two into each stud or plate. The diagonal steel brace will keep the unsheathed interior wall panels square during storage and transport. It will also resist warping in the studs it crosses. To resist warping in the studs along the edges of the wall panel — where accuracy is critical — horizontal blocks have already been installed in the first and last stud spaces (2.50, page 100).

Once a wall panel is properly braced it is time for the official inspection. That is my job. When summoned I bring with me a very large permanent marker and a measuring tape. I compare the wall panel to the diagram. I use my tape measure to confirm the accuracy of critical dimensions. I look for twisted studs and I run my hand across the joints to make sure that the studs are flush with the wall plates. I am quality control. If a wall panel does not pass



Above Left: **2.46** Looking down the length of a stud to find the crown.

Above: **2.47** Measuring the wall panel diagonally from corner to corner to ensure that it is square.

Left: **2.48** Making the saw cut for the diagonal steel brace.



**2.49** Using an awl to punch holes in the steel cross brace and hammering nails through the holes into the studs.

**2.50** Horizontal blocks in the stud spaces at the edges of the panel to resist warping.

**2.51** Marking a wall panel with its unique code.



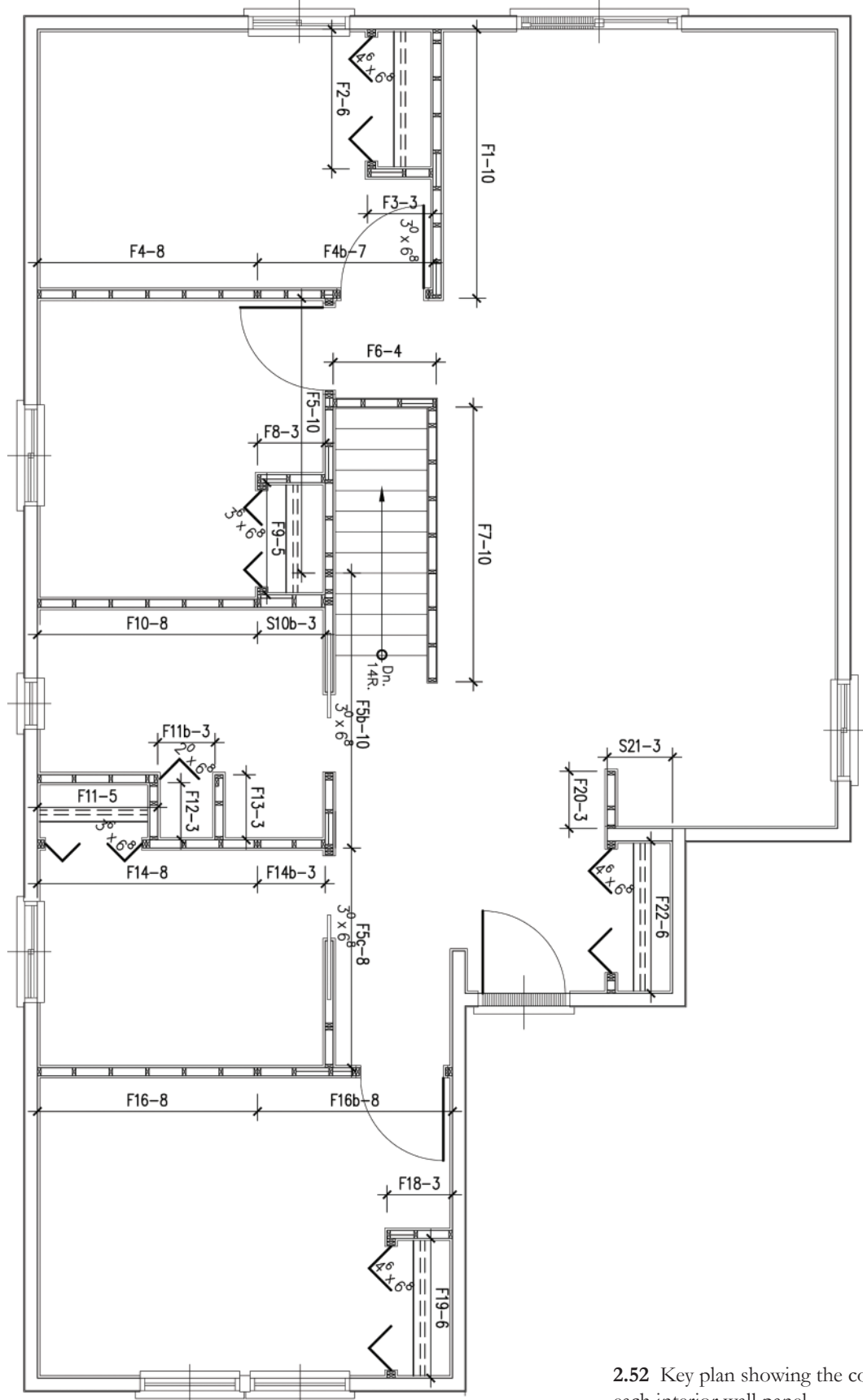

2.52 Key plan showing the code for each interior wall panel.

this inspection they go back to work. If it does pass I get out my very large permanent marker and on the bottom of the wall panel I write its unique code (2.51, page 100). Code F11-5, for example, means that the wall is made of two-by-fours (F); that it is wall panel number 11 and will be erected near panels 10 and 12; and that it is five feet long, or within a foot of five feet (5), and is stored in a stack of similar sized panels. After this code, which is also written on the diagram for each wall panel, I write an upwards pointing arrow and a 'B'. The 'B' indicates that this is the bottom edge of the panel. The arrow indicates which way around the panel needs to be erected. The arrow always points towards the wall panels' code as it is written on my key plan (2.52, page 101). After I mark the bottom edge of the panel I hand the marker to one of the students who copies the code onto the other three edges. No matter how a wall panel is stacked during storage its code will always be visible.

After a wall panel is branded it is lifted off of its jig and carried outside for storage in a stack and beneath a tarp (2.53).

By the end of the class each of the three groups are able to complete their two assigned wall panels.

Comments from student task sheets, May 6, 2005:

"During practice I was slightly discouraged because I was not very good at screwing. As I continued I became more confident and comfortable with the tools." - An undergraduate student.

"Perhaps drawings could have a cutting list and more dimensions. OK for architects, but 'normal' habitat volunteers might need more info." - A graduate student.

There will be no classes on Wednesday May 11th and Friday May 13th since most of the undergraduate students are away on a field trip. I have some breathing room to figure out: **how best to fit windows in the exterior wall panels**; a design for the jigs to build exterior wall panels on which can accommodate both standard panels and panels with various sized window openings; more informative and intuitive diagrams; and how exactly to install vinyl siding on the wall panels and have it connect together across the joints once the panels are installed.

From an e-mail to Terri Meyer Boake, May 13, 2005:

Please find attached the current state of the drawings. The plans show some grading notes which I sent to Meritech Engineering (and Orchard) last Thursday (2.41, page 95). Since then I have changed the window sizes... and I have changed some of the interior partitions, both of which are updated on your set. The elevations are drawn with the old window dimensions and using solid PVC exterior mouldings at the joints, around the windows, and over the rim board. I am unable to get the solid PVC. Royal has been no help. I am trying to figure out the siding. I will update the elevations when I know what it should look like.



2.53 Carrying a finished interior wall panel through the workshop.

### How Best to Fit Windows in the Exterior Wall Panels

From the CMHC Better Buildings Advanced Framing Case Study:

When the location of door and window openings in the exterior wall is coordinated with the modular stud spacing, it can reduce the use of cripples and jack studs... (2.54) Where it is possible to use window sizes that fit between the studs, no added cripples or lintels are required (2.55).<sup>16</sup>

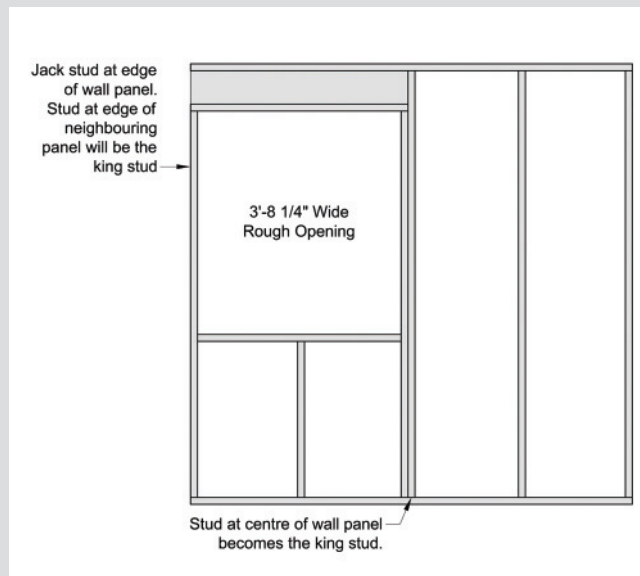

2.54 Typical eight-foot-long exterior wall panel with a window filling two stud spaces.

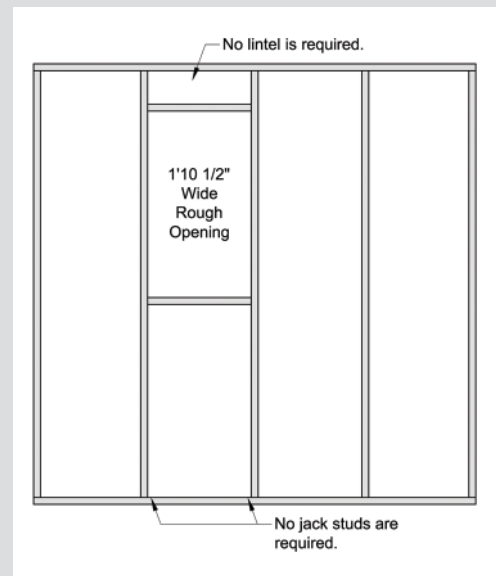

2.55 Typical eight-foot-long exterior wall panel with a window filling one stud space.

I sent Richard **the list of the windows** last weekend.

I have heard nothing from Richard, Bryan, or Meritech all week. Not communicating seems to be how everyone works, so I'm trying it out. I have plenty to do without talking to them. However, what makes me happy today, because I don't have to deal with them, also makes me nervous for the future.

I worked with the graduate students Wednesday on the jigs for the exterior walls. We are finishing that this afternoon...

Friday, May 13, 2005, 1:34 pm: I rush into the workshop. I shove a sheet of paper into the hands of the first graduate student I see. On the paper is a list of tasks that need to be done while I am gone. I am on my way to the local Gentek Building Products distributor in Kitchener. A man there named Doug is willing to give me samples of their vertical vinyl siding and vinyl trim. I am hoping to find a solution for the siding by experimenting with the samples. I need to go there now to have the samples for the weekend.

Doug and I stand before a two-storey-tall stack of shelves in Gentek's Kitchener warehouse. On the shelves sit open boxes with lengths of vinyl siding and trim sticking out of them. When I point up at one Doug climbs a ladder, cuts a piece off, and brings it back down to me. In my arms I hold a box that is quickly filling with odd shaped pieces of vinyl. My pockets are already stuffed with product and installation brochures.

My cell phone rings. "Hello?"

"Um, Hi Carolyn," It is one of the graduate students, "A man and a woman are here from Habitat."

I start to sweat. "What do they want?"

"I don't know. They were asking for you. I told them that you'd gone somewhere to see about the siding. They went to go get coffee. I thought you should know that they're here."

"Well I won't be back for at least another forty-five minutes. They have my phone number. They could have called... Anyway, thanks, I'll be back as soon as I can."

Richard and Janice are in the workshop when I return. They are disappointed that there are no walls being built today. I tell them that the undergraduate students are away. Richard wants a copy of the elevation drawings. He is going to have the heat loss and heat gain calculations done for the house over the weekend so that he can apply for a building permit next week. He is lucky that I have a draft of the elevations with me; I printed a set this morning to refer to while I work on the siding (**2.56**). As I release the pages from their binder I ask him if he has the grading plan for the permit application. He says that he was at the engineers' office today and



## The List of the Windows

From an e-mail to Richard Davison, May 8, 2005:

Window Sizes:

- 1 of 3'6-1/2"w x 4'8"h Casement, left side fixed, right side hinged on the right
- 1 of 3'6-1/2"w x 4'8"h Casement, right side fixed, left side hinged on the left
- 1 of 1'9-1/2"w x 3'4"h Casement hinged on the right
- 1 of 3'7-1/4"w x 3'4"h Slider
- 3 of 3'7-1/4"w x 4'0"h Slider
- 1 of 70-7/8"w x 81-7/8"h Sliding glass door (A Bonneville standard size)

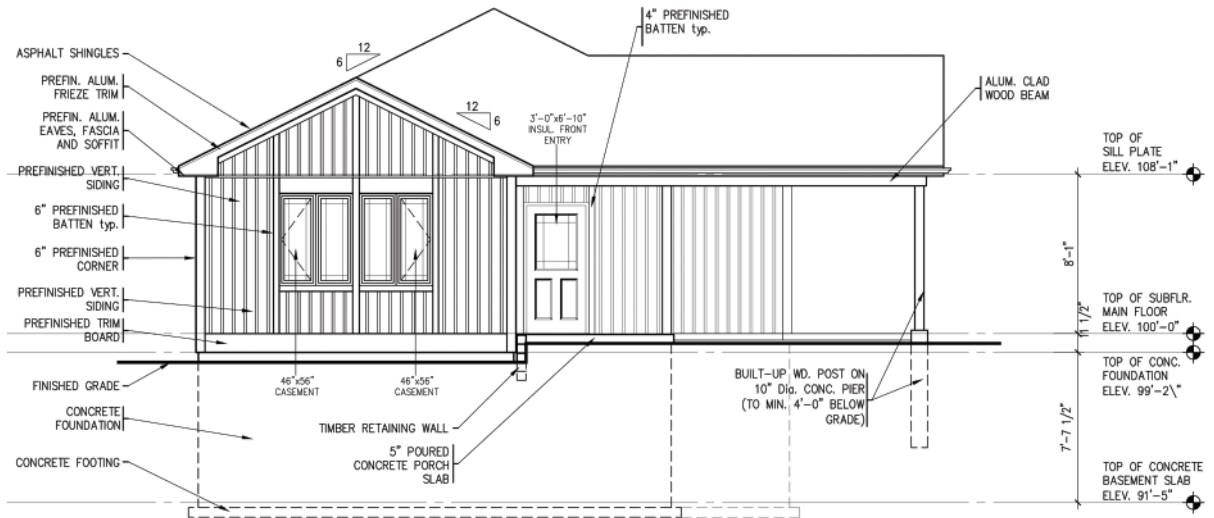

2.56 Current draft of the front elevation.

that they have not done any work on the grading. As I hand him the drawings I tell him that I am still working on the siding and that I have not yet revised the drawings to show the exact sizes of the windows. He says that the drawings are good enough for the calculations. They turn to leave. I suggest that they might try calling ahead next time, especially if they want copies of the drawings.

In my absence the graduate students have completed the three jigs for the exterior wall panels (2.57). Like those for the interior wall panels, the bases of these jigs are made of five-eighths-of-an-inch-thick plywood supported on a frame of two-by-fours. These jigs, however, do not have a raised edge around their perimeter; instead they have a series of blocks attached to their surface. Studs, plates and sills are placed against these blocks; lintels sit on top of these blocks (2.58). No measuring is required to assemble a wall panel and no measuring mistakes can be made. The three jigs are not identical. Each is built to accommodate a different height of window.

Sunday, May 15, 2005, 2:00 pm: I have a solution for the siding. The wall panels will be almost completely covered with board and batten style siding panels. The siding panels will sit between two lengths of J trim which will cover their cut ends. The first siding panel on each wall panel will have its 'batten' removed before it is secured beneath an undersill trim that will run the full height of the wall panel (2.59). The last siding panel on each wall panel will be left out until after the wall panels are erected (2.60, page 108).

On-site the joint between the erected panels will be covered by a three-and-a-half-inch-wide window surround trim which locks into the undersill trim on one side of the joint and is nailed to the wall panel on the other side of the joint (2.61, page 108). Finally the last siding panel will be slid into the deep groove of the window surround trim (2.62) and locked onto the second last siding panel (2.63, page 108).

The siding solution relies on the use of the window surround trim: it is the key to covering the joints between the panels; it is also used beside windows and beneath the windows (2.64, page 109); and the wider five-inch width is used to help cover the perimeter of the floor deck that will be exposed below the preclad wall panels (2.65, page 109).

The solution is not simple. It uses eleven different vinyl siding profiles, one of which is in two different widths, two of which are in two different colours, and many of which are used in nonstandard ways.

Wednesday, May 18, 2005, 9:30 am: It is the second day of building wall panels in the workshop, but the first day for the second group of students. Once again we start by practicing to drive screws.

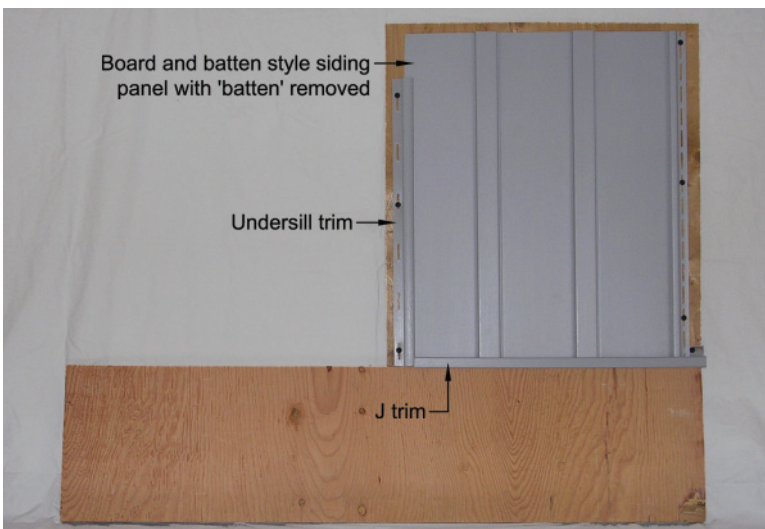
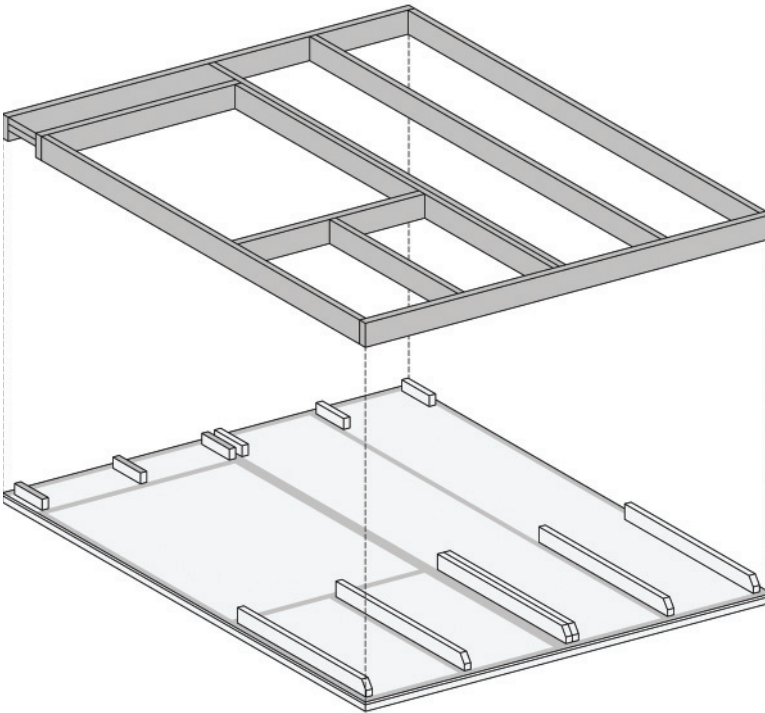

2.57 A jig for exterior wall panels.

2.58 Diagram showing how an exterior wall panel with a window fits into the jig.

2.59 The exterior wall panel is almost completely covered with board and batten style siding panels.

Above Right: **2.60** The last siding panel is not installed.

Right: **2.61** The joint between the panels is covered by a three-and-a-half-inch-wide window surround trim.

Below: **2.62** The deep groove of the window surround trim

Below Right: **2.63** The last siding panel is installed.

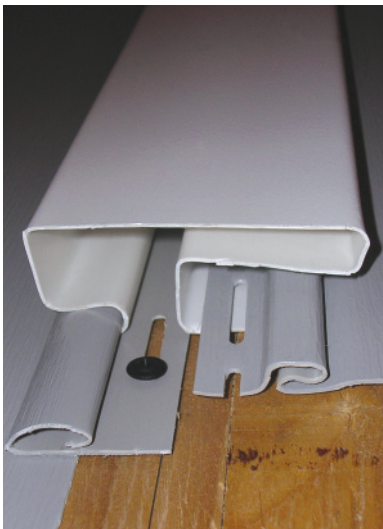

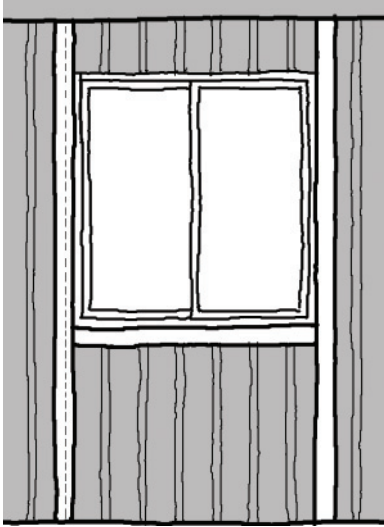

## F5-10

Complete

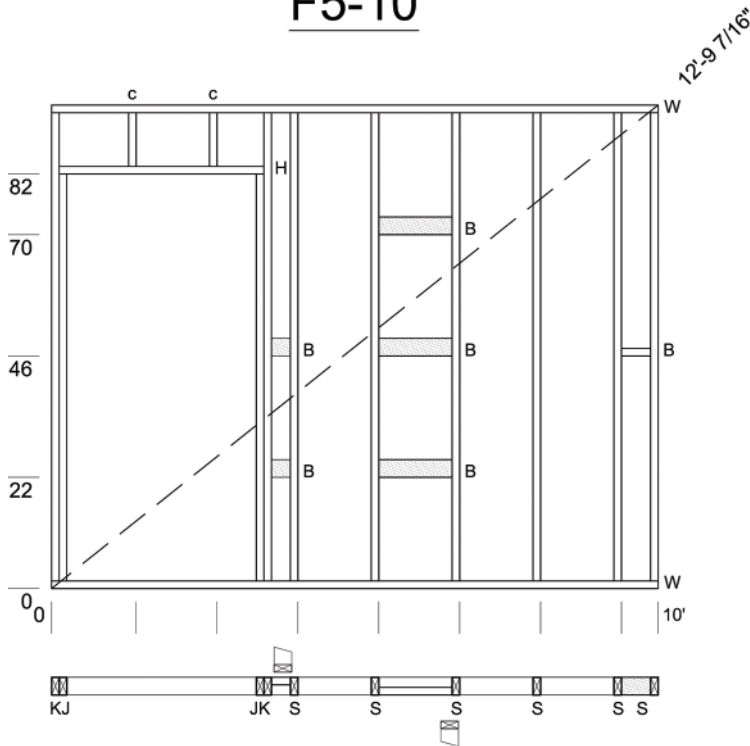

W	all Plates	2 of 10'
S	tuds	6 of 92 5/8"
K	ing Studs	2 of 92 5/8"
J	ack Studs	2 of 6'-8 1/2"
C	ripples	2 of 10 5/8"
H	header Plate	1 of 3'-4 1/2"
B	locking	2 of 3 3/4"
		3 of 1'-2 1/2"
		1 of 5 3/4"

Two screws at each perpendicular connection

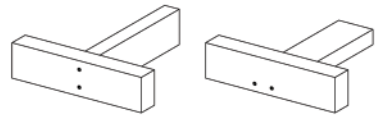

Screws staggered diagonally 16" apart at parallel connections

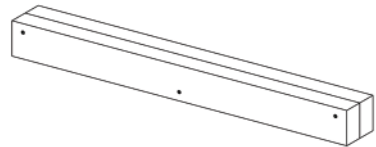

Top Left: **2.64** A sketch showing three-and-a-half-inch-wide window surround trim installed beside and beneath the windows.

Top Right: **2.65** Siding covering the perimeter of the floor deck below the preclad wall panels.

Above: **2.66** Interior wall panel diagram with a lumber list and connection details.

Once again we have six wall panels to build. This time, however, I have prepared better diagrams (2.66, page 109). Each now includes a lumber list and some connection details drawn in three dimensions. Unfortunately, I include the wrong information in one of the lumber lists (2.67). In this case the mistake is easily caught by the group before they start to build the wall panel.

All six wall panels are completed by the end of class (2.68).

Comments from student task sheets, May 18, 2005:

“It was really interesting learning how walls are physically constructed rather than conceptually. It also feels amazing to be able to contribute to building a house - that each stud and how it connects to the others makes a difference.” - An undergraduate student

“It would have been useful to have more explanation about how to do specific tasks. The introduction and practice with screws felt a bit unorganized. At one point, we were standing around not knowing what to do and we were told to help but given no specific instructions or even a general idea of what to do. I’ve never built a wall before so I’d like to learn properly and not build something crummy that will cause later problems...” - An undergraduate student

“Diagrams much clearer than last class. Cutting list/3d + more measurements helped the process.” - A graduate student

Friday, May 20, 2005, 1:30 pm: We are running out of lumber. I thought I ordered enough. Much of what we have left is warped. The lumber delivery contained many poor quality pieces, which have been left for last, and although the lumber has been stored under a tarp, some became wet and has dried again.

We scavenge to find every useable piece of wood. We carefully plan the cutting of the wood to not waste a scrap of the scraps. We push, pull, pry, and twist to force the wood into place (2.69).

Between wall panels I take each group aside for a short seminar. I talk with them about framing a house from a plan. I want them to think beyond the diagrams that they are given for the prefabrication. I want them to start to question, and to hopefully understand, why each piece of lumber is where it is. I want them to be able to connect what they design with how it is constructed.

Despite the extra effort required, and perhaps due to the reduced size of some of the wall panels (2.70, 2.71), each group is able to complete three wall panels by the end of class.

Comments from student task sheets, May 20, 2005:

“The work seemed to go a lot faster today than the other week. I think we’re starting to get a feel for the tools and also multitasking on a single object. The group dynamics were great, the organization good and the precision excellent. A very productive and enjoyable afternoon!” - An undergraduate student

“Today was very unorganized... The building of the walls had to be done over because of bad leadership and instruction. The group found it easier to figure out the diagrams on our own than to follow the leader

W all Plates	2 of <del>6'-4 1/2"</del> 5'6 1/2"
S tuds	13 of 92 5/8"
K ing Studs	2 of 92 5/8"
J ack Studs	2 of 6'-8 1/2"
C ripples	42 of 10 5/8"
H eader Plate	1 of <del>3'-4 1/2"</del> 4'10"
B locking	<del>3 of 3 3/4"</del>
	1 of <del>10 1/4"</del> 4"

Left: 2.67 A lumber list with the wrong information.  
 Below Left: 2.68 Two days of completed interior wall panels stored outside the workshop.



Left: 2.69 Pushing and pulling to force the wood into place.  
 Below Left: 2.70 A small interior wall panel.  
 Below: 2.71 A very small interior wall panel.



of the group. The first class was much more satisfying and more fun. The wood was of poor quality too.” - An undergraduate student

“We learned about framing a wall on site today and did exercises where we looked into details at different parts of the house, which was a good background to know, since prefabrication is such a different process.”  
- An undergraduate student

Tuesday, May 24, 2005, 9:58 am: I leave a message on Richard’s cell phone requesting two-dozen lengths of two-by-four lumber be delivered before 9:30 tomorrow morning. I then call Doug Freure and request the same thing. He says that he has to talk to Richard about it and that he will call me back.

3:27 pm: Richard returns my call. He says that he will talk to Doug and someone will call me back.

4:40 pm: One of the graduate students, Mark Cichy, e-mails me a rendering of the house. He worked for sixteen hours to create the image for me. I e-mail it to my advisors Terri Meyer Boake, Mike Elmitt, and John Straube (2.72). I want to sell them on my solution for the siding.

Mostly the look is well received.

Wednesday, May 25, 2005, 9:22 am: I call Richard on his cell phone and I ask him if the lumber is going to be delivered. He says that I was to talk to Doug about it. I correct him. He suggests that I call Doug.

9:25 am: I call Doug and I request that he order the lumber from a local company where we can pick it up immediately. He says that they have an account at Home Depot and that he will place the order with them and then call me back.

I need a truck. The two people I know with pick-up trucks are not at school. I check the parking lot. There is only Rick Haldenby’s mini-van.

9:30 am: The students are gathering to start work. Rick Haldenby walks into the workshop. He is leading two people on a tour of the school. I do not have another option and he has just made it too easy to ask.

“Rick?” I interrupt; I have a large, nervous smile on my face.

“Yes, Carolyn.” He smiles back.

“Can I borrow your van?” He reaches into his pocket and tosses me his keys. I thank him and I give the keys to a graduate student, who leaves immediately for Home Depot.

9:44 Doug calls back to say that he has ordered the material. I tell him that there is already someone on their way to pick it up.

Work has already begun. Two groups are framing the only two interior wall panels that need to be built with two-by-six lumber. The third group is removing two-by-four lumber from the underside





2.72 A rendering of the house by Mark Cichy.

of their jig and will reuse it to frame a wall panel. By the end of class each group must frame two interior wall panels and their first exterior wall panel.

The new lumber arrives; it is much better quality. The students assemble their second interior wall panels quickly.

Immediately after finishing their last interior wall panel each group replaces their jig with one for the exterior wall panels. The students then gather around their graduate student leader. I have given each graduate student a four page package of diagrams, which illustrate how to assemble a typical eight-foot-wide exterior wall panel (2.73-2.76).

What these three-dimensional diagrams show — that the flat diagrams for the interior wall panels do not — is the order of assembly. The first of the two framing pages shows the joining together of the lumber around the perimeter of the wall panel (2.73). The second framing page shows the installation of the intermediary studs (2.74). The separation of the framing into two distinct steps is the first instruction that the students ignore.

They gather the lumber for the entire wall panel and they lay it all out on the jig. Since there is no raised edge on these jigs the lumber around the perimeter tends to fall off if the intermediary studs are installed before the lumber around the perimeter is joined together (2.77, page 117). They quickly become grateful for their steel-toed boots.

Despite this, the assembly of the framing goes well (2.78, 2.79, page 117). There are the usual questions about which way the wood should bow. As with the interior wall panels, I have them bow the plates towards the inside of the panel so that the studs can push the plates straight. Unlike the interior wall panels, I have them bow the studs at the edge of the panels outwards. It will be much easier to push these studs straight while nailing the sheathing down, then to try to pull them outwards.

The squaring of the wall panels goes well (2.80, page 117) — when they remember to do so. They are quicker to complain that the sheathing is not square than to remember that they did not square the wall panel.

The sheathing of the wall panels goes well (2.81-2.84, page 118) — after they read the note on the diagram that places the slight overhang of the plywood along the bottom edge of the panel (2.75, page 116). It goes even better once they concede that it is easier to adjust the alignment of the plywood when you drive the first few nails only halfway down.

The wrapping of the wall panels in Tyvek goes well (2.85, 2.86, page 119) — once I show them how to fold the corners (2.87, 2.88, page 119). I failed to diagram these details.

Taking the completed wall panels outside does not go well. After the awkward tasks of prying a wall panel off of its jig and

### 8' Exterior Wall Panel - Framing

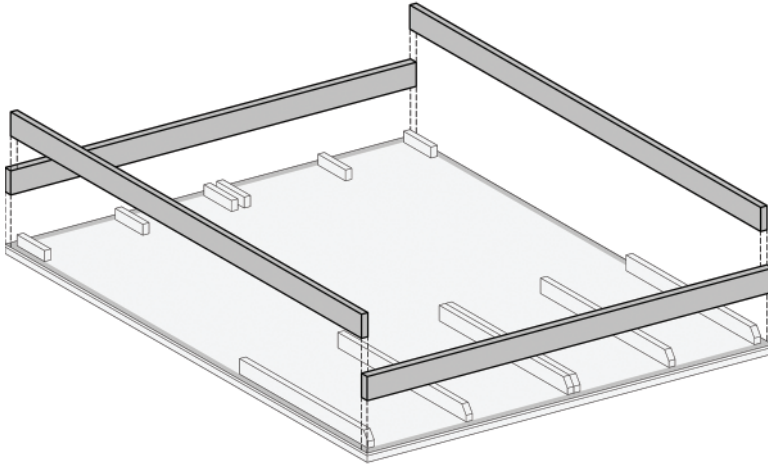

### 8' Exterior Wall Panel - Framing

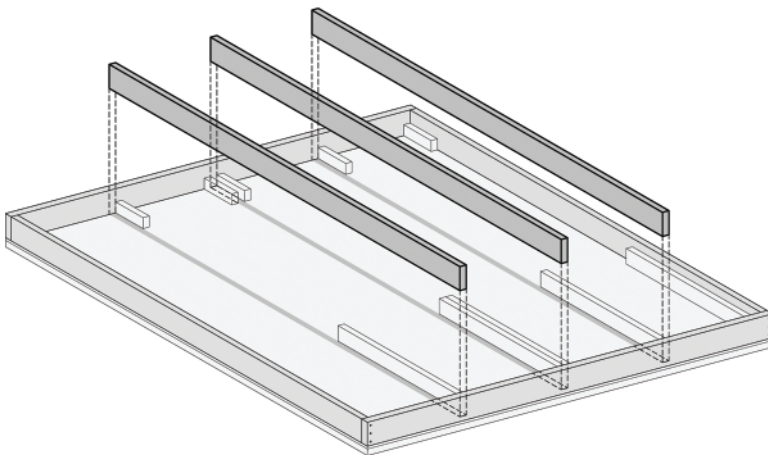

2.73 Framing diagram showing the creation of a square frame around the perimeter of the wall panel.

2.74 Framing diagram showing the installation of the intermediary studs.

### 8' Exterior Wall Panel - Sheathing

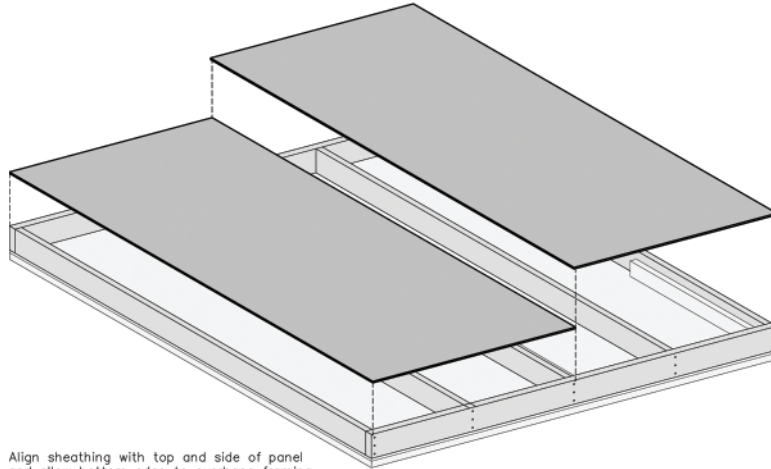

### 8' Exterior Wall Panel - Weather Protective Barrier

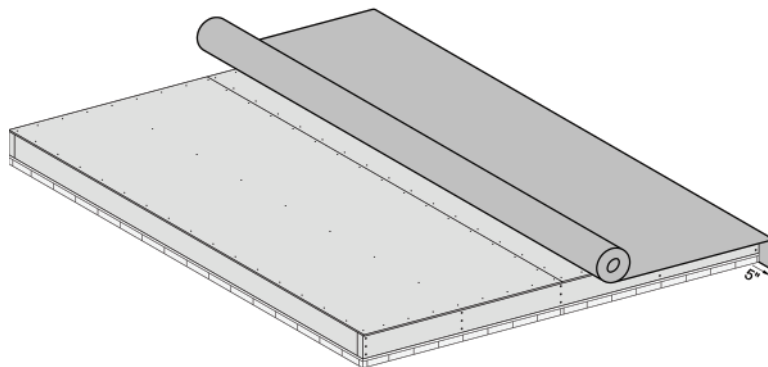

2.75 Diagram showing the installation of the sheathing.

2.76 Diagram showing the installation of the weather protective barrier.





Top Left: **2.77** Catching a wall plate as it falls off the jig.

Top Right: **2.78** Assembling the framing for the first exterior wall panels.

Above Left: **2.79** Screwing together the framing around the perimeter of the wall panel.

Above Right: **2.80** Measuring to ensure that the wall panel is square.



Above: 2.81-2.84 Installing the plywood sheathing.

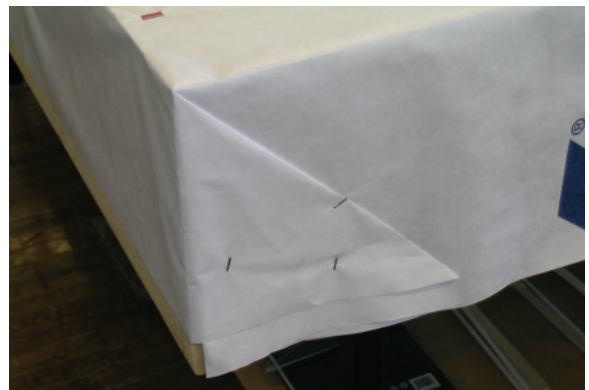

Top Left: **2.85** Rolling out the Tyvek.

Top Right: **2.86** Stapling the Tyvek down.

Above Left: **2.87** Folding the Tyvek at the corner of the panel.

Above Right: **2.88** A finished corner.

then completing the stapling of the Tyvek (2.89, 2.90), there is the even more awkward task of trying to carry the eight-foot-square wall panel through the workshop. There is not enough room to carry the wall panel flat (2.91) and the door out of the workshop is not large enough unless the wall panel is carried through at an angle (2.92). Once outside, the wall panels are easier to carry (2.93), but there is confusion around storing the wall panels. On the exposed framing along the bottom edge of each wall panel I have written that panel's code. The panels must be stored on edge and with the code showing. They have a surprisingly large amount of difficulty orienting their wall panels correctly for storage (2.94).

Although they keep me on my toes, I think that the construction of the first three exterior wall panels goes well.

Comments from student task sheets, May 25, 2005:

"The drawings are clearer this class; especially the 3D axo of the different steps of how to assemble the exterior wall. The jig itself was bending, which made us think all our wood was bowed at first, but we made sure everything was flush and square, with accuracy and care."  
- An undergraduate student

"We worked at a really good pace even though we encountered some funny pieces of wood. The jigs proved to be very efficient. Nevertheless, each piece of wood is unique and requires specific attention." - An undergraduate student

"My group was extremely tired this morning and consequently took many repeated prompts for each step that should have been evident. Required patience.

"Great diagrams (except maybe the detail of the staple on the Tyvek - confusing without notes)" - A graduate student

From an e-mail from Amanda Scott, May 26, 2005:

I am still working on the grading plans and I am having some difficulties with the barrier free house. It looks like I need a large ramp. Please send me your elevation plans so that I can confirm my top of foundation versus first floor elevation. Also please tell me if I can reduce the driveway width to 2.9m.

From an e-mail to Amanda Scott, May 27, 2005:

Please find elevations attached. I have also attached a draft set of details that concern the foundations and their relationship to grade (2.95-2.98, pages 122-123). Note that the porch is now shown sloped to allow rain water to run off towards the front.

It is my understanding that if the driveway width is reduced to 2.9 meters that there would have to be an additional pedestrian path to the street. We would like to avoid this. What is the need to reduce the width?

I am available to meet early next week if necessary.





Above Left: **2.89** Lifting a wall panel off its jig.

Above Right: **2.90** Completing the stapling of the Tyvek along the interior edge of a wall panel.

Left: **2.91** Carrying a wall panel through the workshop.



Left: **2.92** Carrying a wall panel at an angle out through the door of the workshop.

Below Left: **2.93** Carrying a wall panel flat outside the workshop.

Below: **2.94** Confusion over the correct orientation of the wall panels for storage causes delays.



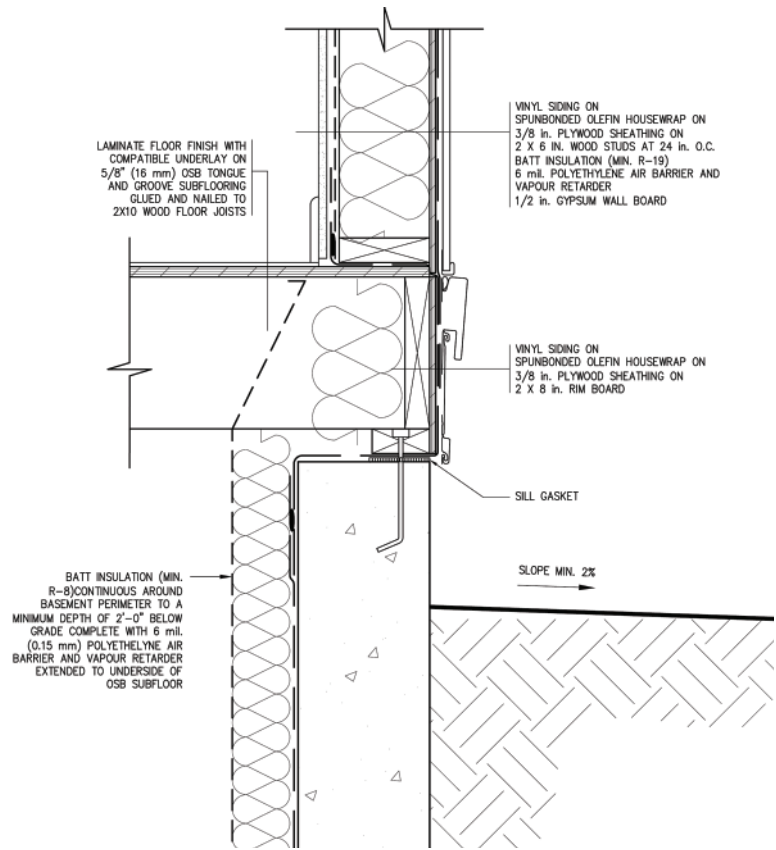
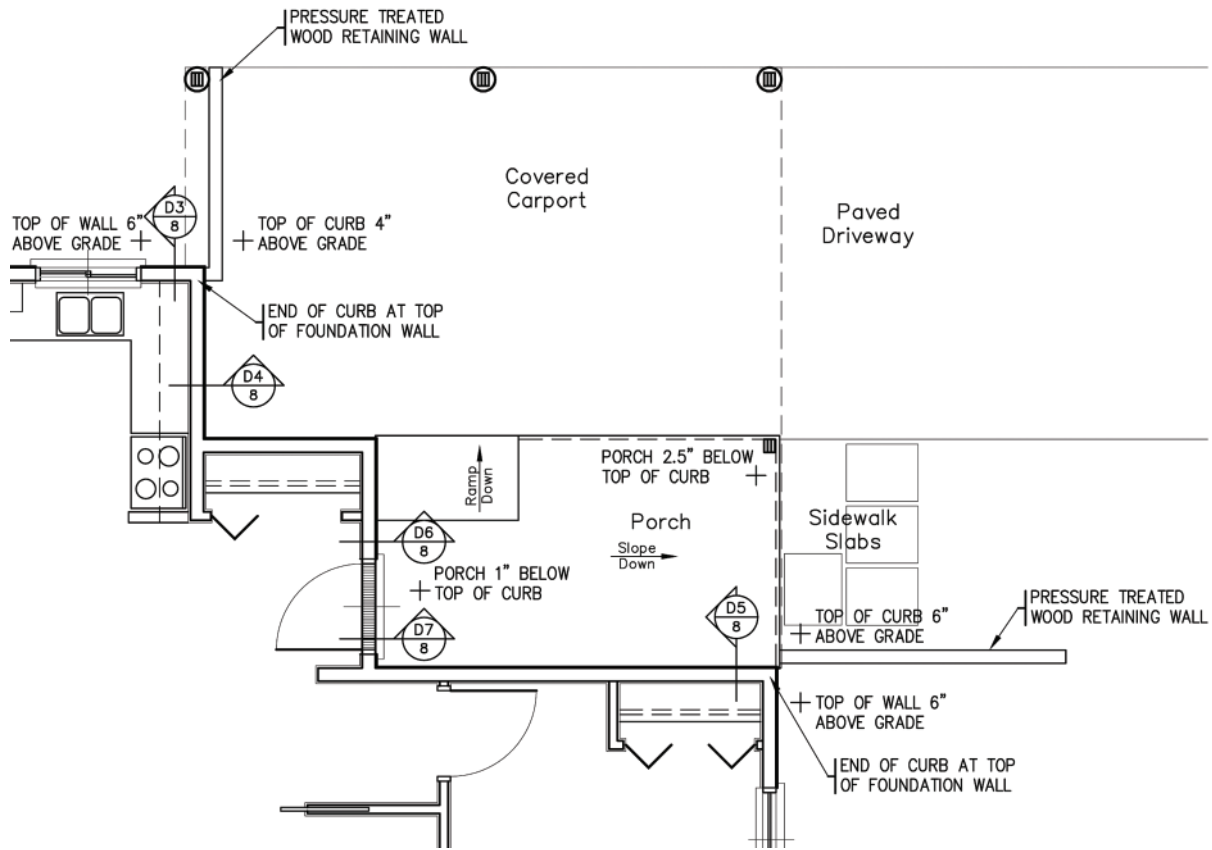

2.95 Key plan showing the grading information and the locations of the detail sections.

2.96 Detail D3: Typical Foundation Detail.

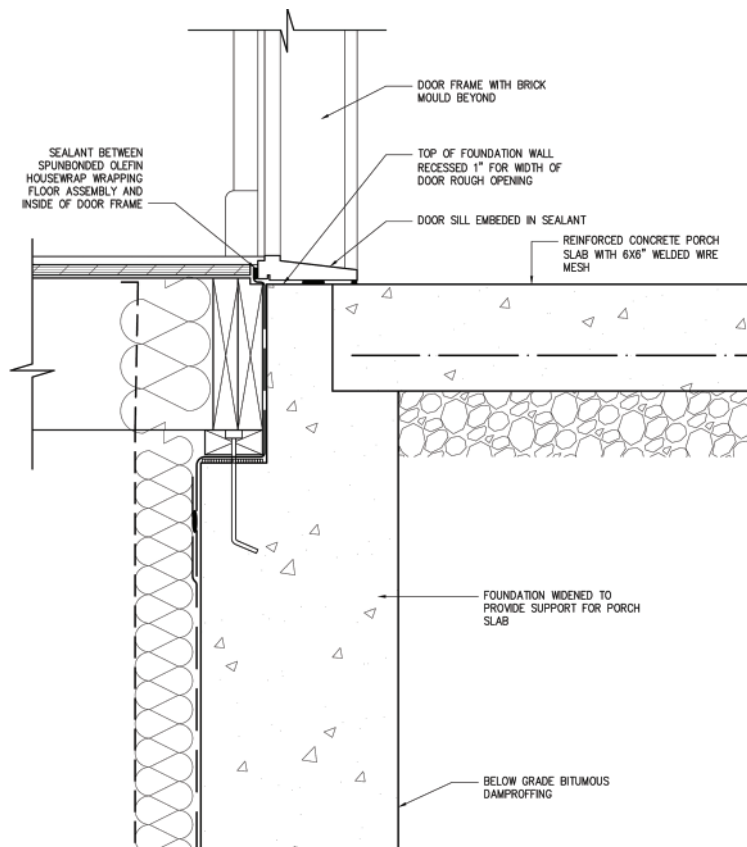
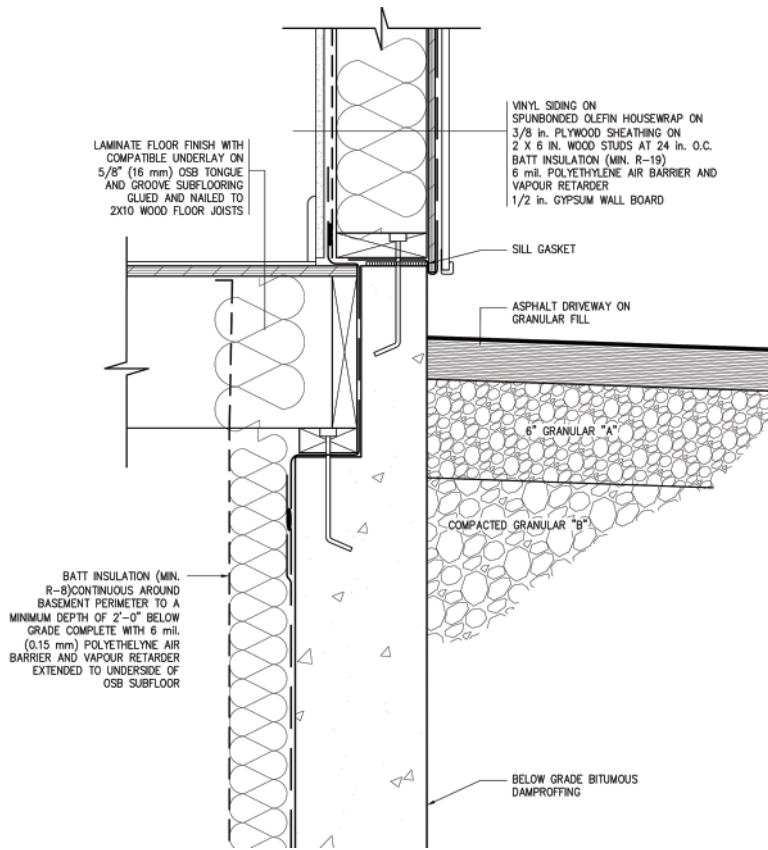

2.97 Detail D4: Foundation Detail at Driveway.

2.98 Detail D7: Porch Detail at Entrance

From an e-mail to Richard Davison, May 27, 2005:

Siding:

10 pieces - 5" Window and Door Surround, Snow White, 20' lengths  
12 pieces - 3.5" Window and Door Surround, Snow White, 20' lengths  
40 pieces - Surround Starter, Snow White, 12' lengths  
17 pieces - Board and Batten, Snow White, 10' lengths  
323 pieces - Board and Batten, Dover Grey, 10' lengths  
6 pieces - 3" Outside Corner, Snow White, 10' lengths  
15 pieces - 3" Deluxe Starter Strip, Neutral, 12' lengths  
15 pieces - Undersill, Dover Grey, 12' lengths  
5 pieces - Drip Cap, Snow White, 12' lengths  
40 pieces - 1/2" J-Trim, Dover Grey, 12' lengths

Soffits:

18 pieces - Fairweather Soffit 12" centre vented, Snow White, 12' lengths  
42 pieces - Fairweather Soffit 12" vented, Snow White, 12' lengths  
32 pieces - 1/2" J-Trim, Snow White, 12' lengths

Fascia:

22 pieces - 6" Fascia Regular Grade No Rib, Dover Grey, 9'-10" lengths  
1 roll - Flat Stock, Dover Grey, 24"x50' (to cover the beams)

We'll need some eavestrough and downspouts in the Dover Grey. Please advise me if there is anything you require from me to acquire those.

Friday, May 27, 2005, 4:35 pm: The students are building exterior wall panels in the workshop, but I am not there. I am driving to Toronto. I have left early to attend a wedding. I am not happy.

I did not prepare diagrams for today's wall panels; I did not have time to. I gave written instructions instead. For each wall panel I gave a short description (**2.99**). I expected this — when combined with the package of diagrams for a typical eight-foot-wide exterior wall panel and a plan of the house showing the location of the exterior wall panels (**2.100**, page 126) — to be sufficient. It was not.

I had asked the graduate students to arrive an hour early today so that we could alter the jigs. I neglected to make accommodations for wall panels with horizontal blocking in the design of the jigs. We had to cut spaces for this horizontal blocking out of the raised blocks on the jigs (**2.101**, **2.102**, page 127). We also had to correct one of the jigs because one of its raised blocks was placed incorrectly. One of the graduate students who helped to construct that jig insisted on placing blame for the error. I said that I just wanted it fixed. He was adamant that the diagrams for the jigs were wrong. I said that it did not matter. He would not let it go. Finally, I told him that I had already checked the diagrams, that they are correct, and that we could check them if he wanted, or he could stop arguing and fix the problem. He fixed the problem.

The graduate students had arrived late; they did not think that

BB4-8

8' panel

right stud inset 6" (plates 7'6")

overhang sheathing 5.5" from inset stud  
(cut 1/2" off sheathing)

2-1x8 ply.  
2-8' (2x6)

5-Pee (2x6)

tyres to be left loose on overhanging  
sheathing side & to project past  
edge of sheathing 5" (typ.)

EC1-6

6' panel 2-6' (from Pee (4x4))  
blocking in first stud space



6-Pee.  
2-1x8 Ply.

EHI-6

6' panel

right stud inset 6" (plates 5'6")

overhang sheathing 5.5" from inset stud  
(cut sheathing 1/2" shorter  
than 24" required)

2.99 A page of descriptions for three exterior wall panels with annotations made during construction.

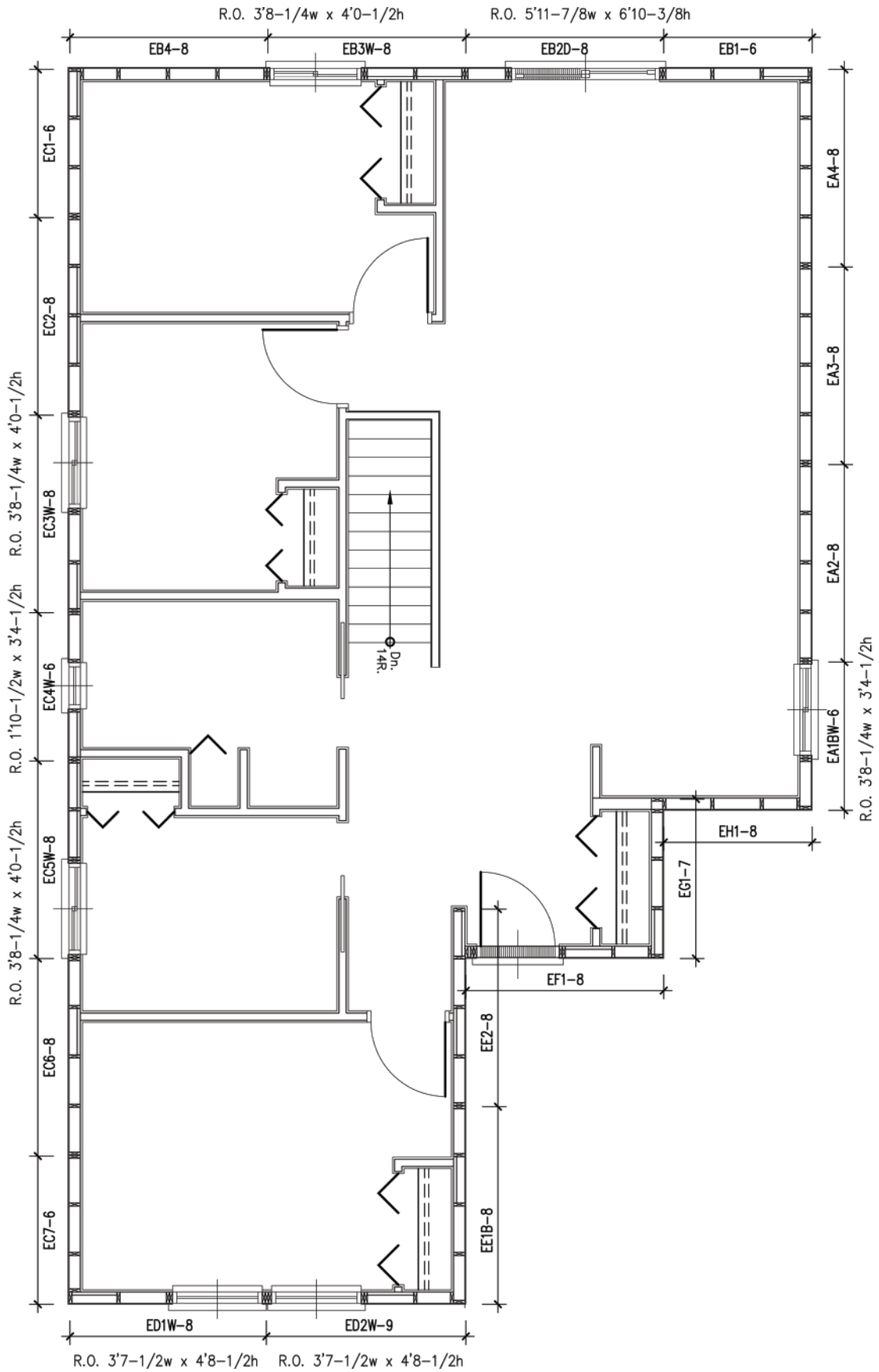



Facing Page: **2.100** Key plan showing the location of each exterior wall panel.

Above Left: **2.101** Cutting through a raised block on a jig.

Left: **2.102** New spaces cut out of the raised blocks on the jigs to accommodate wall panels with horizontal blocking.

the alterations would take an hour. The alterations took an hour. As a result there was no time for the briefing that I give them before each class. We were unable to discuss their written instructions.

When we started building they had a lot of questions. Many of their questions were about things that we have done before and things that they should know, such as the size of the blocking and which way the lumber should bow. Most of the rest of their questions could be answered by simply referring to the diagrams and the instructions in their hands. The more imminent my departure became, the greater these questions disturbed me.

I was not happy when I had to leave them. They do not listen to what I tell them, they do not read the written instructions that I give them, they do not look at the diagrams that I give them, and they do not remember what they have done before.

Comments from student task sheets, May 27, 2005:

“Today was disorganized from the start. We didn’t have diagrams (which would work for a task they were familiar with but not for the first time on exterior walls)...

“Wood was warped and the 2x6’s weren’t 5 1/2” high. Some were 1/4” off. Jig 1 was off and caused major aggravation. We had to place our wall on the floor to square using force of 1 1/2 groups to align with plywood (2.103).” - A graduate student

“Surprisingly the written instructions were enough for me without the 3D. The standard 3D drawings were useful to explain the principles to the group.” - A graduate student

“The sheathing on one of the walls was a little bit longer at one corner. Therefore we needed to trim it off using a planing tool (2.104).” - An undergraduate student

From an e-mail to Richard Davison, May 29, 2005:

Gentek has changed their window surround to use undersill as the starter, so the 40 pieces of surround starter requested should be: 40 pieces, Undersill, Snow White, 12’ lengths

Please advise me of the expected delivery of the siding.

We are hoping to start framing the walls with the windows in them and install some windows starting 9:00 am Wednesday morning. To assist with the window installation we will be needing:

- 1 bundle of shim shingles

We will also be needing:

- 15 lbs. 1 1/4 in. roofing nails

- 3 rolls of tyvek tape

- 2 tubes exterior acrylic latex caulk (for use between the siding and the windows)

Wednesday, June 1, 2005, 9:15 am: I gather the graduate students around one of the jigs to brief them before class begins. Today, in addition to the package of diagrams for a typical eight-foot-wide exterior wall panel and a plan of the house, I give them each two





2.103 Sheathing an exterior wall panel on the floor of the workshop.

2.104 Using a hand plane to trim the sheathing at the edge of an exterior wall panel..

new two-dimensional diagrams of the wall panels they are to build (2.105) and two pages of connection details (2.106, 2.107, page 133). We are to build the first exterior wall panels that have openings for windows. I start the briefing with wood selection.

From a video recording, June 1, 2005:

Me: "If the wood is kinked don't use it. Cut it and use it for blocking."

Keith: "That's what happened with Natalie on her two walls. I finally figured it out. The two walls she had, the top plate on the one was kinked and the bottom plate on the other one was kinked... The last foot and a half of both pieces of wood that she had shifted a quarter of an inch. So when she tried to put her walls to square it would never square up, because you could never take that kink out. We could only do the second one on the floor and five of us wedged it against that table. We finally got the kink out."

Me: "Talk to them about which way the wood should bow. They should be putting it in the jig. You're not putting it in the jig. They are putting it in the jig, they are looking at the wood, figuring out where it's crowned, where it's bowed, and figuring out how to use the blocks to their advantage. Then you start by screwing them together into a frame, right? Something that's going to keep it on the table so that when you put your intermediate studs in your plates don't fly off."

Heather: "So how do you do that if you have a lintel that's right at the edge?"

Me: "Right, so we're going to put the middle piece in instead. So make one corner, make the bottom corner, then do one in the middle. What we did with Natalie's because it was sliding off the table is we put a temporary screw in here." I point to one of the blocks near the perimeter of the jig. "Unfortunately, we sunk it all the way in and we couldn't see it so we Tyveked it, stapled it and then we tried to lift the panel up and it was stuck to the jig. Always, when you temporarily attach to something, leave it out like half an inch..."

"So you've got your wood and you've bowed it the right way, right? I mean they've bowed it the right way."

Mark: "Yes, which I constantly remind them of."

Me: "Then they can go and get your lintel cut and your blocking cut while you're screwing in the rest of the frame, right? And then you've got your two people who are going to screw your lintel together, right?"

Mark: "okay."

Me: "There's a lot of different tasks in this one. You're going to have to look at how you want to put your lintel in... because you want to screw down from your header plate into your jack studs... When you drop your header in if it's not flush at the top you may have to rock it a little. It's going to be sitting on the blocks, right? What you're going to want to do if it's not running flush is you're just going to want to push it down at this end to raise it up here and start screwing it in here. Just kind of like how you would straighten when your jack stud and king stud are off — you know, one's higher than the other. So you just want to, you know, start at one end and then you can start pulling it up to make it all flush on top. Do you get it?"

# EC3W-8

Complete

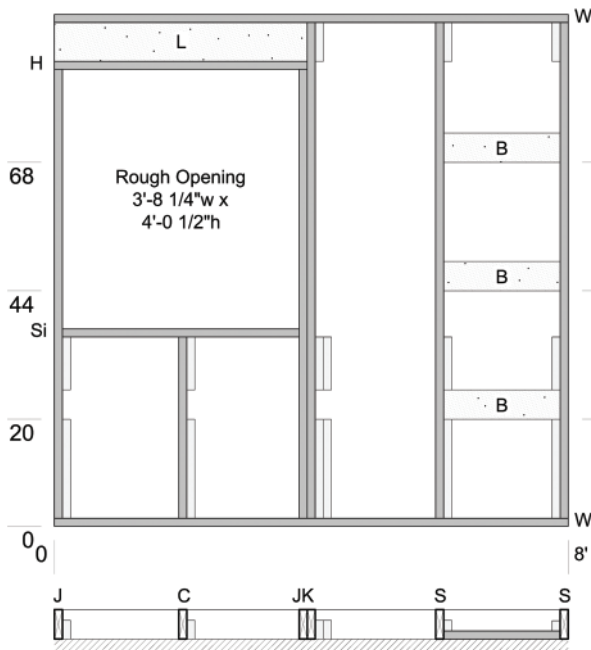

W	all Plates	2 of 8'
S	tuds	2 of 92 5/8"
K	ing Studs	1 of 92 5/8"
J	ack Studs	2 of 6'-11 7/8"
L	intel	2 of 3'-11 1/4" (2x8)
H	header Plate	1 of 3'-11 1/4"
Si	ll Plate	1 of 3'-8 1/4"
C	ripples	1 of 2'-9 7/8"
B	locking	3 of 1'-9 3/4"

### Sheathing Instructions:

Sheathe entire panel. Cut window rough opening out of sheathing prior to weather protective barrier attachment.

### Weather Protective Barrier Instructions:

Cover entire panel. Cut barrier at window rough opening during window installation as directed.

## 2x6 Framing Connection Details

Three screws at each perpendicular connection: stud to plate, header plate to jack stud.

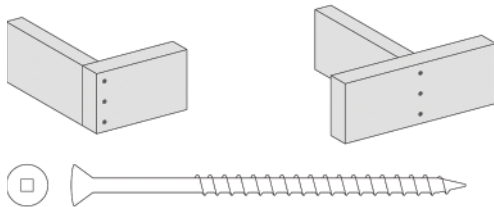

Three screws between studs and blocking.

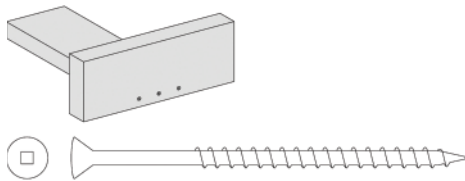

Two screws 16 inches apart at parallel connections: king stud to jack stud, built-up columns.

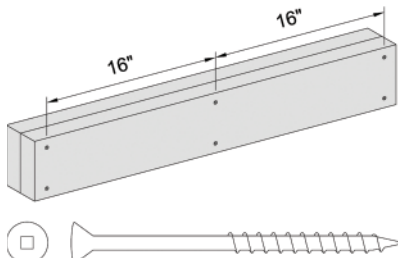

Above: **2.105** Exterior wall panel diagram with a lumber list and instructions for installing the sheathing and the weather protective barrier.

Left: **2.106** Framing connection details for the exterior wall panels.

Mark : “uh...yeah...”

Me: “I’m hoping that these blocks will be just the right height.” I point at the blocks that will sit beneath the lintel.

Keith: “They should be.”

Mike: “Did you get more screws?”

Me: “Yes, I bought seventeen bucks worth of screws... So we’re going to use those up first and then we’re going to use mine.

“So we want slow and steady, right? Make sure you’re doing it right. No messy walls. Just go slow and make sure they know that they’re in control. You’re just there to say no or yes, right? They’re going to do. Ask them what they want to do.” Mike and Keith wander off.

“So, you’ve got your whole frame screwed together. What do you do?”

Mark: “All this is done?” He points at one of his wall panel diagrams. “What about blocking?”

Me: “Your blocking’s in. Everything is all screwed together. Though you may want to this before too.”

Heather: “Plywood.”

Me: “No. Square the wall!” I yell so they all hear.

Mark: “Oh shit, yeah.”

Me: “You may want to do this before you screw in your blocking and your lintel to check”

Mark: “Really?”

Me: “You may want to do that because once you have your blocking and your lintel in it’s going to be awfully hard to move that wall.”

Mark: “You mean after the lintel’s in check it.”

Me: “You may want to check before.”

Mark: “Oh.”

Me: “Because when you screw your lintel in you’re going to have a hard time squaring that wall up.”

Mark: “Good point.”

Me: “So you’re going to put your sheathing on, right? And then you’re going to have to drill a hole with an appropriately sized bit — which I will dig out of somewhere — to router out the window...” The undergraduates are arriving and the graduate students have stopped listening.

“Okay, so Garforth you’re going to help them with the router and show them how to do it?”

Mike: “Yeah, sure.”

They build (2.108-2.114).

Four out of the six assigned wall panels are complete by the end of class. Two of the groups take three and a half hours to build one wall panel each. One group builds their wall with a jack stud that is too short. In fact they cut and install three that are too short before getting it right. The other group uses a severely bowed stud

## Lintel Installation Instructions

Screw the members of the lintel together with a line of screws every 16 inches.

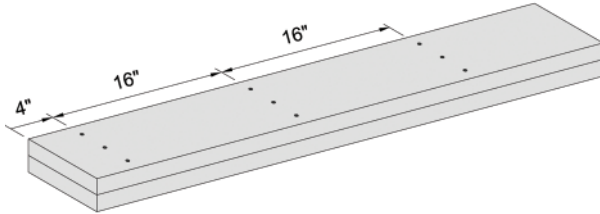

Attach top plate and header plate to lintel with two screws every 16 inches.

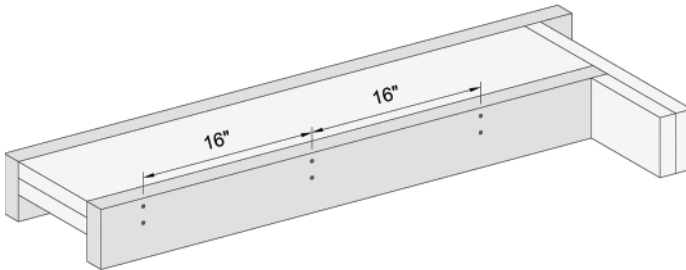

Attach king stud to lintel with four screws into each member of the lintel.

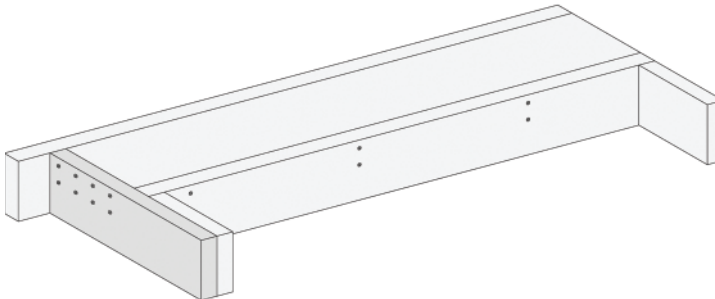

Left: **2.107** Framing connection details for the installation of a lintel in exterior wall panels.

Below Left: **2.108** Driving screws through a jack stud into a header plate.

Below: **2.109** Driving screws through a sill plate into a jack stud.



in their panel. They do not realize that there is a problem until after they have the sheathing mostly nailed down. We are unable to remove all of the outwards bow in the edge of the wall panel, so we will have to bow the edge of the adjacent panel inwards. These two wall panels will form the frontmost and most prominent wall of the house.

Comments from student task sheets, June 1, 2005:

“I found the focus of today’s class to be very focused and encouraging. I like how there is always emphasis for everyone to get a try. For example when I got the chance to cut the hole for the window space. The lintel pieces were cut from the wrong pieces today (2x6 instead of 2x8), and I think that may have been avoided if it was very clearly marked on the directions what size each wood piece is cut from. Perhaps on the spot labeling is more readable than a legend to the right?” - An undergraduate student

“I found it very difficult to accurately build one wall today. Nothing was wrong with the instruction. I could have read the tape better though.” - A graduate student

Thursday, June 2, 2005, 8:50 am: I receive a call from Doug Freure. He wants a list of the siding to order. I tell him that I sent the list to Richard last week. He says that Richard did not give it to him. I tell him to check Richard’s e-mail. Then I ask when the windows are coming. He says that he is having a problem ordering the windows, that they have switched manufacturers, that the windows will now be supplied by Crescent Supply Limited, that someone there knows the family and wants to donate the windows for their house, and that they will not warrant the windows unless they are installed on site. I ask why. He does not know. He says that he will work on them. He asks where I got the sizes for the windows on the window list from. I tell him that the sizes coordinate with the prefabrication of the wall panels and that it is imperative for him to order the exact sizes on the list.

From an e-mail to Bryan Bruce, June 2, 2005:

Please find attached a set of up to date drawings. Last I heard the grading plan was still being worked on, so that the drawings weren’t submitted for permit yet. So if you want to submit something more accurate here it is. I’ve also included a pdf set of details which concern the foundation.

Friday, June 3, 2005, 1:00 pm: The graduate students are on time for their briefing. They appear attentive. We gather around one of the jigs. I have spread out the diagrams of the wall panels that we are to build today.

From a video recording, June 3, 2005:

Me: “You need to stand back. If you’re right here with them screwing you can’t see that the wood’s not lining up. So you stand back. They



Left: **2.110** Using clamps to help install a lintel.

Below Left: **2.111** Measuring to check the accuracy of a window opening.



Left: **2.112** Using a router to cut out the sheathing at a window opening.

Below Left: **2.113** A sheathed exterior wall panel with the window opening cut out.

Below: **2.114** The top plate, lintel, and header plate of a completed exterior wall panel.



have to start thinking, they have to start figuring out what they're doing on their own, you know? Um... sit down with them at the beginning. Show them what we're going to build, you know? Mike did a nice session with his group last Friday. They really appreciated it and they built faster... That extra instruction helps them work better."

Mark: "The problem is that you stand back and then they don't actually think for themselves and then they blame you for not being active enough to help."

Keith: "That's not what you're here to do."

Mark: "So what am I supposed to say?"

Natalie: "Last week I had to say, 'sorry I'm not allowed to help you, my job...'"

Me: "At the beginning of the class you go to your group, you go, 'Listen...'"

Heather: "You're encouraged to think for yourself."

Me: "...you guys should know what you're doing by now, you know? Go to it."

Keith: "The other day I said, 'I'm unionized today. I'm sitting on the table drinking coffee.'"

Me: "Do you remember that first job description that I gave you? That you were responsible for showing them what to do and then quality control."

Mark: "Yeah."

Me: "It's always been stand back and watch. And I know it's been hard to do, but we've really got to get to that point. When we get on-site there's not going to be... I'm not going to be five feet away. You're not going to be five feet away. You're going to have to send them to do tasks and not see what they're doing. So they need to start thinking for themselves... So yeah, they build, you solve the problems, you find the mistakes, you know what I mean?" They are quiet.

"As for tolerances, there's been questions on what is acceptable. Basically I want it to be as exact as possible. Tolerances are something that there isn't a number to, it's more like an intuition."

Natalie: "It's the effect."

Me: "Yeah, you've got to look at what it's going to press on and stuff like that. I have some tolerance built into the wall panels (2.115), however, that's more for if the foundation is not right, right? Um... so," I point to one of the diagrams, "I'd like them to be built to this dimension. If you can't get this dimension go under. Make the panels slightly smaller. If it's too big, problem. If it's too small we can shim it. If your plates are a sixteenth too short I don't care. Make the wall. If they're a sixteenth too long cut them.

"Check your materials list on your sheet. I don't like the materials list, because a lot of times you'll get something like some of these plates won't be an inch and a half. They might be an inch and a half and a little more. Like this, this is a critical dimension." I point to the underside of the header plate. "This materials list is just to help you. It's not saying that it has to be that length. I need you to get that dimension. And of course it could also have some wonderful 1:00 am errors as they usually do.



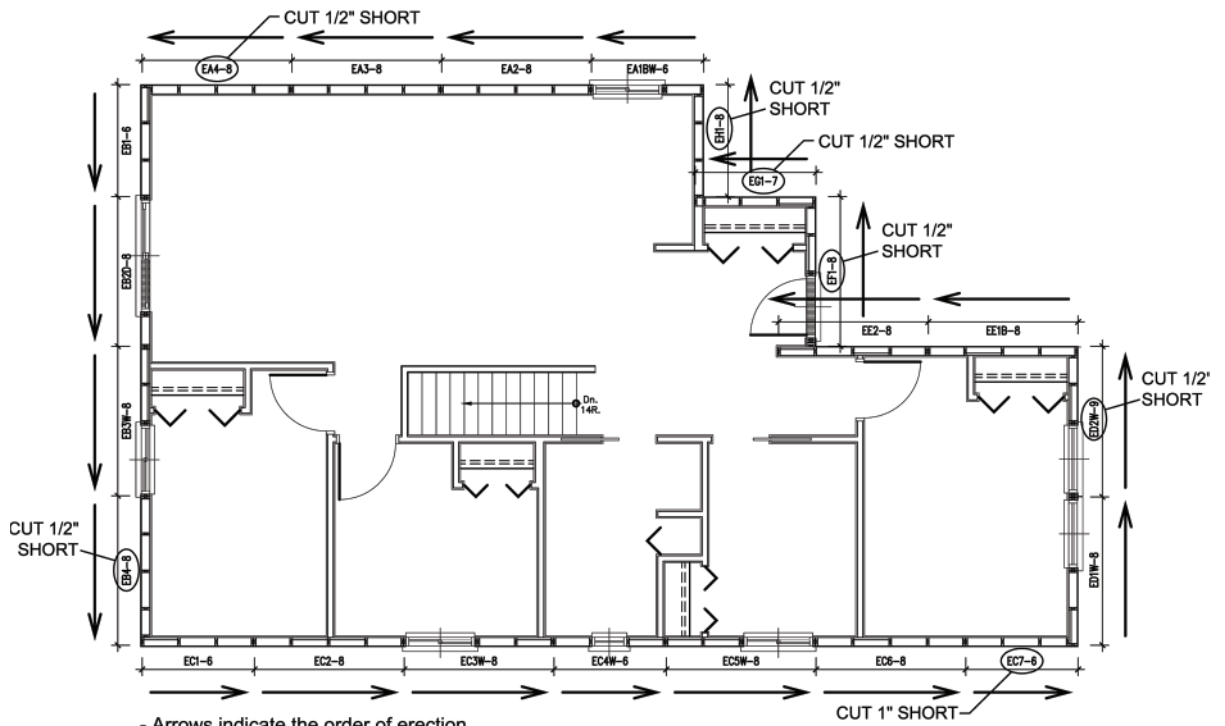

- Arrows indicate the order of erection.
- A short wall can be shimmed. A long wall has to be rebuilt.
- Cut the last panel in each wall short in case foundation is off ( $\frac{1}{8}'' \times \text{\# of panels}$ , rounded up to nearest  $\frac{1}{2}''$ ).

2.115 Diagram showing the changes made to the length of exterior wall panels to make them tolerant to inaccuracies.

“About switching the groups around: we’re going to switch them around again today. Um... the comments that I got back from them was that some of them liked switching groups cause they knew each other anyway... Um... the other comments I got on it was that they were like, ‘oh, the work was slow because we switched groups.’ They couldn’t figure out what to do next because they were with different people, which doesn’t work. When you’re on-site you’re going to be with a different person every five minutes, maybe. You’re going to be with different people all the time. So if they are having difficulty switching groups they’ve got to learn how to switch groups. They’ve got to learn to work with different people. So we’re going to switch the groups all the time, like just randomly, who cares. They’ve got to learn to work with what they’ve got. I mean, you’ve got to learn to work with what you’ve got, right? Sorry, Natalie, you will probably get the slow group again for the third time in a row.”

Natalie: “That’s alright. I can deal with that.”

Me: “I don’t know what else I’ve got scribbled on here...” I pause to stare at my notebook.

Keith: “So there’s five walls today, right?”

Me: “There’s six walls today and there’s actually seven to be completed. The seventh wall is the front door wall. That is, as yet, undetermined, where the front door is exactly going to sit. That is something that we will just frame at a later date. Um...”

Keith: “What are the odds of getting all of these walls done today, given the experience with the last...”

Me: “This is an easy wall.” I point at the diagrams. “This is an okay/easy wall. This is a simple window and beam pocket (2.116). They’re all about... These beam pockets, actually, will not sit on the jig.”

Mark: “Really?”

Me: “You can’t frame this on the jig. Unless you want to remove this blocking.” I point to the first line of blocking on the jig.

Keith: “Why don’t we save these till the end?”

Me: “Well yeah, do these second and do this second.” I pull aside the diagrams for the two walls with beam pockets and the diagram for the wall panel with the patio door in it.

“There have been a number of problems that have come up this week in terms of the furthering of this project.” I take a big breath in. “I have been trying to get windows and I have been trying to get siding. The windows... they switched companies and didn’t tell me and didn’t order them. Now the company is having difficulty with putting the windows in the panels and then transporting them. They insist they won’t warranty the windows. Um... I...” I stammer through a wave of nausea. “So I just changed that diagram to, hopefully, the sliding door size that we’re going to get... Um... these beam pockets, I don’t exactly know what size the beams are.” Another wave of nausea hits. “These should be oversized, so we’re going to frame that, but it might change today as well if I hear back from Orchard... As of yesterday the siding hasn’t been ordered...”

Keith: “But can we do the siding without the windows?”

Me: “We’ll side all the non-window panels first, um...”

# EA1BW-6

Complete

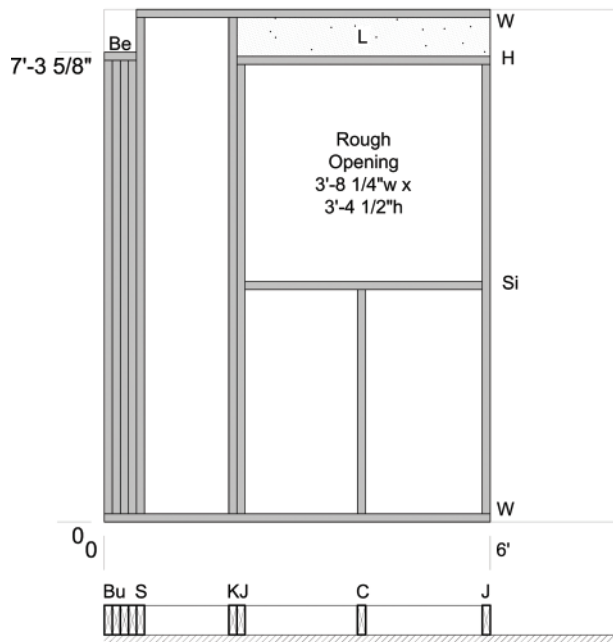

<b>W</b> all Plates	1 of 6', 1 of 5'-6"
<b>S</b> tuds	1 of 92 5/8"
<b>K</b> ing Studs	1 of 92 5/8"
<b>J</b> ack Studs	2 of 6'-11 7/8"
<b>L</b> intel	2 of 3'-11 1/4" (2x8)
<b>H</b> eadler Plate	1 of 3'-11 1/4"
<b>S</b> ill Plate	1 of 3'-8 1/4"
<b>C</b> ripples	1 of 3'-5 7/8"
<b>B</b> uilt-up Column	4 of 7'-0 5/8"
<b>B</b> eaming Plate	1 of 6"

### Sheathing Instructions:

Sheathe entire panel. Cut window rough opening out of sheathing prior to weather protective barrier attachment.

### Weather Protective Barrier Instructions:

Cover entire panel. Cut barrier at window rough opening during window installation as directed.

### Note:

At beam pocket sheathing and barrier to be cut out on site to fit.

**2.116** Diagram of an exterior wall panel with a window and a beam pocket.

Mark: “Do windows go over siding?”

Keith: “No. You need the window to be able to line up the siding.”

Me: “So, um... I went to the site this morning...” This one is really hard to say, “and there is no hole in the ground. There is nothing (2.117). We are to go on-site two weeks today. Um...”

Mark: “How are we supposed to do the foundation?”

Keith: “Well they can do the foundation in four days if they have the... actually, two days...”

Me: “There is no permit as yet.”

Keith: “Okay, that’ll slow them down.”

Me: “So, um...” I think I may vomit. “So as of yesterday we’re in danger of not having any windows, not having any siding, and not having.. a house.”

With the undergraduates organizing themselves the work goes slowly. Four wall panels are complete by the end of class. The only group to build two wall panels builds both of the wall panels that require beam pockets (2.118, 2.119). Unfortunately, due to a labeling error on my part, one of the beam pockets is nine-and-a-half-inches deep while the other beam pocket is eleven-and-a-half-inches deep. I do not know yet what depth the beams will be — I have yet to hear back from an inquiry I made to Orchard Design — so I do not know what is the correct depth for the beam pockets. Fixing the mistake becomes a job for the site.

Comments from student task sheets, June 3, 2005:

“I think we were supposed to build 2 walls today, but we finished one. Today was a little more difficult than last week as the window openings had to be perfect and we were off a little and then took apart almost half of the work we had previously accomplished.” - An undergraduate student

“Whenever we started to stand around, or noticed that we were, we found something to do.” - An undergraduate student

“Group worked well together and were able to take more of an independent role with me only stepping in with reminders or to assist with problems.” - A graduate student

Monday, June 6, 2005, 10:25 am: I call Doug Freure and I ask him when the siding will be delivered. He says that he is expecting to hear from Gentek this afternoon. He says that they are refusing to ship the siding because they do not like the idea of the prefabrication. I rhetorically ask him why they care. I tell him that we are purchasing their product and that it is our business how we use it. He says that when the siding is ready he will pick it up and bring it to me. I tell him that as long as we get it as soon as possible I do not care who delivers it. Then I tell him that I need forty linear feet of **Tyvek FlexWrap** or a comparable window flashing. He says that he will talk to Richard about it. I tell him that I have drawn a detail for



## Tyvek FlexWrap

From the DuPont Tyvek website:

DuPont™ FlexWrap™ is uniquely engineered to address the issues of flashing the bottom corners at the window sill where damage is most likely to occur. DuPont™ FlexWrap™ is wrapped into the sill rough opening before the window is installed, making one step, seamless protection possible.<sup>17</sup>

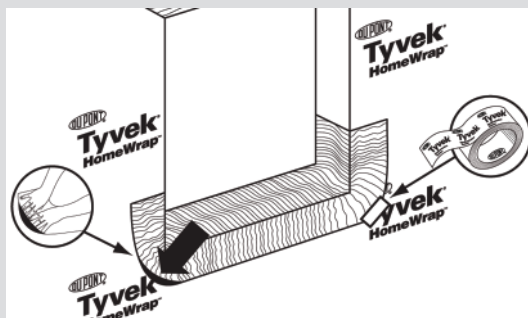

2.120 A Tyvek FlexWrap installation diagram.

Top: 2.117 There is no hole at the site.

Above Left: 2.118 Assembling a built-up column that will support a beam.

Above: 2.119 Carry a completed wall panel with a beam pocket through the workshop.

the roof trusses which shows the height required at the raised heel to coordinate with the preclad wall panels (2.121). He says that he will probably have to order the trusses soon and to e-mail the detail to him and he will give it to the truss manufacturer, Tampa Hall Limited.

12:04 pm: I e-mail Doug the truss detail and a copy of the AutoCad file for Tampa Hall.

2:01 pm: I call Richard and I ask him when they will excavate the site. He says that he has an excavator ninety percent confirmed for tomorrow and that he will try to pick up the permit tomorrow morning. I did not know that he had applied for the permit or even that the grading plan was done. I ask him if he will give me a copy of the grading plan or if I should ask Amanda Scott for it. He says to ask Amanda. He says that there was a problem with the grading because of the height of the sewer. He asks for my foundation details. I tell him that I need to check the details against the grading plan first.

From an e-mail to Amanda Scott, June 6, 2005:

Can you please forward me an AutoCad copy of the grading plan for the barrier free bungalow?

From an e-mail to Bryan Bruce, June 6, 2005:

Can you please send me a copy of the drawing set that was submitted for permit?

Tuesday, June 7, 2005, 1:07 pm: I receive an e-mail from Keith Reycraft at Orchard Design. It is simply an attachment containing a set of drawings. It is the wrong set of drawings. It is a design done by Orchard Design which does not have a carport (2.122).

From an e-mail to Keith Reycraft, June 7, 2005, 1:25 pm:

Thank you.

However that set I believe is an older version. The one that was sent for permit would have a carport on it.

From an e-mail from Amanda Scott, June 7, 2005, 1:38 pm:

It is in the process of being changed as per city comments, I will once it is approved.

Facing Page Top: 2.121 A detail showing the height of the raised heel required for the roof trusses to coordinate with the preclad wall panels.

Facing Page Bottom: 2.122 "Main Floor Plan" of "Habitat for Humanity Barrier Free Bungalow" provided by Orchard Design.

From an e-mail to Amanda Scott, June 7, 2005, 2:01 pm:

Can you send me the previous one anyway, so that I can get an idea of what's going on?

4:30 pm: I drive to the site. There is no hole.

4:34 pm: Keith Reycraft sends me another set of drawings. The design has a carport, but it is still the wrong set of drawings. It is the



set that Bryan Bruce sent me in April, which does not accommodate the prefabrication or the family's needs.

From an e-mail to Keith Reycraft, June 7, 2005, 6:41 pm:

You're getting closer, but it's still not right.

There is a more recent design. All the bedrooms and the bath are along the south side of the house. It's in for permit review now at the building department, so the date of the file should be pretty recent. I'm interested in the actual set that went in to the city.

From an e-mail from Keith Reycraft, June 8, 2005:

Apparently you made these changes and we did not update ours with those changes. The last complete set we did and gave to Richard was the previous set sent to you.

Wednesday, June 8, 2005, 11:25 am: The students are hard at work on the last three wall panels. They have few questions for me this morning. While they work I am able to do some other work; I am even able to leave the room without returning to an onslaught of questions. The graduate students are finding and solving most of the problems on their own.

I call Richard. I get his answering machine. I leave a terse message. I say that I am having a serious problem acquiring the information that I need: that I am unable to get a copy of the drawing set that was submitted for permit from Orchard Design and that Meritech will not send me a copy of the grading plan. I say that I cannot revise the foundation details without this information and that we need to discuss how this and other delays are affecting the construction schedule.

11:45 am: Richard returns my call. He says that he is coming to see me.

12:30 pm: Richard enters the workshop. He has just picked up a conditional permit for the excavation from the Building Department. He shows me the drawing set. It consists of a grading plan by Meritech (**2.123**), an outdated set of plans by me, and a set of old elevations by Orchard Design. The elevations do not match the plans. I make a photocopy of the grading plan. I am not happy with it; the front of the house is eighteen inches higher above grade than I requested. Richard says that they had to raise the bottom of the house above the height of the sewer. He says that a committee decided in favour of raising the house and building a much larger ramp over keeping the house low and not providing the plumbing for a future second bathroom in the basement. I tell him that the ramp will likely not fit under the carport. He says that it is too late to change it now. I tell him that if I was told about the problem earlier that I could have found a better solution.

I ask him where my windows are. Richard says that the window company is insisting that the windows be installed on-site. They

Facing Page: **2.123** Detail of the grading plan prepared by Meritech Engineering.



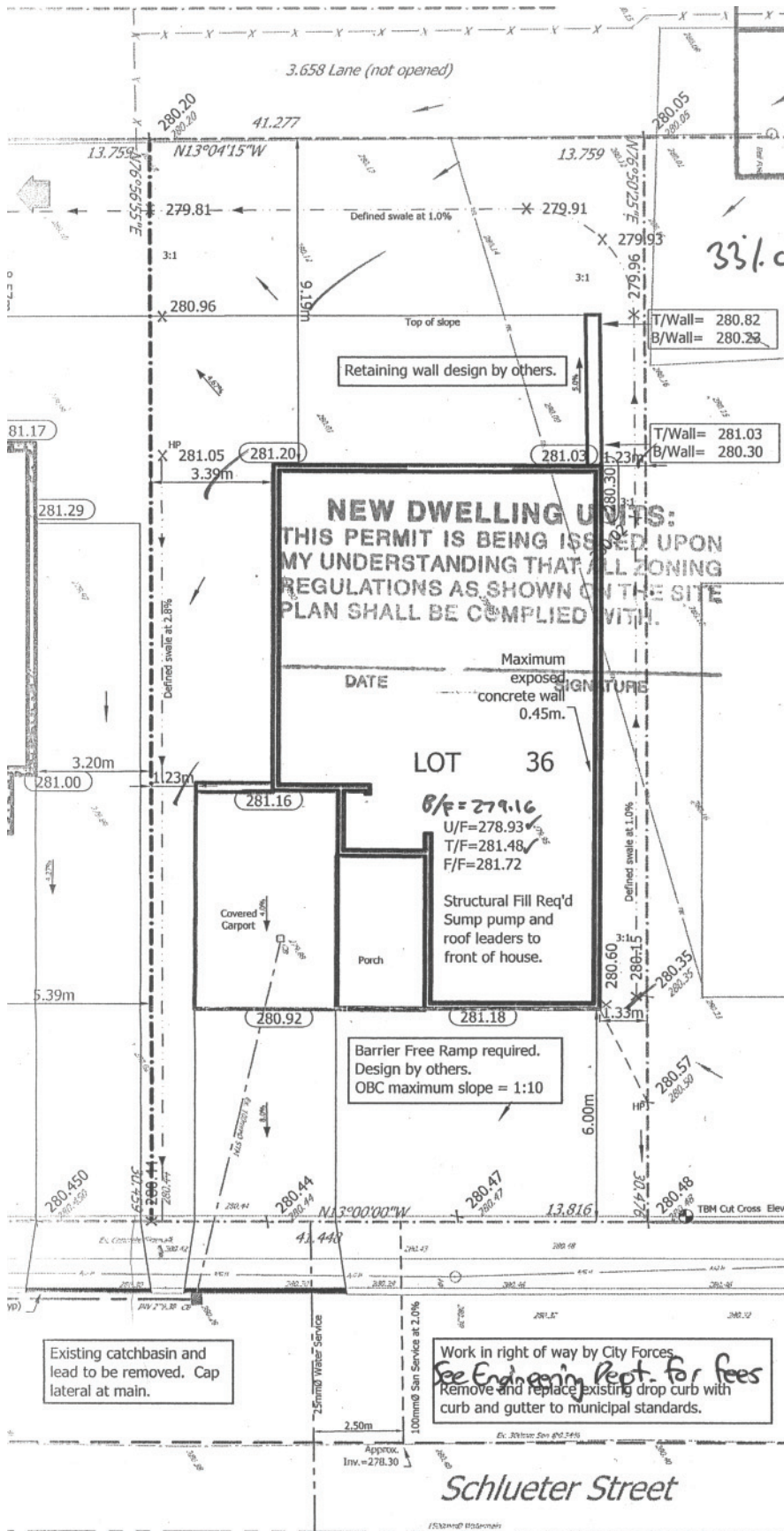

THE ELECTRIC METER/B  
 MUST BE INSTALLED AT  
 1.68m +/-0.15m  
 (5'6" +/-6")  
 ABOVE FINISHED GRAD

33% COVERAGE

- General Notes**
1. Sketch prepared for Habitat for Humanity
  2. Existing Information provided by Mac
  3. Proposed building positioned by calc
  4. All embankments are 3:1 unless otherwise noted
  5. All downspouts and sump pumps to be installed
  6. Wheelchair ramp design by others. Design to meet Ontario Building Code, maximum slope 1:12
  7. Where structural fill is required, a geogrid is to be used in the placement of footings.
  8. Retaining wall design by others. Grade to be as shown. T/W=Top of Wall, B/W=Bottom of Wall. Subject to the Ontario Building Code.
  9. Existing services, utilities and structures to be shown on drawings, and where shown, contractor shall inform himself of the location and structures, and shall assume liability for any damage to them.
  10. All work shall be in accordance with OPSP's, Ontario building code, and all applicable codes unless otherwise noted.
  11. All units are in meters unless otherwise noted.
  12. Proposed grades are to match existing grades. If any work is required on adjacent property, the contractor shall coordinate with the adjacent landowners prior to the start of work.
  13. Erosion control measures are the responsibility of the contractor. Refer to the Ontario provincial guidelines or as directed by the engineer.
  14. Cap storm and sanitary laterals and manholes unless otherwise noted.
  15. All trenches into building to have 1m wide concrete apron.
  16. Contractor to ensure all required permits are obtained.
  17. Contractor to notify engineer 24 hours in advance to coordinate inspections.
  18. Contractor to provide the engineer with a copy of the certification of the works.

- OPS NOTES:**  
 The following minimum specifications
1. Compaction
    - a) Earth fill placed as 'structural fill' shall be proctor maximum dry density. Earth fill shall be placed by the project Geotechnical Engineer.
    - b) Underground services shall have suitable native backfill compacted to maximum dry density, in accordance with the Ontario Building Code.
  2. Precast concrete structures shall be installed in accordance with the Ontario Building Code.
    - a) Ditch inlets shall be installed in accordance with OPSP 705.030, Type A, grate at 150mm.
    - b) Pipes shall be installed as per OPSP 705.030, Type A, grate at 150mm.
    - c) Concrete pipes, as per OPSP 802.030, shall be installed in accordance with the Ontario Building Code.
    - d) Sewer laterals shall be installed in accordance with the Ontario Building Code.
    - e) Watermain services to be 25mm

Retaining wall <  
 AC June 03/05

will only ship the windows to the site. He suggests that we install the windows in the wall panels at the site and then erect the wall panels. I tell him that if we take next Friday to transport the wall panels to the site, install the windows, and complete the siding, that the erection of the wall panels will have to begin on Saturday and that this puts us behind schedule. He says that the floor deck will likely not be ready for us next Friday anyway. He says that he is hoping that the hole will be dug tomorrow so that he can pour the footings this Friday and then pour the foundation walls on Monday. He says that the hole may not be backfilled before the erection of the wall panels.

12:55 pm: All of the wall panels are complete (2.124).

Comments from student task sheets, June 8, 2005:

“We were supposedly building this wall without help from the team leader, but sometimes her instructions were less than clear. We didn’t have enough strength to lift the walls so outside help was necessary.”

- An undergraduate student

“She needed instructions repeated several times and found it difficult to pick up an instruction sheet and actually read it. I got to a point where she would ask what to do next and I’d pass her the sheet and ask her to tell me what it said.” - A graduate student in reference to the undergraduate student quoted above

“It’s pretty cool how we are finished framing now. It will be interesting to move on to the siding next week because I’d like to see how two presided panels might go together.” - An undergraduate student

10:00 pm: I am at home. I sit down to review the grading plan and my foundation details. My roommate walks up, looks at the grading plan, and asks me why the house is backwards.

10:26 pm: I call Richard. I do not expect him to answer, but he does. I tell him that the house is mirrored on the grading plan. I tell him that the wall panels are all built for the house in its original orientation and that they will not work if the house is mirrored. I tell him that Meritech needs to change the grading plan. He says that to request a review of a changed grading plan by the Building Department will delay the permit too long. He says that if I remove the sheathing from the exterior wall panels and sheathe the opposite side of the panels that they should work. I tell him that I will have to redo not just the sheathing, but the Tyvek and the blocking as well. He says to do it. I tell him that it is easier to bring the change to the Building Department than to do all that work. He says to do it anyway. I tell him that I cannot do it because I do not have the labour. He says that I must make the change to the grading plan. I tell him that Meritech needs to make the change. He says that requesting a change from them will take too long and that he needs to take the changed drawing to the Building Department in the morning. I tell him that the drawing is Meritech’s, it has Meritech’s name on it, and it is unethical for me to change it. He says that I



**2.124** All of the wall panels required to frame the house.

have to make the change or the construction of the house will be delayed even further. I tell him that I cannot use Meritech's title block. He tells me to call him in the morning when it is done.

I scan the grading plan into my computer and then I forge a new one (2.125).

Thursday, June 9, 2005, 9:02 am: I call Richard and tell him that the grading plan is ready. He says that Janice Tessman will pick it up from me.

10:15 am: Janice arrives. I give her the grading plan and I ask her to ask Richard why we cannot keep the house low and rough-in a sewage pump for use if the basement bathroom is completed.

10:39 am: I call Doug Freure. I leave a message. I ask when the vinyl siding, and the other materials that I have requested, will be delivered.

11:47 am: I e-mail the students to tell them that class is cancelled for tomorrow morning and that all of them are to attend class next Wednesday to install vinyl siding.

5:45 pm: I drive to the site. There is no hole.

Friday, June 10, 2005, 11:49 am: I call Doug. He says that he was off work the last couple of days and that he will call me back.

6:30 pm: I drive to the site. There is no hole. There is an outline of the house marked out on the ground (2.126, page 150). The outline shows the house in the right orientation.

Monday, June 13, 2005, 9:54 am: I call Doug. He says that someone else is handling the material orders and that he will call me back.

3:54 pm: My cell phone rings. The siding is on its way.

The siding arrives. Both widths of the window surround trim are missing. The delivery driver says that he thinks they are on back order.

7:45 pm: I drive to the site. There is a hole! It is shallow (2.127, page 150).

Tuesday, June 14, 2005, 10:14 am: I call Doug. I ask about the siding on back order. He says that he may have the siding today. I tell him that I need white caulk, not the grey that was sent with the siding. I ask him about the other materials that I requested and I remind him that I requested them on the twenty-ninth of May. I tell him that I need them to install the siding tomorrow. He says that he will ask for the white caulk and that he will find the other materials.

1:58 pm: Richard leaves a message on my cell phone asking me to call him about the allowed area of glass for the house.

Facing Page: 2.125 The revised grading plan.

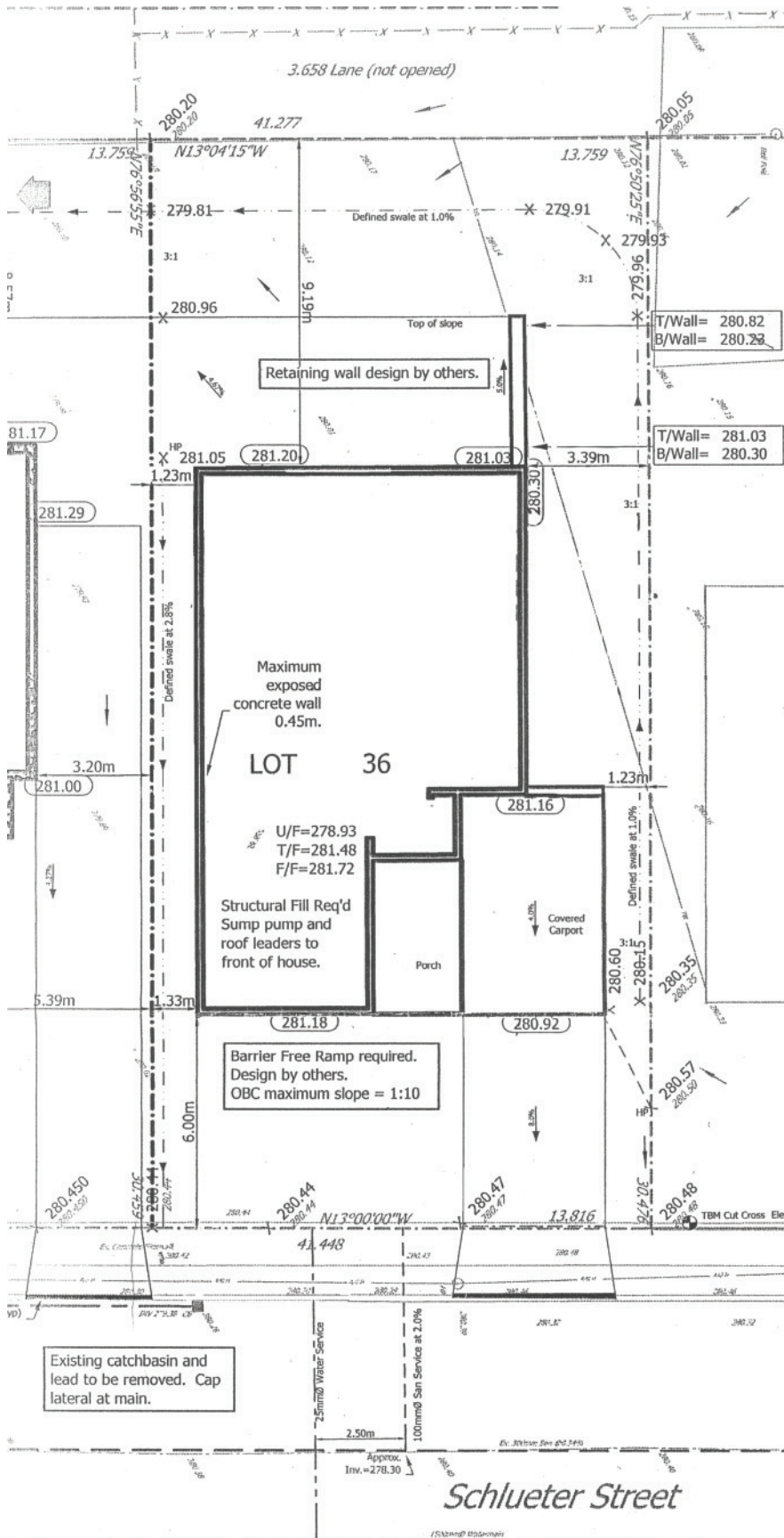



Top **2.126** An outline of the house marked out on the ground.

Above **2.127** The site is excavated.

Facing Page: **2.128** The South elevation.

These drawings are the sole ownership of Orchard Design Studio (ODS). Any reproduction of these drawings without written request to ODS is strictly prohibited.  
 ODS is not responsible for errors and omissions to these drawings. All construction shall conform to the Ontario Building Code Latest Edition. The Owner / Constructor must verify all dimensions, structural components and details and report any discrepancies to ODS prior to construction.



STATUS: BUILDING PERMIT
PLOTTED: 2/06/2005 12:00 PM
SCALE: 3/16"=1'-0"
DWN BY: CMB
DATE: MAY 2005
REV.

PROJECT: **HABITAT FOR HUMANITY BARRIER FREE BUNGALOW**

TITLE: **LEFT SIDE ELEVATION**

SHEET No. **4** OF **12**

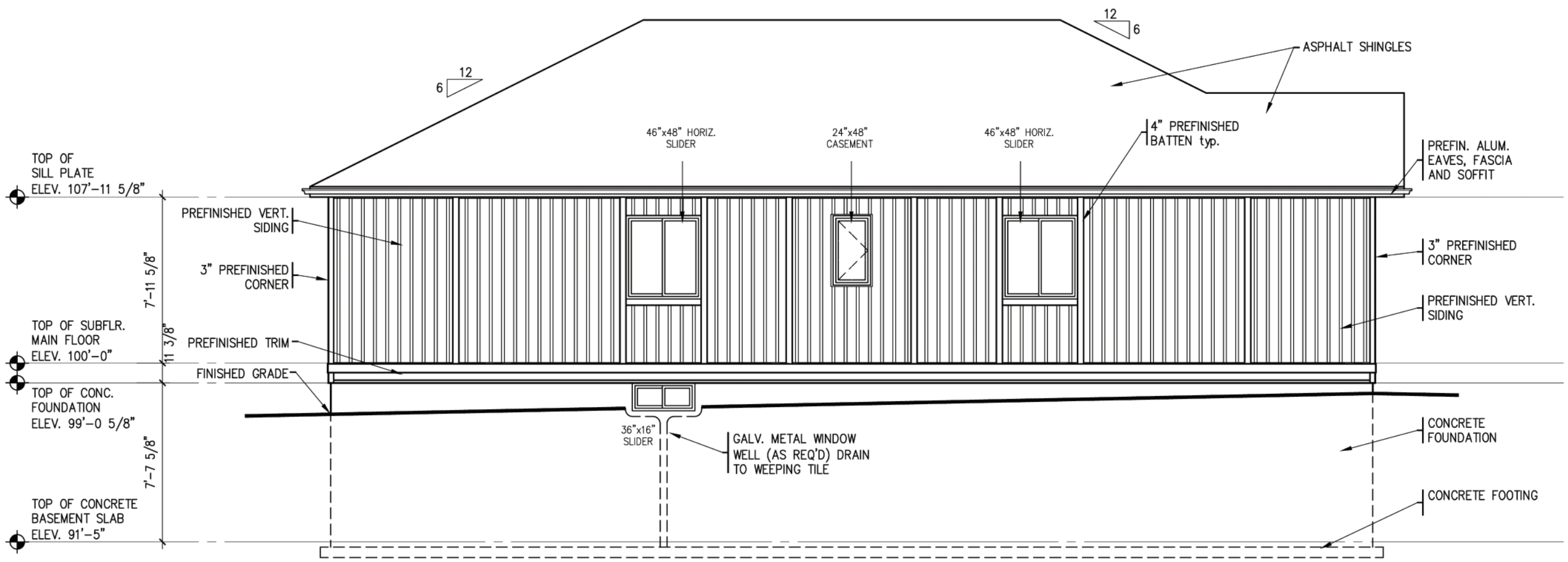

NOTE: WINDOW SIZES SHOWN ARE APPROXIMATE. EXACT ROUGH OPENINGS TO BE DETERMINED BY WINDOW MANUFACTURERS SPECIFICATIONS.

2:05 pm: I call Richard. He says that I need to call David Durnford at the Building Department because there is a problem with the area of the unprotected openings.

I pull out my copy of the Ontario Building Code and the elevations of the house. I check the allowed areas of glass against the size of the windows on each side of the house. The amount of glass on the South elevation (**2.128**, page 151) is close to, but still under, the maximum allowed.<sup>18</sup>

2:15 pm: I call David Durnford. He says that they calculate the area of the glass for a window by taking eighty-five percent of the area of the rough opening. By his calculation the area of glass on the South elevation is over the maximum allowed. To prove that the area of glass is below the maximum he wants specifications from the window manufacturer which detail the amount of glass in the windows.

2:20 pm: I call Richard. I tell him that David Durnford wants specifications from Crescent. Richard says that we do not have time for that. He says that he needs the permit to start the footings tomorrow. I suggest that we remove the basement window on the South side. He agrees. I ask him how likely it is that we can erect the wall panels on Saturday. He says that it is unlikely. I tell him that the next day that we can erect the wall panels is the following Thursday. He agrees. I tell him that due to the delay we will likely not be able to complete the roof. He agrees. He says that I should call Doug to confirm both the truck for transporting the wall panels and the delivery of the windows to the site on Friday.

4:40 pm: I call Doug. He does not answer. I leave him a message.

I drive to Home Depot and buy the materials that we need to install the siding tomorrow.

Wednesday, June 15, 2005, 7:40 am: I am barely awake when Richard calls. He wants me at the site to discuss changes to the foundation.

8:40 am: I meet with Richard at the site. We stand on the road and lay the basement floor plan on the hood of his pick-up truck. Since the house is higher Richard wants to simplify the foundation by eliminating the concrete porch and its supporting foundation wall and then replace them with a wood ramp and a fourth concrete pier (**2.129**). He also wants to eliminate the concrete curb at the top of the foundation wall beneath the carport. I look at the plan and realize that it is the very first draft I gave him at the beginning of May in Tim Hortons. At that time I had not confirmed the structural requirements. If he pours the concrete using this plan the piers will be in the wrong place and they will not have the required footings. I ask him where the up to date drawings that I gave him are. After rummaging around in the cab of his pick-up he finds them. I look them over and agree to the changes. Then I ask him

Facing Page: **2.129** The Basement Floor Plan with notes indicating changes to the foundation.



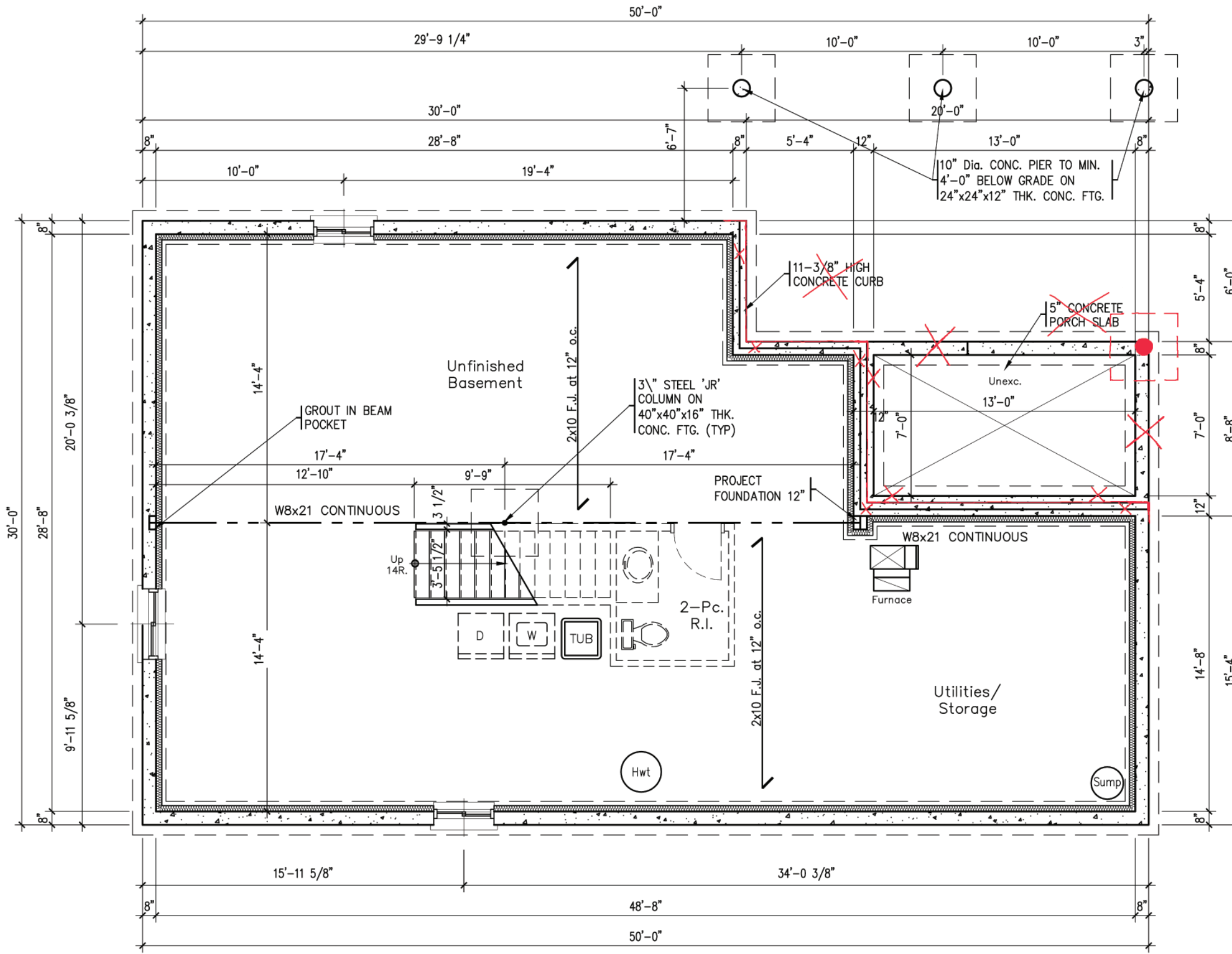

**NOTE:**  
 PROVIDE BUILT-UP WOOD STUD  
 POST EQUAL TO STUD DEPTH x  
 WIDTH OF BEAM, AT BOTH ENDS  
 OF STEEL or WOOD BEAM.



These drawings are the sole ownership of Orchard Design Studio (ODS). Any reproduction of these drawings without written request to ODS is strictly prohibited.  
 ODS is not responsible for errors and omissions to these drawings. All construction shall conform to the Ontario Building Code Latest Edition. The Owner / Constructor must verify all dimensions, structural components and details and report any discrepancies to ODS prior to construction.



STATUS: BUILDING PERMIT
PLOTTED: 2/06/2005 12:00 PM
SCALE: 3/16"=1'-0"
DWN BY: CMB
DATE: JUNE 2005
REV.

PROJECT: HABITAT FOR HUMANITY BARRIER FREE BUNGALOW  
 TITLE: BASEMENT FLOOR PLAN

SHEET No. 5 OF 12

what was wrong with using a sewage pump and keeping the house low. He says that everybody disagreed with the idea and that even if they had agreed Amanda at Meritech would refuse to make the change.

9:12 am: I call Doug from the car. He does not answer.

When I arrive at the workshop the students are waiting. They sit on stools and tabletops. I hand out maps to the site. I tell them to meet here, in the workshop, Friday morning at 8:00 am to start loading the truck. I tell them to meet every other day at 8:00 am at the site and that it is their responsibility to get themselves there. I tell them to wear pants, sunscreen, and sunglasses and to bring water, lunch, and a hard hat. I try to explain the delays: I tell them that they will likely see more of the foundation and the floor deck construction and less of the roof construction. I talk about how the site will be different: that there will be less direction; that their group leader will not be two feet away; that they have to drive themselves and make sure that they are productive; that they may not know a lot about what they are doing; and that the pace may be slow at times. I tell them that they must be patient, keep thinking, ask questions, and keep an open mind. I tell them that they are not marked on what they know, but they are marked on their attitude and how they respond to what they do not know.

The thirty-one students are divided into four groups for the morning. Each group is to install siding on two wall panels simultaneously, with three or four undergraduate students per wall panel. Each graduate student has two sets of siding installation diagrams (2.130, 2.131) and siding rules for their group (2.132, page 156).

The first page of the siding installation diagrams details the length and exact installation location of the undersill trim and the J trim (2.130). The diagrams are for both six-foot-long and eight-foot-long wall panels, so there is a calculation to determine the length of the J trim. The second page of the diagrams details the length and installation of the board and batten style siding panels (2.131). There are more calculations to ensure that the siding panels will be centred on the wall panel. On some of the wall panels the siding panels are installed from left to right, on others they are installed from right to left (2.133, page 157). There is also an additional page of directions that details changes to the standard calculations for wall panels that will form a corner of the house (2.134, page 158).

Eight wall panels are laid out in the parking lot. The graduate students help their groups identify, cut, and properly install the trim pieces (2.135, 2.136, page 158). Some groups talk through the calculations for the siding panels together (2.137, page 158), others assign one group member to do all of the calculations. Once they trim the first siding panel to the correct width and install it (2.138, 2.139, page 159), the rest of the siding proceeds quickly (2.140, 2.141, page 159).

Facing Page Top: 2.130 Diagram detailing the installation of the vinyl siding trim.

Facing Page Bottom: 2.131 Diagram detailing the installation of the vinyl siding panels.

## Siding - Trim Installation

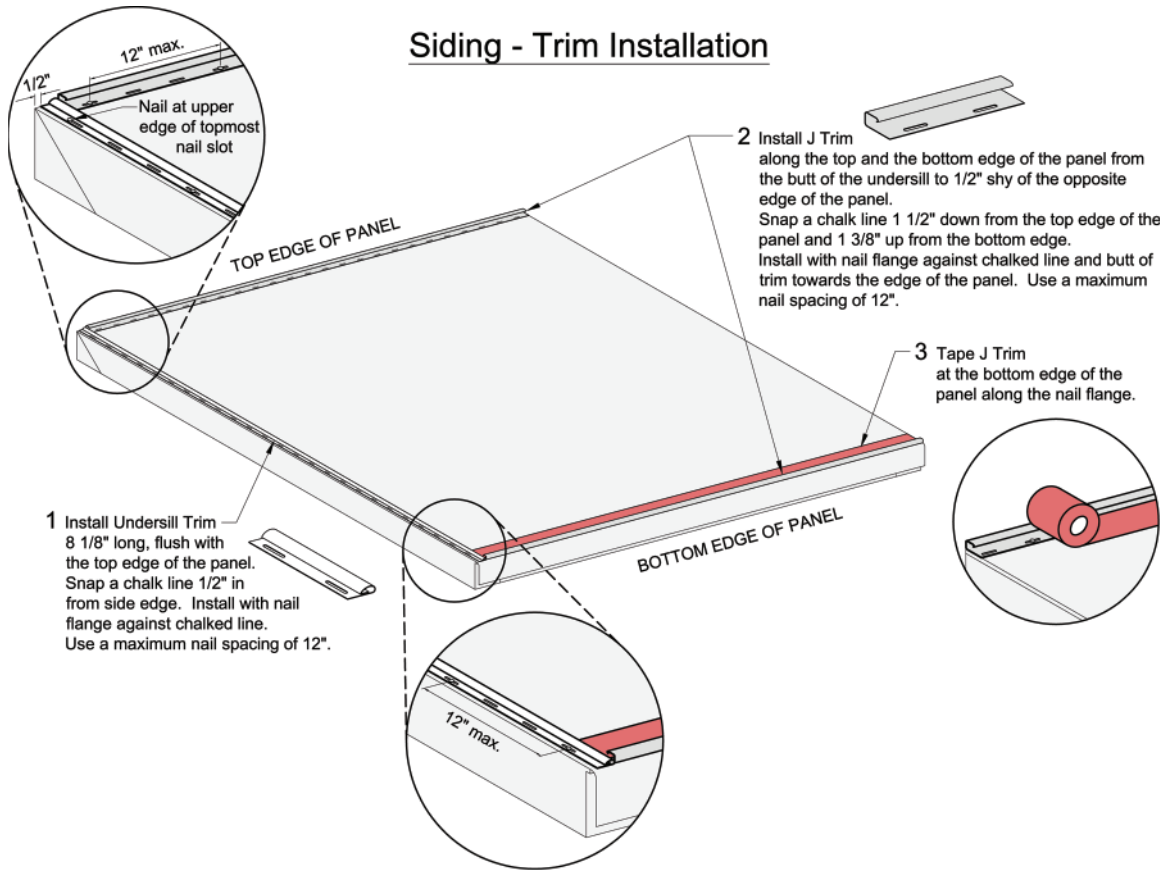

## Siding - Panel Installation

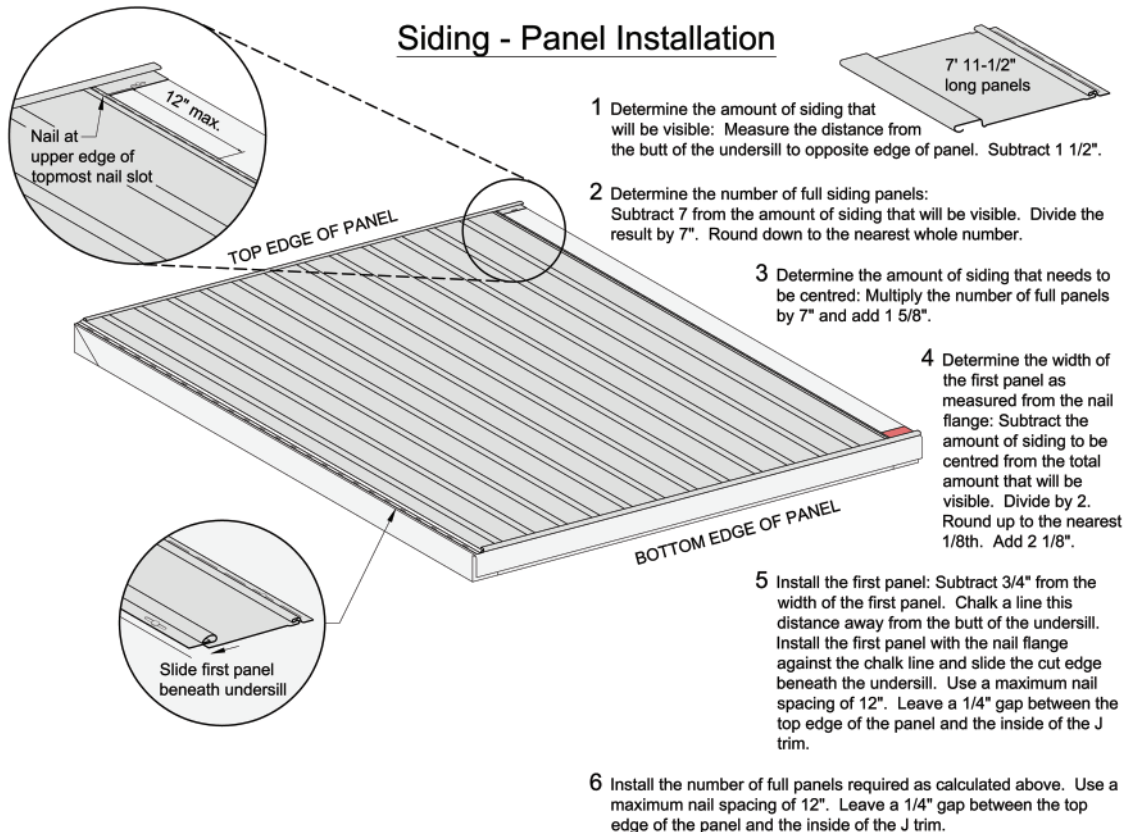

## Vinyl Siding Rules

Vinyl siding will expand and contract with temperature changes. It must be free to move.  
Always:

- Nail in the centre of the nailing slot using large headed (roofing) nails.



- Hang siding on the nails. Do not nail tight to the wall.

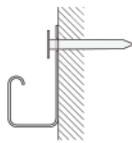

- Leave a gap (typically 1/4") where siding panels are inserted into trim.

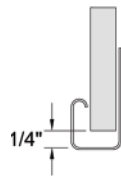

Terminology:

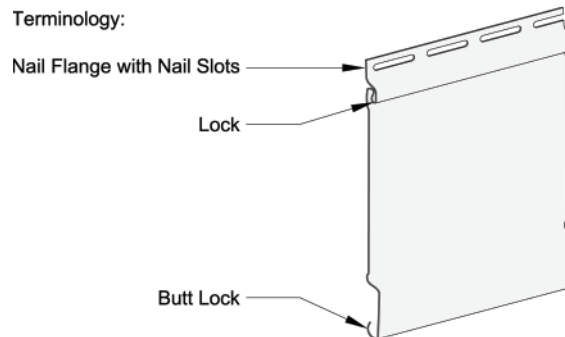

2.132 Page of rules for installing vinyl siding.

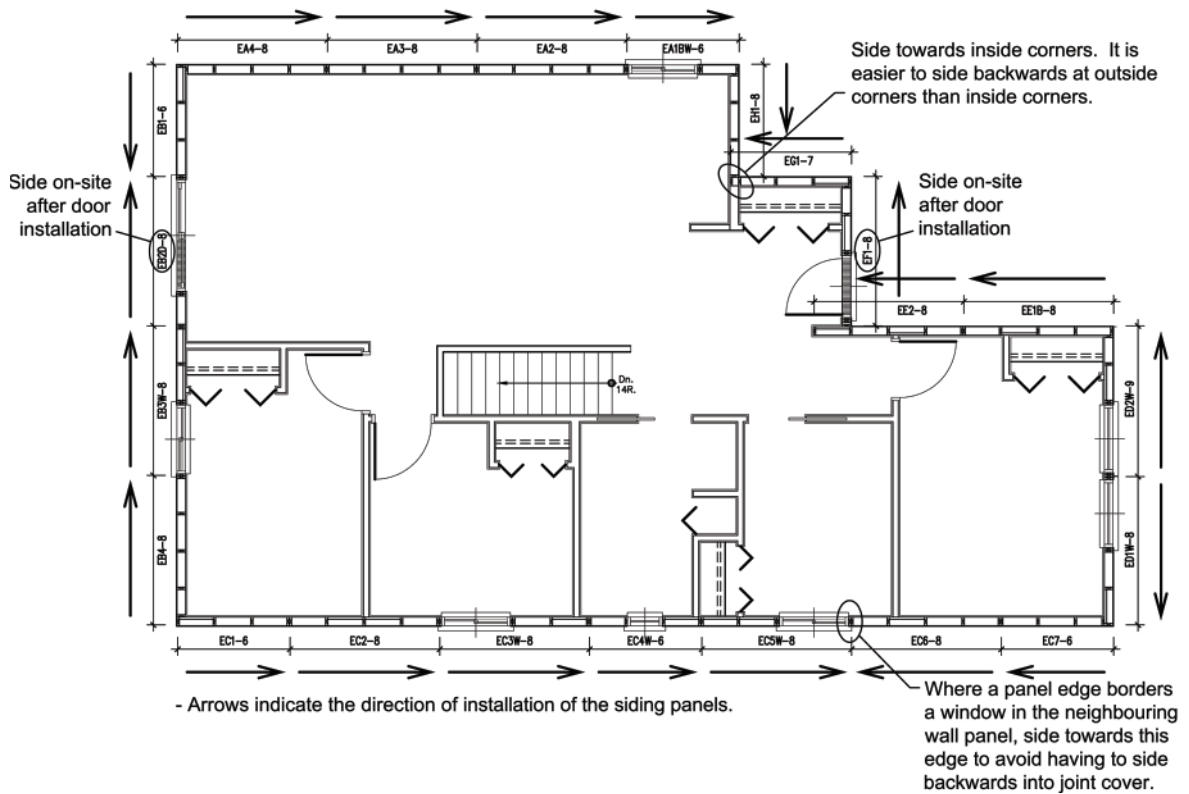

2.133 Diagram showing the direction of installation of the siding panels.

## Siding - Panels at Corners

### Changes to trim installation:

- 1 Do not install undersill trim.
- 2 Start J Trim 1-1/4" from the edge of the panel at the corner or 3/4" from edge of the overhang. J trim to end 1/2" shy of the opposite edge of the panel.

### Changes to panel installation:

- 1 To determine the amount of the visible siding subtract 1-3/8" from the length of the J Trim.
- 4 At the end of the calculation for the width of the first panel add 1-3/4" instead of 2-1/8".
- 5 Do not install the first panel.
- 6 Add 7" to the width of the first pane that was calculated in step 4. Chalk a line this distance from the start of the J trim. Install the first full panel with the nail flange against the chalk line. Install the remaining full panels.

Above Right: **2.134** Directions detailing changes to the standard calculations for wall panels at the corners of the house.

Right: **2.135** Installing J trim along the bottom edge of a wall panel.

Below: **2.136** J trim installed along the top edge of a wall panel.

Below Right: **2.137** Talking through the calculations for the siding panels.





Top Left: **2.138** Trimming the first siding panel to its calculated width.

Top Right: **2.139** The first siding panel trimmed and ready for installation.

Above: **2.140** Installing siding panels.

Left: **2.141** Siding panels installed.

One of the graduate students approaches me and insists that there must be an easier way to install the siding. He says that the calculations are unnecessarily complicated, that having to do calculations is ridiculous, and that uneducated tradesmen would not do calculations like this on-site. He is almost irate. I tell him that someone who is installing vertical siding on-site does do calculations to centre the siding, but only once for every wall of the house, not for every six or eight feet. I tell him that the calculations are further complicated by having to connect the interlocking vinyl siding across the joints between wall panels. I tell him that the material is not designed for this application, that because it is so complicated no one preclads wall panels in vinyl siding, and that only a fool would attempt to do so. That satisfies him.

It may have been this distraction or it may have been the blinding reflection of the sun off of the Tyvek, but I realize too late that some of the students are not locking the siding panels together properly. Some of the wall panels are almost complete when I ask them to remove the siding panels (2.142), put tape over the holes in the Tyvek (2.143), and reinstall the siding panels (2.144).

Comments from student task sheets, June 15, 2005:

“There was a lot of math to do at one point, and it was intimidating at first. But once the calculations were done, the rest of the placing of the panels made sense. The directions given today were very clear, even with explanations of why each step was done (ex. The tuck tape for keeping the water out) and everything went rather smoothly.” - An undergraduate student

“The written instructions are good but to have everyone in the group read/understand them was quite difficult.” - An undergraduate student

2:40 pm: I call Doug. His phone is off.

4:23 pm: I call Doug. The phone rings. He does not answer and neither does the answering machine.

8:15 pm: I drive to the site. There are no footings.

From a fax to Doug Freure, June 15, 2005:

I have not been able to get in touch with you by phone, so I'm trying the fax.

We have to install the windows and complete the siding on Friday and Saturday. The 36 students involved must complete this work. Their class schedules have been altered to accommodate these days. While the scope of tasks that they will be able to complete has changed the requirement for the students to do the work has not. We have done the work we can with the materials we have. The windows (with accessory materials) and the undelivered siding are necessary for the work to proceed.

This Friday is and always has been our first day on site. On Friday you are to provide a truck for the delivery of the materials to the site. I have previously discussed this with Richard, but I need you to confirm that this will happen.





2.142 Removing incorrectly installed siding panels.

2.143 Taping over nail holes in the Tyvek.

2.144 Reinstalling siding panels.

Once we are at the site we need the outstanding materials by 9:30 am. These materials include:

- Windows
- Undelivered siding and white caulk
- Shingle shims
- Tyvek Tape
- Tyvek FlexWrap

We will also need tools. If tool management is not your responsibility please advise me who I should speak to. The tools I expect to need on Friday and Saturday are as follows:

- Skill saw
- Chop saw
- Blades for cutting vinyl siding
- Cordless drills
- Aviation snips (as many pairs as you have)
- Staple gun
- Caulking gun
- Chalk lines
- Squares
- Levels
- Pry bars
- Utility knives
- Half a dozen hard hats
- 20 more aprons

When you receive this please call me at... to discuss.

From an e-mail to my advisors, Terri Meyer Boake, Mike Elimitt, and John Straube, June 15, 2005:

Completing the house to weathertight is no longer a responsibility of the school. It will still be part of my continuing commitment to them along with the finishing.

The revised schedule (**2.145**) is optimistically as follows:

Friday June 17th - transport materials to the site, begin window installation and continue with siding.

Saturday June 18th - complete window installation and siding of panels

Tuesday June 21st and Wednesday June 22nd - floor deck with graduate students, other volunteers, and students making up for missing class. This is dependent on the stripping of the forms and the issuance of the full building permit.

Thursday June 23rd and Friday June 24th - panel erection (students are on site one of those two days. Splitting the installation over two days will allow all students to participate)

Saturday June 25th - complete siding and possibly erect trusses

Monday June 27th to Thursday June 30th - roofing with masters students and other volunteers.

The students are going to miss most of the roofing but will be able to view/experience the front end. I expect that we will be on site while they are forming and pouring the foundation walls. It will provide opportunities for them to see what weeping tile looks like in real life, etc.

### Original Schedule

Month	Day of the Week						
	Monday	Tuesday	Wednesday	Thursday	Friday	Saturday	Sunday
June	13	14	15 9:30 - 1:30 Last Class. Complete wall panels.	16	17 8:00 - 4:00 Move to site. Start erecting wall panels.	18 8:00 - 4:00 Finish erecting wall panels and complete siding.	19
	20 Roofing.	21 Roofing.	22 8:00 - 12:00 Roofing.	23 8:00 - 4:00 Roofing.	24 8:00 - 4:00 Roofing.	25 8:00 - 4:00 Complete roof. Weathertight.	26
	27	28	29	30	Holiday weekend		

### Revised Schedule

Month	Day of the Week						
	Monday	Tuesday	Wednesday	Thursday	Friday	Saturday	Sunday
June	13	14	15 9:30 - 1:30 Last Class. Install siding on eight wall panels.	16	17 8:00 - 4:00 Move to site. Install windows and siding on wall panels.	18 8:00 - 4:00 Install windows and siding on wall panels.	19
	20	21 Start floor deck.	22 8:00 - 12:00 Complete floor deck.	23 8:00 - 4:00 Start erecting wall panels.	24 8:00 - 4:00 Finish erecting wall panels.	25 8:00 - 4:00 Complete siding. Start roofing.	26
	27 Roofing.	28 Roofing.	29 Roofing.	30 Roofing.	Holiday weekend		

2.145 The original on-site construction schedule and the revised on-site construction schedule.

Thursday, June 16, 2005, 10:27 am: I call Doug. He says that he has the fax and that he has not read it yet.

1:15 pm: I call Doug. He says that Janice will bring the tools to the site and that he will bring the materials. I ask about the windows. He says that they should be ready today and that he left a message with the manufacturer to call him. I ask about the missing siding trim. He says that the Kitchener distributor thinks that they have the five-inch-wide window surround, but not the three-and-a-half-inch-wide window surround. I say that I will call to see if we can acquire it straight from the factory.

1:29 pm I call the head office of Gentek Building Products Limited. I leave a message detailing my difficulty with acquiring the window surround.

2:27 pm: I receive a call from Wendy at Gentek's Kitchener distributor. She says that the die used to machine the window surround is broken. They cannot manufacture the profile.

I hang up the phone. The three-and-a-half-inch-wide window surround is vital to the completion of the siding. It is necessary to both connect the siding across the joints between wall panels and to complete the siding on any wall panel with a window. Without the missing pieces my siding solution does not work. I laugh.

2:30 pm: I call Doug and tell him that they cannot manufacture the window surround. He asks me if Orchard would know of a substitute. I suggest that other Gentek distributors may have stock. He says that he will make the calls.

4:15 pm: I receive a call from Doug. He says that a truck from Active Towing will be arriving at 9:00 am tomorrow. I tell him that I need the truck at 8:00 am. He says that I need to call Linda at Active Towing to give them the address of the School and that I can ask her if we can have the truck earlier.

4:18 pm: I call Linda. I give her the address of the school and I ask if the truck can come earlier. She says that she will talk to the driver when he arrives in the morning and that she will have him give me a call.



## On The Site

Friday, June 17, 2005: I drive closely, and nervously, behind the first truck load of wall panels (2.146). The truck arrived at quarter-to-eight this morning. The driver was told that there were twenty wall panels to transport. There are twenty-seven interior wall panels, twenty-two exterior wall panels, a large amount of uninstalled siding, and unused framing materials including lumber and plywood. The driver phoned his dispatcher to ask for a second truck.

The truck ahead of me is loaded with all of the exterior wall panels and the unused plywood (2.147). All of the little things — nails, screws, staples, siding scraps, etc. — are packed into my car with me and my personal tools. As I follow the truck around a large left turn the load shifts and the exterior wall panels closest to the cab of the truck start to lean to the right. Images of the wall panels sliding off the truck into traffic flash through my mind. Fortunately we arrive at the site without incident.

We immediately start working to unload the truck (2.148, 2.149).

It is now noon and I have sent the students away for a lunch break. It took two more truck loads on the smaller second truck and all morning to move everything (2.150). I sit in my car with my legs hanging out of the door and a clipboard on my knees. I am reviewing the five remaining wall panels that do not have a window or a door in them and do not yet have siding. One is a wall panel that will be erected at an outside corner of the house, one contains a beam pocket and will be at an outside corner, one will be at an inside corner, and two will be at both an inside corner and an outside corner. Four out of the five require changes to the siding installation instructions (2.151, page 168). I was not expecting to install siding on these panels this afternoon, but we will be. I was expecting to install windows this afternoon. I prepared instructions detailing how to do so, but there are no windows. Doug and the materials that we need are nowhere to be found. Richard and Janice showed up on-site late this morning. Richard said that the windows may be manufactured next Tuesday or Wednesday. I asked what we are supposed to do. Janice said that if we clear all three excavations of loose rock and dig one of the excavations one foot wider then they will be ready for their contractor to form and pour the footings.

This afternoon half of the students will be assigned to working on the excavation and half will be assigned to installing vinyl siding (2.152-2.156, page 169). Today will end early and the entire day tomorrow will be cancelled. There is nothing that we can do.

Comments from student task sheets, June 17, 2005:

“This is not productive! We are not learning anything from picking up stones. We signed up for this class to learn, not to pick up stones and move tree branches around.” - An undergraduate student



Above Left: **2.146** The first truck load of wall panels.

Above: **2.147** Loading the truck with exterior wall panels.

Left: **2.148** Starting to unload the first truck load at the site.



Above Left: **2.149** Storing unloaded exterior wall panels at the back of the site.

Left: **2.150** The smaller second truck loaded with interior wall panels.

EB1-G side corner panel

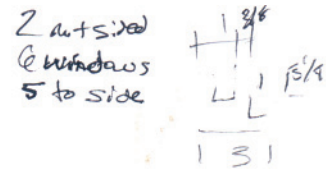

EE1B-8 corner panel with beam pocket.

Do not side at beam pocket.

EE2-8 visible = 2" from left edge  
 5" from right edge of sheathing  
 I channel to <sup>right edge of sheathing</sup> 3.5" shy of right edge of sheathing  
 Have last piece out .2 if ~~beam~~ space is less than 5"

EG1-7 visible 1 5/8" from left edge.  
 5" from right edge of sheathing  
 I channel to 3.5" shy of right edge of sheathing  
 Start of I trim as per corner directions.

EH1-G visible 1 5/8" from right edge  
 5" from left edge  
 I channel to 3.5" shy of left edge  
 Start of I trim as per corner directions

2.151 Written instructions detailing changes to the siding installation instructions for five wall panels.





Left: **2.152** Clearing an excavation of loose rock.

Below Left: **2.153** Communicating the changes required to the siding installation instructions.

Below Right: **2.154** Preparing to cut a siding panel to length.

Bottom Left: **2.155** Installing siding panels.

Bottom Right: **2.156** Storing a sided wall panel.



“Today felt a lot more productive than usual. It really makes a difference to be on-site as opposed to the shop. I actually feel like I’m more closely connected to the project... I can’t wait to start erecting walls. Then our contribution to the build will be really felt.” - An undergraduate student

Thursday, June 23, 2005: I dig. Future homeowner Laurie Baker, an undergraduate student, and myself are trying to stabilize one of the concrete piers for the carport by packing dirt around it (2.157). Sweat runs out from under my hard hat and down the sides of my face. Although it is only midway through the morning it already feels as though the temperature is over thirty degrees. Yet it feels good to dig. I spend most of my time telling people what to do: I assign tasks, I instruct, I supervise, I settle disputes, and I motivate. Every few minutes someone wants my attention. What I want is to build; so I jump down into the excavation, grab a shovel, and I dig.

The concrete pier sits on an unnecessary strip footing. When the footings were poured on Monday the changes to eliminate the concrete porch and its supporting foundation were not incorporated (2.158). In addition, the wrong foundation plan was used and the footing pads for the other concrete piers are in the wrong location. One footing pad is two feet away from where it needs to be.

Tuesday morning, when I told Richard about the footing errors, he told me that the siding on my wall panels is installed too far up the wall and it will interfere with the installation of the soffit. I said that the soffit will be higher than normal because of the raised heel trusses that were ordered. He said that raised heel trusses were not ordered. I said that I had sent Doug the detail and the AutoCad drawings to send to Tampa Hall. Richard said that they were not sent to Tampa Hall.

I called Fernando at Tampa Hall. He threatened to pull the trusses out of the production schedule and delay their manufacture a week. I sent him the detail and the AutoCAD drawings. He called me back, apologized, and said that the drawings were exactly what they needed.

Tuesday afternoon I drove to Barrie and back. The Gentek distributor in Barrie was the only distributor in Ontario with stock of the three-and-a-half-inch-wide window surround. After a series of telephone debates between Andrew at Gentek, Richard, and I about which delivery method would be the fastest and cause the least damage to the vinyl, I drove to Barrie. There Andrew kindly cut the twenty-foot-long pieces into eight-foot-long and twelve-foot-long sections and then tied them to the roof of my car. While I still need the five-inch-wide window surround to complete the siding for the house, I now have all the materials to complete the precladding of the wall panels once the windows are installed.

Yesterday morning Richard said that the windows were being manufactured that day. I asked him if they could be delivered for



Left: **2.157** Packing dirt around a concrete pier to stabilize it.  
Below: **2.158** The footings.



today. He said that he will ask but he does not want to push the manufacturer because he wants them to donate windows in the future.

Shortly afterwards I spoke to Doug. He said that the windows have already been manufactured and that the manufacturer will not deliver them until they can come to the site and see that we are erecting the wall panels to ensure that the windows are not installed before the wall panels are erected.

The concrete truck arrived at 12:20 yesterday afternoon. I stood and watched the contractors pour the foundation walls and the concrete piers (**2.159, 2.160**). I watched to know that it was completed and that the students would have work to do today.

We started this morning by stripping the concrete formwork off of the foundation walls and breaking off the protruding metal ties (**2.161**). Right now, two of the graduate students are working with Janice Tessman to survey the accuracy of all three foundations (**2.162**), one of the graduate students is leading a group to build a wooden bridge over the excavation to each of the foundations, another graduate student is directing the damp proofing of the foundation wall (**2.163**), and the last graduate student has just brought me a wheel barrow full of loose dirt to pack around the concrete pier.

I am called away from my digging. The steel beams have arrived (**2.164**, page 174). The one for our house is too long. It must be cut to length and holes must be drilled through the top flange to allow a wooden plate to be bolted to its length (**2.165**, page 174). After the beam is set in place the floor joists will rest on, and be nailed to, this plate.

The two graduate students assigned to surveying the foundation approach. They report that along the top of the wall there is nine millimeters between the highest point and the lowest point. I am happy with that. They also report that every section of the foundation wall is between one-quarter of an inch and just over one inch too long (**2.166**, page 174). I can work with that. We can start construction of the floor deck.

First two-by-fours are laid across the top of the wall and the location of the anchor bolts are marked on them (**2.167**, page 174). While holes in these sill plates are drilled, the sill gasket and the Tyvek — which will wrap the perimeter of the floor deck — are installed (**2.168-2.170**, page 175).

By the end of the day all of the sill gasket, half of the Tyvek, and half of the sill plates are in place (**2.171**, page 175). Holes have been drilled in the remaining sill plates and they are ready to be installed.

Comments from a student task sheet, June 23, 2005:

“Today was the most productive day because I took on a variety of roles that apply to many parts of the foundation. I got a very clear idea of how a foundation is built up and connected to the walls. I feel like



Top Left: **2.159** Placing concrete in the foundation formwork.

Top Right: **2.160** Placing concrete in a sono tube.

Above Left: **2.161** Stripping concrete forms off of the foundation walls.

Above Right: **2.162** Surveying the accuracy of the foundation wall.

Left: **2.163** Applying damp proofing over the ties in the foundation wall.



Above: **2.164** Unloading a steel beam.



Above Right: **2.165** Bolting a wooden plate to the top flange of the steel beam.

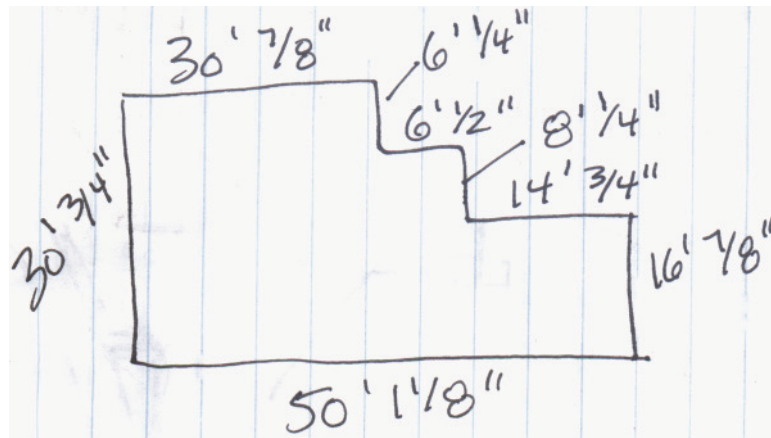

Right: **2.166** Sketch showing the dimensions of the foundation walls.

Below Right: **2.167** Marking the locations of anchor bolts on a two-by-four sill plate.





Left: **2.168** Drilling a hole in a sill plate at an anchor bolt location.



Above Left: **2.169** Installing sill gasket along the top of the foundation wall.

Above: **2.170** Installing Tyvek along the top of the foundation wall.

Left: **2.171** The foundation wall at the end of the day.



I have a much better knowledge of what I have been drawing.” - An undergraduate student

From an e-mail to my advisors, Terri Meyer Boake, Mike Elimitt, and John Straube, Friday, June 24, 2005:

Well, we finished the sill plating, installed the rim boards, framed the stair opening and have more than half of the joists in (2.172-2.174). We will finish the floor deck tomorrow. The joists are going much faster because we are not as dependent on the number of ladders. We can't do much else tomorrow because the windows came late today and are completely wrong. They coordinate somewhat with the April plan before the redesign and must be the windows for the house next door. They are not only the wrong size, but there isn't the correct number of them. I was thinking I could accommodate them if they weren't too far off, but what am I going to do with a 6 foot wide window when my largest rough opening is less than 4 feet? They have to be for the house next door. Anyway, this can't be fixed until Monday, so as I said we shall finish the floor deck tomorrow. If it is a delivery problem and we can get them delivered then I can get enough hands next week to install them in the panels and side the panels. If the order has been messed up then we will probably have to erect the panels before the windows arrive. These are the two options. Accommodating the windows that were delivered today is not feasible. In conclusion: no panels will be erected tomorrow and I do not know when they will be.

From an e-mail to my advisors, Terri Meyer Boake, Mike Elimitt, and John Straube, Saturday, June 25, 2005:

After a slow but steady start due to a late delivery of more joists and the correct cross bridging we completed framing the joists (2.175), installed the bridging (2.176, page 179)... and sheathed the rim boards so that the siding of the panels will be in line with the siding below (2.177, page 179). The sub floor sheathing was going on slowly when we came across a missing joist, the location of which was confused by the stair. Stopping there was fine anyway because I soon discovered that the joists that were framed into the stair were out an inch at the hanger end. It was late in the day so that was it. The Graduate students that are assisting me will be on site with me Monday to correct the errors so that the sheathing can be completed. I spoke to Richard about the windows and gave him a list showing what windows I requested and what we received (2.178, page 179). I will speak with him about it again on Monday when he will be able to make some calls and possibly get some answers from other people.

The last several days have been long and very hot. One of the biggest fights has been against sun and heat stroke. This has slowed everybody down. Today was the worst. Two people have gone to the hospital this week due to site injuries, one for a concussion and one for a split open thumb.

Comments from student task sheets, June 25, 2005:

“I learned a lot about floor framing such as how cross bracing works,





Above Left: **2.172** Installing rim boards.

Above: **2.173** Installing two-ply joists at the stair opening.

Left: **2.174** Installing joists.

Below: **2.175** All of the joists are installed.



how difficult it is to get the rim joists straight, and how important it is to have a flat sill plate and straight joists.” - An undergraduate student

“Today was slightly anti-climactic. It’s really too bad that we don’t get to see the walls go up... I learned a lot in this course. A very different hands-on approach is extremely enjoyable and I think I’d do something like this again... Now I know how everything is dependent on everything!” - An undergraduate student

Monday, June 27, 2005: I find Richard near the food tent. He tells me that I need to use the windows that were delivered. I tell him that the delivered windows do not match the rooms that need windows. He says that the trusses are coming, that the walls need to be up, and that he does not have the money to buy new windows. Then he says that the problem was I never specified that the windows on the list I provided were different from the windows shown on the drawings. I say that the delivered windows do not match the drawings of the house. He says that the windows match the drawings that he submitted for permit. I say that they do not match any drawings that I have ever produced of the house. He says again that I did not specify on the list of windows that they were different from the drawings. I say that I do not know which drawings they were using, but the windows do not match any drawings that I have produced. I say that I told both him and Doug how important it was to order the exact dimensions on the list I supplied because of the prefabrication of the wall panels. He tells me that the drawings he submitted for permit were all that he had. I tell him that the drawings were ready and that Orchard Design had them weeks before he submitted for permit. I tell him that the windows do not even match the draft plan that I gave him at Tim Hortons, which he just used to pour the footings wrong. He says that the plan did not have draft written on it. I say that I told him the plan was not finished, that I told him the same thing when I gave him the elevations for the heat loss and heat gain calculations, that I told him the windows shown on those elevations needed to be reviewed and revised, and that even if he had used any of the drafts I gave him the windows would be much closer to being correct. I ask him why he cannot use the windows for the neighbouring house. He says that the manufacturer will want to drive by the house and see their windows in it. He says that Doug lost one window sponsor and he cannot afford to lose another. He asks me why I cannot use the windows for the front wall of the house. I say that there is one six-foot-wide and one four-foot-wide window to fit in and that ten feet of window in that wall will run into the master bedroom closet. He tells me to get the walls up and says that we will look at what windows we can fit in and what we need to order afterwards.

As I climb up onto the incomplete floor deck. I am not happy. I am not happy that we cannot install the windows and complete the siding before we erect the panels. The test will be incomplete. I will not know if my theories are sound. I will not know if it really

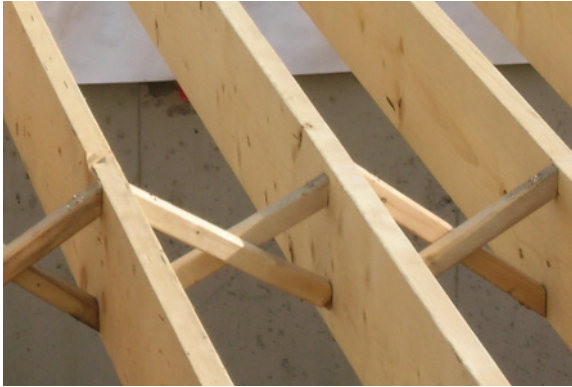

Windows Requested May 8th	Windows Delivered June 24th
Master - 3'6-1/2"w x 4'8"h Casement	5'11"w x 4'7"h Casement
Master- 3'6-1/2"w x 4'8"h Casement	3'11-1/4"w x 4'7"h Casement
Bed 2 - 3'7-1/4"w x 4'0"h Slider	3'11-1/4"w x 3'11-1/4"h Casement
Bed 3 - 3'7-1/4"w x 4'0"h Slider	3'11-1/4"w x 3'11-1/4"h Casement
Bed 4 - 3'7-1/4"w x 4'0"h Slider	4'7"w x 5'3-7/8"h Casement
Bath - 1'9-1/2"w x 3'4"h Casement	3'3-1/4"w x 3'3-1/4"h Casement
Kitchen - 3'7-1/4"w x 3'4"h Slider	

Top Left: **2.176** Installed cross bridging.

Top Right: **2.177** Nailing sheathing to the rim boards.

Above: **2.178** A table showing what windows were requested and what windows were received.

works. They did not have to take on this project. They have shown themselves to be unable and uncooperative. The windows are the latest, and best, example of this.

I am also not happy that the joists around the stair opening were installed incorrectly. Although I am less unhappy about it then I was on Saturday when, at the end of a long day in very humid thirty-four degree heat, I was pulling freshly glued OSB floor sheathing off of these same joists. Still, I am not happy to now be pulling nails out of joist hangers (2.179). The graduate student that I charged with the important task of framing the stair opening and installing the surrounding joists left the joist installation to an overconfident undergraduate student whose work he failed to check. It will take us all morning to fix the mistake.

From an e-mail to my advisors, Terri Meyer Boake, Mike Elmitt, and John Straube, Tuesday, June 28, 2005:

We finished the floor deck today (2.180). It is sheathed and the headerwrap has been stapled up (2.181, 2.182, page 182). The work that we completed today is what Habitat was supposed to provide us with 11 days ago (plus backfill)...

The trusses were delivered today (2.183, page 182).

I requested a backfill. The response I received was to “not count on it.”

A reporter and a photographer visited from the Record today, so look out for an article (2.184, page 183).

With the floor deck complete we can erect the wall panels, whether or not they are complete.



Left: **2.179** Pulling a nail out of a joist hanger.

Below: **2.180** The completed floor deck.





Top Left: **2.181** Straightening joists and nailing down the sheathing.

Top Right: **2.182** Folding the Tyvek at a corner of the floor deck.

Above: **2.183** The roof trusses arrive.

Facing Page: **2.184** An article in the Record newspaper, June 29, 2005.

# Habitat for Humanity role helps architecture student

BY BARBARA AGGERHOLM  
RECORD STAFF

## CAMBRIDGE

At the family home of master's architecture student Carolyn Bilson, there's lots of light, warmth and space for everyone.

Renovated by her dad and made welcoming by her mom, her mid-sized Toronto home is the place where Bilson's friends all seem to end up.

Now, as much as she is able, Bilson, 25, would like to design and build homes that give the same sense of comfort to their owners as her childhood home gives her.

She hopes that Laurie and Sean Baker and their four children will be happy in the Habitat for Humanity house in Cambridge that she helped design and is now helping to build.

"I'm trying to take my house and give that to other people through design," Bilson said yesterday at the Habitat construction site on Schlueter Street.

Yesterday, as the scorching sun beat down on their backs, Bilson and five other master's students from the University of Waterloo's School of Architecture in Cambridge were hammering the sub-floor on one of three Habitat for Humanity houses under construction on the street.

With water bottles hanging from their tool belts, the sweating students watched each other closely to see that the 34 C heat didn't cut them down.

"This heat is slowing us down terribly," Bilson said, wiping her forehead under an orange hard hat. "The biggest challenge is preventing sunstroke."

At the rear of a nearby tent, prefabricated interior and exterior wall panels constructed in the school's shop by the master's students and 31 architecture undergraduates were waiting to be erected.

It's the fifth year that architecture professor Terri Boake has run an elective course in which students can get hands-on experience working for Habitat for Humanity, which builds affordable homes for low-income families.

Yesterday, Laurie Baker was working on her own house and her neighbour's Habitat for Humanity home as well.

"There's a lot of scrapbook memories here," she said. "We're really getting to know each other."

For Bilson, who has participated in several



Carolyn Bilson helped design the Habitat for Humanity house that she and other volunteers are working on in Cambridge.

Habitat for Humanity projects, experience on a construction site is necessary to becoming a good architect.

"I always think of building as the grammar that an architect needs to write," she said. "If you don't know your grammar, you can't write well."

Her experience with Habitat for Humanity is also giving her information for her master's thesis, which is examining how Habitat can build more and better homes, by making good use of prefabrication.

While looking at how to keep costs down and minimize waste in the construction of prefabricated parts, Bilson is also focusing on improving communication among workers.

With a short building season and the organization's reliance on volunteers, Habitat needs to communicate building instructions clearly, she said. On other builds, she has seen wall panels that didn't fit or were made from the wrong materials. So she wrote construction sheets and diagrams for undergraduate students who were building the prefab walls.

The design of the Baker's four-bedroom bungalow, sponsored by area Lions Clubs and Lions Clubs International Foundation, is slightly different from other Habitat homes.

Bilson was asked to adapt the plans to suit a family with two children who are disabled. That result: bedrooms visible from other rooms, wider doors and larger spaces to allow wheelchair access, a ramp leading to the entrance and a carport.

She's anxious to measure students' success in building the prefabricated walls. When her thesis is finished, she'll share the results with Habitat.

"It should work," said fellow master's student Mike Garforth. "It's going to be interesting when the first walls go up."

## Wall Panel Erection

Wednesday, June 29, 2005: In groups of four we carry the exterior wall panels from one end of the site, through the food tent and down the road, to the house at the other end of the site (2.185, 2.186). Once there we slowly climb two slanted sets of stairs, which bridge the gap over the excavation, up onto the floor deck (2.187).

We have two days to erect and cap all of the wall panels. After tomorrow the affiliate's build schedule has them working on another site for three weeks. I will also lose the help of my fellow graduate students; their commitment to me of labour and feedback ends tomorrow, as it did for most of the undergraduates on Saturday. This morning eight undergraduate students who need to make up for a missed class are on-site. They are the only undergraduates who will see the wall panels, which they spent weeks building, start to come together and help to form a house.

I guide them through the erection of the first exterior wall panel: we lift the wall panel into place, ensure that it is flush with the edge of the floor deck, drive nails through the bottom plate of the wall panel into the framing below, use a level to plumb the wall panel, and finally secure it with a pair of temporary braces (2.188-2.190).

One after another the wall panels go up (2.191-2.193, page 186). I keep the wall panels moving and I make sure they are erected where they should be (2.194-2.197, page 186). One of the graduate students takes charge of the detailed installation of each wall panel; he ensures that the walls are plumb, that neighbouring panels are aligned, and that the joints between panels are tight (2.198, 2.199, page 187). Another graduate student stands on a ladder in the excavation and ensures that the panels are aligned properly on the exterior of the house (2.200, page 187). They call me in to advise when neighbouring panels are difficult to align, to approve alignments as close enough, or to persuade a wall panel into place with a sledge hammer (2.201, page 187). Unfortunately, in storage many of the wall panels became infested with earwigs. As I hit the wall panels with the sledge hammer they rain down.

By the time the undergraduate students leave at lunch we have erected fifteen exterior wall panels. The three longest walls of the house are complete (2.202, page 187, 2.203, page 188).

After lunch we move and erect two more exterior wall panels, we move all of the interior wall panels up onto the floor deck, and we start to erect the interior wall panels (2.204- 2.206, page 188).

We have half of the interior wall panels erected when we run out of polyethylene vapour barrier to install where the interior walls intersect the exterior walls (2.207, page 189). It is late in the afternoon and I am glad to stop work for the day (2.208-2.210, page 189).





Above Left: **2.185** Carrying an exterior wall panel through the food tent.

Above Right: **2.186** Carrying an exterior wall panel down the road.

Left: **2.187** Carrying an exterior wall panel up onto the floor deck.

Below Left: **2.188** Lifting the first exterior wall panel into place.

Bottom Left: **2.189** Nailing through the bottom plate into the rim joist below.

Below: **2.190** The first erected wall panel.







Facing Page Top: **2.191-2.193**  
Erecting the first wall of exterior wall panels.

Facing Page Bottom: **2.194-2.197**  
Carrying and erecting a wall panel.

Far Left: **2.198** Using a clamp to align neighbouring wall panels.

Left: **2.199** Using a level to check if an erected wall panel is plumb.



Far Left: **2.200** Ensuring that two wall panels are aligned properly on the exterior of the house.

Left: **2.201** Driving a wall panel into place with a sledge hammer.

Below: **2.202** View of the completed walls from the exterior of the house.





Above: **2.203** View of the completed walls from the interior of the house.



Right: **2.204** Erecting exterior wall panels near the front of the house.

Below: **2.205, 2.206** Erecting interior wall panels.





Above Left: **2.207** Installing polyethylene vapour barrier to an exterior wall where an interior wall panel will be installed.

Above: **2.208** Erected interior wall panels at the end of the day.

Left: **2.209** Erected interior wall panels at the end of the day.

Below: **2.210** View of the erected walls at the end of the day.



Thursday, June 30, 2005: Two interior wall panels are too short due to errors I made on their diagrams. We make them longer (2.211). One interior wall panel is too long because the basement stair opening is narrower than I specified. We make it shorter (2.212). The gap between the exterior wall panels in the frontmost wall of the house takes all of the clamps that we can find to close it (2.213, 2.214). The bow in the bottom edge of the exterior wall panel next to the front door takes all of the people that we can find to straighten it out (2.215). The six of us work steadily, but not rushed, and we have all of the wall panels erected by early in the afternoon.

We must still staple strips of polyethylene vapour barrier to the top of all the walls and then install a capping plate (2.216, page 192). While the installation of this second top plate is standard framing practice, it is not required here since the roof trusses are spaced identically to, and will sit directly above, the studs in the wall panels. I have chosen to use the capping plate to strengthen the connection between neighbouring wall panels (2.217, page 192).

While most of the graduate students work to cap the walls, I work with another graduate student to install shims in the gaps at the corners of the house (2.218, 2.219, page 192). During the prefabrication of the wall panels I unscientifically shortened the last wall panel in seven of the eight exterior walls of the house by either half an inch or one inch (2.115, page 137). My intent was to make the prefabrication tolerant to minor errors in the foundation and imperfect installations of the wall panels. I was worried that neighbouring wall panels would not fit tightly together and cause the overall length of the wall to grow. As it is easier to add to the length of a wall than to shorten a wall, I cut the last wall panel in each wall short. The resulting gaps at the corners of the house range from half an inch to one and one-quarter inches (2.220, page 193). In each case the gap is equal to or greater than the amount by which I shortened the wall, which suggests that shortening the walls was not necessary. However, each wall of the foundation is longer than specified (2.166, page 174). If the foundation were perfectly accurate, and I had not shortened the walls, five of the seven walls would be too long.

Without haste we have erected and capped all of the wall panels in two days (2.221-2.223, page 194). The house is ready for roof trusses.

I am doing the last walk through of the day, to make sure that nothing has been left behind in the house, when — for the first time — Richard comes to take a look. He was leading a group to erect roof trusses on the neighbouring house today. Janice led the framing of the walls for the same house, which they completed yesterday (2.224, page 194). Richard tells me that I surprised him. He says that we have done a good job and that he left us alone because when he looked over he could see that we knew what we



Top Left: **2.211** Strips of wood ready to be attached to the end of an interior wall panel to make it longer.

Top Right: **2.212** A partially disassembled wall panel ready to be cut shorter.

Above Left: **2.213** The gap between the two exterior wall panels in the frontmost wall of the house.

Above: **2.214** Using clamps to close the gap between the wall panels in the frontmost wall of the house.

Left: **2.215** Using body weight to flatten the bow in the bottom plate of a wall panel.



Top: **2.216** Installing a second top plate across the top of the erected wall panels.

Above Right: **2.217** A second top plate installed across the tops of neighbouring wall panels.

Right: **2.218** The gap between exterior wall panels at a corner of the house.

Far Right: **2.219** Driving a screw to secure a shim between exterior wall panels at a corner of the house.





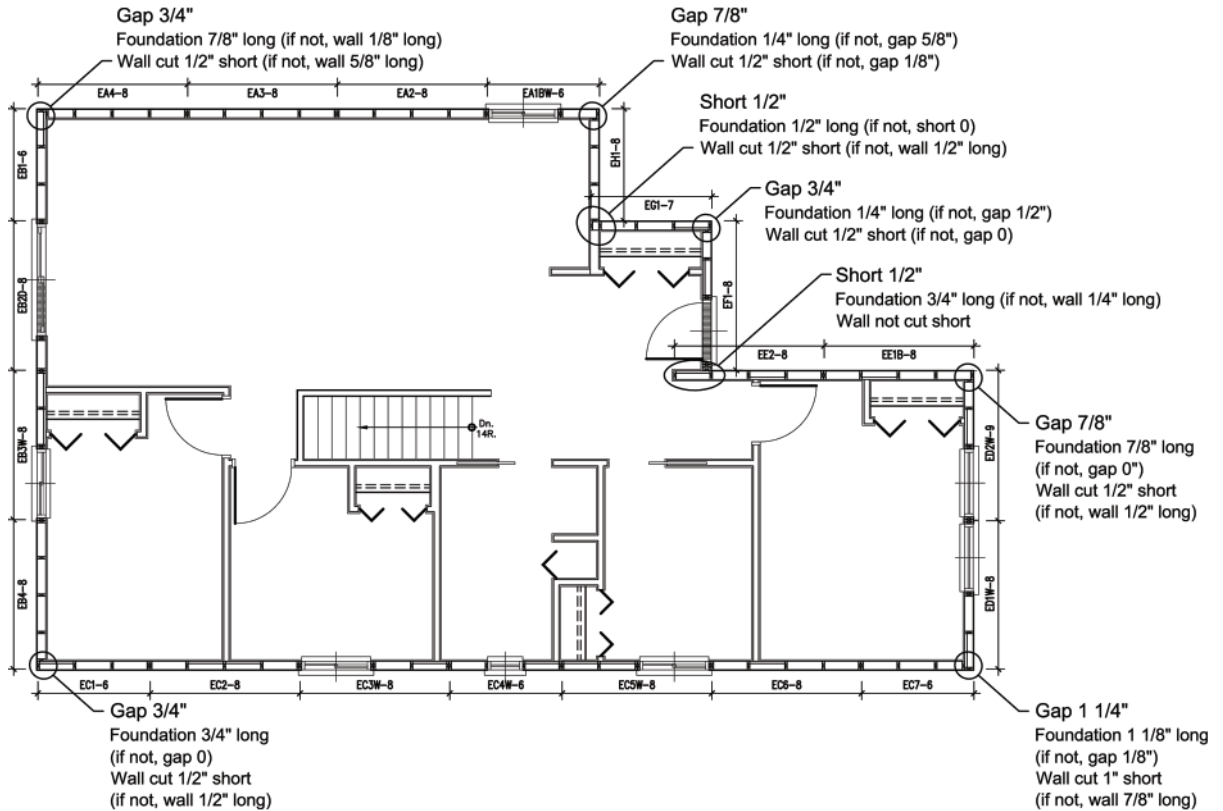

2.220 Diagram indicating the size of the gap between exterior wall panels at each corner of the house and whether the shortening of each wall was necessary.

were doing. He says that this site will be shut down, because they are moving to another site next week, but he wants to have both sites running the week after so that we can get the roof up. I have a week off.

Comments from graduate student task sheets, June 30, 2005:

“I must say that I was impressed that all of the exterior panels and most of the interior panels fit as planned. There were so many elements that could have countered a good result: the panels warping and expanding with outdoor storage, potential errors in foundation, human error in design and fabrication, and damage during shipment. The system essentially worked and most errors were discovered before they became serious issues.”

“Work done on site was far more intense than the work done in the shop. Since the shop was an air and temperature controlled environment fatigue did not come into play. While working on-site I noticed that the amount of production drastically declined in some cases. Since the heat was so incredible I found it very hard to focus for an extended period of time. Decisions that would have initially been quite straight forward all of a sudden became difficult...”

“I learned so much about construction techniques, process and administration, but also about leadership skills, management, quality control and team reliance. It is not only important to know and understand the materials and task at hand but how to communicate it effectively to your team and execute the task safely and efficiently.”



Top: 2.221, 2.222 Erected and capped interior wall panels.

Middle: 2.223 Erected and capped exterior wall panels.

Above: 2.224 The house and the neighbouring house at the end of the day when the site shuts down.

## Weathertight

Tuesday, July 12, 2005: The site is up and running again. I return without the labour of my student workforce, but now I am only responsible for myself and the house. I need to make the house weathertight by installing the windows and constructing the roof; I need to complete the vinyl siding and, where I can, test the connection of the vinyl siding across the joints between panels; and I need to see what effect, if any, the prefabrication of the wall panels has on the construction of the rest of the house.

The site runs for three days before shutting down again. There are not enough volunteers. We work only one afternoon on the erection of the roof trusses. After dangerously lifting eleven thirty-foot-long trusses across the, still unbackfilled, excavation and up onto the top of the walls, we erect the first thirty-foot-long truss — the hip girder — and eight jack trusses at the back of the house (2.225, 2.226). For most of the three days I work with Janice and one volunteer on the roof of the neighbouring house. We install the additional framing required between the erected trusses to complete the hips and valleys of the roof (2.227). I have never done this before. In fact, before erecting those first few trusses I had never constructed any part of a roof.

At the end of the third day Janice tells me that the site will be shut down for the next ten days. She also tells me that Richard is ordering new windows.

Monday, July 25, 2005: I return to the site. The excavation is backfilled and there are volunteers: future homeowner, Sean Baker, and four of his friends. Unfortunately, only two of them will climb a ladder. We manage to erect the ten remaining thirty-foot-long trusses and the remaining jack trusses at the back of the house (2.228).

Tuesday, July 26, 2005: It is raining heavily. We drill holes through the subfloor to drain the growing pools of water into the basement. When lightning is not lighting up the sky we erect eight more trusses (2.229, page 198). The day is called on account of rain and I drive Richard's pick-up truck to Home Depot to buy the posts and beams for the carport. The Materials Manager, Doug Freure, no longer works for the affiliate.

Wednesday, July 27, 2005: The concrete piers do not line up. Richard says that they shifted during the backfilling. In order for the carport posts to not hang too far off of the concrete piers the carport must now be set back from the front wall of the house and be built deeper and out of square (2.230, page 198). The beam pockets are made wider to accommodate the new location of the

Facing Page Top: 2.225 The erected hip girder with jack studs behind.

Facing Page Middle Left: 2.226 Future homeowner Sean Baker nailing a raised heel truss in place.

Facing Page Middle Right: 2.227 The additional framing installed at a valley.

Facing Page Bottom: 2.228 The erected roof trusses from the back of the house.





Top: **2.229** The erected roof trusses.

Above: **2.230** A carport post sitting off-centre on a concrete pier.

Above Right: **2.231** Using a reciprocating saw to widen a beam pocket.



Left: **2.232** The posts are over nine inches too high when they, and the beam at the front of the carport, are erected.

Below Left: **2.233** The carport beam seated in its beam pocket at the front of the house.

Below: **2.234** The erected roof trusses, carport posts, and carport beam.



beams (**2.231**, page 198). It then takes three tries to raise the front beam and its two attached posts: first the posts are over nine inches too tall (**2.232**, page 199); then one of the posts is an inch short; finally it is just right, but by then it is the end of the day (**2.233**, **2.234**, page 199).

Thursday, July 28, 2005: Five of us erect the rest of the posts and beams for the carport, the rest of the trusses on the main house, and half of the trusses on the carport before the volunteers leave early (**2.235**, **2.236**).

Friday, July 29, 2005: We erect the last of the trusses (**2.237**), build the overhangs on the gable ends, and begin to install the fascia boards. Despite my best efforts the heel of the roof trusses were manufactured three-quarters-of-an-inch too tall. In order for the soffit to line up with the preclad wall panels a strip of plywood is nailed to the bottom edge of every fascia board before it is installed (**2.238**).

After the volunteers leave early for the long weekend I work with Janice on framing the hips and valleys (**2.239**).

Tuesday, August 2, 2005: The Texans are here. They have their own tools. Where the fascia board is not complete they install it. Where the fascia board is complete they start to install the roof sheathing (**2.240**, **2.241**, page 202). Janice and I work just ahead of them to complete the hip and valley framing. They move fast; we have trouble. Moving the carport back has put the roof of the carport out of plane with the roof of the main house. It takes us a few attempts to make it look like the two line up.

Friday, at the end of three-and-a-half days the sheathing is complete, including the sheathing on the gable ends (**2.242**, page 202). If not for Janice and I slowing things up they would have finished sooner. The roof is ready when the shingles are delivered (**2.243**, page 202). Professionals are scheduled to shingle the roof tomorrow.

The Texans leave and the site shuts down for another week.

Monday, August 15, 2005: The shingles are brown, not the black and grey that I requested. We tape the exterior side of the joints between panels (**2.244**, page 203) and we start to install the vented vinyl soffit around the perimeter of the house. We cannot install the aluminum fascia; the strip of plywood nailed to the bottom of the fascia board has made the aluminum fascia too short (**2.245**, page 203).

The new windows arrive. They are the right size. We install all of them (**2.246-2.248**, page 203).

Facing Page Top Left: **2.235** The erected roof trusses, carport posts, and carport beams.

Facing Page Top Right: **2.236** Steel straps tying the beam at the rear of the carport to the exterior walls of the house.

Facing Page Middle Left: **2.237** Erecting roof trusses on the carport.

Facing Page Middle Right: **2.238** Sketch showing the strip of plywood required across the bottom edge of the fascia boards.

Facing Page Bottom: **2.239** Janice Tessman working on the roof to complete the hip and valley framing.



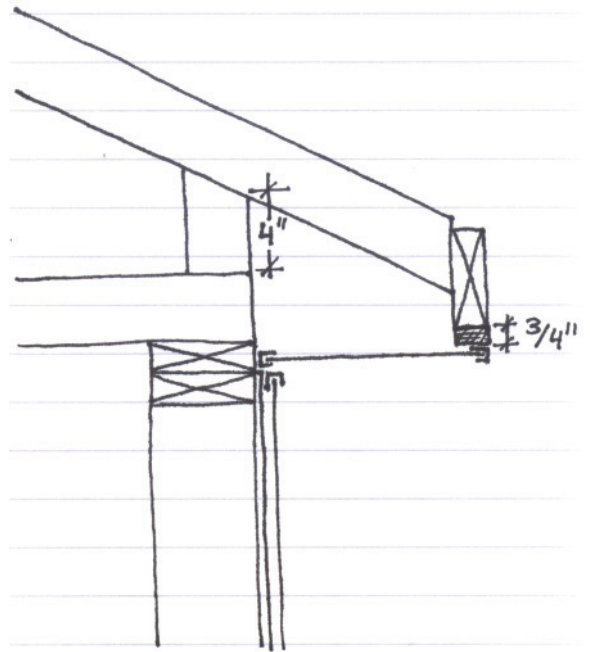



Above: **2.240** Driving a nail at the corner of a sheet of OSB roof sheathing to secure it in place.



Above Right: **2.241** Using a nail gun to complete the nailing of the roof sheathing.



Right: **2.242** Installing plywood sheathing on the gable end of the carport.

Below: **2.243** Bundles of shingles on top of the complete roof sheathing.





Top Left: 2.244 Taping over the vertical joint between exterior wall panels.

Top Right: 2.245 The aluminum fascia is too short due to the extended fascia board.

Left: 2.246 Installing a window.

Above: 2.247 A level indicating a level sill plate in a shop built window opening.

Below Left: 2.248 Installed windows.



A large group of Mennonites arrived this morning to work on the third house. They framed all of the walls and erected all of the trusses by the end of the day (2.249).

Tuesday, August 16, 2005: We continue to install the soffit, we install siding trim around the windows (2.250), and we install both the front door (2.251) and the sliding door at the back of the house. They are the doors from the first window delivery. They do fit; unfortunately their beige frames do not match the siding.

The Building Inspector arrives for the framing inspection. The house passes. The Inspector only requests that I install two blocks of wood to better support the peaks of the two hips roofs (2.252). He says that the quality of work is equivalent to the custom home builders in the area.

I call Hogie at Gentek. I am looking for the missing pieces of five-inch-wide window surround trim. They are an important part of the horizontal band of siding which will cover the perimeter of the floor deck and they should have arrived by now. Hogie says that someone called and told him that we do not need them anymore. I tell him that we do need them. He says that they are ready to be picked up.

Wednesday, August 17, 2005: Richard now introduces me to the volunteers in the morning with a speech about not judging a book by its cover. I spend the day inside the house leading a group of volunteers to install insulation, polyethylene vapour barrier, and premade frames for the pocket doors (2.253-2.255, page 206). Richard has scheduled the Building Inspector for tomorrow morning to inspect the insulation and the vapour barrier. Below us, in the basement, a volunteer named Glenn leads a few other volunteers to pour the concrete floor slab.

Thirteen lengths of five-inch-wide window surround trim arrive.

Thursday, August 18, 2005: While the volunteers complete the soffit and install framing for insulating the interior of the foundation wall (2.256, page 206), I start work on the horizontal band of siding around the perimeter of the floor deck. I do not get very far. Three of the thirteen lengths of five-inch-wide window surround trim are the profile I expected; the remaining ten lengths are a different profile (2.257, 2.258, page 207). The profiles are two different depths and lock into two different profiles of starter (2.259, 2.260, page 207).

I call Hogie at Gentek. He says that I have three lengths of the old window surround profile and ten of the new profile. I tell him that I have the correct starter to install the old profile. He says that he will try to find more pieces of the old profile by calling the other distributors and that he will call me back in an hour.



Left: **2.249** The third house with the walls and roof trusses erected by a group of Mennonites in one day.



Above Left: **2.250** Undersill trim installed beneath and beside a window.

Above: **2.251** The installed front door.



Left: **2.252** A block of wood installed to better support the peak of a hip roof as requested by the Building Inspector.



Top Left: **2.253** Installing insulation.

Top Right: **2.254** Installed polyethylene vapour barrier.

Above Left: **2.255** An installed pocket door frame.

Above Right: **2.256** Assembling two-by-four wood framing in the basement for insulating the interior of the foundation wall.

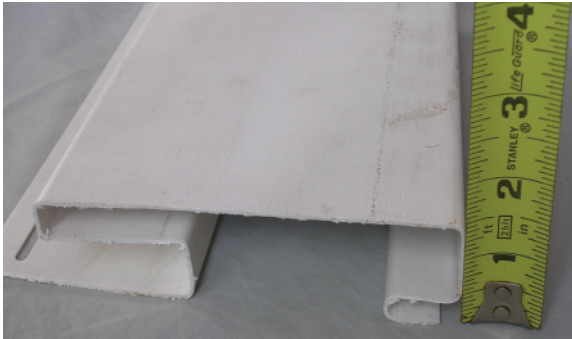

Top Left: **2.257** The expected profile of five-inch-wide window surround trim.

Top Right: **2.258** The unexpected profile of five-inch-wide window surround trim.

Above Left: **2.259** The expected window surround profile locked into an undersill trim.

Above Right: **2.260** The unexpected window surround profile locked into a starter strip.

The house passes the insulation and vapour barrier inspection.

Friday, August 19, 2005: I call Hogie at Gentek. He is away until Monday. We install drywall.

Saturday, August 20, 2005: We install drywall.

Monday, August 22, 2005: I call Hogie at Gentek. He says that the profile which he thought was the old profile is actually the new profile. It used to be the old profile, after they switched manufacturers, but they switched manufacturers again and now it is the new profile. He says that he was unable to find more of either profile, but he will exchange the starter pieces I have for the ones I need to install the ten lengths of the old profile.

We finish installing the drywall (2.261).

Tuesday, August 23, 2005: We have new vinyl fascia material that can be cut to the nonstandard height that we need (2.262). It is not grey, like the original aluminum fascia; it only comes in white. A white fascia will actually help with the transition from the grey siding to the brown shingles. I lead two volunteers to install this fascia and two others to install the large soffit beneath the carport (2.263). I also try to figure out how to work with the two different depths of five-inch-wide window surround. The profile that I did not expect, which I now have two-hundred linear feet of, is shallower than the three-and-a-half-inch-wide window surround pieces which cover the vertical joints between panels. Where the two intersect the vertical joint cover overhangs the horizontal band below. It looks bad (2.264).

Inside, a professional begins the taping of the drywall (2.265).

Wednesday, August 24, 2005: While two volunteers complete the vinyl fascia and two others complete the carport soffit (2.266, page 210), I install a pressure treated board beneath the front door of the house. The wheelchair ramp will be attached to this board. On either side of the board I install the starter pieces for the horizontal band of siding (2.267, 2.268, page 210). I have decided to install the original profile of five-inch-wide window surround on the front wall of the house and on the walls beneath the carport. I have also decided that along the rest of the walls, where the other profile will be installed, I will first fur out the perimeter of the floor deck to compensate for that profile's shallower depth. I drive to Home Depot and buy pressure treated plywood for the furring.

Thursday, August 25, 2005: I have five volunteers for the day to work with me on the vinyl siding. First we install strips of pressure



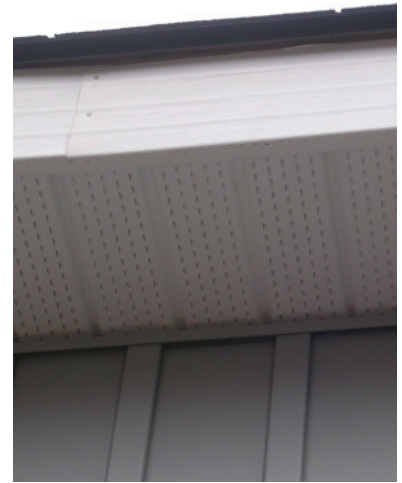

Top Left: **2.261** Drywall installed.  
 Top Right: **2.262** White vinyl fascia installed below the brown shingles and above the white soffit and the grey siding.  
 Above Left: **2.263** Installing the vinyl soffit beneath the carport.  
 Above Right: **2.264** The vertical joint cover overhanging the shallower profile of five-inch-wide window surround trim.  
 Left: **2.265** Drywall taped.



Top: **2.266** The complete soffit beneath the carport.

Middle: **2.267, 2.268** Starter pieces for the horizontal band of siding nailed to the rim board.

Right: **2.269** Pressure treated plywood nailed to the rim board to fur it out for the installation of the shallower profile of five-inch-wide window surround trim.





Above Left: **2.270** Installing the starter pieces for the horizontal band of siding.

Above Right: **2.271** Installing the shallower profile of five-inch-wide window surround trim.

Left: **2.272** Completing the horizontal band of siding by installing a white board and batten siding panel oriented horizontally.

Below Left: **2.273** Installing a piece of three-and-a-half-inch-wide window surround trim over a vertical joint between panels.

Below: **2.274** Installing a piece of three-and-a-half-inch-wide window trim alongside a window.



treated plywood to fur out the perimeter of the floor deck (2.269, page 210). Then we install the starter pieces and the shallower five-inch-wide window surround trim to the plywood (2.270, 2.271, page 211). Half of the group then works to complete the horizontal band, while the other half starts to install three-and-a-half-inch-wide window surround pieces over the vertical joints between the panels and alongside the windows (2.272-2.274, page 211).

Friday, August 26, 2005: Graduate students Mike Garforth and Keith Button return to help me by completing the siding on the front wall of the house (2.275). Two other volunteers spend the morning installing the remaining pieces of three-and-a-half-inch-wide window surround trim over the joints and at the inside corners. Then they spend the afternoon completing the siding between these joint covers — or corner pieces — and the siding on the preclad wall panels (2.276-2.278). They do not have any problems. I switch between instructing, supervising, and completing the rest of the horizontal band.

Monday, August 29, 2005: The site opens at noon. I have one volunteer. We complete the siding on the walls beneath the carport (2.279).

Tuesday, August 30, 2005: I have two volunteers. They install board and batten siding panels (2.280, page 214). I work ahead of them uninstalling and reinstalling crooked pieces of trim. They complete the siding on two more walls of the house (2.281, 2.282, page 214). I remove improperly installed siding from a preclad wall panel. The siding on the panel has already been removed once before (2.283, page 214).

Wednesday, August 31, 2005: One volunteer and I complete the siding on the back wall of the house (2.284, page 214). We also replace badly installed and damaged pieces of vinyl fascia (2.285, 2.286, page 215).

Inside, Laurie Baker and a few volunteers paint (2.287, page 215).

Thursday, September 1, 2005: In the morning two volunteers install siding on the gable end of the carport (2.288, page 215). I fix two preclad wall panels where a number of the siding panels were installed too high or were not installed high enough (2.289, 2.290, page 215). By noon all of the vinyl siding is finally complete.

My remaining obligation to the construction of the house is to cover the carport beams with aluminum. I have almost no experience with aluminum. It is a delicate material to work with. I

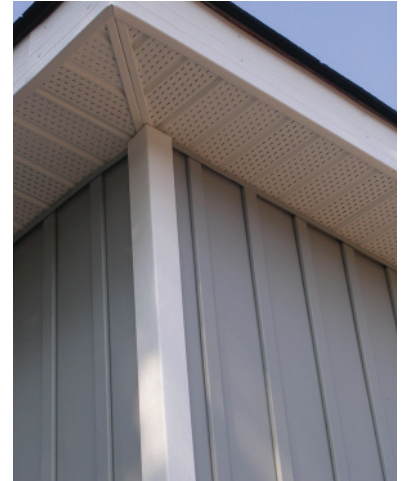

Top: **2.275** Siding complete on the front wall of the house.

Above Left: **2.276** Installing a trimmed to fit siding panel into a corner piece and beneath the last siding panel of a preclad wall panel.

Above Middle: **2.277** Locking the last siding panel of a preclad wall panel into place.

Above Right: **2.278** Siding complete at a corner of the house.

Left: **2.279** Siding complete at the front door of the house.



Top Left: **2.280** Installing board and batten siding panels above a window.

Top Right: **2.281** Siding complete on the North elevation.

Above: **2.282** Siding complete on the South Elevation.

Above Right: **2.283** A wall panel with improperly installed siding removed.

Right: **2.284** Siding complete on the back wall of the house.





Above Left: **2.285** Poorly installed vinyl fascia.

Above: **2.286** Repaired vinyl fascia.

Left: **2.287** Primed walls.

Below Left: **2.288** Installing siding on the gable end of the carport.

Below: **2.289** A siding panel that is installed too high.

Bottom: **2.290** Siding panels that are installed too low.



asked Janice for her assistance. I thought she agreed, but she is now unwilling.

It takes me all afternoon and several stores to find an aluminum break to rent.

Friday, September 2, 2005: An equally inexperienced, but patient, volunteer and I manage to bend and install two seven-foot-long sections of aluminum before the site is shut down at noon for the long weekend (2.291).

Tuesday, September 6, 2005: By early in the afternoon two volunteers and I are able to complete the aluminum on the carport beams (2.292, 2.293). The exterior finishing of the house is complete over two months late (2.294).

Janice has asked me to stay and lead the completion of the house. A wheelchair ramp and a back deck still need to be built. The site needs to be landscaped. Inside, the floor, trim, fixtures, and cabinetry need to be installed. I imagine myself working every day for the next three months, each day with one, two or no volunteers. I imagine myself begging for materials and assistance. I imagine myself accused of others' mistakes.

I have completed my obligations: I have done what I said I would do and I have what I need for my thesis. Although the house is unfinished, I leave the site.















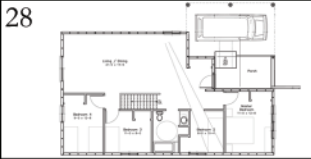











Left: **2.291** The first section of aluminum installed to a carport beam.





















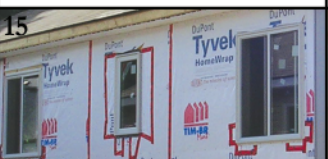





Below Left: **2.292** Installing aluminum to a carport beam.

Below: **2.293** Making small bends in a section of aluminum by hand before its installation.

Bottom: **2.294** The exterior finishes are complete.



Month	Day of the Week						
	Monday	Tuesday	Wednesday	Thursday	Friday	Saturday	Sunday
April	25 	26	27	28 	29	30	1
May	2	3	4	5	6 	7	8
	9	10	11	12	13 	14	15
	16	17	18 	19	20 	21	22
	23	24 	25 	26	27 	28	29
June	30	31	1 	2	3 	4	5
	6	7	8 	9	10	11	12
	13 	14	15 	16	17 	18	19
	20 	21	22 	23 	24 	25 	26
	27 	28 	29 	30 	1	2	3

Month	Day of the Week						
	Monday	Tuesday	Wednesday	Thursday	Friday	Saturday	Sunday
July	4	5	6	7	8	9	10
	11		13	14	15	16	17
	18	19	20	21	22	23	24
						30	31
August	1					6	7
	8	9	10	11	12	13	14
					19		21
						27	28
						3	4
September	5						

2.295 Graphic calendar.



## **Reflections**

On Dedication	222
On Prefabrication	228

## On Dedication

October 8, 2005: One more time I walk through the house that I built. I am here for the dedication ceremony. Volunteers and their families are here. The Baker Family and their friends are here (3.1). Janice is here, Richard is not. The house is still unfinished. The electrical fixtures are installed and a steep wood ramp with no railing now leads to the front door of the house (3.2). Everything else is the same as when I left. I find it appropriate that the affiliate is having a dedication for this house while it is still incomplete, since their dedication to the construction of this house was incomplete.

Before I began working with them on this house, I concluded from my on-site work with other affiliates that for prefabrication to be successful a complete commitment is required — one that extends beyond prefabrication to incorporate design and execution. I still believe this. I also believe that this affiliate was not sufficiently committed to many elements of this project, including — but not limited to — the prefabrication. Deciding to build a house for a family with a disabled child in exchange for sponsorship money required accommodating, where possible, the needs of the family; accepting the student labour for the on-site construction required providing sufficient site preparations for the students to be employed during their scheduled time on-site; and agreeing to the panelization of the house required accommodating changes to the construction process.

Construction of the house began, not with the pouring of the footings, but when we built the first wall panels in the workshop. Materials to complete the prefabrication of the wall panels, from the lumber and screws to the windows and siding, needed to be acquired before the on-site work even began. Once on-site, instead of framing the walls to fit the foundation, the foundation needed to fit the prefabricated walls. Its accuracy became more important and its orientation could not be reversed. Instead of cladding the walls of the house to fit the soffit height created by the roof trusses after their installation, the roof trusses needed to be built to align with the preclad wall panels. The consultants, suppliers, and contractors involved needed to be made aware of the changes to the construction process, and when resistance was met, they needed to be convinced of the necessity of the requested accommodations.

What I do not know is why the affiliate's commitment to the project was so lacking. Perhaps they did not recognize the benefits that the student labour and the prefabrication were providing to them. Perhaps they had difficulty understanding the needs of the family and the changes required to the construction process. Perhaps they were unable to convince others to make the necessary accommodations for the project, because they were not convinced of the project's merit themselves.



**3.1** The Baker Family poses for pictures in their new living room.

**3.2** A steep wood ramp with no railing leads to the front door of the house.

I am handed a copy of the program for the dedication (3.3). The ceremony is about to start. I read through the list of volunteers on the inside of the program. There are two-hundred and thirty-eight names. My name is not one of them. My name is not listed anywhere on the program.

I think — not for the first time — that perhaps their lack of commitment to the project was an attempt to distance themselves from me and what they believed was the project's impending failure.

They underestimated my dedication to the project. I wanted to build a house. I wanted to turn my ideas into reality and to test the validity of my theories. I became willing to do anything to achieve my goals. I not only agreed to, but I pushed for, a construction schedule that gave me little time to develop my ideas, design the house, and prepare drawings for the panelization. I ignored the affiliate's lack of commitment to the project and my lack of trust in the affiliate. I violated one of my own design guidelines to "use readily available materials" when I used uncommon vinyl siding profiles to solve the problems associated with precladding the exterior wall panels with vinyl. I unethically revised the grading plan.

While my actions were at times questionable, my dedication to the project was not. I worked hard. I tried to compensate for my lack of experience with effort, but there were limits to what I was able to do — with the time, knowledge, and skills that I had — and there were limits to what I had the power to do. I wanted to build a house, but it is not an individual act. I was dependent on others. The students and the volunteers who helped to build the house; the professors and the administrators of the school that I represented; the consultants, suppliers and contractors who were employed by or donated their products and services to the affiliate; the family who were to live in the house; the sponsors who paid for the house; and the employees and committee members of the affiliate each had their own interests and motivations. I had influence, but no control, over their actions and their commitment to the project.

I now stand as part of the "Circle of Love" with some of these others. The 'circle' of people holding hands snakes around the perimeter of the living room, the kitchen, and the front entrance. In my right hand is Terri's hand; in my left hand is my Mother's. Across the room from me is the Baker family. To their left are the representatives of the affiliate and the sponsors of the house. To their right is a long chain of volunteers. I find the solidarity symbolized by our circle to be somewhat insincere, but each person here did have an effect — some big, some small — on providing a house for the family.

They start to sing. I do not sing; I do not know the words. They are a rough chorus, but one individual to this group. If they were different people this song would sound different. If they



# *Dedication Ceremony*

of the

## **Lions Club/Unruh Family 2005 Building Project**

*Sean & Laurie Baker  
Kevin, Dustin, Kayla & Tyler*

**Saturday, October 8, 2005, 10 am  
120 Schlueter Street, Cambridge ON**

- |  |  |
|--|--|
| 1. <b>Welcome</b><br><i>Chuck Ferguson, HFHWR</i>  | 9. <b>Presentation of Keys</b><br><i>Brenda Clements</i>     |
| 2. <b>Hymn</b>   | 10. <b>Family Comments</b><br><i>Sean &amp; Laurie Baker</i> |
| 3. <b>Opening Devotion</b><br><i>Heidi Sievert</i>   | 1. <b>Blessing of House</b><br><i>Heidi Sievert</i>          |
| 4. <b>Recognition of Sponsors</b><br><i>Chuck Ferguson</i>   | 13. <b>Circle of Love</b><br><i>Chuck Ferguson</i>           |
| 5. <b>Greetings from Local Dignitaries</b><br><i>Chuck Ferguson</i>  | 14. <b>Hymn</b>  |
| 6. <b>Recognition of Volunteers &amp; Donors</b><br><i>Chuck Ferguson</i>  | 15. <b>Benediction</b><br><i>Heidi Sievert</i>               |
| 7. <b>Introduction of Partner Family</b><br><i>Brenda Clements, HFHWR</i>  | 16. <b>House Tour &amp;<br/>Refreshments</b>                 |
| 8. <b>Presentation of Hammer and Bible</b><br><i>Bible: Canadian Bible Society<br/>CMHC Handbook: CMHC<br/>Hammer: Brenda Clements</i> |  |

3.3 Front cover of the program for the dedication ceremony.

were different people the experience of building this house would have been different. Would an increased commitment by the affiliate to the project have changed the outcome? Yes, as would have a decreased dedication on my part. How would each affect the outcome? I do not know. Perhaps the house would have been completed on time; perhaps it would be more behind schedule. Perhaps all of the exterior wall panels would have been complete; perhaps the test would be more incomplete. I do not know how the outcome would be different, but I do know that it so easily could have been different. One test is not enough.



## On Prefabrication

December 2, 2005: I stand before the House Under Construction Demonstration Area at the Construct Canada trade show in the Metro Toronto Convention Centre (3.4). Two years ago I came to this trade show to search for information on prefabricated products and systems that might be useful to Habitat for Humanity. Two years ago I watched a man give a demonstration of an ICF system in front of another “House Under Construction.” This year the House Under Construction Demonstration Area is sponsored by Hitachi Power Tools and Habitat for Humanity Canada. It is my design (3.5).

When Terry Petkau at Habitat for Humanity Canada commissioned me to design the “House Under Construction” he asked me to use prefabrication to enable quick and easy assembly and disassembly of the structure. I agreed to his request. The erection of the wall panels was one of the few activities during the construction of the Baker Family’s house that I consider to have gone quickly and easily. There were a few corrections required and a few panels that were more difficult to install, but the additional work required did not slow progress significantly. If all of the exterior wall panels had been complete, if the windows had been installed and the siding completed, I think the erection would have gone equally well.

This quick and easily erection of the exterior wall panels was supposed to lead to faster project completion — one of the potential advantages of prefabrication that I made note of two years ago during my research into prefabrication. I have not been back to the house since the dedication, but I am told that it is still incomplete. The panelization of the walls did push the completion of the project forward by enabling us to progress from having a completed floor deck to being ready for roof trusses in two days with a small number of low-skilled people. However, the influence of the prefabrication on the timely completion of the project ended once the wall panels were erected.

The other advantages of prefabrication that I made note of during my research were: greater quality control; easier management and training of labour; fewer delays due to weather; and less on-site waste. These words have enhanced meanings for me now. The weather, while it was not an issue in the workshop, did prove problematic on-site. Quality control was definitely easier to ensure in the close quarters of the workshop and the students were easier to manage and train. In fact the training that the students received in the workshop — in construction knowledge and skills; in communication of, and approach to, the work; in taking direction; and in leadership — was undoubtedly beneficial to the productivity of their work on-site. I can only imagine the chaos that would have occurred if these same thirty-six students had been completely

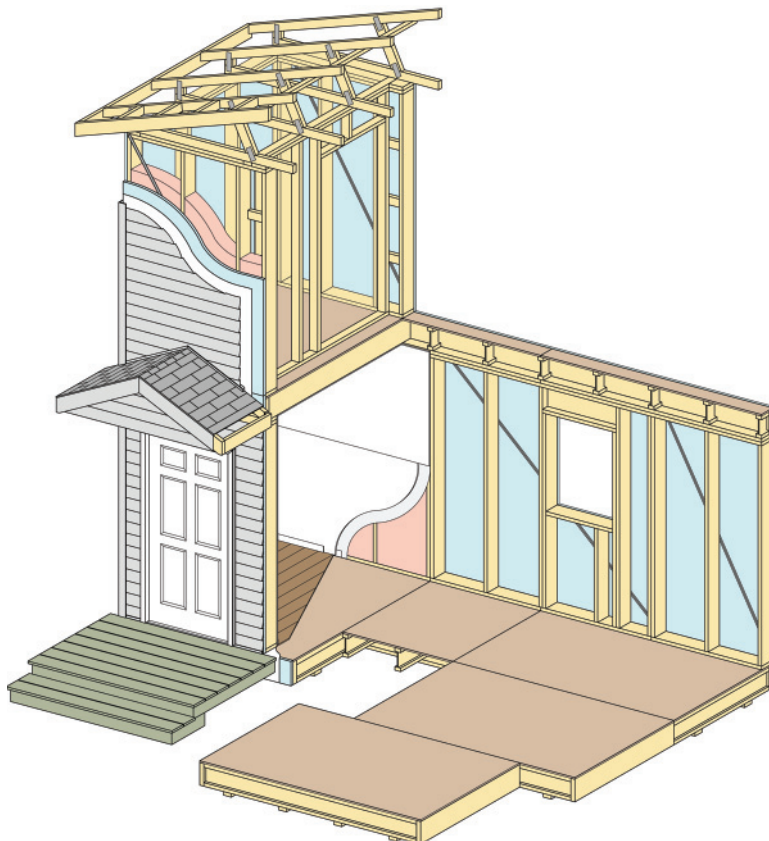

**3.4** House Under Construction Demonstration Area at Construct Canada 2005.

**3.5** Design drawing of the House Under Construction Demonstration Area for Construct Canada 2005.

unskilled when they arrived on-site.

Some of the potential barriers to prefabrication that I similarly made note of, particularly inflexibility with on-site changes and difficulty in acquiring acceptance from builders and tradesmen, also have enhanced meanings for me now. I not only know that these barriers can affect the success of a project, but I understand how they do. My experience building the house painted a picture for me that I found missing from every book I read on prefabrication. I still do not know why particular prefabrication projects succeeded or failed, but I understand how numerous, varied, and intertwined the reasons for a project's success or failure can be. I understand how easy it is for a venture to fail.

I was not available to participate in the assembly of the "House Under Construction," but Terry tells me that it went reasonably well. There were difficulties with properly aligning the prefabricated floor sections on the uneven floor of the exhibit hall and with the accuracy of the window opening in the one wall panel, however the venture appears to be a success. Prefabrication was able to fulfill a need in this small project.

Habitat for Humanity International is currently using prefabrication in a much larger project to respond to a much larger need. On August 29, 2005, while I was trying to complete the vinyl siding on the Baker Family's house, Hurricane Katrina made landfall along the Gulf Coast of the United States. Considered the "single most catastrophic natural disaster in U.S. History,"<sup>1</sup> it initiated the flooding of over eighty percent of the city of New Orleans<sup>2</sup> and it destroyed tens of thousands of homes in the states of Louisiana, Mississippi, and Alabama.<sup>3</sup> Five days later Habitat for Humanity launched a rebuilding program called **Operation Home Delivery**. As part of this program affiliates throughout North America are assembling house kits and shipping them to affiliates in the affected areas for assembly. These kits consist of open wood framed wall panels, which are prefabricated by the supplying affiliate; windows; interior and exterior doors; door hardware; posts and beams; roof trusses and sheathing; fascia boards; wall sheathing and house wrap; nails; screws; tape; glue; and unless the house is to be built on a slab on grade, floor framing and floor sheathing. The houses are three and four bedroom bungalows of 1092 to 1166 square feet (3.6). In three months almost two-hundred house kits have been shipped.<sup>5</sup> The goal is to build one-thousand houses in eighteen months.<sup>6</sup>

Two years ago I set out to develop a panelized wall system for use by Habitat for Humanity and to test it in the design and construction of just one house. While the house I built is a prototype of an incomplete test, the use of the panelized wall system did prove beneficial to the construction of the house in numerous ways. The panelization succeeded in breaking up the construction of the walls into components that are easy to understand and construct. The diagrams that I developed to facilitate the prefabrication of these

## Operation Home Delivery

From a news release from Habitat for Humanity International, September 3, 2005:

AMERICUS, Ga. (Sept. 3, 2005) – Habitat for Humanity International is launching “Operation Home Delivery,” a three-phase response to help provide assistance and rebuilding opportunities in New Orleans and elsewhere along the Gulf Coast in the aftermath of Hurricane Katrina.

”First responders are providing immediate aid right now, but, soon, efforts will be moving toward helping people rebuild their lives and their homes,” said Jonathan Reckford, Habitat’s chief executive officer. “We are working now to make sure we have just such a plan in place when conditions are at a point that rebuilding can get under way.”

Specifically, the plan focuses, first, on helping Habitat affiliates that were hardest hit by Katrina restore some level of service. Then Habitat will seek to serve as a catalyst with other organizations, governments, corporations, foundations, etc., to bring people together to talk about low-income housing and recovery on a scale that Habitat alone would be unable to do, and third, to establish and implement a “home in a box project.”

Habitat’s plan is to assemble the materials needed to build a house – either purchased or donated – and then, working with affiliates, churches, corporations and others in communities all over the country, volunteers, working with building specialists, will “pre-build” the frame of a home over a few days. The house will be tacked together to ensure a rock-solid fit, then the frame will be taken apart and the components placed, along with other necessary construction materials, in a container and shipped to an area along the Gulf Coast or New Orleans where families, volunteers and builders will rebuild the home.<sup>4</sup>

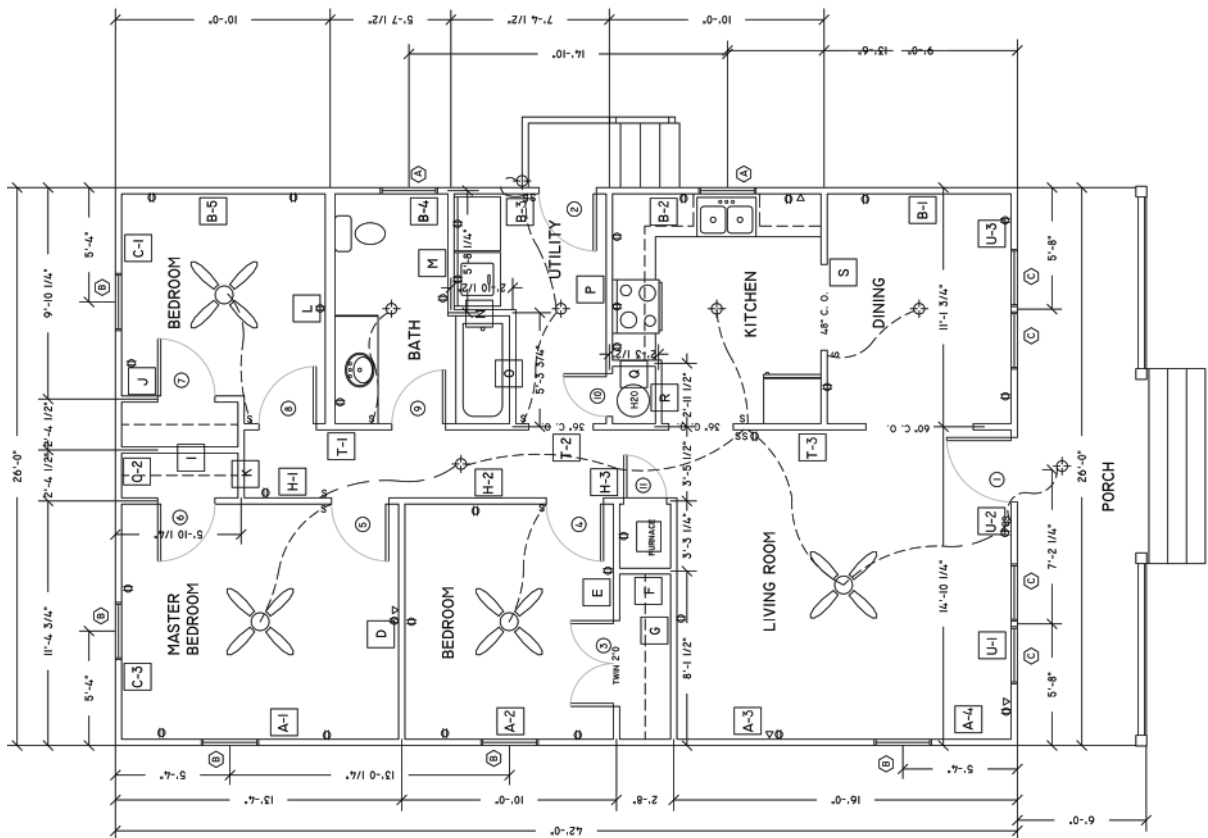

3.6 Plan of a three bedroom house used in Operation Home Delivery.

wall panels provided a more detailed and comprehensive package of drawings for the house than a standard set of drawings. The increased detail and clear standards of these diagrams minimized errors due to the misinterpretation of the standard drawings and inconsistencies between wall panels.

The panelization also succeeded in decreasing the time required on-site to complete the framing of the walls, while facilitating the organization of this work. The integration of the panelization into the otherwise conventionally constructed house was eased by founding the design of the wall panels in conventional construction methods, incorporating the panelization into the design of the house, and incorporating tolerances into the construction of the wall panels. Organizational difficulties were minimized by decreasing the quantity of decisions that needed to be made on-site.

Of additional benefit to the construction of the house — although not integral to the panelized wall system — was the hierarchical organization of the student workers and the feedback acquired from these students through their task sheets. The organization of the graduate and undergraduate students into a hierarchy facilitated their management and instruction. The comments provided by the students through their task sheets gave daily feedback on the successes and difficulties that they were experiencing, while concurrently exposing the progress and type of understanding that they were gaining. With a more diverse group of workers this feedback would be even more useful.

Just as the use of the panelized wall system and the processes used to implement it were beneficial to the construction of the house, the construction of the house proved beneficial to the panelized wall system by both furthering its development and exposing what additional development it requires.

The panelized wall system needs to be pushed beyond its largely unscientific creation. Does it cost more or less money than conventional construction? Does it take more or less man hours to build? Does every interior wall panel need a cross brace? Should the last exterior wall panel in a wall be cut short by half an inch, one inch, or nothing?

The panelized wall system needs to be fully and further tested. Are the exterior wall panels too heavy once the windows are installed? How would the outcome differ with different people in different circumstances? Are the diagrams easily understandable by volunteers who do not have an architectural education?

The panelized wall system needs to be expanded to accommodate the differing abilities and needs of affiliates. The construction practices and preferences of affiliates need to be surveyed and the results incorporated. A variety of cladding options need to be developed. The process of precladding the wall panels with vinyl siding needs to be simplified through the use of readily available materials and the elimination of calculations.



Lastly, the panelized wall system needs to be clearly and completely documented. The changes required to the conventional construction process need to be explained in detail. Any choices need to be easy for affiliates to make and should be limited to a well defined set of options. Plans, diagrams, and instructions need to be complete and free of errors. Ultimately, to be a system that affiliates could and would choose to use, it needs to stand on its own, independent of verbal instruction. The panelized wall system needs to become a package which is easy to pick up, understand, and use.

## Conclusion

My initial on-site construction experience with Habitat for Humanity left me with more questions than answers. Through building a house I sought to correct the disparity between my knowledge of construction practices and reality, and I sought to prove the validity of my theories and designs. The experience did give me a greater understanding of construction practices. I learned how to build a house by doing so. However, the test of the panelized wall system was incomplete. The validity of the system, along with its theories and designs, remains unproven.

What the attempt did prove is that the construction of one house, with one group of people, is insufficient to fully develop and test the design and the documentation of a system of prefabrication. While the development of the panelized wall system was furthered by the construction of the house, for it to become an autonomous system that affiliates can easily access, understand, and implement, further development and repeated testing is required. There are too many variables that can influence the outcome of a project for one test to be enough.

Through building a house I sought answers, but I discovered more questions. The biggest of which is: is it worth it? Is prefabrication worth the extra effort required?

For Habitat for Humanity the answer to this question needs to be sought by each affiliate. An affiliate must decide if prefabrication matches their goals and resources. It will not be appropriate for every affiliate or for every project by an affiliate. This thesis shows that prefabrication does have benefits when using unskilled labour. It also shows that prefabrication can cause significant complications. While prefabrication does have the potential to increase the efficiency of on-site construction, its usage carries the risk of being less efficient than conventional construction practices. No matter how well developed a system of prefabrication is, and how easy it is to implement, there will always be advantages, disadvantages and risks to using prefabrication that an affiliate must evaluate against each other and with an understanding of their goals and resources. The more information that an affiliate can acquire on its own experiences with prefabrication and the experiences of other affiliates, the better informed this evaluation will be.

This thesis, through its chronicle of my experiences, details the development of the panelized wall system, exposes the multitude of factors that influenced the outcome of the project, and imparts the understanding that I gained. It provides for this project the information that I found missing from documentation on other projects that utilize prefabrication — information that is essential to learning from these projects and applying the knowledge that is acquired to future projects. Whether the next project involves the further development of this panelized wall system, the creation of

another system of prefabrication, or an evaluation of the value or appropriate use of prefabrication, the thorough documentation of this project enables it to contribute to that venture. This thesis is ultimately as much a resource for future projects as it is a record of this project.

## Notes

### Ideas

- 1 Habitat for Humanity Canada, “Frequently Asked Questions”
- 2 Insulating Concrete Form Association, “Types of Insulating Concrete Forms.”
- 3 Friedman, *Comprehensive Analysis of Self-Build Housing Experiences*, 2.
- 4 “McLevin Woods Habitat Project,” Arsenault, A-2.
- 5 “Habitat for Humanity,” Nicholls, A3.
- 6 “‘B’ Unit,” Devos, A-6.
- 7 Stevenson, *Houses by Mail*, 19.
- 8 Herbert, *The Dream of the Factory-Made House*, 292.
- 9 *Ibid.*, 302.
- 10 *Ibid.*, 307.
- 11 Partnership for Advanced Technology in Housing, “PATH Technology Inventory;” Kieran, “Refabricating Architecture;” Ross, *Beyond Metabolism*; Arieff, *Prefab*; Herbers, *Prefab Modern*; Mathieu, “The prefabricated housing industries in the United States, Sweden and Japan;” Brock, “The Prefabricated House in the Twenty-First Century;” Friedman, “Prefabricated Wall Systems and the North American Home Building Industry;” Decker, *Quonset Hut*.
- 12 Novabrik, “General Info.”
- 13 National Research Council Canada, “An Introduction to CCMC.”
- 14 Ministry of Municipal Affairs and Housing, “BMEC.”

### Reality

- 1 Ministry of Municipal Affairs and Housing, “Exams: Samples, Schedule and Policies.”
- 2 Ministry of Municipal Affairs and Housing, “Designer Qualification and Registration.”
- 3 Canada Mortgage and Housing Corporation, “Better Buildings Case Study Number 46: Advanced Framing,” 1.
- 4 *Ibid.*, 2.
- 5 *Ibid.*, 4.
- 6 Canadian Wood Council, “Plywood Grades.”
- 7 Ontario Federation for Cerebral Palsy, “What Is Cerebral Palsy?”
- 8 Autism Society Canada, “What is Autism Spectrum Disorder?” 1.
- 9 Autism Society Canada, “General Characteristics of Autism.”

- 10 Spina Bifida and Hydrocephalus Association of Canada, "Hydrocephalus: The Facts."
- 11 A.D.A.M. Inc., "Osgood-Schlatter disease."
- 12 DuPont, "Tyvek StuccoWrap Installation Guidelines," 1.
- 13 Royal Group Technologies Limited, "About Us."
- 14 Royal Building Products, "Board & Batten Pamphlet," 2.
- 15 Royal Mouldings Limited, "Trimplank Trim Boards."
- 16 Canada Mortgage and Housing Corporation, "Better Buildings Case Study Number 46: Advanced Framing," 2.
- 17 DuPont, "DuPont™ FlexWrap™."
- 18 Ministry of Municipal Affairs and Housing, Ontario Building Code 1997, "9.10.14.1. Maximum Percentage Area of Unprotected Openings," 9-45.

### **Reflections**

- 1 Federal Emergency Management Agency, "By the Number - One Year Later: FEMA Recovery Update for Hurricane Katrina."
- 2 Department of Homeland Security, "Hurricane Katrina: What Government Is Doing."
- 3 Federal Emergency Management Agency, "By the Number - One Year Later: FEMA Recovery Update for Hurricane Katrina."
- 4 Habitat for Humanity International, "Habitat for Humanity plans 'Operation Home Delivery' for hurricane victims."
- 5 Habitat for Humanity, "We are rebuilding. You can help," 2.
- 6 Habitat for Humanity International, "Habitat for Humanity Hurricane Recovery: January 2006 Update," 14.

## Illustration Credits

### Ideas

- 1.36 Habitat for Humanity Edmonton Prefabrication Shop. Drawing by Ralph Totman.
- 1.37 A Novabrik. Novabrik International Inc, <http://www.novabrik.com>.
- 1.38 House Under Construction 2004. Photo courtesy of York Communications.

### Reality

- 2.1 Region of Waterloo News Release. The Region of Waterloo, <http://www.region.waterloo.on.ca/web/region.nsf/0/D92F548C2E4A6E2F85256F6900584A93?OpenDocument>.
- 2.2 Preliminary 2005 Build Schedule. Table by Habitat for Humanity Waterloo Region, adapted by author.
- 2.7 Preliminary Elevation. Drawing by Orchard Design.
- 2.8 Preliminary Plan. Drawing by Orchard Design.
- 2.9 Barrier Free Preliminary Plan. Drawing by Orchard Design.
- 2.10 Plan of Survey. Provided by Orchard Design.
- 2.18 Plywood Clad House in Elora. Dave Fair.
- 2.26 Main Floor Plan. Drawing by Orchard Design.
- 2.27 Front Elevation. Drawing by Orchard Design.
- 2.28 Right Side Elevation. Drawing by Orchard Design.
- 2.29 Upper Floor Plan. Provided by Habitat for Humanity London.
- 2.31 Floor Plan Sketch. Drawing by Laurie and Sean Baker.
- 2.32 Board & Batten. Royal Building Products, <http://www.royalbuildingproducts.com/products/siding/boardbatten/index.html>.
- 2.33 Trimplank. Royal Mouldings Limited, <http://www.royalmouldings.com/NewPages/SecondLevelPages/TrimPlank.htm>.
- 2.38 Topographic Survey. Drawing by Meritech Engineering.
- 2.43 Assembling Interior Wall Panels. Mike Garforth.
- 2.47 Measuring For Square. Still from video by Mike Garforth.
- 2.49 Installing Cross Brace. Mike Garforth.
- 2.51 Marking its Unique Code. Mike Garforth.
- 2.57 Exterior Wall Panel Jig. Still from video by Mike Garforth.
- 2.68 Completed Interior Wall Panels. Mike Garforth.
- 2.69 Pushing and Pulling. Still from video by Mike Garforth.

- 2.70 Small Interior Wall Panel. Still from video by Mike Garforth.
- 2.71 Very Small Interior Wall Panel. Mike Garforth.
- 2.72 Rendering of the House. Mark Cichy.
- 2.77 Catching a Wall Plate. Still from video by Olivia Keung.
- 2.78 Assembling the Frame. Still from video by Mike Garforth.
- 2.79 Screwing Together the Framing. Mike Garforth.
- 2.80 Measuring to Ensure Square. Still from video by Mike Garforth.
- 2.81 Installing the Plywood Sheathing 1. Still from video by Olivia Keung.
- 2.82 Installing the Plywood Sheathing 2. Still from video by Mike Garforth.
- 2.84 Installing the Plywood Sheathing 3. Still from video by Mike Garforth.
- 2.86 Stapling the Tyvek. Mike Garforth.
- 2.87 Folding the Tyvek. Mike Garforth.
- 2.88 Finished Corner. Mike Garforth.
- 2.89 Lifting Off of Jig. Still from video by Mike Garforth.
- 2.90 Completing the Stapling. Still from video by Olivia Keung.
- 2.91 Carrying Through the Workshop. Still from video by Mike Garforth.
- 2.92 Carrying Through the Door. Still from video by Olivia Keung.
- 2.93 Carrying Outside the Workshop. Still from video by Mike Garforth.
- 2.104 Using a Hand Plane. Mike Garforth.
- 2.108 Jack Stud to Header Plate. Mike Garforth.
- 2.109 Sill Plate to Jack Stud. Mike Garforth.
- 2.118 Assembling a Built-up Column. Still from video by Mike Garforth.
- 2.119 Completed Wall Panel with Beam Pocket. Still from video by Mike Garforth.
- 2.120 FlexWrap. Drawing by DuPont.
- 2.122 Main Floor Plan. Drawing by Orchard Design.
- 2.123 Grading Plan. Drawing by Meritech Engineering.
- 2.125 Revised Grading Plan. Revised by author from a drawing by Meritech Engineering.
- 2.135 Installing J Trim. Mike Garforth.
- 2.136 J Trim Installed. Mike Garforth.
- 2.137 Talking Through the Calculations. Mike Garforth.
- 2.138 Trimming First Siding Panel. Mike Garforth.

- 2.139 First Siding Panel Trimmed. Mike Garforth.
- 2.140 Installing Siding Panels. Mike Garforth.
- 2.144 Reinstalling Siding Panels. Mike Garforth.
- 2.148 Starting to Unload. Olivia Keung.
- 2.149 Storing Exterior Wall Panels. Olivia Keung.
- 2.152 Clearing an Excavation of Loose Rock. Olivia Keung.
- 2.153 Communicating Siding Changes. Still from video by Olivia Keung.
- 2.154 Preparing to Cut. Still from video by Olivia Keung.
- 2.155 Installing Siding Panels. Still from video by Olivia Keung.
- 2.156 Storing a Sided Wall Panel. Still from video by Olivia Keung.
- 2.157 Stabilizing a Concrete Pier. Sylvia Pawlowski.
- 2.167 Marking Anchor Bolts on Sill Plates. Sylvia Pawlowski.
- 2.168 Drilling Hole in Sill Plate. Still from video by Mike Garforth.
- 2.169 Installing Sill Gasket. Still from video by Mike Garforth.
- 2.170 Installing Tyvek Along Top of Foundation. Still from video by Mike Garforth.
- 2.172 Installing Rim Boards. Mike Garforth.
- 2.173 Installing Two-ply Joists. Mike Garforth.
- 2.174 Installing Joists. Still from video by Carmen Lau.
- 2.175 All Joists Installed. Mike Garforth.
- 2.176 Installed Cross Bridging. Mike Garforth.
- 2.177 Sheathing Rim Boards. Still from video by Mike Garforth.
- 2.180 Completed Floor Deck. Mike Garforth.
- 2.181 Straightening Joists. Mike Garforth.
- 2.182 Folding the Tyvek. Mike Garforth.
- 2.183 Trusses Arrive. Mike Garforth.
- 2.184 Newspaper Article June 29, 2005. The Record newspaper.
- 2.185 Carrying Wall Panel Through Tent. Mike Garforth.
- 2.187 Carrying Wall Panel up onto Floor Deck. Mike Garforth.
- 2.188 Erecting the First Wall Panel. Heather Fitzpatrick.
- 2.190 First Erected Wall Panel. Natalie Soranno.
- 2.191 Erecting the First Wall 1. Heather Fitzpatrick.
- 2.192 Erecting the First Wall 2. Heather Fitzpatrick.
- 2.193 Erecting the First Wall 3. Heather Fitzpatrick.
- 2.194 Carrying and Erecting 1. Natalie Soranno.
- 2.195 Carrying and Erecting 2. Natalie Soranno.
- 2.196 Carrying and Erecting 3. Natalie Soranno.



- 2.197 Carrying and Erecting 4. Natalie Soranno
- 2.201 Driving with a Sledge Hammer. Natalie Soranno.
- 2.202 Exterior View of the Completed Walls. Mike Garforth.
- 2.203 Interior View of the Completed Walls. Mike Garforth.
- 2.204 Erecting Exterior Wall Panels. Natalie Soranno.
- 2.208 Erected Interior Wall Panels 1. Mike Garforth.
- 2.209 Erected Interior Wall Panels 2. Mike Garforth.
- 2.214 Using Clamps. Mike Garforth.
- 2.215 Using Body Weight. Heather Fitzpatrick.
- 2.223 Erected and Capped. Mike Garforth.
- 2.224 House and Neighbouring House. Mike Garforth.

### **Reflections**

- 3.1 The Baker Family. Terri Meyer Boake.
- 3.2 Wooden Ramp to Front Door. Terri Meyer Boake.
- 3.3 Dedication Ceremony Program. Habitat for Humanity  
Waterloo Region.
- 3.6 Operation Home Delivery Plan. Habitat for Humanity  
Metro Jackson.

All other illustrations by author

## Bibliography

### Ideas

- Arieff, Allison. "Prefab, Proven." Dwell. December 2004.
- Arieff, Allison and Bryan Burkhart. *Prefab*. Salt Lake City: Gibbs Smith, Publisher, 2002.
- "McLevin Woods Habitat Project." Arsenault Architect Inc, April 6, 2004. Architectural Drawings.
- Brock, Linda and James Brown. "The Prefabricated House in the Twenty-First Century: What Can We Learn From Japan? A Case Study of the KST-Hokkaido House." Paper prepared for the World Conference on Timber Engineering, Whistler Resort, British Columbia, Canada, July 31 – August 3, 2000. <http://ce.wsu.edu/Resources/papers/4-2-3.pdf>.
- Brown, Azby and Joseph Cali. *The Japanese Dream House: How Technology and Tradition and Shaping New Home Design*. New York: Kodansha International, 2001.
- Decker, Julie and Chris Chiei, eds. *Quonset Hut: Metal Living For a Modern Age*. New York: Princeton Architectural Press, 2005.
- "B' Unit: The Amsterdam." Devos Design & Drafting, July 5, 2002. Architectural Drawings.
- Friedman, Avi, Steve Pomeroy, David Krawitz, and Alexander Smith. *Comprehensive Analysis of Self-Build Housing Experiences*. Ottawa: Canada Mortgage and Housing Corporation, 1999.
- Friedman, Avi and Vince Cammalleri. "Prefabricated Wall Systems and the North American Home Building Industry." *Building Research and Information*, Vol. 21, No. 4, 1993. Pages 209-215.
- Habitat for Humanity Canada. "Frequently Asked Questions." <http://habitat.ca/faqp1.php>.
- Herbert, Gilbert. *The Dream of the Factory-Made House: Walter Gropius and Konrad Wachsmann*. Cambridge, Massachusetts: The MIT Press, 1984.
- Insulating Concrete Form Association. "Types of Insulating Concrete Forms." <http://www.forms.org/index.php?act=typesoficf>.
- Herbers, Jill. *Prefab Modern*. New York: Harper Design International, 2004.
- Kieran, Stephen and James Timberlake. *Refabricating Architecture: How Manufacturing Methodologies Are Poised to Transform Building Construction*. New York: McGraw-Hill, 2004.
- Koch, Carl and Andy Lewis. *At Home With Tomorrow*. Toronto: Rinehart & Company Inc, 1958.
- Mathieu, Renee. "The prefabricated housing industries in the United States, Sweden and Japan." *Construction Review*. July-

August 1987.

- McCoy, Esther. *Case Study Houses, 1945-1962*. Los Angeles: Hennessey & Ingalls, Inc., 1977. (Second Edition, First ed. Published in 1962 under title: Modern California houses).
- Ministry of Municipal Affairs and Housing. "BMEC." 2002. [http://www.obc.mah.gov.on.ca/userfiles/HTML/nts\\_4\\_8751\\_1.html](http://www.obc.mah.gov.on.ca/userfiles/HTML/nts_4_8751_1.html).
- National Research Council Canada. "An Introduction to CCMC." 2002. [http://irc.nrc-cnrc.gc.ca/ccmc/introCCMC\\_e.shtml](http://irc.nrc-cnrc.gc.ca/ccmc/introCCMC_e.shtml).
- "Habitat for Humanity, Harlbut Road, Warkworth, Campbellford/Seymour." Jeremy Nicholls B.Arch, June 2004. Architectural Drawings.
- Novabrik International Inc. "General Info: Product Info." [http://www.novabrik.com/html/en/general\\_info/products.php3](http://www.novabrik.com/html/en/general_info/products.php3).
- Partnership for Advanced Technology in Housing. "PATH Technology Inventory." NAHB Research Center, 2005. <http://www.toolbase.org/techinv/index.aspx>.
- Ross, Michael Franklin. *Beyond Metabolism: The New Japanese Architecture*. Toronto: Architectural Record Books, McGraw-Hill Book Company, 1978.
- Stevenson, Katherine Cole and H. Ward Jandl. *Houses By Mail: A Guide to Houses from Sears, Roebuck and Company*. Washington, D.C: The Preservation Press, 1986.

## Reality

- A.D.A.M. Inc. "Osgood-Schlatter disease." 2004. <http://www.nlm.nih.gov/medlineplus/ency/article/001258.htm>.
- Autism Society Canada. "General Characteristics of Autism." 2005. [http://www.autismsocietycanada.ca/understanding\\_autism/characteristics\\_of\\_asc/index\\_e.html](http://www.autismsocietycanada.ca/understanding_autism/characteristics_of_asc/index_e.html).
- Autism Society Canada. "What is Autism Spectrum Disorder?" 2006. [http://www.autismsocietycanada.ca/pdf\\_word/info\\_AS\\_C%27swhatisautisminfosheet\\_8\\_1\\_06\\_e.pdf](http://www.autismsocietycanada.ca/pdf_word/info_AS_C%27swhatisautisminfosheet_8_1_06_e.pdf).
- Canada Mortgage and Housing Corporation. "Better Buildings Case Study Number 46: Advanced Framing." 2004. <http://www.cmhc-schl.gc.ca/en/inpr/bude/himu/bebu/loader.cfm?url=/commonspot/security/getfile.cfm&PageID=57498>.
- Canadian Wood Council. "Plywood Grades." 2005. <http://www.cwc.ca/products/plywood/grades.php>.
- DuPont. "DuPont™ FlexWrap™." 2006. [http://www2.dupont.com/Tyvek\\_Construction/en\\_US/products/commercial/products/flexwrap.html](http://www2.dupont.com/Tyvek_Construction/en_US/products/commercial/products/flexwrap.html).
- DuPont. "Tyvek FlexWrap Installation Guidelines." 2001.
- DuPont. "Tyvek StuccoWrap Installation Guidelines." 2004.
- Ministry of Municipal Affairs and Housing. "Designer

Qualification and Registration.” 2002. [http://www.obc.mah.gov.on.ca/userfiles/HTML/nts\\_4\\_24355\\_1.html](http://www.obc.mah.gov.on.ca/userfiles/HTML/nts_4_24355_1.html).

Ministry of Municipal Affairs and Housing. “Exams: Samples, Schedule and Policies.” 2002. [http://www.obc.mah.gov.on.ca/userfiles/HTML/nts\\_4\\_16219\\_1.html](http://www.obc.mah.gov.on.ca/userfiles/HTML/nts_4_16219_1.html).

Ministry of Municipal Affairs and Housing. *Ontario Building Code 1997*. Ontario: Publications Ontario, 1997.

Ontario Federation for Cerebral Palsy. “What Is Cerebral Palsy?” <http://www.ofcp.on.ca/aboutcp.html>.

Royal Building Products. “Board & Batten Pamphlet.” 2006. <ftp://69.70.45.30/Royal%20FTP%20Resource/ROYAL%20Resource%20FTP/Board%20&%20Batten/Board&Batten%20LITERATURE/Board&BattenPamphlet.pdf>

Royal Group Technologies Limited. “About Us.” 2006. <http://www.royalgrouptech.com>.

Royal Mouldings Limited. “Trimplank Trim Boards.” 1999. <http://www.royalmouldings.com/NewPages/SecondLevelPages/TrimPlank.htm>.

Spina Bifida and Hydrocephalus Association of Canada. “Hydrocephalus: The Facts.” 2006. <http://www.sbhac.ca/index.php?page=hydra>.

## Reflections

Department of Homeland Security. “Hurricane Katrina: What Government Is Doing” September 24, 2006. [http://www.dhs.gov/xprepresp/programs/gc\\_1157649340100.shtm](http://www.dhs.gov/xprepresp/programs/gc_1157649340100.shtm)

Federal Emergency Management Agency. “By the Number - One Year Later: FEMA Recovery Update for Hurricane Katrina.” August 25, 2006. <http://www.fema.gov/news/newsrelease.fema?id=29109>.

Habitat for Humanity International. “Habitat for Humanity plans ‘Operation Home Delivery’ for hurricane victims.” Date. <http://www.habitat.org/newsroom/2005archive/insitedoc010602.aspx>.

Habitat for Humanity International. “Habitat for Humanity Hurricane Recovery: January 2006 Update.” January 26, 2006.

Habitat for Humanity International. “We are rebuilding. You can help.” November 22, 2005.