

fashioning the distillery district : an architecture of spectacle and performance

by
Kristy Wung

A thesis
presented to the University of Waterloo
in fulfillment of the
thesis requirement for the degree of
Master of Architecture

Waterloo, Ontario, Canada, 2007
© Kristy Wung 2007

author's declaration

I hereby declare that I am the sole author of this thesis.
This is a true copy of the thesis, including any required
final revisions, as accepted by my examiners.

I understand that my thesis may be made electronically
available to the public.

abstract

In the beginning there was cladding, first embraced by humans through the painting and tattooing of skin as a means of displaying one's social position, tribal affiliation, or stage in life. Accompanied by the performance of ritual dances and movement, space was then engaged and the primitive realm of architecture was established. Thus commenced the intimate affair between fashion and architecture, a relationship that most architects have dismissed or even actively purged from their work. This thesis, however, attempts to view the two elements of architecture and fashion in a positive light, as cooperative facilitators of spectacle and event. Indeed, it is the themes of architecture, performance, and decoration that have fueled the design of a fashion school within the Distillery District.

Riding the wave of what has been dubbed Toronto's "architectural renaissance," the proposed insertion of a fashion school in this distinct historical precinct further cultivates the district's mission of revitalization. The design fosters a vital cultural and heritage destination while simultaneously creating a communal gathering place that gains meaning from human interaction. That is, the establishment of a cultural institution will further define the area as a forum of creativity and social engagement, stimulating both the immediate surroundings as well as the rest of the city.

acknowledgements

I would like to express my heart felt gratitude to the following advisors for their dedication, encouragement, and guidance throughout this journey:

Thesis Supervisor:
Ryszard Sliwka
Associate Professor, University of Waterloo

Committee:
Philip Beesley
Associate Professor, University of Waterloo

Lloyd Hunt
Adjunct Associate Professor, University of Waterloo

External Reader:
Kathryn Saunders
Kathryn Saunders Design Inc., Toronto, Ontario

As well, I am sincerely grateful to all those who have offered me their time and insightful conversations bringing this body of work to fruition.

Thank you especially to three wonderful ladies that have embarked on this journey with me from beginning to end. Without your constant support, encouragement and perceptive advice, I would never have found the light at the end of this dark tunnel to persevere.

to my parents

table of contents

	<i>author's declaration</i>	iii
	<i>abstract</i>	v
	<i>acknowledgements</i>	vii
	<i>table of contents</i>	x
	<i>list of illustrations</i>	xii
chapter 00	<i>introduction</i>	02
chapter 01	<i>on place</i>	
1.1	the notion of place.....	08
chapter 02	<i>on performance</i>	
2.1	performance spaces.....	14
2.2	the spectacle of fashion.....	18
chapter 03	<i>on fashion</i>	
3.1	fashion's social role.....	24
3.2	the relationship between fashion and architecture.....	28
chapter 04	<i>on decoration</i>	
4.1	the influence of ornamentation in design.....	34

chapter 05	<i>the site</i>	
5.1	site and situation	44
5.2	revisiting the past	48
5.3	the revitalization and the present	50
5.4	the future	54
5.5	site analysis	58
chapter 06	<i>the design</i>	
6.1	design brief	62
6.2	drawings	72
6.3	renderings	86
chapter 07	<i>conclusion</i>	100
	bibliography	103
	appendix A	107

list of illustrations

Fig.	Description / Source	Page
01	Performance Space Typologies composed by author, illustrations by Ming Cho Lee, <i>Theatrical Space: A Guide for Directors and Designers</i> . Lanham: Scarecrow Press, 1995, p.viii	17
02	Alexander McQueen, Ready-to-Wear, 2006 A/W The Online Home of Vogue & W <www.style.com>	19
03	Viktor and Rolf, Ready-to-Wear, 2001 S/S Caroline Evans. <i>Fashion at the Edge</i> . New Haven: Yale University Press, 2003.	20
04	Viktor and Rolf, Ready-to-Wear, 2007 A/W The Online Home of Vogue & W <www.style.com>	21
05	Viktor and Rolf, Ready-to-Wear, 2007 A/W The Online Home of Vogue & W <www.style.com>	21
06	John Galliano for Christian Dior, Ready-to-Wear, 2006 A/W The Online Home of Vogue & W <www.style.com>	25
07	John Galliano for Christian Dior, Haute Couture, 2007 S/S The Online Home of Vogue & W <www.style.com>	25
08	1950's Teddy boy's look, Costume National, Mens 2006 S/S The Online Home of Vogue & W <www.style.com>	27
09	1960's rockers' look, Costume National, Mens 2006 S/S The Online Home of Vogue & W <www.style.com>	27
10	1960's -70's mod look, Marc Jacobs, Ready-to-Wear, 2003 A/W The Online Home of Vogue & W <www.style.com>	27
11	1980's rap culture look, Enyce, Ready-to-Wear, 2005 S/S The Online Home of Vogue & W <www.style.com>	27
12	Viktor and Rolf, Haute Couture, 1999 A/W Brooke Hodge, <i>Skin + Bones: Parallel Practices in Fashion and Architecture</i> . New York City: Thames & Hudson, 2006, p.223	28
13	Viktor and Rolf, Haute Couture, 1999 A/W Brooke Hodge, <i>Skin + Bones: Parallel Practices in Fashion and Architecture</i> . New York City: Thames & Hudson, 2006, p.223	28
14	Viktor and Rolf, Haute Couture, 1999 A/W Brooke Hodge, <i>Skin + Bones: Parallel Practices in Fashion and Architecture</i> . New York City: Thames & Hudson, 2006, p.227	28

15	Viktor and Rolf, Haute Couture, 1999 A/W..... 28 Brooke Hodge, Skin + Bones: Parallel Practices in Fashion and Architecture. New York City: Thames & Hudson, 2006, p.237	31	Map of Greater Toronto Area 42 drawn by author, base map source: City of Toronto Data [computer file]. Toronto, Ontario: Department of Works and Emergency Services, 2003.
16	Viktor and Rolf, Haute Couture, 1999 A/W..... 29 Brooke Hodge, Skin + Bones: Parallel Practices in Fashion and Architecture. New York City: Thames & Hudson, 2006, p.238	32	Aerial Photo of Greater Toronto Area 43 Google Earth
17	Viktor and Rolf, Haute Couture, 1999 A/W..... 29 Brooke Hodge, Skin + Bones: Parallel Practices in Fashion and Architecture. New York City: Thames & Hudson, 2006, p.238	33	Surrounding Neighbourhoods 44 drawn by author, base map source: City of Toronto Data [computer file]. Toronto, Ontario: Department of Works and Emergency Services, 2003
18	Viktor and Rolf, Haute Couture, 1999 A/W 29 Brooke Hodge, Skin + Bones: Parallel Practices in Fashion and Architecture. New York City: Thames & Hudson, 2006, p.239	34	Major Arterials 44 drawn by author, base map source: City of Toronto Data [computer file]. Toronto, Ontario: Department of Works and Emergency Services, 2003.
19	Sydney Opera House, Jorn Utzon 30 photo by Tom Fletcher <www.sydneyarchitecture.com>	35-41	Historical Maps of Gooderham and Worts Distillery 45-47 redrawn by author, base map source: Diamond + Schmitt Architects Inc. Gooderham and Worts / Triangle Lands Heritage Assessment. Toronto: City of Toronto Planning and Development Department and Toronto Historical Board, 1990
20	Viktor and Rolf, Ready-to-Wear, 2003 A/W 30 Brooke Hodge, Skin + Bones: Parallel Practices in Fashion and Architecture. New York City: Thames & Hudson, 2006, p.232	42	Gooderham and Worts Distillery, 2007..... 47 drawn by author, base map source: City of Toronto Data [computer file]. Toronto, Ontario: Department of Works and Emergency Services, 2003
21	Royal Ontario Museum, Daniel Libeskind 31 Spacing Wire <www.spacing.ca>	43	Gooderham and Worts Distillery, 2022 47 drawn by author, base map source: City of Toronto Data [computer file]. Toronto, Ontario: Department of Works and Emergency Services, 2003
22	Gareth Pugh, Ready-to-Wear, 2007 S/S 31 The Online Home of Vogue & W <www.style.com>	44	Historic Painting of Gooderham and Worts Distillery 48 The Distillery <www.thedistillerydistrict.com>
23	Beautification 34 Industrial Design: Ornament & Design 23/06, p.31	45	Gooderham and Worts Distillery Elements and Processes 49 redrawn by author, base map source: Diamond + Schmitt Architects Inc. Gooderham and Worts / Triangle Lands Heritage Assessment. Toronto: City of Toronto Planning and Development Department and Toronto Historical Board, 1990
24	Beautification 34 Industrial Design: Ornament & Design 23/06, p.10	46	View of Trinity Street During the Day 52 The Distillery <www.thedistillerydistrict.com>
25	Trademarked Burberry Check 35 Answers.com, Business & Finance <www.answers.com>	47	Programme of Distillery District 53 redrawn by author, source: the Distillery < www.thedistillerydistrict.com >
26	Knotted Chair, Marcel Wanders 35 taken by Murray Moss <http://images.businessweek.com>	48	West Don Lands Precinct Plan 54 Urban Design Associates. West Don Lands Precinct Plans. Toronto: Toronto Waterfront Revitalization Corporation, 2004.
27	US Embassy, Edward Durell Stone 36 Schooley Caldwell Associates <www.sca-ae.com>		
28	Ricola Europe Factory, Herzog de Meuron 37 Brooke Hodge, Skin + Bones: Parallel Practices in Fashion and Architecture. New York City: Thames & Hudson, 2006, p.20		
29	Ricola Europe Factory, Herzog de Meuron 38 Brooke Hodge, Skin + Bones: Parallel Practices in Fashion and Architecture. New York City: Thames & Hudson, 2006, p.122		
30	Prada Aoyama, Herzog de Meuron 39 Brooke Hodge, Skin + Bones: Parallel Practices in Fashion and Architecture. New York City: Thames & Hudson, 2006, p.125		

49	Front Street Neighbourhood, West Don Lands55 Urban Design Associates. West Don Lands Precinct Plans. Toronto: Toronto Waterfront Revitalization Corporation, 2004.	66	Design Processes of Fashion71 drawn by author
50	Don River Park Neighbourhood, West Don Lands55 Urban Design Associates. West Don Lands Precinct Plans. Toronto: Toronto Waterfront Revitalization Corporation, 2004.	67	View of Existing Building From Tank House Lane86 photo by author
51	River Square Neighbourhood, West Don Lands55 Urban Design Associates. West Don Lands Precinct Plans. Toronto: Toronto Waterfront Revitalization Corporation, 2004.	68	View of Proposed Insertion From Tank House Lane87 digital image by author
52	Aerial Perspective of West Don Lands55 Urban Design Associates. West Don Lands Precinct Plans. Toronto: Toronto Waterfront Revitalization Corporation, 2004.	69	View of Existing Building Exiting City Via Cherry Street88 photo by author
53	View of Trinity Street at Night57 The Distillery < www.thedistillerydistrict.com >	70	View of Proposed Insertion Exiting City Via Cherry Street89 digital image by author
54	Site Analysis Plan58-59 drawn by author	71	View of Existing Building Entering City Via Cherry Street90 photo by author
55	Calvin Klein, 2008 Resort62 The Online Home of Vogue & W < www.style.com >	72	View of Proposed Insertion Entering City Via Cherry Street91 digital image by author
56	Calvin Klein, 2008 Resort62 The Online Home of Vogue & W < www.style.com >	73	View of Existing Building From Gardiner Expressway at Night92 digital image by author
57	Helmut Lang, 2008 Resort63 The Online Home of Vogue & W < www.style.com >	74	View of Proposed Insertion From Gardiner Expressway at Night92 digital image by author
58	Helmut Lang, 2008 Resort63 The Online Home of Vogue & W < www.style.com >	75	View of Main Lobby.....94 digital image by author
59	Programme and Symbiosis64 drawn by author	76	View of Main Lobby Hosting a Fashion Show94 digital image by author
60	The Folds65 drawn by author	77	View of Multi-Purpose Space95 digital image by author
61	Detail of Roof66 drawn by author	78	View of Ramps in Main Lobby Space96 digital image by author
62	Social Encounters67 drawn by author	79	View of Gallery Space97 digital image by author
63	Vertical Layering of Programme68 drawn by author	80	“The Devil Wears Prada” movie102 < www.imbd.com >
64	Multi-Purpose Use69 drawn by author	81	m1 work108 photo by Somya Singh and author
65	Spectacle and Spectator70 drawn by author	82	m1 work109 photo by Somya Singh and author
		83	m1 work109 photo by Somya Singh and author



chapter
introduction 00

In an age of heightened self-consciousness, fashion — a cultural phenomenon that some ridicule as frivolous and superficial — plays a significant role in constructing different meanings, pleasures, and identities in our everyday lives. An ongoing debate exists between the “fashion conscious,” who are often dismissed as shallow and capricious, and those who consider fashion to be a tragic fad culture that thrives on people’s insecurities. Regardless of this seeming irreconcilability, fashion remains a fundamental component of cultural expression that is exhibited to all; whether the brand of jeans we select is a conscious choice or not, we are deeply submerged in the culture of fashion. It is this tension, generated from divergent responses to fashion, that encourages discussion and interaction. Indeed, it is this tension that has propelled this thesis to present fashion and its association with architecture as a mutually beneficial relationship.

We live in a society where technological advances are responsible for an ever-increasing rapidity in transport and in the transfer of digital information. This accelerated telecommunication and mobility has unnaturally transformed the construction of our physical surroundings, ultimately influencing our thinking and how we experience time and space. As David Harvey suggests, the time taken to traverse vast spatial barriers can be measured in seconds, owing to the sophistication of technology “compressing our temporal and spatial worlds,”¹ while simultaneously increasing the size of our world in terms of the vastness of information available. Termed the “paradox of the expanding world” by Hans Ibelings, the area considered an individual’s “familiar territory” is larger than ever but, ironically, people find the world less and less meaningful precisely because the majority of the world is familiar to them only from a fleeting visit, and not as a place where they feel some affinity, where they feel at home, where they actually

meet other people rather than simply being thrown together by chance.² Using the intersecting concepts of fashion and event as socially unifying cultural phenomena with which people can identify, this thesis aims to establish a direct contrast to the “non-places” that are typical expressions of the age of globalization. The project intends to foster a “place” that will acquire meaning through human attachments and activities, using spaces of performance and fashion to drive and sustain social fluidity and exchange. It acknowledges that architecture is the generator of a social place as Bill Hillier and Julienne Hanson clearly asserts,

[By] giving shape and form to our material world, architecture structures the system of space in which we live and move. In that it does so, it has a direct relation – rather than a merely symbolic one – to social life, since it provides the material preconditions

for the patterns of movement, encounter and avoidance which are the material realization – as well as sometimes the generator – of social relations. In this sense, architecture pervades our everyday experience far more than a preoccupation with its visual properties would suggest.³

This thesis is driven by the concepts of fashion and its inherent elements of spectacle, events, and decoration to create an architectural design that is an instance of fashion. From primal customs of inscribing skin to historical costumes ornamented and fabricated with architectonic references — as seen in the male courtiers who wore hats, capes, and padded court attire with Gothic architecture influences, or women of Henry VIII’s court donning headdresses in the shape of Tudor arches⁴, or the theoretical postulates of Adolf Loos and Gottfried Semper — the common creative impulses

shared between fashion and architecture formed the inspiration for this thesis. The proposal is an example of how architecture and fashion cooperatively construct the framework for developing a meaningful place where public and semi-public space is used as a social platform that cultivates and encourages multiple interactions.

This thesis proposes an intervention within the backdrop of Toronto's Victorian era Gooderham and Worts Distillery, now known as the Distillery District, in an attempt to further the area's historical revitalization, its development of an artistic community, and to encourage the city's cultural revival. Blossoming as a contemporary metropolis since the post-war years, Toronto's distinct identity is gradually maturing along with the development of its cultural diversity and various events such as the annual "Doors Open" architectural tour and the world-renowned Toronto International Film Festival. In addition, a building boom is sweeping across Toronto

as the revitalization of over a dozen significant cultural institutions is in progress. Buildings such as Diamond + Schmitt Architects Inc.'s Opera House and Kuwabara Payne McKenna Blumberg Architects' National Ballet School contribute to what has been dubbed Toronto's "architectural renaissance." Culture is at the heart of Toronto's building initiative as "the city's creative machinery generates over \$8 billion in revenue annually and accounts for over half of the province's cultural revenues.⁵ According to one popular website, Toronto is the most visited tourist destination in Canada and visiting its cultural attractions is the second most popular tourist activity, next to shopping. Thus, the cultural injection of a fashion school, as proposed by this thesis, aims to further cement the Distillery District as an artistic and cultural destination, connecting downtown Toronto to the new West Don Lands development, while cultivating a distinct identity as a social hub of the city. The following is an investigation of the concepts of fashion and its

interrelated ideas that drive the culmination of this thesis, the design, which is a symbiosis of architecture and fashion's inherent elements.

¹ Harvey, David, *The Condition of Post-Modernity*, Blackwell Publishers, Massachusetts, 1990, 240.

² Ibelings, Hans, *Supermodernism: Architecture in the Age of Globalization*, NAI Publishers, Rotterdam, 2002, 65.

³ Hillier, Bill and Julienne Hanson, *The Social Logic of Space*, Cambridge University Press, Cambridge, 1988, ix.

⁴ Quinn, Bradley, *The Fashion of Architecture*, Berg, Oxford, 2003, 2.

⁵ <http://readingt.readingcities.com/index.php/toronto/search/eight_projects_reshaping_toronto/> accessed on 01 March, 2007.

GOODERHAM & WORTS LIME

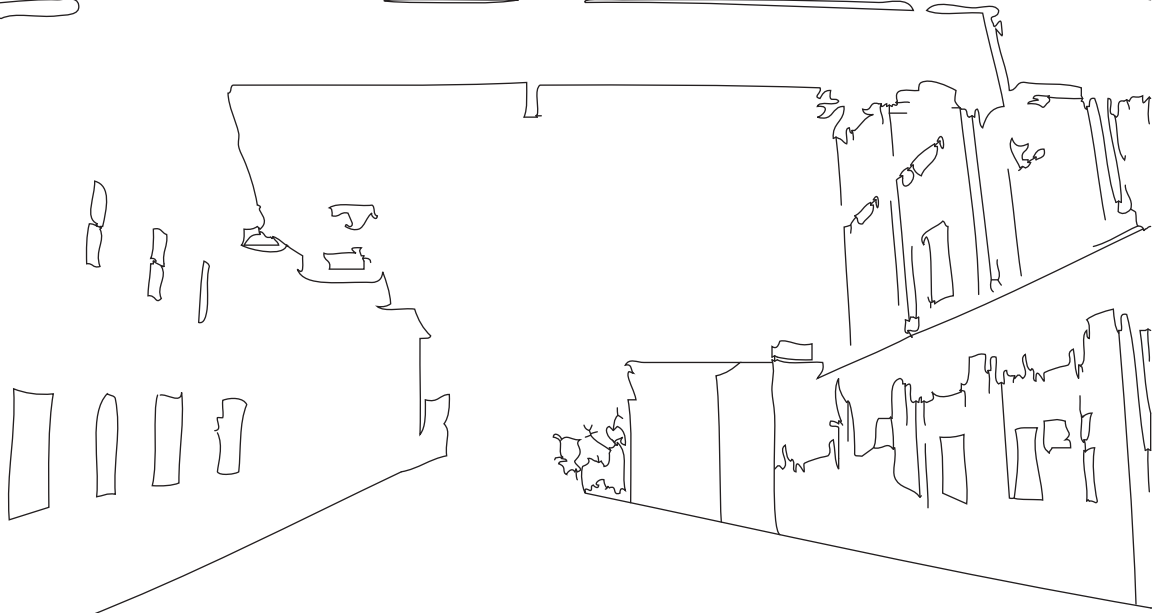

chapter
on place 01

1.1 the notion of place

Today, the effects of technological progress and globalization have produced a consistent stream of “non-places,” a term used by Marc Auge to describe places that are there only to be passed through, places for which nobody feels any special attachment. Non-spaces are not relational; they have neither identity, nor historical context. Common in the spheres of mobility and consumption, they are easily discernable through their characteristics of homogeneous form and recognizable standardization, being transient spaces for traffic, communication, and consumption. Typical expressions include subways, airports, hotels, and department stores, where individuals fail to experience the socially organic environment. According to Auge, non-places create “solitary contractuality” where the relationships between people and their surroundings are established through the negotiation of words and texts “offering us instructions including the prescriptive (“Take right-hand lane”), prohibitive (“No smoking”),

or informative (“You are now entering the Beaujolais region”).”¹ Non-places create fleeting and ephemeral spaces, furnishing solitary individuality where one is confined to — and left to interpret the information from — one’s own isolated world.

Conversely, “place” represents an area that has acquired meaning because of shared human activities and processes. Place is a significant element that is central to human life, affecting the way that people experience the world and forming the basis for social interaction. Place must have a direct relationship with humans and the human capacity to both produce and consume meaning.² Seemingly common and straightforward, the notion of place is, in fact, a complex idea with several schools of thought attempting to define the concept. These scholars range from regional geographers who produce research about places as distinct parcels of land with their own ways of life, to radical geographers

who study the way places are expressions of power. For this thesis, a more humanist approach to the concept of place is sought, acknowledging it as an essential way of being in the world. As Malpas suggests,

The idea of place encompasses both the idea of the social activities and institutions that are expressed in and through the structure of a particular place (and which can be seen as partially determinative of that place). . . . Indeed the social does not exist prior to place nor is it given expression except in and through place – and through spatialised, temporalised ordering. . . . It is within the structure of place that the very possibility of social arises.³

Advocating this notion of place as an embodied relationship with the world, the work of Nigel Thrift, and his contemporaries Allan Pred and David Seamon, seeks

to represent place as a space constructed and experienced by people doing things. Thus, place is a series of practices that can never be finished, as it is constituted through the perpetual cycle of social practice, constantly being performed, made, and remade on a daily basis. As Tim Cresswell summarizes, “[p]lace . . . becomes an event rather than a secure ontological thing rooted in notions of the authentic. Place as an event is marked by openness and change rather than boundedness and permanence.”⁴ It is a place that furnishes the setting in which the events are acted out; it becomes the stage for performance sustained by human interaction.

At the heart of the artistic, cultural, and entertainment scene in Toronto, the Gooderham and Worts Distillery embodies the essence of “place” as a result of its charming past and its successful revitalization process. The district has experienced a successive transformation — from a once-flourishing distillery empire, to a derelict

industrial property, to its celebrated rebirth as a hub of social culture. The cobblestone roads and Victorian brick buildings of Gooderham and Worts Distillery have acquired a defining spirit and meaning through its very permanence and through a perpetual relationship with its occupants. Encompassing a unique and vibrant historical character, the scenic pedestrian-only village serves as the stage – both metaphorically, as a place for social interaction and literally, as the physical backdrop for more than 800 movies in the last decade. As one of the few remaining authentic historical districts, Gooderham and Worts Distillery has embraced various independently-owned retailers, remarkable eateries, prominent artist studios, and galleries. Together, these occupants have propelled the district into an engaging public space of activity and social gathering. Whether guests admire the remnants of the nineteenth-century Dickensian antique steel hoppers, wooden-wheeled factory carts, and pulleys that speckle the site, or they

enjoy a cup of Mayan hot chocolate from the celebrated Soma chocolatemaker, the success of Gooderham and Worts Distillery is clear. By attracting visitors from both neighbouring and global communities alike, it is generating a recognition that plants the seeds for further expansion. Because of its thriving realization as a distinct neighbourhood, its effects have promulgated beyond the confines of its district by accelerating the growth and revitalization of its bordering areas, as the development of the West Don Lands proves. Thus, Gooderham and Worts Distillery has not only established itself as a vital place in Toronto's social scene through its past and present human interactions and activities, but it has also furnished a stage for future events, and incorporated adjacent communities into the act.

¹ Auge, Marc, *Non-Places: Introduction to an Anthropology of Supermodernity*, Verso, London, 1995, 94-96.

² Cresswell, Tim, *Place: A Short Introduction*, Blackwell Publishing, Oxford, 2004, 7.

³ Malpas, Jeffrey Edward, *Place and Experience: A Philosophical Topography*, Cambridge University Press, Cambridge, 1999, 35-36.

⁴ Cresswell, Tim, op. cit., 39.



chapter
on performance 02

2.1 performance spaces

As defined in the last chapter, “place” is a spatial entity that encompasses the notion of event. Together, place and event engage in a symbiotic relationship that requires social interaction to sustain their meaning and connection to the city. Accordingly, architecture becomes the facilitator, generating events and social relations. As Bill Hillier and Julienne Hanson assert, “[t]he ordering of space in buildings is really about the ordering of relations between people.”¹ In an article written by Kim Dovey and Scott Dickson, the scholars identify the innovation of Rem Koolhaas’ work in programmatic innovation creating a “notion of an architecture of liberation in terms of the multiple ‘freedoms’ for new forms of action that architecture is seen to make possible. Space is programmed for indefinite function and chance encounter.”² Citing OMA’s Educatorium in Utrecht as an ideal instance of an architecture that encourages an irruption of events, social encounters and opportunities for action; the building functions as a synthetic landscape

which allows its users to discover their paths and uses. The sense of the building becomes an event and a series of encountered spaces. Designed as fields of play with permeable boundaries, the delineation between inside and outside, between architecture and metropolis is blurred. Intrinsicly tied to the performance element, fashion embraces states of chance encounters. Whether the spectacle is staged or transpires as a random event, performance spaces are embody this freedom that fashion represents and is translated into architecture.

For more than 2,500 years, the theatre has been a central aspect of social and cultural life in human societies. Theatrical performances are the ritualistic interactions between the two main elements of space and event, requiring the simultaneous presence of both the spectators and the performers. Theatre is about the manifold intersecting relationships, as nothing in performance exists in isolation. The performer is always

situated in relation to other actors, the stage, and to the audience, and the performer's representation of his character is also relative to the ideas, behaviours, and objective realities of the other actors as they work cooperatively to construct their performance. The actor's performance must also bring the director's and designer's visions into the process. Finally, the spectators engage with both the performers and with fellow audience members.

Contrary to our commonly held beliefs about the roles of performer and spectator in the theatre, German theatre director Manfred Wekwerth says, "the primary player in the theatre. . . is not the actor but rather the spectator."³ A significant part of the gratification that evolves from participating in theatre events is in experiencing the act itself in the company of like-minded people. Spectators go to the theatre as individuals, or as members of subgroups — couples, families, groups of

friends, teachers, and their students — and through the process of engaging with the performance, they become a collective, unified in part by their shared applauding, laughing, and cheering. As Tyrone Gunthrie, a prominent twentieth-century English theatre director recalls,

Being considerably aware of other members of the audience, as when one is watching an open stage performance, has the positive advantage of reminding one that theatre-going, unlike watching Movies or Television, is a sociable event, and that the audience has a creative, not merely a passive role to play. One's own concentration, participation and enjoyment are intensified by the awareness that they are being shared, that the whole audience is likewise concentrating, participating, and enjoying.⁴

The spectators play a performance role in the theatre as well. Traditionally, an element of the theatrical event has been that the audience members not only go to the theatre to see a presentation, but they are also active participants in their own performance, dressing up and putting themselves on display for others to notice. For the spectators, the social event is embedded in the theatre experience and their reception of the performance is part of the social encounter. The areas within the theatre space to which they are given access also encourage (or discourage) types of social behaviour and social interaction.

Thus, the basic principle of the theatre is a reality in which human beings, in a defined space, are watched by other human beings, a notion which fashion thrives on, whether it is a structured performance as in a runway show or an individual exhibition of style for other to discern. The physical arrangement of space

between where the actors and spectators are positioned deeply affects the relationship between these two fundamental components. Tyrone Gunthrie, generally considered the father of the modern thrust stage, strongly advocates its use as the most successful theatre configuration. His argument stems from the thrust stage's dual function of enabling spectators to have visual connections with both the stage and fellow members of the audience. He says:

The audience did not look at the actors against a background of pictorial and illusionary scenery. Seated around three sides of the stage they focused upon the actors in the brightly lit acting area, but the background was of the dimly lit rows of people similarly focused on the actors. All the time, but unemphatically and by influence, each member of the audience was being ceaselessly reminded that he was

not lost in an illusion, was not at the court of King Humanitie in 16th century Scotland but was in fact a member of a large audience taking part, “assisting at,” as the French very properly express it, a performance, a participant in a ritual.⁵

The visual consciousness established in the gaze between spectators and spectacle furnishes an initial connection, transforming the audience from an assembly of separate human beings into a collective.

fig. 01
Performance Space Typologies

The proscenium theatre has two distinct spaces: a stage for the performance and an auditorium for the spectators. The threshold between the two areas is created by a proscenium arch which acts like a picture frame through which the audience views the performance. The audience is seated on one side of the raised platform and views the show from one direction only. The actor enters the performance space through the scenery which typically fills the space behind the stage.

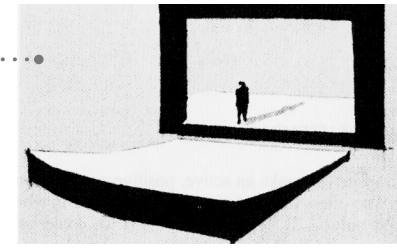

proscenium theatre

In the most widely used theatre space, the thrust theatre, the audience surrounds the stage on three sides while the remaining fourth edge of the stage is backed by a wall or portal that provides a background for the action. Its advantage over the proscenium theatre is a greater level of intimacy between the spectator and the performer as the action occurs in the same space, similar to that of an open stage, but maintains the utility of a backstage. Like the proscenium, the spectators view the stage from essentially one direction. The performers enter the acting area through the scenery upstage or through the audience at the two front corners. Versions of the thrust include the three-quarter thrust in which the stage juts into the middle of the auditorium and semi-thrust or modified thrust which is a combination of the three-quarter thrust and an apron proscenium where the stage situates within the audience gathered centrally.

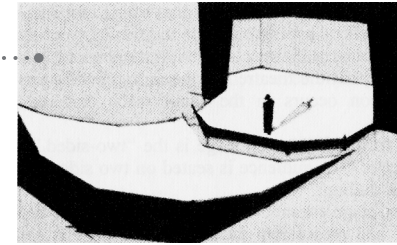

semi-thrust theatre

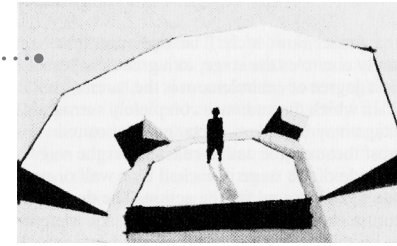

3-sided thrust theatre

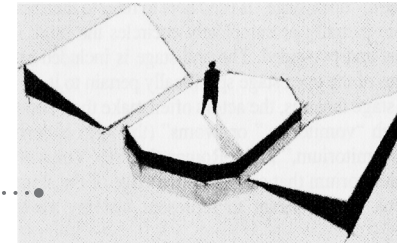

transverse theatre

In the open-stage theatre, also known as the “arena” theatre, the audience and performance space share a unified continuous volume that is not interrupted by a proscenium arch. The spectators are positioned to entirely surround the stage. The performers access the acting area at the four corners of the stage through the audience. The stage can be square, rectangular or round. An uncommon form of the open stage is the “two-sided” or “transverse” theatre in which the audience is seated on two sides of the stage.

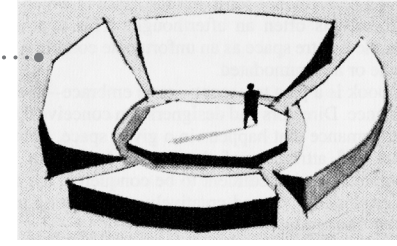

arena theatre

2.2 the spectacle of fashion

The connections between fashion and spectacle envelop not simply the performative aspect of wearing garments, but also the design of costumes for the stage, the theatrical potential of fashion shows, and the manipulation of celebrities to promote and commodify the latest clothing styles.

In the early twentieth century, theatricalization played a critical role in driving the growing success of the couture industry while offering a lively forum for the dissemination of new fashions. Couturiers such as Paul Poiret collaborated with Parisian theatres in the presentation of plays about fashion houses, mannequins, and dresses, recognizing that such events created ideal opportunities to parade their latest styles before audiences — largely made up of wealthy bourgeois women — who admitted their patronage of the theatre was solely because it satisfied their desire to see the latest styles modelled in a spectacular and compelling

context.⁶ Occasionally, the promotional practices were extended beyond the stage as certain members of elite society among the audience had the honour of wearing the couturier's latest creations to the theatrical productions. Author and critic Arsène Alexandre studied the parallels between the operations of a couture house and those of a theatre in 1902, comparing the similar rhythm of fashion's two-cycle collections of fall and spring with that of the theatre's two-act play. He also noted that, like each theatre, each house of couture had its own unique repertoire and its own trademark style.⁷

The social sphere was a critical element in the development of the spectacle in fashion. During this period in Paris, the aforementioned Poiret was infamous for pioneering highly theatrical and elaborate costume parties which also served as a backdrop for the promotion of seasonal collections. Known as *fêtes*, these contemporary renditions of masquerade balls



fig. 02
Alexander McQueen
Ready-to-Wear
2006 A/W

were extremely popular among the upper social class who arrived decadently dressed for the themed event. In London, Poiret's English counterpart, Lucile, a high society dressmaker, strove to develop the consumer experience with "the social side of choosing clothes, of serving tea and imitating the setting of a drawing room."⁸ Incorporating a stage into her showroom, the presentations were like intimate, domestic tea parties — albeit with live orchestral music accompanying the parading models who were adorned in lavish gowns that were listed in a printed program, creating an intimate and voyeuristic bond between the spectacle and spectator. Thus were the beginnings of the first fashion shows, intrinsically tied to the nature of social events.

Following this era, the theatricalization process evolved, transforming the fashion show from mannequin parades within the intimate settings of the fashionable dressmakers' salons into the elaborate productions

of fantastical spectacles in engaging atmospheres with extravagant stage designs, lighting, and music. Etymologically, the French word "spectacle" denotes theatrical presentation, and the fashion show undeniably corresponds to Guy Debord's ideas in his *Society of the Spectacle*, in that it translates commercial enterprise into alluring display, aestheticizing everyday life on the runway.⁹ In many ways, the works of prominent designers such as John Galliano, Alexander McQueen, Viktor + Rolf, and Hussein Chalayan — all famous for their dramatically staged presentations of fashion garments — articulate their visions to be responsive to our perpetually evolving world of unstable rapid social, economic, and technological change. The creative boundaries continue to be pushed further. Consider McQueen's 1999 Autumn/Winter collection which staged an entire fashion show on an ice-skating rink decorated with silver birch trees in a snowstorm. Likewise, Viktor + Rolf's 2001 Spring/Summer show featured a troupe



fig. 03
Viktor + Rolf
Ready-to-Wear
2001 S/S

of Dutch tap dancers in Busby Berkeley-esque line-ups, culminating in a dance routine by the two designers themselves as the finale. Consider also Dries Van Noten's celebration of his fiftieth collection, at which a chandelier-lit dinner party for 500 was attended by 250 waiters. All the guests were seated at an ultra-long table that converted to a catwalk for the evening's main event; once the dishes were cleared, he served his 2005 Spring/Summer for dessert. Clearly, the fashion runway has become the epitome of spectacle and event.



fig. 04
Viktor + Rolf
Ready-to-Wear
2007 A/W



fig. 05
Viktor + Rolf
Ready-to-Wear
2007 A/W

¹ Hillier, Bill and Julienne Hanson, *The Social Logic of Space*, Cambridge University Press, Cambridge, 1988, 2.

² Dovey, Kim and Scott Dickson. "Architecture and Freedom? Programmatic Innovation in the Work of Koolhaas/OMA" cited in *Journal of Architectural Education*, vol. 56, no. 1, Sept. 2002, 220.

³ Wekwerth, Manfred, "Theater und Wissenschaft" cited in *Space in Performance: Making Meaning in the Theatre*, University of Michigan, Michigan, 1999, 42.

⁴ Guthrie, Tyrone, "Argument" cited in *Theatrical Space: A Guide for Directors and Designers*, Scarecrow Press, Lanham, 1995, 37.

⁵ Mackintosh, Ian, "Architecture, Actor and Audience" cited in *Space in Performance: Making Meaning in the Theatre*, University of Michigan, Michigan, 1999, 268.

⁶ Troy, Nancy J., *Couture Culture*, MIT Press, Cambridge, 2003, 82-83.

⁷ *Ibid.*, 87.

⁸ *Ibid.*, 91.

⁹ Evans, Caroline, *Fashion at The Edge*, Yale University Press, New Haven, 2003, 73.



chapter
on fashion 03

3.1 fashion's social role

According to the Oxford English Dictionary, the word “fashion” has a myriad of definitions ranging from “the action or process of making” and “a particular shape or cut” to “particular stylistic trends” and “conventional usage in dress. The etymology of the word “fashion” is from the Latin *factio*, meaning “making or doing,” and *facere*, which means “to make or to do.” The original connotation of the word alludes to an activity, as fashion was something that one did in contrast with the common contemporary Western characterization of fashion as something that one wears. These multiple definitions are perhaps a reflection of the ambiguity that is deeply inherent in the nature of fashion as a cultural phenomenon. From one perspective, it is associated with the lifestyles of the wealthy, glamorized on the glossy pages of fashion magazine spreads and idolized by image-conscious individuals. On the other side of the spectrum, a commonly held prejudice is that fashion and clothing are trivial, superficial pursuits, particularly

popular in capitalist societies.

This ambivalence surrounding fashion draws on an observation by Nietzsche, who noted that to be ambivalent is a fundamental, innate characteristic of the human condition, as we are subjected to “contradictory emotional or psychological attitudes [and] continual oscillations.”¹ It is precisely this ambivalence, the states of differentiation and oscillation, which fuel the motor of fashion and serve as the backdrop against which its movements flourish. This process was observed at the beginning of the twentieth century by Georg Simmel, a German sociologist, who saw fashion as a social by-product of the opposing processes of conformity and individualism, of unity and differentiation, in society.²

Yet, there is more to fashion than an artificial, temporal arena within which consumer capitalism cyclically renews itself.³ Although obscured by its overt



fig. 06
John Galliano for
Christian Dior
Ready-to-Wear
2006 A/W



fig. 07
John Galliano for
Christian Dior
Haute Couture
2007 S/S

frivolous and commercial qualities, fashion plays a significant social and cultural role. The garments that individuals choose to wear represent more than mere attire; on a collective level there is an underlying social meaning that is silently being communicated to the public. Fashion symbolically locates one within the universe of status claims and lifestyle attachments. One's clothing conforms to certain parts of an organization that negotiates the relationship between the individual's identity and place in society, revealing both social integration and differentiation within the larger community.

In his essay *Men's Fashion* (1898), Adolf Loos, a Viennese modernist architect and writer, quotes an American philosopher who says, "[a] young man is rich if he has a good head on his shoulders and a good suit in the closet."⁴ Loos was intrigued by modern fashion, which he understood to fulfill two functions: to provide

adequate protection from weather and environment, and to serve as a mask enabling individuals to effectively impersonate a social role. He further comments:

[one ought] to be dressed in such a way that one stands out the least. A red tail coat would attract attention in the ballroom; therefore a red tail coat is not the modern style for the ballroom. A top hat would attract attention when ice-skating, therefore a top hat is not the modern dress for ice-skating. Among the best people, to attract attention to oneself is considered vulgar.⁵

As Loos argues in the above passage, clothing should make one inconspicuous enough to fit into society. One should strive to conform and enter into a dialogue with a specific environment or social group, with an appropriate outer appearance and etiquette suited

for the specific occasion. Loos's discourse was written within the historical context of late nineteenth-century Austria, where economic and political developments favoured the upper social class, and where individuals were distinguished by the class or professional sphere to which they belonged.

In 1904, Georg Simmel echoed Loos's views, arguing in his writing that fashion is a product of class distinction that not only conveys solidarity and uniformity with those of equal class, but also accentuates whether or not one is a member of another social circle. Simmel strongly emphasized this social class differentiation as the motivation for fashion:

Social forms, apparel, aesthetic judgment, the whole style of human express, are constantly transformed by fashion, in such a way, however, that fashion — i.e., the latest fashion

— in all these things affects only the upper classes. Just as soon as the lower classes begin to copy their style, thereby crossing the line of demarcation the upper classes have drawn and destroying the uniformity of their coherence, the upper classes turn away from this style and adopt a new one, which in turn differentiates them from the masses; and thus the game goes merrily on.⁶

Following this era, the rise of industrial capitalism and urbanization saw the heightening of individual anonymity and alienation, and clothing continued to be utilized as a communicative tool which guaranteed a sense of belonging and aided identification.⁷ Dress became a declaration, challenging not only dominant beliefs, but power structures and cultural norms. Rather than following the industrial infrastructure of fashion design, production, and marketing that attracted



(from left to right)
 fig. 8
 1950's Teddy boy's look
 Costume National
 Mens 2006 S/S

fig. 9
 1960's rockers' look
 Costume National
 Mens 2006 S/S

fig. 10
 1960's -70's mod look
 Marc Jacobs
 Ready-to-Wear
 2003 A/W

fig. 11
 1980's rap culture look
 Enyce
 Ready-to-Wear
 2005 S/S

wealthy aristocrats, less privileged classes favoured the countercultural stance of the bohemian outsider, which provided a more sensitive composition for dressing the self. As witnessed in the recent eras — with the Teddy boys in the 1950's, the hippies and rockers in the 1960's, the mods in the 1960's-70's, and the rap culture in the late 1980's-90's — visible subcultures chose to express their radical political and social views through extreme dress, using fashion and clothing as both weapons and defences, counteracting the elitist society by favouring the unconventional. North American feminists reacted by adopting “muted imitations of male dress (the business suit) or parodied the masculine vestimentary codes (the tuxedo look, sequined ties)”.⁸

These days, more than ever before, fashion is an expression of status, belonging, or dissent, as “it enables people to mark themselves out from the anonymity of the city and align themselves with a particular group.”⁹ Not

only are the garments and accessories that we use to adorn our bodies an outward display of our allegiances, but the stores where one shops have also become a means of expressing certain values and attitudes. Fashion is an important instrument, choreographing the spectacle that we display to society as an expression of both the self and the collective. Together with architecture, the way we dress has become one of the most significant ways in which social relations between ourselves and others are constructed, experienced, and understood.



3.2 the relationship between fashion and architecture

Two significant and dominant differences between fashion and architecture are: 1) their character, as fashion is contradictory and transient in nature, while architecture is about permanence and longevity; and 2) the scales of production, as fashion designers create garments for the single human body, whereas architects construct structures large enough to shelter many bodies collectively. Despite these obvious differences, the point of origin for both practices is rooted in the fundamental task of enclosing space around the human form. Fashion's ambiguous affair with architecture theoretically dates back as far as Vitruvius, a first-century Roman architect, who associated the metaphor of architecture with clothing. In his famous treatise, *The Ten Books of Architecture*, Vitruvius conceived of Greek dress and architecture in unity with the proportions of the human body. He compared the Doric column to "the strength and beauty of the body of a man," while the Ionic column was identified with a matron and the Corinthian

column was associated with a young maiden.¹⁰

Although "fashion" periodically made an appearance in the writings of architecture from the late seventeenth century to the nineteenth century, a notable theoretical revival of the interrelationship of the two disciplines emerged during the mid-nineteenth century, when Gottfried Semper, a German architect, shed new light on the correlations between architecture and clothing. His research on the architecture of classical civilizations was viewed through the lens of citizens' dress during his era. In 1850, he released his dissertation, *Four Elements of Architecture*, in which he introduced the notion that architecture was historically derived from four technical arts: ceramics, carpentry, masonry, and weaving. Semper further speculated in his best known publication, *Der Stil in den technischen und tektonischen Künsten, oder praktische Aesthetik* (Style in the Technical and Tectonic Arts, or Practical Aesthetics),



fig. 12-18
Viktor + Rolf
Haute Couture
1999 A/W

that weaving and wickerwork were crucial skills for the primary architectural expression of enclosure, namely the wall. He postulated that the origins of architecture were not derived from either the mound or post and beam construction, but rather, the woven wall, the “primordial seed” for dwelling. According to Semper, the earliest enclosures consisted of hanging carpets, which established the spatial boundaries of a dwelling, and also played an essential role in the production of social space. The notion of ownership of these spaces, occupied and demarcated by the boundaries of the woven structure, generated the idea of community.

Emanating from textiles, Semper noted that, etymologically, the German word *wand* (wall, partition, or screen) and *gewand* (dress, garments, or clothing), were both derived from a single root signifying the woven material that composed the wall. He also associated the notion of *bekleidung* (dressing or cladding) to *kleidung*

(clothing).¹¹ In Semper’s *Bekleidung* thesis, the theory of cladding, the first task of architecture was cladding. This was later affirmed by the work of his disciple, the previously mentioned Adolf Loos, in his essay, *The Principle of Cladding*:

The architect’s general task is to provide a warm and livable space. Carpets are warm and livable. He decides for this reason to spread out one carpet on the floor and to hang up four to form the four walls. But you cannot build a house out of carpets. Both the carpet on the floor and the tapestry on the wall require a structural frame to hold them in the correct place. To invent this frame is the architect’s second task. This is the correct and logical path to be followed in architecture. It was in this sequence that mankind learned how to build. In the beginning was cladding.¹²

fig. 19
Sydney Opera House, Sydney, Australia
Jorn Utzon



fig. 20
Viktor + Rolf
Ready-to-Wear
2003 A/W

Semper's influential theories later became the foundation of various architectural ideas, developed by his contemporaries and followers, including those of Loos and Otto Wagner.

In 1977, architectural theorist, Charles Jencks published a diagram in his infamous book *The Language of Postmodern Architecture*, highlighting the myriad of stylistic modulations in architecture from 1960 to 1980; a reference which illuminated resemblances to fashion's rapid cycle of style change.

In addition to theoretical ideas, the cross-fertilization and similarities shared between fashion and architecture throughout history illustrate the deep commonality of execution, experience, ideas, and design between clothing and building. Fashion designers seek architectonic influences in both forms and silhouettes:

Ladies of Henry VIII's court wore headdresses in the shape of the Tudor arch, while male courtiers wore expressions of Gothic architecture in their hats, capes and padded court attire. The trunk hose and cod pieces of the Elizabethan era mimicked the columns, buttresses and even table legs of the period. Architecture of the 1840s was dominated by blunted arches and rounded window frames, the same flattened curves conspicuous in the dress lines of the period.¹³

Similarly, architects are intrigued by the fashion designer's craft and technique in the use of fabric, and they strive to mimic a similar fluidity and visual aesthetic in their own structures. The parallels are further revealed in the vocabulary commonly shared between the two disciplines which are used to describe both the buildings and garments. These terms include, but

fig. 21
Royal Ontario Museum, Toronto, Canada
Daniel Libeskind



are not limited to, “wrapping,” “layering,” “pleating,” “draping,” “exposing,” “veil,” “transparent,” “reveal,” and “textures.” Inspired by this reciprocal relationship between the two disciplines, the design proposal borrows fashion’s notion of the “fold” as an architectural strategy to create a dynamic relationship between two existing structures, discussed further in the fifth chapter.

¹ Davis, Fred, *Fashion, Culture and Identity*, University of Chicago Press, Chicago, 1992, 23.

² *Ibid.*, 23.

³ Miles, Steven, *Consumerism as a Way of Life*, Sage Publications, London, 1998, 90.

⁴ Loos, Adolf, *Spoken Into The Void: Collected Essays*, MIT Press, Cambridge, 11.



fig. 22
Gareth Pugh
Ready-to-Wear
2007 S/S

⁵ *Ibid.*, 11.

⁶ Simmel, Georg, “Fashion” cited in *American Journal of Sociology*, v. 62, no. 6, 1957, <<http://www.jstor.org.proxy.lib.uwaterloo.ca/view/00029602/dm992513/99p1373a/0>> accessed on 18 October, 2006.

⁷ Beward, Christopher, *Fashion*, Oxford University Press, Oxford, 2003, 217.

⁸ Silverman, Kaja, “A Fashionable Discourse” cited in *On Fashion*, Rutgers University Press, New Brunswick, 1994, 193.

⁹ Castle, Helen, “Catwalk Architecture: An Interview with Sally Mackereth” cited in *Architectural Design*, v.70, no. 6, Dec. 2000, 61.

¹⁰ McLeod, Mary, “Undressing Architecture: Fashion, Gender, and Modernity” in *Architecture in Fashion*, Princeton Architectural Press, New York, 1994, 41.

¹¹ *Ibid.*, 48.

¹² Loos, Adolf, *op. cit.*, 66.

¹³ Quinn, Bradley, *The Fashion of Architecture*, Berg, Oxford, 2003, 2.



chapter
on decoration **04**

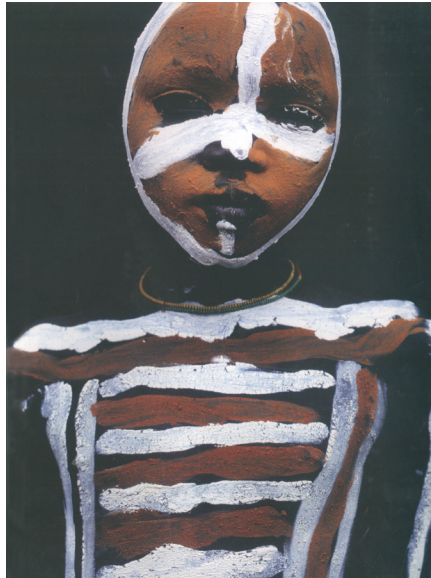

fig. 23
Beautification

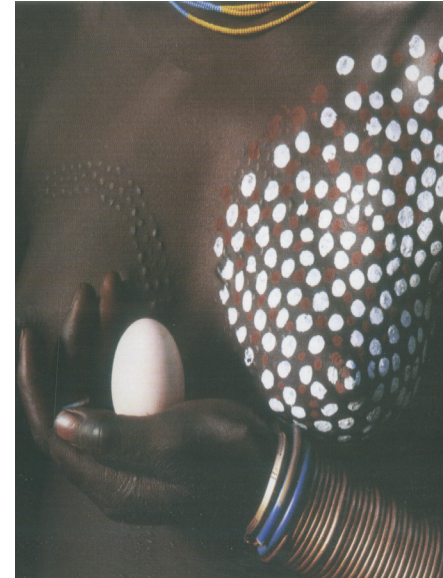

fig. 24
Beautification

4.1 the influence of ornamentation in design

As “man has always expressed his desire to embellish the space he lives in, either on objects or his own body,”¹ ornamentation becomes the physical expression of an innate human characteristic, articulated either as an aesthetic quality shaped by its technical and utilitarian traits, or as an additional layer to the object’s form and function. Tracing the origins of ornamentation, one of the earliest examples, termed “beautification,” was a ritual encompassing the decoration of one’s body, either by inscribing one’s skin or by adorning one’s body with jewellery. Ornamentation held a dual role as both an eternal part of the human body and an ephemeral accessory with its own inherent aesthetics. The practices of embellishment on the human body included painting, tattooing, and even scars made by deliberate mutilation and deformation, all of which were done “to aesthetically set off or enhance a person’s natural features and emphasize differences in customs, sex, ethnicity, social hierarchy and age.”² Dictated by primal

rules of balance and symmetry, the embellishment was normally influenced by its surroundings, depicted either by imitating the visible natural forms, or through abstract geometric representations. Colours also played a vital role in illustrating the pictorial decoration, from mythically inspired, elaborate geometric patterns to marks in an arithmetical sequence representing magical symbolic values. Thus, the first instances of ornamentation were not merely driven by aesthetic purposes, they also served as visual symbols representing a person’s social hierarchy, tribal affiliation, or a stage in life within a given society. In 1908, Adolf Loos’ dissemination of his essay, *Ornament and Crime*, opposed the practice of ornamentation and tattooing by condoning the act as immoral. He criticized the means of symbolic expression as a mark of a criminal or a degenerate who engaged in a relation which separated oneself from the moral and civilized circumstances of modern man. Nonetheless, inscribing one’s skin became a fashionable statement

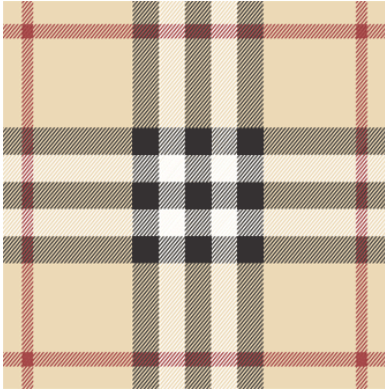

fig. 25
trademarked
Burberry check



fig. 26
Knotted Chair
Marcel Wanders

that solidified ornamentation's position within the realm of fashion. Today, embellishment continues to play a significant role in clothing, especially within the domain of haute couture. Haute couture is an elite sector of the fashion market, exclusively producing garments that are considered works of art based on the high quality of the fabric and patterns used, and usually being hand-sewn with extreme care taken to construct intricate detailing and finish. Decorative patterning in textiles, wall coverings, and other goods further associate the haute couture garment with certain companies. Examples of this include Burberry's signature check, Pucci's wildly coloured and bold patterns, and the distinct "LV" monogram of Louis Vuitton: all identifiable prints that exhibit a specific brand allegiance.

Embellishments were closely linked to the rise of the "industrial arts" — the heart of where design was born — and eventually led to the flourishing plastic and

decorative epoch of Art Nouveau, which resonated from 1890 to 1914. Its brief popularity was driven into exile by the prevailing Modernist era and its advocates, including designers Adolf Loos, Peter Behrens, and Walter Gropius, who all opposed the excesses of ornamentation and championed simplicity. The resurgence of decoration in the industrial design field occurred when avant-garde designers longed to create something that provoked an intense aesthetic experience, and the renaissance of ornamentation provided the answer in fashioning a renewed interest in craftsmanship and decoration, propelling a truly expressive design to provoke people's imaginations. Advanced technologies have helped to establish unprecedented changes into the design of consumer goods — new materials, new interfaces between the object and the user, and unique production flexibility allow the modulation from large scale to small scale production.³ Celebrated industrial designer Marcel Wanders successfully exploited the boundaries

of ornamentation using innovative technology, material, and fabrication processes to create triumphant pieces of work. As seen in his famous *Knotted Chair*, Wanders' employment of electronic equipment allows the "motif" in the object to transcend mere surface application, to be incorporated into the object as a pattern, the structure, and frame of the product. Wanders explores the volumetric complexity as well as structural decoration, exemplified in the recent multipurpose stool for Kartell or the bumpy membrane for Flos' Zeppelin lamp.⁴

Paralleling its counterpart in industrial design, the re-emergence of decoration within contemporary architecture gradually surfaced as a departure from the reductive forms of the International Style. In September 1959, Thomas H. Creighton, then the editor of *Progressive Architecture*, identified a tendency toward "surface or façade plasticity" as the defining characteristic of a movement he dubbed the "New Sensualism,"



fig. 27
US Embassy,
New Delhi, India
Edward Durrell
Stone

citing Edward Durrell Stone's United States Embassy in New Delhi, India, as a leading example, featuring a textured and patterned exterior screen wrapped around the building's perimeter.⁵ Morris Lapidus was another architect that Creighton identified as an ambassador of his "New Sensualism" movement. Lapidus was notorious for his use of over-the-top ornamentation in combination with brilliant lighting effects, colours, and curvilinear forms, producing flamboyant and spectacular spaces. William Jordy further advocated Creighton's notion of the new decorative trend, and perceived the reawakening of ornamental surfaces in recent American building projects as a reaction to the prewar functionalist ideology that had succeeded the concept of beauty in architecture.

As with industrial design, the advent of new materials, processes, and technologies helps decoration to secure its presence within the post-modernist



fig. 28
*Ricola Europe Factory,
Mulhouse-Brunstatt,
France
Herzog de Meuron*

architecture scene, defining ornamentation on another level that would have been inconceivable without contemporary technological advances. Herzog and de Meuron's Ricola Europe factory and storage building in Mulhouse-Brunstatt, France, is a prime example of utilizing progress in digital technology and methods of fabrication to implement the building's characteristic decorative tattooing. Modernizing historical archetypes of transparency, patterning, and excess, the main façade of the building, and its large cantilevered overhang, are adorned in translucent polycarbonate panels that are silk-screened with repetitive plant motifs to form a surface that partitions the interior while displaying a metanarrative for the herbal remedies produced and housed in the building.⁶

Technological developments have enabled a building's features, which were once simply ornamental, to be transformed into fundamental, structural elements.

This method of surface articulation synthesized pattern with the building's support, converting serial motifs from mere ornamentation into structural envelope.⁷ Herzog and de Meuron's Prada Aoyama Tokyo boutique is an elegant example of a non-figurative patterned surface, wrapping around the entire building while concealing the structural complexity of the six-level, five-sided structure. Burying all functions within the central core volume, the translucent, honeycombed and patterned skin encloses a labyrinth of interior spaces that only truly discloses its beauty when it glows at night. Deyan Sudjic applauded the building in an article he wrote for *Domus*, praising the store for "serv[ing] to define [a] new building type: part advertising billboard, part architectural gift-wrapping," remarking on the graceful enclosure, which renders the whole building a successful retail display.⁸

From a primordial act of embellishing the human body to the translucent, honeycombed and patterned

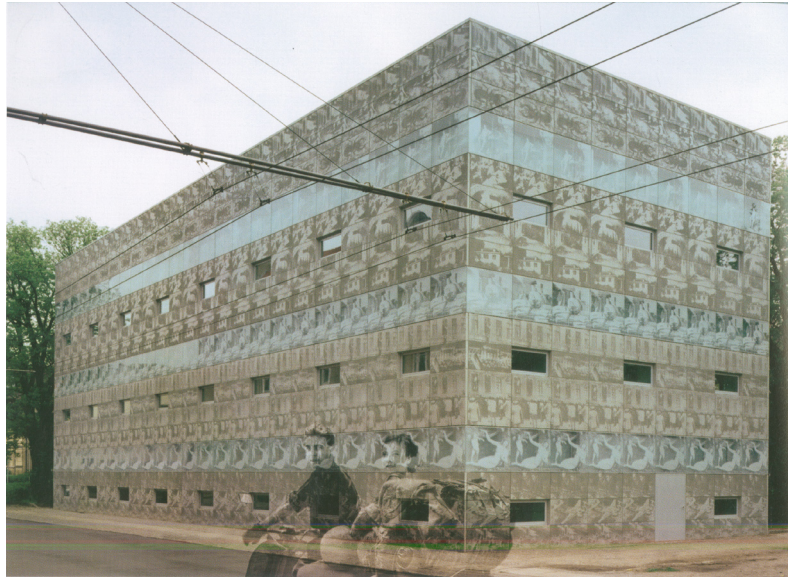

fig. 29
Ricola Europe Factory,
Mulhouse-Brunstatt,
France
Herzog de Meuron

skin of Herzog and de Meuron's Prada Aoyama Tokyo boutique, the notion of decoration has appeared contextually with the birth of design. Its profound significance reverberates in every design-related field, bearing witness to humans' creative capacity to conceive decorative motives. Inspired by historical influences, whether the ornamentations were geometric, floral, animalier or humanistic, the revival of embellishment within the fields of design have become a narrative link that connects the certainties of the past with the prospects of the future. This "temporal bridge" is a means to fascinate and capture the user's attention, as ornamentation has become the reconciliation of ethos and pathos in form.⁹ Pervading the clothes we put on our backs, the objects we use each day, and the spaces we inhabit, embellishment thus plays a significant role in fabricating an intense aesthetic encounter, awakening our sensory experience with objects and space.

¹ Paris, Tonino, "Ornament and the Aesthetics of Objects" cited in *Industrial Design: Ornament & Design 23/06*, 7.

² *Ibid.*, 7.

³ Vitta, Maurizio, "The Ghost of Decorative Embellishments" cited in *Industrial Design: Ornament & Design 23/06*, 13.

⁴ Martino, Carlo, "Decorative Variations" cited in *Industrial Design: Ornament & Design 23/06*, 60.

⁵ Rosa, Joseph, *Glamour: Fashion + Industrial Design + Architecture*, New Haven: Yale University Press, 2004, 124-5.

⁶ *Ibid.*, 131.

⁷ *Ibid.*, 131.

⁸ *Ibid.*, 132.

⁹ Vitta, Maurizio, *op. cit.*, 15.

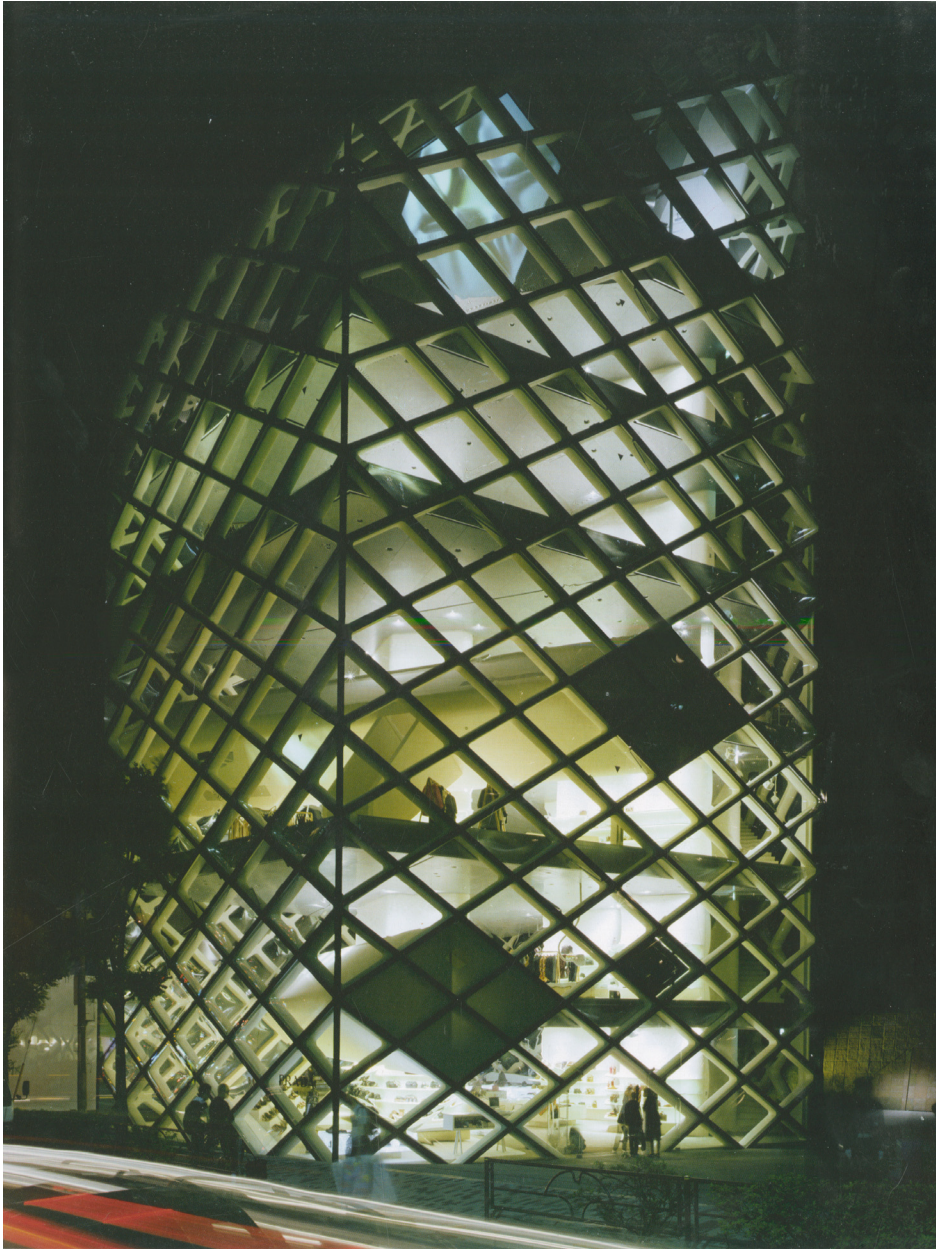
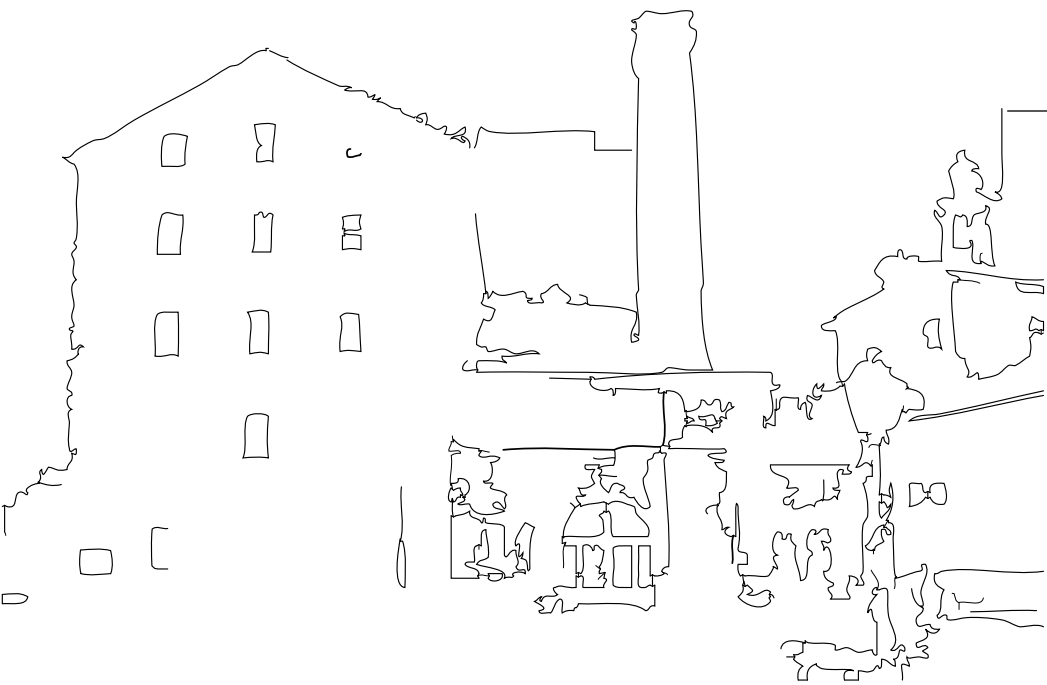

fig. 30
Prada Aoyama in
Tokyo, Japan
Herzog de Meuron



chapter
the site 05

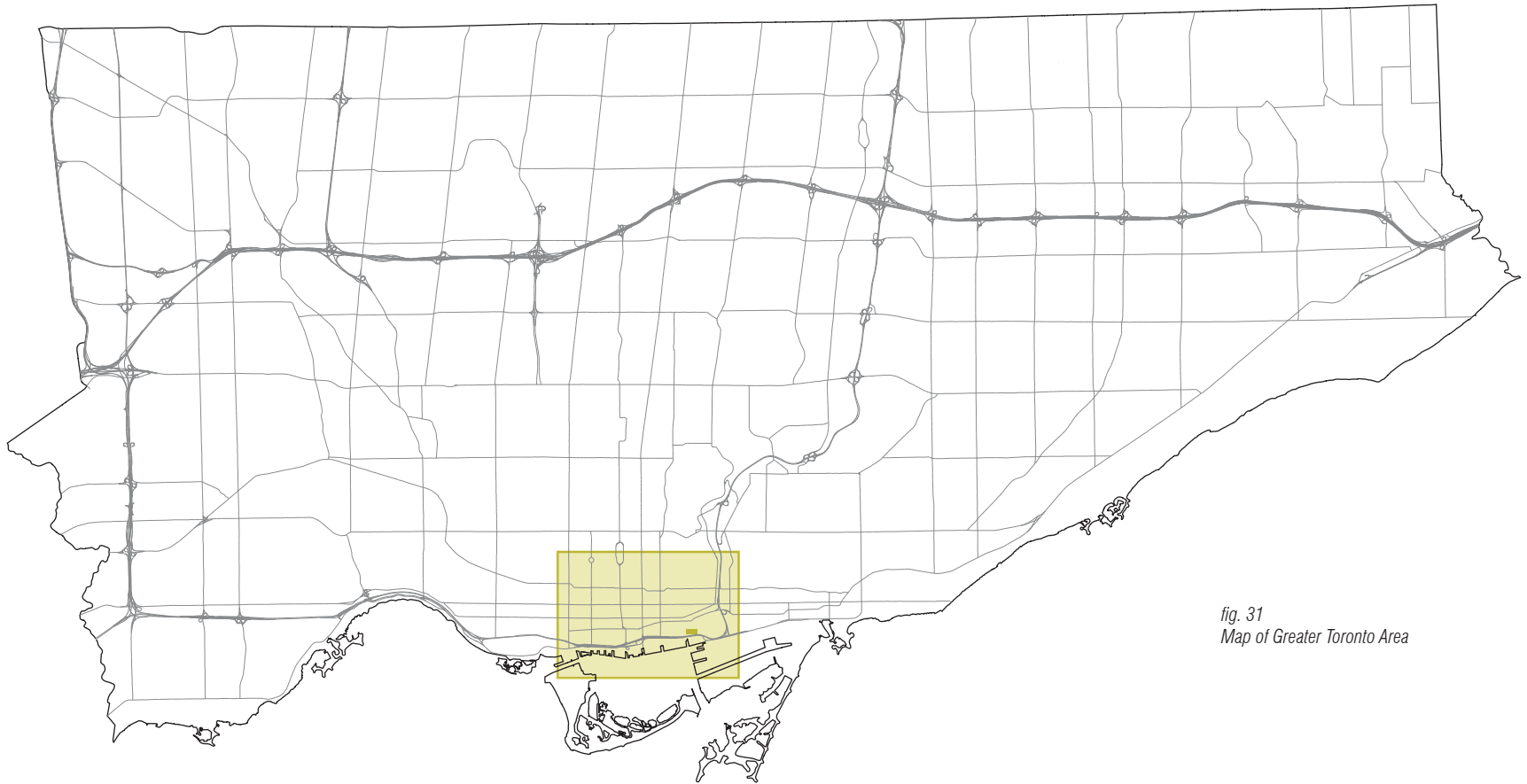
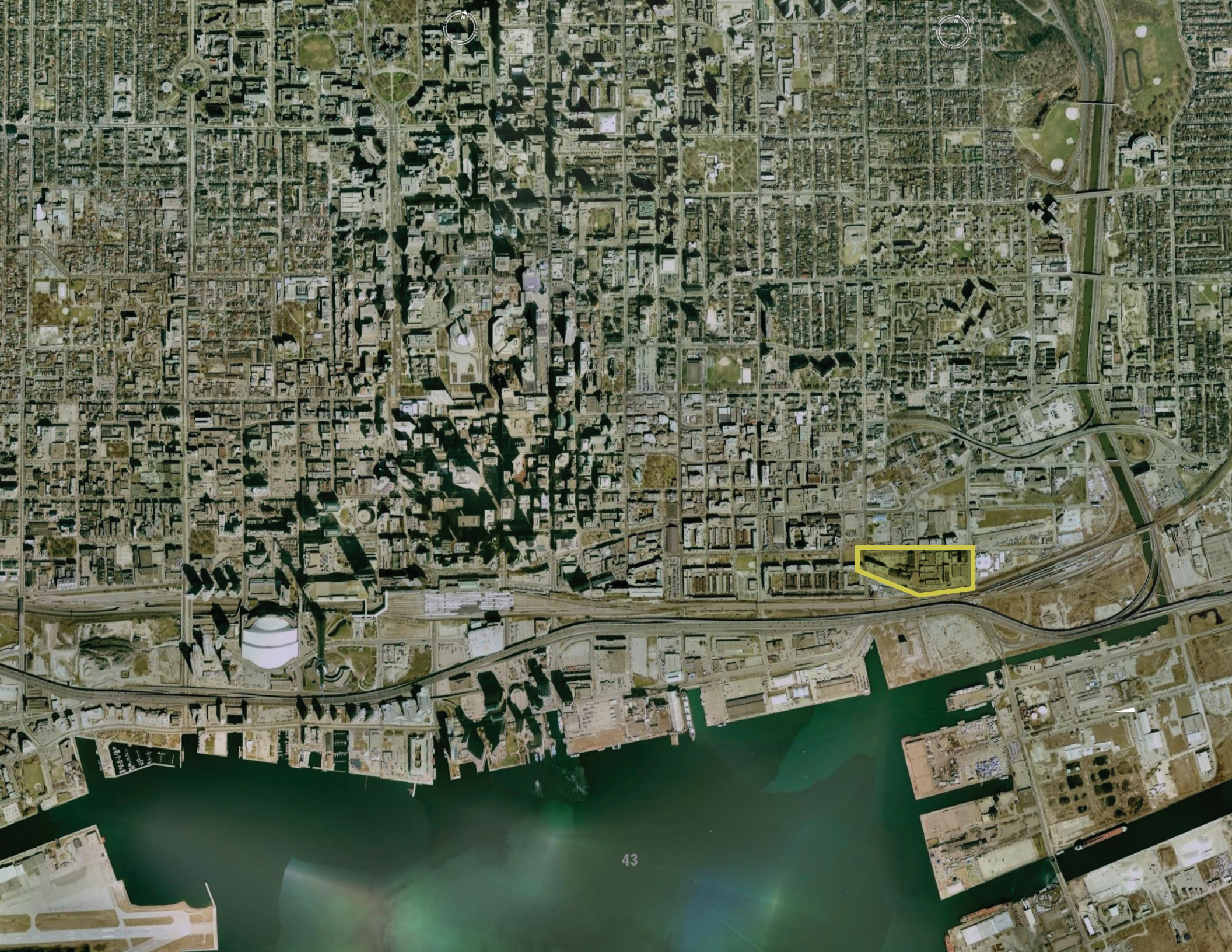
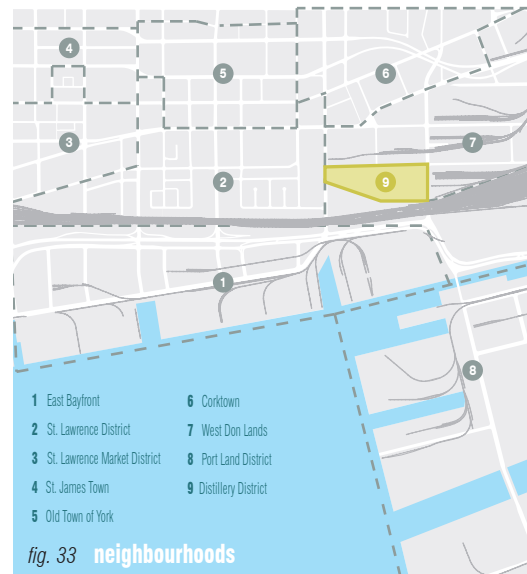

fig. 31
Map of Greater Toronto Area

fig. 32 (opposite page)
Aerial Photo of Greater Toronto Area





5.1 site and situation

Situated east of the former downtown core of Toronto, the former Gooderham and Worts Distillery, now referred to as the “Distillery District,” is a collection of forty-five brick and stone buildings on a thirteen acre plot of land, and is recognized as North America’s largest and most notable collection of Victorian-era industrial architecture. Currently, the Distillery District is bordered by Cherry and Parliament Streets to the east and the west, with Mill Street and the Gardiner Expressway serving as its northern and southern boundaries, respectively. As a result of the future development of the neighbouring West Don Lands (formerly known as the Ataratiri lands) flanking its eastern perimeter, the Distillery District will be positioned in the geographic heart of the city.

With the Distillery District’s compelling historical narrative, the condition of the complex and its surrounding area provides physical evidence of the changes caused by a multitude of processes, including



technological advancements and city politics. In the following sequence of maps, the development of the Gooderham and Worts area is traced, illuminating the physical growth of the distillery’s operations, the gradual shifting of the shorelines southward as a result of waterfront development, and the transformation of urban activities within its borders. The Distillery District has grown from the original windmill that stood as a distinct landmark along the city’s waterfront and has progressively expanded to a sizeable area that once covered the two city blocks between Parliament and Cherry Streets, from Mill Street to the railway tracks. The smaller distillery complex at the northwest corner of Mill and Trinity Streets includes the warehouses on the north side of Mill between Trinity and Cherry, the docks, grain elevators, and coal sheds on the waterfront, a cooperage on Front Street, a stave shed in an adjacent bottling complex, and a cattle shed complex on the east side of the Don River, south of the Sunlight Soap Works.¹



fig. 35-37
Historical Maps of Surrounding Fabric Encompassing Gooderham and Worts Distillery



fig. 38-40
Historical Maps of Surrounding Fabric Encompassing Gooderham and Worts Distillery

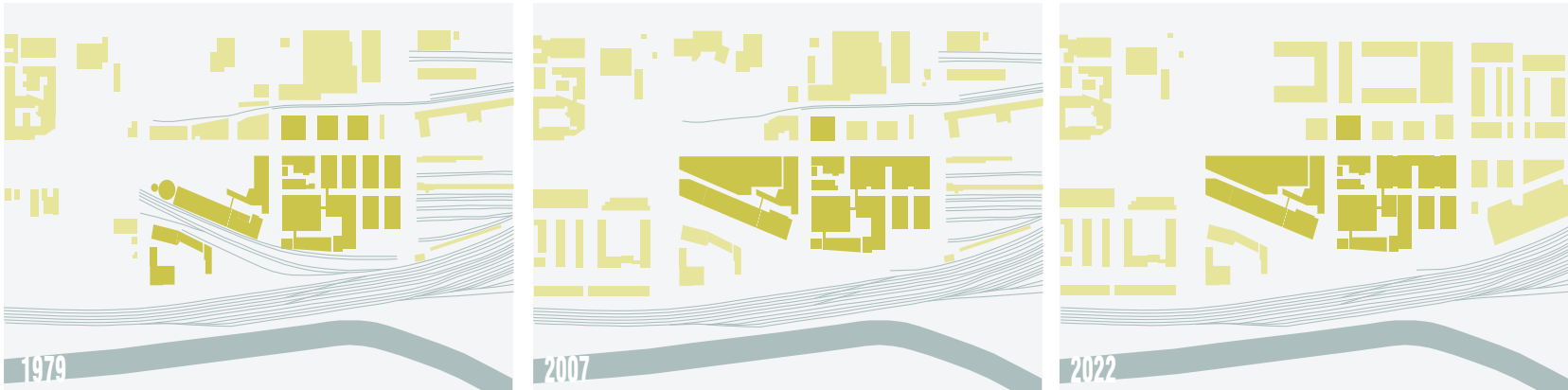

fig. 41-43
Historical Maps of Surrounding Fabric Encompassing Gooderham and Worts Distillery



*fig. 44
Historic Painting
of Gooderham
and Worts*

5.2 revisiting the past

The original municipal plans for this area, which incorporated extensive parklands, became subordinate to commercial and economical interests. Its location beside the main line of the Canadian National Railway, and its position at the mouth of the original route of the Don River outlet into Lake Ontario cemented the site as a key industrial and trans-shipping hub facilitating connections to the rest of Canada and, indeed, the world.²

The cobblestone paths and brick walls of the Gooderham and Worts Distillery embody the structural remains of what was once Canada's largest whisky manufacturer. Founded in 1832 by brothers-in-law James Worts and William Gooderham, the distillery first began as a milling operation, consisting of a wind-powered grist mill on the shore of Toronto's harbour. With a surplus of wheat, Gooderham decided to further develop the empire by producing beer and whisky in 1837. The

distillery occupied a small plot of land on the west side of Trinity Street near the harbour, and the business expanded by acquiring a small wharf at its waterfront. Sadly, a fire destroyed the original distillery and it had to be rebuilt in 1842. Gradually, as various factories and businesses were established in the area, they attracted a growing population of workers and housing options had to be quickly provided in the surrounding areas. Families, including the proprietors Gooderham and Worts, lived in the complex of their respective industrial properties. The arrival of the railroad in the mid-nineteenth century, which ran along the district's southern border, hastened the industrialization of the eastern waterfront and increased the area businesses by creating easier access through which products could be shipped and received. The area flourished and caused the steady expansion of the distillery. A new mill and state of the art distillery were erected after 1859, followed by a malt house, and a company office between

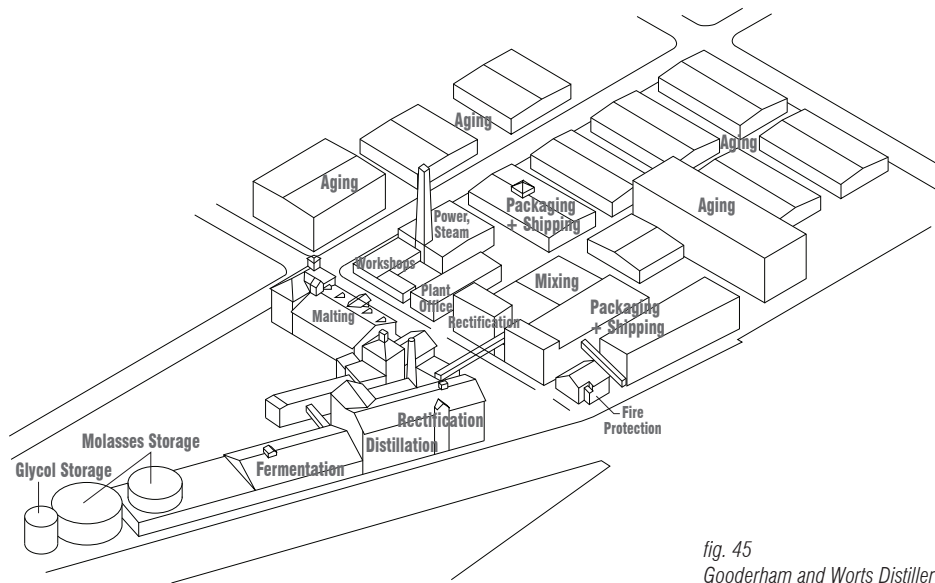

fig. 45
Gooderham and Worts Distillery Elements and Processes

1863 and 1864. In 1869, another fire caused interior damage to buildings 2 through 7, yet the robust stone walls stood strong. By 1871, the Gooderham and Worts Distillery was responsible for almost half of Ontario's total production of spirits, and exported its whisky and spirits to both Canadian and American markets.³ Despite a law enacted in 1883, which legislated that whisky needed to be aged for a minimum of two years before it could be sold, the distillery continued to prosper. In fact, expansion of the facilities was required to accommodate the growing demand, and warehouses were constructed to store the massive output. By 1887, the property had extended to both the west and the east, to what are now its current boundaries at Parliament and Cherry Streets.

The early twentieth century saw the advent of both the first world war and, perhaps more significantly to the distillery, prohibition, during which the manufacture, transportation, import, export, and sale of alcoholic

beverages was restricted or illegal, forcing the Gooderham and Worts Distillery to face difficult and trying times. In 1923, the distillery was sold to Harry C. Hatch and a group of his associates, who later acquired the Hiram Walker and Sons Limited plant in Windsor, Ontario. In 1927, a pivotal year for the distillery, the final two buildings in the complex were completed, and the distilleries — now owned by Hatch — were merged, creating the Hiram Walker-Gooderham and Worts Limited, which gradually moved its distilling operations to a new facility closer to the American border.⁴ As production slowly declined, vacant buildings and lands were leased to new tenants. Despite modest volumes, the Gooderham and Worts brand whisky, rum, and antifreeze continued to be manufactured, rescuing the distillery from the threats of 1960s urban renewal and modernist mega-projects, until all production formally ceased in 1990.

5.3 the revitalization and the present

Following the end of production and the termination of Gooderham and Worts as an active distillery, plans for redevelopment were made. Toronto's municipal planning council had three central concerns in restoring this complex: (1) the revitalization of abandoned industrial space; (2) the redevelopment of the central waterfront district; and (3) the preservation of heritage buildings.⁵ Since Gooderham and Worts Distillery was the city's largest remaining (albeit deserted) industrial complex centrally located near the waterfront, and had received formal recognition as a site of "National Historic Significance" by the Canadian government, opportunities for its future use blossomed. The current revitalization of the Distillery District was influenced by three documents: (1) a consultants' study submitted to Toronto's planning department in 1990; (2) a 1991 proposal for the site from the site's owner; and (3) the city's official plan for the Distillery District, enacted in 1994.⁶

The consultants' study is comprised of an extensive historical record of the distillery's past, and an elaborate proposition of guidelines for the future redevelopment of this novel site. The three governing principles of the study's revitalization plan state that the Distillery District is "a heritage resource of extraordinary importance in North America, deserving the utmost efforts towards its preservation"; that the process of heritage preservation should be financially self-sustaining, contingent on the overall viability of redevelopment; and that new structures should not overwhelm the older buildings but fit in with them comfortably.⁷ The consultants emphasized the significance of applying the element of diversity and hybridization in the distillery's facilities and programme, suggesting a wide variety of uses from retail and office space to leisure and cultural activities to residences. They pursued a moderate approach increasing the scale and density of the existing development by three times. The study recommended that, in addition to being a

place of cultural consumption, the site should also function as a “work space for artists,” a concept which has since been brought to fruition, playing a pivotal role in the successful resurrection of the distillery.

A year after the consultants’ study was released, Hiram Walker, the multinational company that had acquired the Gooderham and Worts Distillery, released a proposal of its own which materially agreed with the consultants’ propositions. The owner’s proposal shared a similar vision of implementing diversity in uses, while maintaining the utmost respect for historical preservation. The Hiram Walker proposition only differed from the consultants’ report in two ways. First, Hiram Walker’s vision considered a higher density volume of new construction and, second, it considered the conversion of several one-storey warehouses as podiums for new buildings, an option abandoned by the consultants. Interestingly, both reports described the

use of studio spaces as a subordinate function within the larger context of the development, which is contrary to the eventual outcome and revitalization that we see today.

Redevelopment plans were stalled for three years following the release of the owner’s proposal, as elaborate discussions took place amongst all of the parties interested in the fate of the distillery. These stakeholders included city planners, historical conservation groups, and concerned members of the community. In 1994, the city finally authorized a plan which essentially followed the previous proposition’s viewpoints on the fundamental issues such as heritage preservation, the footprint of redevelopment, and the provision of mixed use. It also included some distinct departures from Hiram Walker’s approach which, for example, included the proposition to raise the number of residential units in the project and decrease the amount of commercial floor space.⁸



fig. 46
View of Trinity Street During the Day

Despite the plan's approval by the Province of Ontario's municipal planning agency — which made some minor changes — the factor of marketability caused a period of decline in demand for office and commercial space in the Toronto area. As such, the land sat unchanged for nearly a decade, except for the erection of three condominium buildings along the perimeter of the site in the late 1990s.

In late 2001, the former Gooderham and Worts Distillery was sold to a local firm, Cityscape Holdings Inc., a company that was committed to historical revitalization and preservation. They shared the same perspectives that Hiram Walker and the consultants had previously proposed, and pledged to follow the strategy of adaptive re-use and redevelopment of the distillery. Slowly, the distillery was on its way to being regenerated as tenants were found and the derelict buildings were transformed into places of consumption and leisure. In

the spring of 2003, the revived distillery opened and was branded the Distillery District by Cityscape Holdings Inc. Today, the Distillery District is home to over one hundred commercial tenants, including artists' studios and workshops, a brewery, galleries, a theatre, restaurants, a café, and boutique retailers. The Gooderham and Worts Distillery has been restored to its original intentions of being a place of leisure and activity and its fate is fulfilled as a place of cultural and artistic destination.

fig. 47 (opposite page)
Programme of Distillery District Uses

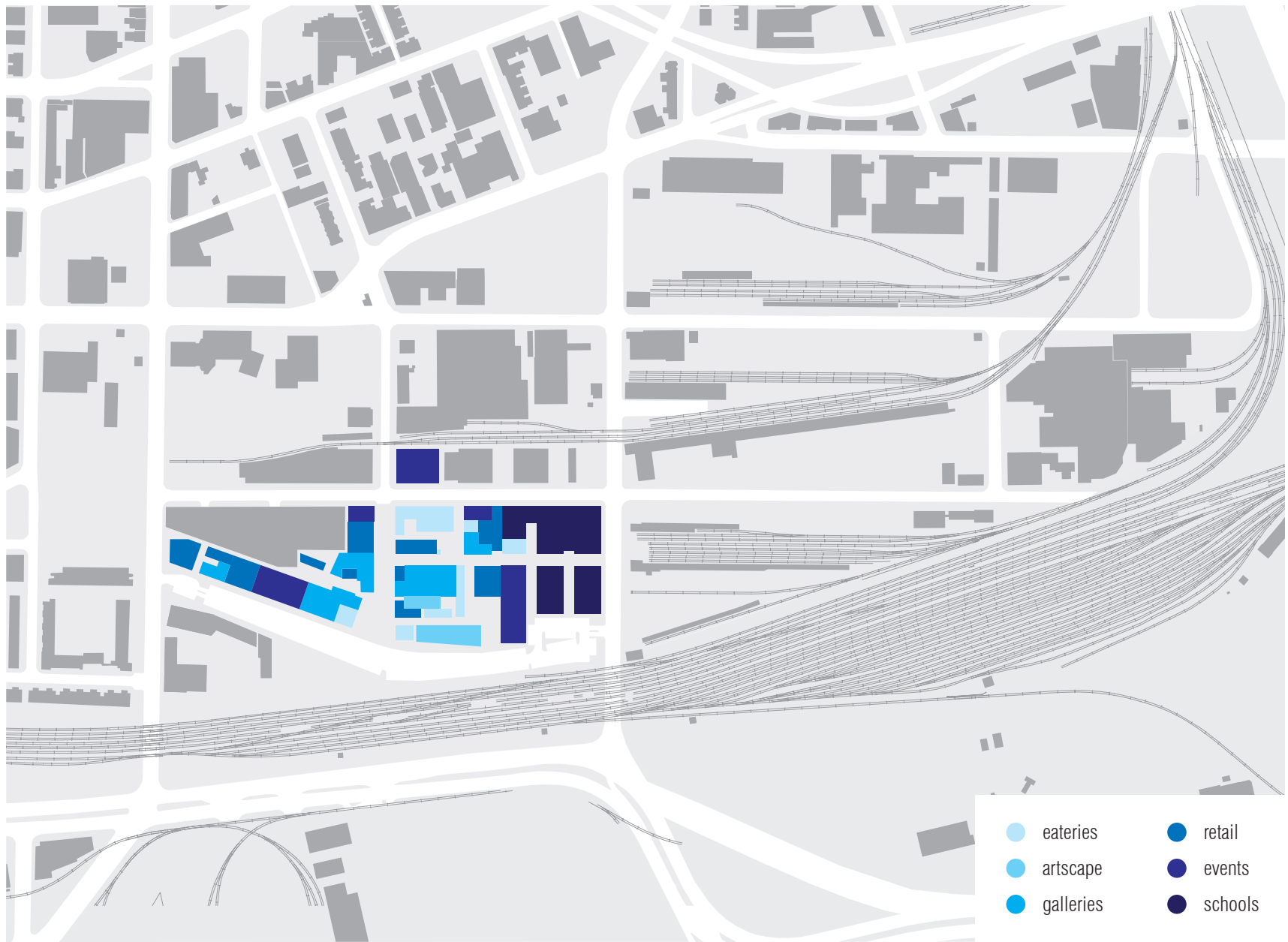

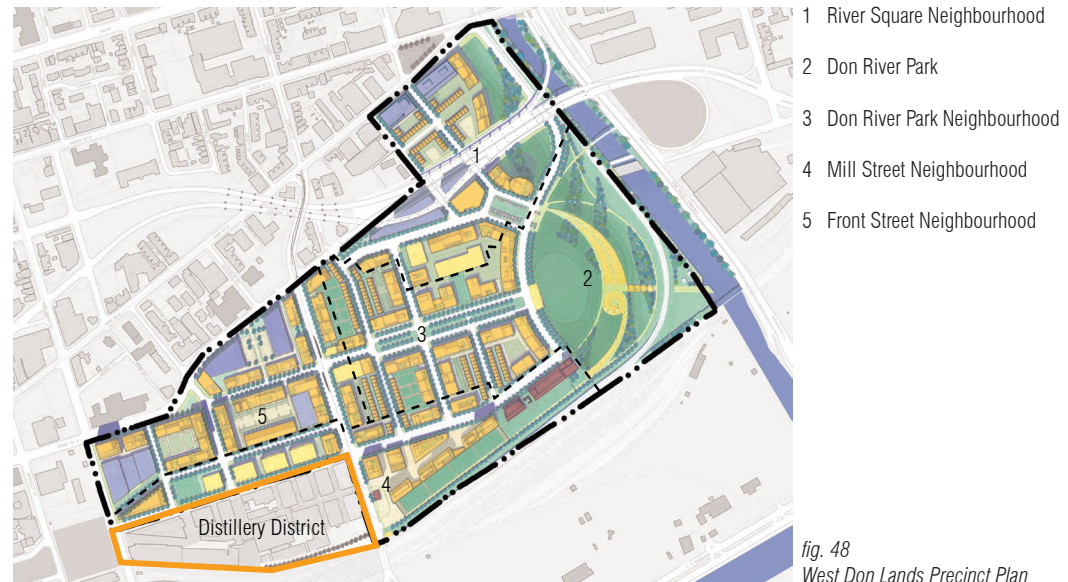

fig. 48
West Don Lands Precinct Plan

5.4 the future

Adjacent to the northern and eastern edges of the Distillery District lies the allotment of land for the prospective West Don Lands project, a vision conceived by the Toronto Waterfront Revitalization Corporation, whose sole mandate is to counter urban sprawl and encourage the growth of urban Toronto by coordinating the redevelopment of the waterfront. This redevelopment has two primary ambitions. First, it intends to link the downtown core of Toronto with the Don River Valley corridor by creating a 19.5 acre park opening into the Don River Valley, distinctly defining both the West Don Lands and the city while furnishing a strong visual connection to the downtown. Second, the project would broaden the urban centre of Toronto by extending east, revitalizing the neighbourhood and rejuvenating the north-south corridors. In addition to the extensive green space, other beneficial elements of the proposed development include the construction of 6,000 new residences (including 1,200 units of affordable rental

housing), devoting 25 per cent of the community to parks and public space (incorporating the Don River Park), and creating two childcare centres, a community centre with a pool, and an elementary school. By establishing four distinct neighbourhoods that embrace the character of the existing adjacent areas through form and typology, the West Don Lands project weaves itself seamlessly into the continuous urban fabric of the city. Slated for residential construction to commence by mid-2007, the first residential occupancy will occur by the spring of 2008.



fig. 49
Front Street Neighbourhood



fig. 50
Don River Park Neighbourhood



fig. 51
River Square Neighbourhood

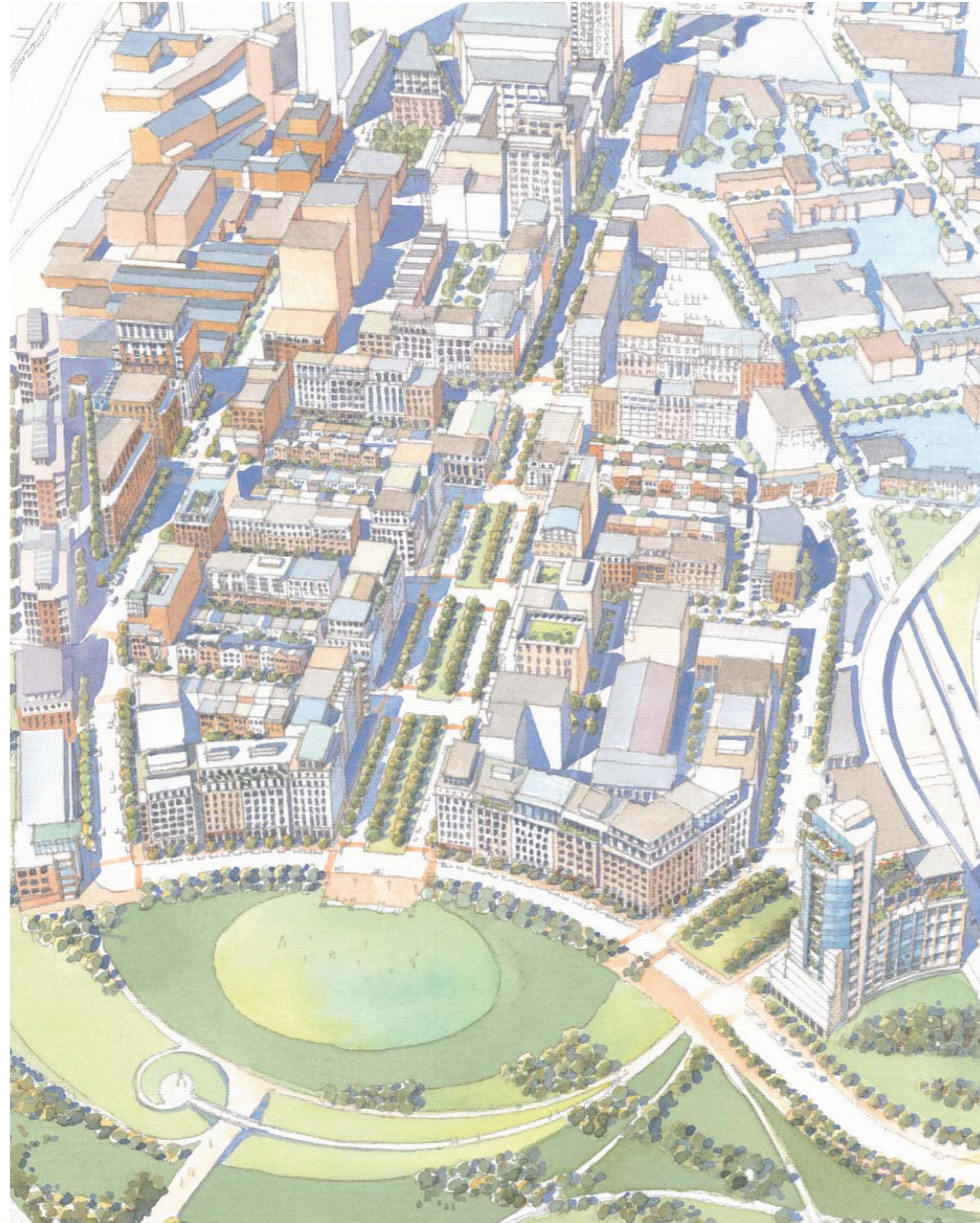

fig. 52
Aerial Perspective of West Don Lands

The imminent development of the West Don Lands project now repositions the Distillery District from the periphery of the downtown core into the centre of the city. The distillery becomes a crucial reference point and a notable landmark within the redevelopment, “providing a key link to the area’s past.”⁹ The West Don Lands project strives to reclaim the historical significance that surrounds the area by recapturing the rich, nostalgic ambience of the Victorian industrial era. To achieve this, the developers propose using methods such as applying “industrial motif of steel checker plate tree pit covers, lighting fixtures designed to match the original Distillery fixtures, retention of red brick gutters, and the creation of interpretive kiosks with an industrial character.”¹⁰ This new proposition revitalizes the derelict area by expanding Toronto’s urban core eastwards, furnishing fertile exchanges with the Distillery District and the rest of the city through the creation of urban communities.

¹ Diamond + Schmitt Architects Inc., *Gooderham and Worts / Triangle Lands Heritage Assessment*, (Toronto: City of Toronto Planning and Development Department and Toronto Historical Board, 1990), 79.

² *Ibid.*, 29.

³ Toronto Green Community and Toronto Field Naturalists, *Historic Distillery District*, <<http://www.lostrivers.ca/points/distillerydistrict.htm>> accessed on 10 October 2006.

⁴ Caulfield, Jon, “Chapter 9: The Distillery District” cited in *Urban Planning Overseas Journal 2005*, <http://www.arts.yorku.ca/sosc/urbanst/publications/Urban_Planning_Overseas_Journal_2005.pdf> accessed on 01 September 2006.

⁵ *Ibid.*, 86.

⁶ *Ibid.*, 88.

⁷ *Ibid.*, 89.

⁸ *Ibid.*, 91.

⁹ Urban Design Associates, *West Don Lands Precinct Plans*, (Toronto: Toronto Waterfront Revitalization Corporation, 2004), 12.

¹⁰ *Ibid.*, 12.



fig. 53
View of Trinity Street at Night

5.5 site analysis

- 1 Tank House Lane**

As the main east-west artery of the Distillery District, Tank House Lane is traversed by pedestrians both entering and leaving the district. Bordering the site, the interaction between this major circulation path and the proposed school will play a vital role in shaping the design.
- 2 Cherry Street**

During the early 18th century, it was the spit of land that connected the mainland to an island which later became a landfill project, now known as the Port Lands district. The fact that Cherry Street is both an entrance and exit of the city will drive and encourage the project to create a strong presence along this central thoroughfare.
- 3 Front Street**

A central circulation arm of Toronto which defined the approximate outline of Lake Ontario's shoreline during the original English settlement of York. Front Street is a main arterial closest to the site, connecting the city from east to west.
- 4 Distillery District Parking Lot**

Adjacent to the south of the site, the Distillery District parking lot could potentially be used as an experimental space to hold larger events, comparable to the parking lot of MuchMusic.
- 5 Toronto Terminals Railway**

Reminders of the site's former operation as a principal industrial hub is encompassed by the viaduct that frames the southern border of the site.
- 6 Market Lane**

Adjacent to the western edge of the site, the pedestrian pathway is utilized mainly by visitors who park their vehicles in the parking lot.
- 7 Gardiner Expressway**

A key infrastructure of Toronto, the users of the elevated Gardiner Expressway have clear visual connections with the site.
- 8 Young Centre for Performing Arts**

A collaboration between George Brown College and the Soulpepper Theatre Company, the theatre accommodates 4 indoor performance venues as well as workshop and training studios. The design proposal envisions a virtual stage shared between the two to create a dynamic, intimate relationship.
- 9 West Don Lands**

With the creation of 6000 new residences and extensive park space, the West Don Lands proposal transforms the deserted industrial wasteland into an eastward expansion of the urban centre. The redevelopment plays a critical role in repositioning the Distillery District into the heart of the city.

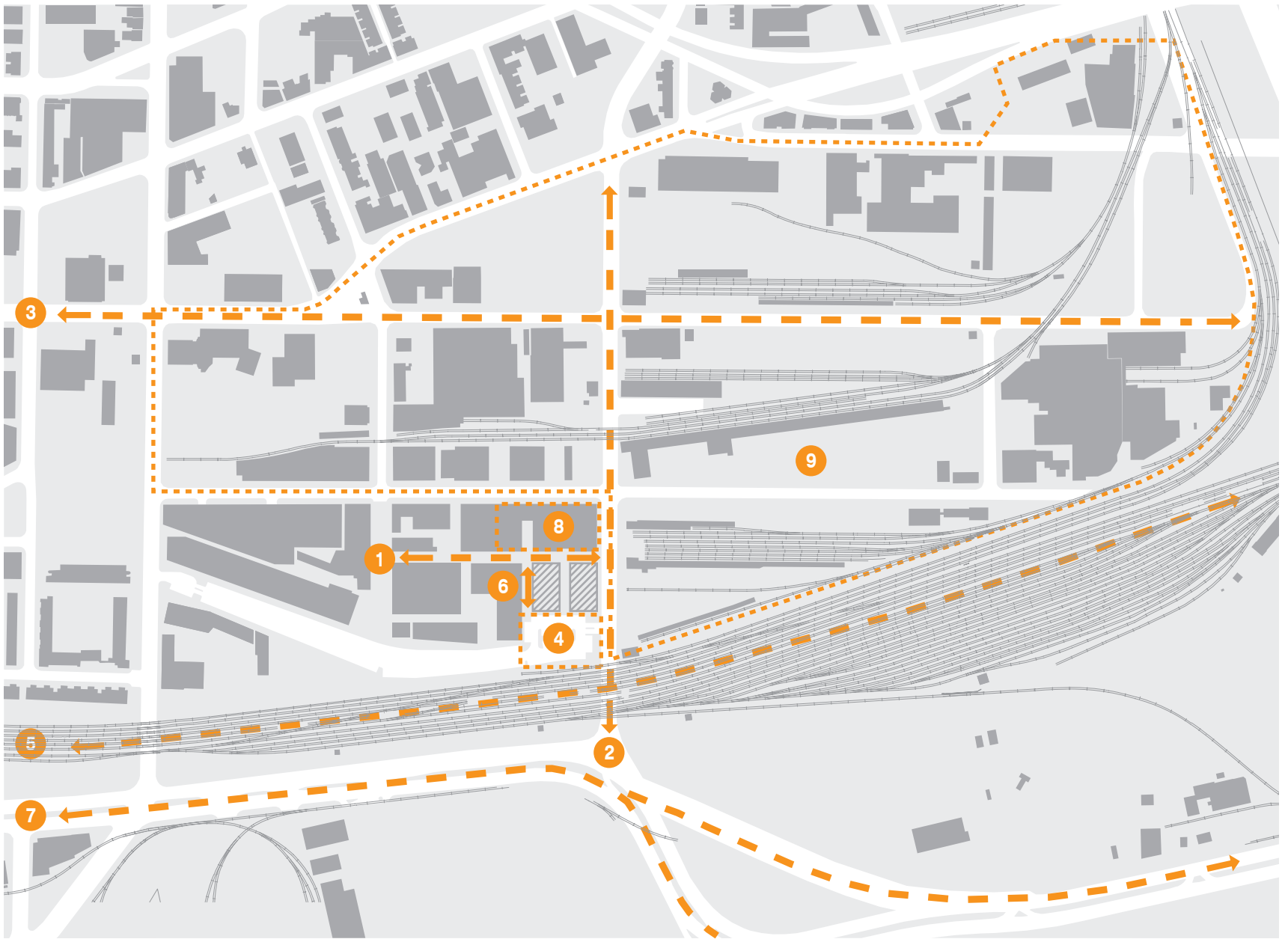

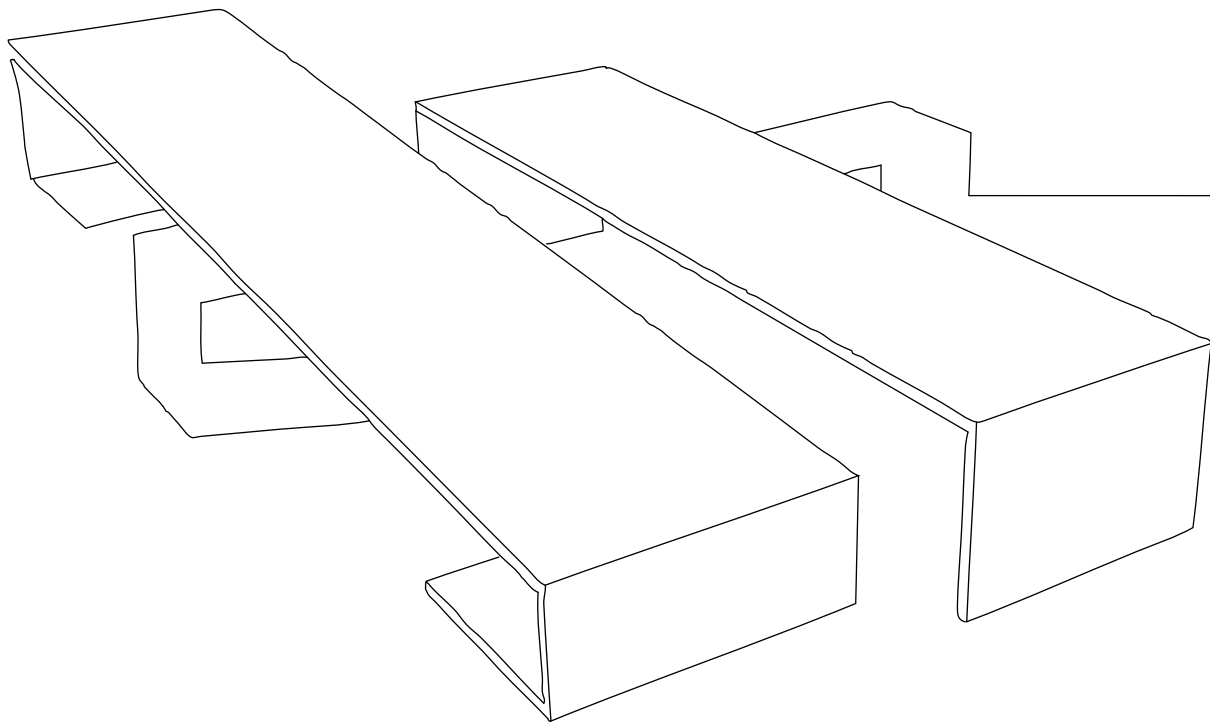

chapter
the design 06



fig. 55
Calvin Klein
2008 Resort



fig. 56
Calvin Klein
2008 Resort

6.1 design brief

No one can imagine that we should not change and adapt the existing building mass, but on the contrary, find that there are important architectural expressions in conversions, which reflect our changing times and changing uses.

- Inge Mette Kirkeby

Amid a society where shopping mall construction is prioritized over much-needed cultural facilities and where social interaction between urban condominium dwellers is lower than that of their counterparts in the sprawling suburbs¹, there is a distinct need for meaningful places that foster healthy social relationships. It is just such a meaningful place that is the aim of this thesis design. Ignasi de Sola-Morales argues that the fundamental essence of a place is tied to the production of an event, which in turn constructs spaces of collective gathering.² Culture, being a tool that brings individuals together socially by furthering our understanding of one another's

similarities and differences, has always played a vital role within the narrative of human life. This design proposal seeks to foster Toronto's cultural revival, strengthening its growing identity as a distinguished metropolis on the world stage. In its use of fashion as an offshoot of culture, the design is a synthesis of ideas embracing the interrelationship of city, event, fashion, and architecture, which cooperatively stimulate a social community.

As architecture symbolizes the values of our current civilization, the project aims to demonstrate these values within the framework we live in by confronting the old with the new, expressing itself as a modern insertion that is not intimidated by its historical counterpart. The design strives to be an example of a radical and bold intervention that captures the passerby's attention, while simultaneously respecting its existing Victorian fabric and context. Embodying a design philosophy similar to fashion designers Helmut Lang and Calvin Klein,



fig. 57
Helmut Lang
2008 Resort

both fashion houses are notoriously associated with styles that define modern sophistication, simplicity and elegance. The two designers share adoration for sharply cut suits and trousers and mutually shun the addition of frills or ruffles into the garments they produce. The proposed design attempts to mimic this polished refinement exhibited by the two designer's characteristic spare, clean shapes and austere lines, through the purity of the project's exterior folds and minimal interiors. Both mainly champion the use of achromatic colors black, white and grey with the occasional splash of neutral hues in their clothing; similarly, the palette of this design is distilled to the natural shades of the materials applied (i.e. wood, concrete, metal and the existing brick). The inspiration of simple elegance defined by Helmut Lang and Calvin Klein represents the new insertion's endeavor to compliment the refined beauty of the existing architecture.



fig. 58
Helmut Lang
2008 Resort

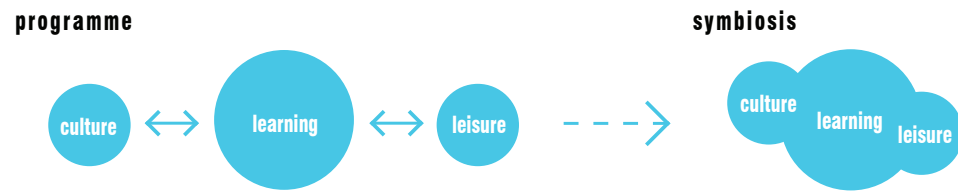

fig. 59
Programme and Symbiosis

This thesis proposes the establishment of a school of fashion design on a carefully selected site, encompassing the revitalization of the once-abandoned Distillery District through artistic, cultural, and entertainment renewal. This not only furthers the area's objectives locally, its influence extends into the development of adjacent neighbourhoods and Toronto as a whole. Transforming once-defunct industrial areas into areas of high cultural interest has been a successful tactic to revitalize neighbourhoods and cities, as the impact of Frank O. Gehry's Guggenheim Museum in Bilbao, Spain, or Herzog de Meuron's Tate Modern in London, England can clearly confirm. Despite the difference in scale with respect to the aforementioned interventions, the addition of a fashion school in the Distillery District will help to cultivate an even stronger and more meaningful cultural space, forming a lively interchange with its environment and visitors.

Before attempting to design a fashion school, the design processes of fashion were investigated so that the school facilitated the required needs of its users while simultaneously actively encouraging the development of creativity.

Striving to establish the concept of place within the design, three approaches are proposed to revitalize the space:

- (1) an intervention into existing buildings;
- (2) the relationship between new and old structures;
- (3) charging space with a performative aspect.

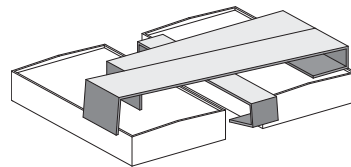
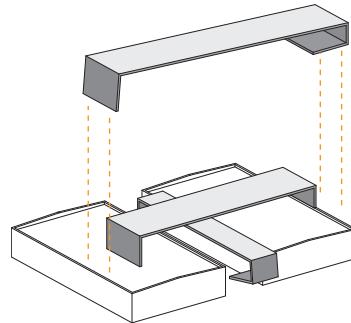
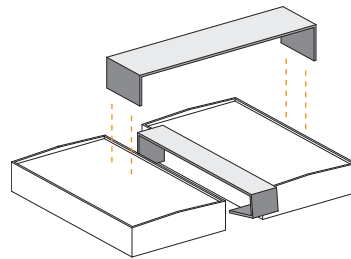
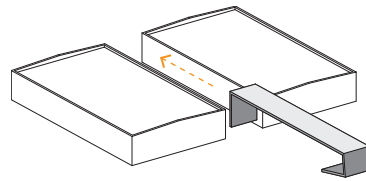

1 < intervention into existing buildings

Intervention, in architectural terms, is a procedure that stimulates either the potential or repressed meaning of an existing space. Using this method, the proposal seeks to reactivate the former storage use of the two buildings that its design appropriates. These tank houses were built in 1889, their storage capacity being required as a result of the 1883 law requiring whisky to be aged a minimum of two years before its sale. Inspired by this act of preservation, the project will quip on this historical use by engaging in the preservation and maturing of the minds of its occupants. Thus, the school of fashion design will become a communal vessel for creativity and performance, a shared repository of activity and social interaction. The sequence of events created in the central spine will be the fundamental element that ties together the public and school programme.

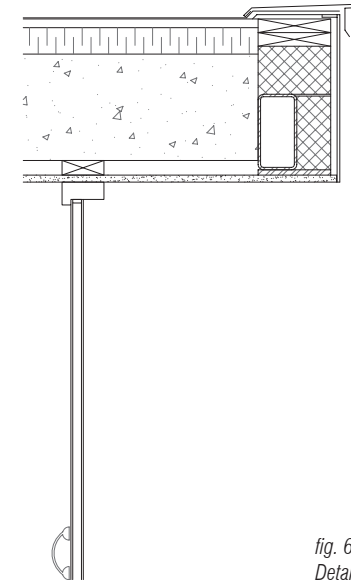

fig. 61
Detail of Roof

2 < the relationship between new and old

Respecting the historical value of the Victorian era architecture, the design will be incorporated with minimal disruption to the existing structures. The flooring of the principal event space remains the cobblestone that paves the rest of the district's exterior pedestrian pathways, creating an extension of the distillery lane into the building, and bringing an exterior feeling to the interior. The design seeks to integrate the new — as suggested by the use of two large architectural folds — with the old: two isolated containers. Architecturally, a fold is an expression of form that gathers spaces while simultaneously delineating them. The folds in this design represent the assembly of programmatic elements that relate to the school. A conscious juxtaposition between the new and the old is represented by both form and materiality. The distinction between the lightness and delicacy of the new structure composed of glass and

zinc hovering above the pre-existing heavy brick masses below, creates an intense dialogue between the original structure and its modern counterpart.

The new insertion encompasses the notion of ornamentation through its distinct exterior folds which acts like an outer layer that envelops the old. This material reads like skin that exudes pure surface with a great amount of attention taken into constructing its clean joints. The precise and distinct lines that form this second membrane aspire to define the elegance and aesthetic pleasure Vitruvius describes with the term *venusta* (beauty), the third element that he outlines as central to good architectural design practices.

3 < charging space with performative aspect

As previously mentioned in Chapter 2, performance — ranging from the attire one chooses to put on and display for the rest of the public to the highly spectacular fashion show — is an integral aspect of fashion. Moreover, it is a core facet of the cultural phenomenon. Thus, fashion and its performance is used to drive the programme of the design, charging the space with performative aspects.

Performance is a socially engaging activity involving the presence of both spectators and actors, who all naturally become participants of a collective interaction. It is this dynamic effect, then, that is utilized as the main instrument to stimulate the design project's spaces. The proposal engages performance on three descending scales, trickling from the greater urban context to the immediate theatrical performances, and finally down to the less formal and individual moments within the building.

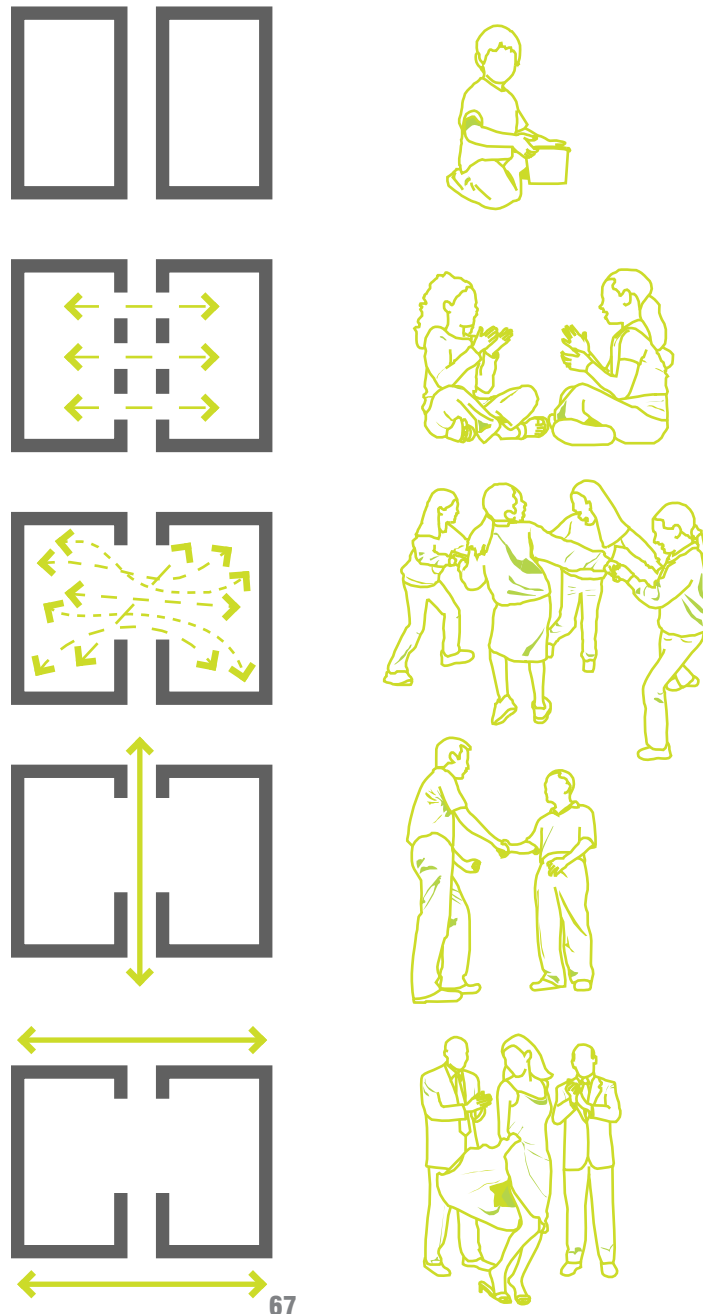
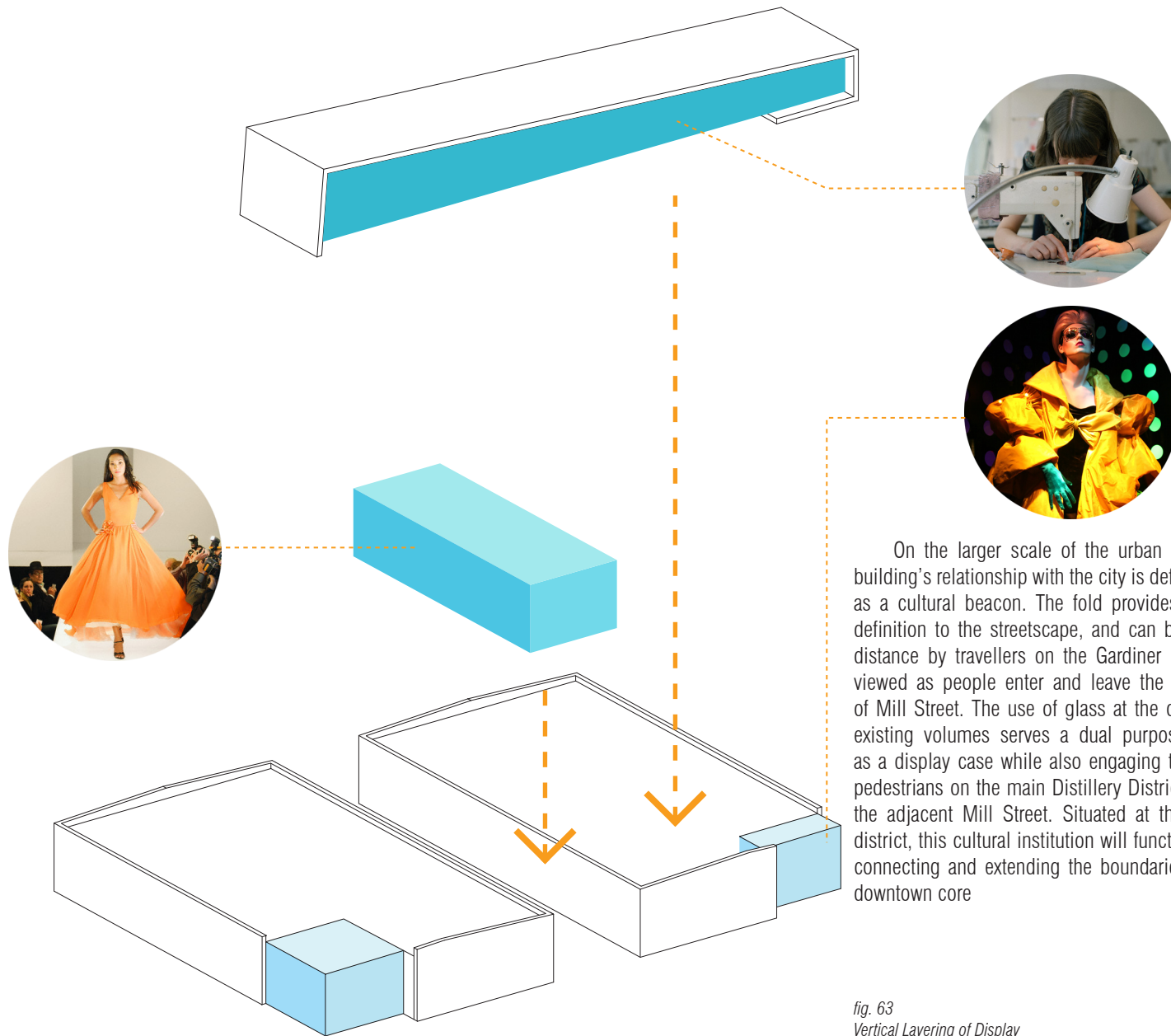

fig. 62
Social Encounters



On the larger scale of the urban landscape, the building's relationship with the city is defined by its role as a cultural beacon. The fold provides an important definition to the streetscape, and can be seen from a distance by travellers on the Gardiner Expressway, or viewed as people enter and leave the city by means of Mill Street. The use of glass at the corners of both existing volumes serves a dual purpose, functioning as a display case while also engaging the attention of pedestrians on the main Distillery District pathway and the adjacent Mill Street. Situated at the edge of the district, this cultural institution will function as a hinge, connecting and extending the boundaries of Toronto's downtown core

fig. 63
Vertical Layering of Display

To establish both a spatial and visual connection between the two existing detached masses, a large opening is cut through each volume's brick walls, yielding a higher probability of social encounters and relationships. To further link the segregated spaces, the interstitial alleyway between the two buildings will become both the main lobby and the principal

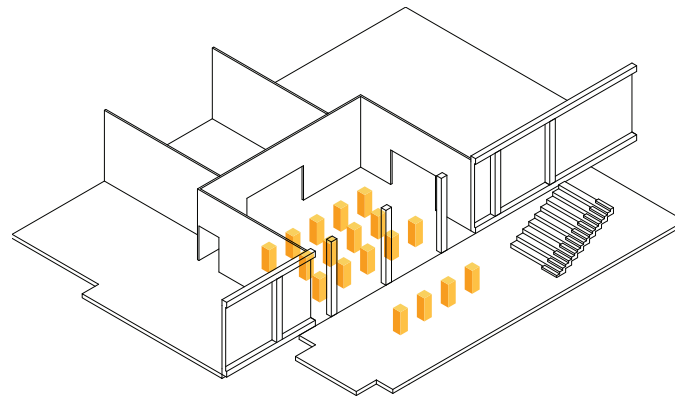

exhibition use

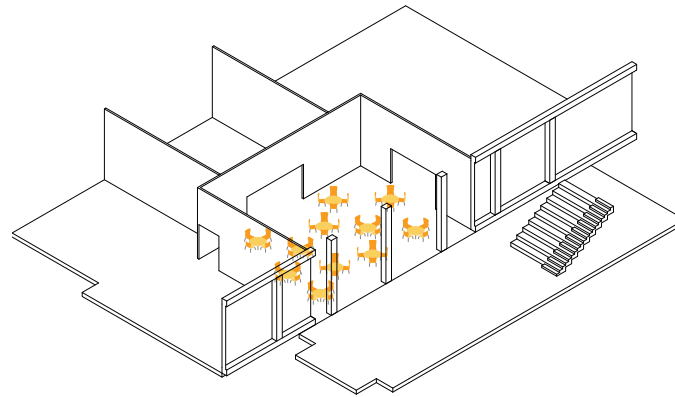

cafe / restaurant use

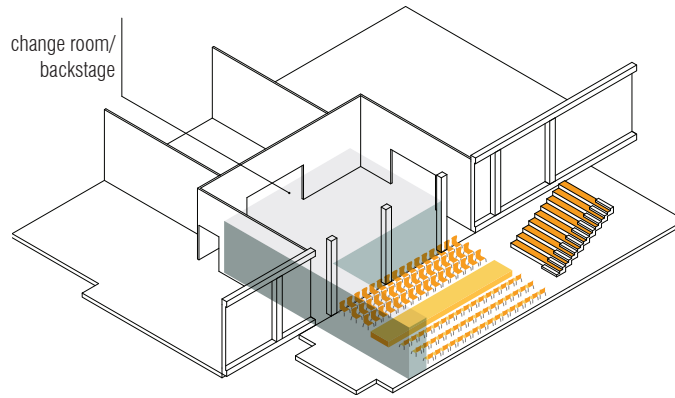

event use

fig. 64
Various Uses of the Multi-Purpose Space

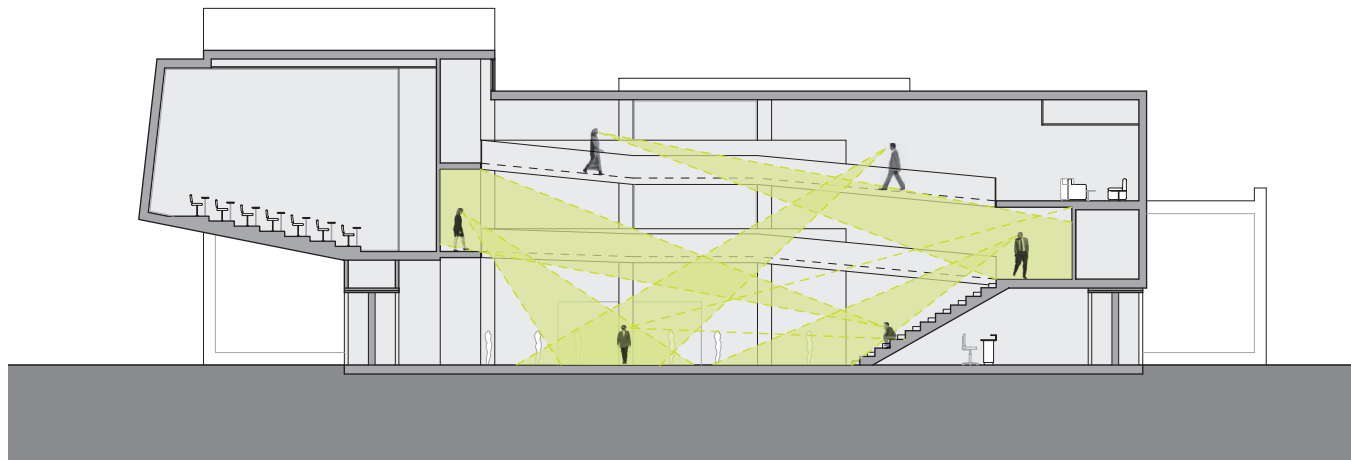

fig. 65
Spectacle and Spectator

event arterial, as it contains a space large enough to accommodate fashion shows, with the central stairs functioning as spectator seating.

To encourage dynamic energy in the main distillery lane, the performance spaces are also layered vertically. The ground level design of the building includes the main runway connecting the two volumes, which is then layered by the spectacle of objects in the display cases, and the exhibition of students working in the studios on the uppermost level.

Spaces are designed to encourage versatility and randomness in activity, countering the rectilinear and symmetrical spatial arrangement in plan. The school of fashion design will have a number of versatile uses, ranging from everyday school functions to spaces for gala performances.

On a more intimate scale, less formal and unique individual events are performed throughout the building, from patrons enjoying a beverage at the bar, to the act of circulating vertically through the lobby space on the central stairs. Blurring the lines between spectator and spectacle, the catwalks above the principal performance space allow users to view the event from above, or to be watched by the audience from below. These smaller events are a reflection of the individual spectacles that are enacted in the daily routine of people's lives.

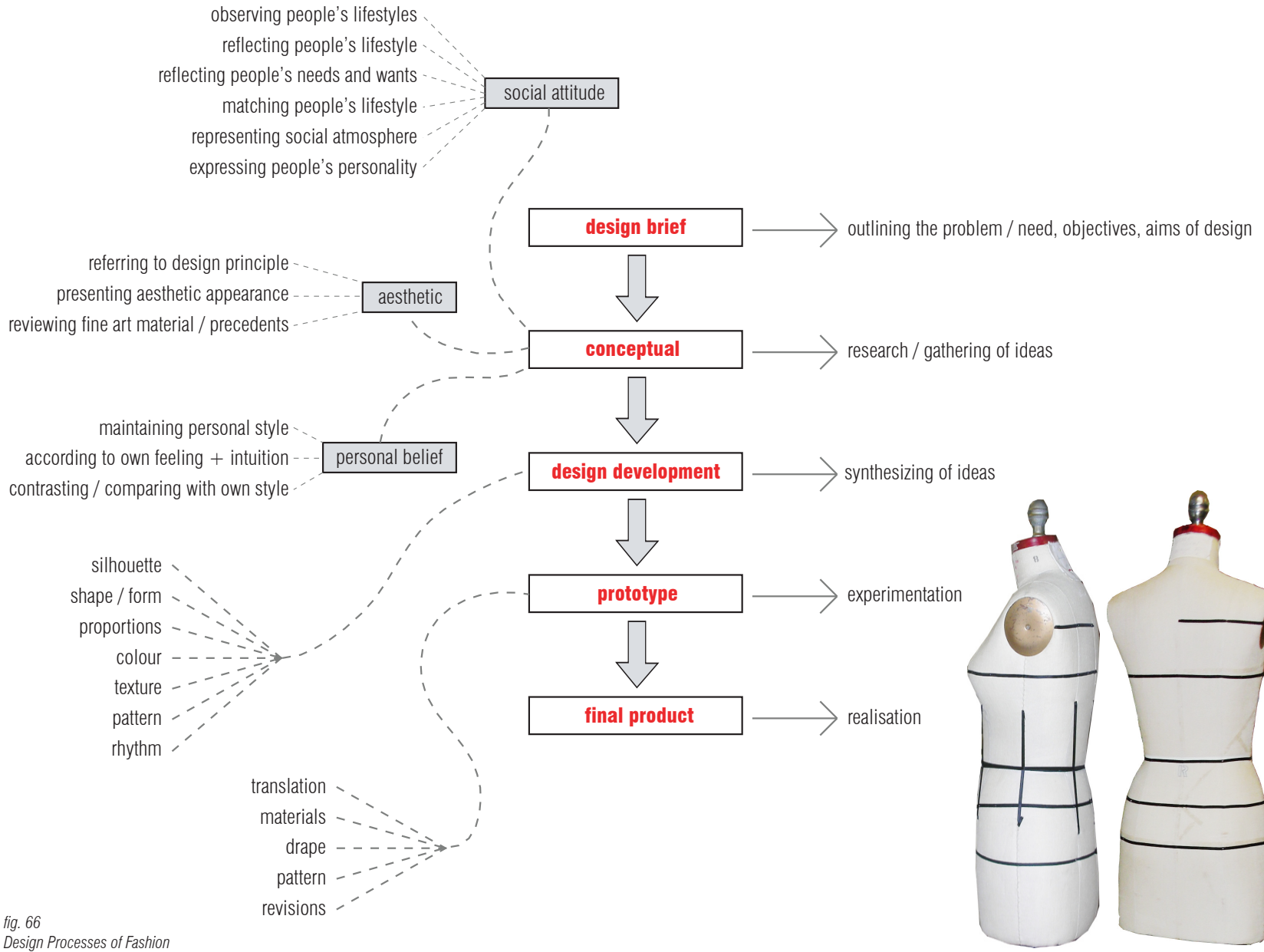
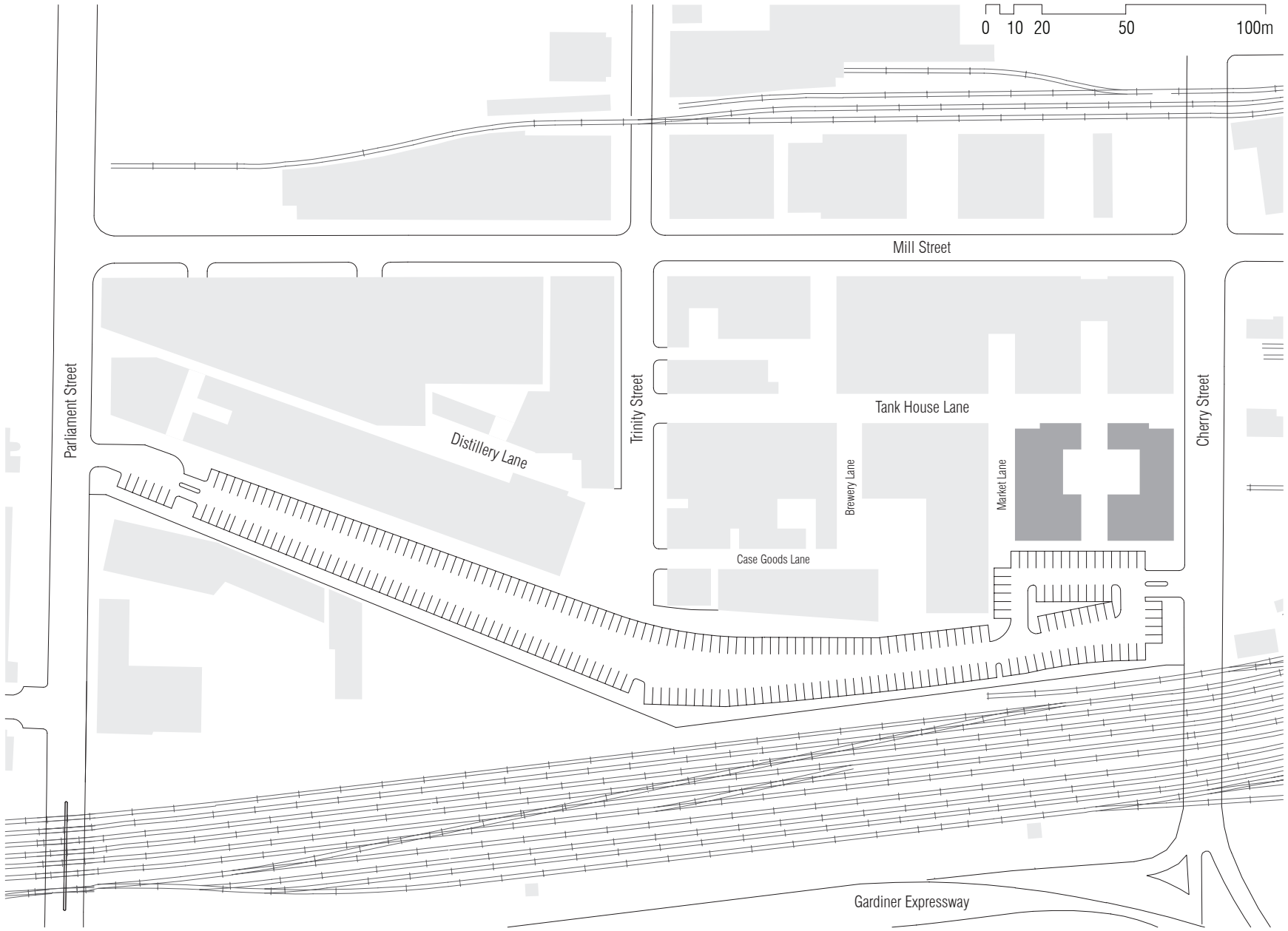
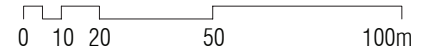
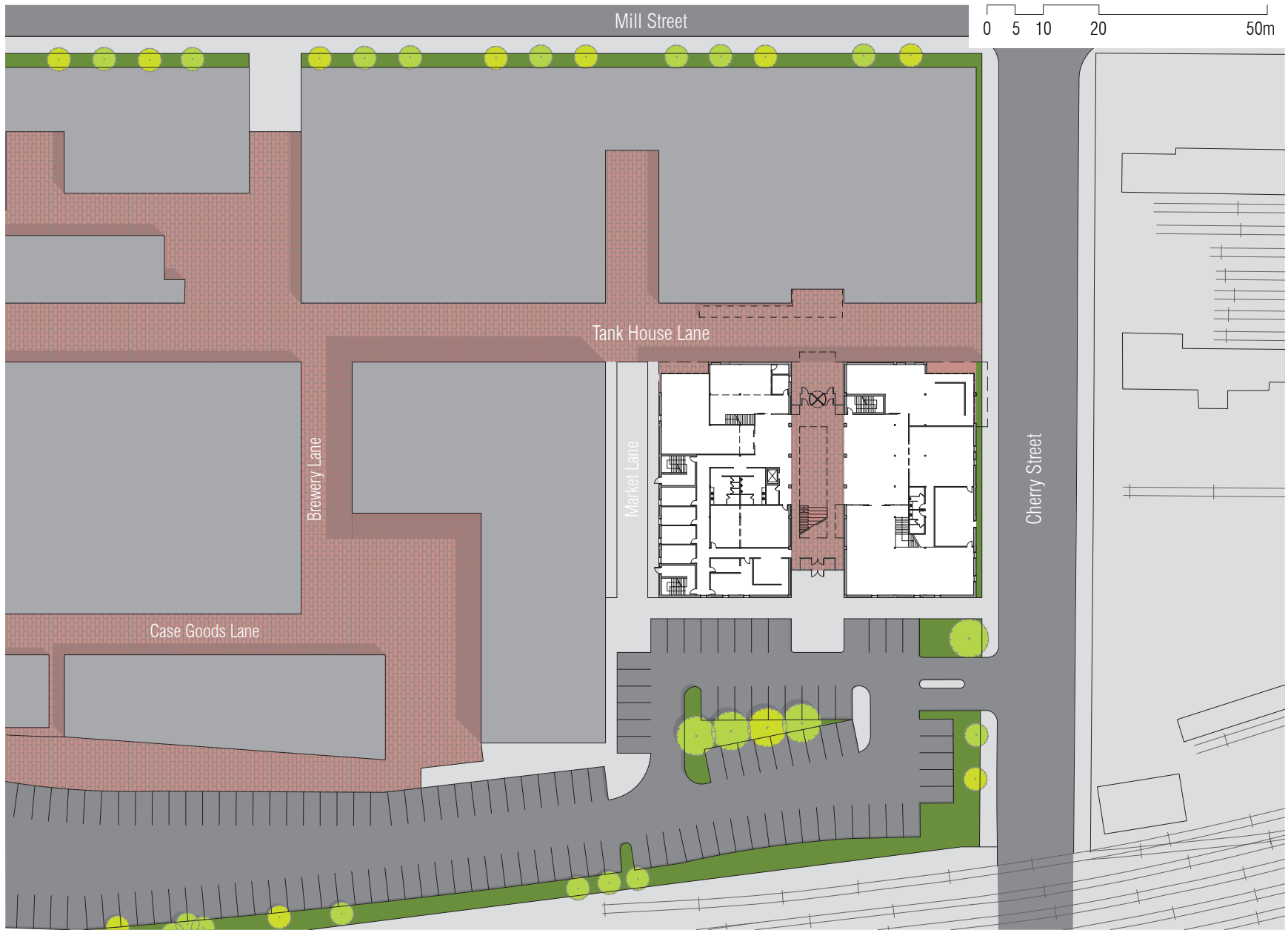

fig. 66
Design Processes of Fashion

6.2 drawings





gallery	1
storefront display	2
cafe	3
kitchen	4
restaurant	5
unprogrammed public space	6
lobby	7
mechanical room	8
multi-purpose room	9
meeting room	10
administration	11
staff kitchen	12
administration office	13
office	14
retail	15
retail display	16
library	17
librarian's office	18

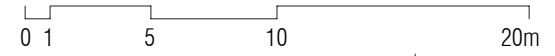

existing new

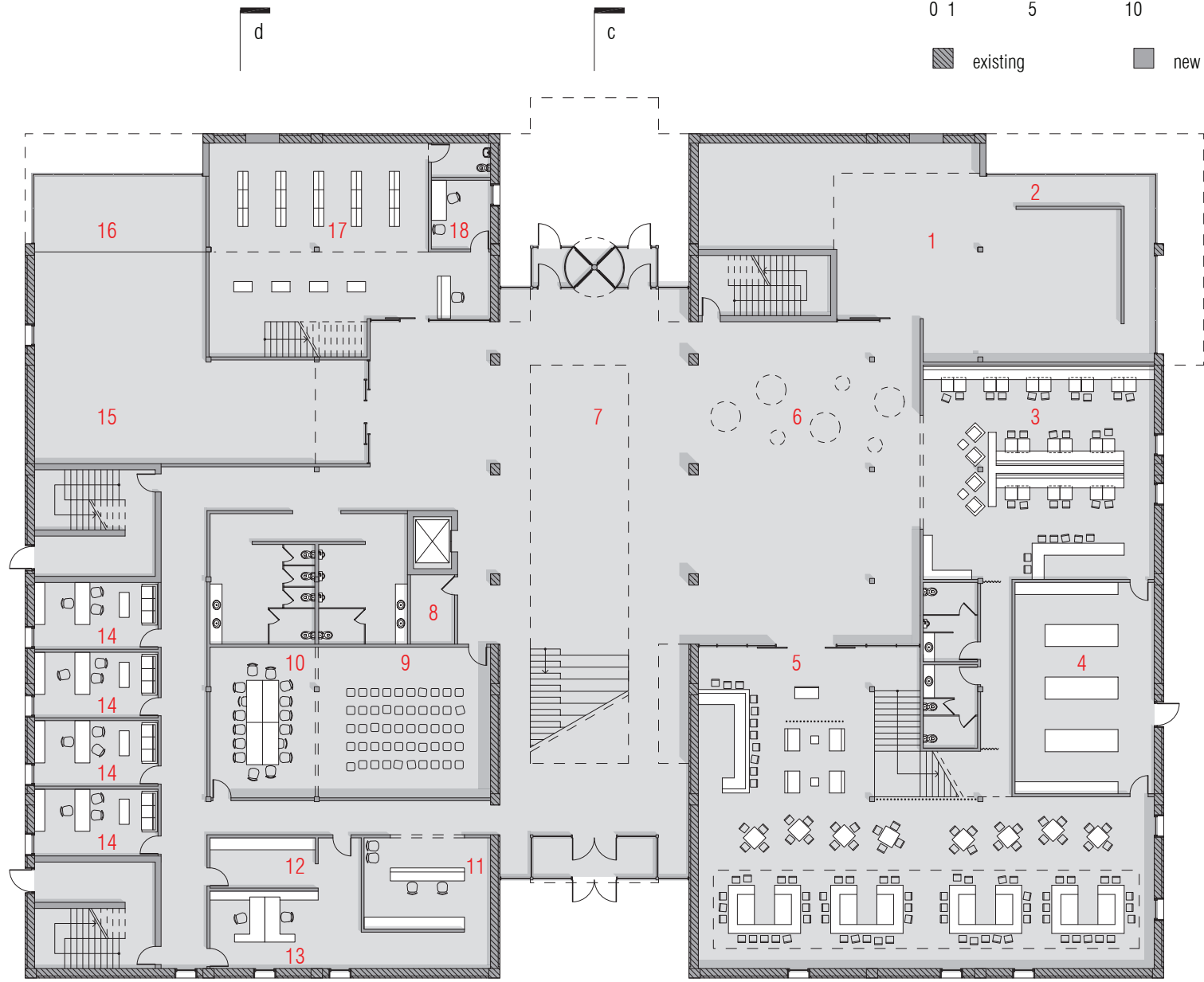

77

ground floor (+0.0 m)

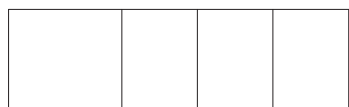
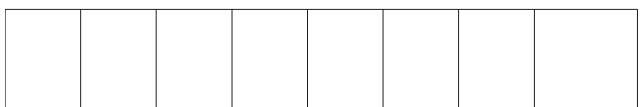

sewing area	1
construction room	2
restaurant	3
av room	4
computer lab	5
office	6
library	7
lecture hall	8
mechanical room	9

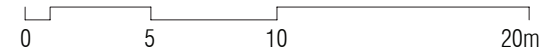

existing new

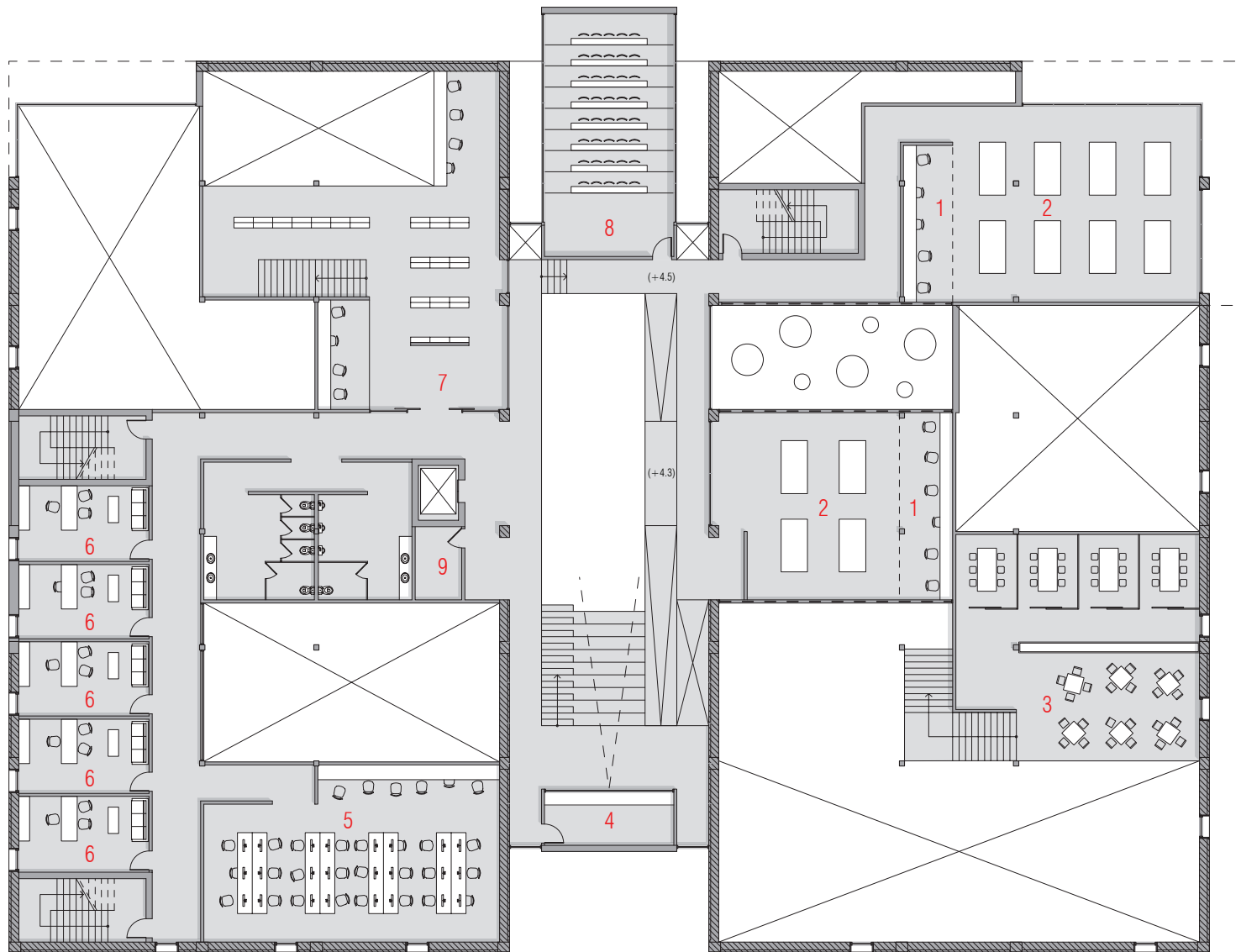

studio	1
lounge	2
mechanical room	3
multi-purpose room	4
roof terrace	5

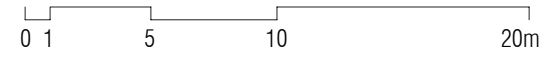

 existing  new

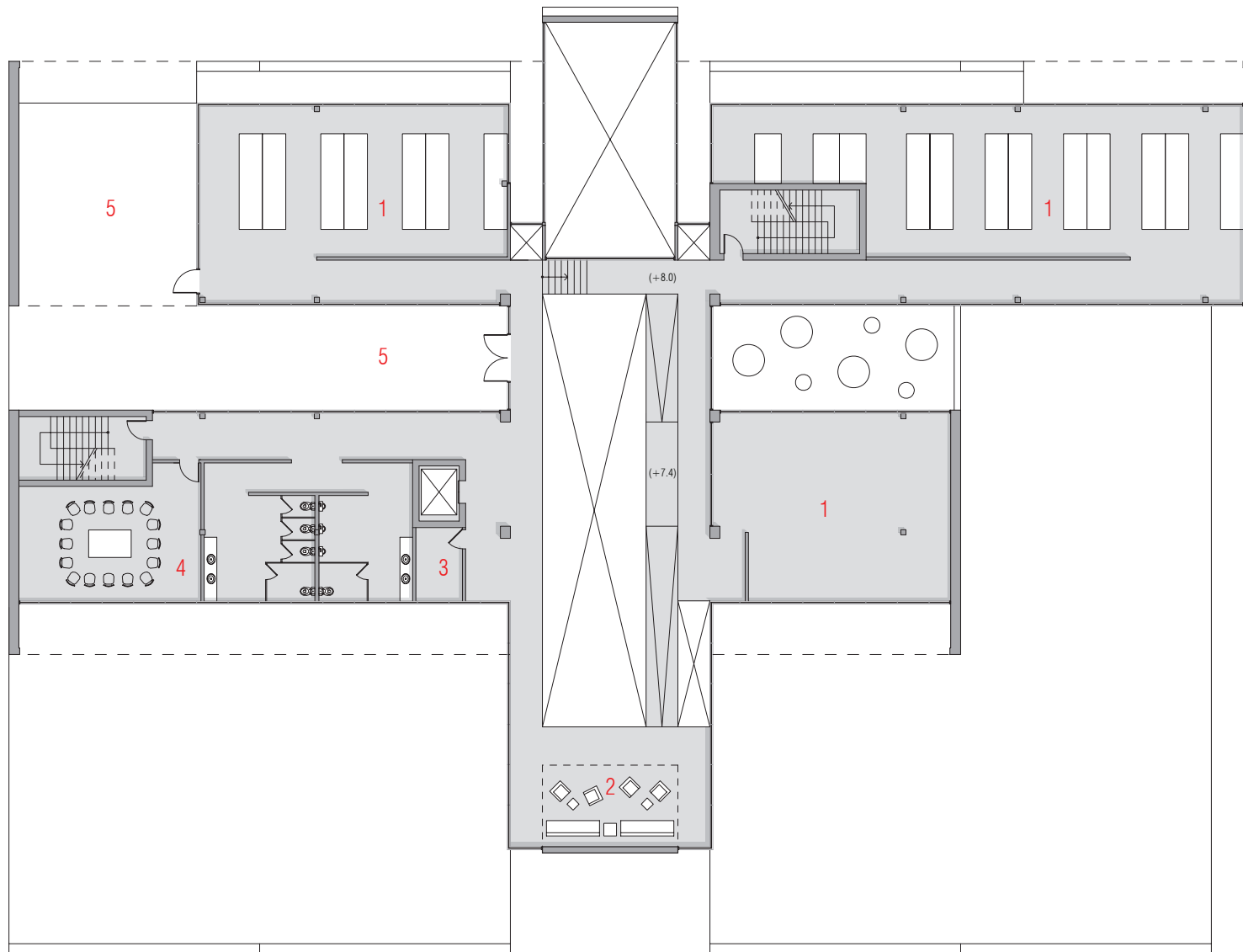

81

3rd floor (+6.5 m)

retail	1
library	2
lounge	3
lobby	4
unprogrammed public space	5
cafe	6

studio	7
construction room	8
gallery	9
lecture hall	10
library	11
roof terrace	12
retail	13

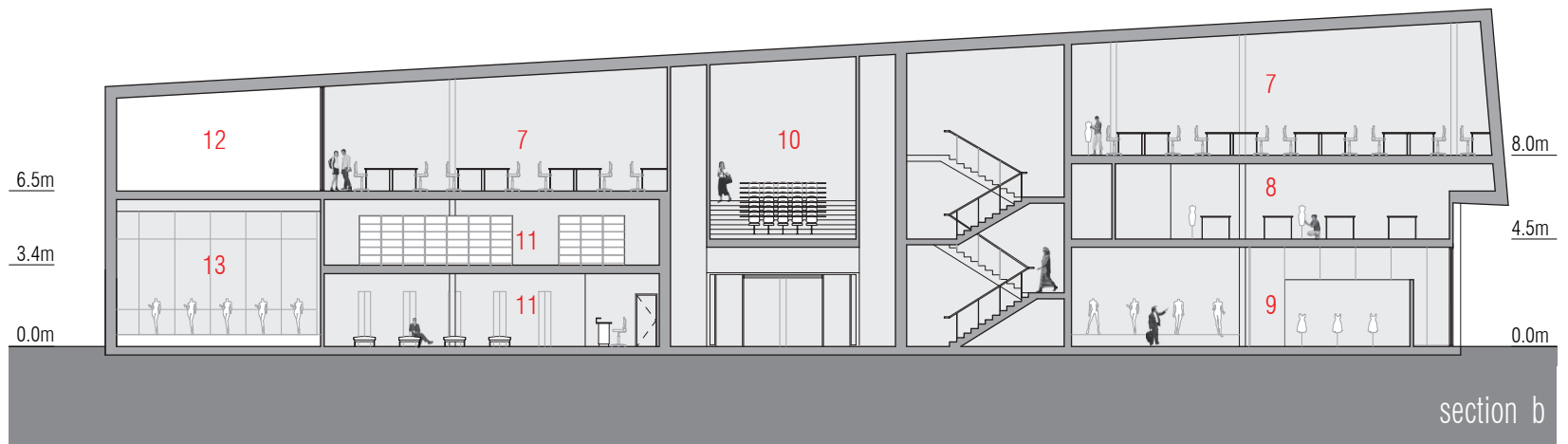
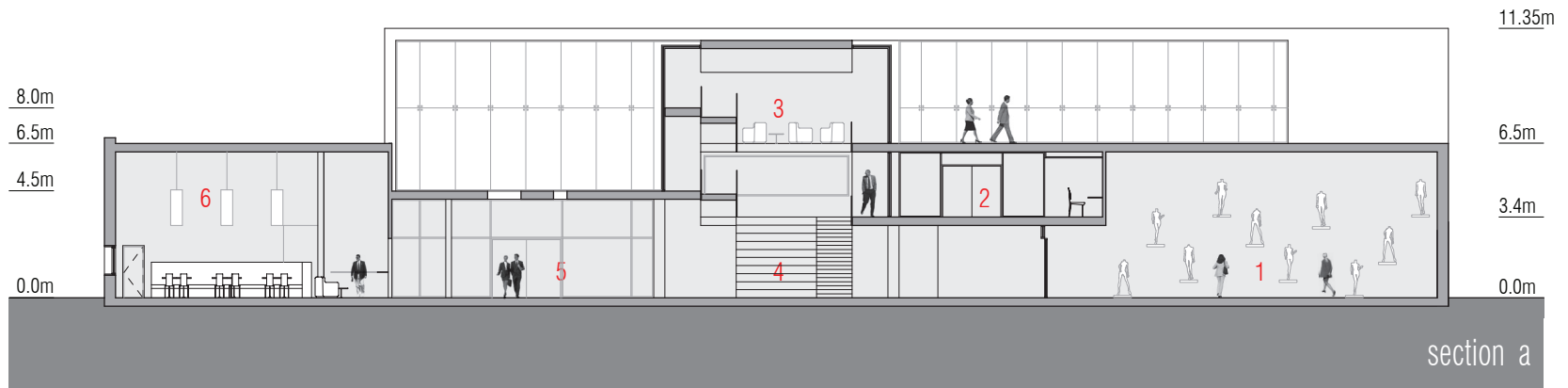
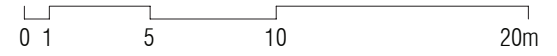

info desk 1
av room 2
lounge 3
lobby 4
lecture hall 5

administration office 6
staff kitchen 7
computer room 8
meeting room 9
retail 10
library 11
studio 12

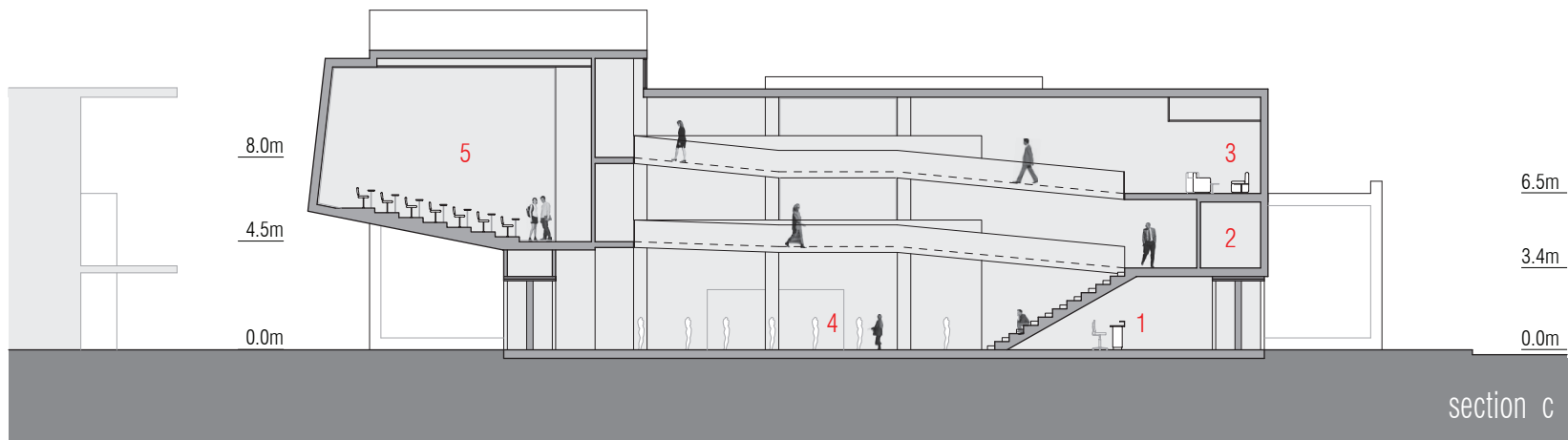
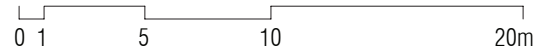

section c



section d

fig. 67
View of Existing Building From Tank House Lane



fig. 68
View of Proposed Insertion From Tank House Lane



fig. 69
View of Existing Building Exiting City Via Cherry Street

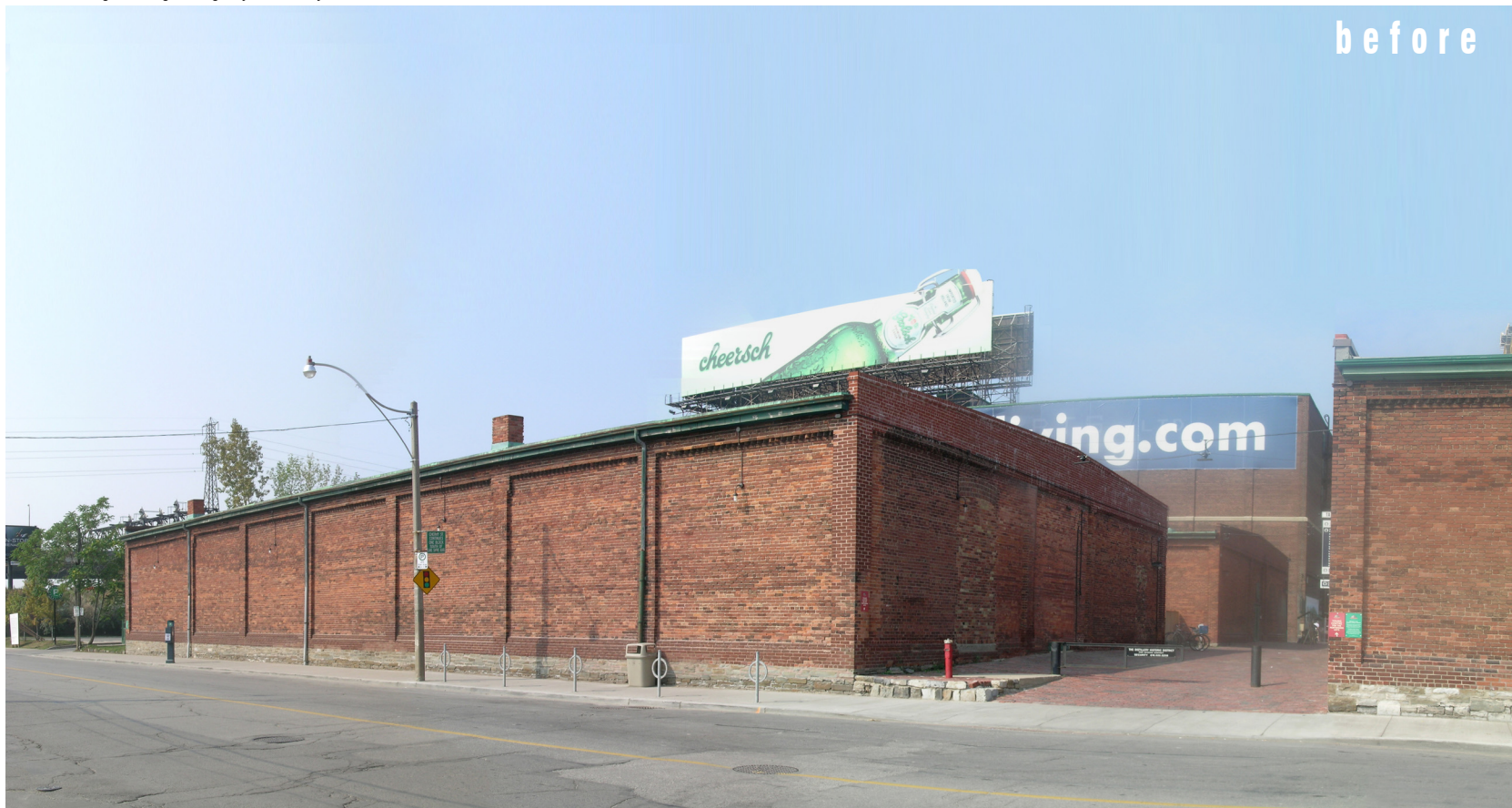

before

fig. 70
View of Proposed Insertion Exiting City Via Cherry Street



fig. 71
View of Existing Building Entering City Via Cherry Street



fig. 72
View of Proposed Insertion Entering City via Cherry Street



fig. 73
View of Existing Building From Gardiner Expressway at Night



fig. 74
View of Proposed Insertion From Gardiner Expressway at Night

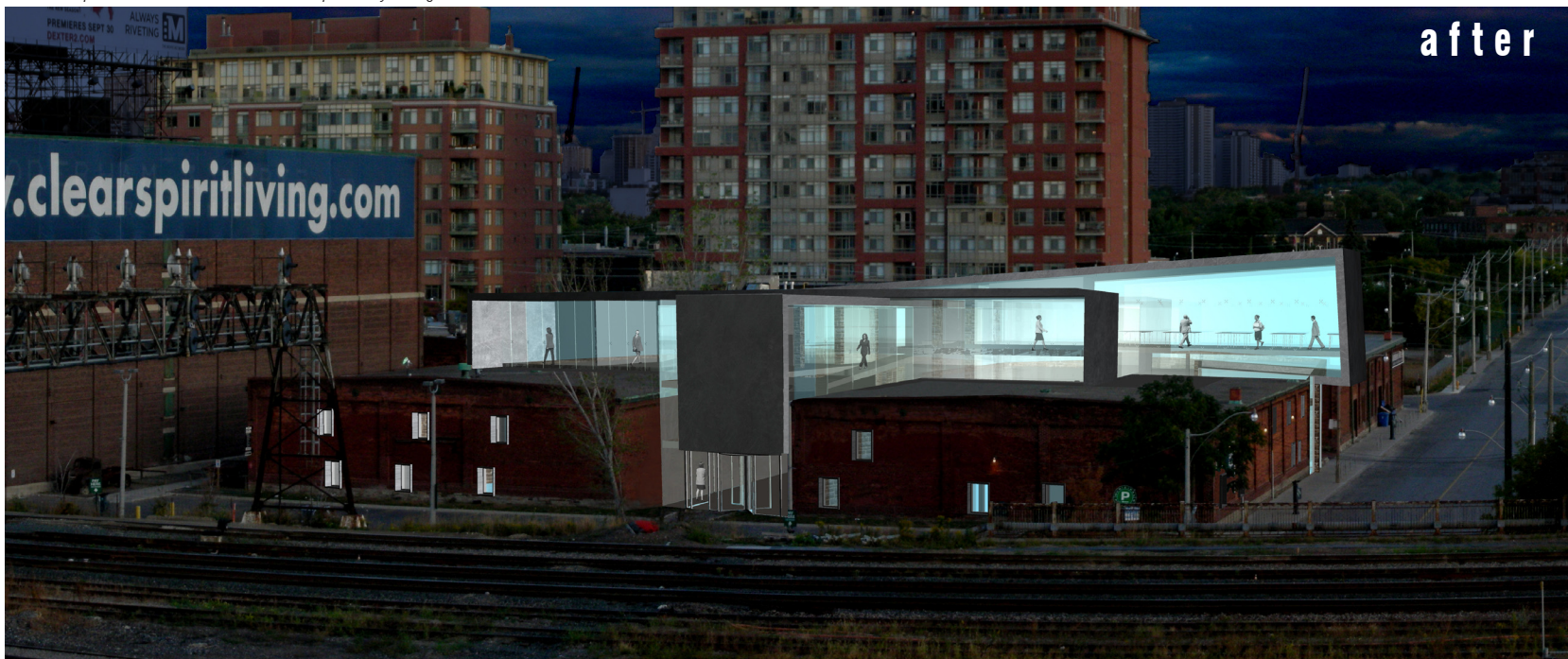

fig. 75
View of Main Lobby

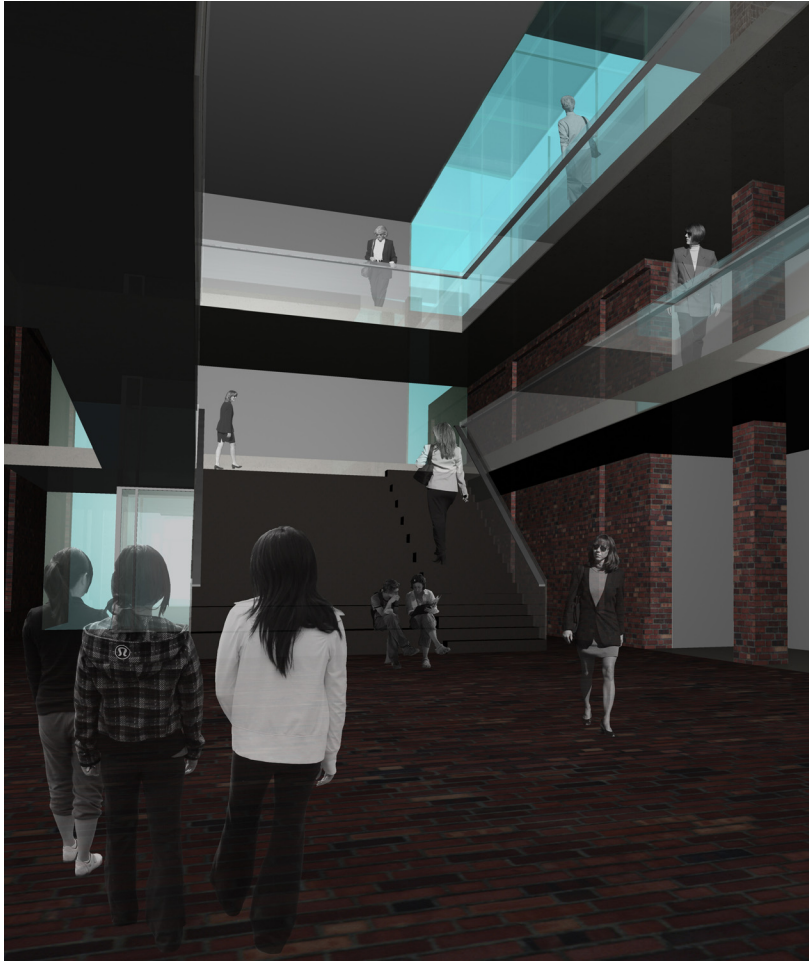

fig. 76
View of Main Lobby Hosting a Fashion Show



fig. 77
View of Multi-Purpose Space Functioning as Cafe/Restaurant Use



fig. 78
View of Ramps in Main Lobby Space

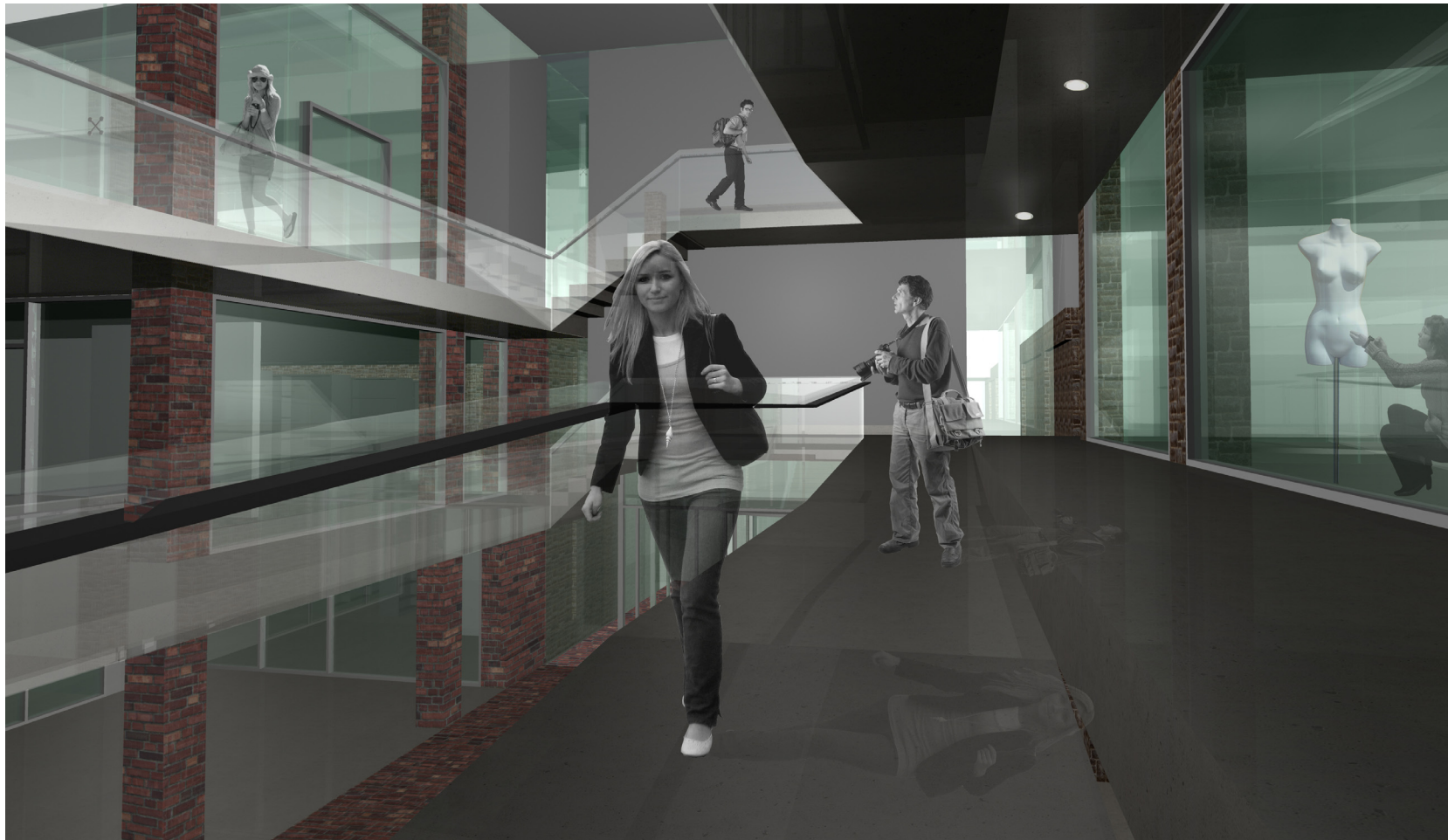

fig. 79
View of Gallery Space





chapter
conclusion 07

This . . . 'stuff'? Oh . . . ok. I see, you think this has nothing to do with you. You go to your closet and you select out, oh I don't know, that lumpy blue sweater, for instance, because you're trying to tell the world that you take yourself too seriously to care about what you put on your back. But what you don't know is that that sweater is not just blue, it's not turquoise, it's not lapis, it's actually cerulean. You're also blithely unaware of the fact that in 2002, Oscar De La Renta did a collection of cerulean gowns. And then I think it was Yves St Laurent, wasn't it, who showed cerulean military jackets? And then cerulean quickly showed up in the collections of 8 different designers. Then it filtered down through the department stores and then trickled on down into some tragic casual corner where you, no doubt, fished it out of some clearance

bin. However, that blue represents millions of dollars and countless jobs and so it's sort of comical how you think that you've made a choice that exempts you from the fashion industry when, in fact, you're wearing the sweater that was selected for you by the people in this room. From a pile of stuff.

Meryl Streep as
Miranda Priestly

Profoundly asserted by Miranda Priestly, a (fictional) demanding fashion editor in the movie, *The Devil Wears Prada*, fashion prevails as a cultural phenomenon at the heart of our existence whether we are consciously aware of it or not. While the clothing style or garment with which an individual chooses to adorn themselves may not be of interest to every single person, it nonetheless holds a significance that is familiar to people of all walks of life, deeply embedded as it is in the art,

design, consumerism, mass media, and communication produced in our contemporary culture. Charged with this very significance, this thesis embodies the themes linked to fashion and its association with architecture, culminating in the design of a fashion school.

Indeed, this thesis strives to define the intimate relationship that architecture has with its surrounding urban fabric. The proposal's situation within the historical precinct serves as a hinge unifying the downtown core and its developing eastern counterpart, gradually leading the expansion of the city's urban centre. Further, it consolidates the Distillery District's revitalization objectives by establishing a prominent cultural landmark within a city in the midst of shaping its identity. The design proposition activates the potential for expansion and development of the city's eastern downtown region, fostering gateways to future precincts in both the south (Port Lands) and east (West Down Lands) of the city.

As Toronto — Canada's largest and fastest growing metropolis — continues to evolve, the proposition will cultivate a unique character in the newly revitalized area, providing a local stage upon which the surrounding community plays out their daily lives. A meaningful connection is established between the individual and the place through the events and social relations experienced within the space. Architecture thus plays a fundamental role in constructing this vital relationship between humans and their built environment. Like a patch woven into a quilt, the proposition is a vibrant cultural addition, extending into its surrounding urban context, and drawing people into what was once a derelict industrial area. Through the engagement with and use of its facilities, it becomes a forum of artistic endeavours and a hub of social interaction for both its immediate and broader communities. The Distillery District affirms its presence as a distinct node within the city, concurrently functioning as a visual marker that

greet those who enter and leave the city via Mill Street. The design redefines Toronto's eastern streetscape, animating the public realm and further nourishing the city's lively and diverse culture.

As our technologically advanced world continues to flourish, the meaning in the spaces of our corporeal world is often overlooked and its value is diminished. In an effort to re-establish that value, this thesis attempts to reawaken a place within the city of Toronto through the cultivation of its significance, using architecture's relationship with fashion and its inherent constituents. The fashion school's situation within the Distillery District provides an outlet for creativity while simultaneously expanding the culture of fashion. The insertion is a form of affirmation for the distinct identity of the area, as well as a summation of architecture as an instance of fashion.



fig. 80
"The Devil Wears Prada" movie

bibliography

- Auge, Marc. *Non-Places: Introduction to an Anthropology of Supermodernity*. London: Verso, 1995.
- Benstock, Shari and Suzanne Ferriss. *On Fashion*. New Brunswick: Rutgers University Press, 1994.
- Beward, Christopher. *Fashion*. Oxford: Oxford University Press, 2003.
- Brook, Peter. *The Empty Space*. London: Penguin Books, 1972.
- Brooker, Graeme and Sally Stone. *Rereadings: Interior Architecture and the Design Principles of Remodelling Existing Buildings*. London: RIBA Enterprises, 2004.
- Carlson, Marvin. *Places of Performance: The Semiotics of Theatre Architecture*. Ithaca: Cornell University Press, 1989.
- Castle Helen. "Catwalk Architecture: An Interview with Sally Mackereth" cited in *Architectural Design*, v.70, no. 6, Dec. 2000.
- Cresswell. *Place: A Short Introduction*. Oxford: Blackwell Publishing, 2004.
- Chung, Chuihua Jody, Jeffrey Inaba, Rem Koolhaas, and Sze Tsung Leong. *Harvard Design School Guide to Shopping*. Koln: Taschen, 2001
- Condee, William Faricy. *Theatrical Space: A Guide for Directors and Designers*. Lanham: Scarecrow Press, 1995.
- Davis, Fred. *Fashion, Culture and Identity*. Chicago: The University of Chicago Press, 1992.
- Debord, Guy. *The Society of the Spectacle*. New York: Zone Books, 1997
- Diamond + Schmitt Architects Inc. *Gooderham and Worts / Triangle Lands Heritage Assessment*. Toronto: City of Toronto Planning and Development Department and Toronto Historical Board, 1990.
- Dovey, Kim and Scott Dickson. "Architecture and Freedom? Programmatic Innovation in the Work of Koolhaas/OMA" cited in *Journal of Architectural Education*, vol. 56, no. 1, Sept. 2002.
- Evans, Caroline. *Fashion at the Edge*. New Haven: Yale University Press, 2003.
- Fausch, Deborah, Paulette Singley, Rodolphe El-Khoury, Zvi Efrat. *Architecture in Fashion*. New York: Princeton Architectural Press, 1994.
- Foster, Hal. *Recodings: Art, Spectacle, Cultural Politics*. Seattle: Bay Press, 1985.

- Harvey, David. *The Condition of Postmodernity*. Massachusetts: Blackwell Publishers, 1990.
- Hillier, Bill and Julienne Hanson. *The Social Logic of Space*. Cambridge: Cambridge University Press, 1988.
- Hodge, Brooke. *Skin + Bones: Parallel Practices in Fashion and Architecture*. New York City: Thames & Hudson, 2006.
- Holl Steven, Juhani Pallasmaa, and Alberto Perez-Gomez. *Questions of Perception: Phenomenology of Architecture*. Tokyo: a + u Publishing Co., 1994.
- Ibelings, Hans. *Supermodernism: Architecture in the Age of Globalization*. Rotterdam: NAI Publishers, 2002.
- Loos, Aldo. *Spoken Into the Void: Collected Essays 1897-1900*. Cambridge: MIT Press, 1982.
- Malpas J. E. *Place and Experience: A Philosophical Topography*. Cambridge: Cambridge University Press, 1999.
- Martino, Carlo. "Decorative Variations" cited in *Industrial Design: Ornament & Design 23/06*.
- McAuley, Gay. *Space in Performance: Making the Meaning in Theatre*. Michigan: University of Michigan, 1999.
- McBride, Patrizia C. *In Praise of the Present: Adolf Loos on Style and Fashion*. Baltimore: The John Hopkins University Press, 2004.
- Miles, Steven. *Consumerism as a Way of Life*. London: Sage Publications, 1998.
- Pallasmaa, Juhani. *The Eyes of the Skin*. London: Academy Group Ltd., 1996.
- Paris, Tonino. "Ornament and the Aesthetics of Objects" cited in *Industrial Design: Ornament & Design 23/06*.
- Quinn, Bradley. *The Fashion of Architecture*. Oxford: Berg, 2003.
- Relph, Edward. *Place and Placelessness*. London: Pion Limited, 1976.
- Rosa, Joseph, Phil Patton, Virginia Postrel, and Valerie Steele. *Glamour: Fashion + Industrial Design + Architecture*. New Haven: Yale University Press, 2004.
- Saunders, William S. ed. *Commodification and Spectacle in Architecture*. Minneapolis: University of Minnesota Press, 2005.
- Sola-Morales, Ignasi de. *Differences: Topographies of Contemporary Architecture*. Cambridge: MIT press, 1997.

Stanwick, Sean and Jennifer Flores. *Design City: Toronto*. West Sussex: John Wiley & Sons Ltd, 2007.

Troy, Nancy J. *Couture Culture: A Study in Modern Art and Fashion*. Cambridge: MIT Press, 2003.

Urban Design Associates. *West Don Lands Precinct Plans*. Toronto: Toronto Waterfront Revitalization Corporation, 2004.

Vitta, Maurizio. "The Ghost of Decorative Embellishments" cited in *Industrial Design: Ornament & Design* 23/06.

Wigley, Mark. *White Walls, Designer Dresses*. Cambridge: MIT Press, 1995.

Wiles, David. *A Short History of Western Performance Space*. Cambridge: Cambridge University Press, 2003.

Internet Resources:

Bureau of Labour Statistics. *American Time Use Survey Summary*. United States Department of Labour. <<http://www.bls.gov/news.release/atus.nr0.htm>> (accessed 18 August, 2006)

Caulfield, Jon, "Chapter 9: The Distillery District", *Urban Planning Overseas Journal* 2005, <http://www.arts.yorku.ca/sosc/urbanst/publications/Urban_Planning_Overseas_Journal_2005.pdf> (accessed 1 September 2006)

Ouellette, Robert. *Eight Projects Reshaping Toronto*. Reading Toronto. <http://readingt.readingcities.com/index.php/toronto/search/eight_projects_reshaping_toronto/> (accessed 01 March, 2007)

Simmel, Georg. "Fashion" cited in *American Journal of Sociology*, v. 62, no. 6, 1957, <<http://www.jstor.org.proxy.lib.uwaterloo.ca/view/00029602/dm992513/99p1373a/0>> (accessed 18 October, 2006).

Toronto Green Community and Toronto Field Naturalists. *Historic Distillery District*. Lost River Walks. <<http://www.lostrivers.ca/points/distillerydistrict.htm>> (accessed 10 October 2006).

appendix A

size: 12' x 10'
materials: white cotton fabric, thread
technologies: sewing, digital photography



fig. 81
m1 work



*fig. 82-83
m1 work*