

Biomechanical Predictors of Functionally Induced Low Back Pain, Acute  
Response to Prolonged Standing Exposure, and Impact of a Stabilization-  
Based Clinical Exercise Intervention

by

Erika Nelson-Wong

A thesis

presented to the University of Waterloo

in fulfillment of the

thesis requirement for the degree of

Doctor of Philosophy

in

Kinesiology

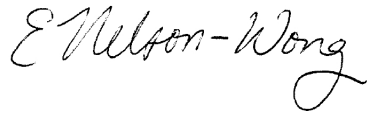
Waterloo, Ontario, Canada, 2009

© Erika Nelson-Wong 2009

## **AUTHOR'S DECLARATION**

I hereby declare that I am the sole author of this thesis. This is a true copy of the thesis, including any required final revisions, as accepted by my examiners.

I understand that my thesis may be made electronically available to the public.

A handwritten signature in black ink that reads "Erika Nelson-Wong". The signature is written in a cursive style with a large, looping initial "E".

Erika Nelson-Wong

## **ABSTRACT**

**Purpose:** Biomechanical differences between people with low back pain (LBP) and healthy controls have been shown in multiple research studies. Because of the typically used cohort research design, it is impossible to determine whether these are predisposing factors or adaptive responses to the LBP condition. LBP development has been associated with static standing postures in occupational settings, and previous experimental work has shown that a percentage of individuals will develop considerable LBP with a 2-hour functional standing exposure. This transient pain-generating model allows for comparisons between pain developers (PD) and non-pain developers (NPD) to determine whether pre-disposing factors exist. There were two major objectives for this thesis. The first was to utilize a multifactorial approach including physiotherapy clinical assessment tools, psychosocial assessments, and biomechanical measures to characterize differences between PD and NPD individuals. Acute responses to the 2-hour standing exposure were also investigated. The second objective was to investigate the impact of an exercise intervention on LBP development during standing, and to determine whether the intervention resulted in changes in any of the previously identified factors.

**Methods:** Forty-three participants without any prior history of LBP volunteered for this study. A clinical assessment was conducted on each participant by a licensed physiotherapist. Participants completed a compilation of psychosocial questionnaires. Participants performed a trunk extensor endurance test, pre- and post-standing functional movements (forward flexion in standing, squatting, single leg stance), and 2-hours of standing. Continuous electromyography (EMG) data were collected from 16 trunk and hip muscles, kinematic and kinetic data were used to construct an 8-segment rigid link

model to calculate time-varying 3-dimensional trunk and pelvis angles and the reaction moment at the L<sub>5</sub>S<sub>1</sub> joint. Average and peak vertebral joint rotation stiffness (VJRS) measures during the functional tasks were calculated with an EMG-assisted anatomical model. Participants completed 0-100 mm visual analog scales (VAS) rating their LBP every 15 minutes during the 2-hr standing exposure. Participants were classified as PD or NPD based on the threshold criteria of a greater than 10 mm increase in VAS score during standing. Participants were randomly assigned to exercise (EX) intervention or control (CON) groups. The EX group completed a standardized home exercise program (HEP) focused on hip and trunk control during dynamic movement for 4-weeks. There were weekly meetings with the investigator to monitor and progress the HEP. The CON group was instructed to maintain their usual activity level during the 4-week period. All participants returned for a second data collection following the 4-week period.

**Results:** Forty percent of participants developed LBP during the 2-hours of standing. The PD group had hypoactivity of the gluteus maximus muscles during standing forward flexion compared to NPD ( $p < 0.05$ ). The PD group had elevated gluteus medius and trunk flexor/extensor muscle co-activation prior to reports of pain development ( $p < 0.05$ ). PD and NPD demonstrated markedly different patterns of muscle activation during the 2-hr standing exposure, with PD decreasing trunk flexor/extensor co-activation as standing duration progressed. PD demonstrated higher average hip muscle activation levels during standing, with shorter muscle rest periods than NPD. There were no PD/NPD group differences in questionnaire responses, total VJRS, or extensor muscle fatigability. The only clinical assessment tool that predicted LBP development was the active hip abduction test.



Following 2-hours of standing, there was a decrease for all participants in VJRS about the lateral bend axis during unilateral stance. PD had increases in peak gluteus medius muscle activation during single leg stance (SLS). Males showed a decrease in stability during unilateral stance as shown by increased centre-of-pressure excursion.

PD<sub>EX</sub> had decreased VAS scores during the second data collection ( $p = 0.007$ ) compared with PD<sub>CON</sub>. There was a trend ( $p = 0.08$ ) for PD<sub>EX</sub> to show improvement on the active hip abduction test. Male PD<sub>EX</sub> had a decrease in gluteus medius co-activation during standing ( $p < 0.05$ ). PD<sub>EX</sub> had increased trunk flexor/extensor co-activation during the middle stages of standing. PD<sub>EX</sub> showed a variable response in gluteus medius muscle rest periods during standing compared with the other groups. Between-day repeatability for the CON groups was excellent with intraclass correlation coefficients  $\geq 0.80$  ( $p < 0.05$ ) for the majority of the outcome measures.

**Conclusions:** There were clear differences between PD/NPD groups in muscle activation patterns, prior to subjective reports of LBP, supporting the hypothesis that some of the differences observed between these groups may be predisposing rather than adaptive. A prolonged standing exposure does not appear to have detrimental effects on functional movement performance. An exercise intervention resulted in positive changes in the PD group, both in subjective pain scores as well as muscle activation profiles. Control groups had excellent between-day repeatability, showing that in the absence of intervention these outcome measures remain stable over time. Elevated gluteus medius and trunk co-activation in the first 15-30 minutes of standing may indicate that an individual is at increased risk for LBP during standing. Trunk co-activation during a sustained postural task may be beneficial, and can be facilitated through appropriate exercise intervention.

## **ACKNOWLEDGEMENTS**

There are multiple people who I must thank for their guidance, friendship, support and assistance.

First and foremost, thanks to Dr. Jack Callaghan, who has been my supervisor, mentor, and friend. I hope that I have been able to live up to his (very) high expectations. Thanks also to the entire Callaghan family, Lisa, Luke and Ella, for sharing their home, friendship and meals with me and for being my surrogate family in Canada.

Thanks to Dr. David Winter for sharing his tremendous knowledge, insight, and passion for research with me.

Dr. Aftab Patla is the reason I came to the University of Waterloo, and I learned a great deal from him in the short time we had. We all continue to miss him very much.

Without Dr. Barb Tschoepe ‘gently’ pushing me, I would never have started this journey. Thank you for your belief and confidence in me.

Thank you to the members of my committee: Dr. Jen Durkin, Dr. Tim Flynn, and Dr. Rhona Hanning. I believe you have helped to make this work stronger through your insightful questions and suggestions.

It would have been impossible to complete these data collections without the help of all of our undergraduate lab assistants: Andrew Jeffreys, Alexander Macintosh, Mamiko Ngoguchi, Alexandra Peel, Lynne Pronovost, Joey Saucier, Katie Selman, Emily Sischek, Dave Smith, and Matthew Trouborst. You are all remarkable young people, and I am looking forward to seeing where your paths take you!

Thanks to my other Canadian family, the Callaghan Spine Lab: Tyson Beach, Nadine Dunk, Diane Gregory, Jennie Jackson, and Rob Parkinson. With very special gratitude to Janessa Drake, Sam Howarth, and Diana DeCarvalho – the three of you have talked me up, talked me down, served as sounding boards, helped with coding, and been amazing friends over the past 4 years.

Not much would get done without the able and willing assistance of the following people: Wendell Prime, Craig MacDonald and Ruth Gooding. Wendell spent hours helping me troubleshoot EMG signals, Craig kept my computers functioning, and Ruth made sure everything went as smoothly as possible starting well before I even arrived on campus.

I have benefited greatly by having my doctoral studies funded in part by the Foundation for Physical Therapy through the Mary McMillan, PODS I and PODS II scholarships.

Last, but certainly not least, I have to thank my husband Jim. We have shared many adventures together, and I am looking forward to beginning the next one.

# TABLE OF CONTENTS

List of Figures.....	xiv
List of Tables .....	xx
<b>1. Introduction and Background .....</b>	<b>1</b>
<b>1.1. Incidence of Low Back Pain.....</b>	<b>1</b>
<b>1.2. Risk Factors and Causes of Low Back Pain .....</b>	<b>1</b>
<b>1.3. Prolonged Standing as a Risk Factor for Low Back Pain.....</b>	<b>2</b>
<b>1.4. Sub-Classification of Low Back Pain Disorders .....</b>	<b>3</b>
<b>1.5. Stabilization-based Exercise as an Intervention for Low Back Pain .....</b>	<b>3</b>
<b>1.6. Motor Control Patterns and Low Back Pain: Predisposing Versus Adaptive Factors?.....</b>	<b>4</b>
<b>1.7. Central Themes and Hypotheses for This Thesis .....</b>	<b>5</b>
1.7.1. Study 1: Predictive Factors for Low Back Pain Development During Standing .....	7
1.7.2. Study 2: Acute Changes in Response to Standing Exposure.....	8
1.7.3. Study 3: Response to an Exercise-Based Intervention .....	8
1.7.4. Study 4: Repeatability of Motor Control Patterns During Functional Movements and Prolonged Standing In People With and Without Standing-Induced Low Back Pain.....	9
<b>2. A General Review of the Literature.....</b>	<b>10</b>
<b>2.1. Proposed Underlying Mechanisms of Low Back Pain .....</b>	<b>10</b>
2.1.1. Patho-Anatomical Model.....	10
2.1.2. Peripheral Pain Generator Model .....	11
2.1.3. Neurophysiological Model .....	12
2.1.4. Psychosocial Model.....	12
2.1.5. Mechanical Loading Model.....	15
2.1.6. Bio-Psychosocial Model.....	16
<b>2.2. Sub-Classification of Low Back Pain .....</b>	<b>17</b>
2.2.1. Quebec Task Force Classification System .....	18
2.2.2. Pain Pattern Classification System .....	20
2.2.3. ‘Motion Signature’ Classification System.....	21

2.2.4.	Movement and Control Impairment Classification System.....	22
2.2.5.	Treatment-Based Classification System .....	22
<b>2.3.</b>	<b>Stabilization Terminology: Clinical Versus Biomechanical Instability- Are We Talking About the Same Thing?.....</b>	<b>26</b>
<b>2.4.</b>	<b>Altered Muscle Activation in the Presence of Low Back Pain.....</b>	<b>28</b>
2.4.1.	Pain-Spasm-Pain Model .....	31
2.4.2.	Pain Adaptation Model.....	32
2.4.3.	Gaps in the Muscle Activation Literature.....	34
<b>2.5.</b>	<b>Some Methodological Considerations.....</b>	<b>36</b>
2.5.1.	Biomechanical Modeling.....	36
2.5.2.	Vertebral Joint Rotational Stiffness.....	38
2.5.3.	The Subjective Nature of Pain Reporting.....	39
2.5.4.	Adherence to Prescribed Exercise Interventions .....	41
<b>3.</b>	<b>Methods.....</b>	<b>43</b>
<b>3.1.</b>	<b>Laboratory Preparation .....</b>	<b>43</b>
3.1.1.	Drift Test on Force Platforms .....	44
3.1.2.	Motion Capture System Set-up.....	45
3.1.3.	Force Platform and Motion Capture Congruence.....	45
3.1.4.	Calibration of Motion Capture System.....	46
3.1.5.	Calibration of Force Platforms .....	46
3.1.6.	Location of Force Platforms in the Global Coordinate System.....	47
<b>3.2.</b>	<b>Experimental Protocol.....</b>	<b>47</b>
3.2.1.	Participant Recruitment .....	47
3.2.2.	Psychosocial and Activity Questionnaires.....	48
3.2.3.	Clinical Assessment.....	53
3.2.4.	Anthropometric Measurements .....	60
3.2.5.	Instrumentation for Electromyography.....	61
3.2.6.	Extensor Endurance Test.....	64
3.2.7.	Flexion in Standing Without Motion Capture .....	65
3.2.8.	Instrumentation for Motion Capture.....	66

3.2.9.	Pre-Standing Functional Movements .....	68
3.2.10.	Prolonged Standing Protocol .....	71
3.2.11.	Visual Analog Scale (VAS) Reporting.....	73
3.2.12.	Post-Standing Functional Movements.....	74
<b>3.3.</b>	<b>Data Collection and Signal Processing.....</b>	<b>75</b>
3.3.1.	Spectral Analysis and Filtering of Electromyography Signals.....	75
3.3.2.	Determination of MVCs .....	80
3.3.3.	Co-Contraction Index .....	81
3.3.4.	Cross-Correlation Analyses.....	82
3.3.5.	Fatigue Analyses For Extensor Endurance Test.....	83
3.3.6.	Calculation of Flexion Relaxation Ratio .....	84
3.3.7.	Force Platform Signal Processing.....	85
3.3.8.	Centre-of-Pressure .....	86
<b>3.4.</b>	<b>Biomechanical Modeling .....</b>	<b>87</b>
3.4.1.	Inverse Dynamic Model .....	87
3.4.2.	Vertebral Joint Rotational Stiffness.....	88
<b>3.5.</b>	<b>Statistics .....</b>	<b>93</b>
<b>4.</b>	<b>Results - Laboratory and Equipment Preparation.....</b>	<b>94</b>
4.1.	Force Platform Drift Test.....	94
4.2.	Cal Tester.....	95
4.3.	Motion Capture Calibration .....	96
<b>5.</b>	<b>Study 1: Identification of Predictive Factors for Low Back Pain Development</b>	
	<b>During Standing.....</b>	<b>97</b>
5.1.	Participant Baseline Characteristics .....	97
5.2.	Low Back Pain Development During Standing .....	98
5.3.	Psychosocial Questionnaires .....	100
5.4.	Clinical Assessment.....	102
5.5.	Extensor Endurance Test.....	110
5.6.	Flexion Relaxation Ratio .....	114
5.7.	Single Leg Stance .....	115

5.7.1.	Muscle Co-contraction During Single Leg Stance .....	116
5.7.2.	Trunk and Pelvis Kinematics During Single Leg Stance .....	117
5.7.3.	Vertebral Joint Rotation Stiffness During Single Leg Stance .....	120
5.7.4.	Centre of Pressure Excursion During Single Leg Stance .....	122
5.7.5.	Gluteus Medius Muscle Activation Levels.....	124
5.7.6.	Conclusions – Single Leg Stance .....	125
<b>5.8.</b>	<b>Vertebral Joint Rotation Stiffness During the Squat Movement .....</b>	<b>126</b>
<b>5.9.</b>	<b>Trunk and Pelvis Kinematics During Prolonged Standing .....</b>	<b>128</b>
<b>5.10.</b>	<b>Phase Relationships/Timing .....</b>	<b>130</b>
<b>5.11.</b>	<b>Muscle Co-Contraction Index.....</b>	<b>132</b>
<b>5.12.</b>	<b>Average Muscle Activation Patterns During Standing .....</b>	<b>139</b>
5.12.1.	Average EMG Values During Standing Exposure .....	140
5.12.2.	Gaps Analyses .....	142
<b>5.13.</b>	<b>Discussion and Conclusions .....</b>	<b>146</b>
<b>6.</b>	<b>Study 2: Acute Changes in Response to Prolonged Standing Exposure.....</b>	<b>154</b>
<b>6.1.</b>	<b>Introduction.....</b>	<b>154</b>
<b>6.2.</b>	<b>Flexion Relaxation Ratio .....</b>	<b>155</b>
<b>6.3.</b>	<b>Single Leg Standing .....</b>	<b>156</b>
6.3.1.	Muscle Co-Contraction During Single Leg Stance .....	157
6.3.2.	Vertebral Joint Rotation Stiffness During SLS .....	159
6.3.3.	Trunk and Pelvis Kinematics.....	162
6.3.4.	Centre of Pressure Excursion During Single Leg Standing.....	167
6.3.5.	Gluteus Medius Muscle Activation During Single Leg Standing .....	168
6.3.6.	Conclusions – Single Leg Stance Response to Standing Exposure.....	170
<b>6.4.</b>	<b>Vertebral Joint Rotation Stiffness During Squatting.....</b>	<b>171</b>
<b>6.5.</b>	<b>Discussion and Conclusions .....</b>	<b>174</b>
<b>7.</b>	<b>Study 3: Response to an Exercise-Based Intervention .....</b>	<b>178</b>
<b>7.1.</b>	<b>Introduction.....</b>	<b>178</b>
<b>7.2.</b>	<b>Additional Methodology.....</b>	<b>178</b>
7.2.1.	Assignment to Intervention Groups.....	178

7.2.2.	The Exercise Intervention.....	179
7.2.3.	Data Collection Day 2 .....	182
<b>7.3.</b>	<b>Exercise Compliance.....</b>	<b>183</b>
<b>7.4.</b>	<b>Pain Development .....</b>	<b>183</b>
<b>7.5.</b>	<b>Activity Level Between Testing Sessions.....</b>	<b>186</b>
<b>7.6.</b>	<b>Clinical Assessment Findings.....</b>	<b>187</b>
<b>7.7.</b>	<b>Extensor Endurance Test.....</b>	<b>191</b>
<b>7.8.</b>	<b>Flexion Relaxation Ratio .....</b>	<b>193</b>
<b>7.9.</b>	<b>Single Leg Stance .....</b>	<b>194</b>
7.9.1.	Muscle Co-contraction During Single Leg Stance .....	194
7.9.2.	Gluteus Medius Muscle Activation During Single Leg Stance.....	198
<b>7.10.</b>	<b>Vertebral Joint Rotation Stiffness During Squat Task .....</b>	<b>199</b>
<b>7.11.</b>	<b>Muscle Co-activation During Prolonged Standing .....</b>	<b>206</b>
7.11.1.	Co-contraction Index (CCI) for Gluteus Medius (GMed).....	206
7.11.2.	Co-Contraction Index (CCI) for the Global Trunk Flexors/Extensors ....	208
<b>7.12.</b>	<b>Muscle Activation Patterns During Prolonged Standing.....</b>	<b>210</b>
7.12.1.	Muscle Activation Levels During Standing .....	210
7.12.2.	Gaps in Muscle Activation During Standing.....	214
<b>7.13.</b>	<b>Discussion and Conclusions .....</b>	<b>216</b>
<b>8.</b>	<b>Study 4: Repeatability of Motor Control Patterns During Functional Movements and Prolonged Standing In People With and Without Standing- Induced Low Back Pain .....</b>	<b>221</b>
<b>8.1.</b>	<b>Purpose and Hypotheses .....</b>	<b>221</b>
<b>8.2.</b>	<b>Pain Development .....</b>	<b>221</b>
<b>8.3.</b>	<b>Clinical Assessment Findings.....</b>	<b>224</b>
<b>8.4.</b>	<b>Extensor Endurance Test.....</b>	<b>228</b>
<b>8.5.</b>	<b>Flexion Relaxation Ratio .....</b>	<b>230</b>
<b>8.6.</b>	<b>Single Leg Stance .....</b>	<b>231</b>
<b>8.7.</b>	<b>Vertebral Joint Rotation Stiffness During Squatting.....</b>	<b>232</b>
<b>8.8.</b>	<b>Muscle Co-Contraction During Prolonged Standing .....</b>	<b>236</b>



<b>8.9. Muscle Activation Patterns During Prolonged Standing</b> .....	<b>238</b>
8.9.1. Average EMG During Standing .....	238
8.9.2. Total Gap Length During Prolonged Standing.....	238
<b>8.10. Conclusions and Discussion</b> .....	<b>239</b>
<b>9. General Discussion and Conclusions</b> .....	<b>244</b>
<b>References</b> .....	<b>249</b>
<b>Appendices</b> .....	<b>260</b>
<b>Appendix A: Modified Minnesota Leisure-Time Physical Activity Questionnaire</b>	<b>260</b>
<b>Appendix B: Current Health Status Form</b> .....	<b>265</b>
<b>Appendix C: The Clinical Assessment Form</b> .....	<b>268</b>
<b>Appendix D: Core Stabilization Exercise Program</b> .....	<b>269</b>
<b>Appendix E: Stabilization Exercise Log</b> .....	<b>275</b>

## LIST OF FIGURES

Figure 1.1 Schematic diagram showing the central thesis questions and the four primary studies. ....	7
Figure 2.1 Schematic of The World Health Organization’s International Classification of Functioning, Disability and Health (ICF) showing bi-directional interaction between factors adapted from Stucki and Sigl (2003). ....	14
Figure 2.2 Clinical algorithm for sub-classification of LBP patients adapted from Fritz, et al. (2007).....	23
Figure 2.3 a) The nociceptor (N) projects onto the alpha motor neuron ( $\alpha$ ) via excitatory interneurons (E), causing increased muscle activity. b) The nociceptor projects onto the muscle spindle (S) via the gamma motor neuron ( $\gamma$ ). The muscle spindle acts directly, and through excitatory interneuron projections, on the alpha motor neuron to increase muscle activity. Diagram adapted from van Dieen, et al. (2003).....	32
Figure 2.4 Proposed Neural Pathway for the Pain Adaptation Model The nociceptor (N) projects onto alpha motor neurons ( $\alpha$ ) supplying the agonist and antagonist muscles via excitatory (E) and inhibitory (I) interneurons. Descending motor commands suppress excitation of the agonist and inhibition of the antagonist, while facilitating inhibition of the agonist and excitation of the antagonist, resulting in increased antagonist and decreased agonist muscle activity. Diagram adapted from van Dieen, et al. (2003).....	34
Figure 3.1 Laboratory Set-up and Hardware Arrangement .....	44
Figure 3.2 Flowchart of the experimental protocol for the two data collection days separated by a 4-week period.....	48
Figure 3.3 Lateral bridge support test was performed to failure on each side.....	56
Figure 3.4 Participant positioned with pelvis aligned in the frontal plane and lower extremities in line with the trunk. Top panel shows frontal plane view, bottom panel shows sagittal plane view from above, and side panel shows a sagittal/transverse plane view to allow a visualization of the axial rotation of the pelvis and trunk. ....	59
Figure 3.5 Participant demonstrates good control of the pelvis and trunk during active hip abduction, resulting in an examiner score of 0. Note the lower limbs, trunk, shoulders and pelvis remain aligned in the frontal plane.....	59
Figure 3.6 Participant demonstrates poor control of the pelvis and trunk during active hip abduction, resulting in an examiner score of 3. Note the pelvis tips forward out of the frontal plane during the hip abduction movement, trunk and shoulders are starting to rotate, and abducting hip is internally rotated. ....	60
Figure 3.7 Electrode placements for electromyography. ....	62
Figure 3.8 Schematic showing iRED marker placement on figure. Calibration markers are shown in light gray. ....	68

Figure 3.9 Participant performing right single leg standing (RSLS).....	69
Figure 3.10 Forward flexion in standing (with motion capture instrumentation).....	70
Figure 3.11 Unloaded squats were performed pre- and post- prolonged standing. ....	71
Figure 3.12 Prolonged Standing Experimental Set-up .....	72
Figure 3.13 Raw EMG from right external oblique containing ECG contamination. ....	77
Figure 3.14 Power spectrum plot of the raw EMG signal shows frequencies of the ECG contamination as well as 60 Hz electrical noise. ....	78
Figure 3.15 EMG signal post-filtering with a notch filter (59-61 Hz) and band-pass (30- 500 Hz) as described in the text.....	79
Figure 3.16 Power spectrum plot of the signal, post-filtering. ....	80
Figure 3.17 Representative example of MPF slope for a female participant during the extensor endurance test. ....	84
Figure 3.18 Representative example of extensor EMG for a typical forward flexion trial. The upright standing phase is from approximately 0-2 seconds, and the fully flexed phase is between approximately 7.5 – 12 seconds.....	85
Figure 3.19 Coordinate system for the force platform relative to the participant’s position (note <i>z</i> is + down).....	87
Figure 5.1 The 2-hour standing protocol was successful at inducing pain in 40% of the participants with a clear differentiation between PD and NPD groups (time by group interaction significant at $p < 0.001$ ). ....	99
Figure 5.2 Pain developers averaged a maximum VAS score of $22.7 \pm 2.91$ mm and non- pain developers averaged a maximum VAS score of $1.37 \pm 0.45$ mm.....	100
Figure 5.3 ROC plot for different cut-off thresholds. The equivalent perpendicular distance from the line of identity, 0.205, indicates no difference in optimum cutoff threshold between scores of 1 and 2. Area under the curve (AUC) is approximately 0.64, and indicates limited utility of the test. ....	105
Figure 5.4 Females were able to maintain the Beiring-Sorensen position longer than males ( $p < 0.05$ ). ....	111
Figure 5.5 During the extensor endurance task, females had the highest average muscle activations in the thoracic erector spinae (TES) while males had the highest average activations in the lumbar erector spinae ( $p < 0.01$ ). ....	112
Figure 5.6 Male pain developers had elevated co-contraction (CCI) of the right lumbar erector spinae - left internal oblique muscles during right single leg standing compared to all other groups ( $p < 0.05$ ). ....	117
Figure 5.7 There were significant PD/NPD group by gender differences ( $p < 0.05$ ) in right single leg standing for the relative trunk angle about the lateral bend axis. ..	119

Figure 5.8 ‘Active’ VJRS by vertebral level during RSLs had no differences between PD/NPD groups. ....	121
Figure 5.9 Representative centre-of-pressure plot during LSLs showing how peak excursion was calculated. Note the origin is located in the centre of the force platform.....	123
Figure 5.10 Average normalized EMG for left gluteus medius during LSLs shows male PD had higher % MVC activation levels than the other 3 groups ( $p < 0.05$ ). ....	124
Figure 5.11 Participants had a general increase in pelvis posterior tilt over the 2-hours standing period ( $p < 0.01$ ). The difference from the initial pelvis position at the beginning of the trial is shown to demonstrate changes over time.....	129
Figure 5.12 Average phase lags between trunk flexor and extensor muscles and right gluteus medius over 2-hours of standing indicate a bottom up postural control strategy.....	131
Figure 5.13 Trunk flexor-extensor co-contraction index (CCI) over time shows differing levels of co-contraction index between groups during the initial 30 minutes of standing. * indicates significant differences, $p < 0.05$ .....	134
Figure 5.14 Right and left gluteus medius co-contraction index (CCI) over time shows higher muscle co-activation for the PD group versus the NPD group during the initial and final 30 minutes of standing. * indicates significant differences, $p < 0.05$ . ....	135
Figure 5.15 Over the 2-h prolonged standing period, the NPD group showed an average increase in co-activation of both the trunk flexor-extensor and bilateral gluteus medius muscles. ....	136
Figure 5.16 During acute pain development, steepest slope of VAS, the PD group had a decrease in co-activation of trunk flexor-extensors and bilateral gluteus medius muscles. Co-activation of both muscle groups increased again at the end of the standing period, while VAS leveled off.....	137
Figure 5.17 Time-varying co-activation patterns for trunk flexor-extensor and bilateral gluteus medius muscles were negatively correlated between PD and NPD during the time period of acute pain development (decreasing levels for PD and increasing for NPD). ....	138
Figure 5.18 The Right Gluteus Medius muscle had higher activation levels ( $p < 0.05$ ) during standing for male pain developers compared with the other 3 groups. ....	141
Figure 5.19 PD/NPD groups had different patterns of RLES muscle activation magnitudes ( $p < 0.05$ ) over the 2-hour standing exposure. ....	142
Figure 5.20 Total Gap time for each 15-minute block during the 2-hour standing exposure shows a slight decrease ( $p < 0.05$ ) in right and left gluteus maximus, right external oblique and left internal oblique muscle groups as standing duration increased....	144

Figure 5.21 The total Gap time for bilateral gluteus medius muscles decreased over time for the NPD group, while it stayed relatively constant for the PD group during the standing exposure. NPD had longer total Gap times than PD for these muscles at the beginning and end of the standing protocol (* designates $p < 0.05$ ). .....	145
Figure 5.22 NPD had longer total Gap times during prolonged standing exposure than PD ( $p < 0.05$ ) for bilateral gluteus maximus muscles.....	146
Figure 6.1 There was a significant ( $p < 0.05$ ) decrease in co-contraction of left lumbar erector spinae and left internal oblique muscles during right SLS following the prolonged standing exposure. ....	158
Figure 6.2 Following the prolonged standing exposure, males who were pain developers had a decrease in co-contraction of the right lumbar erector spinae and left internal oblique muscles during right SLS compared to the other three groups ( $p < 0.05$ ). .....	159
Figure 6.3 There was a general decrease in stiffness about the lateral bend axis ( $p < 0.05$ ) following the 2-hour standing exposure. ....	161
Figure 6.4 Participants increased lateral bending of the thorax relative to the pelvis during right SLS following the 2-hour standing exposure ( $p < 0.01$ ). .....	163
Figure 6.5 The PD/NPD groups responded differently in RSLs following the standing exposure in trunk flexion/extension ( $p < 0.05$ ). .....	164
Figure 6.6 PD/NPD groups responded differently to standing exposure in global pelvis lateral bending during the LSLs task ( $p < 0.01$ ). .....	166
Figure 7.1 The exercise intervention included: A) abdominal bracing with heel slides and straight leg raises; B) Arm and leg extensions in quadruped (arm raise is shown); C) Bridging in supine; D) Standing rows with resistance band; E) Side bridge support .....	181
Figure 7.2 Additional exercises included: F) ‘Clamshells’ in sidelying; G) Single leg wall-slide squat with abdominal bracing .....	182
Figure 7.3 There was a significant change in VAS score on Collection Day 2 for the PD group ( $p < 0.001$ ). There were no longer significant differences in VAS between PD and NPD groups ( $p > 0.05$ ) on Collection Day 2. The dashed gray line shows the cut-off threshold for PD/NPD classification. ....	184
Figure 7.4 There were no significant ( $p > 0.05$ ) changes in VAS score for either NPD <sub>CON</sub> or NPD <sub>EX</sub> between Collection Days 1 and 2. The dashed gray line shows cut-off threshold for PD/NPD classification.....	185
Figure 7.5 PD <sub>EX</sub> had a significant ( $p < 0.0125$ ) change following the 4-week exercise intervention, while PD <sub>CON</sub> had no significant ( $p > 0.05$ ) change in VAS score. The dashed gray line shows the cut-off threshold for PD/NPD classification.....	186
Figure 7.6 Raw examiner rated Active Hip Abduction Test scores between collection days by PD/NPD group and assigned intervention show a decrease for the PD <sub>EX</sub> group between days (non-significant at $p = 0.08$ ). .....	188

Figure 7.7 Histogram plot of the between day changes in examiner-scored AHAbd test, using the $\geq 2$ = ‘pos’ and $< 2$ = ‘neg’ classification, by PD group and intervention received.....	189
Figure 7.8 The PD group had a decrease in right lumbar erector spinae-left internal oblique co-contraction during RSLs ( $p < 0.05$ ) on the second collection day, regardless of intervention received, while the NPD group had no change.....	196
Figure 7.9 Males had an overall decrease in co-contraction of the right lumbar erector spinae-left internal oblique muscle pair during RSLs ( $p < 0.05$ ) on Day 2, while females had no change.....	197
Figure 7.10 NPD <sub>CON</sub> had an increased relative contribution of the EO muscle to VJRS about the $y$ -axis (axial twist) during the ‘up’ phase of squat on the second collection day, while PD <sub>CON</sub> had no changes between days.....	201
Figure 7.11 There were no effects of the exercise intervention on EO contribution to VJRS about the $y$ -axis (axial twist) during the ‘up’ phase of squat for either PD or NPD groups.....	201
Figure 7.12 The NPD <sub>CON</sub> group had an increase in the relative contribution from the EO muscles to VJRS about the $y$ -axis (axial twist) during the ‘up’ phase of squat on Day 2.....	202
Figure 7.13 There were no between day changes in EO contribution to VJRS about the $y$ -axis (axial twist) during the ‘up’ phase of squat for the PD group, regardless of intervention received.....	202
Figure 7.14 The average relative contribution of the EO to VJRS about the $y$ -axis during the ‘down’ phase of the squat increased for the NPD <sub>CON</sub> group only on Day 2.....	204
Figure 7.15 Average contribution of EO to stiffness about the $y$ -axis during the ‘down’ phase of squat did not change for PD or NPD groups after exercise intervention.....	204
Figure 7.16 There was an increase in the EO contribution to axial stiffness during the ‘down’ phase of squat on the second day for the NPD <sub>CON</sub> group.....	205
Figure 7.17 There were no significant between day changes in EO contribution to axial stiffness during the ‘down’ phase of squat for PD <sub>EX,CON</sub> .....	205
Figure 7.18 The Male PD <sub>EX</sub> group was the only group that had differences in gluteus medius CCI between collection days ( $*p < 0.05$ ).....	207
Figure 7.19 Both NPD <sub>CON</sub> and PD <sub>CON</sub> had significant decreases in trunk flexor/extensor CCI ( $*p < 0.05$ ) on Collection Day 2.....	208
Figure 7.20 There were differences in the NPD <sub>EX</sub> and PD <sub>EX</sub> response to intervention, with PD <sub>EX</sub> having increases and NPD <sub>EX</sub> having decreases in trunk co-contraction throughout the 2-hour standing period.....	209

Figure 7.21 When NPD were examined independently, it could be seen that there was a decrease in trunk CCI for both exercise and control groups between collection days. .... 209

Figure 7.22 PD<sub>EX</sub> had an initial decrease, followed by increased trunk co-contraction. PD<sub>CON</sub> demonstrated decreased trunk co-contraction on Day 2 throughout the 2-hour standing period..... 210

Figure 7.23 There was a significant ( $p < 0.001$ ) change in average activation of the right lumbar erector spinae muscle between collection days. .... 211

Figure 7.24 NPd and PD groups responded differently ( $p < 0.05$ ) to exercise intervention in average left gluteus medius muscle activation levels during standing. PD<sub>EX</sub> had a small decrease in average LGMd activity, while NPd<sub>EX</sub> had a very small increase. .... 212

Figure 7.25 Between day differences for average activation of gluteus maximus muscles differed between intervention groups ( $p < 0.05$ ). .... 213

Figure 7.26 Male PD<sub>EX</sub> demonstrated longer rest periods for the right gluteus medius muscle during prolonged standing following exercise intervention ( $p < 0.05$ ). ..... 216

Figure 8.1 There were no between day differences for either control group in VAS score for the low back during standing. The gray dashed line indicates the VAS cutoff threshold for the PD group classification. .... 222

## LIST OF TABLES

Table 2.1 Red flags for serious spinal pathology (Waddell 2004) .....	19
Table 2.2 Yellow flags for psychosocial risk factors (Waddell 2004) .....	19
Table 3.1 Questions taken from the Cognitive Risk Profile for Pain (CRPP).....	49
Table 3.2 Questions from the Survey of Pain Attitudes – Brief (SOPA-b).....	50
Table 3.3 Questions from the Fear Avoidance Beliefs Questionnaire (FABQ) .....	51
Table 3.4 Cues to differentiate test performance on the AHAbd test.....	58
Table 3.5 Anthropometric measurements .....	61
Table 3.6 Electrode placement for electromyography .....	62
Table 3.7 Positions for maximum voluntary contractions (MVCs).....	64
Table 3.8 Placement of motion capture (iRED) markers.....	67
Table 4.1 Drift test data for large force platform (FP1).....	94
Table 4.2 Drift test data for small force platform (FP2).....	95
Table 4.3 Force platform outputs for objects of known mass.....	95
Table 4.4 Reported error in COP from CalTester.....	95
Table 5.1 Baseline characteristics of participants.....	98
Table 5.2 Mean CRPP responses (lower scores indicate stronger agreement with the statement).....	101
Table 5.3 Mean SOPA-b responses (higher scores indicate stronger agreement with the statement).....	102
Table 5.4 Mean FABQ responses (higher scores indicate stronger agreement with the statement).....	102
Table 5.5 Group differences on clinical measures (significant <i>p</i> -values in bold) .....	103
Table 5.6 The 2x2 table for examiner-scored AHAbd test with cutoff score $\geq 2$ (95% CI is shown in parentheses) .....	106
Table 5.7 The 2x2 table for self-rated AHAbd test with cutoff score $\geq 4$ (95% CI is shown in parentheses).....	107
Table 5.8 Summary data for muscle activation level during extensor endurance test....	112
Table 5.9 There were gender differences in EMG fatigue measures for erector spinae muscles (significant <i>p</i> -values in bold). .....	113
Table 5.10 Average Flexion Relaxation Ratio values for the three monitored muscle groups (significant <i>p</i> -value is in bold). .....	115



Table 5.11 The 8 combinations of muscle pairs used for CCI in single leg stance. ....	116
Table 5.12 Trunk and pelvis angles in left single leg stance (LSLS) .....	118
Table 5.13 Trunk and pelvis angles in right single leg stance (RSLs).....	120
Table 5.14 Peak centre-of-pressure (COP) excursion (averaged across participants) during single leg stance.....	123
Table 5.15 Relative contribution of external oblique to VJRS during squatting (significant <i>p</i> -values in bold). .....	127
Table 5.16 The 12 combinations of flexor/extensor muscle pairs that were used for CCI during standing .....	133
Table 5.17 Summary data for average EMG activation during 2-hours of standing exposure .....	140
Table 5.18 Average EMG values that had significant PD/NPD group differences during prolonged standing exposure. ....	141
Table 5.19 Summary data for Gaps analysis during 2-hours of standing exposure .....	143
Table 5.20 Total Gap time for each 15-minute block for the muscles that had significant main effects of time .....	144
Table 6.1 Summary data for pre- and post- prolonged standing exposure flexion relaxation ratios (FRR) .....	155
Table 6.2 Summary data for relative trunk angle during RSLs pre- and post-prolonged standing exposure .....	162
Table 6.3 Summary data for relative trunk angle by PD/NPD group during RSLs, pre- and post- prolonged standing exposure (significant differences in bold). ....	164
Table 6.4 Summary data for thorax and pelvis position during RSLs pre- and post- prolonged standing exposure .....	165
Table 6.5 Summary data for relative trunk and thorax angles during LSLS, pre-and post- prolonged standing exposure .....	165
Table 6.6 Summary data for global pelvis angle in LSLS pre- and post-prolonged standing exposure (significant differences in bold).....	166
Table 6.7 Summary data for COP excursion in RSLs, pre- and post prolonged standing exposure. ....	167
Table 6.8 Summary data for COP excursion in LSLS, pre- and post prolonged standing exposure. ....	168
Table 6.9 Effect sizes and <i>p</i> -values for COP excursion changes in males. ....	168
Table 6.10 Peak right gluteus medius muscle activation during RSLs, pre- and post- prolonged standing exposure .....	169

Table 6.11 Peak left gluteus medius muscle activation during LSLS, pre- and post-prolonged standing exposure .....	170
Table 6.12 Average ‘active’ VJRS values pre- and post- standing exposure during squat task .....	172
Table 6.13 Peak ‘active’ VJRS values pre- and post- standing exposure during squat task .....	173
Table 7.1 Sample distribution following re-classification and participant dropout.....	179
Table 7.2 Between-day comparisons for MPAQ scores by intervention group .....	187
Table 7.3 Summary data for clinical assessment measures .....	190
Table 7.4 Between-day peak and average muscle activation levels during extensor endurance test .....	192
Table 7.5 Between-day measures of fatigability during extensor endurance test.....	193
Table 7.6 Between-day flexion relaxation ratios (FRR).....	194
Table 7.7 Summary data for trunk co-contraction values in left single leg standing. ....	197
Table 7.8 Summary data for trunk co-contraction values in right single leg standing. ..	198
Table 7.9 Peak and average gluteus medius (Glut Med) muscle activation for PD/NPD groups during single leg stance (SLS) on collection Days 1 and 2 .....	199
Table 7.10 Between-day differences in left gluteus medius average activation levels by PD/NPD group and assigned intervention .....	213
Table 7.11 Between-day differences in average gluteus maximus muscle activation in response to 4-week control or exercise period.....	214
Table 7.12 PD/NPD group differences in total Gap length were present on both Days 1 and 2.....	215
Table 8.1 VAS scores for control group participants on Days 1 and 2. Participants who changed groups are in bold. ....	223
Table 8.2 Between-day examiner rated AHAbd test scores by PD/NPD group and gender. ....	225
Table 8.3 Between-day repeatability for clinical assessment tools. Measures that had poor between day repeatability are indicated in <i>bold italic</i> . ....	226
Table 8.4 Intraclass correlation coefficients for muscle fatigability during extensor endurance test between days. Measures that have poor between day repeatability are indicated by <i>bold italic</i> . ....	229
Table 8.5 Between-day repeatability for peak and average EMG during the extensor endurance test. Measures with poor repeatability are indicated with <i>bold italic</i> . ....	230

Table 8.6 Between-day repeatability for flexion relaxation ratio. Measures with poor repeatability are indicated with <i>bold italic</i> . .....	231
Table 8.7 Between-day repeatability for average external oblique contribution to vertebral joint rotation stiffness during the ‘up’ phase of the squat. Measures that were different between days are indicated with <i>bold italic</i> . .....	233
Table 8.8 Between-day repeatability for peak external oblique contribution to vertebral joint rotation stiffness during the ‘up’ phase of the squat. Measures that were different between days are indicated with <i>bold italic</i> . .....	234
Table 8.9 Between-day repeatability for average external oblique contribution to vertebral joint rotation stiffness during the ‘down’ phase of the squat. Note that all measures were different between days. ....	235
Table 8.10 Between-day repeatability for peak external oblique contribution to vertebral joint rotation stiffness during the ‘down’ phase of the squat. Note that all measures were different between days. ....	236
Table 8.11 Within-day and between-day repeatability for gluteus medius co-contraction during standing. ....	237
Table 8.12 Within-day and between -day repeatability for trunk flexor/extensor co-contraction during standing. Poor repeatability is indicated in <i>bold italic</i> . ....	238
Table 8.13 Within-day and between-day repeatability for average muscle activation during standing. ....	238
Table 8.14 Within-day and between-day repeatability for total Gap length during standing. ....	239

# **1. INTRODUCTION AND BACKGROUND**

## **1.1. Incidence of Low Back Pain**

It is well known that low back pain (LBP) is a major contributor to escalating health care costs and disability in North America. It is estimated that 70-85% of all adults will experience a significant episode of LBP at some point in their lives (Giesecke, Gracely et al. 2004). One-third of adults in the United States have some back pain each year, with 7-14% of US adults reporting some restriction of daily activities due to back pain within the previous year, and 700,000 workers' compensation claims for work-related back pain each year (Waddell 2004). Low back injuries are also the most commonly reported occupational injury in Canada (Kumar 2001). One third of worker's compensation costs are related to back pain with chronic cases accounting for the majority of costs (Abenhaim, Rossignol et al. 2000). In a review of the epidemiological literature, Hestabek (2003) found estimates for the point prevalence of LBP ranging from 7 to 39% for the general population. For those who have had a prior episode of LBP, the risk of developing LBP doubles, with a commensurate increase in point prevalence estimates from 14 to 93%.

## **1.2. Risk Factors and Causes of Low Back Pain**

Many risk factors have been identified for the development of low back injury, including anthropometric characteristics, lumbar hypomobility, reduced lumbar lordosis, psychological distress and previous low back injury (Adams, Mannion et al. 1999), as well as specific mechanical loading factors (Norman, Wells et al. 1998). However, LBP is a complex, multi-factorial process with patho-anatomical, neuro-physiological, physical and psychosocial components (Linton 2000; Kumar 2001; Waddell 2004)

potentially contributing to low back dysfunction. Therefore, the effective prediction of who will develop LBP remains problematic (Leboeuf-Yde, Lauritsen et al. 1997).

Most patients presenting to the health care system with complaints of LBP are not found to have any discernable tissue damage or injury, at least with the use of current diagnostic imaging techniques (Giesecke, Gracely et al. 2004). These patients are typically referred to as having ‘non-specific LBP’ in the absence of positive diagnostic findings for overt structural damage. It has been estimated that no specific pathology can be found in 85% of LBP cases (Waddell 2004).

### **1.3. Prolonged Standing as a Risk Factor for Low Back Pain**

Epidemiological studies have shown that standing occupations have a strong association with LBP (Andersen, Haahr et al. 2007; Roelen, Schreuder et al. 2008). Checkout clerks and individuals in other occupations often have long periods of standing and are known to develop LBP as the length of time on their feet increases (Kim, Stuart-Buttle et al. 1994). In a 2-year prospective study of Danish workers across 30 different industries, Andersen and colleagues (2007) found requiring prolonged periods of occupational standing (> 30 minutes out of each hour) was one of the strongest predictors of LBP with a hazard ratio of 2.1 (95% CI 1.3-3.3). Another study in Dutch workers reported that prolonged standing was related to increased pain reporting in the low back and thoracic region (Roelen, Schreuder et al. 2008). Prolonged standing has been strongly associated with LBP incidence, but not all workers exposed to prolonged standing will become LBP developers. Therefore it would be useful to have screening and assessment tools that could be predictive of pain development and that could assist in early identification of at-risk individuals.

#### **1.4. Sub-Classification of Low Back Pain Disorders**

There has been much evidence recently that supports the idea that non-specific LBP is not a single entity and can be further sub-classified into homogenous subgroups that share similar, stable characteristics (Leboeuf-Yde, Lauritsen et al. 1997; Flynn, Fritz et al. 2002; Childs, Fritz et al. 2004; O'Sullivan 2005; Brennan, Fritz et al. 2006; Dankaerts, O'Sullivan et al. 2006; Dankaerts, O'Sullivan et al. 2006; Dankaerts, O'Sullivan et al. 2007). Previous research studies that have treated all non-specific LBP patients as a single, homogenous group, risk having their results 'washed out' due to potential differences between subgroups (Leboeuf-Yde, Lauritsen et al. 1997; Dankaerts, O'Sullivan et al. 2006). This washout effect may help to explain some of the equivocal findings related to characteristics of non-specific LBP patients in the literature (Leboeuf-Yde, Lauritsen et al. 1997; Brennan, Fritz et al. 2006) .

#### **1.5. Stabilization-based Exercise as an Intervention for Low Back Pain**

It is becoming widely accepted that patients who receive treatments that are matched to a sub-classification category have better outcomes than those receiving unmatched treatments (Fritz, Cleland et al. 2007). Most clinical guidelines for the treatment of LBP include some form of supervised exercise as an intervention (Airaksinen, Brox et al. 2006), however the appropriate prescription, optimal level of supervision, and dosing has been less well established. The purpose of this research is not to attempt to answer these larger questions. Exercise intervention for patients with LBP is an accepted part of physical therapy practice, and is included as a stand-alone first-line treatment or as an adjunct to manual therapy in most practice patterns (Hayden, van Tulder et al. 2005;

Ferreira, Ferreira et al. 2007). Therefore, it was decided to include a standardized exercise program as the intervention for this study.

In a systematic review, Hayden and colleagues (2005) found that the most effective exercise intervention strategy was to individually tailor a program to the patient, deliver it in a supervised format with regular follow-up with the therapist, and encourage patient adherence to the program in order to achieve high dosage. These authors also reported that exercise programs with an emphasis on muscle strengthening appeared to be most effective. Other research has investigated the response to stabilization-based exercise intervention in patients with low back pain, with a primary focus on identification of predictive factors for positive outcomes with this intervention (Hicks, Fritz et al. 2005). A decision was made to utilize an exercise intervention that was largely based on this previous work by Hicks and colleagues (2005). This progressive exercise program emphasizes strengthening of the trunk musculature, is relatively high intensity, and requires therapist supervision for progression and monitoring. The exercise program is described in further detail in Chapter 7.

## **1.6. Motor Control Patterns and Low Back Pain: Predisposing Versus Adaptive Factors?**

It is well known that motor control impairments occur with non-specific LBP. These are commonly considered to be secondary to pain (van Dieen, Selen et al. 2003), and are proposed to be adaptive and protective in nature (van Dieen, Cholewicki et al. 2003). Because of this premise, it has been suggested that no attempt should be made to normalize or correct these ‘adaptive’ motor patterns (van Dieen, Cholewicki et al. 2003; van Dieen, Selen et al. 2003; O’Sullivan 2005). Several research groups have suggested

that there is also a ‘maladaptive’ motor control impairment where the alteration in motor pattern is not protective, but instead results in provocation of pain and abnormal tissue loading (Burnett, Cornelius et al. 2004; McGill 2004; O’Sullivan 2005). In these cases, it is suggested that correction of the maladaptive motor pattern may be beneficial.

It should be noted, however, that regardless of the terminology used (‘adaptive’ versus ‘maladaptive’), the motor pattern in question has still previously been considered to be in response to some initial LBP or injury, and therefore both should essentially be considered to be adaptations of the motor control system to LBP. Since most prior research has utilized intact subject groups (those who already have a clinical presentation of LBP versus healthy controls), it is impossible to answer the question of whether alterations in motor control are predisposing or adaptive in nature. The presence of a dysfunctional motor control pattern in a healthy individual, may in fact predispose them to develop a non-specific LBP disorder for the same reasons that O’Sullivan’s ‘maladaptive’ subgroup is thought to perpetuate and worsen their disorder through faulty movement and control (O’Sullivan 2005).

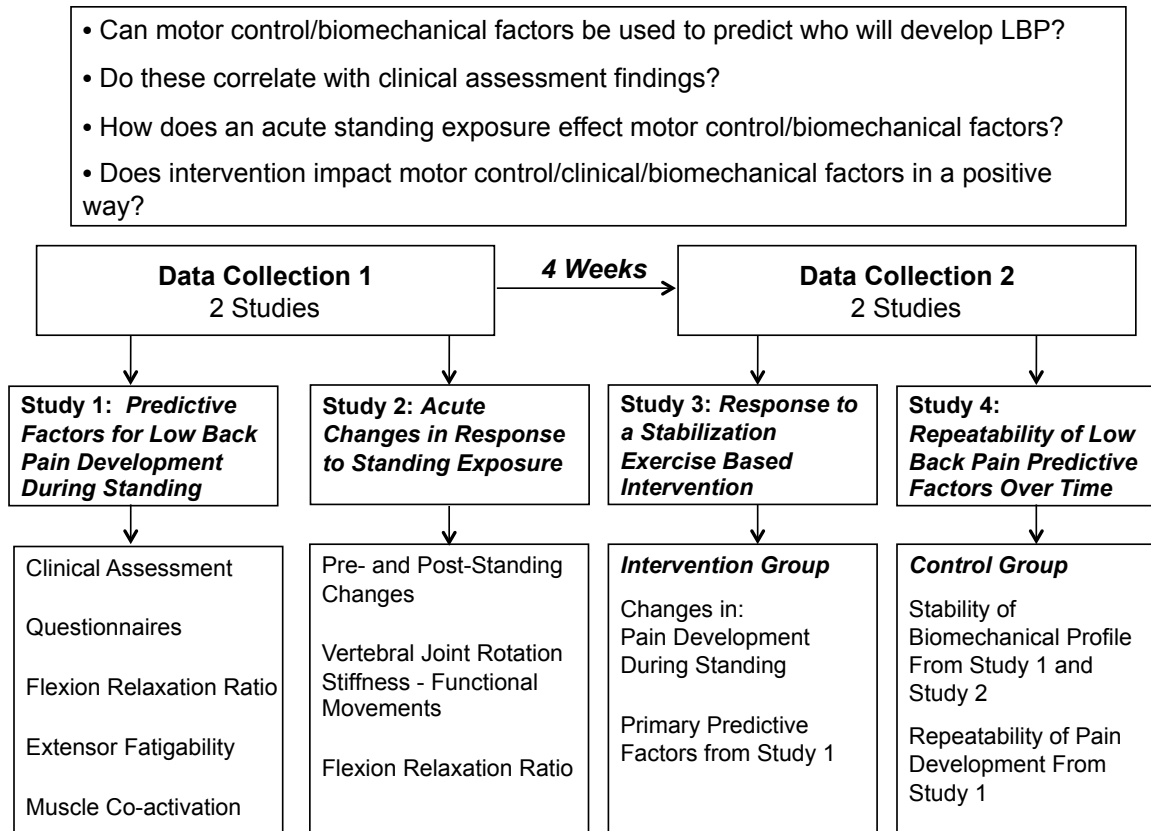
### **1.7. Central Themes and Hypotheses for This Thesis**

The primary theme for this thesis was to investigate whether there are motor control, clinical and/or biomechanical factors that pre-dispose individuals to develop LBP during a functional standing task, and whether these individuals could be identified *a priori* based upon these factors. Acute changes in these motor control and biomechanical patterns in response to a single prolonged standing exposure were also of interest. A secondary theme was to investigate the impact of a commonly utilized physiotherapy intervention of a trunk and hip muscle stabilization exercise program on pain



development, and the previously identified motor control and biomechanical factors. In addition, the stability of the previously identified motor control, clinical and biomechanical factors over time and with repeated standing exposures in the absence of intervention was investigated.

It should be noted that the terms ‘motor control pattern’ and ‘muscle activation pattern’ are used extensively throughout this work. ‘Motor control pattern’ has been defined as ‘the way in which muscles are activated, usually in a specific pattern to accomplish a controlled task...’ (McGill, Grenier et al. 2003). Within this document, ‘muscle activation pattern’ will refer to the actual (processed) EMG signal, whereas ‘motor control pattern’ will be used as a more general interpretation of the muscle activation recording. A flowchart presented in Figure 1.1 illustrates how the central themes and sub-questions relate to each other and to individual studies.



**Figure 1.1 Schematic diagram showing the central thesis questions and the four primary studies.**

**1.7.1. Study 1: Predictive Factors for Low Back Pain Development During Standing**

Hypothesis 1.1 Individuals who develop LBP will demonstrate positive findings on clinical assessment compared to non-LBP developers.

Hypothesis 1.2 LBP developers will demonstrate increased fatigability of extensors on an extensor endurance test and decreased Flexion Relaxation Ratio (FRR) in standing than non-LBP developers.

Hypothesis 1.3 Individuals who develop LBP will exhibit greater muscle co-activation during prolonged standing than those who do not develop LBP.

Hypothesis 1.4 Individuals who develop LBP during standing can be discriminated into causal and adaptive subgroups based upon motor control patterns; the causal group will exhibit altered motor control prior to development of symptoms, while the adaptive group will demonstrate a change in their motor control as symptoms develop.

***1.7.2. Study 2: Acute Changes in Response to Standing Exposure***

Hypothesis 2.1 There will be a decreased FRR during post-standing lumbar flexion in all participants, with a larger effect seen in LBP developers.

Hypothesis 2.2 There will be increased ipsilateral gluteus medius muscle activation (%MVC) in single leg stance (SLS) post-standing in all participants, with a larger effect seen in LBP developers.

Hypothesis 2.3 There will be decreased postural stability (as seen by centre-of-pressure excursion) in SLS post-standing in all participants, with a larger effect seen in LBP developers.

Hypothesis 2.4 LBP developers will demonstrate decreased contribution of abdominal musculature to Vertebral Joint Rotation Stiffness (VJRS) during functional activities compared to non-LBP developers.

***1.7.3. Study 3: Response to an Exercise-Based Intervention***

Hypothesis 3.1 LBP developers in the exercise intervention group are expected to have decreased subjective pain reports (VAS) during the second standing exposure compared with LBP developers who did not receive exercise intervention.

Hypothesis 3.2 LBP developers in the exercise intervention group are expected to no longer demonstrate positive findings on clinical assessment. LBP developers who did not receive exercise are expected to have no change in their clinical assessment findings.

Hypothesis 3.3 LBP developers in the exercise intervention group are expected to have decreased muscle co-activation during prolonged standing.

Hypothesis 3.4 Other motor control/biomechanical factors previously identified in Study 1 are expected to normalize in the LBP developer group after being exposed to exercise intervention. No changes are expected in the control groups.

***1.7.4. Study 4: Repeatability of Motor Control Patterns During Functional Movements and Prolonged Standing In People With and Without Standing-Induced Low Back Pain***

Hypothesis 4.1 Individuals not receiving exercise intervention will demonstrate good repeatability of clinical, motor control and biomechanical factors between the two data collections (ICC >.80).

Hypothesis 4.2 Individuals not receiving exercise intervention will remain in their respective pain development groups during the second standing exposure.

## **2. A GENERAL REVIEW OF THE LITERATURE**

### **2.1. Proposed Underlying Mechanisms of Low Back Pain**

Upon entering into any discussion about LBP, it is worth reviewing the prevailing theories that attempt to describe the causes of LBP. Despite the widespread prevalence and economic costs of LBP, the etiology of the disorder remains a subject of much debate and is not yet fully understood.

Insidious onset of LBP, in the absence of a specific traumatic event or injury, is a very common and problematic occurrence. The etiology of this type of LBP presentation is poorly understood, although there are several theories that have been proposed to address the issue. O’Sullivan (2005) has described the different theoretical models that have been proposed to explain the underlying mechanisms of non-specific LBP, and that form the basis for clinical intervention.

#### ***2.1.1. Patho-Anatomical Model***

The patho-anatomical model is based upon the premise that abnormal structural findings are causal to LBP, and treatment should be directed to address the structural defects (Bogduk 1995; Nachemson 1999). However, many structural defects (such as disc degeneration, disc herniation, spondylosis, scoliosis, and low-grade spondylolisthesis) have been found to be as common in asymptomatic people as in people with LBP, and the presence of structural abnormalities has been found to have poor correlation with pain and disability (Nachemson 1999; Giesecke, Gracely et al. 2004; Waddell 2004). The underlying hypothesis of the patho-anatomical model is that LBP arises from injury, which implies that there must be some mechanical disruption of the tissue (Kumar 2001).

### ***2.1.2. Peripheral Pain Generator Model***

The peripheral pain generator model is based on the hypothesis that a painful structure exists (the 'pain generator') which can be identified through the patient's history, anatomical demarcation of pain, clinical findings and through the use of anesthetic blocks (Schwarzer, Aprill et al. 1994; Bogduk 1995). Structures that can be sources of pain in the low back include the vertebrae themselves, through nociceptors located in the periosteum and blood vessels in the trabecular bone. The intervertebral disk is innervated only in the outermost portion of the annulus, however it has been shown to be a primary pain generator in chronic LBP through provocation discography (Schwarzer, Aprill et al. 1994). The dural portion of the nerve root contains nociceptors and can be a source for pain, as well as pain arising from direct irritation to the nerve root (Winkelstein and DeLeo 2004). The facet joint capsules are very highly innervated (Bogduk 1995), as are ligaments (Kumar 2001) and fascia. Muscle as a pain-generating source has been somewhat controversial (Bogduk 1995), as it is unlikely that individual muscle fibers contain nociceptors. However, there are nociceptors in the blood vessels and in fascia, and muscle spindles are very sensitive to mechanical stimuli (Waddell 2004). Perhaps the most important source of muscle pain arises from metabolic factors, as pH is lowered and local metabolites are concentrated in the presence of sustained muscle contraction (Fitts 1994; Kumar 2001; Waddell 2004).

Intervention based upon the pain generator model is aimed directly at the painful structure, generally through administration of anesthetic blocks, however there is little consideration for underlying causes and this treatment has not been shown to have long-term efficacy (Nachemson 1999).

### ***2.1.3. Neurophysiological Model***

The neurophysiological model postulates that there are disruptions in the pain processing pathway rather than damage or injury to peripheral structures or tissues (Giesecke, Gracely et al. 2004). This can be manifested as ‘central sensitization’, which is the prolonged excitability and responsiveness in spinal cord pathways (Zusman 2002), resulting in mechanical hyperalgesia (increased pain response to painful stimuli) and mechanical allodynia (increased pain response to non-painful stimuli) (Winkelstein and DeLeo 2004) as well as a reduction in pain threshold (Giesecke, Gracely et al. 2004). Central sensitization has generally been considered to be the result of prolonged pain input to peripheral A $\delta$  (Group III) and C-fibres (Group IV) afferents, however it can also result from descending pain modulation systems (inhibitory and excitatory) from the brain (Zusman 2002). These systems can be impacted by factors such as cognition, emotion, selective attention and pain behaviors arising from the forebrain (Zusman 2002).

In the neurophysiological model, the site of pain production is shifted from the peripheral structures to the central nervous system, however it must be emphasized that there still exists a biological, organic mechanism, although it is strongly influenced by psychosocial factors. Based upon this model, treatment needs to allow for ‘desensitization’ through gradual exposure to mechanical stimuli, as well as a psychological approach to address potentially ‘sensitizing’ cognitions, emotions, attention and behaviors (Zusman 2002).

### ***2.1.4. Psychosocial Model***

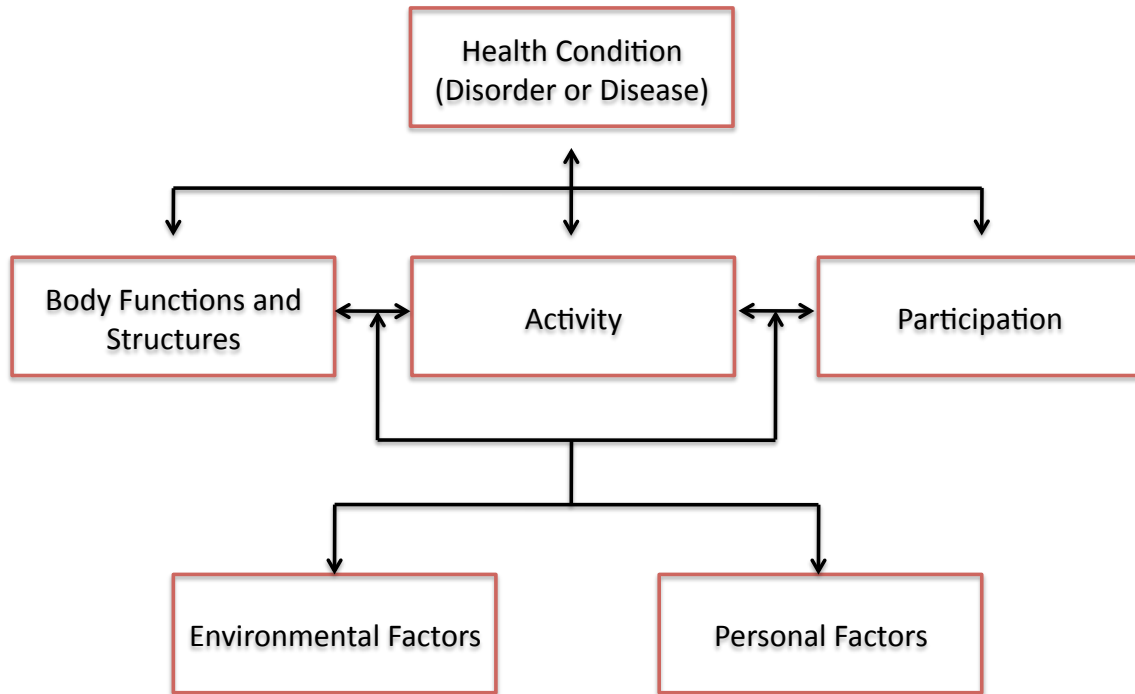
The psychosocial model emphasizes the impact of psychological and social factors on pain modulation. The complex interactions between dysfunction, pain, impairment and

disability are included in this model. Psychological factors such as negative thinking, fear and anxiety, and avoidance behavior have been associated with higher levels of pain and disability (Linton 2000; Zusman 2002; Waddell 2004).

Disability has been defined by the World Health Organization (WHO) as follows: “Any restriction or lack (resulting from an impairment) of ability to perform an activity in the manner or within the range considered normal for a human being (Waddell 2004).” The WHO framework of the International Classification of Functioning, Disability and Health (ICF) is being widely adopted by medical and rehabilitation professions worldwide (Stucki and Sigl 2003). In contrast to previous models describing the relationships between disease, impairment and disability, the ICF model allows for bi-directional interactions between health status, activity, and external factors and recognizes that a disease state may, in fact, be impacted by the individual’s participation in activities (or ‘disability’ level) (Stucki and Sigl 2003). Figure 2.1 shows this complex interaction between health status, structure, function, activity level, personal and environmental factors. In the ICF model, ‘body functions’ are the physiological and psychological functioning of body systems; ‘body structures’ are anatomical components of the body; ‘activity’ is the execution of a task or action on an individual level; ‘participation’ is the involvement in functioning on a societal level; ‘environmental factors’ represent extrinsic factors, such as aspects of the physical world and relationships, that impact an individual’s life; and ‘personal factors’ represent intrinsic factors, such as age, gender, and genetic makeup, that impact an individual (Stucki and Sigl 2003). Limitations in the body functions or structures are impairments, limitations in activity and participation



influence disability, and there is interaction among all of the components that influence health status, functioning and disability.



**Figure 2.1 Schematic of The World Health Organization’s International Classification of Functioning, Disability and Health (ICF) showing bi-directional interaction between factors adapted from Stucki and Sigl (2003).**

As the WHO has recognized with the current ICF model, the evidence is building that factors such as patient beliefs, distress, and illness behavior strongly influence the degree of low back disability (Waddell 2004), and especially the transition from acute to chronic disability (Linton 2000). Social factors such as the structure of the insurance and compensation systems, work and family stress, and cultural issues can also modulate pain and disability (Nachemson 1999). Linton (2000) suggests three major themes for psychological influence in low back disability: a cognitive theme including attitudes, pain and disability beliefs, and perception of health status; an emotional theme including

depression, anxiety and distress; and a social theme including aspects of work and family life. All of these themes relate to the behavioral domain by influencing coping strategies, pain behavior and activity patterns (Linton 2000). While the psychological component has compelling evidence to support it, there appears to be a very small sub-group of patients for whom these psychological factors form the primary basis for their disorder (O'Sullivan 2005).

#### ***2.1.5. Mechanical Loading Model***

The mechanical loading model is based on biomechanical factors such as effects of sustained postures, cumulative loading, exposure to vibration, high loading tasks, end-range loading of the spine, and repetitive loading tasks (Pope and Hansson 1992; Norman, Wells et al. 1998; Adams, Mannion et al. 1999; Kumar 2001; McGill 2004). Physical factors such as trunk muscle strength, muscle endurance, flexibility, ligamentous integrity, quality of motor control patterns, and individual anthropometrics are also considered to play an important role in the development of LBP in this model (Adams, Mannion et al. 1999; Abenhaim, Rossignol et al. 2000; McGill 2004; O'Sullivan 2005). Adams and colleagues (1999), in a prospective study of back pain in health care workers, identified factors that altered mechanical loading of the spine, such as decreased lordosis, lumbar hypomobility, a long back, and poor muscle endurance, that were more important for the prediction of 'serious' LBP, and were less important for 'trivial' LBP. Norman and colleagues (1998), in a large-scale study of automotive workers, found that LBP cases had significantly higher biomechanical loading than controls. The most important risk factors that emerged from their study included peak shear at the L<sub>4/5</sub> joint, peak torso

flexion velocity, hand forces over the course of a work shift, and either integrated lumbar moment or compression at L<sub>4/5</sub> over the course of a shift.

#### ***2.1.6. Bio-Psychosocial Model***

Clearly, there is evidence to support all of the above theories, and it seems likely that aspects from each have a role in the development and progression of LBP. A bio-psychosocial model has been proposed that incorporates a multi-dimensional approach taking into account each of the above factors. The bio-psychosocial model is built on elements of physical dysfunction, patient beliefs and coping strategies, patient's level of distress, illness behavior, and social interactions, all of which contribute to pain and disability (Waddell 2004). Physical dysfunction may arise in the absence of structural defects, may be in response to abnormal forces internal or external to the musculoskeletal system, and may include soft-tissue, neuro-physiologic and/or psycho-physiologic changes (Waddell 2004). Patients' beliefs about pain, damage, disease, personal responsibility, control and self-efficacy influence their behavior, and may dictate whether coping strategies are active or passive, fearful or catastrophising (Waddell 2004).

In the bio-psychosocial model, back pain is considered to be a physical problem, and pain is caused by nociceptive signals originating in the back. The clinical presentation, and the individual patient experience of LBP, however, is impacted and modulated by all of the other factors mentioned here.

Based upon a combination of findings from patient interview, radiological imaging, clinical examination and screening questionnaires, the potential contributions from structural abnormalities, pain generating structures, psychosocial factors, and mechanical loading history can be considered. Intervention within the bio-psychosocial framework

emphasizes the patient's role as an active participant in his or her own recovery, and includes addressing patient beliefs and pain/illness behaviors as well as pain relief and appropriate clinical management of the physical dysfunction.

## **2.2. Sub-Classification of Low Back Pain**

Given the complexity and overlapping theories regarding mechanisms of injury and causative factors, it is a very reasonable conclusion that there is not a single etiology for non-specific LBP. It is quite plausible that several mechanisms may have a concurrent role in the development and progression of non-specific LBP, and some mechanisms may dominate in certain subgroups of non-specific LBP patients. Most of the current sub-classification systems are based upon the mechanism models previously discussed.

While it is generally agreed that non-specific LBP should be sub-classified, there has been no widespread consensus on which sub-classification system is the most appropriate or 'correct' to use. Many of the most widely used sub-classification systems share similar features, and their validity and reliability is starting to be investigated more rigorously as clinicians are increasingly demanding this evidence to support their choice of clinical tools. The important thing to keep in mind is that whichever classification system is chosen, it is only useful if it guides intervention and improves outcomes in a clinically meaningful way (Brennan, Fritz et al. 2006).

Some of the commonly used classification systems include the Quebec Task Force Classification System (QTFC) (Abenhaim, Rossignol et al. 2000; Waddell 2004), Pain Pattern Classification (PPC) systems (Maitland 1994; McKenzie 1994; Werneke and Hart 2003), the use of 'Motion Signatures' (Marras, Parnianpour et al. 1995), Movement and

Control Impairment Classification (O'Sullivan 2005), and Treatment Based Classification (TBC) (Fritz, Cleland et al. 2007). There are many shared features among these systems, although the actual clinical implementation and proposed underlying theories are quite different. Each of these classification systems is described in the following sections for comparative purposes. For these research studies, a clinical assessment algorithm similar to what has been described in the TBC system was used.

### ***2.2.1. Quebec Task Force Classification System***

One classification system that has been widely used and studied is the Quebec Task Force Classification (QTFC) system (Abenhaim, Rossignol et al. 2000; Waddell 2004). The QTFC can be used to classify patients into categories based upon presence and location of pain, neurological signs, diagnostic imaging results, and surgical history (Werneke and Hart 2004). Screening is included for 'yellow flag' features (non-organic) that might suggest psychological and/or social factors, as well as 'red flags' that might suggest underlying medical or systemic problems (Waddell 2004). Red and yellow flags are listed in Table 2.1 and Table 2.2.

**Table 2.1 Red flags for serious spinal pathology (Waddell 2004)**

<ul style="list-style-type: none"><li>• Presentation age &lt; 20 years or &gt; 55 years</li><li>• Violent Trauma</li><li>• Constant, progressive non-mechanical pain</li><li>• Thoracic pain</li><li>• Previous history:<ul style="list-style-type: none"><li>• Carcinoma</li><li>• Systemic Steroids</li><li>• Drug abuse, human immunodeficiency virus (HIV)</li></ul></li><li>• Systemically unwell</li><li>• Unexplained weight loss</li><li>• Persisting severe restriction of lumbar flexion</li><li>• Structural deformity</li><li>• Erythrocyte sedimentation rate (ESR) &gt; 25mm</li><li>• Plain X-ray: vertebral collapse or bone destruction</li><li>• Cauda Equina Syndrome/ Widespread Neurologic Disorder<ul style="list-style-type: none"><li>• Difficulty with micturation</li><li>• Loss of anal sphincter tone or fecal incontinence</li><li>• Saddle anesthesia about the anus, perineum or genitals</li><li>• Widespread (&gt; one nerve root) or progressive motor weakness in the legs or gait disturbance</li><li>• Sensory level</li></ul></li></ul>
---

**Table 2.2 Yellow flags for psychosocial risk factors (Waddell 2004)**

<ul style="list-style-type: none"><li>• Beliefs that back pain is harmful or potentially severely disabling</li><li>• Fear-avoidance behavior (avoiding a movement or activity due to misplaced anticipation of pain) and reduced activity levels</li><li>• Tendency to low mood and withdrawal from social interaction</li><li>• Expectation that passive treatments rather than active participation will help</li></ul>
--

Disorders can be classified as specific or non-specific and staged as acute (< 6 weeks), sub-acute (6-12 weeks) and chronic (> 3 months). Anatomical location of pain plays a large role in grouping patients. Patients with only localized back pain are placed in group 1; those with symptoms radiating into the leg, but proximal to the knee are placed in group 2; patients with symptoms radiating distal to the knee are placed in group 3; and

patients with a positive straight leg raising test in addition to symptoms distal to the knee are placed in group 4 (Abenhaim, Rossignol et al. 2000; Waddell 2004).

The predictive value of the QTFC may be lessened because it lacks a true psychosocial assessment and does not take into account many physical examination factors (Werneke and Hart 2004). QTFC classifications at initial assessment for rehabilitation services have not been found to be predictive of pain intensity or disability status at discharge from rehabilitation, or one year post-discharge (Werneke and Hart 2004). Since LBP commonly presents in an exacerbation/remission or multiple recurrence pattern, it is also difficult to define it as acute or chronic within the timeframes used by the QTFC (Waddell 2004).

### ***2.2.2. Pain Pattern Classification System***

Models based on clinical signs and symptoms have been widely used for sub-classification and clinical management of non-specific LBP. These models are based upon biomechanical and patho-anatomical models, and involve identification of movement impairments, assessment of spinal segmental mobility, tissue response to mechanical stress through provocative testing and movement, as well as subjective descriptions of anatomical location and type of pain (Maitland 1977; Maitland 1994; McKenzie 1994). Clinical intervention is guided based on assessment of these signs and symptoms and is aimed at normalizing impairments. It must, of course be recognized that symptoms are not the same as mechanisms (Zusman 2002), and LBP is in itself not a disease, but is a symptom only (Waddell 2004).

Werneke and Hart's (2004) Pain Pattern Classification (PPC) system is a signs and symptoms model based upon McKenzie's 'centralization' phenomenon. Centralization is

the situation where lateral and/or distal symptoms are reduced and transferred to a more proximal and/or midline position in response to certain movements (McKenzie 1994; Werneke and Hart 2004). The PPC system has been used to classify patients into centralization and non-centralization groups, and has shown promise in predicting pain intensity and disability status at discharge from rehabilitation, as well as one-year post-discharge (Werneke and Hart 2004). When time-dependence was included, by using PPC to reclassify patients into centralization, non-centralization and partial reduction groups after multiple treatment sessions, the predictive value of status at one-year increased (Werneke and Hart 2004).

### ***2.2.3. 'Motion Signature' Classification System***

While many of the sub-classification systems are based upon subjective, self-reported measures such as location and intensity of pain, there have been documented biomechanical differences as well. A purely motion-based classification system was described by Marras and colleagues (1995) who used a Lumbar Motion Monitor (a custom triaxial electrogoniometer) to discriminate a healthy from a chronic LBP population, and to sub-classify the LBP group into patho-anatomical and QTFC categories based upon 'motion signatures'. They found that a model using eight variables correctly grouped 94% of subjects into either healthy or LBP categories, and a second eight-variable model was further able to correctly classify 70% of the LBP patients into 1 of 10 sub-categories. Higher order motion components (velocity and acceleration), and interactions between motion components, were found to be the most important variables in the determination of LBP and category (Marras, Parnianpour et al. 1995).



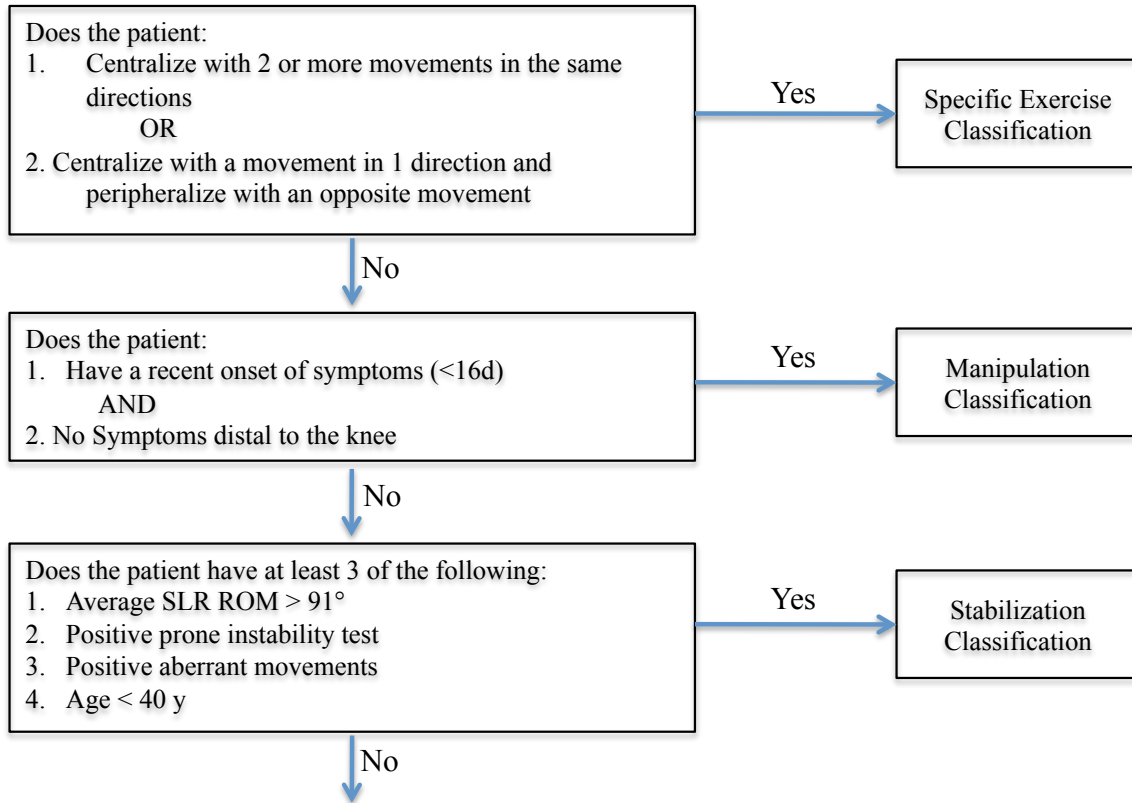
#### ***2.2.4. Movement and Control Impairment Classification System***

O'Sullivan (2005) has suggested a sub-classification system based on the bio-psychosocial model, that groups patients into adaptive and maladaptive motor control responses and is appropriate for guiding intervention. O'Sullivan proposes three broad sub-groups of patients in the LBP population. Group 1 includes patients who have an underlying pathological process driving the disorder, and have adapted their movement in an appropriate way as a protective response. Group 2 is the subgroup where a pain disorder is dominated by non-organic, psychological and/or social factors. Group 3 contains those patients who have either movement or control impairments as a 'maladaptive' response to their LBP, which in turn results in chronic, abnormal tissue loading, pain and disability. These patients have an inappropriate adaptation which, rather than being protective actually serves to worsen the condition (O'Sullivan 2005).

#### ***2.2.5. Treatment-Based Classification System***

While there is widespread agreement that homogeneous sub-groups exist within the non-specific LBP population; other issues such as which classification system should be applied, how this information should be incorporated into clinical practice, and whether or not it influences patient outcomes in a positive manner remain a matter of debate. Brennan and colleagues (2006) have addressed these issues through extensive clinical trials where patients have been assigned to treatment-based classifications and then randomly assigned to physiotherapy interventions designed to match the classification or physiotherapy treatment based on clinical practice guidelines. The treatment-based classification scheme utilized by these authors includes three groups, Manipulation,

Specific Exercise, and Stabilization. Figure 2.2 depicts the decision-making tree utilized for allocating patients to classification group.



Which subgroup does the patient best fit?

Manipulation		Stabilization		Specific Exercise	
Favoring	Against	Favoring	Against	Favoring	Against
<ul style="list-style-type: none"> <li>▪ Recent onset of Symptoms</li> <li>▪ Hypomobility with spring testing</li> <li>▪ LBP only (no distal symptoms)</li> <li>▪ Low FABQ scores (FABQW &lt; 19)</li> </ul>	<ul style="list-style-type: none"> <li>▪ Symptoms below the knee</li> <li>▪ Increasing episode frequency</li> <li>▪ Peripheralization with motion testing</li> <li>▪ No pain with spring testing</li> </ul>	<ul style="list-style-type: none"> <li>▪ Younger age</li> <li>▪ Positive prone instability test</li> <li>▪ Aberrant motions present</li> <li>▪ Greater SLR ROM</li> <li>▪ Hypermobility with spring testing</li> <li>▪ Increasing episode frequency</li> <li>▪ 3 or more prior episodes</li> </ul>	<ul style="list-style-type: none"> <li>▪ Discrepancy in SLR ROM (&gt;10°)</li> <li>▪ Low FABQ scores (FABQPA score &lt;9)</li> </ul>	<ul style="list-style-type: none"> <li>▪ Strong preference for sitting or walking</li> <li>▪ Centralization with motion testing</li> <li>▪ Peripheralization in direction opposite centralization</li> </ul>	<ul style="list-style-type: none"> <li>▪ LBP only (no distal symptoms)</li> <li>▪ Status quo with all movements</li> </ul>

**Figure 2.2 Clinical algorithm for sub-classification of LBP patients adapted from Fritz, et al. (2007)**

From the decision tree presented in Figure 2.2 it can be seen that this classification scheme shares many commonalities with others that have been previously discussed. For example, the Specific Exercise group is analogous to Werneke and Hart's (2004) Pain Pattern Classification system in the Flexion/Extension directions. The Manipulation group has some characteristics of the QTFC system (Abenhaim, Rossignol et al. 2000; Waddell 2004) in discriminating between symptoms radiating distal to the knee. The Stabilization group demonstrates some of the aberrant movement patterns that would be considered Movement Impairments in O'Sullivan's (2005) sub-classification system. This system also follows the bio-psychosocial model in that clinical findings including provocation tests, mechanical loading, patient history, and psychosocial factors are all accounted for. Patients with red flags indicating medical pathology, neurological signs indicative of nerve root compression, or positive diagnostic imaging findings such as fracture would not be classified within this system (Brennan, Fritz et al. 2006).

Some immediate and practical advantages to using this treatment-based classification system are that no special equipment is required (unlike Marras' LMM), minimal specialized post-professional training is required (unlike the McKenzie system), and the subgroups have been validated through independent studies (Flynn, Fritz et al. 2002; Childs, Fritz et al. 2004; Fritz, Whitman et al. 2004; Hicks, Fritz et al. 2005).

Classification into these subgroups has also been shown to have good inter-rater and intra-rater reliability (Fritz and George 2000; Fritz, Delitto et al. 2000; Hicks, Fritz et al. 2003; Heiss, Fitch et al. 2004; Fritz, Piva et al. 2005; George and Delitto 2005; Fritz, Brennan et al. 2006).

Research aimed at validation of this classification algorithm has been done recently, with independent studies demonstrating successful classification with a subsequently matched intervention for the manipulation group (Flynn, Fritz et al. 2002). When patients presented with 4 out of the 5 factors deemed to be most important, the positive likelihood ratio for improvement with spinal manipulation was 24, while the presence of 2 or fewer factors resulted in a negative likelihood ratio of 0.09, indicating the patient would almost certainly fail to improve with manipulation (Flynn, Fritz et al. 2002; Fritz, Cleland et al. 2007). To interpret these likelihood ratios, if the pre-test assumption is that 50% of LBP patients will improve with manipulation, the post-test likelihood of improvement with manipulation increases to 97% if they have 4 or more of the identified factors and decreases to 9% if they have fewer than 2 factors (Fritz, Cleland et al. 2007).

While patients have been sub-classified into the stabilization group with moderate success, the predictive factors used to date have not yielded the same high likelihood ratios for improvement with matched intervention as in the manipulation group (Hicks, Fritz et al. 2003). Four factors have been identified as important for the prediction of improvement with a stabilization exercise program. When 3 of these 4 factors were present, the positive likelihood ratio for improvement was only 4.0, indicating a pre-test to post-test shift in probability of improvement with stabilization exercises from 50% to 80% when 3 of the 4 factors are present, assuming a pre-test probability of 50% of patients improving with this intervention (Hicks, Fritz et al. 2003; Fritz, Cleland et al. 2007). Identification of those patients who would receive minimal benefit from a stabilization exercise program was stronger, with a positive likelihood ratio for *failure to improve* of 18.8 when 3 of the 4 factors were present (Hicks, Fritz et al. 2003; Fritz,

Cleland et al. 2007). This translates to a post-test probability that 95% of patients with 3 out of the 4 factors will fail to improve with stabilization exercises, when a pre-test assumption is made that 50% of patients will fail stabilization intervention. Better identification of factors to predict improvement with stabilization intervention for improved sub-classification into the stabilization sub-group has been identified as an important area for future research (Fritz, Cleland et al. 2007).

### **2.3. Stabilization Terminology: Clinical Versus Biomechanical Instability- Are We Talking About the Same Thing?**

Biomechanical stability of the spine has been hypothesized by Panjabi (1992) to be due to three subsystems: the passive subsystem, which includes the vertebrae, intervertebral discs, ligaments, joint capsules and passive components of the muscles; the active subsystem, which includes the muscles and tendons; and the neural control subsystem, which consists of feedback systems from mechano-receptors in the ligaments, tendons and muscles and the neural control centers. Panjabi (1992) defines spinal instability as ‘abnormally large intervertebral motions’ which can further irritate inflamed neural elements or cause abnormal deformations of the passive spinal structures. Biomechanical instability of the spine can therefore be caused by damage to the passive subsystem through mechanical injury (pathoanatomic model), impaired function of the active subsystem, due to disuse, degeneration, disease or injury, or control errors in the neural control subsystem (Panjabi 1992).

Panjabi (1992) asserts that a quantitative and sensitive measure of spinal instability is the size of the ‘neutral zone’ for a spinal motion segment. The neutral zone has been defined as ‘that part of the range of physiological intervertebral motion, measured from the

neutral position, within which the spinal motion is produced with a minimal internal resistance' (Panjabi 1992). In vitro work has demonstrated greater changes in neutral zone than in total range of motion with induced injury and mechanical fixation. Neutral zone ratio (neutral zone/total range of motion) is considered to be the parameter of choice for comparisons. In vitro work has shown the neutral zone ratio for the L<sub>5</sub>S<sub>1</sub> motion segment to be around 30% in each direction (flexion, extension, side bending and axial rotation) (Panjabi 1992). Panjabi (1992) cites multiple in vitro studies that have demonstrated neutral zone increases are early and sensitive indicators of mechanical injury. In vitro studies cannot include the active subsystem, therefore Panjabi (1992) refers to the neutral zone parameters obtained from these studies as 'passive neutral zones', and hypothesizes that 'active neutral zones', including the active musculature, should be smaller than those measured in vitro. There is, however, no way to directly measure the neutral zone in vivo, or replicate the minimal compressive loading present for these in vitro tests.

Panjabi (1992) defines clinical instability as 'a significant decrease in the capacity of the stabilizing system of the spine to maintain the intervertebral neutral zones within the physiological limits so that there is no neurological dysfunction, no major deformity, and no incapacitating pain'. Panjabi (1992) postulates that the size of the neutral zone, active muscle function and passive spinal function are inter-related. The size of the neutral zone will increase or decrease with injury or fixation of the passive structures, and with decreased or increased muscle force respectively (Panjabi 1992). This hypothesis has provided the basis for much of the existing literature that attributes increased muscle activation in LBP sufferers as an adaptive response to passive structure damage, and as a

response to ‘spinal instability’. This has led to a common management technique for ‘spinal instability’ of surgical fusion or external immobilization in an attempt to treat the passive substructure (Fritz, Cleland et al. 2007). According to Panjabi’s (1992) theory of the three subsystems for spinal stability, however, the passive structure is only one component, and stability can be affected by deficits in either the active or neural control subsystems as well. Because of the complex interplay among these subsystems, and the inability to measure neutral zone in vivo, this may not be a useful indicator of spinal stability clinically.

The terminology of ‘clinical spinal instability’ may be something we wish to move away from since it is not directly measurable in vivo, is a vague descriptor at best, makes patients fearful at worst, and does not necessarily serve to guide interventions that yield the best patient outcomes.

#### **2.4. Altered Muscle Activation in the Presence of Low Back Pain**

Differences in muscle activation patterns between people with LBP and healthy controls has been very well documented, although the interpretation of these differences remains a matter of debate (van Dieen, Selen et al. 2003). Results vary depending upon whether participants were sub-classified or treated as a homogenous LBP group. Findings also appear to be task-dependent.

A common finding has been the presence of generally increased trunk muscle activation in individuals with LBP (Lariviere, Gagnon et al. 2000; van Dieen, Cholewicki et al. 2003; Burnett, Cornelius et al. 2004; Silfies, Squillante et al. 2005; Dankaerts, O’Sullivan

et al. 2006; Pirouzi, Hides et al. 2006). This finding, and the prevailing theories to explain it, will be discussed in more depth later in this section.

There is evidence that LBP also impacts coordination of trunk and hip musculature as differences in muscle onsets, offsets and durations have been found between those with LBP and healthy controls during different tasks including single leg standing, and trunk flexion/extension cycles (Leinonen, Kankaanpaa et al. 2000; Hungerford, Gilleard et al. 2003; Ferguson, Marras et al. 2004).

Studies of fatigability in LBP patients versus control subjects have produced conflicting findings. Kankaanpaa and colleagues (1998) reported increased fatigability of the gluteus maximus and lumbar paraspinal muscles in LBP groups during an isometric back extension task. In contrast, da Silva (2005) found no differences in lumbar paraspinal muscle fatigue or strength between LBP and control groups during three different assessment protocols.

The Flexion Relaxation Phenomenon (FRP) is a period of myoelectrical silence of the lumbar extensor muscles when an individual stands in full flexion and has been confirmed in multiple studies of asymptomatic individuals (Paquet, Malouin et al. 1994). It has been proposed that the FRP is an indication of loads being shifted to the passive structures (ligaments), or being taken over by deeper muscles not accessible by surface EMG recording (Callaghan and Dunk 2002). FRP can be quantified through a ratio of trunk extensor muscle activation in the upright position to muscle activation in the flexed position, or the Flexion Relaxation Ratio (FRR) (Dankaerts, O'Sullivan et al. 2006). FRP has been shown to be absent or diminished in LBP patients, although this effect appears



to be achieved through a different muscle activation pattern (failure to relax the extensors versus increased activation of the extensors) depending upon the patient's clinical sub-classification (Paquet, Malouin et al. 1994; Dankaerts, O'Sullivan et al. 2006). Again, it is unknown whether this is purely an adaptive response to the pain condition or a contributory factor to developing the pain condition.

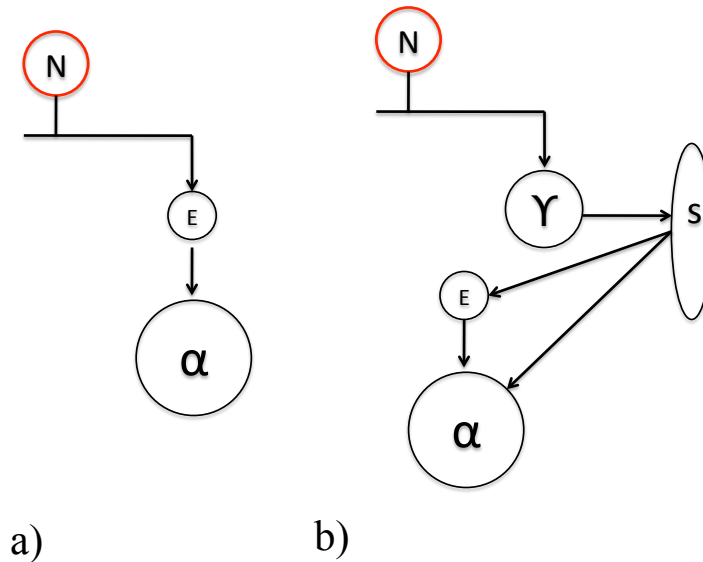
Few studies have investigated the quantifiable effects of physiotherapy interventions on muscle activation patterns in people with LBP. Leinonen (2000) did find changes in the muscle activation patterns of women with chronic LBP, specifically in timing and duration of gluteus maximus activity during trunk flexion/extension, following 5 weeks of physiotherapy intervention. While this lends support for the importance of including assessment and intervention aimed at the hip musculature in this patient population, the intervention lacked a detailed description, patients were not sub-classified, and these results may not be generalizable to other patient groups.

Agonist/antagonist co-activation has also been reported in LBP patients (van Dieen, Cholewicki et al. 2003; Dankaerts, O'Sullivan et al. 2006; Pirouzi, Hides et al. 2006), however not all studies have found this to be the case (Silfies, Squillante et al. 2005). The presence of increased agonist/antagonist co-activation appears to be highly task-dependent.

The finding of increased muscle activation in individuals with LBP has been very consistent. The two main theories that have been used to explain this are the Pain-Spasm-Pain Model and the Pain Adaptation Model, both of which will be described in further detail in the following sections.

#### ***2.4.1. Pain-Spasm-Pain Model***

As early as 1942, Travell (1942) proposed the pain-spasm-pain model. The premise behind this model is that pain results in muscle spasm, which results in more pain as part of a vicious cycle (Simons and Travell 1981; van Dieen, Selen et al. 2003). There are different proposed neural pathways for this model (Figure 2.3a) one involving the peripheral nociceptors projecting via excitatory interneurons onto alpha motoneurons at the segmental level, giving rise to both the perception of pain and the increased muscle activity present with spasm. The other proposed pathway (Figure 2.3b) has peripheral nociceptors influencing muscle spindle output via excitatory projections on gamma motoneurons (van Dieen, Selen et al. 2003). The muscle spindles then cause increased activity in the alpha motoneuron pool, again resulting in muscle spasm. In a review of the literature aimed at supporting or refuting this model, van Dieen et al (2003) were not able to locate studies that either provided unequivocal support for, or clear rejection of these proposed mechanisms.



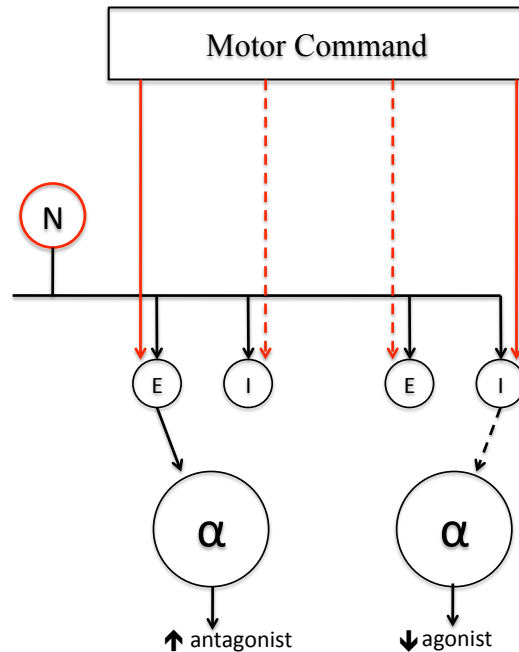
**Figure 2.3 a) The nociceptor (N) projects onto the alpha motor neuron ( $\alpha$ ) via excitatory interneurons (E), causing increased muscle activity. b) The nociceptor projects onto the muscle spindle (S) via the gamma motor neuron ( $\gamma$ ). The muscle spindle acts directly, and through excitatory interneuron projections, on the alpha motor neuron to increase muscle activity. Diagram adapted from van Dieen, et al. (2003)**

#### **2.4.2. Pain Adaptation Model**

Lund and colleagues (1991) proposed the pain adaptation model, based on the hypothesis that pain causes a reduction in agonist muscle activity, and an increase in antagonist muscle activity as a protective mechanism to decrease movement velocity and range of motion to prevent further damage to the passive structure (van Dieen, Selen et al. 2003). The proposed neural pathway for this model (Figure 2.4) is that peripheral nociceptors have both excitatory and inhibitory projections (via interneurons) on the alpha motorneuron. Excitability of these interneurons is under central nervous system control and whichever one dominates is dependent upon the descending motor command. The output of excitatory interneurons on the agonist alpha motorneuron and inhibitory interneurons on the antagonist motorneuron is suppressed resulting in decreased agonist

and increased antagonist activity (van Dieen, Selen et al. 2003). When there are not clearly differentiated agonist and antagonist muscles, as in activities where muscle groups are combining to provide postural stability versus a directional movement, the interpretation of this model becomes less clear.

The existing published studies that have investigated the pain-spasm-pain and pain adaptation models are largely based on animal studies, and artificially induced episodes of acute pain in humans through injection of noxious substances (van Dieen, Selen et al. 2003). Both of these models suggest that altered motor control patterns are adaptive in nature, while one (pain-spasm-pain) can be considered to be ‘maladaptive’ and have the effect of perpetuating the painful disorder, and the other is appropriately adaptive and serves to protect the system (pain adaptation). Neither model allows for the possibility that altered motor control might actually be a contributing factor for the initial development of LBP, and might in some cases be considered to be causal.



**Figure 2.4 Proposed Neural Pathway for the Pain Adaptation Model**

The nociceptor (N) projects onto alpha motor neurons ( $\alpha$ ) supplying the agonist and antagonist muscles via excitatory (E) and inhibitory (I) interneurons. Descending motor commands suppress excitation of the agonist and inhibition of the antagonist, while facilitating inhibition of the agonist and excitation of the antagonist, resulting in increased antagonist and decreased agonist muscle activity. Diagram adapted from van Dieen, et al. (2003)

### 2.4.3. Gaps in the Muscle Activation Literature

As has been pointed out already, most of the work that has been done in this area has used existing cohorts of individuals with clinical LBP compared with asymptomatic controls. This research design inherently limits the ability of the investigators to determine causal versus adaptive relationships. Prospective studies examining these motor control aspects in a quantifiable way are non-existent. Furthermore, sub-classification of LBP patients into homogeneous subgroups appears to be a necessity when studying the disorder of LBP, as it is clear that different subgroups have different

characteristics. While the premise that altered muscle activation patterns are adaptive in response to pain and/or injury and serve a protective function may be true for a subset of patients, there has been very little work done to establish a true cause and effect relationship. Therefore, it stands to reason, that there could also be a subset of patients who have developed an altered muscle activation pattern that has predisposed them to develop LBP.

Many of the tasks performed in previous investigations are not necessarily functional in design, and therefore may provide limited application of findings to the real world. Data collection for several tasks was conducted over the course of 2 to 7 seconds, and/or for just a few repetitions, while in reality most people function in a world where sustained postures and highly repetitive tasks are the norm, so insights into time-varying responses have not been possible.

Many studies have also not included the hip musculature in their analyses. The work that has included the hip has shown that it is a very important contributor to trunk and spine function, and is likely to also play a role in the development and response to LBP (Kankaanpaa, Taimela et al. 1998; Leinonen, Kankaanpaa et al. 2000; Nadler, Malanga et al. 2000; Nadler, Malanga et al. 2001; Nadler, Malanga et al. 2002; Gombatto, Collins et al. 2006).

The conflicting findings in the literature, especially regarding fatigability of hip and trunk muscles, flexion relaxation responses, and presence of co-activation warrant further investigation into these areas.

## 2.5. Some Methodological Considerations

### 2.5.1. Biomechanical Modeling

Biomechanical models must be used in order to calculate an estimate of the loading that occurs in vivo since it is practically infeasible, not to mention potentially unethical, to measure these variables directly.

Measures that can be obtained directly are the external forces acting on the system through the use of force transducers and gravitational forces when the mass of the system is known. Using rigid link segment modeling, and dynamic equilibrium analysis, the equations of motion (Equation 2.1 and Equation 2.2) can be applied to a system of segments to solve for the forces and moments on a specified segment.

$$\text{Equation 2.1} \quad \Sigma F = ma$$

$$\text{Equation 2.2} \quad \Sigma M = I\alpha$$

In these equations,  $F$  is force,  $m$  is the mass of the segment,  $a$  is the linear acceleration of the centre of mass of segment,  $M$  is moment,  $I$  is the moment of inertia about the centre of mass of the segment, and  $\alpha$  is the corresponding angular acceleration of the segment.

The applied force is measured through force transducers at the hands or feet, and the total mass of the body is known. Linear and angular acceleration are calculated through taking derivatives of positional data, obtained through motion capture. Segmental properties such as segment mass, moment of inertia, and centre of mass are estimated from empirically derived data contained in anthropometric tables, and are scaled to the individual subject. Assuming that there are no frictional losses and that the human body

consists of rigid segments, the equations can be solved up (or down) the chain to obtain the reaction forces and moments at the joint in question (Reeves and Cholewicki 2003).

The inverse dynamic analysis provides the joint reaction moment and forces only, which does not include the forces due to muscle activity, and therefore will underestimate the magnitude of the loading at the joint. Once the reaction moment is calculated, an anatomical model can then be applied to estimate the net forces acting on the joint through inclusion of the muscle force. In the simplest case, a single-equivalent muscle is used where a group of muscles, such as trunk extensors, are reduced to a single line of action and are assumed to have a single moment arm. While this will provide some estimate of the muscle force acting on the joint, it does not account for load sharing between muscles, changes in moment arm length with posture, or agonist-antagonist co-activation. It has also been shown that results from these types of models are very sensitive to the choice of moment arm length (Reeves and Cholewicki 2003).

A multi-muscle approach that is more anatomically detailed can be used to balance the net joint moment by partitioning the required force among many muscle force vectors. This results in a mathematically indeterminate problem where there are more unknowns than equations. An infinite combination of muscle forces could be used to achieve the same result. In order to resolve this, an EMG-assisted model can be used where muscle activation levels are measured through electromyography and input into the model. There are, of course, assumptions that must be made in order to use this approach. The cross-sectional area and maximum force-generating potential of the muscle must be known or estimated, and the instantaneous length and contraction velocity of the muscle must be accounted for. In order to accurately balance the joint moment, a 'gain' is usually set that



effectively scales the estimated force due to each muscle. This gain is usually set as a function of maximum muscle force per cross-sectional area (Reeves and Cholewicki 2003). It is not feasible to obtain EMG signals from every muscle, and many muscles are not accessible for EMG recording. Therefore, a common approach is to represent deep muscle activation states through recording surrogate superficial muscles that are accessible for surface EMG. This is a limitation due to differences between the estimated and true activation state for these deep muscles.

### ***2.5.2. Vertebral Joint Rotational Stiffness***

The movements and tasks that were performed in these studies were generally very low demand, with no external loading beyond body weight. Furthermore, participants were not exposed to extreme postures during any of the activities. While muscle co-activation was expected to occur, it was at a low level (generally < 10% MVC) and therefore would not add significantly to the loading experienced by the joint. It has been proposed that increases in muscle activation in the presence of LBP may be a protective mechanism that is present to 'stiffen' the lumbar spine in order to increase stability (van Dieen, Cholewicki et al. 2003). Therefore quantification of joint loading was deemed to be of less interest than potential differences in joint stiffness. Stiffness of the lumbar spine is an important factor as it reflects the ability of the system to resist an applied load or perturbation (Cholewicki and McGill 1995). The lumbar spine in particular relies on the active muscular component to enhance stiffness as it has been shown that the lumbar spine will buckle under small loads (90 N) when only the passive structures are included (Cholewicki and McGill 1996). The active, muscular contribution to rotational stiffness can be calculated for each vertebral joint, about each axis, through the use of

biomechanical models based on the principles previously described. These calculations yield the total active vertebral joint rotational stiffness (VJRS) as well as the relative stiffness contribution due to each individual muscle included in the model.

Calculations of muscle stiffness can be performed if the instantaneous muscle length and force production is known. A complex anatomical model originally developed by Cholewicki and McGill (1996) that has been used in multiple research applications over the past 20 years was employed. A cross-bridge bond distribution moment (DM) model was used to estimate muscle force and stiffness from muscle activations (input as linear-enveloped EMG signals) and posture (input as trunk angles). The external joint moment was calculated within the model through a rigid link segment inverse dynamic analysis. The muscle moment was estimated by an 18 degree of freedom lumbar spine model that balanced the external moment from the rigid link model against the predicted muscle force outputs from the DM model combined with the trunk angle data. For this work, the inverse dynamic calculations to determine the external moment as well as computation of the trunk kinematics were done outside of the model and were included as inputs to the DM muscle contraction and lumbar spine models. More detail about the specific biomechanical models used is provided in Section 3.4.2.

### ***2.5.3. The Subjective Nature of Pain Reporting***

Pain is a subjective variable, and the relationship between ‘pain’ and ‘discomfort’ has not been well established. Many clinical studies treat the two terms synonymously (Chapman and Dunbar 1998; Tait and Chibnall 2002; Schmader, Sloane et al. 2007), while the ergonomics literature uses ‘discomfort’ to describe such disparate concepts as musculoskeletal discomfort (Parakkat, Yang et al. 2007) as well as comfort ratings for

seating (Wilder, Magnusson et al. 1994). Discomfort assessment tools have been validated against pain assessment tools with highly significant correlations (Crane, Holm et al. 2005). For this work, the usage of the terms ‘pain’ and ‘discomfort’ in the low back are assumed to be equivalent descriptors.

There has been a great deal of research conducted on pain assessment and validation of pain assessment tools. Because pain perception is an inherently subjective phenomenon, it can be difficult to quantify in an objective way. A visual analogue scale (VAS) has been used extensively in both clinical and research settings. The VAS is almost always presented as a horizontal line, usually 100 mm in length, with end-point anchors of ‘no pain’ corresponding to the left hand side and ‘worst pain imaginable’ corresponding to the right hand side. The subject marks a point on the scale that indicates the intensity level of their pain. The VAS is scored by measuring the distance to the mark from the left hand side of the scale, and is reported in millimeters. When gradations are included on the VAS scale, its sensitivity has been found to be reduced (Gift 1989). The VAS has been shown to have concurrent and discriminate validity when compared with other established pain measures. Strong test-retest reliability has also been demonstrated (Revill, Robinson et al. 1976; Gift 1989).

The individualistic nature of pain perception was demonstrated by a study during which volunteers were exposed to an electrical stimulus and asked to report the ‘threshold of intolerable pain’ using a VAS. The range of VAS scores for ‘intolerable pain’ varied from 8 to 73 mm (Mader, Blank et al. 2003). This demonstrates the wide variation that may be seen between people in their perception of pain. However, people seem to be consistent within themselves in their perception of pain, as is shown by the strong test-

retest reliability of the VAS as well as other self-report pain rating scales (Bijur, Latimer et al. 2003).

The minimum clinically significant difference (MCSD) in VAS scores within individuals has been found to range from 9 mm (Kelly 1998) to 13 mm (Bijur, Latimer et al. 2003). Factors such as gender, cause or location of pain, and age have not been found to have any effect on the size of the MCSD in VAS score (Kelly 1998).

The self-reported VAS for pain has been extensively used both for laboratory and clinically based research. For this research, the VAS was used with an assumption of a within subject MCSD of 10 mm. Since repeated measurements of VAS were made, participants were not allowed to see their previously reported VAS scores as this has been shown to have some potential for skewing the scores (Gift 1989).

#### ***2.5.4. Adherence to Prescribed Exercise Interventions***

In the literature pertaining to exercise adherence, there are many definitions used to describe what ‘adherence’ is. Adherence has been based on criteria such as number of minutes spent exercising, number of sessions completed per week, and/or number of sessions attended, with different thresholds set that would define a participant as ‘being adherent’ to their prescribed exercise program (White, Ransdell et al. 2005).

For older adults, barriers to exercise have been shown to be more important than motivations in predicting exercise adherence (Forkan, Pumper et al. 2006). In contrast to the older population, extrinsic motivation has been shown to be important for exercise adherence in university students (Capdevilla Ortis, Ninerola Maymi et al. 2007).

University students were found to have improved adherence to an exercise program when

they were provided academic incentives for completing a 12-week exercise program (DeVahl, King et al. 2005). Activities that are undertaken within a variety of contexts (individual exercise, group-based exercise, formal sports) have been shown to be positively associated with increased exercise adherence in university age students (Burke, Carron et al. 2005). Exercise prescription with individualized weekly monitoring has also been found to be more effective at increasing adherence than exercise prescription alone (Keele-Smith and Leon 2003).

This research project involved prescription of an exercise-based intervention. The factors previously described were considered within the design of the intervention. Since the majority of the participants were recruited from the university population, it was assumed that they shared similar characteristics with the participants from the cited literature.

Participants were compensated for agreeing to participate in this research project, which served as extrinsic motivation. Participants also received a one-on-one session each week with the researcher to assess and progress their exercise program. In addition, the importance of adhering to the prescribed program was emphasized upon enrolling in the study.

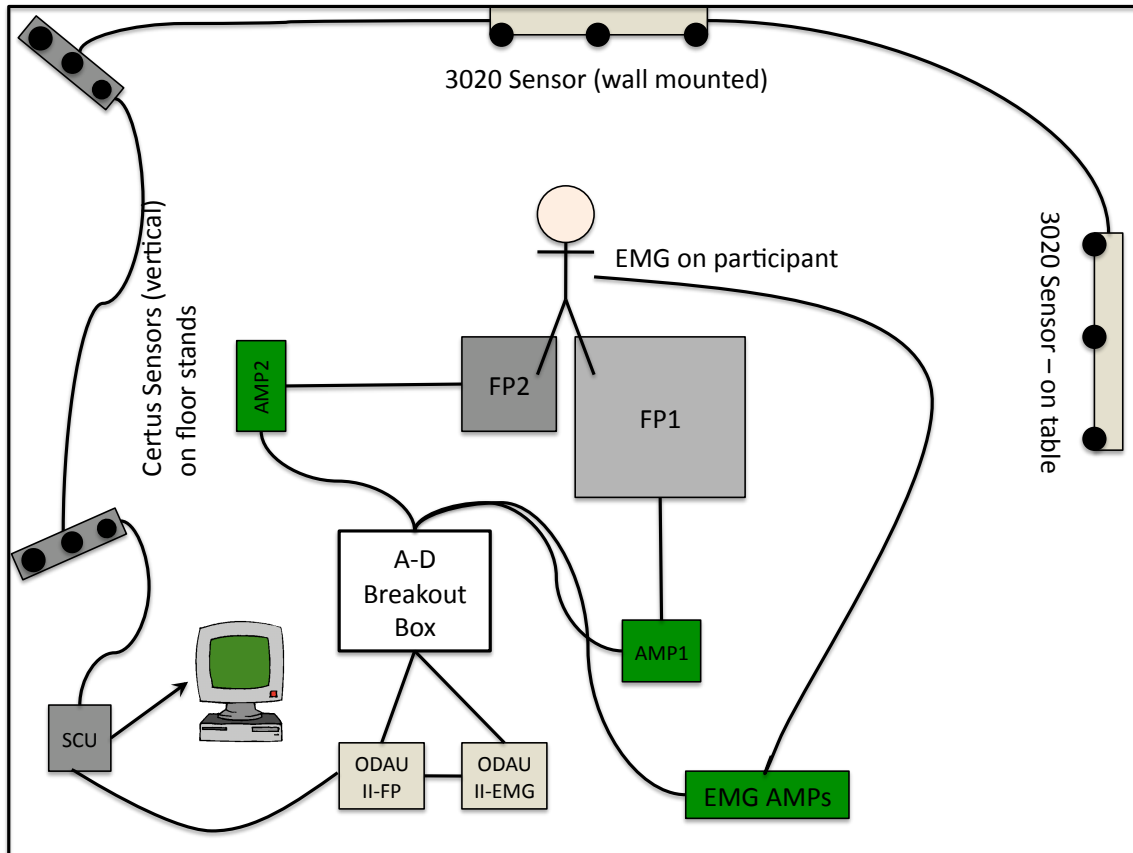
For the purposes of this research, participants were considered to be 'adherent' to their prescribed intervention program if they attended all scheduled one-on-one sessions, and completed their home exercise program 4 times per week (including the scheduled one-on-one session). This standard is well within the range of what has been considered to be acceptable for exercise adherence in the literature (White, Ransdell et al. 2005).

### **3. METHODS**

There were two separate biomechanics data collection days that occurred 4 weeks apart to allow for the intervention phase of the thesis. Both test sessions followed identical experimental protocols. The protocols employed are described in detail here. The first data collection day was used to complete Studies 1-2. Findings from the first data collection also served to determine participant groupings for Studies 3-4.

#### **3.1. Laboratory Preparation**

Prior to the participant's arrival on each collection day, there were some necessary procedures that were performed to prepare the lab for the data collection. The amplifiers for the analog signals were turned on a minimum of 1 hour prior to the participant's arrival, and this time was recorded, to allow for the electronics to warm-up. This was done to minimize the occurrence of electronic drift during the collection. All data were collected through the NDI ToolBench software (Northern Digital Instruments, Inc., Waterloo, ON, Canada). Analog signals from the two force platforms (Advanced Medical Technologies Inc., Newton, MA, USA) and electromyography amplifiers (AMT-8, Bortec, Calgary, Canada) were synchronized through two NDI Data acquisition units (ODAU II, Northern Digital Instruments, Inc., Waterloo, ON, Canada), and then with the motion capture data in the System Control Unit (SCU). A diagram of the laboratory set-up is shown in Figure 3.1.



**Figure 3.1 Laboratory Set-up and Hardware Arrangement**

### ***3.1.1. Drift Test on Force Platforms***

Because of the prolonged duration of this data collection, there was a one-time drift test performed on both of the force platforms (FP1, 90cm x 90cm, Model BP900900; FP2, Model OR6-7, 50x50 cm, Advanced Medical Technology, Inc., Watertown, MA, USA) to determine if electronic drift would be an issue. Data were collected continuously at 5 Hz for 2.5 hours beginning immediately after turning the amplifiers on. A shunt calibration value was used to convert the signals into SI units. Data were averaged over 20-second windows every 5-minutes, and comparisons were made between values at the beginning and end of the test, and at time intervals during the last hour of the test to determine the amount of drift in the force platform data. The force platforms were also

tested for their agreement and accuracy over a range of values by placing objects of known mass (a calibrated mass and the researcher's body mass) on them in each quadrant and on the centre. Values were averaged over the five regions of each force platform to obtain an average reading for each plate. Shunt calibration values were used to convert the resulting signals to SI units for comparison. Results are detailed in Section 4.1

### ***3.1.2. Motion Capture System Set-up***

An Optotrak Certus Motion Capture System (Northern Digital, Inc., Waterloo, ON, Canada) was used for these data collections. The Optotrak system has a reported 3D accuracy of up to 0.15 mm and a resolution of up to 0.01 mm at 2.25 m distance (<http://www.ndigital.com>). There were four sensors used for these data collections, two 3020 sensors and two Certus sensors. These were arranged as shown in Figure 3.1.

### ***3.1.3. Force Platform and Motion Capture Congruence***

Errors can arise if there are any discrepancies in the location of the center of pressure (COP) between the motion capture system and the force platform data. Therefore, prior to beginning data collection, a test was performed according to Holden and colleagues (2003) using the CalTester (C-Motion, Inc., Kingston, ON, Canada) to ensure that there was congruence between the two systems. The test involved using a calibrated rigid body (MTD-2, C-Motion, Inc., Kingston, ON, Canada) instrumented with 4 markers to apply a point load to the force platform. Using the CalTester software, the location of the tip of the device was calculated from the motion capture data through transformation of the marker coordinates. The location of the COP was also calculated from the force platform data. The locations of the force platforms in the global coordinate system were established through digitizing the corners of each force platform. A comparison was then



made between the two COP locations derived from the motion tracking and force platform systems to provide an estimate of the amount of error. Results for each of the two force platforms are detailed in Section 4.2.

#### ***3.1.4. Calibration of Motion Capture System***

The software used for these data collections was NDI ToolBench version 3.00.39 (Northern Digital Instruments, Inc., Waterloo, ON, Canada). Following the protocols within the software, the four Optotrak sensors were calibrated for the motion capture collection volume prior to each data collection with a calibrated cube instrumented with 16 infrared emitting diode (iRED) markers. A dynamic calibration procedure was done first to register the multiple sensors to a single coordinate system (the GCS), and a static calibration procedure was done to specify the location of the origin for that coordinate system. The collection volume was confined to the area over both force platforms. The root mean square (*rms*) error for both dynamic and static calibrations was recorded on the data collection sheets for each of the 86 data collection sessions. Collection proceeded if the *rms* error for the dynamic calibration was less than 0.50 mm. Average *rms* values are provided in Section 4.3. The Global Coordinate System (GCS) origin was placed at the left rear corner of the leftmost force platform, with the axes oriented according to International Society of Biomechanics (ISB) guidelines: *x* +ve anterior, *y* +ve upward vertical, and *z* +ve to the participant's right.

#### ***3.1.5. Calibration of Force Platforms***

After the force platform amplifiers were allowed to warm up for at least 60 minutes, they were zeroed at the amplifiers to remove any bias, and 10 second shunt voltage calibration and zero (unloaded platform) trials were recorded at 1024 Hz.

### ***3.1.6. Location of Force Platforms in the Global Coordinate System***

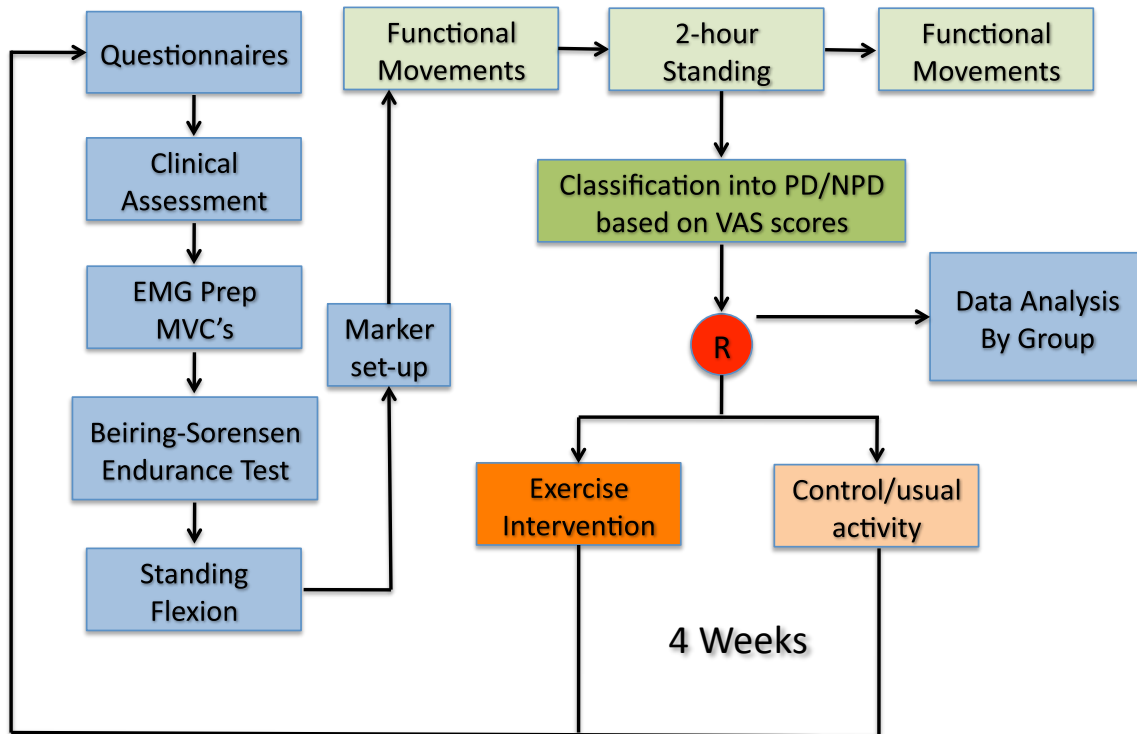
To achieve spatial synchronization between the force platforms and the motion data, the locations of the force platforms within the GCS were determined by digitizing the corner with a calibrated digitizing probe (Northern Digital Instruments, Inc., Waterloo, ON, Canada). The 3-dimensional coordinates for each corner in the GCS were recorded and stored as an ASCII file.

## **3.2. Experimental Protocol**

### ***3.2.1. Participant Recruitment***

Participants without any prior history of low back pain were recruited from the university and general community populations. Due to the extensive time requirements for participation in this study, participants were compensated with a \$50.00 stipend and a t-shirt. An attempt was made to recruit equal numbers of males and females with an age-range from 19 to 40 to represent a working-age population. Exclusionary criteria included any previous history of low back pain requiring any medical intervention or time off occupational duties for longer than 3 days, prior hip or lumbar surgery, employment in an occupation requiring static standing during the previous 12 months, and inability to stand for 2 hours. A preliminary power analysis with  $\alpha = 0.05$ , and  $\beta = 0.80$ , with an estimated standard deviation within subjects based on previous data of co-contraction of the bilateral gluteus medius muscles (Nelson-Wong, Gregory et al. 2008), yielded a sample size estimate of 5 participants required per group. Based on the previous study where 64% of participants developed LBP during the standing protocol, a conservative estimate of 50% of participants developing LBP was assumed. Based on these estimates participants were recruited until there were at least 10 males and 10 females in each of

the LBP and non-LBP intervention groups, which resulted in a total of 43 participants. A flowchart of the experimental protocol is shown in Figure 3.2.



**Figure 3.2 Flowchart of the experimental protocol for the two data collection days separated by a 4-week period.**

### ***3.2.2. Psychosocial and Activity Questionnaires***

It has been demonstrated that beliefs about activity, disease and work can contribute to the level of pain and disability experienced by an individual (Waddell 2004). Since the participants in this study were not a clinical population, it was decided that many of the questions on the standard disability questionnaires would not necessarily be appropriate. Therefore a compilation questionnaire of 26 questions was constructed from three separate questionnaires that are widely used in clinical practice and clinically based research. These included the Cognitive Risk Profile for Pain (CRPP) (Cook and DeGood

2006), the Survey of Pain Attitudes-b (SOPA-b) (Tait and Chibnall 1997), and the Fear Avoidance Beliefs Questionnaire (FABQ) (Waddell, Newton et al. 1993). All of these questionnaires are designed to be completed by the participant independently, and consist of statements that the participant rates their level of agreement with on an ordinal scale. The questions for the compilation were chosen because they could be considered in a hypothetical sense, as in how participants might feel if they were having a back pain problem, rather than an existing back pain problem. The questions used in the compilation questionnaire were presented to the participants as shown in Table 3.1, Table 3.2 and Table 3.3. It is recognized that the questionnaires have not been validated for use in this way, and also that comparisons to the literature cannot be made. However, it did enable the comparison between individuals that were involved in this study and provided some insight into their attitudes and beliefs regarding pain, injury and disability.

**Table 3.1 Questions taken from the Cognitive Risk Profile for Pain (CRPP)**

Strongly Agree	Moderately Agree	Slightly Agree	Slightly Disagree	Moderately Disagree	Strongly Disagree	Please rate your level of agreement with the following statements.
1	2	3	4	5	6	Feeling angry can increase my pain.
1	2	3	4	5	6	Pain can put me in a bad mood.
1	2	3	4	5	6	Exercise can help to manage pain.
1	2	3	4	5	6	My life should be pain free.

1	2	3	4	5	6	Worry can increase the pain that I feel.
1	2	3	4	5	6	My attitude and the way I think are an important part of how to manage my pain.
1	2	3	4	5	6	Stress in my life can make my pain feel worse.
1	2	3	4	5	6	Pain can make me feel depressed.

**Table 3.2 Questions from the Survey of Pain Attitudes – Brief (SOPA-b)**

Please rate your level of agreement with the following statements.	Very Untrue	Somewhat Untrue	Neither True nor Untrue/ or Does not Apply	Somewhat True	Very True
There are many times when I can influence the amount of pain I feel.	0	1	2	3	4
When I hurt, I want my family to treat me better.	0	1	2	3	4
Anxiety increases the pain I feel.	0	1	2	3	4
When I am hurting, people should treat me with care and concern.	0	1	2	3	4
It is the responsibility of my loved ones to help me when I feel pain.	0	1	2	3	4
Exercise and movement are good for a pain problem.	0	1	2	3	4

Just by concentrating or relaxing, I can 'take the edge' off my pain.	0	1	2	3	4
Medicine is one of the best treatments for chronic pain.	0	1	2	3	4
Depression increases the pain I feel.	0	1	2	3	4
If I exercise, I could make my pain problem much worse.	0	1	2	3	4
I believe that I can control how much pain I feel by changing my thoughts.	0	1	2	3	4
Often I need more tender loving care than I am now getting when I am in pain.	0	1	2	3	4
There is a strong connection between my emotions and my pain level.	0	1	2	3	4

**Table 3.3 Questions from the Fear Avoidance Beliefs Questionnaire (FABQ)**

Please rate your level of agreement with the following statements.	Completely Disagree	Moderately Disagree	Slightly Disagree	Unsure	Slightly Agree	Moderately Agree	Completely Agree
Physical activity might harm my back.	0	1	2	3	4	5	6
I should not do physical activities that (might) make my pain worse.	0	1	2	3	4	5	6
My work is too	0	1	2	3	4	5	6

heavy for me.							
My work might harm my back.	0	1	2	3	4	5	6

A physical activity questionnaire was utilized to ensure that there were not large differences between participants in their usual activity level. The activity scale that was chosen was the Minnesota Leisure Time Physical Activity Questionnaire (MPAQ) due to its high test-retest reliability (Folsom, Jacobs et al. 1986). This particular scale also includes a great variety of activity categories, many of which are specific to the Ontario region lifestyle (for example snow shoveling, ice skating, hunting and fishing). This activity scale is based upon self-report, and is generally used to record activity levels over a 12-month period. The scale was being used in this study to assess activity level as a risk-factor or confounding variable and also to ensure that activity levels did not markedly change for the control groups during the 4-week period in between data collections. Therefore, participants were asked to only consider the previous 4-week period when completing the questionnaire. The MPAQ was presented to the participant with instructions to mark ‘yes’ or ‘no’ for whether they had performed each listed activity within the previous 4 weeks. The researcher (ENW) then went through each activity that was marked ‘yes’ and questioned the participant in detail as to the week the activity was performed, the frequency and the duration. Each activity was provided a metabolic equivalent value from tabled data (Folsom, Jacobs et al. 1986), which was multiplied through by the number of minutes spent engaged in that particular activity during the month. These values were then summed to yield an overall MPAQ score for the month. The activity scale is included as Appendix A.

Participants were also asked to complete a short health history to ensure that they had no previous diagnoses that would exclude them from participating in the study. This health history was then gone over by the researcher (ENW) and the participant questioned in more depth about any potential areas for concern (ie; previous musculoskeletal injury). The health history is included as Appendix B.

Immediately upon their arrival at the lab, informed consent was obtained, and the participants completed the questionnaires and health history.

### ***3.2.3. Clinical Assessment***

After the questionnaires were completed, a basic physiotherapy clinical assessment, identical to what would be done in a clinical setting, was performed (by ENW) as a part of the experimental protocol. Areas that were assessed included active lumbar and hip range of motion, an assessment of lumbar segmental mobility, special tests for inter-segmental and general trunk stability, and tests for muscle endurance. The clinical assessment recording form is included as Appendix C.

An attempt was made to include only those assessment tools that have been shown to have reasonable reliability and validity, and that are commonly used during the examination of a patient with low back pain in a physiotherapy setting.

Active range of motion of the lumbar spine with observation of aberrant movement patterns has been shown to have moderate inter-rater reliability as measured by the Cohen  $\kappa$  statistic (95% confidence interval),  $\kappa = 0.60$  (0.47-0.73) (Hicks, Fritz et al. 2003). Five aberrant motions were included in this assessment and collapsed into one score: painful arc in flexion and on return from flexion in standing; presence of an



instability catch; Gower's sign ('thigh-climbing'); and reversal of lumbopelvic rhythm. There have not been validity studies performed on these measures (Hicks, Fritz et al. 2003).

Passive segmental mobility testing, performed through application of pressure to each spinous process in an anterior direction with the subject positioned in prone has been found previously to have poor inter-rater reliability for rating of mobility, with ICC values ranging from 0.03 - 0.37 (Maher and Adams 1994; Binkley, Stratford et al. 1995). Inter-rater reliability of assessment of pain provocation on segmental mobility testing was better, with ICC values ranging from 0.67 - 0.72 (Maher and Adams 1994). Despite the marginal reliability, this assessment tool was included as it is part of the standard physiotherapist practice. A 3-point grading scale was used similar to Hicks et al (2003) where each segment was classified as 'hypomobile', 'normal', or 'hypermobile'.

The prone instability test is a special test that is based on the premise that pain provocation with passive segmental testing that eases with muscle activation can be attributed to lumbar segmental instability. In this test, the subject was positioned in a prone position, with their torso supported by a table and their feet supported by the floor, with the lower extremities and extensor muscles fully relaxed. Applied posterior pressure directed anteriorly, (P-A) was applied to each lumbar spinous process, and assessed for pain provocation. If the subject reported pain at any level, they were then asked to raise their feet from the floor, thereby activating the extensor muscles, and the P-A pressure was repeated. A decrease, or elimination, of the pain was considered to be a positive test, and 'lumbar segmental instability' was identified at that level (Hicks, Fritz et al. 2003).

The prone instability test has excellent inter-rater reliability with a Cohen  $\kappa = 0.87$  (0.80 -

0.94), however this test also has not had validity studies conducted to link positive tests with actual presence of injury (Hicks, Fritz et al. 2003; Hicks, Fritz et al. 2005).

The active straight leg raise (ASLR) test was first described by Mens and colleagues (1999) as a diagnostic test for pregnancy-related posterior pelvic pain (PPPP). The test is conducted with the subject lying supine with legs straight and 20 cm apart. The subject was asked to lift each leg approximately 45° independently, while maintaining an extended knee, and to rate the level of difficulty on a 0 to 5 point scale from ‘not at all difficult’ (0) to ‘unable to do’ (5). The scores were then summed for the 2 legs to give a score ranging from 0-10. The authors suggest that any non-zero score be considered as a positive finding (Mens, Vleeming et al. 1999). Validity of the test has been established in the PPPP population with a Pearson’s Correlation Coefficient = 0.70 ( $P < 0.001$ , two-tailed test) with the Quebec Task Force Classification Rating, which was designed for use in the chronic LBP population (Mens, Vleeming et al. 2002). Test-retest reliability was found to have a Pearson’s Correlation Coefficient = 0.87 (Mens, Vleeming et al. 2001). These researchers suggest that a positive ASLR test indicates impairment in the ability to transfer loads between the lumbosacral spine and the lower extremities, and as such, might be useful in LBP populations other than the PPPP patient group (Mens, Vleeming et al. 2001; Hicks, Fritz et al. 2005).

The lateral bridge (‘side support’) test was used to assess endurance of the lateral flexors. This test has been described by McGill previously, and was found to have excellent test-retest reliability with ICC > 0.95 (McGill, Childs et al. 1999). In this test the subject was positioned on their side with legs extended as they lifted their hips off the floor so their weight was supported by their elbow and feet (Figure 3.3), and this position maintained

for as long as possible (McGill, Childs et al. 1999; Hicks, Fritz et al. 2005). Participants performed the test on each side and were allowed to self-select which side they started with. Encouragement was provided to the participants to maintain correct form during the test, and ‘failure’ was considered to be when the participant could no longer hold the position.



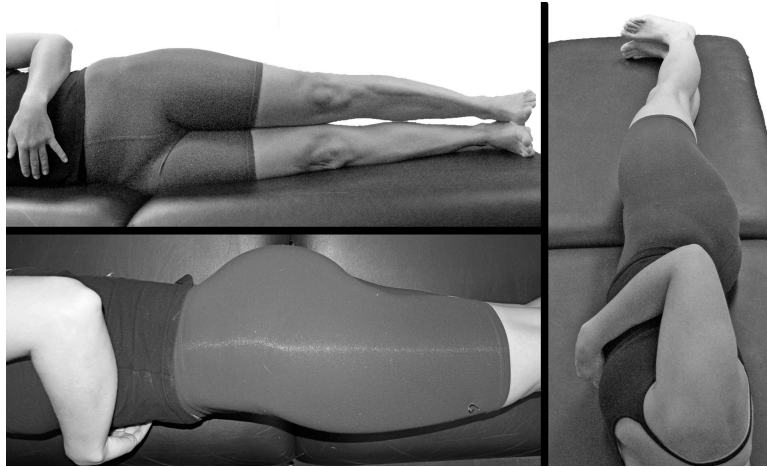
**Figure 3.3 Lateral bridge support test was performed to failure on each side.**

A novel test to assess trunk and pelvis control with active lower limb movement was also included. Due to findings of increased bilateral gluteus medius and trunk flexor-extensor muscle co-activation during prolonged standing in pain developers (Nelson-Wong, Gregory et al. 2008), we hypothesized that these individuals could be considered to be a ‘sub-clinical’ group. Therefore we expected these individuals would demonstrate positive findings on a physical therapy examination that included an assessment of trunk control during a challenge initiated by movement from the hip. To date there is little in the way of good screening tools to identify individuals who are predisposed to developing LBP. A low-demand test that assesses trunk control while performing a

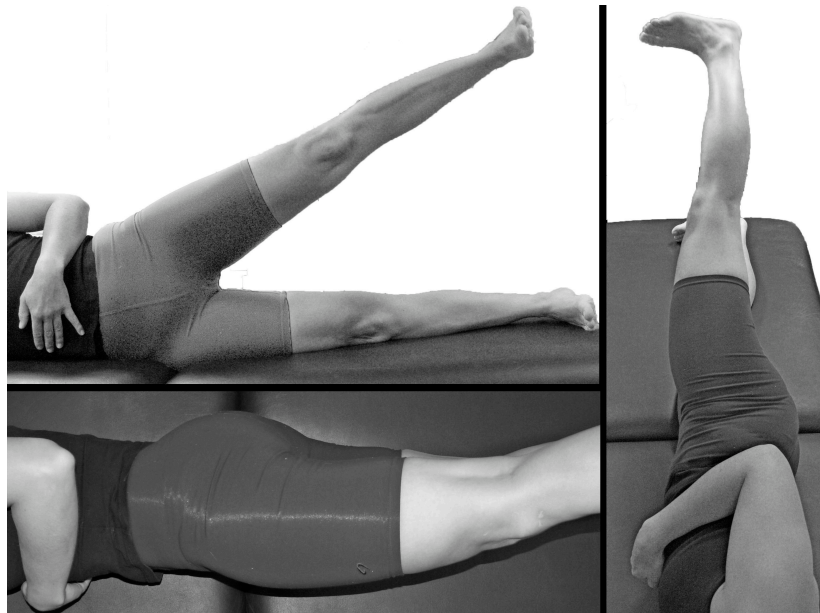
simple movement might be sensitive to predicting pain development during a low-demand functional activity. Therefore, we developed the Active Hip Abduction (AHAbd) test as a simple screening tool to provide a general assessment of an individual's ability to maintain trunk and pelvis alignment during lower extremity movement when placed in an inherently unstable position. The Active Hip Abduction Test (AHAbd) was performed with the participant positioned in sidelying, with lower limbs extended and aligned with the trunk and shoulders. Participants were asked to raise their uppermost lower limb towards the ceiling, without allowing their pelvis or trunk to tip forwards or backwards, and to rate the difficulty of this using the same scale as the ASLR test. In addition, the examiner rated the participant on a 4-point ordinal scale with '0' being no loss of trunk control, '1' being a minimal loss, '2' being a moderate loss and '3' being a severe loss of trunk control. Table 3.4 contains specific scoring criteria cues for the examiner. Figure 3.4 illustrates the starting position for the test. Figure 3.5 and Figure 3.6 illustrate varying levels of performance on the test. As with the ASLR, the participant's self-rated score was summed for both sides. For the examiner rated score, the worse score from the two sides was used.

**Table 3.4 Cues to differentiate test performance on the AHAbd test**

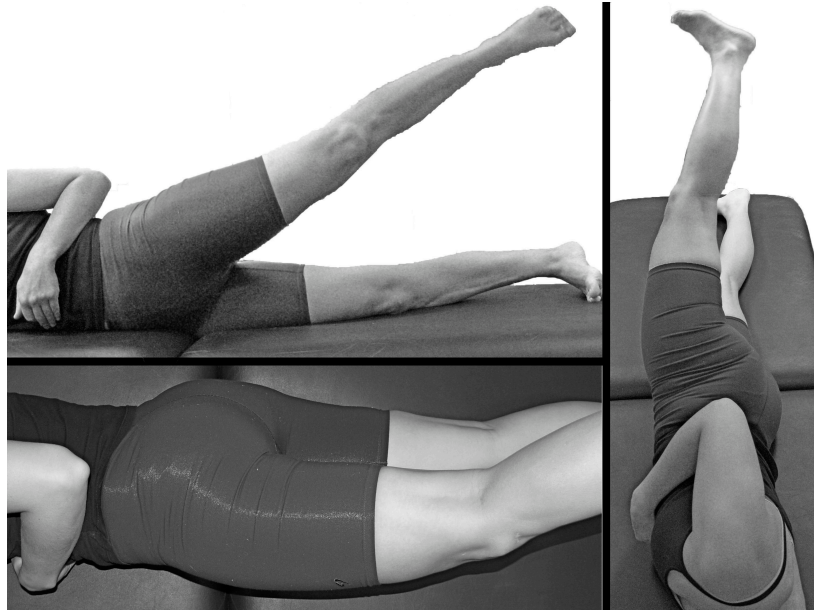
<b>Examiner Score</b>	<b>Cues For Examiner</b>
<p><b>Test Score = 0</b> (no loss of pelvis frontal plane)</p>	<p>Participant smoothly and easily performs the movement.  Lower extremities, pelvis, trunk and shoulders remain aligned in the frontal plane.</p>
<p><b>Test Score = 1</b> (minimal loss of pelvis frontal plane)</p>	<p>Participant may demonstrate a slight ‘wobble’ at initiation of the movement, but quickly regains control.  Movement may be performed with noticeable effort or with a slight ‘ratcheting’ of the moving limb.</p>
<p><b>Test Score = 2</b> (moderate loss of pelvis frontal plane)</p>	<p>Participant has a noticeable ‘wobble’, tipping of the pelvis, rotation of the shoulders or trunk, hip flexion and/or internal rotation of the abducting limb  Movement may be performed overly rapidly, and participant may or may not be able to regain control of the movement once it has been lost.</p>
<p><b>Test Score = 3</b> (severe loss of pelvis frontal plane)</p>	<p>Participant demonstrates the same patterns as in Test Score #2 with greater severity.  Participant is unable to regain control of the movement, and may have to use their hand or arm on the table in order to maintain balance.</p>



**Figure 3.4** Participant positioned with pelvis aligned in the frontal plane and lower extremities in line with the trunk. Top panel shows frontal plane view, bottom panel shows sagittal plane view from above, and side panel shows a sagittal/transverse plane view to allow a visualization of the axial rotation of the pelvis and trunk.



**Figure 3.5** Participant demonstrates good control of the pelvis and trunk during active hip abduction, resulting in an examiner score of 0. Note the lower limbs, trunk, shoulders and pelvis remain aligned in the frontal plane.



**Figure 3.6 Participant demonstrates poor control of the pelvis and trunk during active hip abduction, resulting in an examiner score of 3. Note the pelvis tips forward out of the frontal plane during the hip abduction movement, trunk and shoulders are starting to rotate, and abducting hip is internally rotated.**

A complete description of this test has been submitted to the *Journal of Orthopaedic and Sports Physical Therapy* and is currently in press.

#### ***3.2.4. Anthropometric Measurements***

Anthropometric measurements (Table 3.5) were performed using a standard, non-stretchable plastic tape measure and calipers. These were used for the purposes of scaling the segment parameters in the inverse dynamic model. Whenever possible, the same research assistant collected these measurements for consistency.

**Table 3.5 Anthropometric measurements**

Height in meters (tape measure on wall)	Weight in kilograms (confirmed with force platform)
Trunk Depth at Xiphoid (calipers)	Trunk Depth at Iliac Crest (calipers)
Inter-ASIS Distance (tape measure)	Trunk Width at Xiphoid Process (calipers)
Inter-PSIS Distance (tape measure)	Trunk Width at Iliac Crest (calipers)
Bilateral Width of Knee (calipers)	Bilateral Width of Ankle (calipers)
Bilateral Width of Forefoot (1 <sup>st</sup> -5 <sup>th</sup> metatarsal) (calipers)	Bilateral Thigh Length (Greater trochanter to lateral knee joint-line) (tape measure)
Bilateral ASIS to Greater Trochanter (tape measure)	Bilateral Leg Length (Lateral knee joint-line to lateral malleolus) (tape measure)

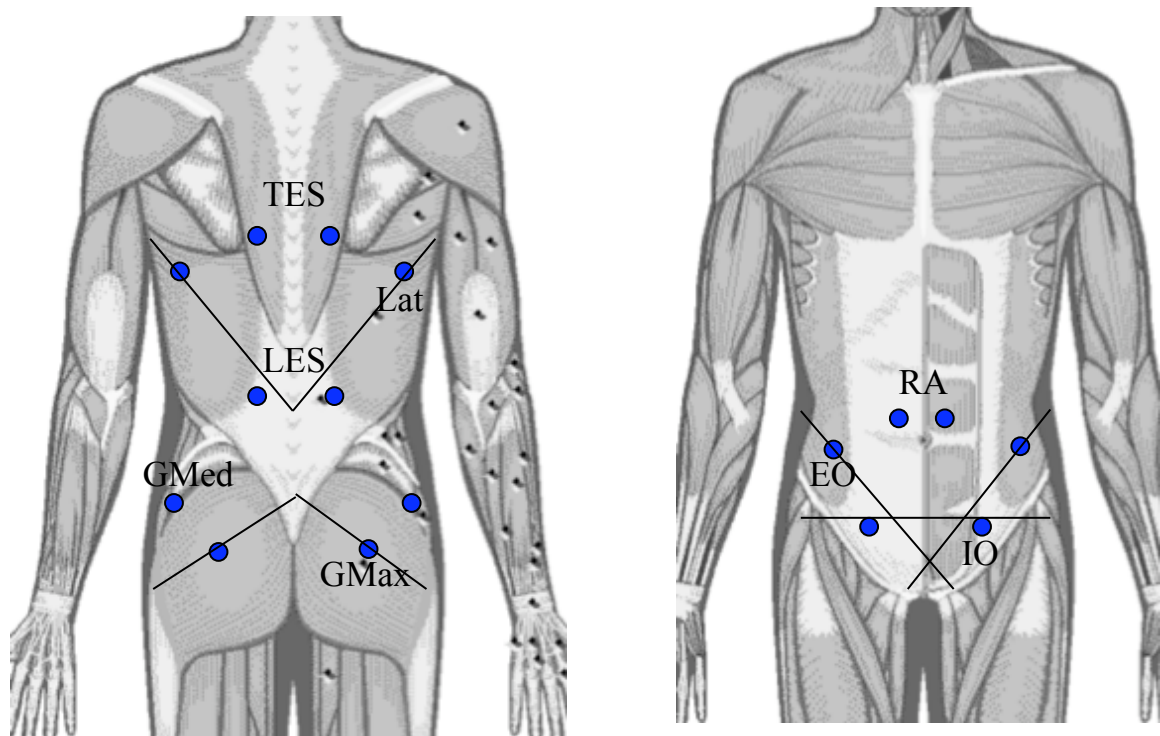
### ***3.2.5. Instrumentation for Electromyography***

Following the clinical assessment, participants had their skin prepped for electrode placement using standard laboratory protocols of shaving and light abrasion with rubbing alcohol. Disposable pre-gelled EMG Ag-AgCl electrodes (Blue Sensor, Medicotest, Inc., Olstykke, Denmark) with a 2 cm centre-to-centre inter-electrode distance were then applied over 8 bilateral muscle groups: Thoracic Erector Spinae (TES), Lumbar Erector Spinae (LES), Latissimus Dorsi (Lat), Rectus Abdominus (RA), Internal Oblique (IO), External Oblique (EO), Gluteus Medius (GMed), and Gluteus Maximus (GMax). All electrode placements were confirmed through palpation and manual resistance. Table 3.6 and Figure 3.7 describe and illustrate the muscles recorded from and electrode placements used.



**Table 3.6 Electrode placement for electromyography**

EMG Lead	Muscle	Electrode Placement
1-1 (R), 2-1 (L)	TES	5 cm lateral to T <sub>9</sub> spinous process (Callaghan, Gunning et al. 1998)
1-2 (R), 2-2 (L)	LES	Between midline and lateral aspect of body at L <sub>1</sub> level (Danneels, Cagnie et al. 2001)
1-3 (R), 2-3 (L)	Lat	Upper 1/3 of line connecting post shoulder crease and L <sub>1</sub> (Anders, Bretschneider et al. 2005)
1-4 (R), 2-4 (L)	RA	1 cm above umbilicus, 2 cm lateral to midline (Ng, Kippers et al. 1998)
1-5 (R), 2-5 (L)	IO	1 cm medial to ASIS, just beneath line joining ASIS's (Ng, Kippers et al. 1998)
1-6 (R), 2-6 (L)	EO	Below rib cage, along line connecting inferior costal margin and contralateral pubic rim (Ng, Kippers et al. 1998)
1-7 (R), 2-7 (L)	GMed	2.5 cm distal to midpoint of iliac crest (Zipp 1982)
1-8 (R), 2-8 (L)	GMax	½ way between greater trochanter and sacrum (Zipp 1982)



**Figure 3.7 Electrode placements for electromyography.**

Prior to collection of maximal voluntary contractions (MVC's), manual resistance was applied in each MVC position to allow the gains to be adjusted on the amplifiers to maximize signal-to-noise ratios, and also so participants could familiarize themselves with the procedures. Participants were asked to resist at approximately 80% of their maximum effort to ensure that saturation of the signals was not occurring. Once the amplifier gains were adjusted through this procedure, they were not changed again. Manual resistance was applied to obtain MVC's for EMG normalization with a 10 second ramped contraction in each of the described positions (Table 3.7). Ten-second resting trials were collected in supine and prone positions, with the participant instructed to relax completely, for determination of the resting activation level of the monitored muscles. Raw EMG signals were amplified (AMT-8, Bortec, Calgary, Canada; bandwidth = 10-1000 Hz, CMRR=115 db at 60 Hz, input impedance = 10 G $\Omega$ ) and collected with a sampling frequency of 2048 Hz using a 16-bit A/D card with a  $\pm 2.5$  V range.

**Table 3.7 Positions for maximum voluntary contractions (MVCs)**

<b>Muscle</b>	<b>MVC</b>
Lumbar Erector Spinae (LES)	Prone on table, legs strapped, hands behind neck, resistance applied to scapular area with examiner standing at head of table (Dankaerts, O'Sullivan et al. 2004)
Thoracic Erector Spinae (TES)	Same as LES, collected simultaneously (Dankaerts, O'Sullivan et al. 2004)
Rectus Abdominus (RA)	Supine on table, legs straight and strapped down, resisted curl-up through shoulders with examiner standing at head of table (Dankaerts, O'Sullivan et al. 2004)
Internal Oblique (IO)	Supine on table, legs straight and strapped down, crossed curl-up (example right shoulder towards the left, with resistance applied to the right shoulder tests the Left IO and Right EO together) (Dankaerts, O'Sullivan et al. 2004)
External Oblique (EO)	Tested simultaneously with contralateral IO (see above) (Dankaerts, O'Sullivan et al. 2004)
Latissimus Dorsi (LD)	Internal Rotation and Extension with Shoulder in 30° Abduction (Dark, Ginn et al. 2007)
Gluteus Medius (GMed)	Sidelying hip abduction
Gluteus Maximus (GMax)	Prone hip extension

### **3.2.6. Extensor Endurance Test**

The Beiring-Sorensen Test was used to assess endurance of the hip and back extensors as described by da Silva et al. (2005). The Beiring-Sorensen test was performed with the subject positioned prone with the trunk, above the iliac crests, extended over the end of a treatment table, with their legs extended and strapped in place on the table. The subject

then held their upper body unsupported and parallel to the table for as long as they could (Kankaanpaa, Taimela et al. 1998; McGill, Childs et al. 1999; da Silva, Arsenault et al. 2005; Hicks, Fritz et al. 2005). This test has shown excellent test-retest reliability, with ICC > 0.95 (McGill, Childs et al. 1999). Outcome measures included time to fatigue, rate of change of EMG *rms* amplitude, and EMG spectral analysis including rate of change of Mean Power Frequency (Kankaanpaa, Taimela et al. 1998; da Silva, Arsenault et al. 2005).

### ***3.2.7. Flexion in Standing Without Motion Capture***

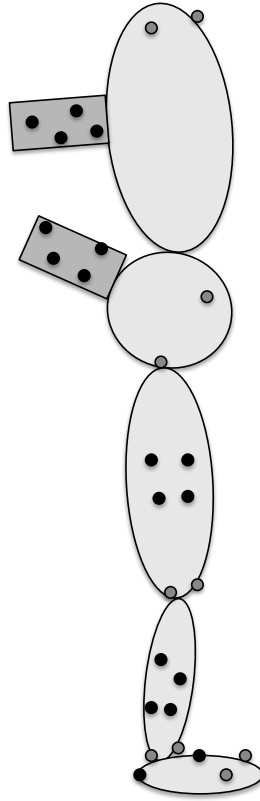
Participants were given a minimum of 10 minutes to recover following the extensor endurance test. Three repetitions of standing forward flexion were then performed with collection of continuous EMG. Participants were asked to stand quietly for several seconds to obtain a baseline EMG value in upright standing, and then bend forward from the hips into their maximum range of lumbar flexion while maintaining extended knees. They were asked to hold this position for several seconds and then return into upright standing. Flexion in standing without motion capture was included after the 4<sup>th</sup> data collection as the initial four participants noted that they felt impeded in their forward bending movement by the motion capture instrumentation. Therefore, forward flexion data without motion capture instrumentation is not available for Data Collection 1, for participants M001, M002, F001 and F002. FRR was calculated for these participants from the flexion in standing trials with motion capture instrumentation, and is reported in these results.

### ***3.2.8. Instrumentation for Motion Capture***

Following the endurance test, participants were instrumented with iRED markers using the Callaghan Spine Biomechanics Laboratory Standard Marker Set-Up for a three-dimensional Bottom Up Inverse Dynamic Model collection of kinematic data with the Optotrak Certus (NDI, Inc, Waterloo, ON, Canada) motion capture system. Circular adhesive ‘washer collars’ were used to adhere the iREDs to the participant’s skin (when possible), and shoes. Foam blocks were used when necessary to position markers so that they were visible to the motion capture sensors. Rigid fins were fashioned out of heavy foam core board, and were affixed to the participant’s sacrum and back at the mid-thoracic level with tape, over a layer of adhesive HypaFix dressing bandage (BSN Medical, Laval, QC, Canada) that was attached directly to the participant’s skin. Calibration markers were positioned over anatomical landmarks and were removed after a calibration trial in upright standing was collected. Tracking markers were used to track the segment’s position during the motion trials. Table 3.8 details the marker placement for this model and Figure 3.8 provides a schematic representation.

**Table 3.8 Placement of motion capture (iRED) markers**

<b>Strober 1 – Left Side and Pelvis</b>		<b>Strober 2 – Right Side and Thorax</b>	
1) 1 <sup>st</sup> Metatarsal * *	2) 5 <sup>th</sup> Metatarsal * *	23) 1 <sup>st</sup> Metatarsal **	24) 5 <sup>th</sup> Metatarsal **
3) Dorsum of Foot	4) Lateral Heel	25) Dorsum of Foot	26) Lateral Heel
5) Shank 1	6) Shank 2	27) Shank 1	28) Shank 2
7) Shank 3	8) Shank 4	29) Shank 3	30) Shank 4
9) Thigh 1	10) Thigh 2	31) Thigh 1	32) Thigh 2
11) Thigh 3	12) Thigh 4	33) Thigh 3	34) Thigh 4
13) Sacrum Fin 1	14) Sacrum Fin 2	35) Thoracic Fin 1	36) Thoracic Fin 2
15) Sacrum Fin 3	16) Sacrum Fin 4	37) Thoracic Fin 3	38) Thoracic Fin 4
17) Medial Malleolus *	18) Lateral Malleolus *	39) Medial Malleolus *	40) Lateral Malleolus *
19) Medial Knee *	20) Lateral Knee *	41) Medial Knee *	42) Lateral Knee *
21) Greater Trochanter *	22) Anterior Iliac Crest *	43) Greater Trochanter *	44) Anterior Iliac Crest *
* = calibration marker only	** = both calibration and tracking marker	45) Right Acromium *	46) Left Acromium *



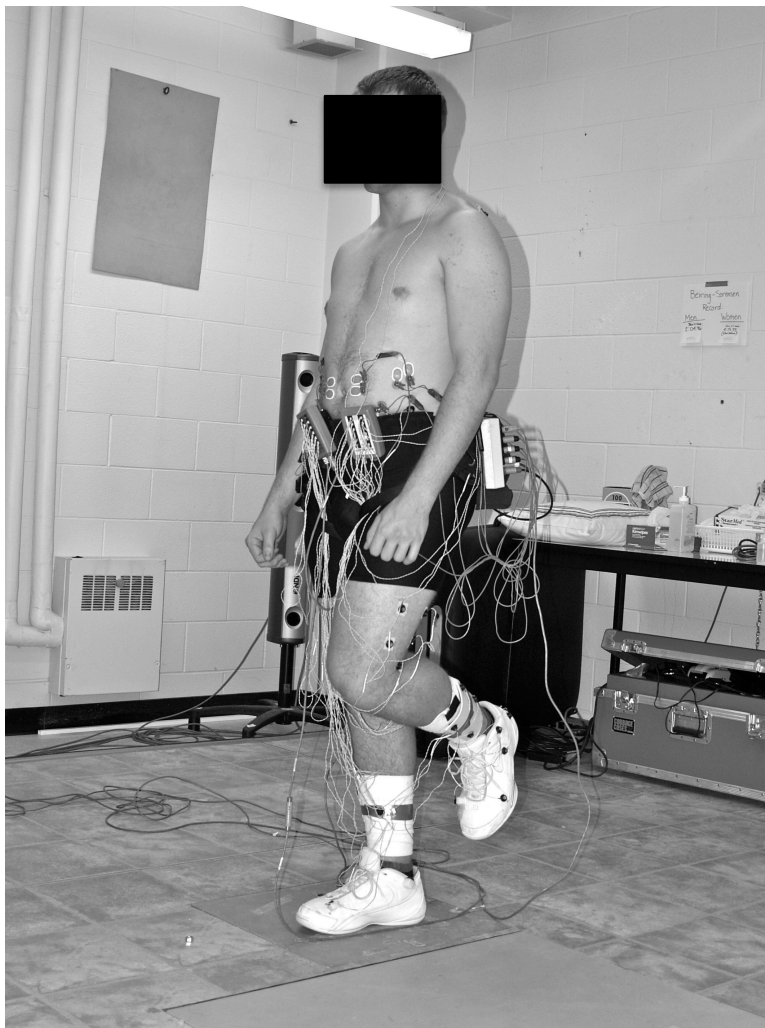
**Figure 3.8 Schematic showing iRED marker placement on figure. Calibration markers are shown in light gray.**

A 10-second calibration trial was performed with the participants in upright standing and was used to define the anatomical coordinate systems for each segment and to build a model template for each participant using Visual3D biomechanical modeling software (C-Motion, Inc., Kingston, ON, Canada). More detail is provided on these procedures in Section 3.4. Following the calibration trial, the markers designated as ‘Calibration Markers’ were removed from the participants as a measure to reduce the amount of instrumentation.

### ***3.2.9. Pre-Standing Functional Movements***

The participants were then asked to complete three different functional movements (single leg standing for 10 seconds on each side, forward flexion in standing, and

squatting) in blocks of five repetitions. These blocks were presented in randomized order to minimize the risk of order effects. Randomization was accomplished with a random number generator in Excel 2008 for Mac, version 12.1.7 (Microsoft Corp., Seattle, WA, USA). Kinematics, kinetics and EMG were collected during the performance of the functional movements. Since an attempt was being made to capture individuals' 'usual' movement patterns, participants were allowed to complete the tasks with minimal restrictions. For the single-leg standing (SLS), they were not given specific instructions on how to position the unloaded leg (Figure 3.9).



**Figure 3.9 Participant performing right single leg standing (RSLs)**



The instructions for the forward lumbar flexion were to bend forward as far as they could from the hips without bending their knees (Figure 3.10).



**Figure 3.10 Forward flexion in standing (with motion capture instrumentation)**

The instructions for the squats were to hold their arms out in front at 90° of shoulder flexion, and to squat down as far as they felt comfortable with the instrumentation over a count of 3-seconds and to return to upright standing at the same pace (Figure 3.11). They

were instructed to either let their heels remain on the floor or lift off as they would normally move if they were performing a squat.

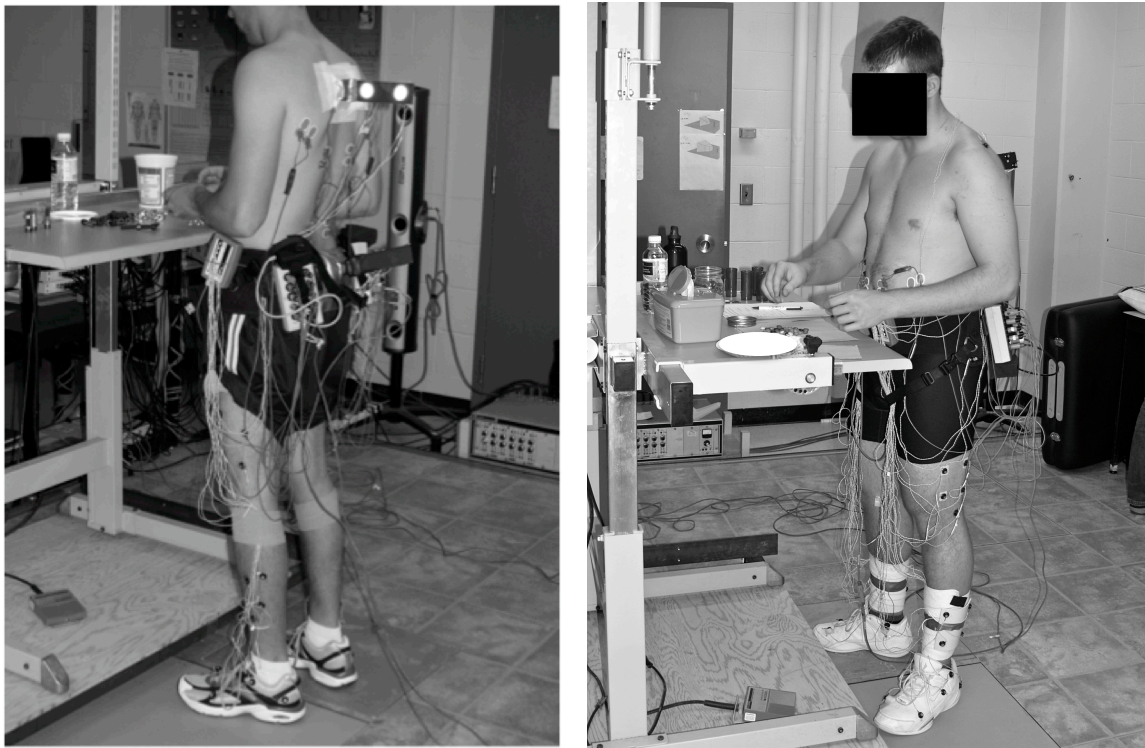


**Figure 3.11 Unloaded squats were performed pre- and post- prolonged standing.**

### ***3.2.10. Prolonged Standing Protocol***

Participants then entered into the prolonged standing task. The experimental set-up is shown in Figure 3.12. A work surface was positioned in front of the participant and adjusted to a height of 5-6 cm below the wrist of the participant in 90° of elbow flexion for light work (Kroemer and Grandjean 1997). Participants were instructed to stand ‘in

their usual manner as if they were standing for an extended period' with the only stipulations being that they could not rest their foot on the standing table frame, and they could not lean on the table surface with their upper extremities to support their body weight. They were also instructed to never have two feet in contact with the same force platform, and when a foot was in contact with the ground, it had to be in contact with its respective force platform (right or left). Another baseline VAS was collected just prior to the start of the 2-hour standing period to account for any discomfort that may have developed during the lengthy instrumentation period.



**Figure 3.12 Prolonged Standing Experimental Set-up**

Three different tasks were performed to simulate light occupational activities. These included a 'sorting' task, where participants were provided with an assortment of candy and instructed to sort it by type and color; a small object 'assembly' task that involved

assembling and disassembling a group of bolts, lock-washers, flat washers, and nuts; and a task termed ‘boredom’ where participants were asked to stand without any activity and were not interacted with by members of the research team. This was included in an attempt to assess the effect of distraction on participants’ pain ratings, as it was felt that participants might report different VAS scores if they were engaged in an activity versus being bored. Tasks were presented in a semi-random block fashion using a random number generator, with 30-minute blocks for each task. There were two blocks of boredom, and task order was a partially controlled randomized design in that two boredom blocks could not be adjacent to each other. EMG, kinematic and force platform data were collected continuously for the 2 hours of standing in 15-minute blocks with sampling frequencies of 2048 Hz, 32 Hz, and 1024 Hz respectively.

### ***3.2.11. Visual Analog Scale (VAS) Reporting***

Participants who reported a non-zero VAS score (average  $1.85 \pm 0.71$  mm) following instrumentation had this value subtracted as a bias from the remaining VAS scores collected. VAS was collected every 15 minutes during the 2-hour standing period for a total of 9 VAS scores including the baseline measure.

Participants were classified into PD and NPD groups based upon their reported LBP scores on the VAS. Because the goal of this study was to induce pain in previously painfree individuals, a threshold VAS score was required to separate participants into PD or NPD categories. Studies investigating criteria for Minimally Clinically Important Difference (MCID) scores for VAS have been conducted across a wide range of diagnoses and populations and have resulted in a large range of MCID values. Typically MCID scores are used to detect improvement in symptoms in response to treatment.

Hagg and colleagues (2003) investigated the MCID for both improvement and deterioration in VAS in LBP patients. They found the MCID for patients to report improvement in their LBP was 15 mm, while the MCID for patients to feel their LBP symptoms had worsened was only 8 mm. While MCID is useful for investigating response to treatment, Minimal Detectable Change (MDC) might also be useful for investigation of perceived pain increases in an induced pain model. MDC for VAS score at the 95% confidence interval was calculated using Equation 3.1 (Kovacs, Abraira et al. 2008).

**Equation 3.1**

$$\text{MDC} = 1.96 * \sqrt{2} * (\text{SEM})$$

where SEM is the standard error of the measurement and was calculated as the square root of the within subject variance (Kovacs, Abraira et al. 2008). Using this method, the MDC for this sample was calculated to be 5.94 mm. It has also been suggested that individuals with less severe pain conditions may have lower MCID values than those with more severe pain conditions (Stratford, Binkley et al. 1998). Based on the low calculated MDC value, the MCID for worsening LBP symptoms in a clinical population reported by Hagg et al. (2003), and the relatively low-level pain inducing stimulus used in this study, the decision was made to use a relative increase of 10 mm on VAS as the cut-point to categorize participants in this study as PD or NPD.

**3.2.12. Post-Standing Functional Movements**

The functional movements performed prior to the prolonged standing trial were repeated at the end of the 2-hour standing period, again in block-randomized order. A 10-second

quiet standing period was then collected to use as a second trial for detection of baseline noise levels in the EMG in order to account for potentially changing conditions within the laboratory environment during the lengthy data collection period.

### **3.3. Data Collection and Signal Processing**

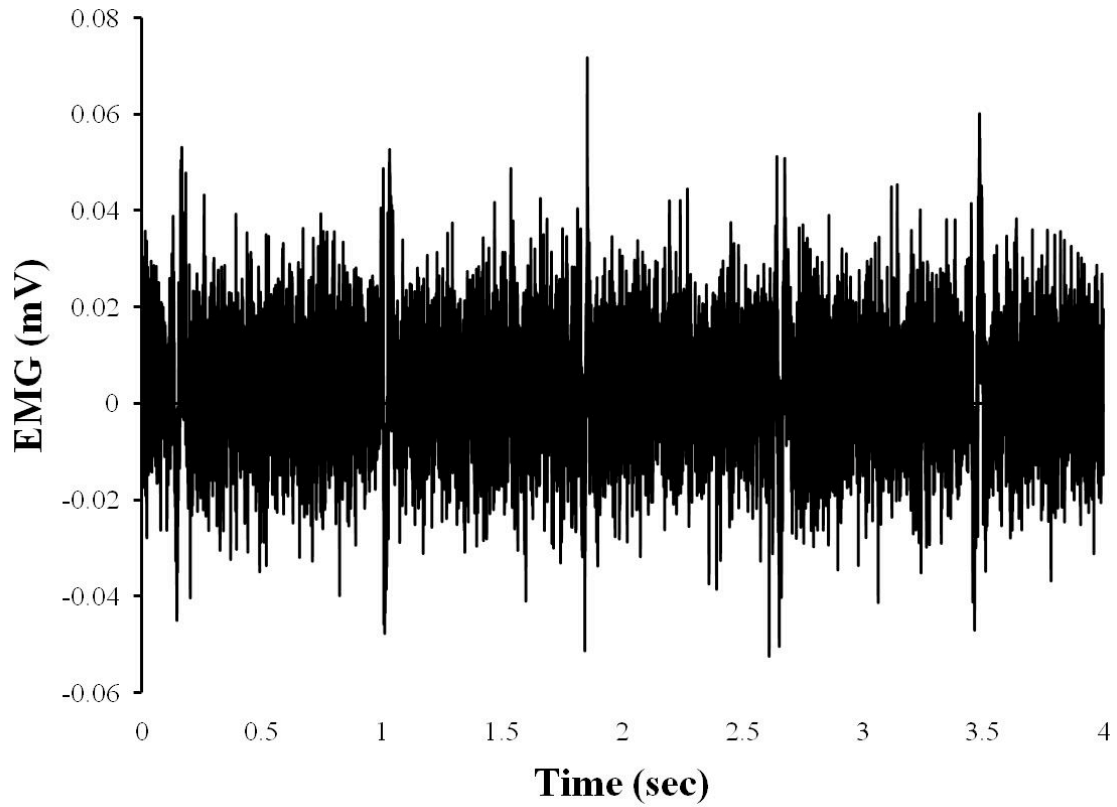
EMG data were collected at a sampling frequency of 2048 Hz, force platform data were sampled at 1024 Hz, and kinematic data were sampled at 32 Hz. Signal processing was done through the use of custom programs written in Matlab R2008a, version 7.6.0 (The Mathworks, Inc., Natick, MA, USA). All data were down-sampled to 32 Hz post-processing in an effort to make the volume of data more manageable while being sufficient to maintain signal integrity of the reduced frequency content processed signals following filtering.

#### ***3.3.1. Spectral Analysis and Filtering of Electromyography Signals***

Due to the low-level demand of the prolonged standing task, and the resulting low amplitude EMG signals, fast fourier transforms (FFTs) were done using KinAnalysis (University of Waterloo, Waterloo, ON, Canada) on each EMG channel for the pre- and post-protocol quiet standing trials to identify the frequency content of any electrical noise. Because cross-correlations were going to be used for the data analysis, it was important for any periodic noise to be removed (Nelson-Wong, Howarth et al. 2009). The presence of electrocardiogram (ECG) contamination, 60 Hz electrical noise, and noise at other frequencies (ie; high frequency noise) was noted for each channel, and the worst case out of the two quiet standing trials was used to determine the filtering to be applied to that channel. Because each channel did not contain the same contamination (ie; from

ECG), it was felt that this customized approach was preferred to minimize the filtering applied to each channel.

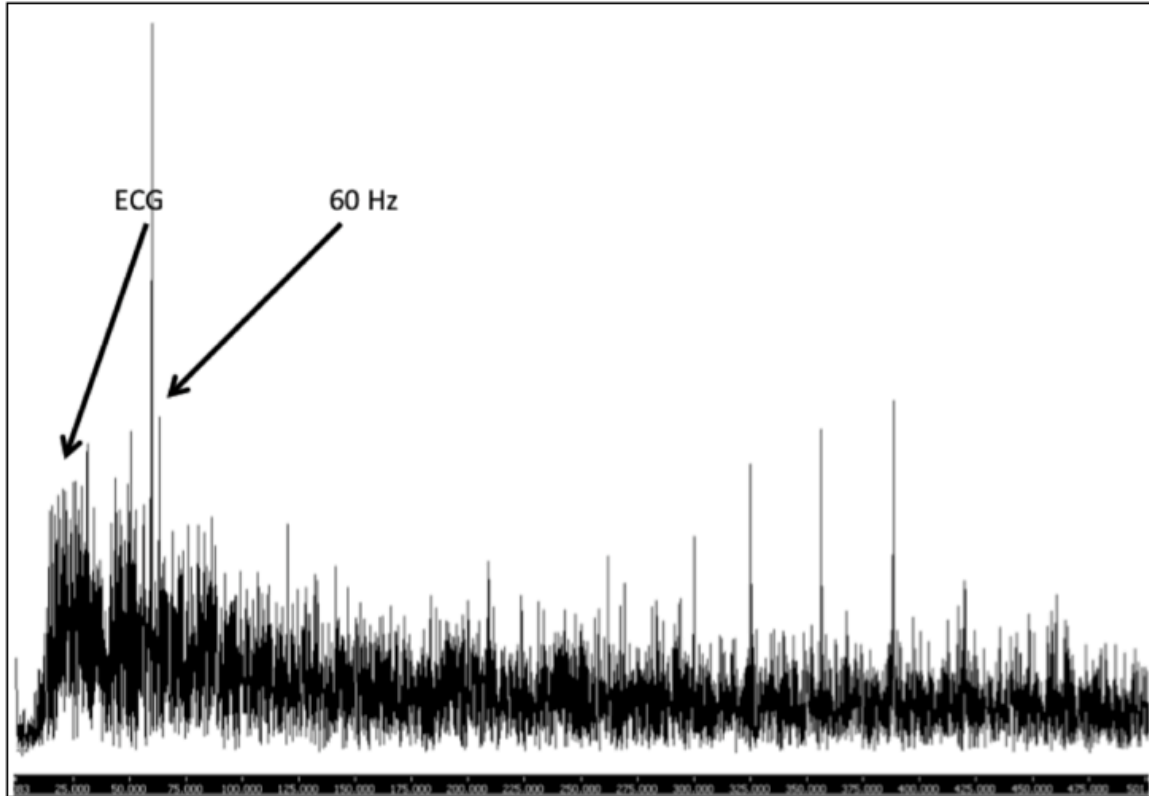
All EMG data underwent a similar algorithm of DC bias removal and bandpass filtering. If ECG contamination was present, the bandpass was applied with cutoff frequencies of 30-500 Hz (Drake and Callaghan 2006), if not then 10-500 Hz was used. If 60 Hz electrical contamination was noted, then a notch (bandstop) filter was also applied, with cutoff frequencies from 59 – 61 Hz (Mello, Oliveira et al. 2007). A representative example is shown in the following figures. Figure 3.13 shows a typical raw EMG signal during a quiet standing trial from the right external oblique containing visible ECG contamination.



**Figure 3.13 Raw EMG from right external oblique containing ECG contamination.**

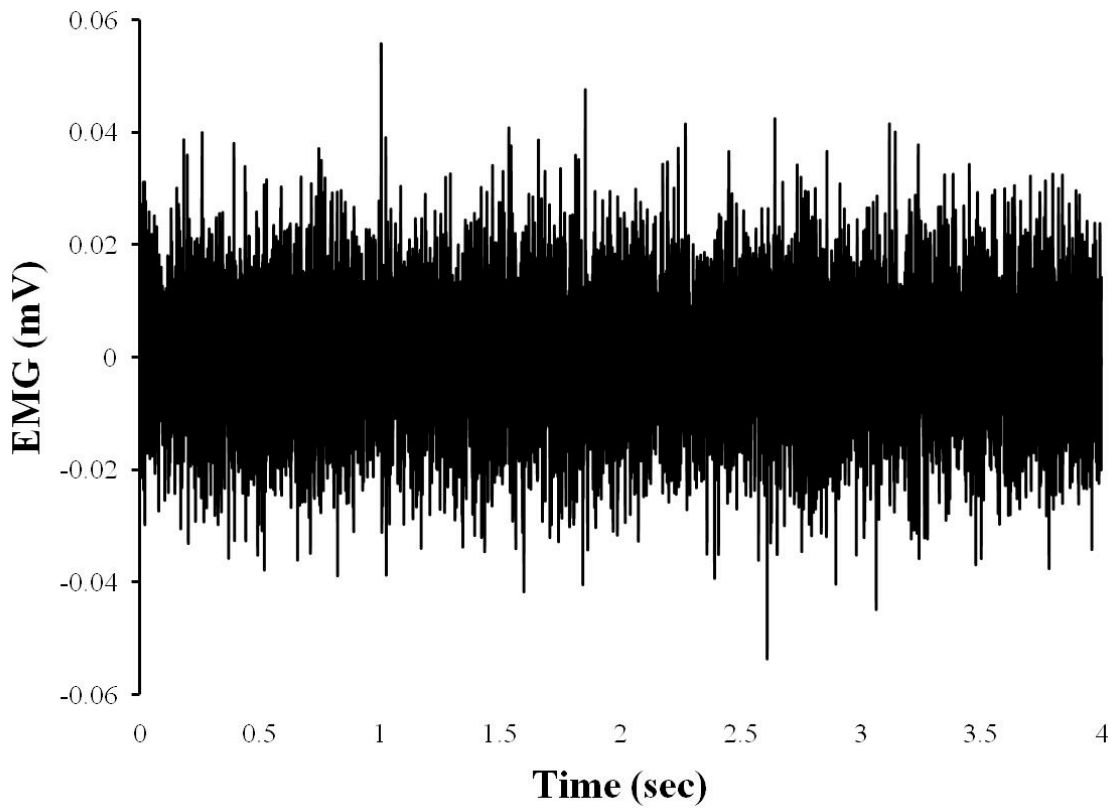
Figure 3.14 shows the output of the FFT for this sample EMG signal conducted in KinAnalysis. Based on the identified contaminants of ECG and 60 Hz, notch and band-pass filtering were applied to this signal as previously described.





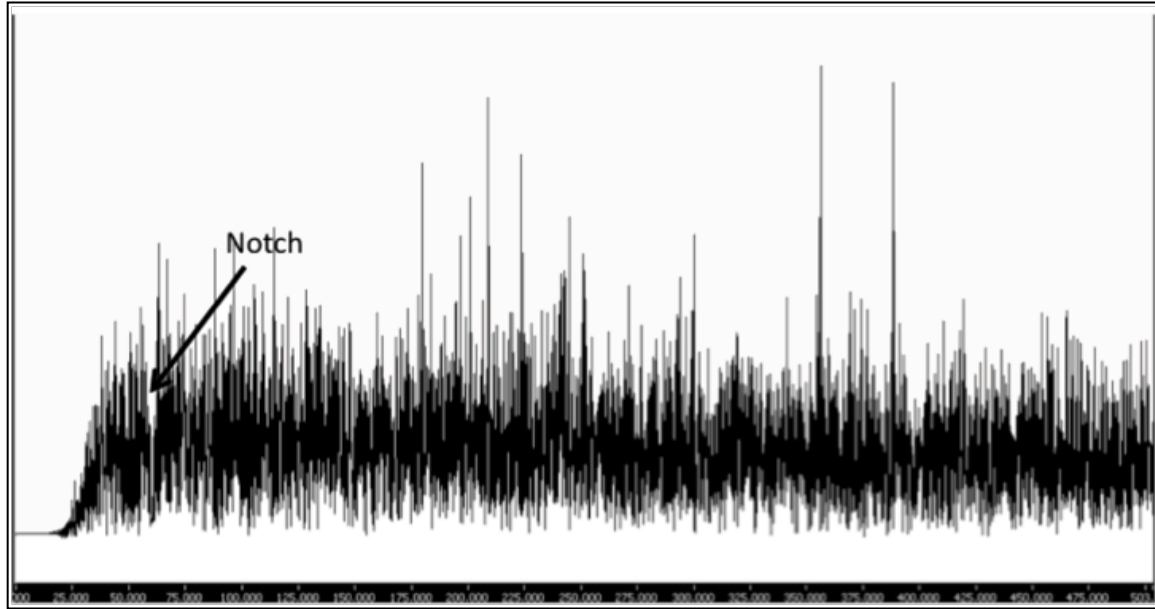
**Figure 3.14 Power spectrum plot of the raw EMG signal shows frequencies of the ECG contamination as well as 60 Hz electrical noise.**

Figure 3.15 shows the EMG signal post-filtering for noise removal. ECG is no longer visible, and the overall EMG amplitude is within the same range as the raw EMG. EMG data were being compared between days, so it is of potential concern that different filtering algorithms may have been applied on Day 1 and Day 2. Since there was minimal amplitude reduction observed post-filtering, and the frequency content of the EMG signals appeared to be largely preserved, this was not considered to introduce a major source of error. The channels that required filtering were also consistent between collections.



**Figure 3.15 EMG signal post-filtering with a notch filter (59-61 Hz) and band-pass (30-500 Hz) as described in the text.**

Figure 3.16 shows the results of spectral analysis performed on the signal post-filtering. The ECG frequency content has been removed, and there is a visible notch at 60 Hz, yet the muscle activation frequency content in that region has been preserved.



**Figure 3.16 Power spectrum plot of the signal, post-filtering.**

Following the removal of the noise components, each EMG signal was full-wave rectified and low pass filtered (dual-pass Butterworth, 4<sup>th</sup> order, effective cutoff frequency of 2.5 Hz) (Brereton and McGill 1998; Winter 2005). Minimum values were extracted from the two resting trials, and the lesser value between the two resting positions (prone versus supine) was used as the ‘resting activation’ for that muscle. This resting value was then removed from the EMG.

### ***3.3.2. Determination of MVCs***

Following post-processing of the MVC trials, the maximum value for each monitored muscle for each trial was extracted. The maximum value recorded for each muscle was then used as the value for normalization of that muscle, regardless of the position from which it was obtained. Since the amplifier gains were not changed in between recording of MVC trials, it was possible for each MVC trial to be directly compared to the others. For most of the muscle groups, the MVC position that corresponded to that muscle group

yielded the maximum value (i.e.; trunk extensors during trunk extension trial). However for the trunk flexors, it was not uncommon to obtain the maximum values during sidelying hip abduction, and maximum values for the gluteus maximus muscles were almost always obtained during trunk extension. These maximum values were then used to normalize the EMG data to % MVC.

### 3.3.3. Co-Contraction Index

Co-contraction Index (CCI) (Lewek, Rudolph et al. 2004) was used to quantify the level of co-activation between all possible muscle pairs using the equation:

#### Equation 3.2

$$CCI = \sum_{i=1}^N \left( \frac{EMG_{low_i}}{EMG_{high_i}} \right) (EMG_{low_i} + EMG_{high_i})$$

The CCI provides a quantitative measure of the degree of co-activation for a pair of muscle groups over a specified number of data points,  $N$ . ‘ $EMG_{low}$ ’ and ‘ $EMG_{high}$ ’ in the equation are the relative magnitudes of the linear enveloped EMG for the muscle pairs under consideration, with ‘ $EMG_{high}$ ’ being the EMG signal with the higher magnitude at each instant in time. A custom program was written in Matlab to compare the magnitude of EMG activation (% MVC) on a point-by-point basis for determination of ‘ $EMG_{low}$ ’ and ‘ $EMG_{high}$ ’ values for entry into Equation 3.2. As an initial starting point, CCI was calculated over one-minute windows (1,920 data points) for the eight 15-minute blocks. As a further data reduction measure data were collapsed by taking an average of the 15 one-minute window CCI values to yield 8 CCI values for the 2-h standing period for each of the possible 120 muscle pairings.

### 3.3.4. Cross-Correlation Analyses

Cross-correlation was also used to investigate timing relationships between the identified co-activated muscle pairs during the prolonged standing task (Nelson-Wong, Howarth et al. 2009). In brief, this methodology can be used to quantify spatial and temporal similarity between two time-varying signals. Cross correlation has been used as a method of describing coordination with kinematic (Shum, Crosbie et al. 2005; Shum, Crosbie et al. 2005) and muscle activation (Osu, Franklin et al. 2002; Mogk and Keir 2003; McDonnell, Ridding et al. 2005; Nelson-Wong, Gregory et al. 2008) data previously. A custom program was written in Matlab to compute cross correlation coefficients,  $R_{xy}$ , with the following equation.

#### Equation 3.3

$$R_{xy}(\tau) = \frac{\frac{1}{T} \int_0^T x(t)y(t + \tau)dt}{\sqrt{R_{xx}(0)R_{yy}(0)}}$$

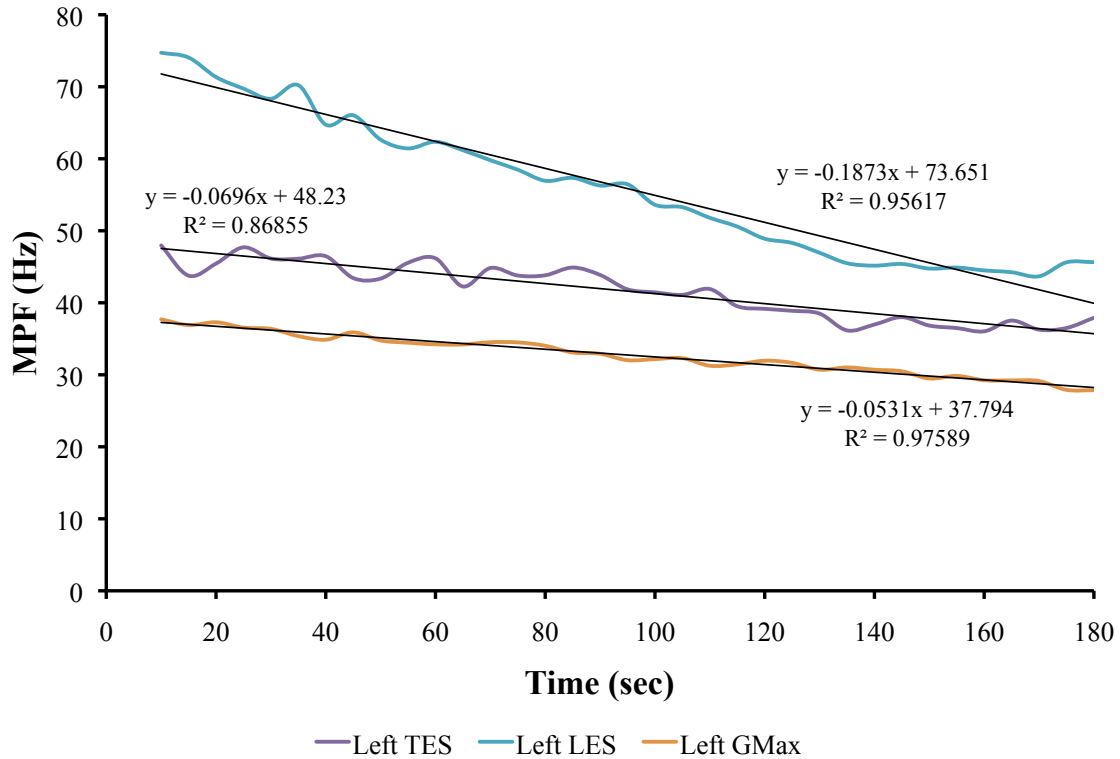
$R_{xy}(\tau)$  is the normalized cross-correlation of two signals,  $x(t)$  and  $y(t)$  at a phase shift  $\tau$  with a potential range of values between -1 and +1, and  $T$  is the length of the record. Cross-correlations were calculated for 1-minute increments during each 15-minute window over the 2-h standing period for each muscle relative to the right gluteus medius muscle. The EMG signals were entered into the cross-correlation equation in an order so that a positive phase lag indicated the trunk muscle was being activated first, and a negative value indicated the right gluteus medius muscle was being activated first. The absolute maximum  $R_{xy}$  values, with corresponding phase lag  $\tau$  were extracted within a

window of  $\pm 500$  msec. Studies investigating the relative timing between thoracic and lumbar paraspinal muscle activations during locomotion showed relative phase lags at maximal correlations of less than 400 msec on average (Prince, Winter et al. 1994). Therefore it was assumed that relative timing between trunk and hip muscle activation for postural control during static standing should be captured within a 500 msec window. The  $\tau$  value provides an indication of the relative timing of each muscle's activation relative to the right gluteus medius. The right gluteus medius muscle was selected as the reference muscle for this procedure since it was the most distal muscle that was monitored in the kinetic chain, and therefore could provide a 'top-down' representation of the relative timing of the other musculature (Prince, Winter et al. 1994). The right gluteus medius muscle was selected over the left gluteus medius as the reference muscle through a random selection.

### ***3.3.5. Fatigue Analyses For Extensor Endurance Test***

Spectral analysis was conducted on the EMG data collected during the extensor endurance test, similar to the methods used by da Silva and colleagues (2005). EMG data from the thoracic and lumbar erector spinae and the gluteus maximus were filtered for noise removal, as described previously. A custom Matlab program was written to calculate the mean power frequency (MPF) over adjacent 250 msec windows throughout the endurance trial. A 20-point moving average (corresponding to 5-second windows) was then taken to smooth the MPF data so that the slope over the trial could be estimated. The resulting MPF values were plotted in Excel, fit with a linear trend-line, and the slopes were extracted (Figure 3.17). As a second fatigue indicator, the root mean square (*rms*) value of the raw EMG signal was also calculated over 250 msec windows for the

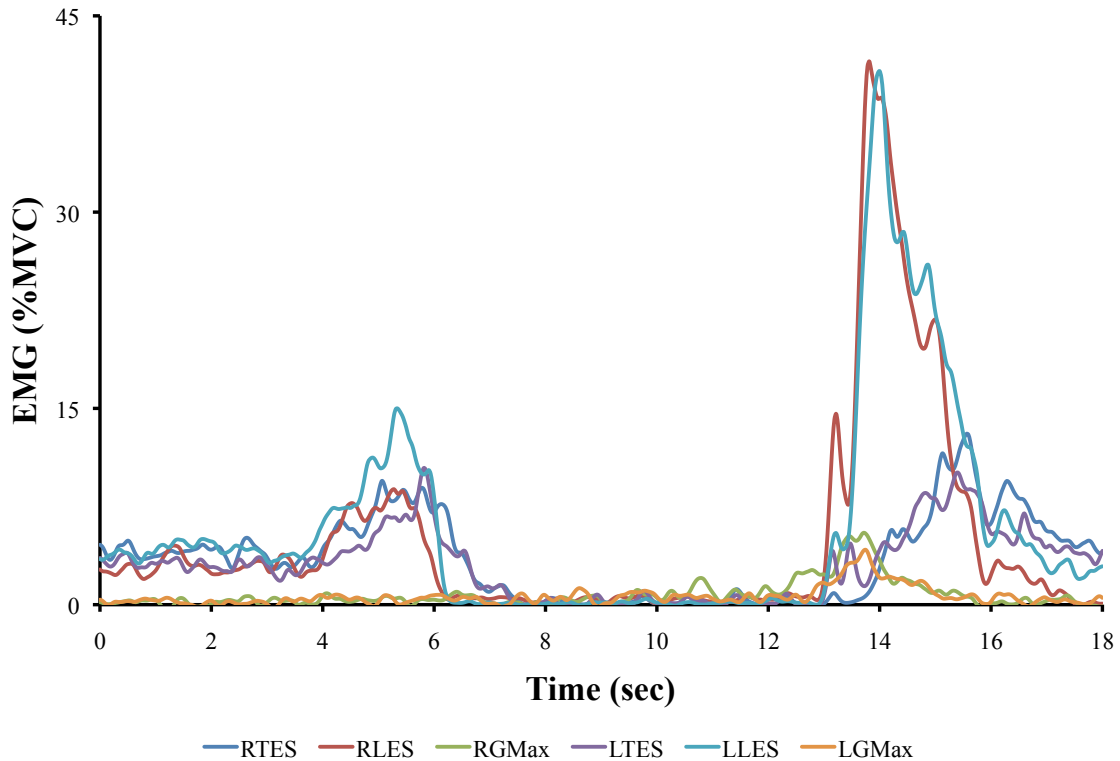
same EMG channels. These data were similarly smoothed, plotted in Excel, fit with trend-lines and had slopes extracted.



**Figure 3.17 Representative example of MPF slope for a female participant during the extensor endurance test.**

### 3.3.6. Calculation of Flexion Relaxation Ratio

Normalized linear envelope EMG data from the forward bending trials (without motion capture instrumentation) for the thoracic and lumbar erector spinae and gluteus maximus muscles were plotted for each participant (Figure 3.18). Average values were taken for the upright standing phase and the forward flexed phase. These phases were based upon visual examination of the EMG plots.



**Figure 3.18** Representative example of extensor EMG for a typical forward flexion trial. The upright standing phase is from approximately 0-2 seconds, and the fully flexed phase is between approximately 7.5 – 12 seconds.

Flexion Relaxation Ratio (FRR) was then calculated using Equation 3.4 (Dankaerts, O'Sullivan et al. 2006).

**Equation 3.4** 
$$FRR = \frac{\text{average}(EMG_{\text{upright}})}{\text{average}(EMG_{\text{flexed}})}$$

### 3.3.7. Force Platform Signal Processing

Post-processing of the force platform data was performed using custom programs written in Matlab. For each independent data collection, averages were calculated for each



channel from the 10-second unloaded force platform trials ('zero' trials) and used as bias values. Following bias removal, data from the 10-second shunt voltage trials were similarly averaged to yield an average shunt value for each channel. The manufacturer provided shunt voltage calibration values were applied to calculate a calibration value for each channel to use for converting the data into SI units (N, Nm).

Force platform data for each trial had the bias removed, and were then low-pass filtered (dual-pass, 4<sup>th</sup> order Butterworth, effective cutoff frequency of 10 Hz) (Winter 2005), followed by down sampling to 32 Hz. The previously calculated calibration constant was then applied to convert the signals into SI units.

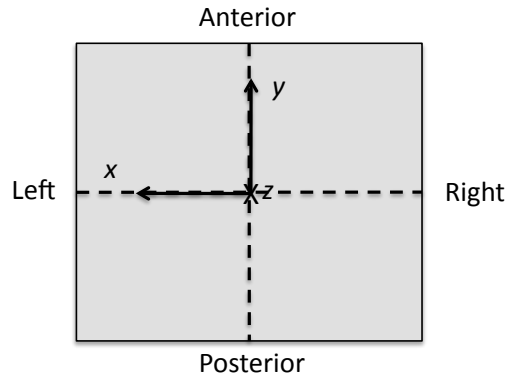
### **3.3.8. Centre-of-Pressure**

Antero-posterior and medio-lateral centre-of-pressures (COP) were calculated using the following equations:

$$\text{Equation 3.5} \quad COP_{A-P} = M_x / F_z$$

$$\text{Equation 3.6} \quad COP_{M-L} = -M_y / F_z$$

These calculations were performed according to the force platform coordinate systems, where +ve for y was anterior with respect to the participant, +ve for x was to the participant's left, and +ve for z was vertically downward as shown in Figure 3.19.



**Figure 3.19** Coordinate system for the force platform relative to the participant's position (note  $z$  is + down).

### 3.4. Biomechanical Modeling

#### 3.4.1. Inverse Dynamic Model

An inverse dynamics rigid link model was created using Visual3D software (C-Motion, Inc.) to calculate trunk and pelvis kinematics and reaction moments at the  $L_5/S_1$  joint. As described previously, an upright standing trial was collected to use in building the model template.

Each segment in the model was constructed using the Model Builder in Visual3D. The segment endpoints were based on the calibration markers that were placed over anatomical landmarks. These were used to calculate the local coordinate systems for each segment, with a general orientation of +ve being anterior, vertically upward and to the right for  $x, y$ , and  $z$  respectively when the participant was standing in the anatomical position. For the thigh, the medial proximal segment endpoint was taken as 50% of the distance between the two greater trochanters. The Visual3D default geometries were used for the body segments to calculate the segmental inertial properties and center of mass locations. The segment masses were scaled according to the participant's mass, again using the Visual3D default calculations, which are based on Dempster's regression

equations (Dempster 1955). For the pelvis, the Visual3D pelvis type (that uses a marker set of anterior iliac crest and greater trochanter) was chosen. For the thorax and pelvis, the participant's trunk depth at the xiphoid process and iliac crest were used to scale those segments respectively. Each segment was tracked with 4 markers, so that if one marker went out of view during the data collection, there would still be 3 non-collinear markers on the segment to track. This model template was then saved and applied to the functional task and standing trials for that participant.

Raw marker and force platform data were imported into Visual 3D for each trial and had the model template applied to them. As part of the import process, the analog data were down sampled to 32 Hz to match the marker data frames. The trunk (thorax relative to pelvis) and global pelvis (in the global coordinate system) angles were calculated in Visual3D, using an Euler angle decomposition sequence of Flexion/Extension (Z), followed by Lateral Bend (X), followed by Axial Twist (Y) in descending order of primary, secondary and tertiary movements (Cappozzo, Della Croce et al. 2005). The origin of the pelvis was located at the proximal pelvis, and was used as the location of the L<sub>5</sub>S<sub>1</sub> joint. The reaction moment was therefore calculated at the junction between the thorax and pelvis segments ('waist'), and was expressed in the pelvis coordinate system. Joint angles were calculated for a quiet upright standing trial, and this was considered to be a 'neutral' position. These values were then subtracted from the time-varying angles as a 'bias' value prior to their entry into any other analyses.

#### ***3.4.2. Vertebral Joint Rotational Stiffness***

An existing anatomical model (Cholewicki and McGill 1996; Grenier and McGill 2007) was used in combination with distributed-moment (DM) equations (Ma and Zahalak

1991) to calculate muscle force and stiffness profiles (Cholewicki and McGill 1995) during each of the functional tasks. Briefly, the model consisted of a rigid ribcage, pelvis and the five lumbar vertebrae. A total of 118 bilateral muscle fascicles, belonging to 10 muscle groups, spanned the vertebral joints (Howarth, Beach et al. 2008). The rotation of each vertebral joint was calculated as a percentage of the total lumbar spine rotation, as determined from the Visual3D model, during each of the functional tasks (White and Panjabi 1990). Each muscle fascicle was assigned a physiological cross-sectional area (PCSA) and the maximum fascicle force was assumed to be equivalent to the product of the PCSA and a nominal maximum muscle stress of  $35 \text{ N/cm}^2$  (Cholewicki and McGill 1996).

Muscle activation profiles were taken from the EMG data and used as inputs to the DM model to determine individual fascicle force and stiffness. The raw EMG data that were entered into the DM model were post-processed a second time using the same filter cut-offs as described previously, the only difference being that single-pass filters were used to introduce a phase lag in the data, analogous to the electromechanical delay due to the neuro-muscular mechanics (Winter 2005). Twelve EMG channels were entered into the model and included: bilateral lumbar erector spinae, thoracic erector spinae, latissimus dorsi, rectus abdominus, external oblique and internal oblique. Because the anatomical model requires EMG data from multifidus, data from the lumbar erector spinae were mapped onto the multifidus channel. As has been done previously with use of the anatomical model, deep muscles that were inaccessible for surface EMG recording (ie; quadratus lumborum, psoas, transversus abdominus) had muscle activation profiles assigned to them from surrogate muscle groups (internal oblique for psoas and

transversus abdominus and lumbar erector spinae for quadratus lumborum) (Beach, Howarth et al. 2008). Time-varying trunk angle data, calculated in Visual3D, were used in conjunction with the muscle geometries and attachment points within the anatomical model to calculate the muscle lengths and contraction velocities that were used in the DM equations. The DM calculations also required an estimation of the muscle's maximum force-producing capability that was described above.

In order to accommodate assumptions within the anatomical and DM models (primarily the assumption of constant PCSA and maximum muscle stress for all participants), a participant-specific gain factor (GF) was derived to linearly scale muscle force and stiffness during each of the functional tasks. Use of a GF that was specific to each participant enabled a relative comparison to be made between individuals of the total VJRS about each vertebral motion segment. The GF was defined as the value that minimized the squared difference between the moments calculated by the Visual3D link segment model ( $M_{LSM}$ ) and the total muscle moment calculated from the DM model ( $M_{mus}$ ) about the flexion/extension axis of the L<sub>5</sub>S<sub>1</sub> vertebral joint across a representative task with  $N$  data frames (Equation 3.7).

**Equation 3.7** 
$$\sum_{i=1}^N (M_{LSM} - GF * M_{mus})^2 = \min$$

A squat was chosen as the reference task to use for determining the GF since it was the task that elicited the highest overall muscle activations across the muscles included in the model. An optimization algorithm was utilized to determine the GF. The GF was increased from 0.002 to 20 in increments of 0.002 (20,000 iterations), and the GF that

produced the smallest difference between the squared calculated external reaction moment ( $M_{LSM}$ ) and the predicted muscle moment ( $M_{mus}$ ) over the duration of the squat, frames  $i = 1$  to  $N$ , was extracted (Beach, Howarth et al. 2008).

Individual contributions of each fascicle to ‘active’ vertebral joint rotation stiffness (VJRS) about each axis of every lumbar vertebral joint were calculated (Equation 3.8) using methods described by Potvin and Brown (2005; 2007) using fascicle attachment locations from Cholewicki and McGill (1996). This measure only takes into account the stiffness contribution due to the activated muscles, and does not incorporate stiffness contributions due to the passive tissues such as vertebral osseous structures, intervertebral disc, or ligaments.

**Equation 3.8**

$$S_m^x = GF \left[ F_m \left( \frac{a_z b_z + a_y b_y - r_x^2}{\|\mathbf{a} - \mathbf{b}\|} \right) + K_m r_x^2 \right]$$

In Equation 3.8,  $S$  designates the contributed stiffness of fascicle  $m$  about axis  $x$ ,  $F$  is the estimated force produced by fascicle  $m$  (derived from the DM equations),  $K$  is the calculated stiffness of fascicle  $m$  (derived from the DM equations),  $a$  and  $b$  designate coordinates (in the coordinate system of the joint) for fascicle  $m$ ,  $\|\mathbf{a} - \mathbf{b}\|$  = the length of fascicle  $m$ , and  $r$  is the orthogonal moment arm for fascicle  $m$  with respect to the joint (Beach, Howarth et al. 2008). The total ‘active’ VJRS for a single vertebral joint was determined by summing the individual contributions of all fascicles spanning the vertebral joint of interest.

Relative contributions of each muscle group to the ‘active’ VJRS were also calculated for each joint and axis (Equation 3.9).

**Equation 3.9**

$$\%TotalStiffness = 100 \frac{\sum_{i=1}^{M_2} S_i^X}{\sum_{i=1}^{M_1} S_i^X}$$

Where  $S$  is the stiffness of each fascicle  $i$  about the  $X$  (lateral bend) axis,  $M_1$  is the total number of fascicles from all muscle groups that cross a particular vertebral joint and  $M_2$  is the number of fascicles from a single muscle group that crosses the same vertebral joint. Left and right sides were summed to provide the contribution from the combined muscle group.

Active VJRS was calculated across the duration of each functional task, however there were only certain phases of each task that were of interest. Key frame numbers were extracted to determine the phases for which the VJRS values would be analysed. For the single leg stand (SLS), only the time period spent in the single leg stance position was required, so frame numbers were extracted from the force platform data by marking when the force platform under the non-stance limb went to zero. The squat task was split into two phases, ‘down’ and ‘up’. These phases were determined from the knee angle data by extracting the frame numbers for when the knee started to move into flexion and the reversal point where it changed direction from flexion into extension. A Matlab program was then written to calculate the peak and average VJRS values for both the total VJRS and each individual muscle relative contribution, at each joint, over the frames of interest.

### 3.5. Statistics

SPSS version 17.0 (SPSS, Inc., Chicago, IL, USA) was used for all statistical analysis. Unless otherwise noted, data were entered into general linear models with between factors of gender, PD/NPD group and intervention and within factors of time (repeated measures during standing protocol for time-varying variables), exposure (pre- and post-standing repeated measures), and collection day (2 repeated measures). The level for significance was set at  $p < 0.05$  for all statistical tests. Bonferroni adjusted  $\alpha$ -values were used for multiple comparisons to determine statistical significance wherever necessary. For the within-factor tests, if data violated sphericity assumptions with Mauchly's Test, Huynh-Feldt adjusted  $p$ -values were used. Unless otherwise noted, pairwise comparisons were made for *post hoc* testing. Consultation and assistance with the statistical analyses were provided by Erin Harvey, University of Waterloo, Department of Statistics and Actuarial Science.



## 4. RESULTS - LABORATORY AND EQUIPMENT PREPARATION

### 4.1. Force Platform Drift Test

Both force platforms had low levels of drift over the 2.5-hour test. Data, calibrated to SI units using the manufacturer supplied calibration matrices, are shown in Table 4.1 and Table 4.2 for the initial outputs when the amplifiers were first turned on (Time 0) and over the final 60 minutes of the test, with the absolute change from time of turning the amplifiers on (Time 0) and the end of the test and the absolute change over the final hour shown in bold. It can be seen that there was a larger degree of drift from the time the amplifiers were turned on until the end of the test, but that this drift stabilized and over the last hour of the test the drift was very small, especially relative to the forces and moments being measured in these studies. It can be seen, however, that it is important to allow for the amplifiers and electronics to warm-up prior to data collection to minimize this source of error and was the rationale for the 1 hour warm-up period adopted for all data collection sessions.

**Table 4.1 Drift test data for large force platform (FP1)**

FP1	$F_x$ (N)	$F_y$ (N)	$F_z$ (N)	$M_x$ (N-m)	$M_y$ (N-m)	$M_z$ (N-m)
Time 0 min	-0.68	-0.66	2.53	-0.53	-0.68	-0.20
Time 90 min	-2.11	-0.92	2.12	-1.76	-0.59	-0.58
Time 120 min	-2.55	-0.63	2.34	-1.90	-0.57	-0.58
Time 150 min	-2.76	-0.45	2.53	-1.97	-0.53	-0.59
<b>Change last 60</b>	<b>-0.66</b>	<b>0.47</b>	<b>0.41</b>	<b>-0.20</b>	<b>0.06</b>	<b>-0.01</b>
<b>Change from 0</b>	<b>-2.08</b>	<b>0.21</b>	<b>0.004</b>	<b>-1.43</b>	<b>0.16</b>	<b>-0.39</b>

**Table 4.2 Drift test data for small force platform (FP2)**

FP2	F <sub>x</sub> (N)	F <sub>y</sub> (N)	F <sub>z</sub> (N)	M <sub>x</sub> (N-m)	M <sub>y</sub> (N-m)	M <sub>z</sub> (N-m)
Time 0 min	4.73	3.12	0.52	1.00	-0.06	0.04
Time 90 min	5.67	2.11	0.05	1.29	0.22	0.14
Time 120 min	5.96	2.14	-0.56	1.45	0.33	0.16
Time 150 min	6.11	2.15	-1.04	1.53	0.51	0.19
<b>Change last 60</b>	<b>0.44</b>	<b>0.04</b>	<b>-1.09</b>	<b>0.24</b>	<b>0.30</b>	<b>0.05</b>
<b>Change from 0</b>	<b>1.39</b>	<b>-0.97</b>	<b>-1.56</b>	<b>0.53</b>	<b>0.57</b>	<b>0.15</b>

Both force platforms were also found to have good agreement between each other when objects of known mass were placed on them (Table 4.3).

**Table 4.3 Force platform outputs for objects of known mass**

	F <sub>x</sub> (N)	F <sub>y</sub> (N)	F <sub>z</sub> (N)	M <sub>x</sub> (Nm)	M <sub>y</sub> (Nm)	M <sub>z</sub> (Nm)
FP1- 4.41 Kg + handle	-0.15	-0.14	47.51	-0.00	-0.16	-0.04
FP2 - 4.41 Kg + handle	0.45	0.41	47.40	0.90	0.00	0.13
<b>Difference – FP's</b>	<b>0.61</b>	<b>0.56</b>	<b>0.11</b>	<b>0.90</b>	<b>0.17</b>	<b>0.16</b>
FP1 - ENW	-0.56	-2.46	610.0	15.56	-18.7	-0.11
FP2 - ENW	-9.73	-8.83	621.5	12.94	-16.57	0.59
<b>Difference – FP's</b>	<b>9.17</b>	<b>6.37</b>	<b>11.44</b>	<b>2.62</b>	<b>2.14</b>	<b>0.70</b>

## 4.2. Cal Tester

Both of the force platforms were in good agreement with the motion capture system for the determination of the centre of pressure (COP) Table 4.4.

**Table 4.4 Reported error in COP from CalTester**

	$\Delta \text{COP}_x$ (mm)	$\Delta \text{COP}_y$ (mm)	$\Delta \text{COP}_z$ (mm)
FP1 (large)	1.3 ± 1.8	0.7 ± 0.2	-2.3 ± 1.0
FP2 (small)	-1.6 ± 7.1	-2.1 ± 0.3	-0.0 ± 7.0

These were deemed to be acceptable given previous reports that for a 1000 N ground reaction force, every 1 mm discrepancy in the COP location equates to a 1 N-m error in the calculated moment at the L<sub>5</sub>S<sub>1</sub> joint (Kingma, de Looze et al. 1996).

### **4.3. Motion Capture Calibration**

Registration and Alignment were performed within the NDI Toolbench software using the built-in wizard. The average *rms* error for the dynamic registration was  $0.46 \pm 0.02$  mm and for the static alignment was  $0.15 \pm 0.03$  mm. These values are within the range of acceptable limits provided from NDI technical support (Gina Jackson) given the number of sensors (4) used for these data collections.

## **5. STUDY 1: IDENTIFICATION OF PREDICTIVE FACTORS FOR LOW BACK PAIN DEVELOPMENT DURING STANDING**

Sections 5.3, 5.4, 5.10 and 5.12 form a paper that has been accepted for publication as of April 27, 2009:

Nelson-Wong E, and Callaghan J.P. “**Muscle Co-activation as a Predisposing Factor in Development of Low Back Pain During Prolonged Standing in Previously Asymptomatic Individuals**”, *Journal of Electromyography and Kinesiology*, In Press, 2009.

The work encompassing Section 5.5 has been accepted for publication as of May 22, 2009.

Nelson-Wong E, Flynn T.W., and Callaghan J.P. “**Development of Active Hip Abduction as a Screening Test for Identifying Occupational Low Back Pain**”, *Journal of Orthopaedic and Sports Physical Therapy*, In Press, 2009.

### **5.1. Participant Baseline Characteristics**

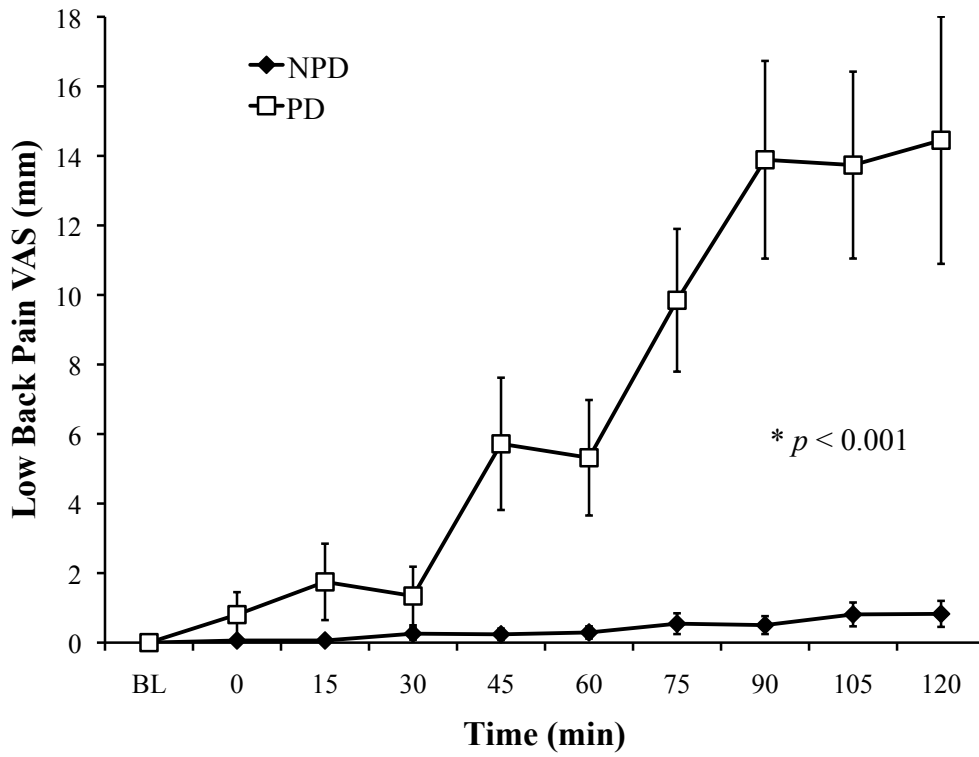
Independent t-tests were conducted to ensure equality of groups on the personal characteristics of age, body mass index (BMI), and activity level as documented by MPAQ score. Baseline characteristics of the participants within each group, PD and NPD, were statistically similar (Table 5.1). The PD and NPD groups were also similar in VAS score for the low back when they arrived for data collection,  $t_{(41)} = -1.858, p > 0.05$ .

**Table 5.1 Baseline characteristics of participants**

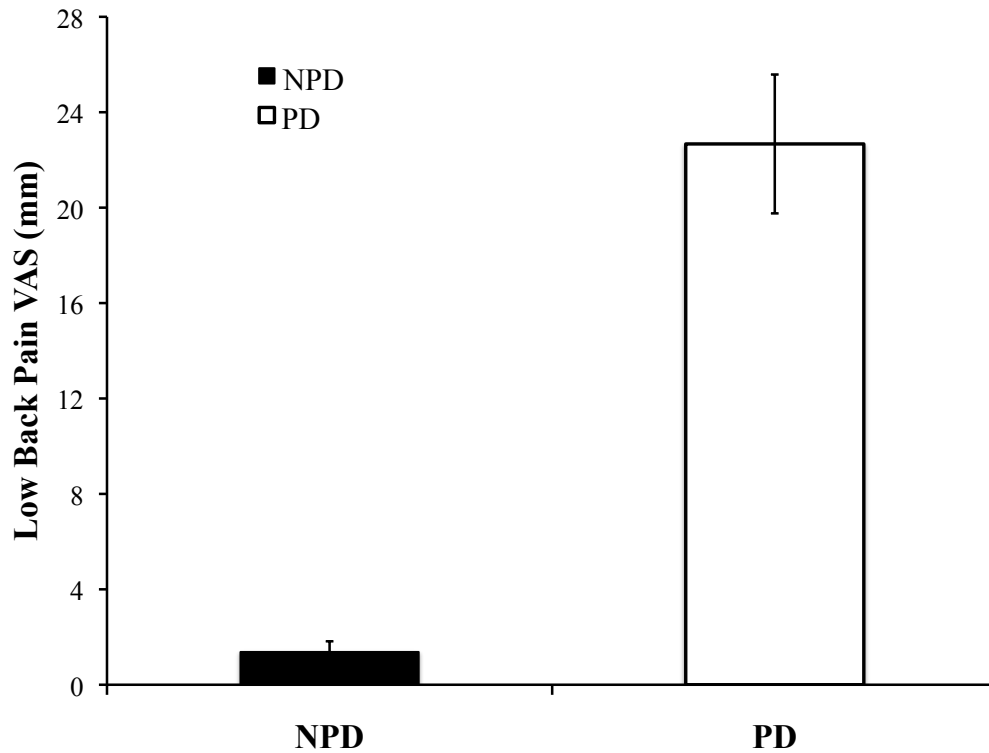
	<b>Group</b>	<b>N</b>	<b>Mean</b>	<b>SD</b>	<b>SEM</b>	<b><i>p</i>-value</b>
<b>Age</b>	NPD	26	22.50	3.11	0.611	0.562
	PD	17	23.12	3.77	0.915	
<b>BMI</b>	NPD	26	23.68	3.25	0.637	0.844
	PD	17	23.88	3.28	0.796	
<b>MPAQ previous 4 weeks</b>	NPD	26	14438.7	7554.9	1481.6	0.315
	PD	17	17071.1	9342.4	2265.9	

## **5.2. Low Back Pain Development During Standing**

VAS change scores from baseline were entered into a 3-way general linear model with between factors of gender and pain developer group, and a repeated measure of time with 9 repeated measures. The standing protocol was successful in inducing LBP in 40% of the participants. As expected, there was a significant interaction of time and group,  $F_{2,984,116.394} = 14.222, p < 0.001$ , with individuals identified as PD showing increased levels of pain over time and the NPD group remaining at a very low level (Figure 5.1). Since the maximum VAS score that was reported during the 2 hours was used to categorize participants as PD or NPD, the group averages for this maximum value are also shown in Figure 5.2.



**Figure 5.1** The 2-hour standing protocol was successful at inducing pain in 40% of the participants with a clear differentiation between PD and NPD groups (time by group interaction significant at  $p < 0.001$ ).



**Figure 5.2 Pain developers averaged a maximum VAS score of  $22.7 \pm 2.91$  mm and non-pain developers averaged a maximum VAS score of  $1.37 \pm 0.45$  mm.**

Although a higher percentage of females reported low back pain (48%) than males (32%), male PD had a higher maximum VAS score ( $27.4 \pm 6.09$  mm) than female PD ( $19.34 \pm 2.31$  mm),  $F_{1,39} = 9.35$ ,  $p < 0.05$ .

### 5.3. Psychosocial Questionnaires

Recognizing that psychosocial factors play a critical role in LBP risk, pain perception and response to injury (Waddell, Newton et al. 1993; Waddell 2004; George, Dannecker et al. 2006), an attempt was made to account for psychosocial factors such as fear of pain and/or physical activity. Participants were not shielded from the knowledge that this was a study about LBP development during standing. Composite scores for the questionnaires

were entered into a 2-way general linear model with between factors of gender and pain developer group. A multivariate analysis was also done (by gender and PD/NPD group) including the individual questionnaire items. Although the full psychosocial questionnaires were not used, neither the composite score or the item-by-item analysis showed increased fear avoidance or negative feelings about exercise and pain in either group or gender ( $p > 0.05$ ). Therefore, the individuals in this study did not appear to have greatly different psychosocial sets regarding their attitudes towards injury, pain and fear of movement. In general, the participants in this study expressed agreement with the belief that exercise and movement are not detrimental for a low back problem. Averaged participant response data for the questionnaires are presented in Table 5.2, Table 5.3 and Table 5.4.

**Table 5.2 Mean CRPP responses (lower scores indicate stronger agreement with the statement).**

<b>Cognitive Risk Profile for Pain (CRPP)</b>	<b>Mean (SE)</b>
Feeling angry can increase my pain.	4.21 (0.23)
Pain can put me in a bad mood.	2.32 (0.16)
Exercise can help manage my pain.	1.84 (0.12)
My life should be pain free.	2.95 (0.22)
Worry can increase the pain that I feel.	3.34 (0.20)
My attitude and the way I think are an important part of how to manage my pain.	1.86 (0.16)
Stress in my life can make my pain feel worse.	2.70 (0.21)
Pain can make me feel depressed.	2.70 (0.21)
Composite Score	22.2 (0.74)



**Table 5.3 Mean SOPA-b responses (higher scores indicate stronger agreement with the statement).**

<b>Survey of Pain Attitudes - brief</b>	<b>Mean (SE)</b>
There are many times when I can influence the amount of pain I feel.	2.72 (0.15)
When I hurt, I want my family to treat me better.	1.63 (0.19)
Anxiety increases the amount of pain I feel.	2.33 (0.18)
When I am hurting, people should treat me with care and concern.	2.0 (0.15)
It is the responsibility of my loved ones to help me when I feel pain.	1.53 (0.17)
Exercise and movement are good for a pain problem.	3.23 (0.11)
Just by concentrating or relaxing, I can 'take the edge' off my pain.	2.86 (0.12)
Medicine is one of the best treatments for chronic pain.	1.44 (0.16)
Depression increases the pain I feel.	2.09 (0.16)
If I exercise, I could make my pain problem much worse.	1.65 (0.18)
I believe that I can control how much pain I feel by changing my thoughts.	2.42 (0.15)
Often I need more tender loving care than I am now getting when I am in pain.	1.47 (0.18)
There is a strong connection between my emotions and my pain level.	1.91 (0.17)
Composite Score	27.3 (0.98)

**Table 5.4 Mean FABQ responses (higher scores indicate stronger agreement with the statement).**

<b>Fear Avoidance Beliefs Questionnaire (FABQ)</b>	<b>Mean (SE)</b>
Physical activity might harm my back.	2.30 (0.27)
I should not do physical activities that (might) make my back worse.	3.21 (0.28)
My work is too heavy for me.	0.57 (0.14)
My work might hurt my back.	2.02 (0.31)
Composite Score	8.05 (0.62)

## **5.4. Clinical Assessment**

The clinical assessment variables were entered into a 2-way general linear model with between factors of gender and PD/NPD group. Non-parametric tests were conducted on the nominal clinical assessment variables where appropriate. The self-rated and examiner

scored active hip abduction (AHAbd) tests were the only clinical assessment tests that showed differences between groups, ( $F_{1,41} = 4.943$  and  $F_{1,41} = 7.418$ ,  $p < 0.05$  respectively). A summary of the clinical assessment findings is presented in Table 5.5. There was no main effect of gender, and no interactions between gender and group.

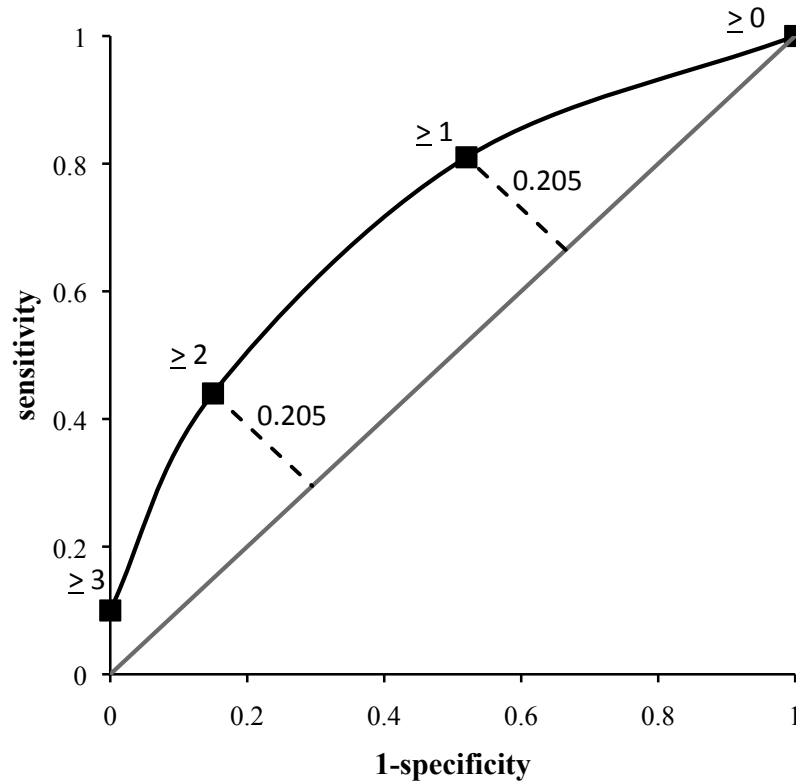
**Table 5.5 Group differences on clinical measures (significant  $p$ -values in bold)**

Clinical Measures	NPD Mean (SD)	PD Mean (SD)	$p$ -value
Lumbar Flexion (°)	122.2 (14.3)	124.8 (17.5)	0.60
Lumbar Extension (°)	48.9 (11.9)	52.1 (12.3)	0.40
Left Lumbar Lateral Flexion (°)	53.0 (7.8)	50.2 (9.9)	0.31
Right Lumbar Lateral Flexion (°)	50.8 (7.8)	48.8 (9.4)	0.45
Right Hip Flexion (°)	119.2 (9.8)	122.7 (9.3)	0.25
Left Hip Flexion (°)	123.5 (9.2)	122.8 (8.5)	0.82
Right Hip Extension – in prone (°)	17.2 (6.1)	14.4 (5.8)	0.40
Left Hip Extension – in prone (°)	17.4 (4.9)	16.8 (5.4)	0.72
Right Hip Internal Rotation – prone (°)	37.9 (11.1)	42.1 (7.8)	0.18
Left Hip Internal Rotation – prone (°)	40.1 (11.7)	44.8 (10.7)	0.19
Right hip External Rotation – prone (°)	45.7 (11.7)	44.4 (15.3)	0.75
Left Hip External Rotation – prone (°)	42.9 (10.4)	42.0 (11.7)	0.81
Right Straight Leg Raise (°)	67.0 (14.3)	70.2 (13.1)	0.47
Left Straight Leg Raise (°)	70.6 (12.7)	73.6 (15.8)	0.49
ASLR test (> 0 indicates + finding)	0.77 (1.3)	1.59 (2.1)	0.12
Lumbar Segmental Mobility – L <sub>5</sub> PA (0=hypo, 1=normal, 2=hyper)	0.69 (0.55)	0.41 (0.51)	0.10
Side Support - time to failure (s)	91.5 (38.6)	97.7 (41.8)	0.62
Beiring-Sorensen test – time to failure (s)	139.3 (43.6)	154.4 (59.7)	0.35
Instability Catch (0=absent, 1=present)	0.0 (0.0)	0.0 (0.0)	1.0
Gower's Sign (0=absent, 1=present)	0.0 (0.0)	0.0 (0.0)	1.0
Lumbo Pelvic Reversal (0=absent, 1=present)	0.23 (0.43)	0.12 (0.33)	0.36
Prone Instability Test at L <sub>5</sub> (0=negative, 1=positive)	0.04 (0.2)	0.18 (0.39)	0.13
Self-Rated AHAbd test (0=no difficulty, 5=unable)	1.19 (1.41)	2.44 (2.28)	<b>0.032</b>
Examiner Scored AHAbd test (0=no loss, 1=min loss, 2=mod loss, 3=severe loss)	0.65 (0.75)	1.35 (0.93)	<b>0.009</b>

The AHAbd test was then transformed into a categorical variable by considering different cut-off thresholds for 'positive' and 'negative' tests, and a receiver operating characteristic (ROC) analysis was performed to determine the optimal cut-off threshold for a positive score. An ROC curve was generated for the examiner rated scores using cut-off thresholds of 0, 1, 2 and 3 and plotting the sensitivity against 1-specificity.

Similarly, ROC curves were constructed for the self-rated scores using cut-off thresholds on a point-by-point basis. Area under the ROC curves (AUC) was calculated in SPSS.

For the examiner-rated AHAbd test, results from the ROC analysis indicated that there was no difference in optimal cut-off threshold for a positive test between scores of 1 or 2 with the perpendicular distance from the line of identity to the cut-off score being equivalent (Figure 5.3).



**Figure 5.3 ROC plot for different cut-off thresholds. The equivalent perpendicular distance from the line of identity, 0.205, indicates no difference in optimum cutoff threshold between scores of 1 and 2. Area under the curve (AUC) is approximately 0.64, and indicates limited utility of the test.**

AUC values for cut-off scores of 1 and 2 were also very similar, 0.662 (95% CI 0.497-0.827) and 0.629 (95% CI 0.452-0.826) respectively. However the calculated odds ratio (OR) using a cut-off score of 1 had a 95% confidence interval that included the null value of 1.0, indicating the test result has a chance of being meaningless with a cut-off score of 1. When a cutoff score of 2 was used, the positive likelihood ratio (LR+) = 2.68 (95% CI 1.02-8.54) and the OR = 3.85 (95% CI 1.05-19.07). This OR indicates that an individual who scores 2 or greater on the examiner-rated AHAbd test would be 3.85 times more likely to be a LBP developer during occupational standing. The 2x2 table for this scenario is presented in Table 5.6.

**Table 5.6 The 2x2 table for examiner-scored AHAbd test with cutoff score  $\geq 2$  (95% CI is shown in parentheses)**

<b>Examiner Scored Active Hip Abduction Test With Cutoff <math>\geq 2</math></b>	<b>PD</b>	<b>NPD</b>
Positive Test (predicts PD)	7	4
Negative Test (predicts NPD)	10	22
Sensitivity	0.41 (0.23-0.67)	
Specificity	0.85 (0.68-0.94)	
LR+	2.68 (1.02-8.54)	
LR-	0.70 (0.42 – 1.05)	
OR	3.85 (1.05-19.07)	

For the self-rated test, the ROC analysis indicated that an appropriate cut-off score would range from 3-5 out of a possible 10. AUC values, and 95% CI's, for each of these cut-off scores were similar to those for the examiner scored test. When OR was calculated using each of these cut-off scores, the cut-off score of 4 was found to be the best with a LR+ of 4.59 (95% CI 1.05-20.13) and an OR of 6.55 (95% CI 1.14-37.75). The 2x2 table for this scenario is presented as Table 5.7.

**Table 5.7 The 2x2 table for self-rated AHAbd test with cutoff score  $\geq 4$  (95% CI is shown in parentheses)**

<b>Self-Rated Active Hip Abduction Test With Cutoff <math>\geq 4</math></b>	<b>PD</b>	<b>NPD</b>
Positive Test (predicts PD)	6	2
Negative Test (predicts NPD)	11	24
Sensitivity	0.35 (0.17 - 0.59)	
Specificity	0.92 (0.76 - 0.98)	
LR+	4.59 (1.05 – 20.13)	
LR-	0.70 (0.49 – 1.01)	
OR	6.55 (1.14 – 37.8)	

Although the examiner-scored test had a lower  $p$ -value than the self-rated test on the statistical analysis, the self-rated test with a cut-off score of 4 had higher OR and LR+ values than the examiner scored test. Mens and colleagues described a positive finding on the ASLR, a test upon which the AHAbd was loosely based, as being any non-zero rating (Mens, Vleeming et al. 2001). The ROC and OR analysis on the AHAbd test in this study indicated that an individual was required to perceive a higher level of difficulty in performing the movement for it to be predictive of LBP development during standing.

OR values for each method of scoring the test had 95% confidence intervals with the lower limits being only marginally greater than the null value of 1.0. This is likely due to the very small sample size in this study, and further research is needed in a larger sample before this test is incorporated into clinical practice. The lower limit of the LR+ 95% confidence intervals for each scoring method were also just above the null value of 1.0. The sensitivity values were both poor, however the specificity values of 0.92 and 0.85,

for self-rated and examiner scored tests respectively, indicate the test may be useful for ruling in pain development during standing. The ROC analyses for both scoring methods yielded poor AUC values, with all 95% CI's encompassing the null value of 0.5. This indicates that the test may not be useful in discriminating pain developers from non-pain developers in standing, again this is likely a function of the small sample size in this study.

The AHAbd test differs from the other clinical assessment tools used in this study in that trunk control in the frontal plane during a low-demand challenge is presented. The ASLR challenges trunk control during lower limb movement, however the patient is in a supine position, which is inherently stable, and also has the benefit of broad tactile input from the supporting surface. The side-support test is a measure of endurance, and while it does require trunk control in the frontal plane, trunk control is not assessed specifically. The side-support test is a high-demand, static task, that involves extensive co-contraction of the trunk musculature to accomplish (McGill, Childs et al. 1999). The AHAbd test was designed to challenge the trunk musculature during active lower limb movement in a destabilized position of sidelying with extended lower extremities. The finding that pain developers had greater difficulty controlling this movement and maintaining the trunk in a neutral position during a relatively low demand challenge supports the concept of decreased trunk control during an upright posture, and perhaps is an indicator of motor control deficiency in this group.

Although electromyography was collected during the standing task, the AHAbd test was performed without biomechanical instrumentation. Therefore direct comparisons of muscle activation patterns and timing cannot be made between the screening test and the

pain-inducing standing task. There have been no inter- or intra-rater reliability analyses performed on this test as it was done as part of a much larger study and was not the primary aim. Repeatability of self-scoring within individuals has also not been assessed. All of the clinical assessments were performed by the same physical therapist, and it is unknown whether the subjective judgment of ‘minimal’, ‘moderate’ or ‘severe’ loss of pelvis frontal plane would be similar between different examiners, however cues to guide clinicians to achieve similar classification of performance during the AHAbd test are provided as guidelines. The improved odds ratio of the test with an examiner scored cut-off threshold of ‘moderate’ or ‘severe’ loss of frontal plane, and a self-rated score of greater than 4, indicates that these thresholds should be used as a baseline for future testing and clinical assessments. The test has been used only in an asymptomatic sample without prior history of LBP, and it is unknown at this point how it might perform in a clinical population. Several studies have shown altered postural and trunk control in response to perturbations in individuals with LBP (Henry, Hitt et al. 2006; Brumagne, Janssens et al. 2008; Silfies, Bhattacharya et al. 2009). Therefore, it may be expected that a test designed to identify impairments in trunk and pelvis control during a self-initiated perturbation should be sensitive to differences in clinical populations, and may be of particular benefit in identifying LBP patients that will respond to exercise intervention aimed at trunk and pelvis control during dynamic lower limb movement. The Active Hip Abduction test performed moderately well in predicting the occurrence of LBP during exposure to an occupational standing task in previously asymptomatic individuals. The test appears to have potential utility as a screening tool to determine which individuals might be at risk for LBP development during a prolonged standing task. Future work is

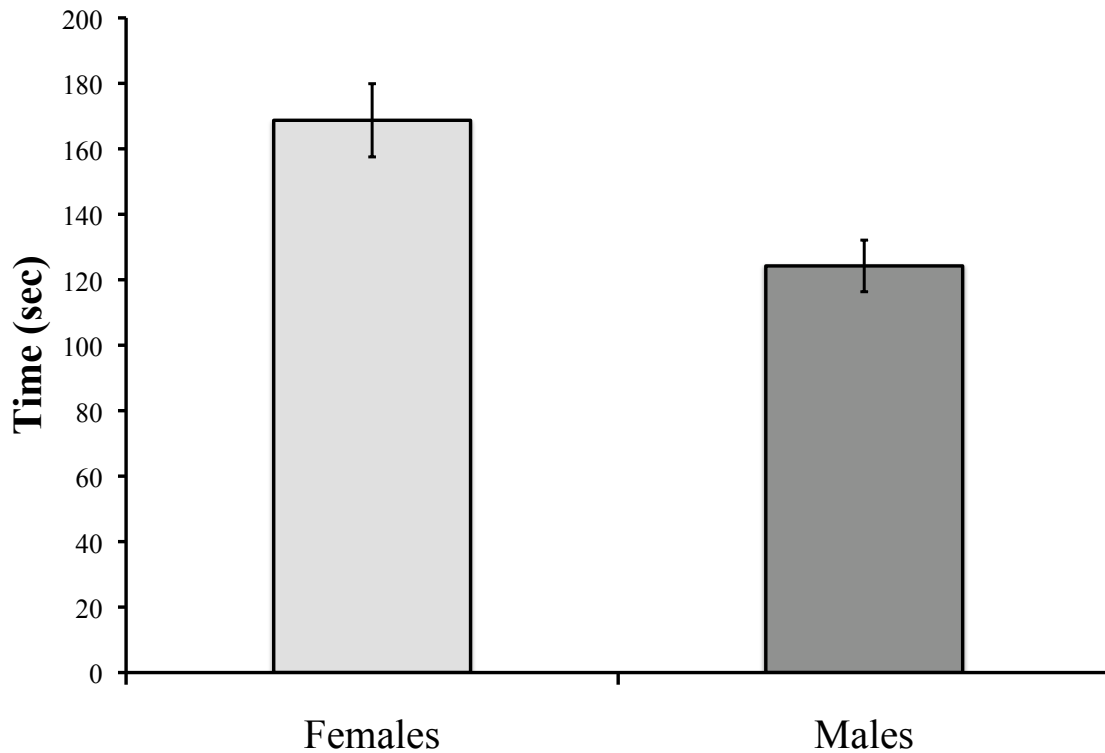


needed to determine the reliability, validity, and generalizeability to clinical and occupational populations.

### **5.5. Extensor Endurance Test**

Average and peak values were calculated for the normalized EMG from the extensor endurance trials.  $MPF_{\text{slope}}$  and EMG amplitude  $rms_{\text{slope}}$  were calculated from the filtered raw EMG (prior to linear envelope) as previously described. Dependent t-tests were conducted on the EMG data for left and right muscle pairs. Left and right sides were shown to be not statistically different ( $p > 0.05$ ). Therefore symmetry was assumed and an average value was taken across the left and right side for each muscle group as a data reduction measure. Time to failure, average and peak normalized EMG amplitudes,  $MPF_{\text{slope}}$  and  $rms_{\text{slope}}$  were entered into 2-way general linear models with between factors of PD/NPD group and gender. Average and peak EMG for gluteus maximus, thoracic and lumbar erector spinae muscles were entered into 3-way general linear models with between factors of gender and PD/NPD groups and a within factor of muscle group to determine whether there were differences in relative muscle activation levels between the gluteal, lumbar and thoracic erector spinae muscles.

There was a significant main effect of gender on the time to failure ( $F_{1,39} = 10.258, p < .005$ ), with no differences between groups and no interactions between gender and group. Females held the extensor position longer than males ( $168.7 \pm 11.2$  sec versus  $124.2 \pm 7.9$  sec) (Figure 5.4).

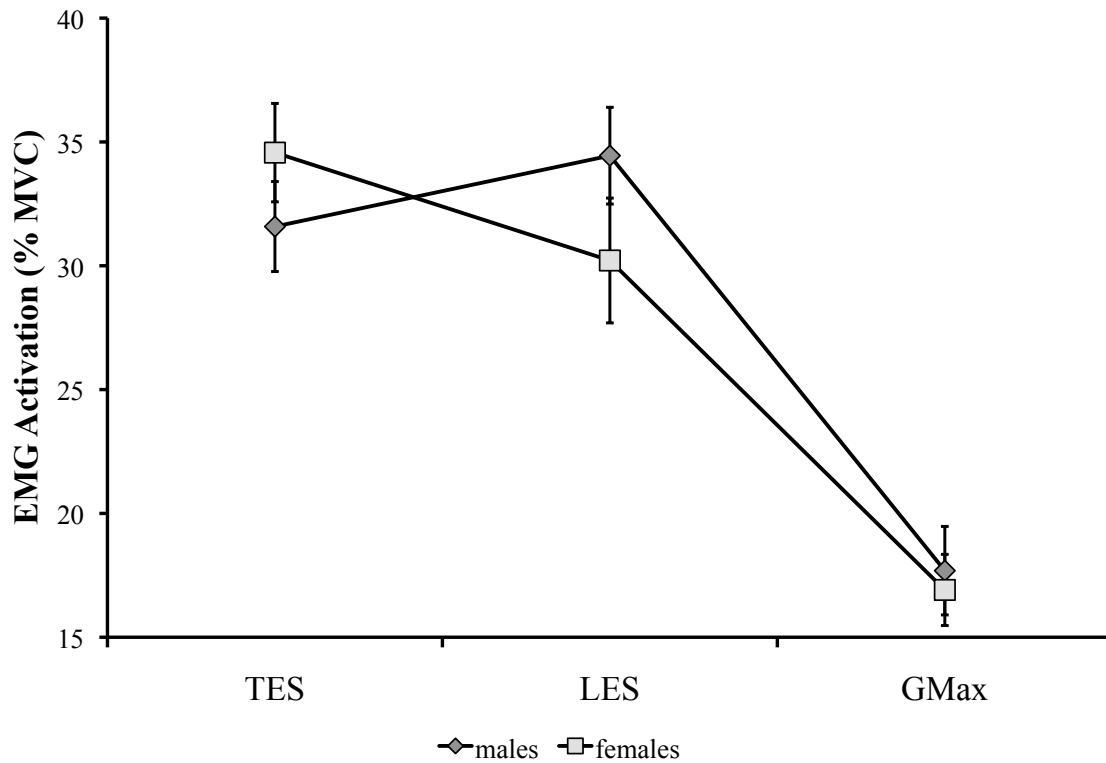


**Figure 5.4 Females were able to maintain the Beiring-Sorensen position longer than males ( $p < 0.05$ ).**

There were no significant differences ( $p > 0.05$ ) in peak or average activation levels (%MVC) across muscle groups. Summary data for these measures is presented in Table 5.8. There were also no PD/NPD group or gender differences in the activation level of the gluteal muscles relative to erector spinae muscles during the extensor endurance task ( $p > 0.05$ ). However there was a significant muscle by gender interaction ( $F_{2,78} = 5.465, p < 0.01$ ) for the average EMG data, with females having their highest % MVC levels in the thoracic erector spinae and males having their highest levels in the lumbar erector spinae (Figure 5.5). Activation levels for the gluteus maximus were similar between genders.

**Table 5.8 Summary data for muscle activation level during extensor endurance test**

	<b>Peak Activation</b> Mean (SD)	<b>Average Activation</b> Mean (SD)
Thoracic Erector Spinae (% MVC)	69.7 (19.0)	33.0 (7.9)
Lumbar Erector Spinae (% MVC)	63.1 (19.6)	32.4 (9.9)
Gluteus Maximus (% MVC)	48.9 (24.5)	17.3 (7.1)



**Figure 5.5 During the extensor endurance task, females had the highest average muscle activations in the thoracic erector spinae (TES) while males had the highest average activations in the lumbar erector spinae ( $p < 0.01$ ).**

There were no group effects or group by gender interaction in either of the EMG indicators for muscle fatigue. There was a significant main effect of gender for MPF slope in the lumbar erector spinae ( $F_{1,39} = 16.511, p < 0.001$ ), with male participants having a steeper negative slope ( $-0.256 \pm 0.018$  Hz/sec) than females ( $-0.143 \pm 0.019$

Hz/sec). There was also a significant main effect of gender in the *rms* slope for the thoracic erector spinae ( $F_{1,39} = 8.207, p < .005$ ) with males having a steeper positive slope ( $4.41 \times 10^{-4} \pm 1.0 \times 10^{-4}$  mV/sec) than females ( $1.52 \times 10^{-5} \pm 8.3 \times 10^{-5}$  mV/sec).

Table 5.9 shows average MPF<sub>slope</sub> and rms<sub>slope</sub> values by gender for each monitored muscle group. These findings, combined with the difference in time to fatigue, suggest that males have a faster rate of fatigue than females during the extensor endurance test since more rapidly decreasing MPF values and more rapidly increasing *rms* values are both well accepted indicators of fatiguing muscles (De Luca 1997). It is not surprising that males would demonstrate greater fatigability during this test since males have a larger upper body mass to support than females, resulting in greater demand on the extensor musculature to maintain the test position.

**Table 5.9 There were gender differences in EMG fatigue measures for erector spinae muscles (significant *p*-values in bold).**

	<b>Males</b> Mean (SD)	<b>Females</b> Mean (SD)	<b><i>p</i>-value</b>
TES – MPF <sub>slope</sub> (Hz/s)	-0.096 (0.08)	-0.097 (0.06)	0.805
LES – MPF <sub>slope</sub> (Hz/s)	-0.256 (0.08)	-0.143 (0.09)	<b>&lt; 0.001</b>
GMax – MPF <sub>slope</sub> (Hz/s)	-0.055 (0.04)	-0.085 (0.10)	0.197
TES – rms <sub>slope</sub> (mV/s)	$4.60 \times 10^{-4}$ ( $4.9 \times 10^{-4}$ )	$2.95 \times 10^{-5}$ ( $4.0 \times 10^{-4}$ )	<b>0.005</b>
LES – rms <sub>slope</sub> (mV/s)	$-4.00 \times 10^{-4}$ ( $5.2 \times 10^{-4}$ )	$-1.44 \times 10^{-4}$ ( $3.48 \times 10^{-4}$ )	0.103
GMax – rms <sub>slope</sub> (mV/s)	$2.18 \times 10^{-4}$ ( $3.71 \times 10^{-4}$ )	$2.00 \times 10^{-4}$ ( $2.14 \times 10^{-4}$ )	0.987

While gender was not addressed in da Silva’s study (2005), the lack of differences in muscle fatigability between PD and NPD groups in this sample is consistent with their findings of no difference in fatigability between healthy controls and individuals with chronic low back pain. In another study, females with chronic LBP were found to have

faster rates of fatigue (as measured by  $MPF_{\text{slope}}$ ) than females without LBP (Kankaanpaa, Taimela et al. 1998). Kankaanpaa (1998) also reported the total time to failure was less in the patient population, suggesting a quicker onset of fatigue.

Because there were no differences found in fatigability, this would suggest that extensor muscle fatigability may not be considered to be a predisposing factor in the development of low back pain during standing, but might rather be considered a consequence of low back pain chronicity leading to overall deconditioning in the chronic low back pain population.

## **5.6. Flexion Relaxation Ratio**

Flexion relaxation ratio (FRR) was calculated for the three trials of forward bending (without motion capture instrumentation) and averaged across trials. FRR was defined earlier as the ratio of muscle activation in upright standing to activation in the fully flexed position. Average EMG values to be entered into the FRR equation, were taken as described previously from stable sections of upright standing posture and from the fully flexed position. Dependent t-tests were conducted on the FRR values for the left and right pairs for the thoracic and lumbar erector spinae and the gluteus maximus muscles to determine whether symmetry could be assumed. There were no statistical differences ( $p > 0.05$ ) between sides, so the FRR values were averaged across the left and right sides for each muscle group. The FRR values for each muscle group were then entered into a 2-way general linear model with between factors of gender and PD/NPD group. Four of the participants (M1, M2, F1 and F2) did not have flexion trials collected without motion capture instrumentation. Statistical analyses were done with and without these four participants' data included, and statistical significance was not changed, so their data

were included. There were no statistically significant main effects or interactions for TES or LES. However, there was a main effect of PD/NPD group for the gluteus maximus ( $F_{1,39} = 4.247, p < 0.05$ ). PD individuals were found to have an increased relaxation response ( $3.4 \pm 6.8$ ) compared with NPD ( $0.91 \pm 1.0$ ) in the gluteus maximus muscles during standing flexion (Table 5.10).

**Table 5.10 Average Flexion Relaxation Ratio values for the three monitored muscle groups (significant  $p$ -value is in bold).**

	<b>PD Group</b> Mean (SD)	<b>NPD Group</b> Mean (SD)	<b><math>p</math>-value</b>
Thoracic Erector Spinae	5.4 (8.1)	7.7 (10.3)	0.650
Lumbar Erector Spinae	18.6 (60.4)	15.6 (27.5)	0.588
Gluteus Maximus	3.4 (6.8)	0.91 (1.0)	<b>0.046</b>

Larger FRR values indicate higher muscle activation in upright standing than in the flexed position. The finding of increased FRR for the gluteus maximus in PD individuals is consistent with earlier reports of gluteal hypoactivity in patients with LBP (Leinonen, Kankaanpaa et al. 2000). Leinonen and colleagues (2000) suggested that the decreased gluteal activation during forward flexion in the patients with LBP was due to deconditioning as a result of the chronicity of their disorder. In this sample, the decreased gluteal activation during flexion occurred in asymptomatic individuals prior to their LBP development during the standing exposure, and therefore cannot be considered as an adaptation to LBP.

### **5.7. Single Leg Stance**

Participants performed five repetitions of a 10-second single leg stance (SLS) task on each leg prior to the prolonged standing exposure. This was included as one of the

functional movements as it is routinely assessed as part of the physical therapy clinical examination. The first trial on each leg, pre-prolonged standing exposure, was selected for analysis to capture response to the initial balance challenge induced by the SLS task and to avoid potential learning effects over the repeated trials. The main outcome measures for SLS included co-contraction of the trunk flexor/extensor muscles (as quantified by CCI), trunk and pelvis kinematics, vertebral joint rotation stiffness (both total ‘active’ VJRS and individual muscle contributions), and total excursion range of the antero-posterior and medio-lateral centre-of pressure. Peak and average gluteus medius activation levels on the stance limb ipsilateral side were also calculated from the normalized EMG.

**5.7.1. Muscle Co-contraction During Single Leg Stance**

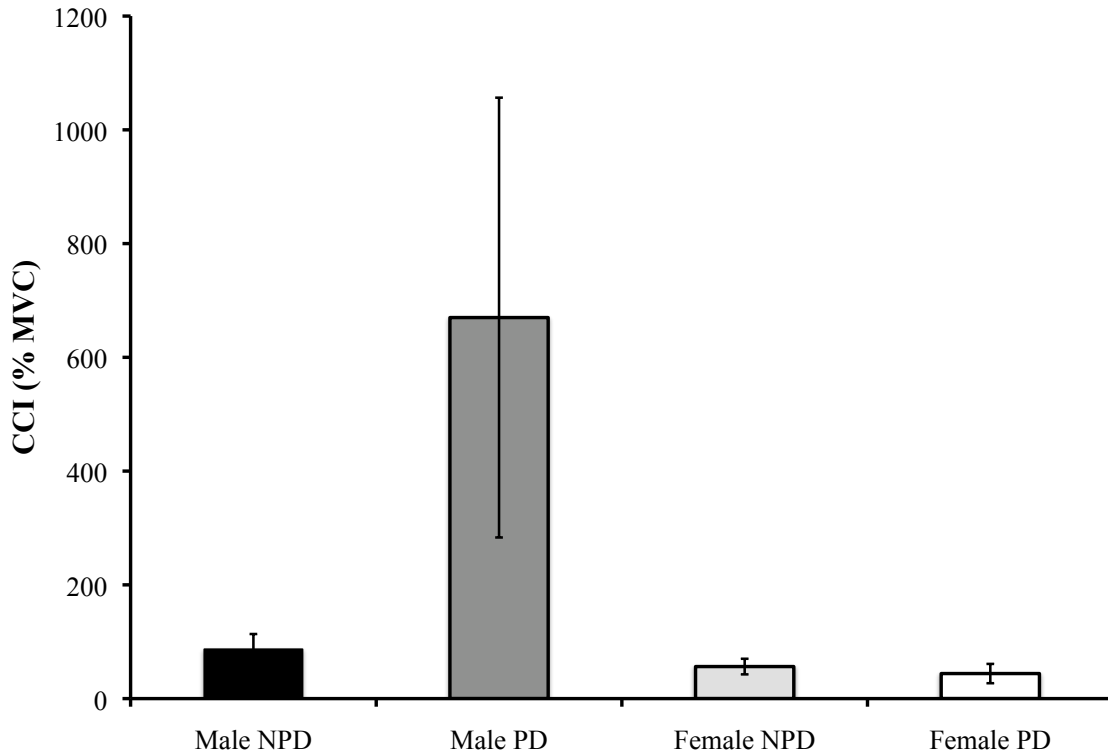
CCI values for each trunk flexor/extensor pair (Table 5.11) were entered into a 2-way general linear model with between factors of PD/NPD group and gender for the first trial of right single leg standing (RSLs) and left single leg standing (LSLS) performed prior to the prolonged standing exposure.

**Table 5.11 The 8 combinations of muscle pairs used for CCI in single leg stance.**

Left Lumbar Erector Spinae (LLES) paired with each of:	Left External Oblique (LEO)
	Left Internal Oblique (LIO)
	Right External Oblique (REO)
	Right Internal Oblique (RIO)
Right Lumbar Erector Spinae (RLES) paired with each of:	Left External Oblique (LEO)
	Left Internal Oblique (LIO)
	Right External Oblique (REO)
	Right Internal Oblique (RIO)

There were no significant differences ( $p > 0.05$ ) between PD/NPD groups or genders on trunk muscle CCI during LSLS. During RSLs, there was a significant interaction

between PD/NPD group and gender on the CCI value for RLES-LIO ( $F_{1,39} = 7.687, p < 0.05$ ), with male PD having higher CCI levels ( $743.2 \pm 141.0$ ) than either male NPD ( $101.8 \pm 96.3$ ), female PD ( $55.3 \pm 118.0$ ) or female NPD ( $68.5 \pm 112.5$ ).



**Figure 5.6 Male pain developers had elevated co-contraction (CCI) of the right lumbar erector spinae - left internal oblique muscles during right single leg standing compared to all other groups ( $p < 0.05$ ).**

### 5.7.2. *Trunk and Pelvis Kinematics During Single Leg Stance*

Three-dimensional trunk and pelvis kinematics during single leg standing were investigated by calculating relative trunk angle (thorax segment relative to pelvis), global pelvis angle (position of pelvis in the GCS) and global thorax angle (position of thorax in the GCS) in Visual3D. The change in rotation from double leg stance (at the beginning of the trial) to single leg stance was the measure of interest. Data from the double leg and single leg phases of the initial SLS trial were averaged to yield stable measures of each



angle about each axis, for each phase, and the difference taken between the two. These angles were entered into a 2-way general linear model with between factors of gender and PD/NPD group.

For LSLs, there were no significant differences between genders or groups and no interactions for any of the angles calculated. Summary data are presented in Table 5.12.

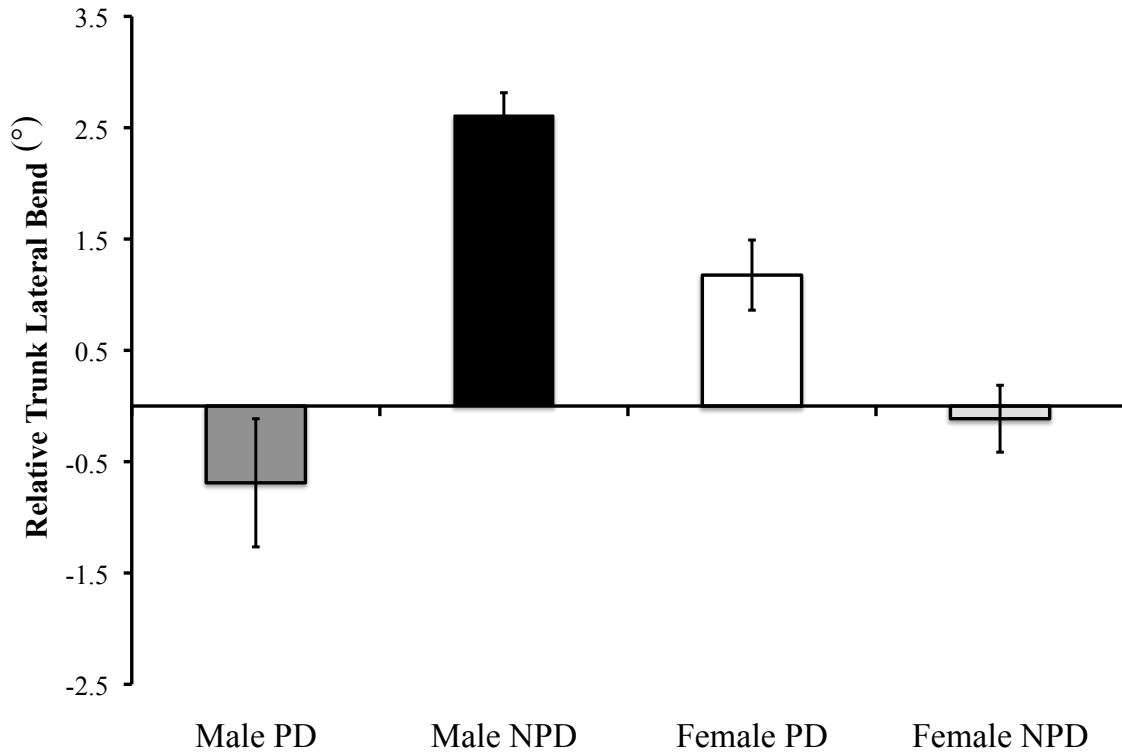
According to the axis convention, lateral bend is +ve to the right, axial twist is +ve to the left, and extension is +ve.

**Table 5.12 Trunk and pelvis angles in left single leg stance (LSLS)**

		Left Single Leg Stance (°)	
		Mean	SD
<b>Trunk Angle</b> (thorax relative to pelvis)	Lateral bend	-1.32	3.54
	Axial twist	0.72	2.08
	Flexion/extension	-1.95	4.71
<b>Pelvis Angle</b> (relative to GCS)	Lateral bend	-2.13	3.16
	Axial twist	-1.37	5.39
	Flexion/extension	0.90	4.47
<b>Thorax Angle</b> (relative to GCS)	Lateral bend	-3.76	3.09
	Axial twist	0.44	5.23
	Flexion/extension	-1.14	3.20

During RSLs, there was a significant PD/NPD group by gender interaction ( $F_{1,38} = 4.674, p < 0.05$ ) for the relative trunk angle about the lateral bend axis, with male PD and female NPD having minimal lateral bend ( $-0.69 \pm 1.4^\circ$  and  $-0.14 \pm 0.95^\circ$  respectively), male NPD and female PD having a larger lateral bend movement towards the ipsilateral limb ( $2.61 \pm 0.78^\circ$  and  $1.18 \pm 1.0^\circ$  respectively). The significant interaction is shown in Figure 5.7. Lateral bend of the trunk towards the ipsilateral stance limb may be a compensation to decrease the demand on the ipsilateral gluteus medius muscles during

SLS by centering the upper body mass over the stance limb. This strategy may be more prevalent in female PD due to anthropometric differences such as a wider pelvis, however it is unclear why the male NPD would demonstrate this same movement strategy.



**Figure 5.7** There were significant PD/NPD group by gender differences ( $p < 0.05$ ) in right single leg standing for the relative trunk angle about the lateral bend axis.

Summary data for the RSLS trunk and pelvis angles are presented in Table 5.13.

**Table 5.13 Trunk and pelvis angles in right single leg stance (RSLS).**

		Right Single Leg Stance (°)	
		Mean	SD
<b>Trunk Angle</b> (thorax relative to pelvis)	Lateral bend	-1.16	3.3
	Axial twist	-0.58	2.35
	Flexion/extension	-2.41	4.99
<b>Pelvis Angle</b> (relative to GCS)	Lateral bend	1.85	2.86
	Axial twist	4.17	4.17
	Flexion/extension	0.73	4.62
<b>Thorax Angle</b> (relative to GCS)	Lateral bend	4.42	2.93
	Axial twist	2.52	4.21
	Flexion/extension	-1.51	3.74

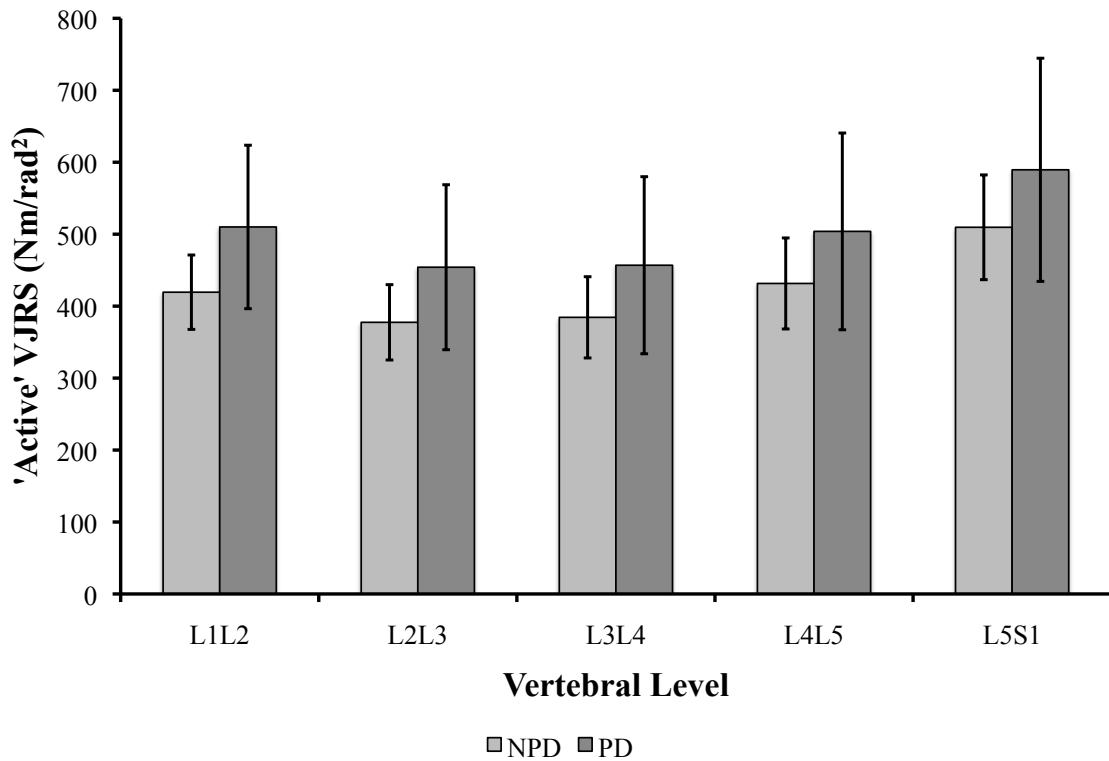
### 5.7.3. Vertebral Joint Rotation Stiffness During Single Leg Stance

There were several participants who could not have vertebral joint rotation stiffness (VJRS) calculations performed on their data for various reasons. One of the male participants (M003) did not tolerate the skin surface markers, and therefore no kinematic data were collected. There was a problem logging the force platform corners for M001, so inverse dynamic calculations could not be performed within the model. Two of the male participants (M013 and M016) had excessive movement of the sacral fin during the squatting task, and the movement artifact was too large to obtain good kinematic or kinetic data. Five participants (M002, M022, F001, F013 and F015) had calculated gain factors (GFs) that were unreasonable ( $GF < 0.10$ ) so total ‘active’ VJRS was not calculated, although individual muscle contribution data were included in the analysis for these participants. This left a sample size for the VJRS analysis of 13 male NPD, 3 male PD, 10 female NPD and 8 female PD for a total  $N = 34$ .

The peak and average ‘active’ VJRS values for right and left SLS were entered into a 3-way general linear model with between factor of PD/NPD group and within factors of

vertebral level (5) and rotation axis (3). Due to the fact that the anatomical model does not account for gender differences and is based on empirical data obtained from males only (Cholewicki and McGill 1996), combined with the small sample sizes in the subgroups due to missing data, gender was not included as a factor for the VJRS analyses.

There were no statistically significant differences in peak or average VJRS values during left or right SLS. Figure 5.8 shows average 'active' VJRS data by level for PD and NPD groups during RSLs. Data has been averaged across the three axes to provide an average rotation stiffness value for each vertebral level.

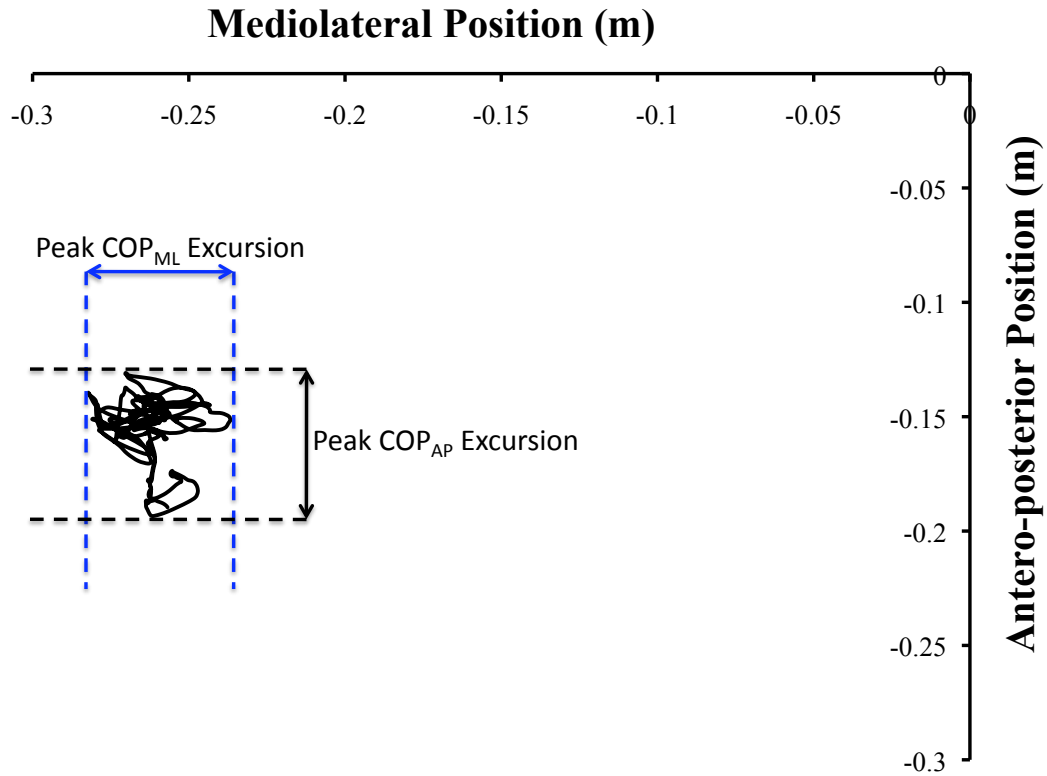


**Figure 5.8 'Active' VJRS by vertebral level during RSLs had no differences between PD/NPD groups.**

The average and peak values for the relative stiffness contribution from each individual muscle were entered separately into a 3-way general linear model with between factor of PD/NPD group, and within factors of vertebral level (5) and rotation axis (3). There were no main effects or interactions that included the variables of interest for any of the individual muscle contributions to VJRS indicating that PD and NPD did not recruit their muscles differently to stabilize the lumbar spine during single leg standing.

#### ***5.7.4. Centre of Pressure Excursion During Single Leg Stance***

Medio-lateral ( $COP_{ML}$ ) and antero-posterior ( $COP_{AP}$ ) centre-of pressures during SLS were calculated from the force platform data as described previously. Magnitude of peak COP excursion in each direction was calculated by taking the difference between the minimum and maximum  $COP_{AP}$  and  $COP_{ML}$  values (Figure 5.9). This provided some quantification of the ‘worst-case’ balance for each participant during single leg stance.



**Figure 5.9** Representative centre-of-pressure plot during LSLs showing how peak excursion was calculated. Note the origin is located in the centre of the force platform.

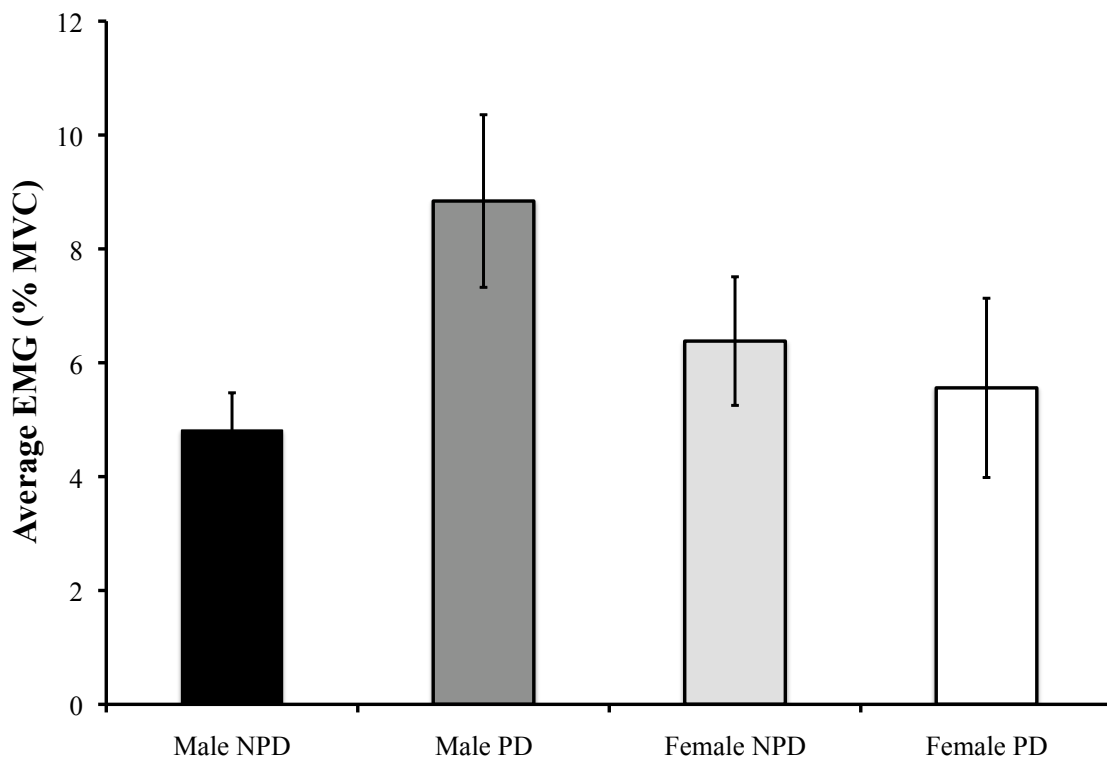
Peak excursion values were then entered into a 4-way general linear model with between factors of PD/NPD group and gender, and within factors of COP direction (AP or ML) and stance limb (right or left). There were no significant main effects or interactions for any of the factors tested. Averaged data across participants is presented in Table 5.14.

**Table 5.14** Peak centre-of-pressure (COP) excursion (averaged across participants) during single leg stance.

	<b>Left Single Leg Stand</b> Mean (SD)	<b>Right Single Leg Stand</b> Mean (SD)
Peak COP <sub>AP</sub> Excursion (cm)	6.95 (2.74)	8.07 (6.62)
Peak COP <sub>ML</sub> Excursion (cm)	3.40 (1.42)	3.81 (1.63)

### 5.7.5. *Gluteus Medius Muscle Activation Levels*

Peak and average EMG values for the gluteus medius during the first trial of SLS prior to prolonged standing were entered into 2-way general linear models with between factors of PD/NPD group and gender. There were no significant differences found in RSLs, however in LSLs there was a significant PD/NPD group by gender interaction for both peak ( $F_{1,34} = 6.478, P < 0.05$ ) and average ( $F_{1,34} = 6.945, p < 0.05$ ) left gluteus medius. As is shown in Figure 5.10, the male PD used a significantly higher percentage of their left gluteus medius capacity, as quantified by % MVC, during LSLs than male NPD and either female PD/NPD group.



**Figure 5.10** Average normalized EMG for left gluteus medius during LSLs shows male PD had higher % MVC activation levels than the other 3 groups ( $p < 0.05$ ).

It appears that the male PD required higher level activations to maintain the same balance in LSLS as the other groups since there were no differences in COP excursion.

#### **5.7.6. Conclusions – Single Leg Stance**

Differences in postural control and postural response to perturbations and balance challenges have been found in previous studies between individuals with LBP and healthy controls (Mok, Brauer et al. 2004; Brumagne, Janssens et al. 2008; Gregory, Brown et al. 2008). Findings from this research provide some support for previous work where increases in muscle co-activation and stiffness in people with LBP exposed to a perturbation have been reported.

Mok and colleagues (2004), in a comparison of balance responses between individuals with LBP and healthy controls under varying conditions, found that people with LBP had generally poorer balance than healthy controls, primarily demonstrated as decreased hip strategy under narrow base conditions. These authors did not investigate muscle activation, however they hypothesized that this decrease in hip strategy was the result of increased trunk stiffness due to increased muscle activation. In the current study, males who were predisposed to become PD responded to a balance challenge, in this case single leg stance, with an increase in trunk muscle co-activation (on RLS) and increased activation of the left gluteus medius muscle during LSLS. There were gender differences, with female PD exhibiting no change in muscle co-activation, or gluteus medius activation. There were no group differences found in estimated trunk stiffness, represented by VJRS analyses, in response to single leg standing.

Given previous reports in the literature of impaired balance and postural control in people with LBP (Mok, Brauer et al. 2004), it was of interest that this did not seem to be a



predisposing factor for pain development in this sample, as indicated by total COP excursion during a balance challenge. Mok et al. (2004) also found no group differences in COP excursion during unilateral stance, although they did elicit differences in more challenging balance conditions. It is possible that single leg standing as presented was not a sufficient challenge to elicit differences in this young and relatively physically active sample.

There were side-to-side differences observed on several of these outcome measures. Participants were contacted by e-mail during data analysis (well after data collection had taken place), and were asked to answer the question ‘which leg would you use if you were going to kick a ball?’ in an attempt to establish leg dominance as a potential factor. 39 out of 43 participants responded (90.7%), and of those 92.3% were right leg dominant and only 7.7% were left leg dominant. Of the three participants that reported left leg as their dominant side, one was male PD, and the other two were male NPD. These participants did not appear to be outliers on any of the outcome measures reported.

### **5.8. Vertebral Joint Rotation Stiffness During the Squat Movement**

Vertebral joint rotation stiffness (VJRS) was also calculated for the first trial of the squat movement. The squat movement was partitioned into ‘down’ and ‘up’ phases by extracting the frames at which the knee angle started to move into flexion to begin the squat and the point of maximal knee flexion at the lowest point of the squat. As before, peak and average ‘active’ VJRS values for each phase were entered into a 3-way general linear model with a between factor of PD/NPD group and within factors of vertebral level (5) and rotation axis (3). The relative contributions to ‘active’ VJRS for each muscle group were also entered into 3-way general linear models with the same factors.

There were no significant differences between PD/NPD groups during either phase of the squat on peak or average ‘active’ VJRS. However, there were significant differences in the relative contribution from the external oblique (EO) muscles. There was a main effect of PD/NPD group for the down phase of the squat on both average ( $F_{1,38} = 4.746, p < 0.05$ ) and peak ( $F_{1,38} = 5.671, p < 0.05$ ) contributions, and on the up phase of the squat for average contribution ( $F_{1,38} = 4.269, p < 0.05$ ), with PD individuals having a higher percentage contribution of EO to vertebral rotational stiffness than NPD (Table 5.15).

**Table 5.15 Relative contribution of external oblique to VJRS during squatting (significant  $p$ -values in bold).**

		<b>NPD (%)</b> Mean (SE)	<b>PD (%)</b> Mean (SE)	<b><math>p</math>-value</b>
Down Phase	Peak	18.2 (2.26)	27.1 (2.94)	<b>0.022</b>
	Average	9.8 (1.43)	14.9 (1.9)	<b>0.036</b>
Up Phase	Peak	17.59 (2.25)	24.23 (2.93)	0.080
	Average	9.27 (1.4)	14.0 (1.82)	<b>0.046</b>

While there were no statistical differences in overall ‘active’ vertebral rotational stiffness during squatting, there were differences between PD and NPD groups in how the musculature was contributing to achieve this stiffness. It is of interest that there was a significant increase in EO contribution but no significant decrease in any one of the other 9 muscle groups modeled. This suggests that the necessary compensation was distributed across the other muscle groups. The finding that PD individuals had higher contributions to vertebral joint rotational stiffness from the external oblique muscle group provides further support for the idea that individuals who are predisposed to LBP development during standing have different patterns of muscle activation and coordination than individuals who are at low risk. The squat trial that was used for this analysis was

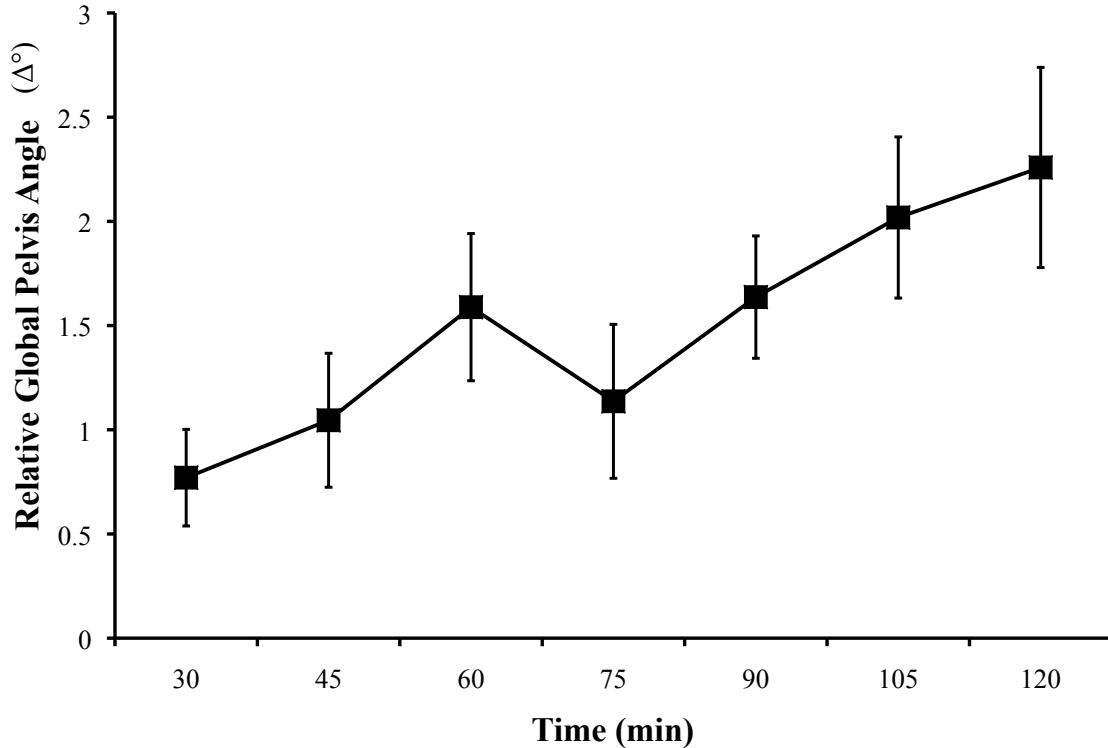
performed prior to the standing exposure, and prior to these individuals reporting any increase in their VAS score, therefore the differences that were found could not be considered to be adaptive to LBP.

### **5.9. Trunk and Pelvis Kinematics During Prolonged Standing**

To determine postural changes over the 2-hour standing exposure, trunk angle (thorax relative to pelvis) and global pelvis angle (pelvis position in the GCS) were calculated for each 15-minute window. As a data reduction measure, and to gain a general sense of how the overall postures were changing, mean values were taken over each 15-minute window. The difference from the initial 15-minute window was taken to investigate postural change during the standing exposure. The mean value about each axis was then entered into a 3-way general linear model with between factors of PD/NPD group and gender, and within factor of time (7 repeated measures). A multivariate analysis of the mean values about each axis from the first 15-minute window (comparison window) was conducted with between factors of gender and PD/NPD group also to determine if there were differences in posture at the beginning of the standing period. These data were not found to be spherical with Mauchly's Test, and therefore Huynh-Feldt adjusted  $p$ -values were used.

There were no significant main effects and no interactions for either the initial window of standing or over the 2-hour standing period for either relative trunk or global pelvis angles. There was a main effect of time on global pelvis angle about the flexion/extension axis ( $F_{4,596, 174.6} = 4.481, p < 0.01$ ) with participants increasing pelvis posterior tilt over the 2-hour period (Figure 5.11). There was no commensurate effect of time on relative

trunk angle, indicating that the changes at the pelvis were accommodated by concomitant changes at the thorax resulting in a stable relative trunk angle.



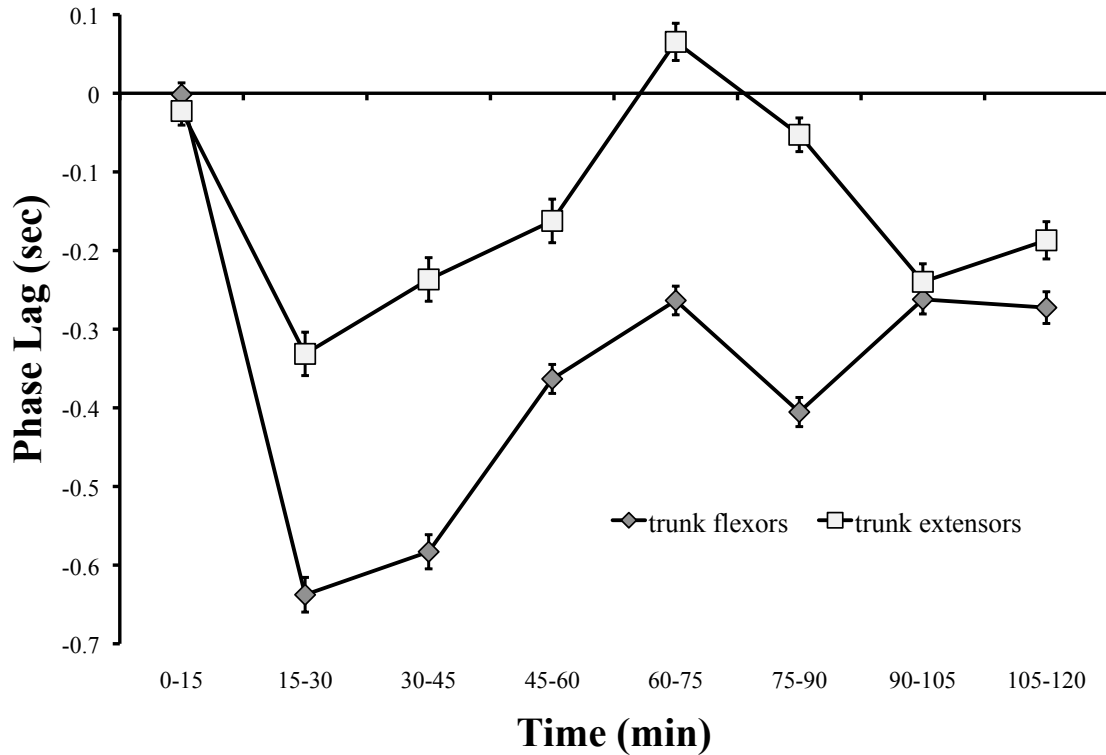
**Figure 5.11** Participants had a general increase in pelvis posterior tilt over the 2-hours standing period ( $p < 0.01$ ). The difference from the initial pelvis position at the beginning of the trial is shown to demonstrate changes over time.

It must be noted that these are very gross measures since the thorax was modeled as a single rigid segment in this study, as opposed to 5 lumbar and 12 thoracic vertebrae, and therefore subtle changes would potentially be missed. Also, for data reduction measures, the time-varying component of the postural changes was removed by collapsing the data into mean values, again resulting in a coarse measure that may not be sensitive to subtle differences. A previous study done with a similar protocol (Gregory and Callaghan 2008)

reported an increase in lumbar flexion over 2-hours of standing, however this flexion increase was not observed in the individuals in the current study.

### **5.10. Phase Relationships/Timing**

EMG for each monitored trunk muscle was cross-correlated against the right gluteus medius (RGMd) EMG and the phase lag,  $\tau$ , at the occurrence of maximum correlation was extracted. No differences between groups or genders and no interactions were detected. There was a consistent pattern for all participants to activate most of the monitored trunk muscles following the RGMd, as shown by negative phase lag values, indicating a predominantly ‘bottom-up’ control strategy. Figure 5.12 shows average phase lag values for the trunk flexor and extensor groups combined during 2-hours of standing, with predominantly negative values.



**Figure 5.12 Average phase lags between trunk flexor and extensor muscles and right gluteus medius over 2-hours of standing indicate a bottom up postural control strategy.**

Phase lags between the trunk muscle activations relative to the right gluteus medius were examined in an attempt to determine whether coordination of muscle activation patterns played a role during acute pain development. The right gluteus medius muscle was chosen as a reference as it was at a distal endpoint of the kinetic chain for muscles being monitored, and enabled the discussion of muscle onsets within the context of ‘top-down’ versus ‘bottom-up’ control. A ‘top-down’ control strategy has been shown previously for the trunk muscles during walking and during perturbations in standing (Prince, Winter et al. 1994), however the hip musculature was not monitored in that study. The participants in this study utilized a primarily ‘bottom-up’ control strategy, and this did not appear to

be influenced by gender or by pain development. It should be noted that this is a coarse measure of postural control since data has been collapsed across 15-minute windows.

### **5.11. Muscle Co-Contraction Index**

Data for F021 (NPD<sub>CON</sub> group) were excluded for gluteus medius CCI due to EMG signal drop out on the gluteus medius during the prolonged standing protocol. Co-contraction Index (CCI) values from each of the possible muscle pair combinations (120 combinations) during standing were entered into 3-way general linear models with between factors of PD/NPD group and gender, and a within factor of time (8 repeated measures). These data were found to violate sphericity assumptions on Mauchly's Test, and therefore Huynh-Feldt adjusted *p*-values were used for statistical significance.

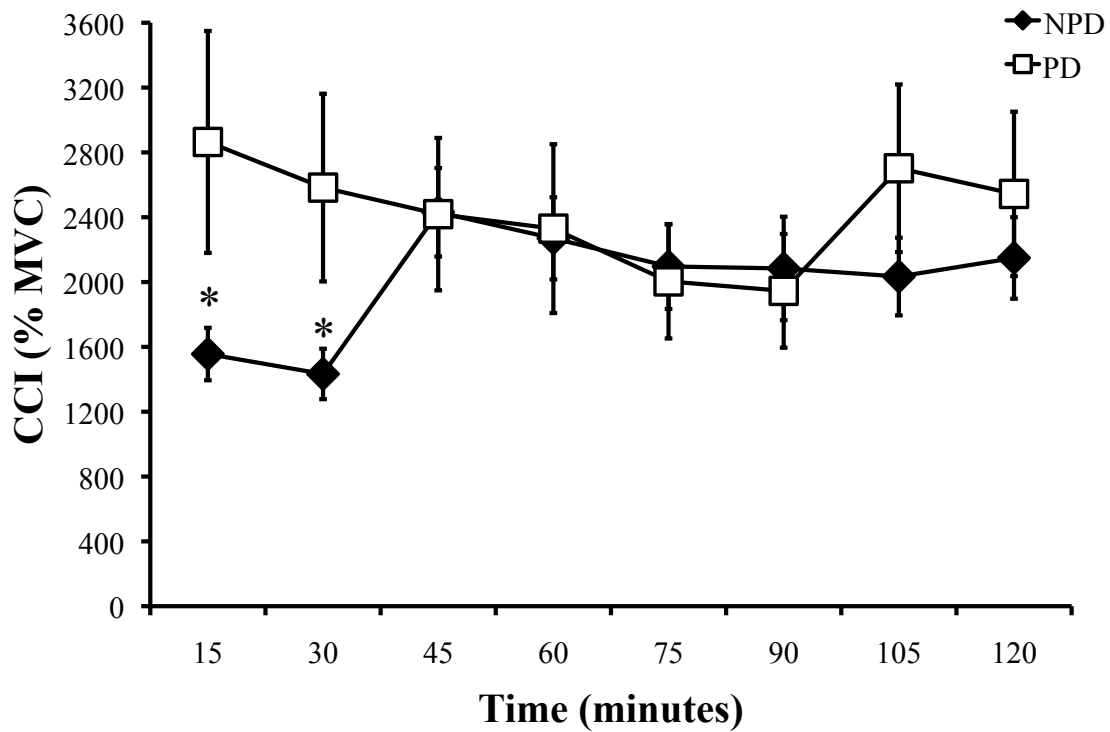
There were no gender effects for any of the CCI results. Therefore the general linear model was collapsed to include only the between factor of group. For each of the trunk flexor-extensor combinations, there were significant time by group interactions with the PD group showing higher levels of muscle co-activation than the NPD group at the beginning and end of the 2-h standing period. As a data reduction measure, an average was taken of the CCI-values over the 12 flexor-extensor combinations (Table 5.16) to yield a global flexor-extensor CCI value for each 15-minute block.

**Table 5.16 The 12 combinations of flexor/extensor muscle pairs that were used for CCI during standing**

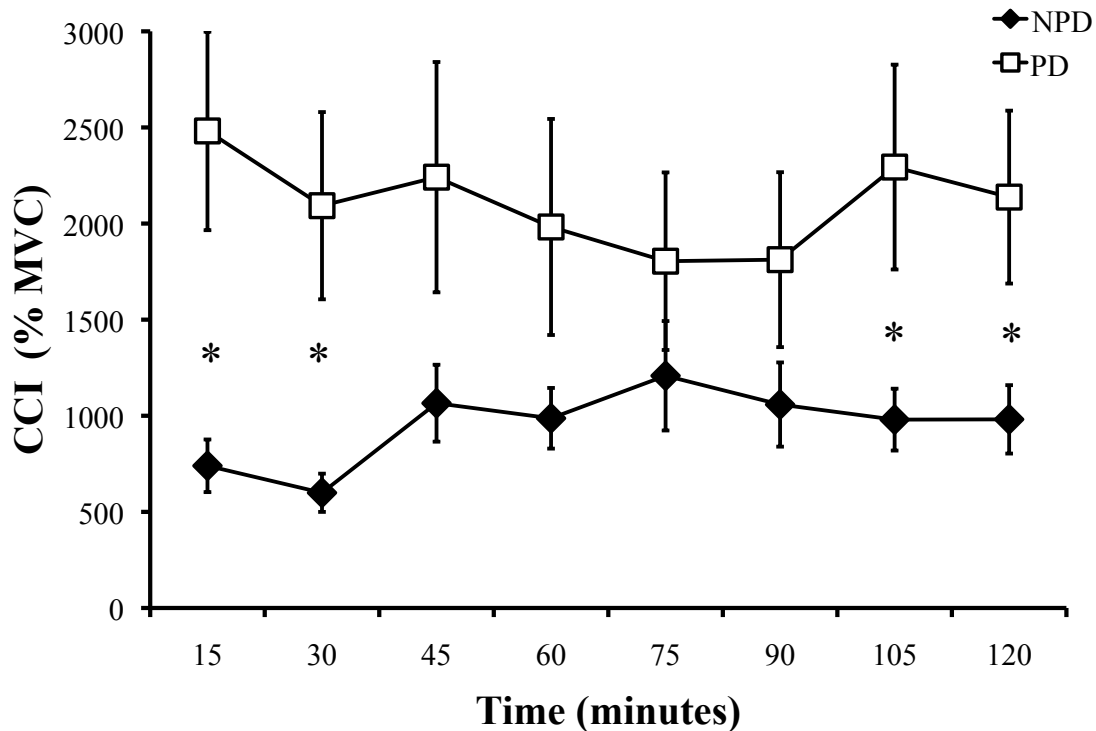
Left Lumbar Erector Spinae (LLES) paired with each of:	Left Rectus Abdominus (LRA)
	Right Rectus Abdominus (RRA)
	Left External Oblique (LEO)
	Right External Oblique (REO)
	Left Internal Oblique (LIO)
	Right Internal Oblique (RIO)
Right Lumbar Erector Spinae (RLES) paired with each of:	Left Rectus Abdominus (LRA)
	Right Rectus Abdominus (RRA)
	Left External Oblique (LEO)
	Right External Oblique (REO)
	Left Internal Oblique (LIO)
	Right Internal Oblique (RIO)

When this global measure was entered into the GLM as described previously, there remained a strong time by group interaction,  $F_{(3.334,130.023)} = 4.108, p < 0.01$  (Figure 5.13). There was also a time by group interaction on the CCI value for bilateral gluteus medius (CCI\_GMd), with the pain developers showing significantly higher levels of bilateral gluteus medius co-activation during the first and final 30 minutes of standing  $F_{(3.62,133.9)} = 2.742, p < 0.05$  (Figure 5.14). PD as a group exhibited increased co-activation muscle patterns as a precursor to the increase in their subjective reports of pain development.





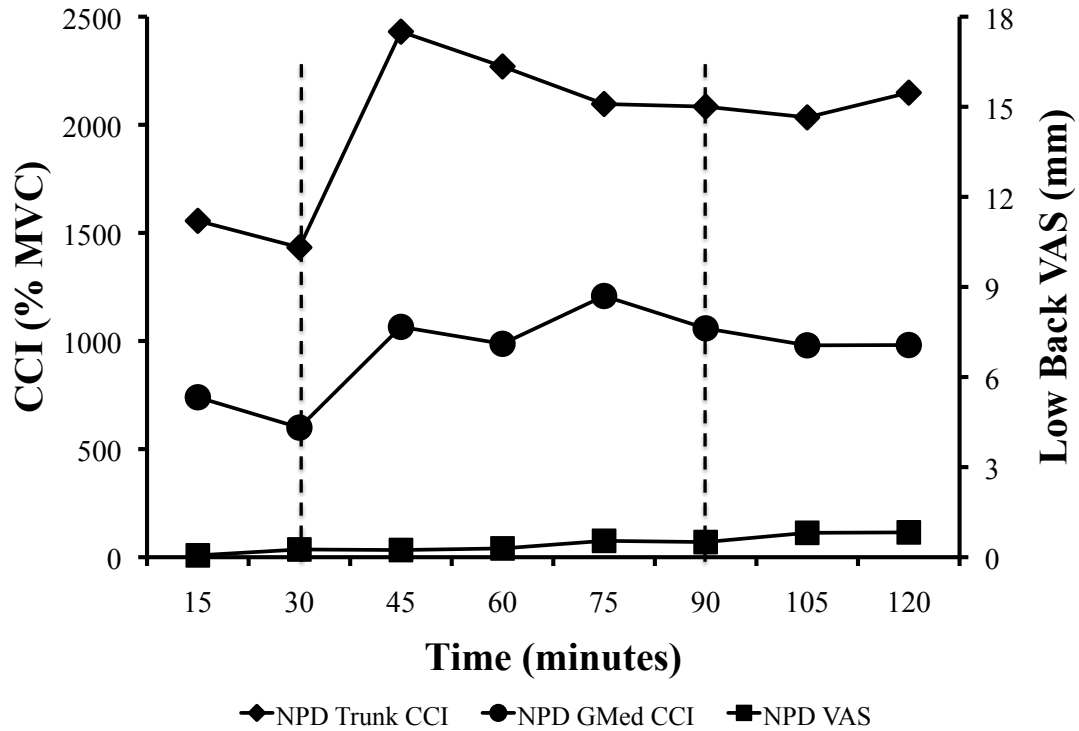
**Figure 5.13** Trunk flexor-extensor co-contraction index (CCI) over time shows differing levels of co-contraction index between groups during the initial 30 minutes of standing. \* indicates significant differences,  $p < 0.05$ .



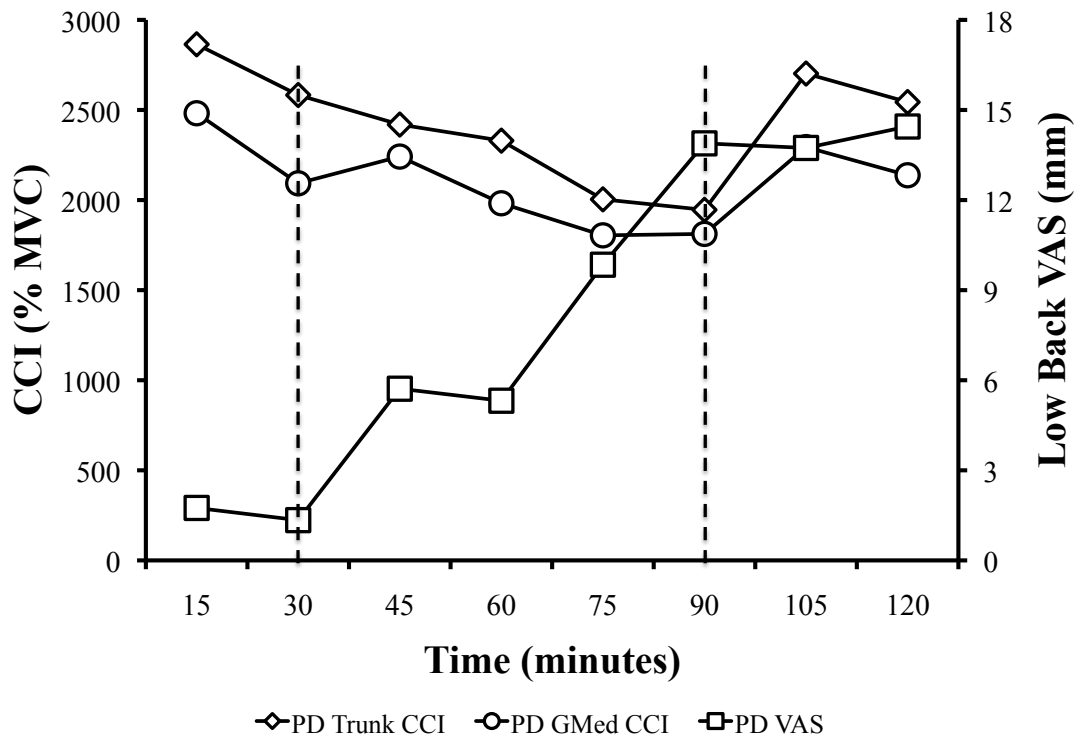
**Figure 5.14 Right and left gluteus medius co-contraction index (CCI) over time shows higher muscle co-activation for the PD group versus the NPD group during the initial and final 30 minutes of standing. \* indicates significant differences,  $p < 0.05$ .**

During the time period from 30 – 90 minutes, the NPD group had an increase in trunk muscle co-activation without any commensurate increase in pain rating levels (Figure 5.15). The PD group showed the reverse pattern with a general decrease in muscle-co-activation, although this was the time period where VAS rating was increasing the most (Figure 5.16). During this period of acute pain development, there was a strong negative correlation between VAS score and co-contraction index for the bilateral gluteus medius and trunk flexor-extensor groups ( $r = - 0.73$  and  $r = - 0.92$  respectively). The co-contraction indices for these muscle groups were negatively correlated ( $r = - 0.39$  for

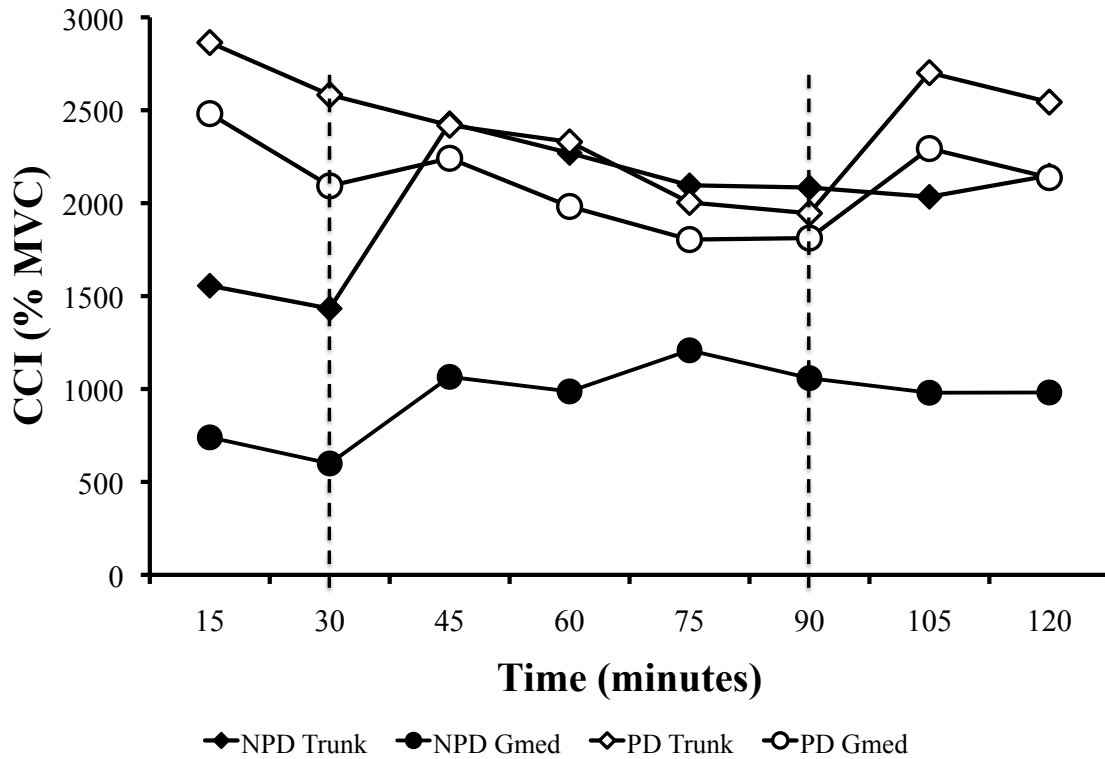
gluteus medius, and  $r = - 0.18$  for trunk flexor-extensors) for the PD and NPD groups, showing a clearly different muscle co-activation pattern (Figure 5.17).



**Figure 5.15** Over the 2-h prolonged standing period, the NPD group showed an average increase in co-activation of both the trunk flexor-extensor and bilateral gluteus medius muscles.



**Figure 5.16** During acute pain development, steepest slope of VAS, the PD group had a decrease in co-activation of trunk flexor-extensors and bilateral gluteus medius muscles. Co-activation of both muscle groups increased again at the end of the standing period, while VAS leveled off.



**Figure 5.17 Time-varying co-activation patterns for trunk flexor-extensor and bilateral gluteus medius muscles were negatively correlated between PD and NPD during the time period of acute pain development (decreasing levels for PD and increasing for NPD).**

Two hours of prolonged standing exposure produced a sub-group that demonstrated clear differences in muscle co-activation patterns that predicted their subjective pain ratings. The PD and NPD groups utilized clearly different strategies during the time period from 30-90 minutes with the NPD group increasing co-activation of the trunk and gluteus medius muscles during this timeframe. Increased trunk muscle co-activation during a prolonged posture may be an appropriate motor control strategy to maintain a relatively static posture in a pain free state. The pain-developing group did not utilize the same strategy, and in effect, seemed to rely less on this mechanism during the period of their

greatest pain development. During the final 30-minutes of standing the PD group increased their gluteus medius muscle co-activation levels once more, and this was the time period where their VAS scores leveled off, or stabilized. The question remains as to whether this was an adaptive response to their increasing discomfort that resulted in a motor pattern change, or whether LBP was stabilizing for some other reason which allowed the participants to revert to their ‘usual’ muscle co-activation pattern.

### **5.12. Average Muscle Activation Patterns During Standing**

To investigate potential differences in magnitude of muscle activation during standing, averages were taken over each 15-minute block of the normalized EMG for each monitored muscle group. Additionally, a Gaps analysis was performed to determine if there were differences in the amount of rest time for individual muscles during the static standing task. A ‘Gap’ was defined as the period of time when the EMG level dropped below 0.5% MVC for a period of 0.2 seconds or longer (Veiersted, Westgaard et al. 1990). The number of Gaps for each monitored muscle, average duration for each Gap, and total Gap time was calculated for each 15-minute block during the 2-hour standing protocol. As a first screening step, every variable of interest for each muscle group was entered into a 2-way general linear model with between factors of PD/NPD group and gender for each 15-minute block, and any significant findings were noted. The variables that were found to be significant were then entered into 3-way general linear models for each muscle group with between factors of PD/NPD group and gender, and within factor of time (8 repeated measures over the 2-hours) to capture the time-varying behaviour of these measures over the 2-hour standing exposure. Where data were found to violate

sphericity assumptions with Mauchly's Test, Huynh-Feldt adjusted  $p$ -values were used for significance. Only significant findings are reported here.

### 5.12.1. Average EMG Values During Standing Exposure

Average EMG values were in general very small during the 2-hour standing exposure, as expected due to the low-demand nature of the task. Summary data for average EMG values for each monitored muscle are presented in Table 5.17.

**Table 5.17 Summary data for average EMG activation during 2-hours of standing exposure**

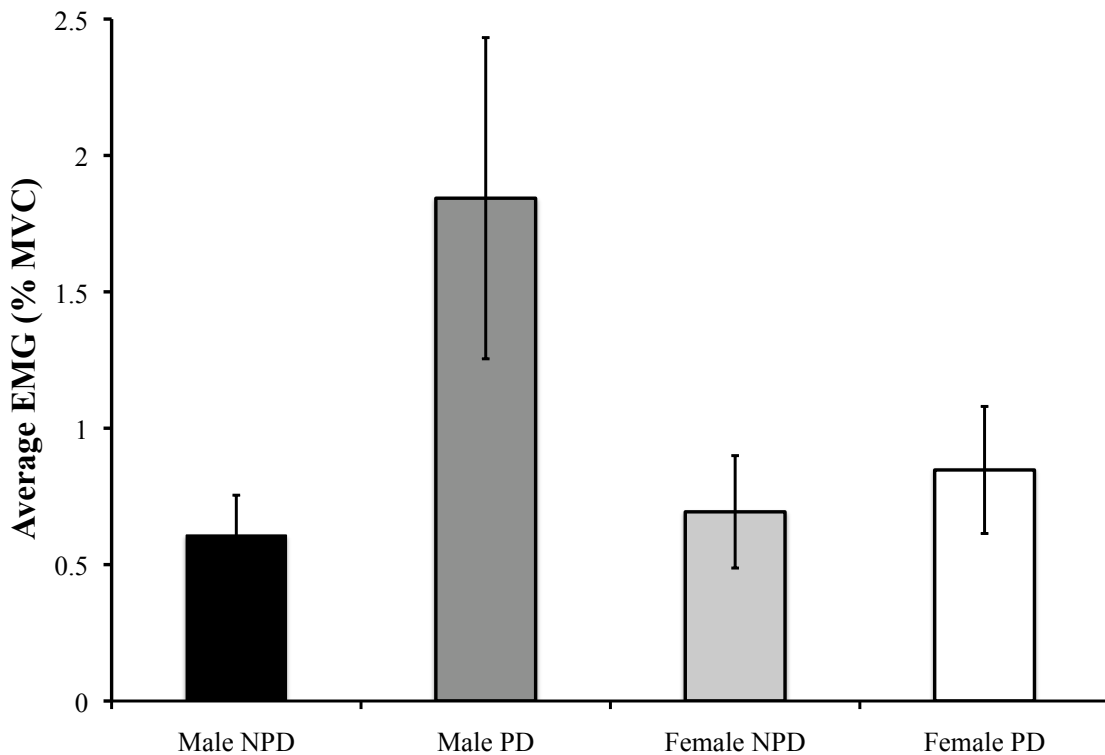
<b>Muscle Group</b>	<b>Average EMG (% MVC)</b>	<b>SD</b>
<b>Right Thoracic Erector Spinae</b>	2.02	1.30
<b>Right Lumbar Erector Spinae</b>	1.96	1.04
<b>Right Latissimus Dorsi</b>	0.57	0.51
<b>Right Rectus Abdominus</b>	0.25	0.22
<b>Right Internal Oblique</b>	2.17	1.89
<b>Right External Oblique</b>	1.32	1.57
<b>Right Gluteus Medius</b>	0.89	0.81
<b>Right Gluteus Maximus</b>	0.73	0.93
<b>Left Thoracic Erector Spinae</b>	1.78	1.17
<b>Left Lumbar Erector Spinae</b>	2.06	1.50
<b>Left Latissimus Dorsi</b>	0.64	0.70
<b>Left Rectus Abdominus</b>	0.25	0.32
<b>Left Internal Oblique</b>	2.20	1.56
<b>Left External Oblique</b>	0.91	0.97
<b>Left Gluteus Medius</b>	1.04	0.99
<b>Left Gluteus Maximus</b>	0.74	1.33

There were significant effects of PD/NPD group in the average EMG for left gluteus medius ( $F_{1,37} = 5.434, p < 0.05$ ), left gluteus maximus ( $F_{1,37} = 4.309, p < 0.05$ ) and right gluteus maximus ( $F_{1,37} = 7.895, p < 0.01$ ) muscles, with PD having larger average EMG values over the 2-hours than NPD for all three of these muscle groups Table 5.18.

**Table 5.18 Average EMG values that had significant PD/NPD group differences during prolonged standing exposure.**

	<b>NPD (%MVC)</b> Mean (SE)	<b>PD (%MVC)</b> Mean (SE)	<b><i>p</i>-value</b>
Left Gluteus Medius	0.761 (0.195)	1.485 (0.241)	<b>0.025</b>
Left Gluteus Maximus	0.401 (0.265)	1.274 (0.327)	<b>0.045</b>
Right Gluteus Maximus	0.427 (0.180)	1.229 (0.222)	<b>0.008</b>

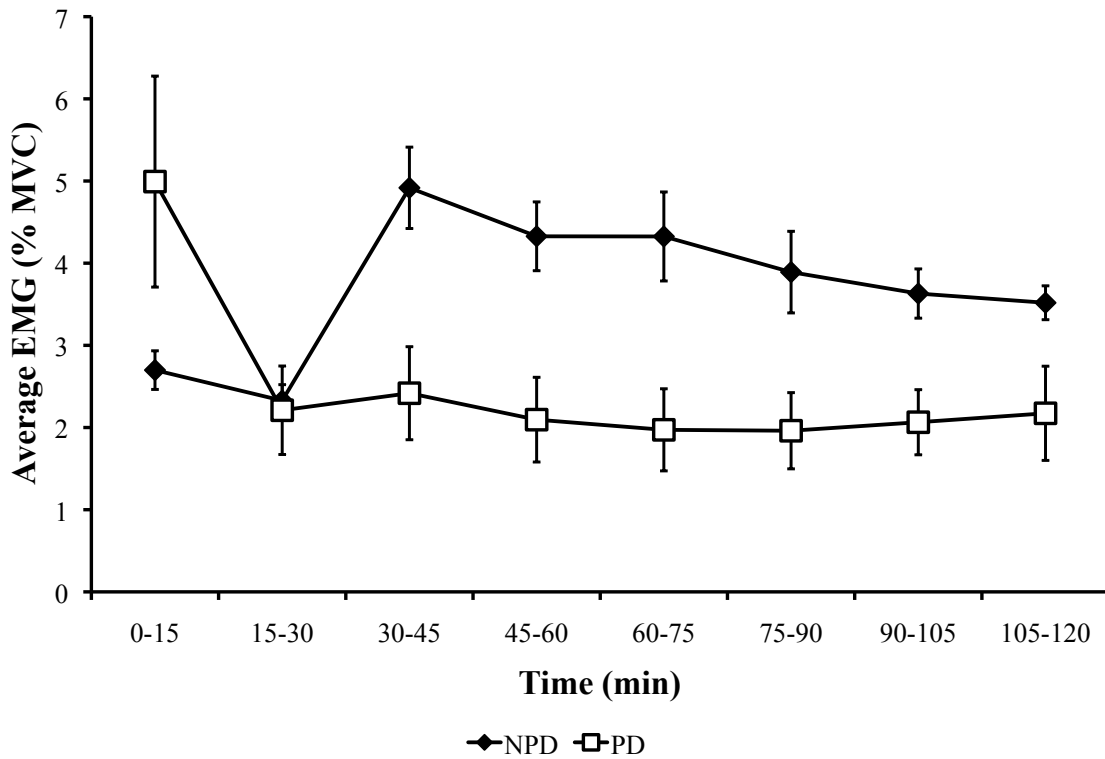
There was a significant PD/NPD group by gender interaction ( $F_{1,37} = 5.657, p < 0.05$ ) for the right gluteus medius muscle (Figure 5.18), with male PD having higher average activation of the right gluteus medius muscle over the 2-hour standing exposure than the other three groups.



**Figure 5.18 The Right Gluteus Medius muscle had higher activation levels ( $p < 0.05$ ) during standing for male pain developers compared with the other 3 groups.**



There was a significant time by PD/NPD group interaction ( $F_{3,853,142.569} = 2.643, p < 0.05$ ) for the right lumbar erector spinae (RLES) muscle. The PD group initially had higher average RLES activation levels than the NPD group, but they decreased to very low magnitudes (2% MVC) after the initial 15 minutes of standing while the NPD group increased RLES activation after the initial 15-minute block (Figure 5.19).



**Figure 5.19 PD/NPD groups had different patterns of RLES muscle activation magnitudes ( $p < 0.05$ ) over the 2-hour standing exposure.**

### 5.12.2. Gaps Analyses

There were no significant differences in total number of Gaps (for each 15-minute block) or in the average Gap duration (total Gap time divided by the total number of Gaps for each 15-minute block). Summary data for the total number of Gaps over the 2-hour

standing exposure, the average number of Gaps over each 15-minute window, and the average Gap length are presented for each monitored muscle in Table 5.19.

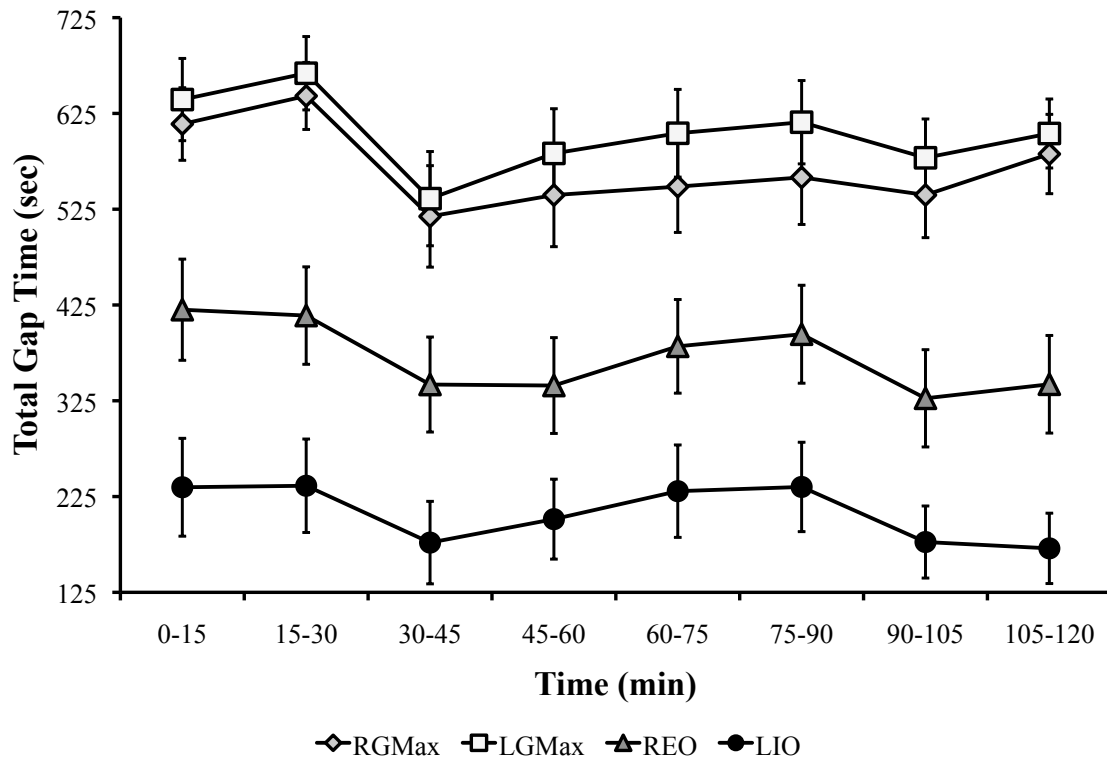
**Table 5.19 Summary data for Gaps analysis during 2-hours of standing exposure**

<b>Muscle Group</b>	<b>Total Gap # Mean (SD)</b>	<b>Ave Gap # Mean (SD)</b>	<b>Ave Gap Time (s) Mean (SD)</b>
<b>Right Thoracic Erector Spinae</b>	1926.7 (1384.8)	240.8 (173.1)	1.82 (2.95)
<b>Right Lumbar Erector Spinae</b>	1990.1 (807.9)	248.8 (101.0)	1.40 (1.36)
<b>Right Latissimus Dorsi</b>	2236.9 (1974.9)	279.6 (246.9)	45.8 (150.3)
<b>Right Rectus Abdominus</b>	2384.0 (2735.0)	298.0 (341.9)	82.2 (159.2)
<b>Right Internal Oblique</b>	1791.6 (1968.8)	224.0 (246.1)	1.67 (5.47)
<b>Right External Oblique</b>	2610.2 (1829.2)	326.3 (228.6)	5.40 (16.61)
<b>Right Gluteus Medius</b>	2297.2 (1771.1)	287.2 (221.4)	23.05 (83.04)
<b>Right Gluteus Maximus</b>	1901.2 (1567.8)	237.6 (196.0)	20.90 (52.44)
<b>Left Thoracic Erector Spinae</b>	2158.5 (1411.9)	269.8 (176.5)	26.38 (133.41)
<b>Left Lumbar Erector Spinae</b>	1753.5 (946.8)	219.2 (118.4)	23.39 (5.71)
<b>Left Latissimus Dorsi</b>	2081.3 (1966.2)	260.2 (245.8)	45.03 (147.7)
<b>Left Rectus Abdominus</b>	1638.9 (2391.8)	204.9 (299.0)	82.92 (171.6)
<b>Left Internal Oblique</b>	1352.5 (1949.3)	169.1 (243.7)	3.75 (15.84)
<b>Left External Oblique</b>	3232.8 (2276.6)	404.1 (284.6)	4.37 (9.97)
<b>Left Gluteus Medius</b>	1476.8 (1093.7)	184.6 (136.7)	28.18 (140.0)
<b>Left Gluteus Maximus</b>	1624.8 (1598.7)	203.1 (199.8)	39.25 (96.0)

There were several significant differences in the variable of total Gap time (summation of all of the Gap durations for each 15-minute block). There was a significant main effect of time for the right external oblique ( $F_{3,783,139,953} = 4.933, p < 0.01$ ), right gluteus maximus ( $F_{3,394,125,591} = 3.138, p < 0.05$ ), left internal oblique ( $F_{3,253,120,345} = 2.794, p < 0.05$ ), and left gluteus maximus ( $F_{3,849,142,395} = 3.217, p < 0.05$ ) muscles, with all of these muscle groups having a progressive decrease in the total Gap time over the eight 15-minute blocks. This indicates a progressive decrease in the amount of rest time for these muscles as standing duration increased. Summary data are shown in Table 5.20 and graphically in Figure 5.20.

**Table 5.20 Total Gap time for each 15-minute block for the muscles that had significant main effects of time**

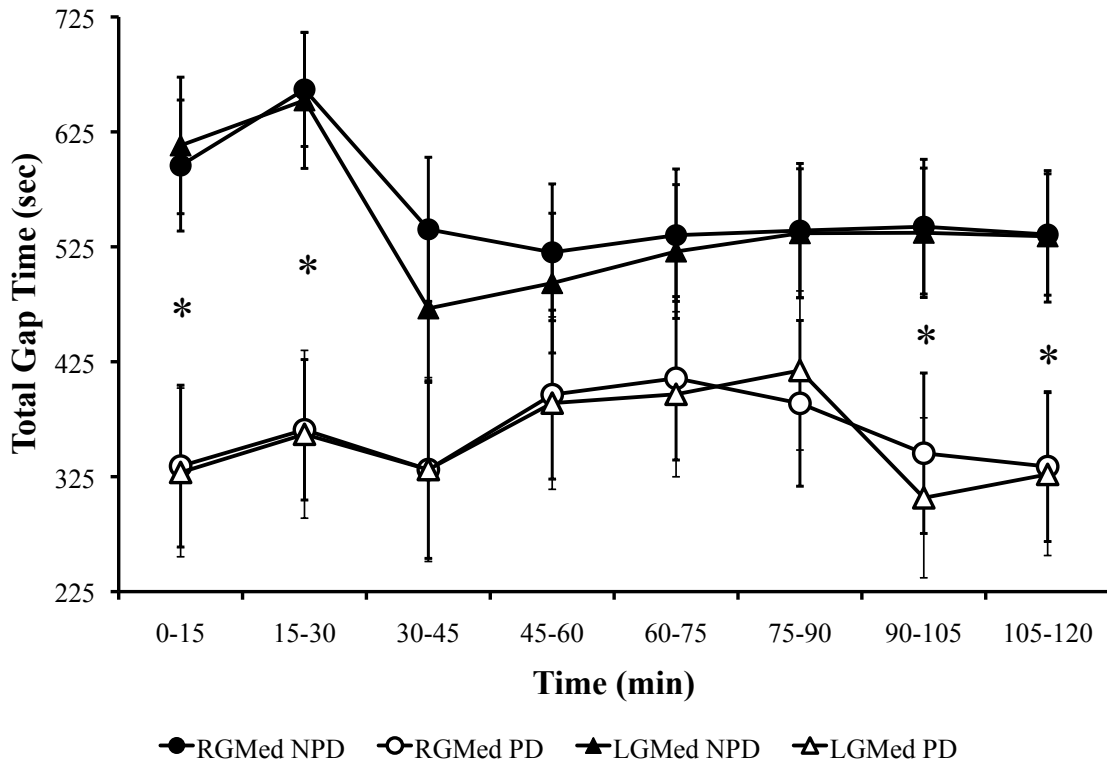
Time Block	Right EO (s) Mean (SE)	R GMax (s) Mean (SE)	Left IO (s) Mean (SE)	L GMax (s) Mean (SE)
0-15 min	420.1 (52.8)	613.9 (37.9)	234.7 (51.1)	639.5 (42.9)
15-30 min	414.0 (50.9)	643.4 (35.0)	236.3 (48.8)	667.0 (38.3)
30-45 min	342.0 (49.6)	517.5 (53.0)	176.9 (43.1)	536.0 (49.2)
45-60 min	340.9 (50.0)	539.8 (53.9)	201.4 (41.7)	583.2 (46.7)
60-75 min	381.8 (48.9)	548.6 (47.9)	230.6 (48.3)	604.3 (45.8)
75-90 min	394.5 (51.1)	558.2 (49.2)	235.0 (46.7)	615.8 (43.5)
90 – 105 min	327.6 (50.8)	539.8 (44.5)	177.5 (37.6)	578.7 (40.5)
105-120 min	342.2 (51.0)	582.6 (41.4)	170.9 (36.7)	604.0 (36.0)



**Figure 5.20 Total Gap time for each 15-minute block during the 2-hour standing exposure shows a slight decrease ( $p < 0.05$ ) in right and left gluteus maximus, right external oblique and left internal oblique muscle groups as standing duration increased.**

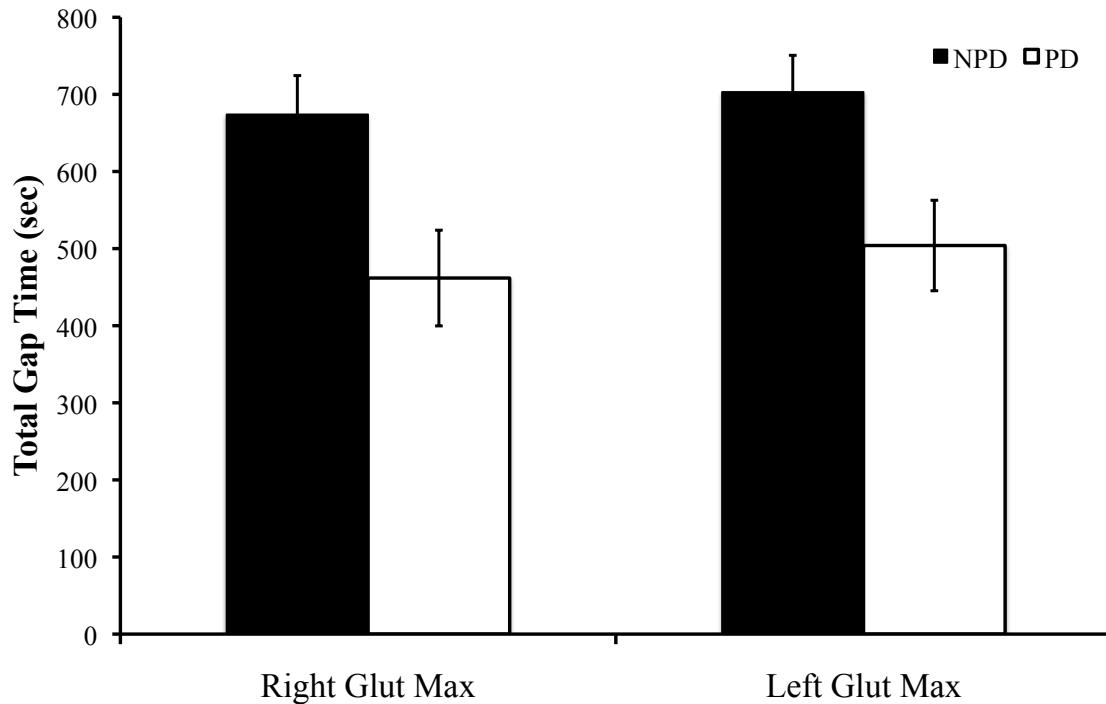
There were significant PD/NPD group by time interactions for both right ( $F_{4,590,169.82} = 2.431, p < 0.05$ ) and left gluteus medius ( $F_{3,297,121.988} = 2.870, p < 0.05$ ) muscles. The

NPD group consistently had longer total Gap times than the PD group for the bilateral gluteus medius muscles. The NPD group responded as the standing duration progressed by decreasing their total Gap time, where the PD group remained at a relatively constant Gap time throughout the entire standing exposure (Figure 5.21).



**Figure 5.21** The total Gap time for bilateral gluteus medius muscles decreased over time for the NPD group, while it stayed relatively constant for the PD group during the standing exposure. NPD had longer total Gap times than PD for these muscles at the beginning and end of the standing protocol (\* designates  $p < 0.05$ ).

There was a significant main effect of PD/NPD group for the right ( $F_{1,37} = 7.065, p < 0.05$ ) and left ( $F_{1,37} = 6.958, p < 0.05$ ) gluteus maximus muscles. These exhibited the same pattern as the gluteus medius muscles with the NPD group having longer total Gap times over the standing exposure than PD group (Figure 5.22).



**Figure 5.22 NPD had longer total Gap times during prolonged standing exposure than PD ( $p < 0.05$ ) for bilateral gluteus maximus muscles.**

Results from these analyses provide a consistent indication that NPD and PD individuals have very different muscle activation patterns, particularly at the hip, that manifest in the early stages of a prolonged standing task. Modulation of these patterns as standing exposure increases also differs between the two groups, and there appears to be a gender component as well.

### 5.13. Discussion and Conclusions

Using a functionally induced transient low back pain model in previously asymptomatic people, it was possible to investigate differences between individuals who develop LBP during a task compared with individuals who do not. With this methodology, as opposed

to more commonly used methods of comparing people who have LBP with healthy controls, predisposing factors that potentially increase an individual's risk for standing-related low back pain development may become apparent. A multifactorial approach was utilized, in order to increase the clinical relevance of these findings by incorporating physiotherapy assessment tools, psychosocial questionnaires, physical activity history, and multiple biomechanical tools including measures of muscle activation, estimates of joint stiffness, and postural measures.

Individuals in this study clearly separated into two distinct groups of pain developers and non-pain developers when exposed to a prolonged standing protocol. All individuals started the protocol with a similar baseline level of no LBP. Over the 2-h standing protocol 40% of the participants reported subjective complaints of LBP while the non-pain developers remained at a near-zero level. This is consistent with earlier findings (Nelson-Wong, Gregory et al. 2008), although the percentage of individuals who developed LBP was lower in this study, 40% versus 64%. This may be due to a difference in the experimental set-up where participants in the previous study were required to stand in a 56cm x 56cm space. The individuals in that study may have felt more highly constrained resulting in a higher number of pain reporters. Inclusion criteria for earlier studies also required participants to be free of LBP during the previous 12-month period rather than lifetime as in this study. It is possible that there were individuals entered into the previous studies who did have some history of LBP and this could also explain the higher percentage of pain developers.

The levels of low back pain reported by this sample ranged from 10 – 56 mm on VAS. Of the 17 participants classified as PD in this study, 9 (53%) had VAS scores that were

below 20 mm. These would be considered to be on the low end compared to clinical low back pain populations where self-reported pain scores prior to treatment averaged 4-5 on an 11-point numeric pain rating scale with the same end-point anchors as the VAS (Childs, Fritz et al. 2004; da Silva, Arsenault et al. 2005; Brennan, Fritz et al. 2006; Dankaerts, O'Sullivan et al. 2007). Although the pain and non-pain groups did clearly separate from each other in this study, similar studies need to be done in clinical LBP populations in order to make comparisons and to determine whether similar muscle activation profiles exist in order to provide a basis for intervention. Other studies using different models of induced pain reported pain responses from 10 -100 mm on VAS for pain threshold in a healthy sample with a cold pressor test (George, Dannecker et al. 2006) and an average increase of 9 mm on VAS in response to a series of thermal pulses applied to a population with chronic low back pain (George, Wittmer et al. 2007). Hagg, et al. (2003) reported the minimum clinically important difference in VAS for LBP patients to feel symptoms had worsened was 8 mm, which is less than the threshold chosen to be categorized as a pain developer in this study.

The expectation was that PD in this study would demonstrate positive clinical findings on examination that would indicate a predisposition towards becoming a LBP developer. From an occupational safety and health perspective it would be ideal to have a simple screening tool that could identify “at risk” workers and guide an appropriate preventative exercise program. Although these participants were a non-clinical group it was felt that they could be considered a sub-clinical group who might be at risk for LBP later in life. While nearly all of the typically used clinical assessment measures were not significantly different between the two groups, the positive finding on the AHAbd test in the PD group

seems to be predictive of LBP development during standing. Therefore, the hypothesis (1.1) that PD individuals would demonstrate positive findings on clinical assessment compared to NPD individuals was supported. The AHAbd had a sensitivity of 0.41, and a specificity of 0.85. While the sensitivity of the test was low, meaning that a negative test is not very strong for ruling out LBP development, the specificity is encouraging indicating that a positive test is good for predicting LBP development. These sensitivity and specificity values correspond to the more clinically useful statistics of positive likelihood ratio (LR+) of 2.68 (95% CI 1.022 – 8.537) and diagnostic odds ratio (OR) of 3.85 (95% CI 1.049-19.069) (Fritz and Wainner 2001). The LR+ is in the range that would suggest a moderate, and potentially important, shift in probability that an individual who is positive on the test would be a LBP developer (Fritz, Cleland et al. 2007). The OR is commonly used to assess the value of diagnostic tests as being associated with a disorder or disease (Fleischer, Didyk et al. 2009), and this value indicates that when an individual was positive on the AHAbd test, they were 3.85 times more likely to be a LBP developer during standing.

Although this sample did not include a clinical LBP population, the ability to predict future LBP development during a specific activity in previously asymptomatic individuals has powerful implications. This simple screening tool, if it can be further validated, has a potential application for workplace screening and early identification of individuals who may be at risk for LBP development with prolonged standing exposures.

It was hypothesized that LBP developers would demonstrate increased fatigability of extensors on an extensor endurance test and decreased Flexion Relaxation Ratio in standing than non-LBP developers (Hypothesis 1.2). This hypothesis is rejected since no



PD/NPD group differences were found in fatigability on the extensor endurance test. While there were PD/NPD group differences in FRR for the gluteus maximus muscles, this went in the opposite direction from what was hypothesized. This finding adds support for the theory that individuals who are predisposed to LBP development have hypoactivity of the gluteus maximus muscles. Interestingly, the PD group had higher % MVC activation of the gluteus maximus muscles during the functional standing activity.

The hypothesis (1.3) that pain developers would have higher muscle co-activation was supported with the significant finding of increased bilateral gluteus-medius and trunk flexor/extensor co-activation in PD during standing compared with NPD. PD individuals demonstrated higher levels of muscle co-activation than NPD individuals immediately upon the initiation of the standing protocol, prior to any subjective reports of LBP. Group differences in this variable were most marked during the first 30 minutes of standing. This supports the contention that this muscle co-activation pattern is not an adaptive response to LBP, and appears to be an important factor in the predisposition of individuals who experience LBP during standing.

Because the LBP developers in this study had difficulty with maintaining postural control when asked to perform a low level challenge directed at the core trunk stabilizers during the AHAbd test, there is some support for the hypothesis that co-activation at the hip is a compensatory motor control pattern that has been adopted by these individuals. This appears to be a dysfunctional muscle activation pattern in that it does not protect these individuals from developing pain during a common, low-level activity. Co-activation at the hip during standing may serve as an attempt to compensate for an inability to adequately utilize core trunk muscles for postural stability during prolonged standing.

There were additional muscle activation differences that are consistent with the findings of increased co-contraction at the hip in the PD group. Most notable are the findings that PD had a total rest time (total Gap time) for the muscle groups at the hip that was less than that of the NPD group. This suggests that there may be a fatigue component that ties into the development of LBP during a static task in these individuals. The different muscle activation patterns demonstrated by the PD group during the initial stages of standing may predispose them to be more susceptible to fatigue as the task duration progresses. Van Dieen and colleagues (2008) found evidence of fatigue, as demonstrated by negative MPF slopes, in the lumbar extensors with sustained contractions at as low as 2% and 5% MVC. While average muscle activation levels for the gluteal muscles were very low during standing, the PD group had muscle activation levels that were higher than the NPD group, and were close to 2% MVC. Interestingly, these authors found greater fatigue occurred in muscles that had lower variability in activation level during the 30-minute exertion. The PD in this study had a shorter total Gap duration in the hip musculature during prolonged standing, indicating that they had less variability in their muscle activation patterns than the NPD. These findings suggest that the PD group might be more susceptible to fatigue during the prolonged standing task and this may be one potential mechanism for their LBP development.

While there was some variability in the PD group, it was not possible to identify individuals who demonstrated a purely 'adaptive' type response with this relatively small sample size, and were therefore unable to adequately address the hypothesis (1.4) related to sub-grouping into 'causal' and 'adaptive' response categories.

There are several limitations in this study. Participant's expectations of whether they were likely to experience pain during the task were not assessed. Although differences were not found in psychosocial profiles about pain and movement, comparisons to the literature were not possible since the complete, validated questionnaires were not used. The sample size was relatively small, and the participants were young, healthy and generally physically fit, and this may limit generalizability of these findings to the general or clinical population. The clinical assessment was not repeated immediately following the experimental protocol, so it is unknown whether any of these factors were changed by the prolonged standing exposure. A limitation of quantifying muscle co-activation using the CCI is that only two muscle groups can be included, so quantification of general muscle co-activation was not done. The kinematic measures to describe torso responses were very coarse as the pelvis and trunk were modeled as only two rigid segments, so it was not possible to discern between lumbar and thoracic spine postural changes. While there was some evidence of increased muscle activation and co-contraction during the single leg stance, it is possible that a more challenging activity (such as a unilateral squat) would have elicited greater discrimination between the PD/NPD groups.

Findings from this study provide further evidence that many of the commonly accepted 'adaptations' to LBP may actually be present as predisposing factors prior to the manifestation of a clinical LBP problem. These results have confirmed the association of hip abductor muscle co-activation prior to the development of LBP during standing. Differences were also demonstrated in modulation of muscle activation patterns between pain/non-pain groups during the acute phase of LBP development. These findings

strengthen the assertion that muscle co-activation of the hip abductors and to a lesser extent, the trunk flexor/extensors are a precursor to LBP development during standing, and may potentially contribute to low level fatigue as standing duration is increased. These findings may provide a basis for potential intervention and preventative measures. A positive finding on a screening test designed to provide a challenge for postural control during active lower limb movement appears to be another marker to identify people at risk for pain development during standing and potentially can assist in targeting individuals for early intervention and prevention measures.

## **6. STUDY 2: ACUTE CHANGES IN RESPONSE TO PROLONGED STANDING EXPOSURE**

### **6.1. Introduction**

Job rotation is commonly used as a strategy by employers for reducing the amount of time employees spend performing repetitive, or physically demanding tasks, on the assumption that increasing variability throughout the shift will decrease the incidence of repetitive strain injuries (Meijssen and Knibbe 2007). Job rotation would theoretically only be beneficial in reducing workplace injuries if the jobs included exposed workers to different risk factors and loading parameters (Frazer, Norman et al. 2003). Jorgensen and colleagues (2005) found that 42.7% of manufacturers in the Midwest United States use job rotation and the median time spent at each job position is 2-hours. Due to the increased complexity of exposures when multifunctional jobs and job rotation are utilized, the acute response to specific exposures within the task rotation design has been identified as an area in need of study (de Oliveira Sato and Cote Gil Coury 2009). Typically job rotation design has focused on alternating between jobs with high and low physical demands (de Oliveira Sato and Cote Gil Coury 2009). Prolonged standing may be classified as a job with low physical demands, however there may be adverse effects of moving from a sustained static posture to a more dynamic activity (Meijssen and Knibbe 2007). The purpose of Study 2 was to investigate the acute response to a prolonged standing exposure as a way of determining whether there might be either detrimental or positive consequences to incorporating a static standing posture into task rotation design. The functional movements that were performed pre- and post- prolonged standing were considered to be relevant to occupational tasks as they include base

elements that many occupational tasks contain (forward bending from the hips, squatting, and a moderate balance challenge of unilateral stance).

## 6.2. Flexion Relaxation Ratio

Flexion Relaxation Ratio (FRR) was calculated as described previously for pre-and post-standing lumbar flexion trials, with motion capture instrumentation. FRR values were calculated for each movement trial, and averages taken across trials to yield FRR values for pre-standing and post-standing exposure. As before, paired t-tests showed no significant differences between left and right muscle pairs ( $p > 0.05$ ). Therefore symmetry was assumed and average values were used for left and right muscle pairs. FRR values were entered into 3-way general linear models with between factors of PD/NPD group and gender and within factor of standing exposure (2 repeated measures). There were no significant changes ( $p > 0.05$ ) in FRR value for any of the three muscle groups following prolonged standing exposure. There remained a significant main effect of PD/NPD group for FRR of the gluteus maximus muscles ( $F_{1,38} = 5.422, p < 0.05$ ). Summary data are presented in Table 6.1.

**Table 6.1 Summary data for pre- and post- prolonged standing exposure flexion relaxation ratios (FRR)**

	Thoracic Erector Spinae Mean (SE)		Lumbar Erector Spinae Mean (SE)		Gluteus Maximus Mean (SE)	
	Pre	Post	Pre	Post	Pre	Post
<b>NPD</b>	7.99 (3.23)	5.33 (1.78)	12.8 (10.0)	1.74 (0.99)	0.83 (0.22)	0.68 (0.13)
<b>PD</b>	3.02 (0.98)	3.90 (1.15)	7.49 (5.1)	2.38 (1.19)	4.71 (2.25)	4.57 (2.57)

Prolonged standing exposure does not appear to have a detrimental effect on the flexion relaxation response. Individuals who demonstrated heightened flexion relaxation of the gluteus maximus muscles prior to the standing exposure, continued to exhibit this same

pattern following the standing exposure, with a similar degree of relaxation as was seen pre-standing exposure. While there was no significant difference detected in FRR for the lumbar erector spinae, it appears that the standing exposure did result in some reduction in FRR for these muscles, although there was a relatively small effect size with Cohen's  $d = 0.34$ . The pre-standing data had a very wide spread (as shown by the large SE), while the post-standing data was much tighter. The reduced FRR appears to be driven primarily by increased activation levels of the lumbar paraspinals during the flexed posture as opposed to a decrease in muscle activity during the upright posture. On average, there was a minimal change in % MVC activation levels during the upright posture from pre- to post- prolonged standing exposure (mean  $\pm$  SE,  $0.06 \pm 0.21$  % MVC). Conversely, there was an average increase in % MVC activation of these muscles during the flexed posture from pre- to post- prolonged standing exposure (mean  $\pm$  SE,  $2.46 \pm 0.61$  % MVC). It is possible that this study was under-powered to detect a significant change in this variable, and this should be investigated further in future work.

### **6.3. Single Leg Standing**

Similar analyses were done on the pre- and post- standing exposure single leg stance (SLS) data as were done for Study 1. Variables were calculated using the same methods for the first repetition of SLS for left and right sides, post-standing. In an attempt to determine the impact of a prolonged standing exposure on these variables, data were entered into 3-way general linear models with between factors of PD/NPD group and gender, and within factor of standing exposure (2 repeated measures).

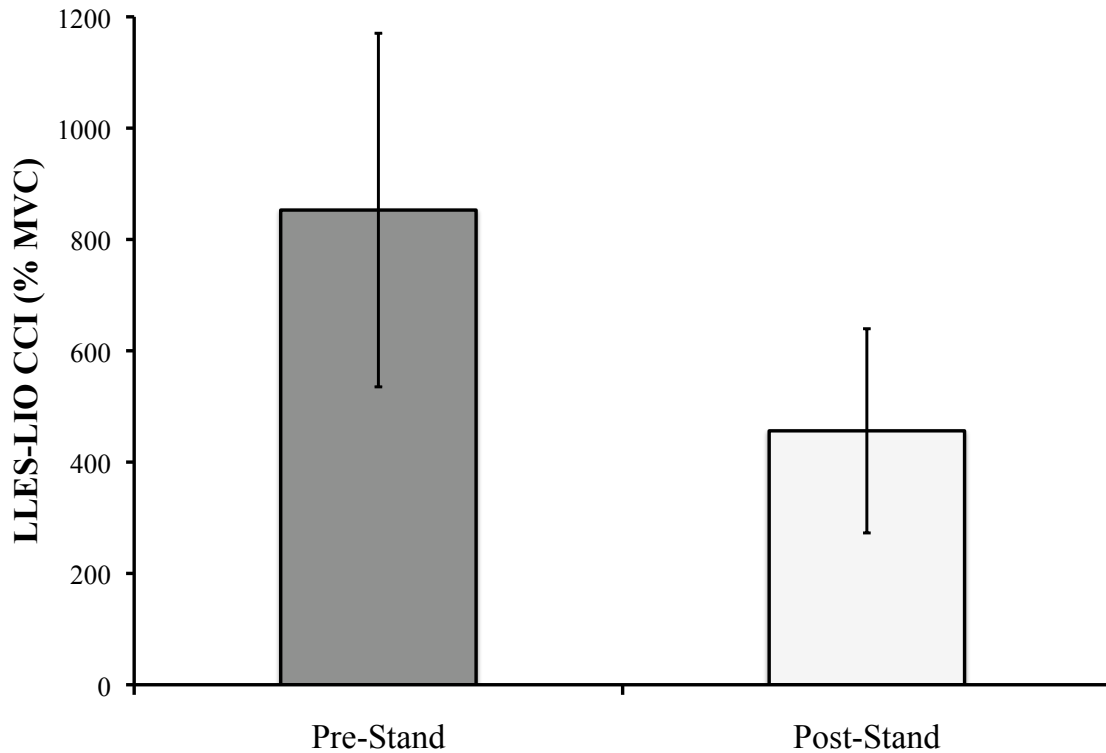
### **6.3.1. Muscle Co-Contraction During Single Leg Stance**

Co-contraction Index (CCI) was calculated for each trunk muscle pair for the first post-standing exposure left and right SLS repetition as previously described. CCI values from the pre- and post-standing SLS trials were then entered into 3-way general linear models with between factors of PD/NPD group and gender, and within factor of standing exposure (2 repeated measures).

As in the pre-standing analysis, in left SLS there were no significant findings on any of the CCI measures.

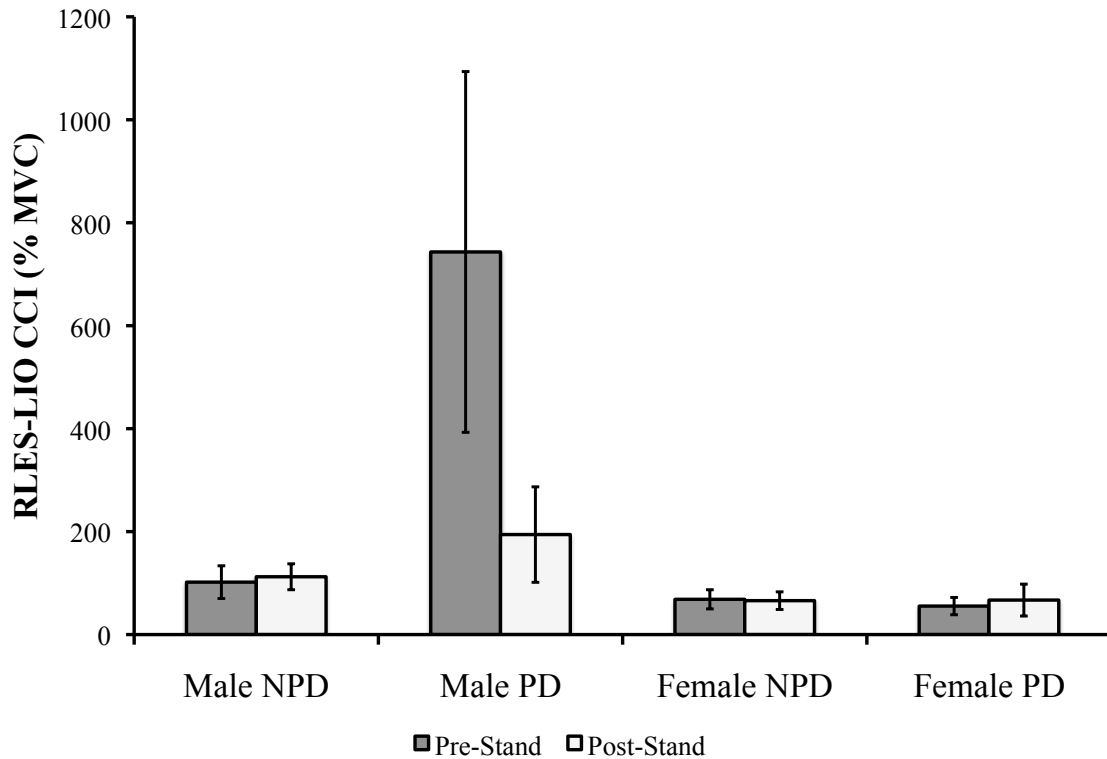
In right SLS there was a main effect of exposure ( $F_{1,39} = 4.395, p < 0.05$ ) for left lumbar erector spinae and left internal oblique (LLES-LIO) co-contraction, with all participants demonstrating a decrease in co-contraction of these muscles following prolonged standing exposure (pre-standing CCI = 1021.0 (312.5) versus post-standing CCI = 534.3 (188.6)) (Figure 6.1).





**Figure 6.1** There was a significant ( $p < 0.05$ ) decrease in co-contraction of left lumbar erector spinae and left internal oblique muscles during right SLS following the prolonged standing exposure.

There was a significant 3-way interaction of PD/NPD group, gender and standing exposure ( $F_{1,39} = 6.315, p < 0.05$ ) during RLS for right lumbar erector spinae and left internal oblique co-contraction (RLES-LIO), with male PD having a decrease in the amount of muscle co-contraction following the prolonged standing exposure (Figure 6.2).



**Figure 6.2** Following the prolonged standing exposure, males who were pain developers had a decrease in co-contraction of the right lumbar erector spinae and left internal oblique muscles during right SLS compared to the other three groups ( $p < 0.05$ ).

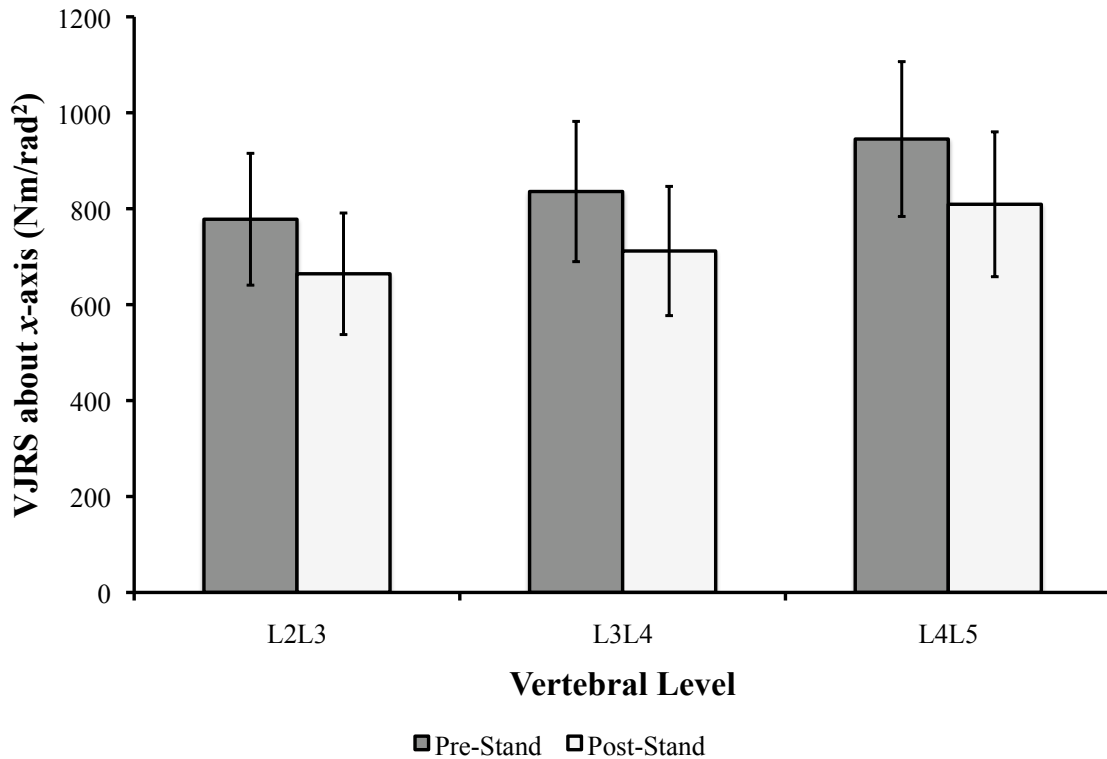
While there were no widespread differences found from pre- to post-standing co-contraction measures in SLS, the male pain developers had a definite decrease in the RLES-LIO muscle pair following the standing exposure. This group was similar to the other three groups in their CCI profile following the standing exposure. The RLES-LIO muscle pair was the only muscle group that was found to have any significant differences prior to the standing exposure.

### 6.3.2. Vertebral Joint Rotation Stiffness During SLS

The total ‘active’ vertebral joint stiffness and the relative individual muscle contributions to VJRS were calculated for the first repetition of post-standing single leg stand trials

(LSLS and RSLs) as was done in Study 1. The frame numbers of interest were extracted as previously described, and the peak and mean values were calculated. For the total ‘active’ VJRS, the peak and mean values for each level and axis combination were entered into 2-way general linear models with between factor of PD/NPD group, and within factor of standing exposure (2 repeated measures) for right and left SLS. As was done previously, gender was not included as a factor given the inherent limitations that have already been addressed within the model. Only significant findings are reported here. There were no significant differences or interactions detected in peak ‘active’ stiffness values during either RSLs or LSLS. For average ‘active’ stiffness during LSLS, there were no significant main effects or interactions in ‘active’ VJRS in response to the standing exposure.

In RSLs, there were significant main effects of exposure for total ‘active’ stiffness about the *x*-axis (lateral bend axis) at L<sub>2</sub>L<sub>3</sub> ( $F_{1,32} = 4.473, p < 0.05$ ), L<sub>3</sub>L<sub>4</sub> ( $F_{1,32} = 4.743, p < 0.05$ ), and L<sub>4</sub>L<sub>5</sub> ( $F_{1,32} = 4.316, p < 0.05$ ), with participants having decreased stiffness in lateral bend at these levels following the standing exposure (Figure 6.3), with Cohen’s *d* values  $> 0.70$ , indicating a medium to large effect size.



**Figure 6.3** There was a general decrease in stiffness about the lateral bend axis ( $p < 0.05$ ) following the 2-hour standing exposure.

Peak and average relative contributions to stiffness for each individual muscle group were calculated as previously described. These were then entered into 4-way general linear models with between factor of PD/NPD group and within factors of vertebral level (5), rotation axis (3), and standing exposure (2 repeated measures). These data were found to violate sphericity assumptions on Mauchly's Test, and therefore Huynh-Feldt adjusted  $p$ -values were used to determine significance. There were no significant differences or interactions for peak or average individual muscle contributions to stiffness following standing exposure.

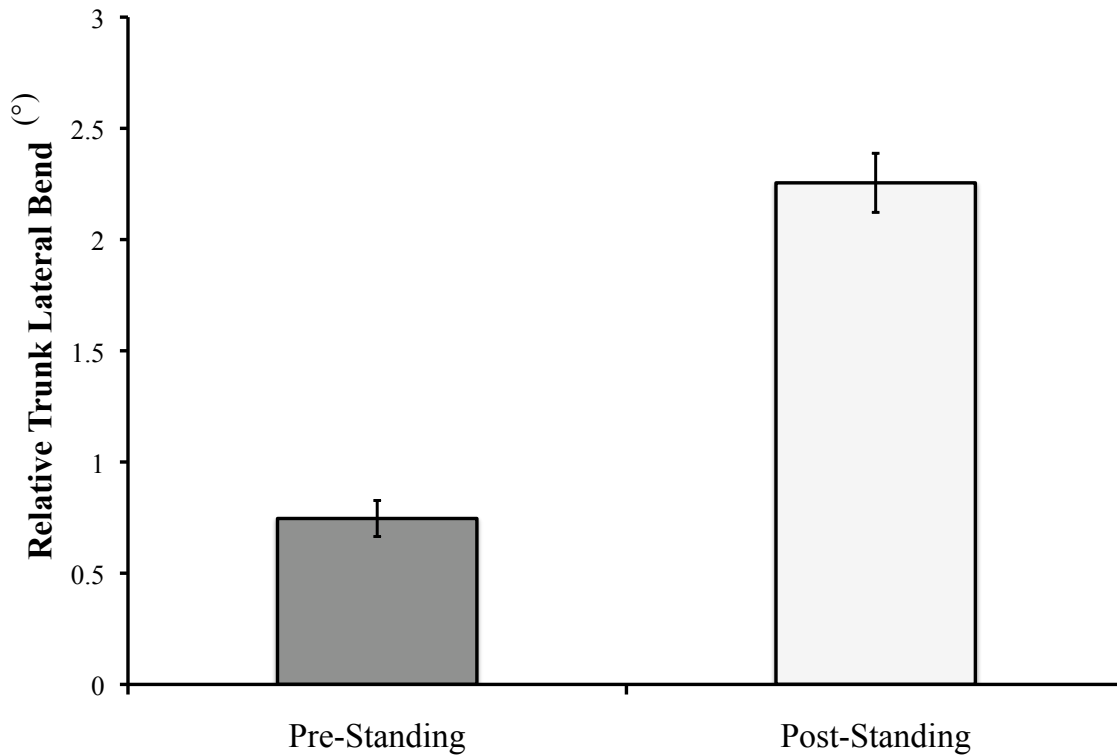
### 6.3.3. Trunk and Pelvis Kinematics

Three-dimensional trunk and pelvis angles were calculated in Visual3D (C-motion, Inc., Kingston, Ontario, Canada) as previously described in Study 1 [Chapter 5], for the first right and left single leg standing trial post-standing exposure. A ‘neutral’ angle was determined by taking average angles from a stable period of double-leg standing at the start of the trial, and SLS angles were determined by taking average angles from a stable period of the SLS phase. The change from ‘neutral’ was then calculated by subtracted the neutral angle from the SLS angle. This was done for the relative trunk angle (thorax relative to pelvis), pelvis angle (pelvis position in the GCS) and thorax angle (thorax position in the GCS). Angles about each axis were then independently entered into 3-way general linear models with between factors of PD/NPD group and gender, and a within factor of standing exposure (2 repeated measures). Only significant main effects and/or interactions that included standing exposure are presented here.

For RSLs, there was a main effect of standing exposure for the relative trunk angle about the *x*-axis (lateral bend) ( $F_{1,38} = 8.613, p < 0.01$ ), with participants increasing their relative trunk angle in lateral bending during RSLs following the standing exposure (Figure 6.4). Summary data, with *p*-values for the main effect of standing exposure are provided in Table 6.2.

**Table 6.2 Summary data for relative trunk angle during RSLs pre- and post-prolonged standing exposure**

		<b>Pre-Standing °</b> Mean (SD)	<b>Post-Standing °</b> Mean (SD)	<b><i>p</i>-value</b> (Exposure)
<b>Trunk Angle</b> (thorax relative to pelvis)	Lateral Bend	1.16 (3.30)	3.05 (5.60)	<b>0.006</b>
	Axial Twist	-0.58 (2.35)	-0.30 (3.43)	0.299
	Flex/Ext	-2.41 (4.99)	-2.05 (5.30)	0.276

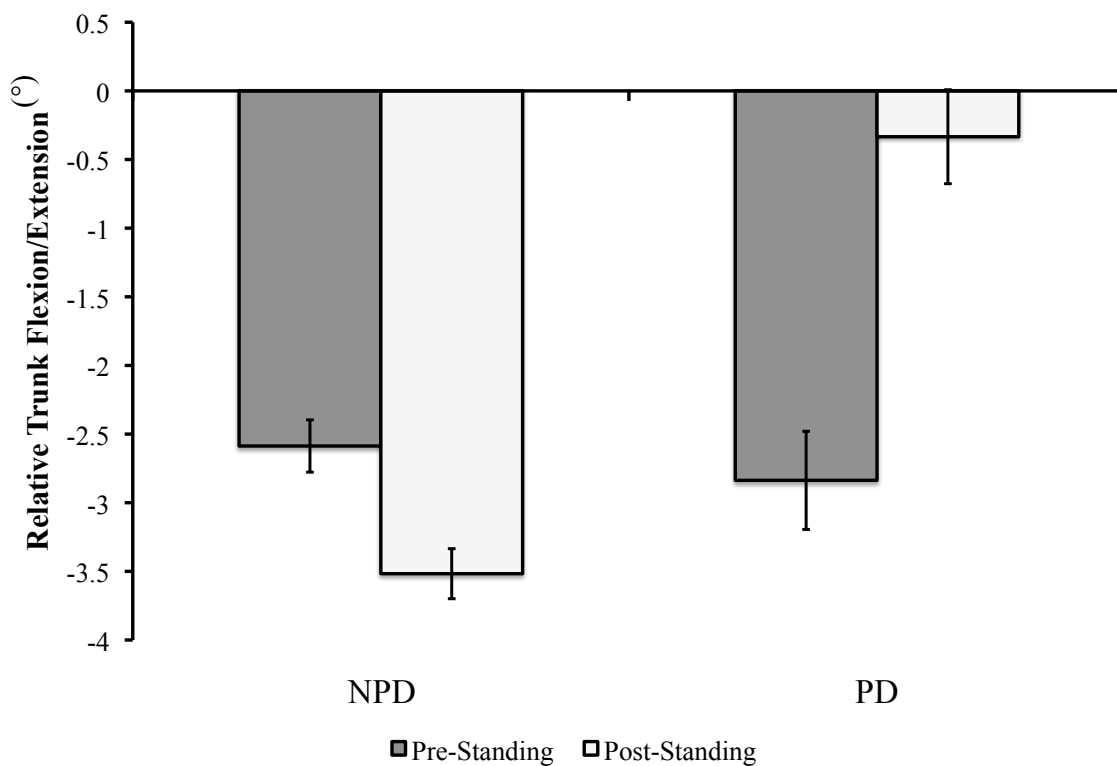


**Figure 6.4** Participants increased lateral bending of the thorax relative to the pelvis during right SLS following the 2-hour standing exposure ( $p < 0.01$ ).

There was a significant interaction between PD/NPD group and standing exposure of the relative trunk angle about the  $z$ -axis (flexion/extension) ( $F_{1,38} = 5.813, p < 0.05$ ), with the PD group having increased extension and the NPD group having increased flexion during RSLs after being exposed to 2-hours of standing (Figure 6.5). Data by PD/NPD group and standing exposure is summarized in Table 6.3.

**Table 6.3 Summary data for relative trunk angle by PD/NPD group during RSLs, pre- and post- prolonged standing exposure (significant differences in bold).**

Trunk Angle (°)		Pre-Standing Mean (SD)	Post-Standing Mean (SD)
NPD	Lateral Bend	1.50 (3.73)	3.97 (5.87)
	Axial Twist	-0.24 (2.41)	-0.43 (2.87)
	<b>Flex/Ext</b>	<b>-2.50 (3.71)</b>	<b>-3.51 (4.93)</b>
PD	Lateral Bend	0.55 (2.32)	1.39 (4.84)
	Axial Twist	-1.20 (2.17)	-0.70 (4.38)
	<b>Flex/Ext</b>	<b>-2.25 (6.87)</b>	<b>0.57 (5.05)</b>



**Figure 6.5 The PD/NPD groups responded differently in RSLs following the standing exposure in trunk flexion/extension ( $p < 0.05$ ).**

There were no significant differences in the thorax or pelvis angles (position in GCS) during RSLs as a result of the standing exposure. Summary data are presented in Table 6.4.

**Table 6.4 Summary data for thorax and pelvis position during RSLs pre- and post- prolonged standing exposure**

		<b>Pre-Standing °</b> Mean (SD)	<b>Post-Standing °</b> Mean (SD)
<b>Thorax Angle</b> (position in GCS)	Lateral Bend	4.42 (3.40)	5.23 (3.51)
	Axial Twist	2.52 (4.21)	3.09 (5.00)
	Flex/Ext	-1.51 (3.74)	-1.28 (4.78)
<b>Pelvis Angle</b> (position in GCS)	Lateral Bend	1.85 (2.86)	0.73 (4.34)
	Axial Twist	4.17 (4.17)	4.46 (5.46)
	Flex/Ext	0.73 (4.62)	0.45 (5.69)

For left single leg standing (LSLS), there was no significant effect of standing exposure on trunk or thorax (thorax position in GCS) angles about any of the rotation axes.

Summary data are presented in Table 6.5.

**Table 6.5 Summary data for relative trunk and thorax angles during LSLS, pre- and post- prolonged standing exposure**

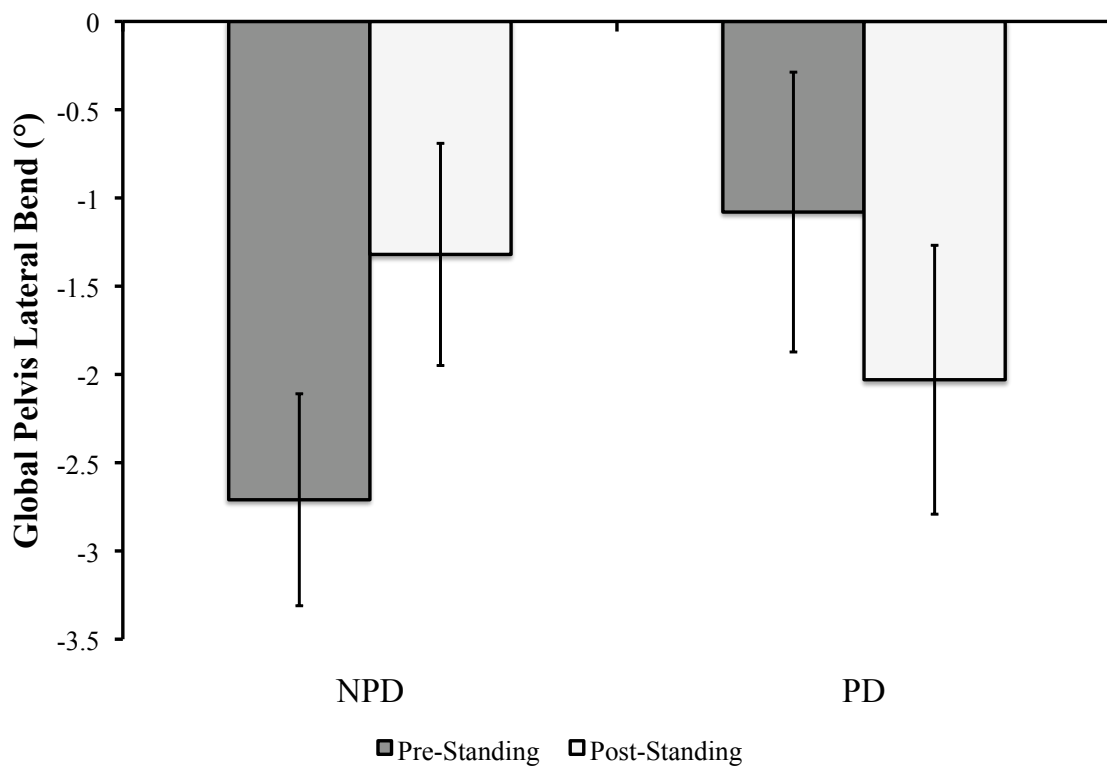
		<b>Pre-Standing °</b> Mean (SD)	<b>Post-Standing °</b> Mean (SD)
<b>Trunk Angle</b> (thorax relative to pelvis)	Lateral Bend	-1.32 (3.54)	-2.0 (4.0)
	Axial Twist	0.72 (2.08)	0.75 (2.92)
	Flex/Ext	-1.95 (4.71)	-0.28 (4.90)
<b>Thorax Angle</b> (position in GCS)	Lateral Bend	-3.76 (3.09)	-4.45 (3.92)
	Axial Twist	0.44 (5.27)	0.55 (7.02)
	Flex/Ext	-1.14 (3.20)	0.74 (4.49)

There was a significant interaction between NPD/PD group and standing exposure ( $F_{1,38} = 9.887, p < 0.01$ ) during LSLS on the pelvis (pelvis position in GCS) angle about the lateral bend axis (Figure 6.6). Summary data are presented in Table 6.6.



**Table 6.6 Summary data for global pelvis angle in LSLs pre- and post-prolonged standing exposure (significant differences in bold)**

Global Pelvis Angle (°)		Pre-Standing Mean (SD)	Post-Standing Mean (SD)
<b>NPD</b>	<b>Lateral Bend</b>	<b>-2.71 (3.12)</b>	<b>-1.32 (3.27)</b>
	Axial Twist	-0.65 (5.60)	-0.98 (7.81)
	Flex/Ext	0.77 (5.31)	-0.23 (4.20)
<b>PD</b>	<b>Lateral Bend</b>	<b>-1.08 (3.07)</b>	<b>-2.03 (2.95)</b>
	Axial Twist	-2.65 (4.92)	-2.07 (5.27)
	Flex/Ext	1.12 (2.48)	0.37 (4.86)



**Figure 6.6 PD/NPD groups responded differently to standing exposure in global pelvis lateral bending during the LSLs task ( $p < 0.01$ ).**

While there were not large PD/NPD group differences in trunk and pelvis kinematics during single leg standing prior to the prolonged standing exposure, groups did appear to respond quite differently to the standing exposure on these measures.

### 6.3.4. Centre of Pressure Excursion During Single Leg Standing

The magnitude of centre-of-pressure (COP) excursion in the antero-posterior (COP<sub>AP</sub>) and medio-lateral (COP<sub>ML</sub>) directions was determined using the same methods as previously described for the first post-standing trial of left and right SLS. These values were entered into 3-way general linear models with between factors of PD/NPD group and gender and within factor of standing exposure (2 repeated measures).

There were no significant main effects or interactions involving PD/NPD group, however there were significant interactions between gender and standing exposure for COP<sub>AP</sub> ( $F_{1,39} = 4.201, p < 0.05$ ) in the RSLs condition and both COP<sub>AP</sub> ( $F_{1,39} = 5.716, p < 0.05$ ) and COP<sub>ML</sub> ( $F_{1,39} = 8.506, p < 0.01$ ) in the LSLS condition. In all three cases, males had an increase in their COP excursion during SLS after exposure to prolonged standing while females had a decrease. Summary data for RSLs and LSLS COP excursion are presented in Table 6.7 and Table 6.8.

**Table 6.7 Summary data for COP excursion in RSLs, pre- and post prolonged standing exposure.**

<b>Right Single Leg Standing</b>		<b>Males</b> Mean (SD)	<b>Females</b> Mean (SD)
<b>Pre-Standing</b>	COP <sub>AP</sub> (cm)	6.3 (2.5)	9.9 (8.8)
	COP <sub>ML</sub> (cm)	3.5 (0.8)	4.2 (2.1)
<b>Post-Standing</b>	COP <sub>AP</sub> (cm)	10.7 (7.6)	7.7 (4.5)
	COP <sub>ML</sub> (cm)	4.1 (1.7)	3.6 (1.3)

**Table 6.8 Summary data for COP excursion in LSLS, pre- and post prolonged standing exposure.**

Left Single Leg Standing		Males Mean (SD)	Females Mean (SD)
Pre-Standing	COP <sub>AP</sub> (cm)	6.8 (2.0)	7.1 (3.4)
	COP <sub>ML</sub> (cm)	3.1 (0.6)	3.7 (1.9)
Post-Standing	COP <sub>AP</sub> (cm)	8.7 (3.0)	6.5 (1.7)
	COP <sub>ML</sub> (cm)	4.4 (2.0)	3.4 (1.2)

There were medium to large effect sizes for the increased COP excursion for the males as shown by the Cohen's *d* values shown in Table 6.9.

**Table 6.9 Effect sizes and *p*-values for COP excursion changes in males.**

		LSLS (cm) Mean (SD)	<i>p</i>	<i>d</i>	RSLs (cm) Mean (SD)	<i>p</i>	<i>d</i>
COP <sub>AP</sub>	Pre	6.8 (2.0)	0.022	0.77	6.3 (2.5)	0.047	0.66
	Post	8.7 (3.0)			10.7 (7.6)		
COP <sub>ML</sub>	Pre	3.1 (0.6)	0.006	0.93	3.5 (0.8)	0.083	0.57
	Post	4.4 (2.0)			4.1 (1.7)		

The implication of this finding is that males had a more difficult time maintaining balance in SLS following the prolonged standing exposure than females did. The decrease in stability during SLS, while relatively small, could potentially have a negative impact on task performance depending on the challenge and risk level of the task being rotated to following a period of prolonged standing.

### **6.3.5. *Gluteus Medius Muscle Activation During Single Leg Standing***

Peak and average muscle activation for the gluteus medius muscles on the ipsilateral stance limb were calculated as described previously. These values were entered into 3-way general linear models with between factors of PD/NPD group and gender and within factor of standing exposure (2 repeated measures).

In the RSLS condition, there was a main effect of standing exposure ( $F_{1,39} = 9.652$ ,  $p < 0.01$ ) on average right gluteus medius muscle activation, with activation levels being higher in the pre-standing trial ( $5.86 \pm 3.96$  % MVC) than in the post-standing trial ( $4.59 \pm 3.88$  % MVC). While this is statistically significant, it is questionable whether this constitutes a meaningful decrease in muscle activation in terms of function.

For peak activation of the right gluteus medius muscle during RSLS, there was a significant interaction between gender and standing exposure ( $F_{1,39} = 5.985$ ,  $p < 0.05$ ) with females having a lower peak activation during RSLS, and males having higher peak activation levels following the standing exposure. Summary data are presented in Table 6.10.

**Table 6.10 Peak right gluteus medius muscle activation during RSLS, pre- and post- prolonged standing exposure**

<b>Right Single Leg Standing</b>	<b>Pre-Standing (% MVC)</b> Mean (SD)	<b>Post-Standing (% MVC)</b> Mean (SD)
<b>Males</b>	10.56 (6.2)	11.85 (9.2)
<b>Females</b>	10.20 (7.2)	6.9 (6.4)

During the LSLS condition, there was no effect of standing exposure on the average muscle activation levels for the left gluteus medius. Pre-standing exposure average left gluteus medius muscle activation levels were  $5.82 \pm 3.6$  % MVC, and post-standing were  $5.57 \pm 4.1$  % MVC during left SLS.

For peak left gluteus muscle activation during LSLS, there was a significant interaction between PD/NPD group and standing exposure ( $F_{1,34} = 4.809$ ,  $p < 0.05$ ), with the NPD group having a lower peak activation and the PD group having a higher peak activation of left gluteus medius following the 2-hours of standing (Table 6.11).

**Table 6.11 Peak left gluteus medius muscle activation during LSLS, pre- and post- prolonged standing exposure**

<b>Left Single Leg Standing</b>	<b>Pre-Standing (% MVC)</b> Mean (SD)	<b>Post-Standing (% MVC)</b> Mean (SD)
<b>NPD</b>	10.71 (7.0)	9.12 (5.0)
<b>PD</b>	10.3 (6.4)	13.4 (12.8)

The increase in peak left gluteus medius muscle activation level following the standing exposure, implies that the PD group is having to exert more effort in maintaining the LSLS position.

### **6.3.6. Conclusions – Single Leg Stance Response to Standing Exposure**

There was a significant impact of the prolonged standing exposure on the single leg stance task for multiple factors. There were many side-to-side differences found, and results were not necessarily consistent between sides. Whether this is a function of leg dominance, individual history, or other factors is unknown. It is clear based on the finding that prolonged standing impacts SLS response, that any study of unilateral stance activities must be performed bilaterally as symmetry cannot be assumed. There was a decrease in ‘active’ trunk stiffness about the lateral bend axis during right single leg standing in response to the sustained standing exposure. This is supported by the decrease that was seen in trunk muscle co-activation, and also may be impacted by the postural changes that were observed. This decrease in stiffness in lateral bending during SLS could be an issue if the task being rotated to following prolonged standing included the necessity for resisting a sideload in combination with a balance activity, as might be seen in occupations such as construction, where workers spend most of their day in standing conditions and are also manipulating heavy loads, often at heights or on unstable/uneven surfaces. The increase in right lateral bending of the relative trunk angle during RSLs

following standing exposure may have been a compensation to decrease the moment arm for the right gluteus medius by centering the trunk mass more directly over the stance limb. There was a corresponding decrease, although small, in the average right gluteus muscle activation during RSLs following the standing exposure that would support this. There were some PD/NPD group differences in response to the standing exposure, most notably in the degree of pelvis lateral bend that occurred during SLS. Interestingly, the PD group had an increase in lateral bending of the pelvis in the direction of the stance limb. This is in the opposite direction of the clinical Trendelenburg sign (Hardcastle and Nade 1985), where the pelvis tips away from the stance limb. This is a common marker for weakness of the gluteus medius muscle, and while typically utilized in assessment of the hip, has been proposed for use in patients with low back pain (Roussel, Nijs et al. 2007). This group also demonstrated an increase in their peak left gluteus medius muscle activity during LSLS, so perhaps they were making an additional effort to maintain a neutral lumbar spine alignment during LSLS to avoid additional low back pain. While male participants exhibited increases in their COP excursion following the prolonged standing exposure, it is unclear whether this would translate to greater difficulty with higher-level balance challenges or imply a balance deficit, as the magnitude of COP excursion remained relatively small.

#### **6.4. Vertebral Joint Rotation Stiffness During Squatting**

The total ‘active’ vertebral joint stiffness and the relative individual muscle contributions to VJRS were calculated for the first repetition of post-standing squat trials as was done in Study 1. The frame numbers of interest were extracted as previously described, and the peak and mean values were calculated. For the total ‘active’ VJRS, the peak and mean

values for each level and axis combination were entered into 2-way general linear models with between factors of PD/NPD group and within factor of standing exposure (2 repeated measures) for the ‘down’ and ‘up’ phases of the squat. Only significant findings are reported here. Similarly to the pre-standing exposure findings, there were no differences in the peak or average total ‘active’ stiffness values in either the ‘down’ or ‘up’ phases of the squat in response to the standing exposure. Summary data for average VJRS values are provided in Table 6.12.

**Table 6.12 Average ‘active’ VJRS values pre- and post- standing exposure during squat task**

Level and Axis		‘Down’ Phase (N-m/rad <sup>2</sup> )		‘Up’ Phase (N-m/rad <sup>2</sup> )	
		Mean (SD)		Mean (SD)	
		Pre-Stand	Post-Stand	Pre-Stand	Post-Stand
L <sub>1</sub> L <sub>2</sub>	x-axis	850.0 (769.8)	796.2 (742.4)	977.9 (846.2)	909.5 (845.0)
	y-axis	357.8 (330.5)	332.6 (304.1)	390.8 (362.4)	353.9 (315.0)
	z-axis	573.7 (447.8)	540.8 (451.8)	665.0 (515.6)	619.0 (506.8)
L <sub>2</sub> L <sub>3</sub>	x-axis	787.5 (714.0)	737.6 (719.7)	912.9 (792.3)	850.2 (810.9)
	y-axis	380.7 (350.0)	352.3 (320.3)	417.8 (385.2)	377.8 (334.0)
	z-axis	519.9 (381.5)	497.6 (422.1)	632.6 (479.0)	581.7 (477.4)
L <sub>3</sub> L <sub>4</sub>	x-axis	825.6 (741.9)	774.4 (773.8)	973.9 (842.0)	905.0 (867.2)
	y-axis	416.6 (389.8)	384.7 (349.9)	468.5 (435.6)	425.2 (373.4)
	z-axis	551.9 (410.6)	536.6 (484.1)	689.4 (550.0)	632.2 (558.8)
L <sub>4</sub> L <sub>5</sub>	x-axis	1004.2 (876.3)	942.8 (936.3)	1212.2 (1025.8)	1120.7 (1053.6)
	y-axis	440.5 (423.6)	406.0 (378.5)	510.5 (480.1)	463.2 (408.0)
	z-axis	631.1 (496.8)	618.6 (597.0)	797.3 (680.3)	729.9 (689.9)
L <sub>5</sub> S <sub>1</sub>	x-axis	1326.7 (1123.0)	1245.2 (1198.1)	1644.4 (1355.6)	1513.4 (1374.7)
	y-axis	502.1 (470.8)	462.8 (428.7)	596.3 (544.6)	536.8 (461.3)
	z-axis	697.1 (529.0)	679.4 (632.9)	878.0 (710.5)	803.1 (717.1)

Summary data for the peak ‘active’ stiffness values during ‘down’ and ‘up’ phases of the squatting task, before and after exposure to the prolonged standing exposure are provided in Table 6.13.

**Table 6.13 Peak ‘active’ VJRS values pre- and post- standing exposure during squat task**

Level and Axis		‘Down’ Phase (N-m/rad <sup>2</sup> )		‘Up’ Phase (N-m/rad <sup>2</sup> )	
		Mean (SD)		Mean (SD)	
		Pre-Stand	Post-Stand	Pre-Stand	Post-Stand
L <sub>1</sub> L <sub>2</sub>	x-axis	1556.0 (1500.6)	1506.0 (1345.6)	1666.0 (1451.4)	1603.0 (1526.1)
	y-axis	647.6 (621.4)	628.0 (540.3)	688.7 (648.9)	618.7 (551.9)
	z-axis	948.6 (764.1)	940.7 (780.7)	1055.4 (856.0)	977.3 (812.2)
L <sub>2</sub> L <sub>3</sub>	x-axis	1484.1 (1452.6)	1423.1 (1308.5)	1614.0 (1436.2)	1553.0 (1523.3)
	y-axis	676.4 (643.3)	659.9 (568.0)	721.2 (667.4)	647.9 (577.2)
	z-axis	907.8 (689.1)	923.3 (792.1)	1058.8 (846.2)	967.7 (822.8)
L <sub>3</sub> L <sub>4</sub>	x-axis	1567.8 (1524.7)	1503.0 (1399.1)	1732.0 (1545.1)	1657.0 (1631.5)
	y-axis	722.0 (691.1)	710.7 (615.8)	779.6 (708.1)	703.8 (622.3)
	z-axis	1026.5 (813.9)	1053.7 (964.1)	1248.3 (1045.7)	1136.5 (1037.8)
L <sub>4</sub> L <sub>5</sub>	x-axis	1873.0 (1753.9)	1814.0 (1673.9)	2098.0 (1827.5)	1993.0 (1909.3)
	y-axis	751.3 (727.9)	738.6 (656.5)	828.8 (748.9)	742.3 (659.7)
	z-axis	1218.7 (1017.1)	1252.9 (1215.1)	1504.8 (1321.6)	1357.4 (1314.6)
L <sub>5</sub> S <sub>1</sub>	x-axis	2397.0 (2145.2)	2351.0 (2154.6)	2711.0 (2263.1)	2559.0 (2340.2)
	y-axis	848.7 (799.2)	829.2 (732.0)	939.8 (856.0)	837.3 (736.3)
	z-axis	1301.7 (1040.6)	1324.2 (1244.1)	1578.3 (1335.9)	1418.7 (1322.5)

Peak and average relative contributions to the ‘active’ stiffness of individual muscle groups about each axis were entered into 3-way general linear models with between factors of PD/NPD group and within factors of vertebral level (5) and standing exposure (2 repeated measures). These data were found to violate sphericity assumptions on Mauchly’s Test, and therefore Huynh-Feldt adjusted *p*-values were used to determine significance. Only significant findings, that included interactions with standing exposure, are presented here.

There was a significant main effect of standing exposure ( $F_{1,38} = 4.629, p < 0.05$ ) on the lumbar erector spinae’s relative contribution to stiffness about the *z*—axis (flexion/extension) with a slight decrease in relative contribution to the activity post-standing ( $29.6 \pm 1.7\%$  versus  $28.8 \pm 1.8\%$ ). While statistically significant, it is questionable whether such a small difference in percentage contribution of the LES



would have any real impact on the performance of the squatting task. There were no other significant findings on the individual muscle contributions to 'active' stiffness in response to a prolonged standing exposure during either the 'down' or 'up' phases of squatting.

## **6.5. Discussion and Conclusions**

Given the fact that workplaces have incorporated the use of work and task rotation as a measure to minimize occupational injuries (Jorgensen, Davis et al. 2005), it was of interest to investigate the response of individuals exposed to a relatively static standing period on functional movement performance. While there were some definite changes in the measured and calculated parameters in response to the prolonged standing exposure, it is unclear what impact, if any, these changes may have on an individual's ability to perform specific work-related tasks following a period of prolonged standing. Since specific occupational tasks were not included in this study design, and only basic functional movements that occupational tasks might incorporate, we are unable to relate these findings to impact on specific job tasks. Findings from this study have shown that there is an impact of prolonged standing exposure on several aspects of the functional movements under consideration. The relative impact of these changes on job task performance will vary depending upon the specific task being performed and the level of risk associated with the task. As with any ergonomic assessment, this must be assessed on a case-by-case basis.

It was expected that there would be a decreased flexion relaxation response, as quantified by FRR, in all participants following a prolonged standing period, with a larger effect in the PD group (Hypothesis 2.1). The rationale for this hypothesis being that there would be

increased muscle activation in the trunk and hip extensors that would resist moving into a flexed position after a long period of being in an extended (standing) position. This hypothesis was rejected as, in fact, there was no impact of the standing exposure on FRR, although as mentioned previously, this is an area that should be investigated further as there did appear to be a decrease in FRR following prolonged standing for the lumbar paraspinals. PD/NPD group differences that were present prior to the standing period (for the gluteus maximus) remained following standing exposure, and the magnitude of this was unchanged. It appears that individuals who are required to bend over, or stoop, following a period of standing, would not necessarily have any detrimental impact from increased muscle activation, or an inappropriate relaxation response, of the paraspinal musculature. Individuals who may already have hypoactivity of the gluteal muscles do not seem to incur further degradation of muscle activation of these muscles following standing exposure.

There were several differences found between pre- and post-standing exposure in the single leg standing task. There are many confounding issues with these analyses, not the least of which is the factor of leg dominance. Some general conclusions can be made, most importantly that there does appear to be a general decrease in trunk stiffness during the SLS task following prolonged standing exposure. Trunk co-contraction was found to decrease in a single muscle pair (RLES-LIO), and only in male pain developers, and therefore is probably not the primary mechanism behind the decrease in stiffness that was observed across participants. There were kinematic differences seen in the trunk and pelvis angles between pre- and post- standing exposure. The relative trunk angle was used as an input to the stiffness calculations as a way of estimating the muscle length for

length-tension relationships. Because the greatest kinematic differences in trunk angle were seen in RSLs, this postural change may be the driving factor behind the stiffness decreases that were observed in the RSLs condition. There were no differences found in the relative contributions to 'active' stiffness from the individual muscle groups, and therefore the hypothesis that there would be a decrease in the contribution from the abdominal musculature (Hypothesis 2.4) was rejected.

It was hypothesized that there would be an increase in the gluteus medius muscle activation, ipsilateral to the stance limb, during SLS in all participants following standing exposure, and that this effect would be largest in the PD group (Hypothesis 2.2). Peak left gluteus medius muscle activation was found to be higher post-standing exposure in LSLS for the PD group only, providing partial support for the hypothesis as stated. There was no increase in average gluteus medius muscle activation, and the effect was only seen in the PD group, and only during LSLS. As discussed previously, it is possible that the PD group was making an attempt to avoid excessive left lateral trunk bending during left SLS through increasing contraction of the left gluteus medius to bring the pelvis into a left lateral bend position as a compensation for their LBP.

It was expected that there would be a decrease in postural stability, as estimated by COP excursion, in all participants following the standing exposure, with a larger effect seen in the PD group (Hypothesis 2.3). While there were no PD/NPD group differences, there were gender differences with males having significantly greater COP excursion range in SLS following the standing exposure. These participants were a young, relatively fit and healthy group, and in general had good balance in single leg standing (no participants had major losses of balance during the task). This small decrease in postural stability in the

males could potentially have an impact on their ability or safety in performing balance-intensive tasks following a period of standing, particularly if the task in question involved high risk, such as walking on a narrow beam at an elevated height or working around dangerous (unstable, moving, hot) equipment in constrained quarters. Individuals who already have some balance deficit may be negatively impacted by a period of prolonged standing, and this should be a consideration when designing and implementing task rotation in the workplace. More study is needed to further investigate this, specifically in older populations that may be more susceptible to balance impairment. Hypothesis 2.3 is partially supported in that the males in this study did demonstrate a decrease in postural stability following the standing exposure.

Primary findings from this study indicate that prolonged standing exposure may have a negative impact on balance responses, ability to resist lateral bending loads while performing a balance challenge, and potentially result in inappropriate relaxation responses of the lumbar musculature during forward bending. These are all factors that should be considered when designing job rotation order in the workplace when a period of prolonged standing is included in the rotation schedule, or is a major component of the work being performed.

## **7. STUDY 3: RESPONSE TO AN EXERCISE-BASED INTERVENTION**

### **7.1. Introduction**

Exercise based interventions are commonly used in the treatment of low back pain (LBP). The first major theme of this thesis was to characterize differences between individuals who develop low back pain during standing and those who do not, and attempt to determine factors that may predispose individuals to becoming LBP developers. Once these factors were identified in Study 1, the second major theme of this research was to investigate responses in these variables in response to an exercise intervention that is similar to what is commonly used in the physiotherapy treatment of people with LBP. The focus for this study was limited to analyses of those variables that were determined to be of importance through the Study 1 findings.

### **7.2. Additional Methodology**

#### ***7.2.1. Assignment to Intervention Groups***

Participants were assigned to either an exercise intervention or control (usual activity) group through a semi-randomized process. Participants were assigned on an alternating basis according to gender and PD/NPD group after completing Collection Day 1. Every other male PD was assigned to exercise, every other male PD assigned to control, and likewise for male NPD, female PD and female NPD. This was done because it was unknown *a priori* whether individuals would be categorized as PD or NPD. In this way, an attempt was made to balance the intervention groups by PD/NPD group and gender. Originally, participants were classified as PD/NPD based on exceeding a threshold VAS criteria of  $\geq 10$  mm for the low back, and data collection ceased once there were at least 5 individuals in each group (total N=43). During subsequent data analysis, however, it was

deemed more appropriate to set the threshold criteria as  $\geq 10$  mm increase from baseline (at the start of the standing protocol), since some participants had non-zero VAS scores by the time the standing protocol began. This was done to be certain that the VAS increases that were reported were, in fact, associated with the prolonged standing protocol. This new classification resulted in some re-grouping of participants, and three individuals who had previously been categorized as PD, were re-classified as NPD. Therefore, there were unequal groups for the intervention study (Table 7.1). It should be noted that all analyses reported in Studies 1 and 2 were based upon this relative VAS score change classification criteria as described.

**Table 7.1 Sample distribution following re-classification and participant dropout**

	<b>Exercise</b>	<b>Control</b>
<b>Pain Developers (PD)</b>	<i>n</i> = 9	<i>n</i> = 8
<b>Non-Pain Developers (NPD)</b>	<i>n</i> = 10	<i>n</i> = 14
	<i>n</i> = 19	<i>n</i> = 22
<b>Total</b>	<b><i>N</i> = 41</b>	

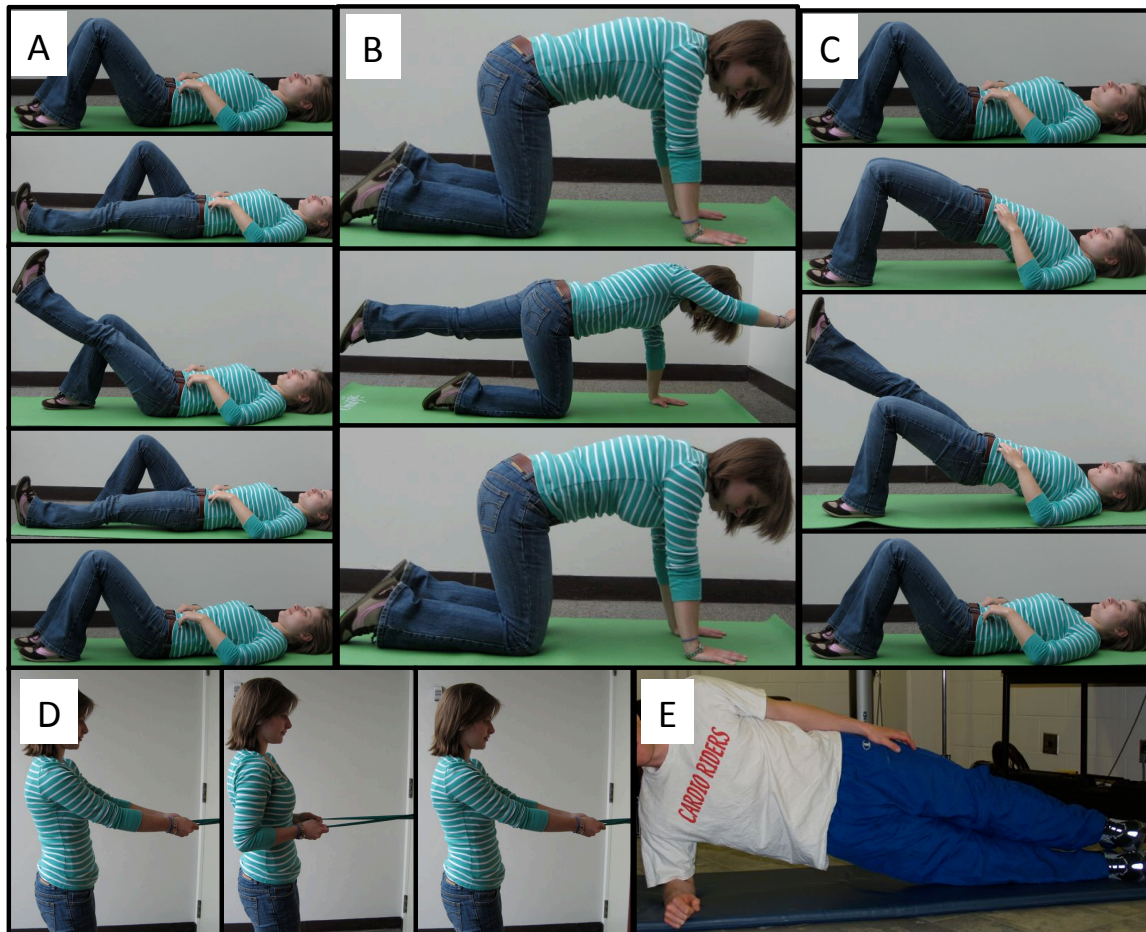
### **7.2.2. The Exercise Intervention**

Participants who were assigned to the exercise intervention group were requested to meet with the primary investigator (ENW) who is also a licensed physical therapist, to be instructed in an exercise program. This initial meeting lasted 30-45 minutes. The general format of the instructional session was as follows. The participant was shown a picture of the exercise, with a written description, and had the purpose and goal of the exercise explained to them verbally. Next the participant was asked to complete the exercise, and was given verbal and tactile cues, as necessary, to ensure they were performing the exercise correctly. The participant continued to perform the exercise, with decreasing levels of cueing, until the investigator, and the participant, were satisfied the participant

would be able to perform the exercise independently at home. This was done for each exercise in the program. Every participant was started at the same level for the first week. Each participant was provided with a handout that had illustrations and written cues and descriptions for each exercise (Appendix D). They were also provided with a 7-day exercise log (Appendix E) that had their goal frequency and duration for the week, as established by the primary investigator, written on it. They were asked to mark down the exercises they performed, the number of repetitions, and the total exercise duration for each day and bring the log back to the next meeting with the primary investigator. An attempt was made to schedule meetings to progress the exercise program every 7 days (in reality this ranged from 5 to 9 days) over the 4-week period.

At subsequent weekly meetings, each participant had their exercise program progressed according to how well they were performing the previous week's program. The threshold for progression was based on the ability to complete the goal number of repetitions, and to demonstrate correct execution of each exercise. A similar instructional method as was done on the first day was used each week to progress the exercise program.

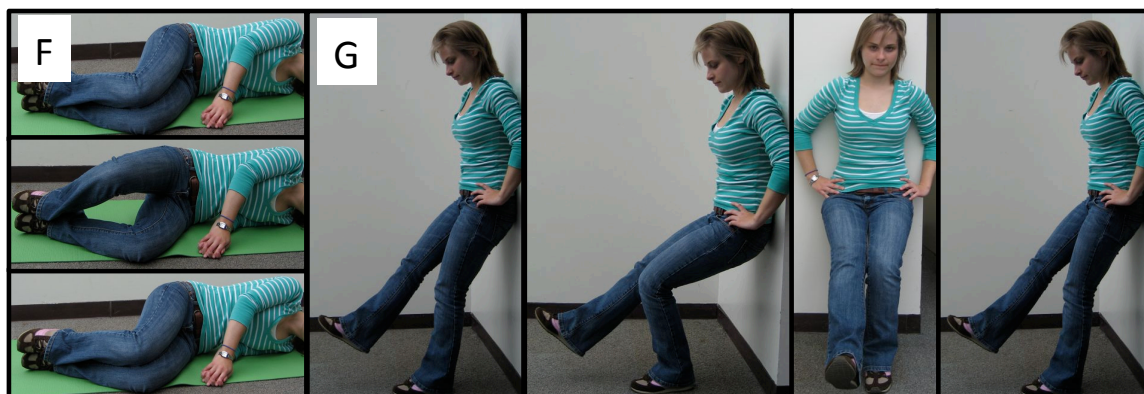
Many of the exercises for this intervention were taken from previous studies that have investigated response of patients with LBP to stabilization-based exercise programs (Hicks, Fritz et al. 2005). These exercises are shown in Figure 7.1.



**Figure 7.1** The exercise intervention included: A) abdominal bracing with heel slides and straight leg raises; B) Arm and leg extensions in quadruped (arm raise is shown); C) Bridging in supine; D) Standing rows with resistance band; E) Side bridge support

Because of the emphasis on hip, as well as trunk control in the current study, there were two additional exercises that were included (Figure 7.2). These were the ‘clamshell’ sidelying series (Sahrmann 2002), and the single leg wall-slide squat (Ayotte, Stetts et al. 2007).





**Figure 7.2 Additional exercises included: F) ‘Clamshells’ in sidelying; G) Single leg wall-slide squat with abdominal bracing**

Participants who were assigned to the control group were instructed to participate in their usual activities over the 4-week period between data collections. They were requested to refrain from initiating any new exercise programs during this 4-week period.

### **7.2.3. Data Collection Day 2**

An identical methodology was used for the data collection and signal processing and analyses for collection Day 2 as collection Day 1, with one exception. Participants did not fill out the psychosocial questionnaires on collection Day 2. There were two participants who did not complete the second data collection for personal reasons (F017 and M022). These participants were both in the NPD group. M022 was assigned to control and F017 was assigned to exercise intervention. Their data was therefore removed from the analysis for the between day comparisons. This left the sample gender distribution as N = 21 males and N = 20 females as reflected in Table 7.1.

Outcome variables that were of interest for this study were those that showed significant PD/NPD group differences in Study 1. The analyses performed for this study, therefore, focused only on those variables and changes in those variables between collection days in

response to the exercise intervention. Unless otherwise noted, statistical analyses were performed through 4-way general linear models, with between factors of gender, PD/NPD group and intervention, and within factor of collection day (2 repeated measures). Bonferroni corrected  $p$ -values were used for multiple comparisons. Where data were not spherical based on Mauchly's Test, Huynh-Feldt adjusted  $p$ -values were used to determine significance. Unless otherwise noted, pairwise comparisons were used for *post hoc* testing.

### **7.3. Exercise Compliance**

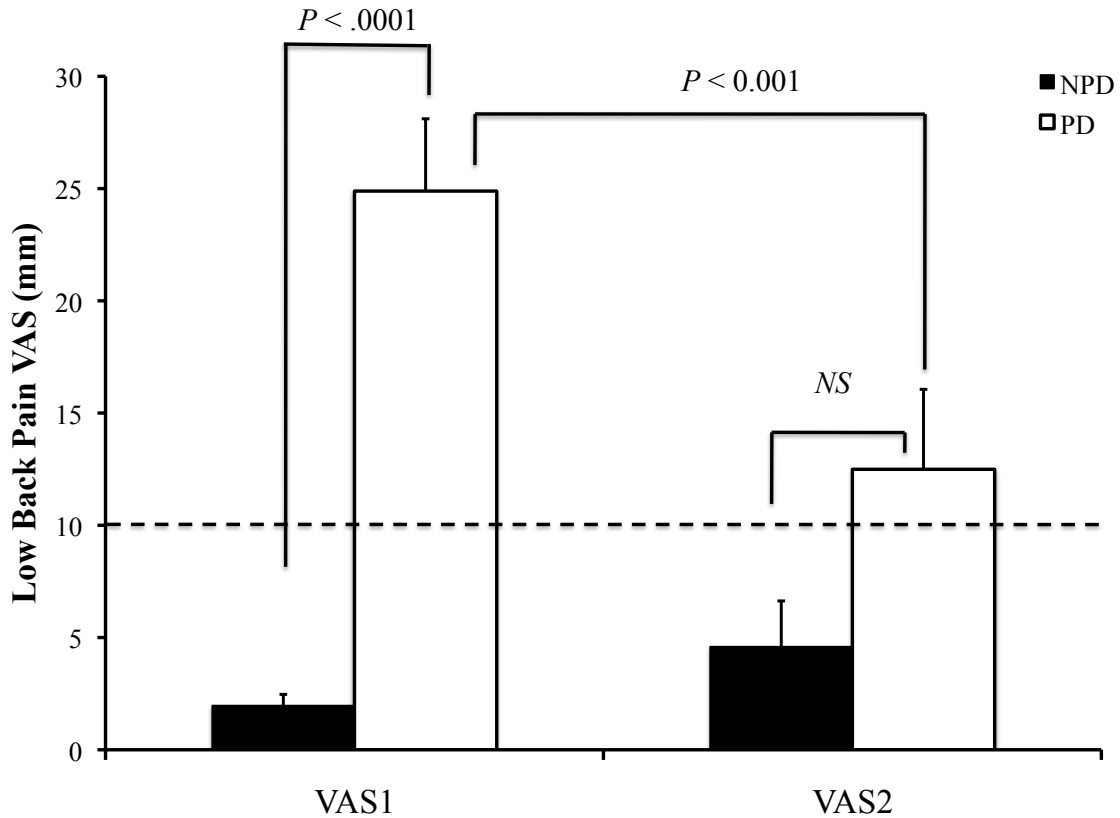
Participants assigned to the exercise intervention performed the exercise program on average 4.0 ( $\pm$  0.3) times per week over the 4-week period for an average weekly time spent exercising of 103.0 ( $\pm$  12.2) minutes (in addition to the weekly meeting with the primary investigator reviewing the exercises). There were no significant correlations between VAS change and frequency or duration of exercise ( $p > 0.05$ ). All of the participants assigned to exercise intervention progressed through the 4 levels of the exercise program.

### **7.4. Pain Development**

Independent t-tests were conducted on VAS scores of PD and NPD assigned to exercise intervention (PD<sub>EX</sub> and NPD<sub>EX</sub>) compared to those assigned to control (PD<sub>CON</sub> and NPD<sub>CON</sub>) to ensure that there were no differences between the intervention groups initially. All comparisons were non-significant ( $p > 0.10$ ).

Maximum VAS (change from baseline) scores from collection Days 1 and 2 were entered into the general linear model and there was a significant interaction between PD/NPD

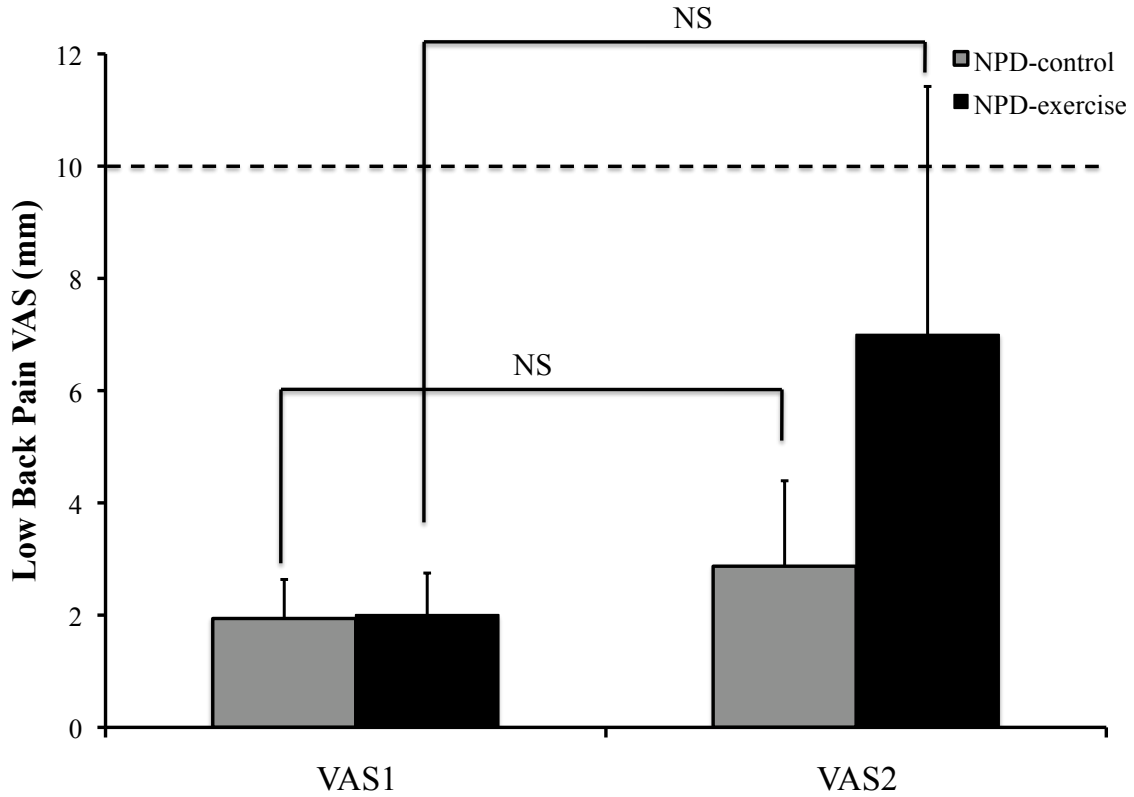
group and collection day ( $F_{2,984,116.394} = 14.22, p < .001$ ). There was no effect of gender on VAS score. These data are shown in Figure 7.3.



**Figure 7.3** There was a significant change in VAS score on Collection Day 2 for the PD group ( $p < 0.001$ ). There were no longer significant differences in VAS between PD and NPD groups ( $p > 0.05$ ) on Collection Day 2. The dashed gray line shows the cut-off threshold for PD/NPD classification.

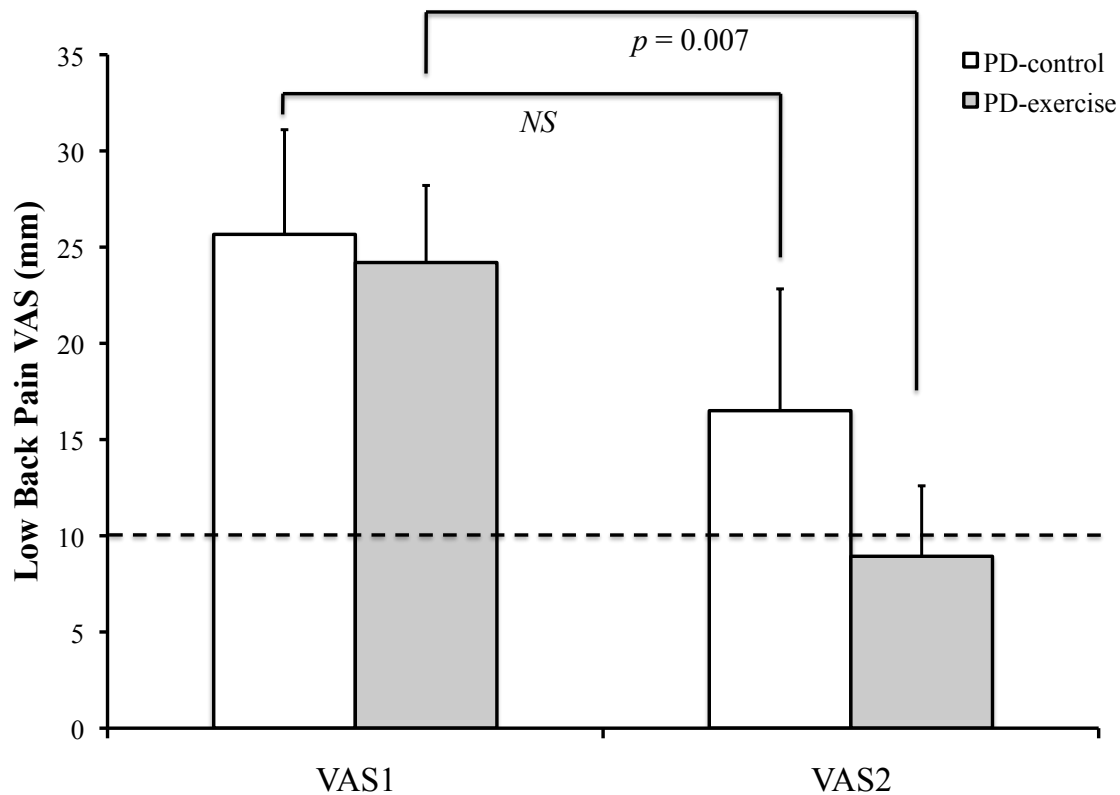
Four 1-tailed (directional hypotheses), paired t-tests were conducted (with Bonferroni corrected alpha of  $p < 0.0125$  for significance) for VAS levels in  $NPD_{CON}$ ,  $NPD_{EX}$ ,  $PD_{CON}$ , and  $PD_{EX}$  with repeated measure of collection day to determine whether there was a subjective response to the exercise intervention. There were no differences in VAS

score for either control group or the NPD<sub>EX</sub> group ( $p > 0.05$ ). VAS scores for the NPD<sub>CON</sub> and NPD<sub>EX</sub> groups are shown in Figure 7.4.



**Figure 7.4** There were no significant ( $p > 0.05$ ) changes in VAS score for either NPD<sub>CON</sub> or NPD<sub>EX</sub> between Collection Days 1 and 2. The dashed gray line shows cut-off threshold for PD/NPD classification.

The PD<sub>EX</sub> group showed a significant change in VAS score after 4 weeks of exercise ( $t_8 = 3.108, p = 0.0072$ ), with a large effect size (Cohen's  $d = -3.78$ ). VAS scores for the PD<sub>CON</sub> and PD<sub>EX</sub> groups are shown in Figure 7.5.



**Figure 7.5 PD<sub>EX</sub> had a significant ( $p < 0.0125$ ) change following the 4-week exercise intervention, while PD<sub>CON</sub> had no significant ( $p > 0.05$ ) change in VAS score. The dashed gray line shows the cut-off threshold for PD/NPD classification.**

There were clear subjective improvements as measured by decreased maximum VAS scores during the 2-hour standing period for the PD<sub>EX</sub> group following 4 weeks of participation in an exercise intervention that emphasized trunk and hip control during dynamic activities.

### 7.5. Activity Level Between Testing Sessions

Minnesota Leisure Time Physical Activity Questionnaire (MPAQ) scores for the 4-week period prior to entering into the study and for the 4-week period in between the two collection days were compared with paired *t*-tests to ensure that activity level for the control group did not change. There were no significant differences detected in activity

level ( $t_{21} = 1.745, p > 0.05$ ) for the control group participants, providing confidence that this group was compliant with instructions to continue with their usual level of activity.

Summary data for 4-week MPAQ scores on Days 1 and 2 are shown in Table 7.2.

**Table 7.2 Between-day comparisons for MPAQ scores by intervention group**

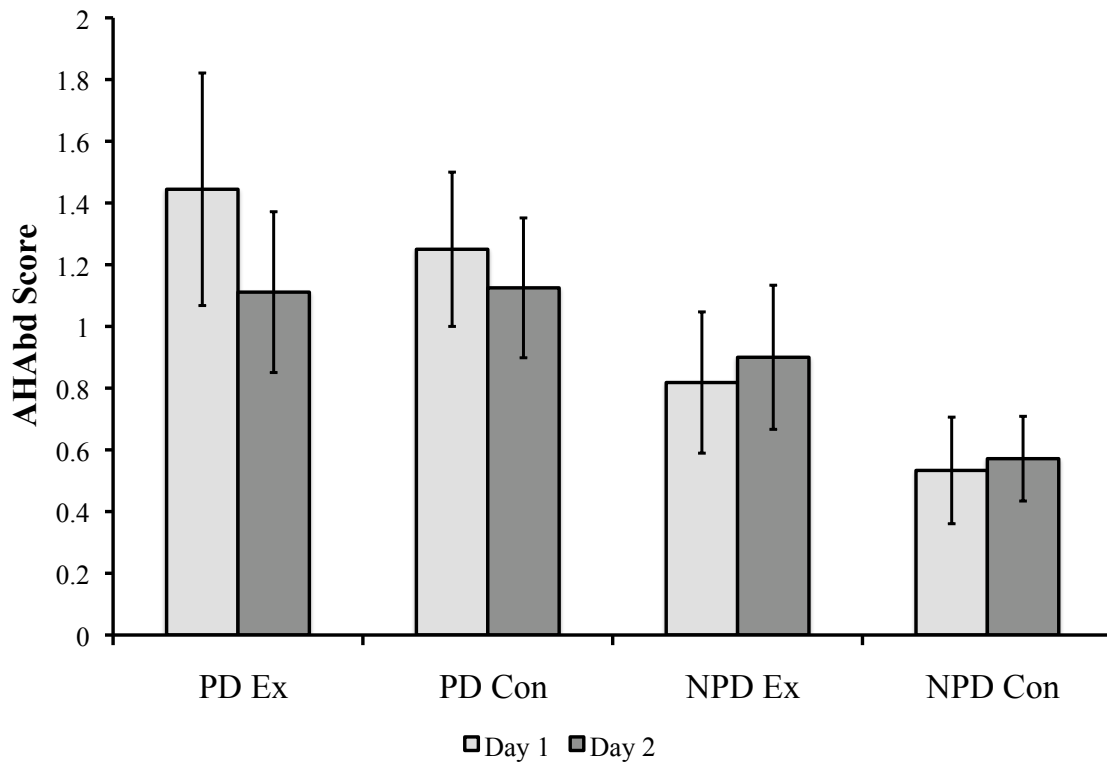
	<b>Day 1 Score</b>	<b>Day 2 Score</b>	<b><i>p</i>-value</b>
<b>Control Group</b>	15182.8 (6816.0)	13615.9 (7182.5)	0.096
<b>Exercise Group</b>	16908.7 (9506.7)	17618.4 (8895.7)	0.642

## 7.6. Clinical Assessment Findings

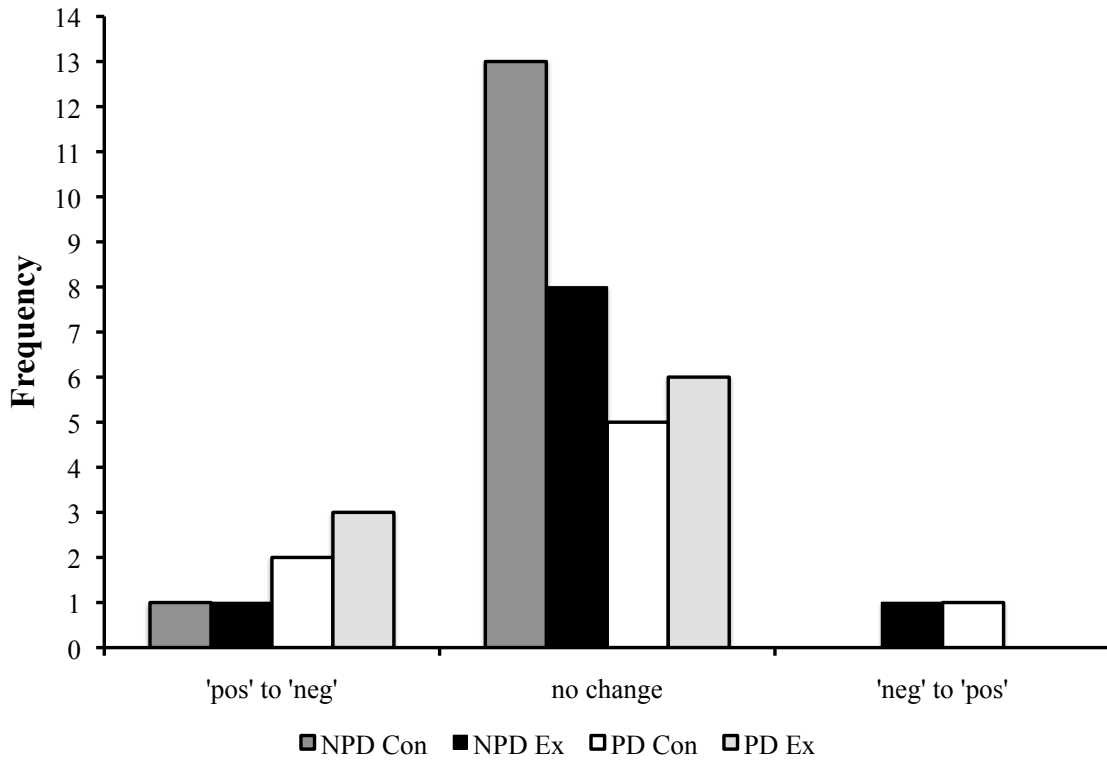
A clinical assessment, identical to Day 1, was performed by the same physical therapist (ENW). Since the Active Hip Abduction test was the only clinical measure that had significant group differences in Study 1, changes in performance on this test were the focus for this study. Examiner rated and self-rated AHAbd scores from collection days 1 and 2 were entered into 4-way general linear models with between factors of PD/NPD group, gender and intervention and within factor of collection day.

There were no significant findings on the self-rated AHAbd scores. There was a significant 4-way interaction ( $F_{1,33} = 7.523, p = 0.01$ ) between collection day, gender, intervention, and PD/NPD group on examiner-rated AHAbd, with a large effect size (Cohen's  $d = 0.95$ ). The scores were dichotomized as described in Study 1 (Nelson-Wong, Flynn et al. 2009), with a 'positive' test being a score  $\geq 2$  and a 'negative' test being a score  $< 2$ , and a Wilcoxon Signed Ranks Test was conducted with comparisons between PD/NPD groups, gender, and intervention. There were no significant between day differences detected on the AHAbd test with these comparisons. When the same test was conducted with comparisons between PD/NPD groups and intervention, however,

there was a trend for the PD<sub>EX</sub> group to have decreased scores on the AHAbd test ( $Z = -1.732, p = 0.083$ ) following the exercise intervention (Figure 7.6). Figure 7.7 shows the number of participants that changed from ‘positive’ to ‘negative’, ‘negative’ to ‘positive’, and no change in score following the 4-week intervention period.



**Figure 7.6 Raw examiner rated Active Hip Abduction Test scores between collection days by PD/NPD group and assigned intervention show a decrease for the PD<sub>EX</sub> group between days (non-significant at  $p = 0.08$ ).**



**Figure 7.7 Histogram plot of the between day changes in examiner-scored AHAbd test, using the  $\geq 2$  = 'pos' and  $< 2$  = 'neg' classification, by PD group and intervention received.**

A summary table for the clinical assessment measures for between day comparisons is provided as Table 7.3.



**Table 7.3 Summary data for clinical assessment measures**

<b>Assessment Measure</b>	<b>Day 1</b> Mean (SD)	<b>Day 2</b> Mean (SD)
Lumbar Flexion (°)	123.3 (15.5)	120.9 (14.9)
Lumbar Extension (°)	50.1 (12.0)	47.8 (13.9)
Lumbar Lateral Flexion (°)	50.9 (8.0)	50.2 (6.8)
Hip Flexion (°)	121.9 (8.7)	123.4 (8.6)
Hip Extension (°)	16.8 (5.0)	17.6 (7.3)
Hip Internal Rotation (°)	40.8 (9.8)	39.6 (9.5)
Hip External Rotation (°)	43.8 (11.1)	42.7 (11.2)
Straight Leg Raise (°)	70.0 (13.4)	70.4 (12.8)
Active Straight Leg Raise (0-10)	1.09 (1.7)	1.40 (1.68)
Self-rated Active Hip Abduction (0-10)	1.69 (1.88)	1.43 (1.81)
Examiner-rated AHAbd (0-3)	0.93 (0.88)	0.88 (0.71)
Segmental Mobility – Sacrum (0-3)	0.72 (0.45)	0.59 (0.50)
Segmental Mobility – L <sub>5</sub> (0-3)	0.58 (0.55)	0.61 (0.49)
Segmental Mobility – L <sub>4</sub> (0-3)	0.84 (0.43)	0.95 (0.44)
Segmental Mobility – L <sub>3</sub> (0-3)	1.02 (0.51)	1.00 (0.39)
Segmental Mobility – L <sub>2</sub> (0-3)	1.05 (0.49)	1.00 (0.39)
Segmental Mobility – L <sub>1</sub> (0-3)	0.98 (0.46)	0.90 (0.30)
Side Support (sec)	94.0 (39.5)	110.9 (52.8)
Extensor Endurance Test Time (sec)	145.3 (50.4)	148.9 (62.4)

On collection Day 1, the only assessment measure that was predictive of pain development during standing was the Active Hip Abduction test. Therefore it was expected that this factor would be the one that was most impacted by the intervention, especially given the significant decrease in VAS score that was observed in the PD<sub>EX</sub> group. It is likely that the sample sizes in this study were too small to detect changes in this measure in response to the exercise intervention, although there does appear to be some trends for the PD<sub>EX</sub> to have improvements in their performance on this test following exercise intervention. This test is being incorporated currently into a larger scale clinical study that should have large enough sample sizes to detect differences in this measure.

### **7.7. Extensor Endurance Test**

Paired *t*-tests were conducted on the MPF<sub>slope</sub> and RMS<sub>slope</sub> between the left and right musculature for each muscle group monitored (thoracic erector spinae, lumbar erector spinae and gluteus maximus) and showed that there were no significant differences ( $p > 0.05$ ) between left and right musculature. Therefore the data were collapsed into single measures for thoracic erector spinae (TES), lumbar erector spinae (LES) and gluteus maximus (GMax) by taking the average of the left and right pair for each participant.

Time to failure, average and peak normalized EMG, MPF<sub>slope</sub> and *rms*<sub>slope</sub> were entered into 4-way general linear models with between factors of PD/NPD group, gender, and intervention, and within factor of collection day. Average and peak EMG for gluteus maximus, thoracic, and lumbar erector spinae muscles were also entered into 5-way general linear models with between factors of gender, PD/NPD group and intervention, and within factors of muscle group and collection day to determine whether there were

differences in relative muscle activation level between the gluteal, lumbar and thoracic erector spinae muscles.

There were no changes in response to intervention on time to failure for the extensor endurance test ( $p > 0.05$ ). There remained a significant main effect of gender ( $F_{1,30} = 7.154$ ,  $p < 0.05$ ), with females being able to maintain the position for a longer time than males ( $173.1 \pm 69.3$  versus  $124.7 \pm 44.2$  s).

There were no main effects and no interactions for peak or average EMG amplitude for any of the three monitored muscle groups ( $p > 0.05$ ). There were no intervention effects on the relative muscle activation levels between the muscle groups from day 1 to day 2 ( $p > 0.05$ ). Similar gender differences in the relative average activation profile were observed on Day 2 as were found initially on Day 1 ( $F_{2,70} = 7.046$ ,  $p < 0.01$ ). There were no changes seen in relative peak muscle activation levels in response to intervention ( $p > 0.05$ ). Summary data for the muscle activation levels during the extensor endurance test are provided in Table 7.4.

**Table 7.4 Between-day peak and average muscle activation levels during extensor endurance test**

Muscle Activation Measures		Day 1	Day 2
		Mean (SD)	Mean (SD)
<b>Thoracic Erector Spinae</b> (% MVC)	Ave EMG	33.0 (7.9)	30.0 (12.9)
	Peak EMG	69.7 (19.0)	64.2 (27.6)
<b>Lumbar Erector Spinae</b> (% MVC)	Ave EMG	32.4 (9.9)	30.6 (14.1)
	Peak EMG	63.1 (19.6)	57.4 (26.5)
<b>Gluteus Maximus</b> (% MVC)	Ave EMG	17.3 (7.1)	16.5 (12.7)
	Peak EMG	48.9 (24.5)	43.2 (24.2)

There were no changes between days in muscle fatigability during the extensor endurance test, as measured by  $MPF_{slope}$  and  $rms_{slope}$  in response to exercise intervention for any of

the monitored muscle groups ( $p > 0.05$ ). Summary data for the  $MPF_{\text{slope}}$  and  $rms_{\text{slope}}$  are provided in Table 7.5.

**Table 7.5 Between-day measures of fatigability during extensor endurance test**

Fatigability Measures		Day 1 Mean (SD)	Day 2 Mean (SD)
<b>Thoracic Erector Spinae</b>	$MPF_{\text{slope}}$ (Hz/s)	-0.096 (0.07)	-0.081 (0.06)
	$rms_{\text{slope}}$ (mV/s)	$2.5 \times 10^{-4}$ ( $4.9 \times 10^{-4}$ )	$1.4 \times 10^{-4}$ ( $3.4 \times 10^{-4}$ )
<b>Lumbar Erector Spinae</b>	$MPF_{\text{slope}}$ (Hz/s)	-0.202 (0.10)	-0.186 (0.09)
	$rms_{\text{slope}}$ (mV/s)	$-2.75 \times 10^{-4}$ ( $4.6 \times 10^{-4}$ )	$2.18 \times 10^{-4}$ ( $3.9 \times 10^{-4}$ )
<b>Gluteus Maximus</b>	$MPF_{\text{slope}}$ (Hz/s)	-0.069 (0.08)	-0.047 (0.05)
	$rms_{\text{slope}}$ (mV/s)	$2.10 \times 10^{-4}$ ( $3.0 \times 10^{-4}$ )	$1.05 \times 10^{-4}$ ( $2.3 \times 10^{-4}$ )

## 7.8. Flexion Relaxation Ratio

As was done in Study 1, lumbar flexion trials in standing were collected prior to instrumentation with motion capture markers. In contrast to the first data collection, all participants had these trials (without motion capture instrumentation) collected for the second data collection. Paired  $t$ -tests were conducted on the Flexion Relaxation Ratio (FRR) data between the left and right musculature for each muscle group monitored (thoracic erector spinae, lumbar erector spinae and gluteus maximus) and showed that there were no significant differences between left and right musculature ( $p > 0.05$ ).

Therefore the data were collapsed into single measures for thoracic erector spinae (TES), lumbar erector spinae (LES) and gluteus maximus (GMax) by taking the average of the left and right pair for each participant.

There were no significant changes between days in FRR in response to the exercise intervention for any of the monitored muscle groups ( $p > 0.05$ ). Although there were no main or interaction effects of day or intervention, the PD/NPD group differences in the

FRR for the gluteus maximus muscles detected previously on Day 1, were no longer present on Day 2 (Table 7.6).

**Table 7.6 Between-day flexion relaxation ratios (FRR)**

		<b>Day 1 FRR</b> Mean (SD)	<b>Day 2 FRR</b> Mean (SD)
<b>NPD</b>	Thoracic Erector Spinae	7.7 (10.3)	8.3 (16.0)
	Lumbar Erector Spinae	15.6 (27.5)	11.3 (14.8)
	Gluteus Maximus	0.92 (1.0)	2.6 (7.5)
<b>PD</b>	Thoracic Erector Spinae	5.4 (8.0)	4.0 (6.8)
	Lumbar Erector Spinae	18.6 (60.4)	8.5 (15.3)
	Gluteus Maximus	3.4 (6.8)	2.3 (3.7)

There was one participant (M05, NPD<sub>CON</sub>) who was deemed to be an outlier on the Day 2 FRR. This participant had an increase in FRR of the gluteus maximus muscles from 0.970 on Day 1 to 36.68 on Day 2. When this individual was removed from the Day 2 analysis, the between PD/NPD group differences for FRR of the gluteus maximus that were observed on Day 1 remained on Day 2 ( $0.69 \pm 0.54$  for NPD versus  $2.32 \pm 3.66$  for PD).

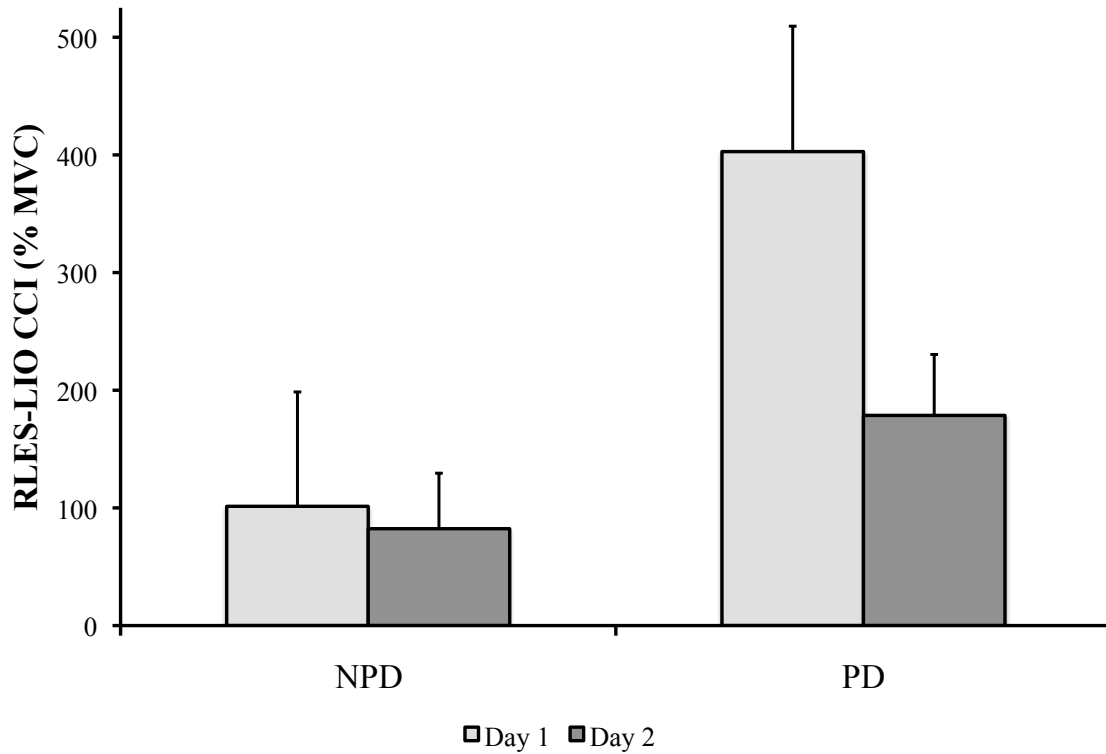
## **7.9. Single Leg Stance**

### **7.9.1. Muscle Co-contraction During Single Leg Stance**

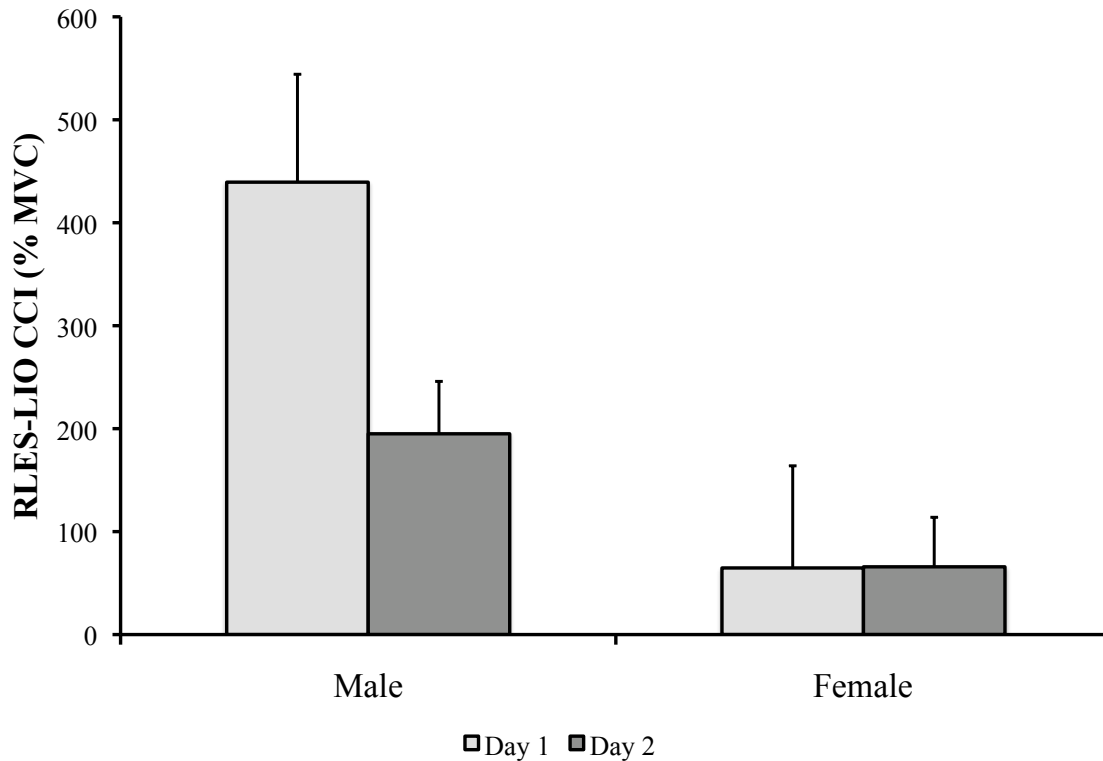
Co-contraction levels of the trunk muscles during the first repetition of right and left single leg stance (RSLS, LSLS) were determined by co-contraction index (CCI) as was done in Study 1. As described previously, frame numbers were extracted from the force platform data to determine the window of data where participants were in the SLS position. The variable of interest for this study was the muscle pair that was found to have significant PD/NPD group differences in Study 1. Therefore, between day changes in CCI for the right lumbar erector spinae and left internal oblique (RLES-LIO) muscle

pair during RSLs were considered. CCI values during RSLs for the RLES-LIO muscle pair from collection days 1 and 2 were entered into a 4-way general linear model with between factors of gender, PD/NPD group, and intervention and within factor of collection day. To determine the response to intervention, any significant interaction including collection day and intervention was considered to be relevant for this study.

There were no significant interactions that included intervention and collection day for RLES-LIO CCI during RSLs. There were significant 2-way interactions between collection day and PD/NPD group ( $F_{1,29} = 4.363, p < 0.05$ ) and collection day and gender ( $F_{1,29} = 6.244, p < 0.05$ ) (Figure 7.8 and Figure 7.9 respectively). There remained a significant PD/NPD group by gender interaction ( $F_{1,29} = 4.793, p < 0.05$ ), with male PD having higher co-contraction ( $528.6 \pm 116.4$  % MVC) of the RLES-LIO muscle pair during RSLs than male NPD ( $105.9 \pm 92.3$  % MVC) and female PD not being significantly different from female NPD ( $52.8 \pm 96.4$  versus  $77.8 \pm 102.2$  respectively) over the two collection days.



**Figure 7.8** The PD group had a decrease in right lumbar erector spinae-left internal oblique co-contraction during RLS ( $p < 0.05$ ) on the second collection day, regardless of intervention received, while the NPD group had no change.



**Figure 7.9 Males had an overall decrease in co-contraction of the right lumbar erector spinae-left internal oblique muscle pair during RSLs ( $p < 0.05$ ) on Day 2, while females had no change.**

Summary data for the 8 trunk flexor-extensor co-contraction index combinations between collection days are presented in Table 7.7 (LSLS) and Table 7.8 (RSLs).

**Table 7.7 Summary data for trunk co-contraction values in left single leg standing.**

Left Single Leg Standing CCI (% MVC)		Day 1 Mean (SD)	Day 2 Mean (SD)
<b>Left Lumbar Erector Spinae</b> (co-contraction with each of the listed muscles in column 2)	Left external oblique	495.4 (953.5)	781.8 (1863.1)
	Left internal oblique	140.2 (186.3)	237.3 (364.7)
	Right external oblique	575.5 (1388.4)	1027.1 (2527.5)
	Right internal oblique	209.2 (304.3)	591.3 (1795.5)
<b>Right Lumbar Erector Spinae</b> (co-contraction with each of the listed muscles in column 2)	Left external oblique	804.1 (1255.3)	677.1 (1454.1)
	Left internal oblique	278.5 (593.1)	275.4 (562.2)
	Right external oblique	668.8 (1214.6)	617.6 (1202.5)
	Right internal oblique	422.6 (622.6)	462.0 (880.6)



**Table 7.8 Summary data for trunk co-contraction values in right single leg standing.**

<b>Right Single Leg Standing CCI (% MVC)</b>		<b>Day 1</b> Mean (SD)	<b>Day 2</b> Mean (SD)
<b>Left Lumbar Erector Spinae</b> (co-contraction with each of the listed muscles in column 2)	Left external oblique	1810.9 (5715.2)	469.3 (666.6)
	Left internal oblique	632.4 (1517.9)	288.3 (360.2)
	Right external oblique	1026.8 (1807.4)	1183.4 (2492.5)
	Right internal oblique	300.0 (531.5)	467.2 (1212.1)
<b>Right Lumbar Erector Spinae</b> (co-contraction with each of the listed muscles in column 2)	Left external oblique	362.4 (719.4)	207.6 (355.7)
	Left internal oblique	186.9 (437.3)	110.3 (229.1)
	Right external oblique	189.0 (207.8)	275.4 (573.7)
	Right internal oblique	78.5 (82.1)	102.1 (125.6)

**7.9.2. Gluteus Medius Muscle Activation During Single Leg Stance**

Average and peak muscle activation for the ipsilateral gluteus medius muscles during single leg stance were entered into 4-way general linear models with between factors of gender, PD/NPD group, and intervention and within factor of collection day. As before, to determine the response to intervention, the interactions of interest were any that included both collection day and intervention. There were no between day differences in response to intervention in average or peak gluteus medius EMG for either RSLS or LSLS. The PD/NPD group differences that were present on collection day 1 persisted on collection day 2 with the PD group having higher activation levels of these muscles (Table 7.9).

**Table 7.9 Peak and average gluteus medius (Glut Med) muscle activation for PD/NPD groups during single leg stance (SLS) on collection Days 1 and 2**

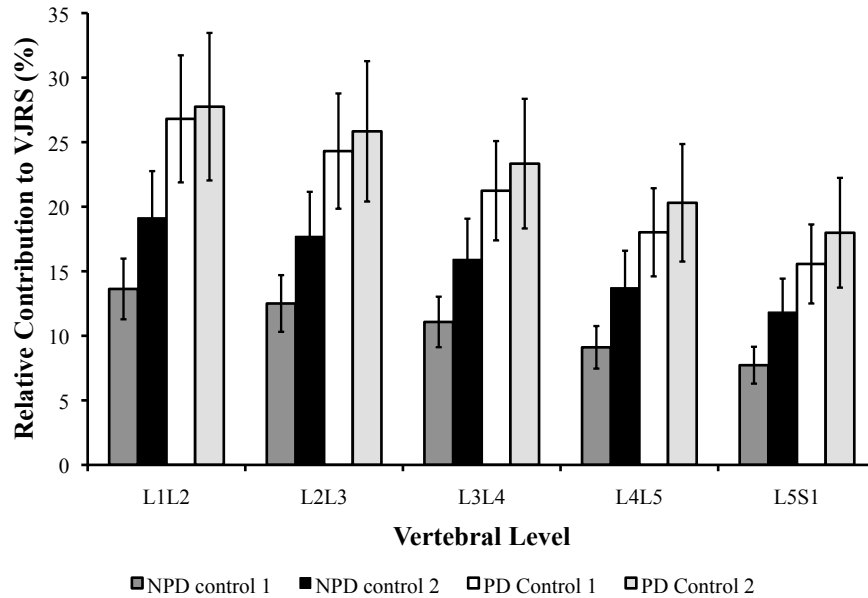
		<b>PD Day 1</b> Mean (SD)	<b>PD Day 2</b> Mean (SD)	<b>NPD Day 1</b> Mean (SD)	<b>NPD Day 2</b> Mean (SD)
<b>L Glut Med LSLs</b> (% MVC)	Average	6.1 (4.3)	7.8 (5.1)	6.0 (3.6)	5.4 (3.6)
	Peak	14.6 (7.3)	14.3 (8.2)	8.1 (4.9)	9.7 (6.1)
<b>R Glut Med RSLs</b> (% MVC)	Average	7.2 (4.5)	6.8 (6.7)	5.0 (3.4)	4.8 (4.9)
	Peak	11.5 (6.9)	12.1 (12.3)	9.7 (6.4)	8.9 (7.9)

### 7.10. Vertebral Joint Rotation Stiffness During Squat Task

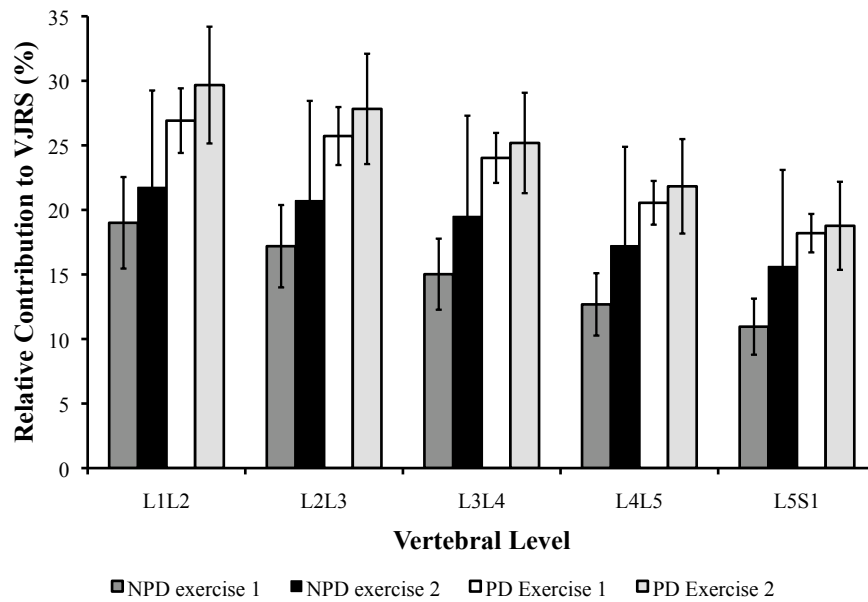
Relative contribution of the external oblique (EO) muscle to ‘active’ vertebral joint rotation stiffness (VJRS) during the ‘up’ and ‘down’ phases of the squat task were found to be different between PD and NPD groups in Study 1. To determine whether the exercise intervention had any impact on this factor, peak and average values for the relative stiffness contribution of the EO during the ‘up’ and ‘down’ phases for the initial squat repetition on Days 1 and 2 were first entered into 5-way general linear models with between factors of PD/NPD group and intervention, and within factors of vertebral level (5), rotation axis (3), and collection day (2).

For the average relative contribution of EO during the ‘up’ phase, there was a significant 5-way interaction between all of the factors ( $F_{3,674,132.246} = 3.683, p < 0.01$ ). To simplify, these data were then entered into 4-way general linear models with between factors of PD/NPD group and intervention and within factors of vertebral level and collection day, for each rotation axis. There were no significant interactions including day and intervention for contribution to stiffness about the *x*-axis (lateral bend), although PD/NPD group differences remained ( $F_{1,36} = 6.841, p < 0.05$ ), with the PD group having higher average relative contributions of the EO to VJRS about the lateral bend axis ( $20.4 \pm 1.9$

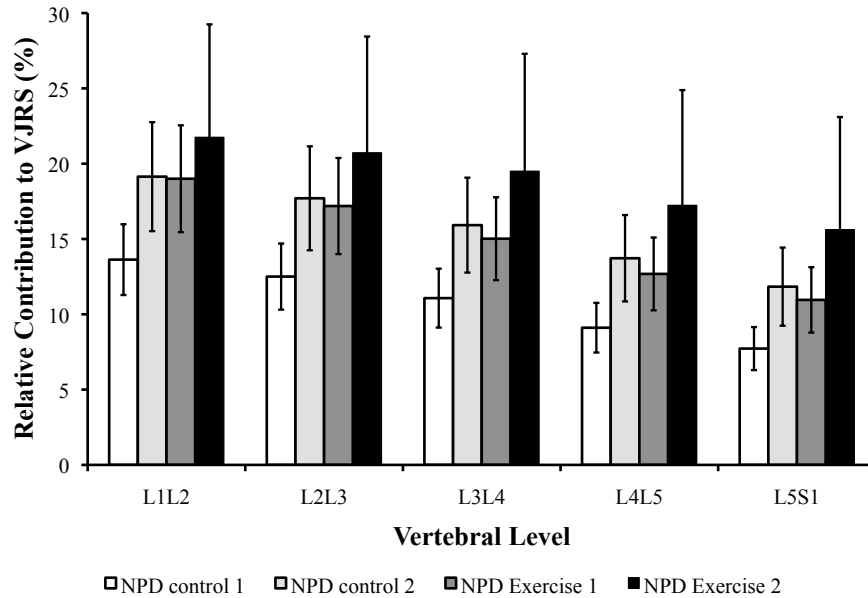
%) than the NPD group ( $14.3 \pm 1.4$  %). Similarly, there were no between day changes in average relative contribution of EO about the  $z$ -axis (flexion/extension), and no PD/NPD group differences. There was a significant 4-way interaction between PD/NPD group, intervention, vertebral level and collection day ( $F_{1,313, 47.261} = 6.824, p < 0.01$ ) for average relative contribution to VJRS about the  $y$ -axis (axial twist). To interpret this interaction, these data were plotted for control group only (Figure 7.10), exercise group only (Figure 7.11), NPD group only (Figure 7.12), and PD group only (Figure 7.13). All groups had decreasing contributions of the EO to VJRS from L<sub>1</sub>L<sub>2</sub> through L<sub>5</sub>S<sub>1</sub> vertebral levels. The NPD<sub>CON</sub> groups had increased relative contribution of the EO to VJRS on Day 2, while NPD<sub>EX</sub> and both PD<sub>EX,CON</sub> groups had no between day differences. The PD/NPD group differences that were seen on Day 1 were still present on Day 2, with the PD group having higher relative contributions of the EO muscles towards VJRS, about all 3 axes, than the NPD group.



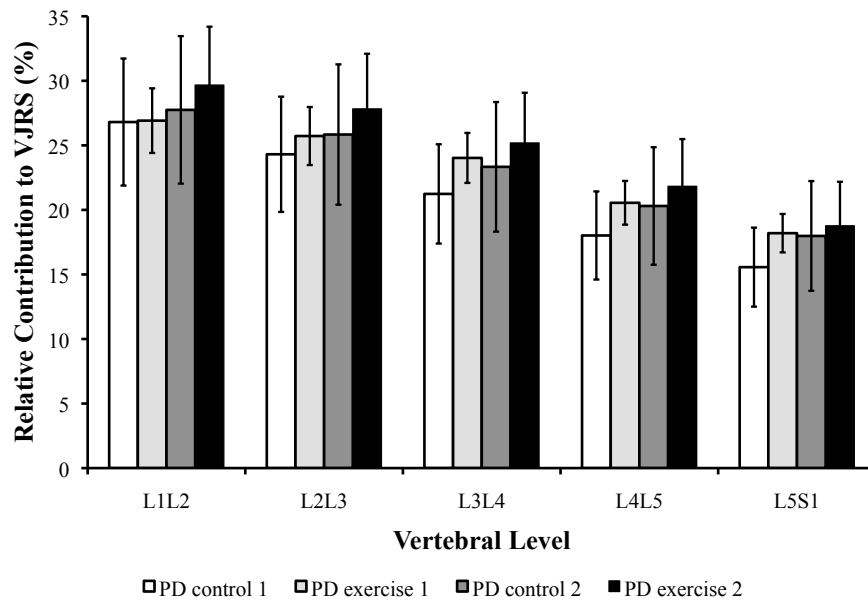
**Figure 7.10** NPD<sub>CON</sub> had an increased relative contribution of the EO muscle to VJRS about the y-axis (axial twist) during the 'up' phase of squat on the second collection day, while PD<sub>CON</sub> had no changes between days.



**Figure 7.11** There were no effects of the exercise intervention on EO contribution to VJRS about the y-axis (axial twist) during the 'up' phase of squat for either PD or NPD groups.

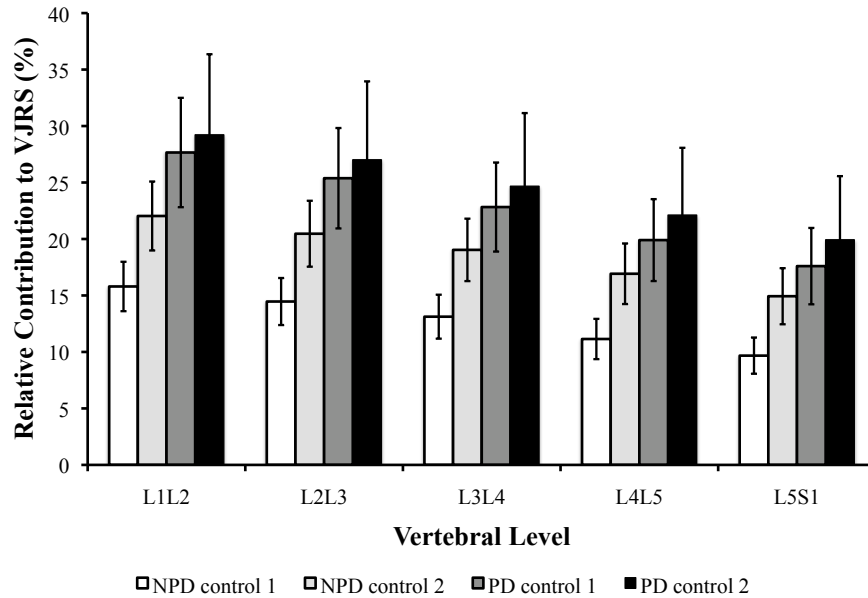


**Figure 7.12** The NPD<sub>CON</sub> group had an increase in the relative contribution from the EO muscles to VJRS about the y-axis (axial twist) during the ‘up’ phase of squat on Day 2.

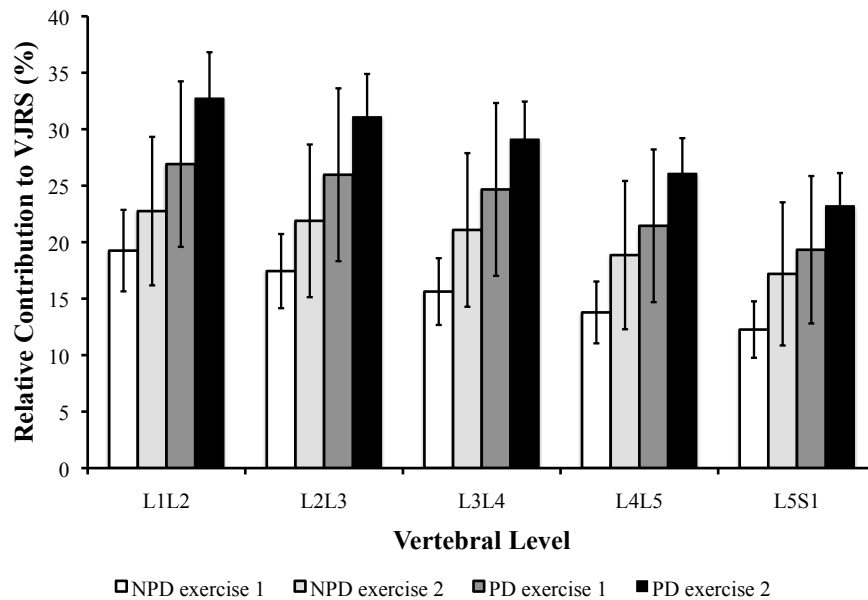


**Figure 7.13** There were no between day changes in EO contribution to VJRS about the y-axis (axial twist) during the ‘up’ phase of squat for the PD group, regardless of intervention received.

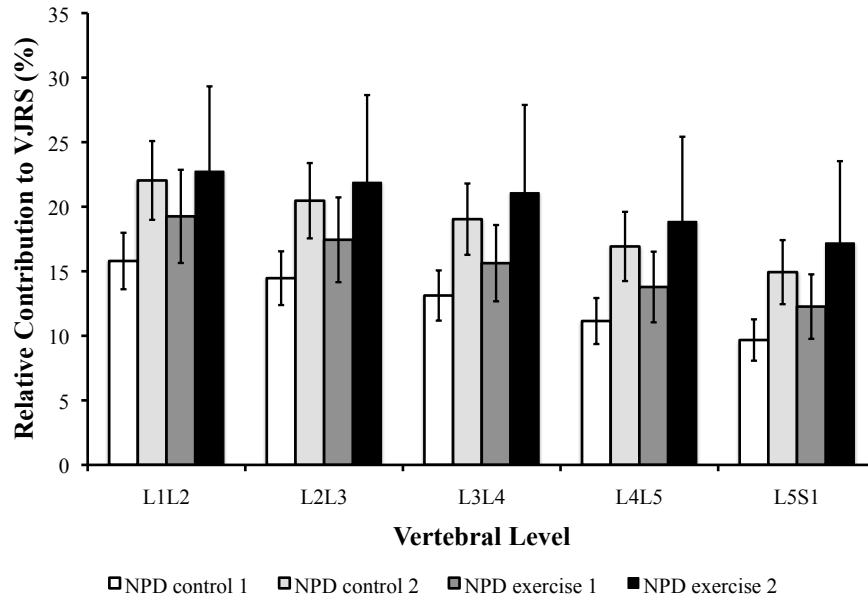
There were similar findings for the average relative contribution of the EO muscles during the ‘down’ phase of the squat. About the  $x$ -axis (lateral bend), there were no between day or intervention effects, however the PD/NPD group differences from Day 1 persisted on Day 2 ( $F_{1,36} = 4.668, p < 0.05$ ), with the PD group having higher average relative contributions of EO to stiffness about the lateral bend axis ( $22.1 \pm 2.1$  %) than the NPD group ( $16.4 \pm 1.6$  %), and no differences about the flexion/extension axis ( $p > 0.05$ ). As with the ‘up’ phase of the squat, there was a 4-way interaction ( $F_{1,355,48.784} = 6.281, p < 0.01$ ) between PD/NPD group, intervention, vertebral level and collection day about the  $y$ -axis (axial twist). As before, these data were plotted for the control group only (Figure 7.14), exercise group only (Figure 7.15), NPD group only (Figure 7.16) and PD group only (Figure 7.17). The same differences were seen during the ‘down’ phase of squat as in the ‘up’ phase, with the NPD<sub>CON</sub> group having increased relative contribution from the EO on the second day, and the other three groups remaining similar between days.



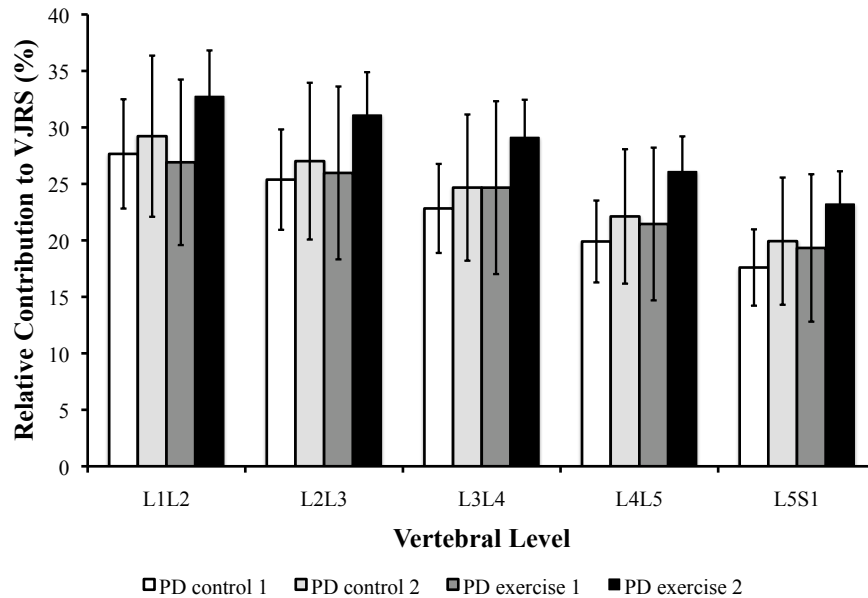
**Figure 7.14** The average relative contribution of the EO to VJRS about the *y*-axis during the ‘down’ phase of the squat increased for the NPD<sub>CON</sub> group only on Day 2.



**Figure 7.15** Average contribution of EO to stiffness about the *y*-axis during the ‘down’ phase of squat did not change for PD or NPD groups after exercise intervention.



**Figure 7.16** There was an increase in the EO contribution to axial stiffness during the ‘down’ phase of squat on the second day for the NPD<sub>CON</sub> group.



**Figure 7.17** There were no significant between day changes in EO contribution to axial stiffness during the ‘down’ phase of squat for PD<sub>EX,CON</sub>.

Findings were similar for the peak values of the EO contribution to stiffness during the ‘up’ phase of the squat, with a significant 4-way interaction ( $F_{1,463,52.656} = 5.396, p < 0.05$ )



between PD/NPD group, intervention, vertebral level and collection day for the axial twist axis, and no between day differences for the lateral bend or flexion/extension axes. Peak data followed the same pattern as the average data for the ‘up’ phase, with the NPD<sub>CON</sub> group showing increased peak contribution on of the EO on Day 2, and the other groups showing no between day differences. PD/NPD group differences remained that were found on Day 1. For the ‘down’ phase of the squat, there were no significant between day differences for peak contribution of the EO about any of the three rotation axes.

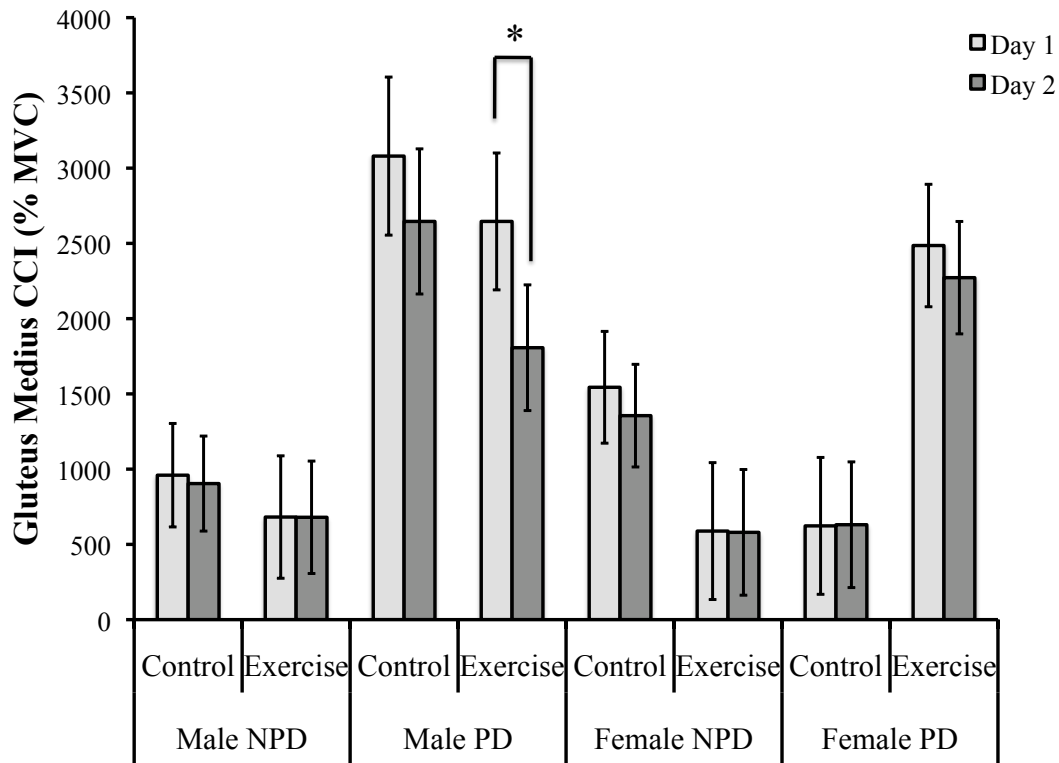
### **7.11. Muscle Co-activation During Prolonged Standing**

The same methodology was utilized to calculate co-contraction indices (CCI) for the prolonged standing data as was previously described in Study 1. In brief, CCI was calculated for each 1-minute window (1,920 data points) during standing, and then average values were taken across each 15-minute block yielding 8 repeated measures over the 2-hour standing protocol. As a data reduction measure, the combinations of pairs for the trunk flexors and extensors were reduced to a single ‘global’ measure of trunk flexor/extensor co-contraction as previously described.

#### ***7.11.1. Co-contraction Index (CCI) for Gluteus Medius (GMed)***

Data for F021 (NPD<sub>CON</sub> group) were excluded for this measure due to not having good EMG signal on gluteus medius for Collection Day 1. Gluteus medius CCI data from Days 1 and 2 were entered into a 5-way general linear model with between factors of gender, PD/NPD group and intervention and within factors of time (8 repeated measurements on each day) and collection day (2 repeated measures). The interaction of interest was any interaction including collection day and intervention. There was a significant 4-way

interaction of gender, PD/NPD group, collection day and intervention ( $F_{1,29} = 16.33, p < 0.001$ , Cohen's  $d = 1.88$ ). As is shown in Figure 7.18, there were no differences between collection days in gluteus medius co-contraction for NPD<sub>EX</sub> or NPD<sub>CON</sub> for either gender. The PD<sub>CON</sub> groups were also similar between days, for both genders. There were gender differences detected in the PD<sub>EX</sub> group. Male PD<sub>EX</sub> had an overall decrease during the 2-hours of standing on Day 2, while female PD<sub>EX</sub> showed no change between collection days in co-contraction of the gluteus medius muscles.

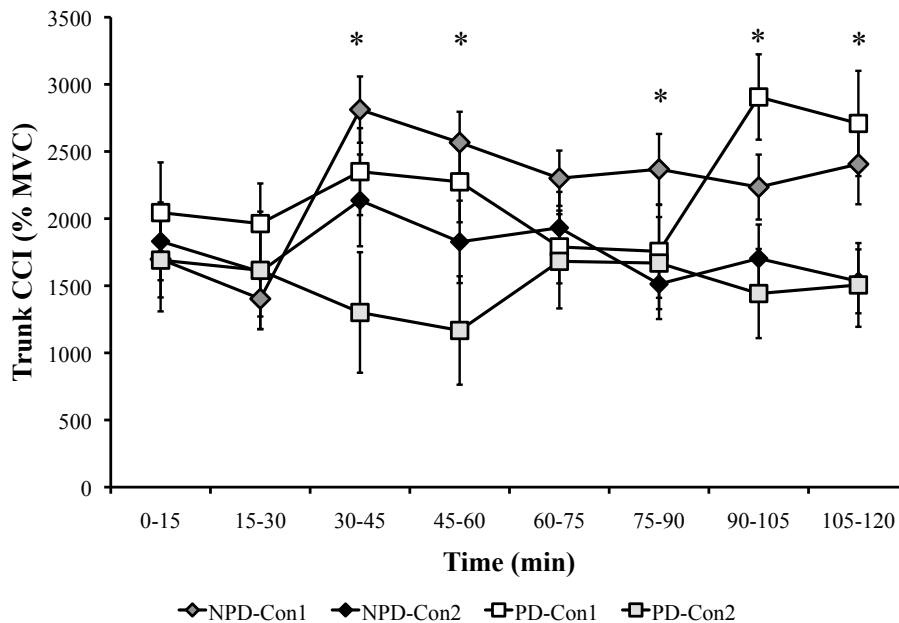


**Figure 7.18 The Male PD<sub>EX</sub> group was the only group that had differences in gluteus medius CCI between collection days (\* $p < 0.05$ ).**

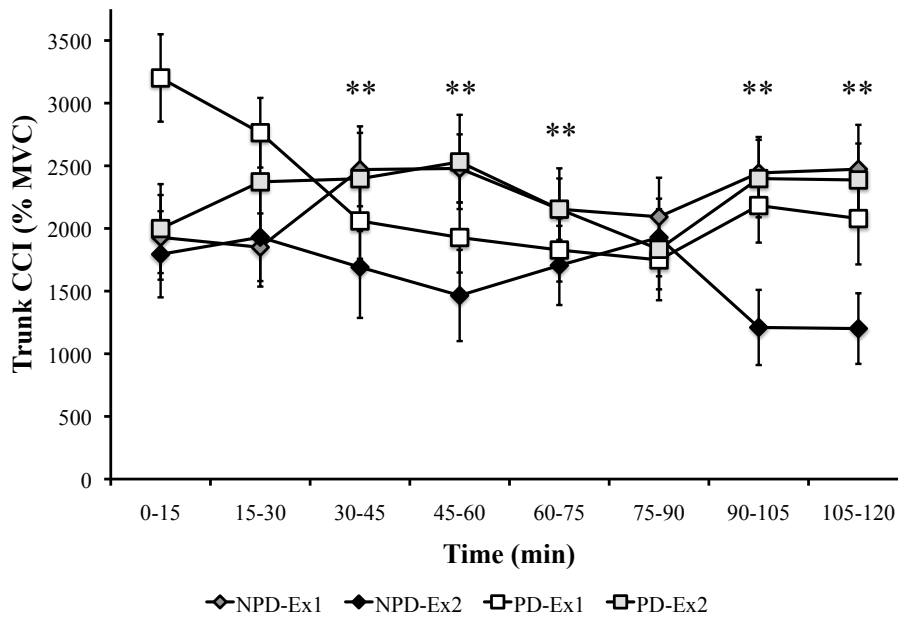
### 7.11.2. Co-Contraction Index (CCI) for the Global Trunk Flexors/Extensors

The global trunk flexor/extensor CCI data from Days 1 and 2 were entered into a 5-way general linear model with between factors of gender, PD/NPD group and intervention and within factors of time (8 repeated measurements on each day) and collection day (2 repeated measures). There was a significant 4-way interaction of collection day, time, intervention and PD/NPD group ( $F_{4,395,136,251} = 2.444, p < 0.05, \text{Cohen's } d = 0.27$ ).

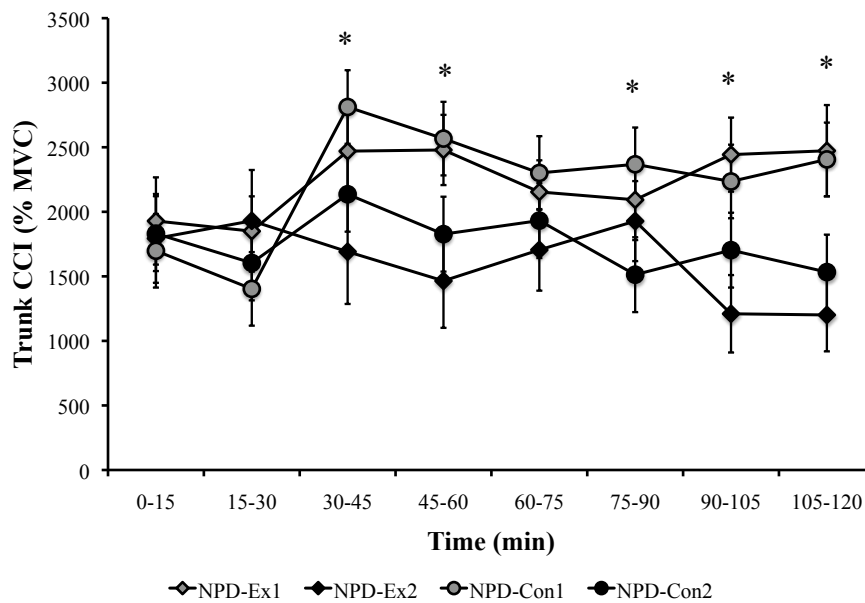
To allow for improved interpretation of the higher order interaction involving the 8 repeated time measures, these data were plotted by control only (Figure 7.19), exercise only (Figure 7.20), NPD only (Figure 7.21), and PD only (Figure 7.22). Significant changes in trunk co-contraction that are in the same direction (i.e.; decreasing for both groups plotted) are denoted by \*, while changes that are in opposite directions (i.e.; one group increasing and one group decreasing trunk co-contraction) are denoted by \*\*.



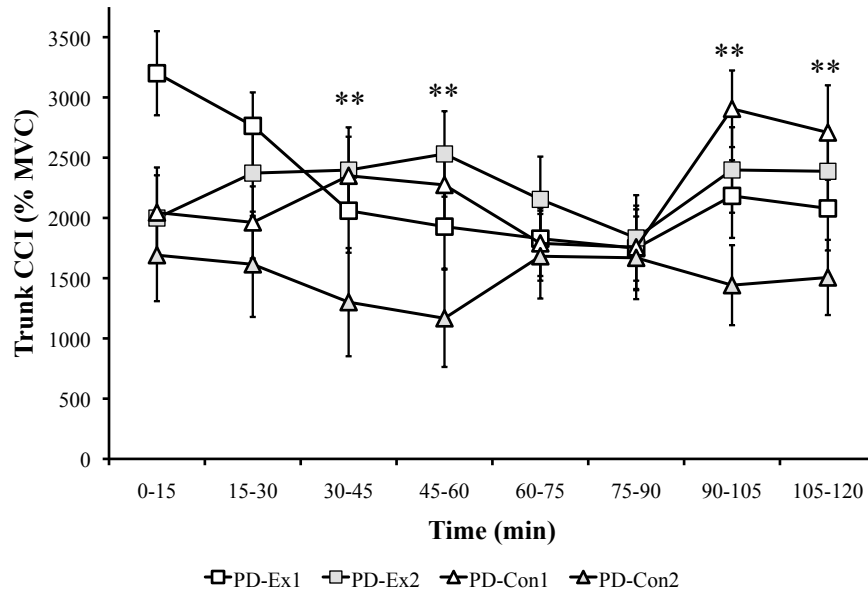
**Figure 7.19 Both NPD<sub>CON</sub> and PD<sub>CON</sub> had significant decreases in trunk flexor/extensor CCI (\* $p < 0.05$ ) on Collection Day 2.**



**Figure 7.20** There were differences in the  $NPD_{EX}$  and  $PD_{EX}$  response to intervention, with  $PD_{EX}$  having increases and  $NPD_{EX}$  having decreases in trunk co-contraction throughout the 2-hour standing period.



**Figure 7.21** When NPD were examined independently, it could be seen that there was a decrease in trunk CCI for both exercise and control groups between collection days.



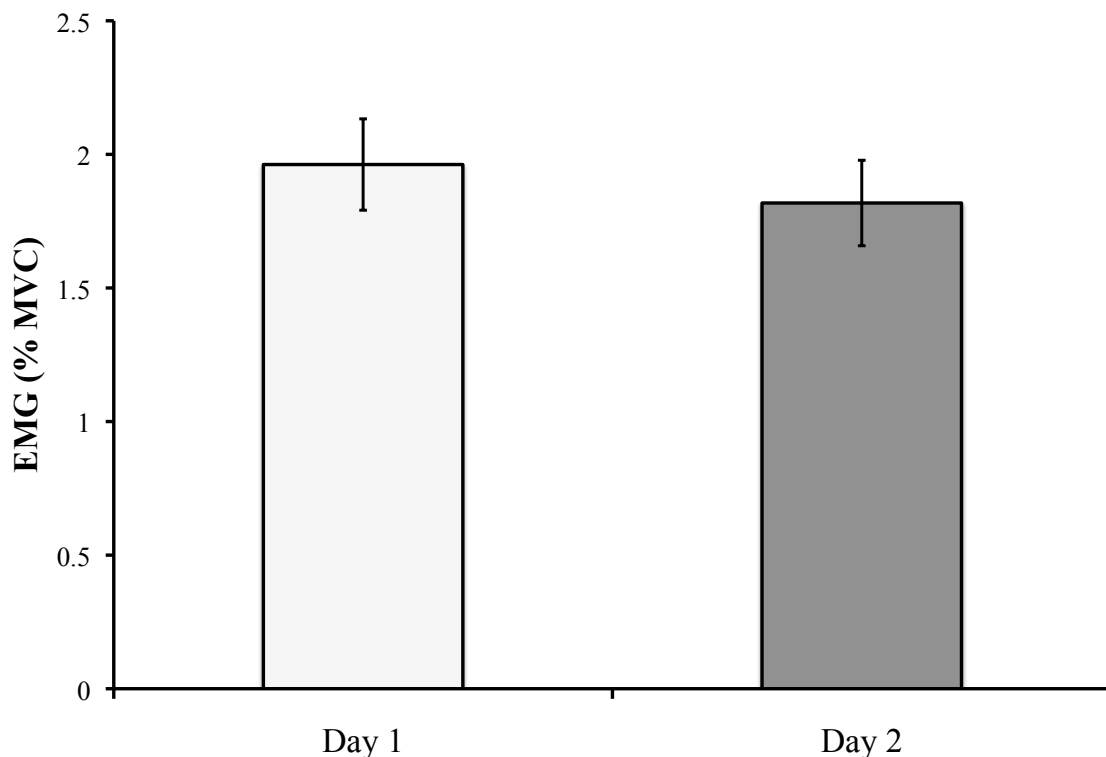
**Figure 7.22 PD<sub>EX</sub> had an initial decrease, followed by increased trunk co-contraction. PD<sub>CON</sub> demonstrated decreased trunk co-contraction on Day 2 throughout the 2-hour standing period.**

## 7.12. Muscle Activation Patterns During Prolonged Standing

### 7.12.1. Muscle Activation Levels During Standing

Average muscle activation levels were calculated for each 15-minute window for the 2-hour standing period from the linear enveloped EMG signals. Variables of interest were those that showed significant PD/NPD group differences in Study 1. These included the right lumbar erector spinae (RLES), right and left gluteus medius (RGMd, LGMd) and right and left gluteus maximus (RGMx, LGMx) muscles. These data were entered into 5-way general linear models with between factors of PD/NPD group, gender, intervention and within factors of time (8 repeated measures) and collection day (2 repeated measures). To determine response to intervention, the outcome of interest included any interaction between collection day and intervention received.

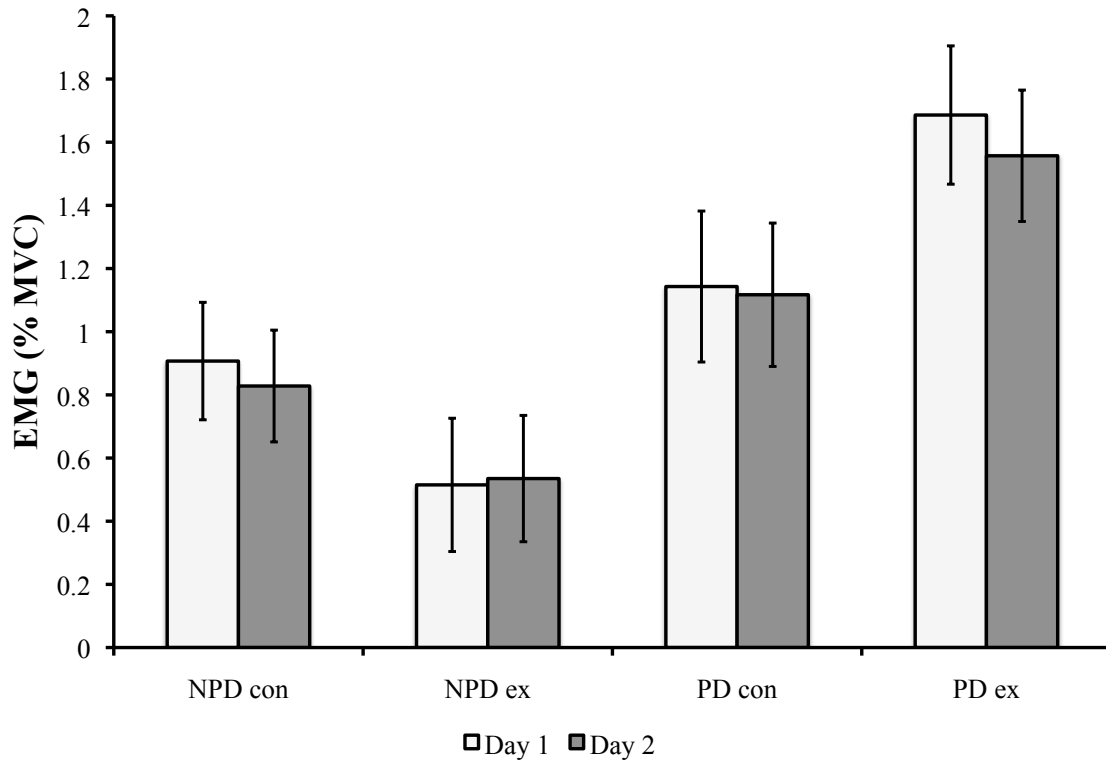
There were no interactions between day and intervention for the RLES. There was a main effect of collection day ( $F_{1,32} = 19.357, p < 0.001$ ), with participants having a small but significant decrease in average activation level of the RLES over the 2-hour standing period between collection days. The magnitude of the decrease in muscle activation for the RLES was very small, from  $1.96 \pm 0.17$  to  $1.82 \pm 0.16$  % MVC.



**Figure 7.23** There was a significant ( $p < 0.001$ ) change in average activation of the right lumbar erector spinae muscle between collection days.

There were no significant interactions including collection day and intervention for average activation level of the right gluteus medius muscle. Group differences that were present on the first collection day persisted ( $F_{1,30} = 13.158, p = 0.001$ ), with the PD group having higher average muscle activation levels ( $1.44 \pm 0.18$  % MVC) of this muscle during standing than the NPD group ( $0.59 \pm 0.16$  % MVC).

There was a significant 3-way interaction ( $F_{1,32} = 5.053, p < 0.05$ ) between PD/NPD group, intervention and collection day for the left gluteus medius muscle, with NPD<sub>EX</sub> having a slight increase in average LGMd activation level following 4-weeks of exercise intervention, and NPD<sub>CON</sub>, PD<sub>CON</sub>, and PD<sub>EX</sub> all having slight decreases.



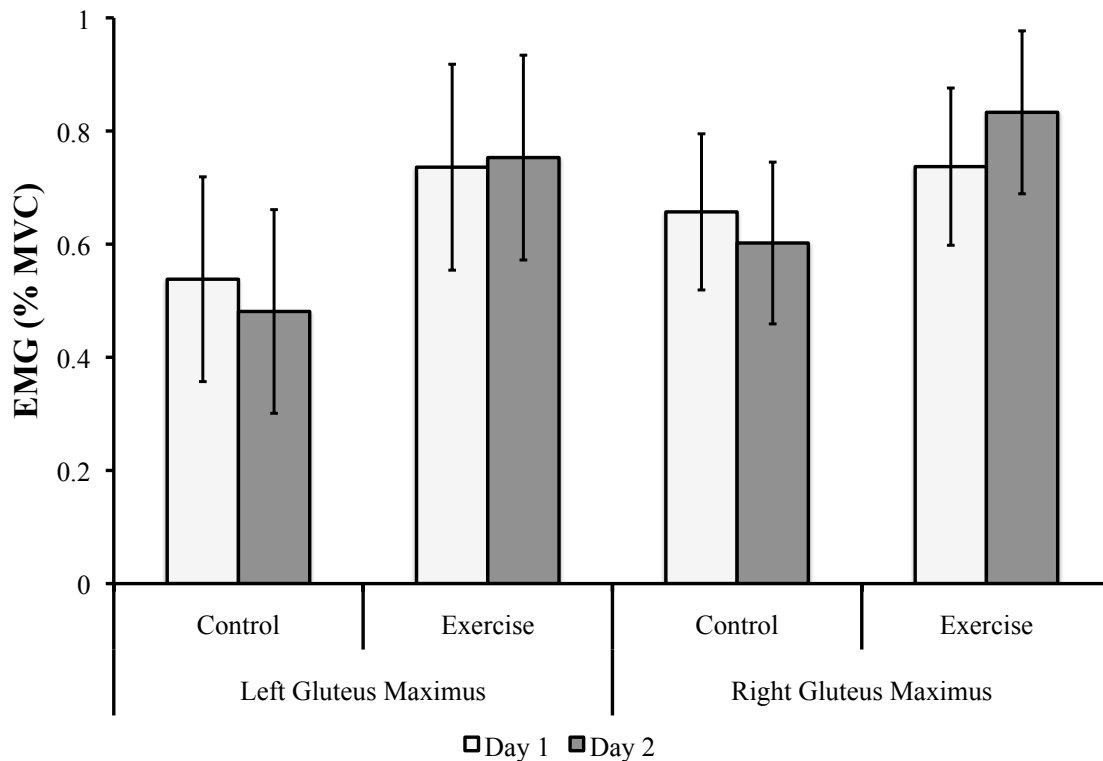
**Figure 7.24 NPD and PD groups responded differently ( $p < 0.05$ ) to exercise intervention in average left gluteus medius muscle activation levels during standing. PD<sub>EX</sub> had a small decrease in average LGMd activity, while NPD<sub>EX</sub> had a very small increase.**

Again, as can be seen in Table 7.10, the magnitudes of these changes are extremely small, and, while statistically significant, are unlikely to hold any biological significance.

**Table 7.10 Between-day differences in left gluteus medius average activation levels by PD/NPD group and assigned intervention**

	<b>Intervention</b>	<b>Day 1 % MVC</b> Mean (SEM)	<b>Day 2 % MVC</b> Mean (SEM)	<b>% Change</b>
<b>NPD</b>	Control	0.907 (0.186)	0.828 (0.177)	- 8.71
	Exercise	0.515 (0.211)	0.535 (0.200)	+ 3.88
<b>PD</b>	Control	1.143 (0.239)	1.117 (0.227)	- 2.27
	Exercise	1.686 (0.219)	1.557 (0.208)	- 7.65

Both right and left gluteus maximus muscles had significant intervention by collection day interactions ( $F_{1,32} = 5.116$ ,  $F_{1,32} = 7.001$  respectively, both  $p < 0.05$ ) (Figure 7.25).



**Figure 7.25 Between day differences for average activation of gluteus maximus muscles differed between intervention groups ( $p < 0.05$ ).**

As with all of the average muscle activation % data, the magnitudes of these changes are extremely small, and it is questionable as to whether any biological relevance can be attributed to them (Table 7.11).



**Table 7.11 Between-day differences in average gluteus maximus muscle activation in response to 4-week control or exercise period**

	<b>Intervention</b>	<b>Day 1 % MVC</b> Mean (SEM)	<b>Day 2 % MVC</b> Mean (SEM)	<b>% Change</b>
Left Gluteus Maximus	Control	0.538 (0.181)	0.481 (0.180)	-10.59
	Exercise	0.736 (0.182)	0.753 (0.181)	+ 2.31
Right Gluteus Maximus	Control	0.657 (0.138)	0.602 (0.138)	- 8.37
	Exercise	0.737 (0.139)	0.833 (0.144)	+ 13.03

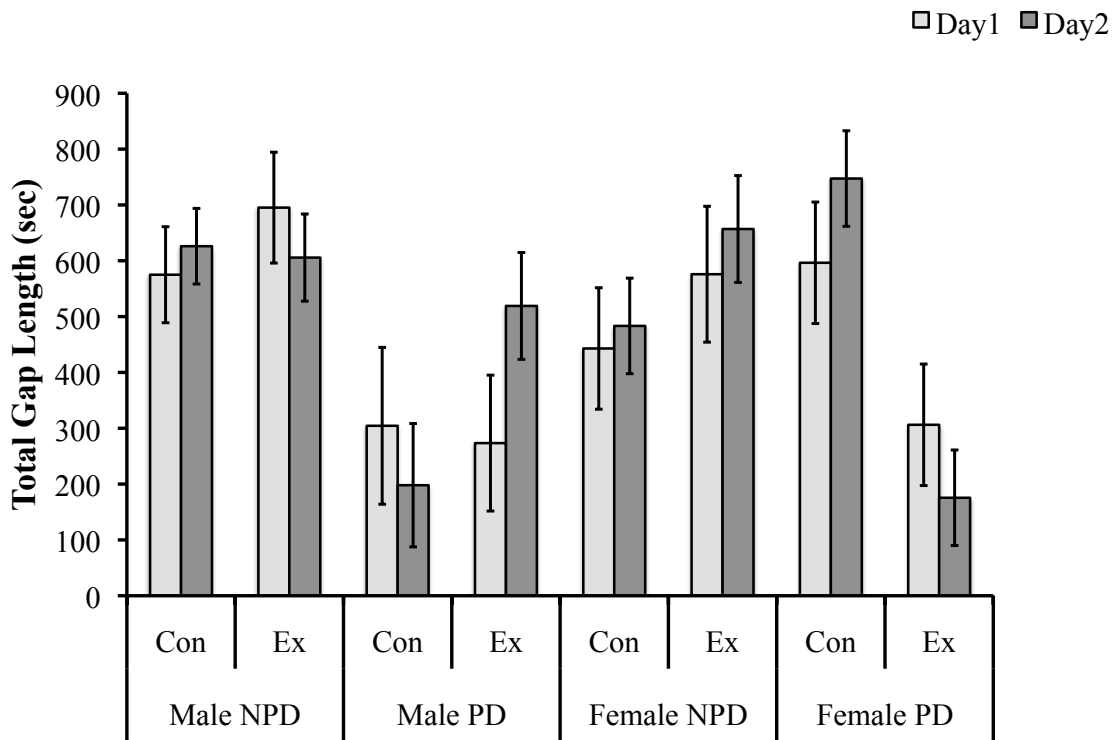
**7.12.2. Gaps in Muscle Activation During Standing**

As was done in Study 1, a Gaps analysis was conducted on the EMG data for the prolonged standing exposure on Day 2 as a method of investigating how much time each muscle was at ‘rest’ during the standing protocol. As the significant PD/NPD group differences that were detected on Day 1 were for the total Gap length, the summation of the total Gap time for the muscle over each 15-minute window, the analyses for Study 3 were limited to the muscles that were found to be different on this measure in Study 1. These data were entered into 4-way general linear models as previously described, with the interactions of interest being any that included both collection day and intervention. There were no significant day by intervention interactions on total Gap length for left or right gluteus maximus, left internal oblique, right external oblique or left gluteus medius. Significant group differences that were observed on collection day 1 persisted on collection day 2, with the PD groups having shorter total Gap length over the 2-hours of standing for bilateral gluteus maximus, gluteus medius, and right external oblique muscles (Table 7.12).

**Table 7.12 PD/NPD group differences in total Gap length were present on both Days 1 and 2**

<b>Muscle Group</b>	<b>NPD Day 1 Gap Length (s) Mean (SEM)</b>	<b>NPD Day 2 Gap Length (s) Mean (SEM)</b>	<b>PD Day 1 Gap Length (s) Mean (SEM)</b>	<b>PD Day2 Gap Length (s) Mean (SEM)</b>
<b>L Glut Max</b>	721.3 (49.1)	736.9 (46.3)	519.5 (56.5)	532.9 (53.4)
<b>R Glut Max</b>	683.0 (49.8)	691.0 (47.4)	449.9 (57.3)	457.8 (54.6)
<b>L Glut Med</b>	575.2 (41.5)	589.1 (39.7)	352.5 (47.8)	376.4 (45.7)
<b>R Glut Med</b>	574.2 (37.6)	591.1 (34.8)	388.7 (43.3)	391.4 (40.1)
<b>R Ext Oblique</b>	477.3 (46.9)	487.5 (47.7)	305.0 (54.0)	312.4 (54.9)

There was a significant 4-way interaction ( $F_{1,32} = 4.792, p < 0.05, \text{Cohen's } d = 0.83$ ) between PD/NPD group, gender, intervention and collection day for total Gap length on the right gluteus medius. As is shown in Figure 7.26, male PD<sub>EX</sub> had an overall increase in gap length of the right gluteus medius muscle following exercise intervention, while there were no significant between day changes for the other groups.



**Figure 7.26 Male PD<sub>EX</sub> demonstrated longer rest periods for the right gluteus medius muscle during prolonged standing following exercise intervention ( $p < 0.05$ ).**

### 7.13. Discussion and Conclusions

The primary aim of this study was to determine whether individuals who had previously been shown to develop LBP during prolonged standing would be positively impacted by completing a 4-week trial of an exercise program focused on trunk and hip control. The exercise intervention chosen was based upon ‘core stabilization’ exercises commonly prescribed in the physiotherapy treatment of patients with LBP. This intervention was selected based upon the idea that individuals who develop LBP during a relatively static task, involving maintenance of prolonged postures, might have similar characteristics to individuals that fall within the ‘stabilization’ sub-classification group within the Treatment Based Classification (TBC) sub-classification algorithm.

The hypothesis that those in the PD<sub>EX</sub> group would demonstrate improvement in their VAS scores during the second standing exposure compared with those in the PD<sub>CON</sub> group (Hypothesis 3.1) was supported. There was a significant decrease in VAS scores for those who participated in the exercise intervention, and while the PD<sub>CON</sub> group also showed an average decrease in VAS on the second collection day, these participants were still over the threshold for PD/NPD classification. Because the control groups did not receive any individual interaction with the investigator during the 4-week period, it is possible that some of the benefits observed in the PD<sub>EX</sub> group were simply due to the attention and encouragement (Hawthorne Effect).

It was expected that any positive clinical findings from the initial assessment would improve in response to the exercise intervention. The only adverse clinical finding that was observed on Day 1 was in the Active Hip Abduction test. While there was a non-significant trend for the PD<sub>EX</sub> group to have improvements on this test following exercise intervention, it cannot be definitely stated that this was the case. This assessment tool requires additional testing with larger and more diverse samples to determine whether it has utility in this application. The hypothesis that the PD<sub>EX</sub> group would no longer demonstrate positive findings on clinical assessment, and PD<sub>CON</sub> would have no change, is partially supported.

Co-contraction of the bilateral gluteus medius muscles and trunk flexor/extensor muscles in people predisposed to LBP development during standing has been a consistent finding. It was therefore expected that if PD were going to benefit from exercise intervention by having decreased LBP, they would also have decreased co-contraction of these muscle groups (Hypothesis 3.3). There were mixed results in this outcome measure, with

differences in response based on gender, and also different responses between the two muscle groups. In partial support of the hypothesis male PD<sub>EX</sub> did have a general decrease in co-contraction of the gluteus medius muscles, however female PD<sub>EX</sub> did not demonstrate similar responses. In previous work investigating the benefit of an ergonomic intervention (standing on a sloped surface) on LBP development (Nelson-Wong and Callaghan 2009 - submitted in review), a decrease in gluteus medius co-contraction was observed in PD, however this was seen equally across genders. In opposition to the hypothesis, a different response was observed for trunk flexor/extensor co-contraction. PD<sub>EX</sub> had an initial decrease in trunk CCI, followed by increased co-contraction, where on the first day they initially had elevated CCI of the trunk, followed by a decrease as standing duration progressed. PD<sub>CON</sub>, NPD<sub>EX</sub> and NPD<sub>CON</sub> all had decreased trunk CCI on the second day, and there were no significant differences between genders. It is possible, as suggested in Study 1, that co-contraction of the trunk flexor/extensor musculature is beneficial for preventing LBP development during a static, prolonged posture, and the increase seen in the PD<sub>EX</sub> group may be a reflection of a positive response to the intervention. The PD<sub>EX</sub> individuals may have been attempting to 'brace' the trunk musculature during standing since this bracing maneuver was emphasized during the exercise intervention. The NPD<sub>EX</sub> group did not demonstrate this same pattern, however they may have responded differently during the standing protocol since they did not have a pain experience on the first collection day and therefore may have not attempted to utilize abdominal bracing. The PD<sub>CON</sub> group followed a similar modulation of trunk CCI as was seen in Study 1, with a marked decrease in trunk CCI during the middle stages of standing (from 30-60 minutes).

The final hypothesis for this study was that there would be a ‘normalization’ of any of the other motor control/biomechanical factors that were observed to be different in the PD group following exercise intervention, with no changes in the control groups (Hypothesis 3.4). Differences were found in Study 1 in the total Gap length for the gluteal muscles, with the PD group spending less time at rest in these muscle groups. There were no significant between day changes in the left gluteal muscles or the right gluteus maximus. There were, however significant changes in the right gluteus medius. Males in the PD<sub>EX</sub> group demonstrated longer total Gap lengths for the right gluteus medius during the standing exposure, indicating they were increasing the amount of time the muscle was spending in the resting state following the exercise intervention. This is consistent with the finding of decreased CCI in the Male PD<sub>EX</sub> group. It is likely that the decrease in gluteus medius CCI for these individuals was driven by decreased activation periods for the right gluteus medius.

While the exact mechanisms of LBP development during standing remain elusive, it is clear from this study that exercise intervention directed at the trunk and hip does have some effect on the muscle activation patterns of those muscle groups during the prolonged standing task. Although there was a significant decrease in subjective VAS scores in the exercise group on the second standing exposure, it is difficult to say unequivocally that this was entirely due to the exercise intervention. The accompanying changes in muscle activation patterns during the second standing exposure do indicate that there may be promise for this type of intervention in addressing LBP development during standing. Although both genders had equivalent decreases in pain response, they showed distinct differences in their muscle activation responses, particularly at the hip.

This may be due to anthropometric differences in the pelvis between genders, leading to necessary differences in gluteus medius muscle activation and control.

Findings from Study 1 indicate that low-level muscle fatigue may be one of the mechanisms underlying the LBP development observed in this protocol. The finding that PD<sub>EX</sub> had increased rest time for the right gluteus medius in the initial stages of standing, combined with decreased VAS scores, provide some support for this theory. It could be that gluteus medius co-contraction is a maladaptive response for an inability to provide adequate postural control at the trunk, and is therefore a predisposing factor for LBP development during this task. Co-contraction of the trunk musculature, on the other hand, may be an appropriate adaptation and may serve as protection against LBP development during sustained postural demands.

It is encouraging to find that a commonly prescribed exercise intervention does have some impact on the motor control and muscle activation profile observed in these individuals. The goal of any clinically prescribed program is to effect a change in the system, and if it can be directed toward the appropriate mechanisms that are driving the impairment that would be ideal. These study results show that there may be some benefit to an exercise program directed at the trunk and hip, and while the specific underlying mechanisms have yet to be completely characterized and determined, it provides a foundation for future work to build upon.

## **8. STUDY 4: REPEATABILITY OF MOTOR CONTROL PATTERNS DURING FUNCTIONAL MOVEMENTS AND PROLONGED STANDING IN PEOPLE WITH AND WITHOUT STANDING-INDUCED LOW BACK PAIN**

### **8.1. Purpose and Hypotheses**

The primary and secondary purposes of this thesis were to determine predisposing factors for LBP development during standing, and to assess the impact of an exercise based intervention on these factors. It was unknown how stable these factors might be over time in the absence of an exercise intervention. Therefore, the purpose of Study 4 was to assess the between-day repeatability of the previously identified factors within the control groups. To accomplish this, factors that were identified as being associated with LBP development in Study 1 were re-assessed in participants from PD and NPD groups who were assigned to the control groups on Day 2.

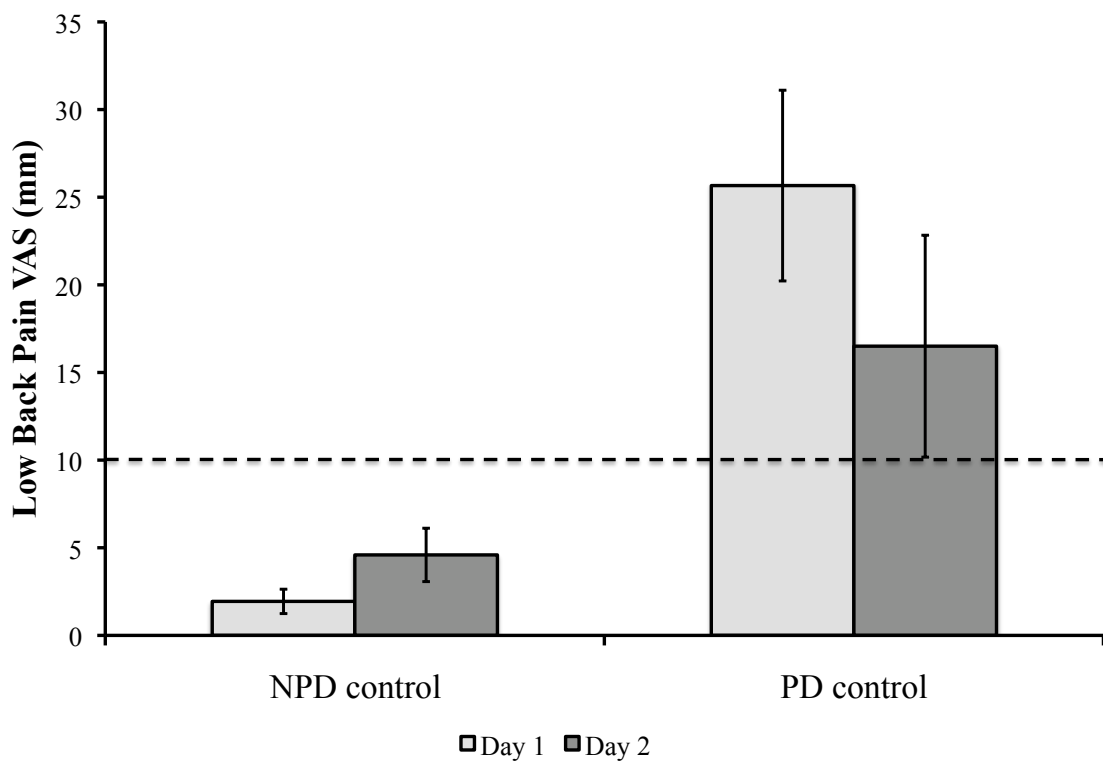
There were two primary hypotheses for this study. First, it was expected that individuals not receiving exercise intervention would remain in their respective pain development groups during the second standing exposure. Second, it was hypothesized that individuals not receiving exercise intervention would demonstrate good repeatability of clinical, motor control and biomechanical factors between the two data collections, as demonstrated by intraclass correlation coefficients (ICC) of  $\geq 0.80$ .

### **8.2. Pain Development**

Of the participants who were classified as PD on day 1, 8 were assigned to the control group for the 4-week period in between testing days. Of these 8, 6 (75%) would have been classified as PD on their second testing day, and 2 (25%) would have been classified as NPD based on the criteria of  $\geq 10$  mm change from baseline in VAS for the low back.



There were 15 participants that were NPD on Day 1 and assigned to the control group. Of these, 2 of the 15 (13.3 %) would have been classified as PD on Day 2, and 13 (86.7 %) remained in the NPD group on the second testing day. As previously reported in Study 3, there were no significant differences between Day 1 and Day 2 VAS scores for the PD<sub>CON</sub> and NPD<sub>CON</sub> groups ( $p > 0.05$ ). Between days VAS scores are shown for the control groups in Figure 8.1.



**Figure 8.1** There were no between day differences for either control group in VAS score for the low back during standing. The gray dashed line indicates the VAS cutoff threshold for the PD group classification.

Of the previously NPD individuals who switched to PD on Day 2, one was female and one was male. Neither one reported any event that might have caused them to experience

pain on the second testing day. The female participant barely exceeded the threshold criteria on Day 2 with a maximum VAS score of 11 mm. The male participant was well above the threshold criteria with a maximum VAS score of 20 mm.

For the two PD participants who changed over to the NPD group on Day 2, one was female and one was male. The female participant reported a VAS score of 0 mm on Day 2 testing and the male participant reported a VAS score of 2 mm on Day 2. The individual between day VAS scores for the control group participants are shown in Table 8.1, with the participants who changed groups in bold.

**Table 8.1 VAS scores for control group participants on Days 1 and 2. Participants who changed groups are in bold.**

<b>Participant ID</b>	<b>Day 1 VAS (mm)</b>	<b>Group Day 1</b>	<b>Day 2 VAS (mm)</b>	<b>Group Day 2</b>	<b>Change (mm)</b>
<b>F02</b>	<b>5</b>	<b>NPD</b>	<b>11</b>	<b>PD</b>	<b>+6</b>
F05	0	NPD	0	NPD	0
F09	0	NPD	0	NPD	0
F10	0	NPD	0	NPD	0
F14	6.5	NPD	0	NPD	-6.5
F18	6	NPD	3	NPD	-3
M02	0	NPD	6.5	NPD	+6.5
M05	4.4	NPD	0	NPD	-4.5
M06	0	NPD	0	NPD	0
M11	0	NPD	0	NPD	0
M14	0	NPD	0	NPD	0
<b>M16</b>	<b>6</b>	<b>NPD</b>	<b>20</b>	<b>PD</b>	<b>+ 14</b>
M18	0	NPD	0	NPD	0
M19	1.5	NPD	0	NPD	-1.5
F11	25	PD	24	PD	-1
F12	32	PD	10	PD	-22
<b>F16</b>	<b>14</b>	<b>PD</b>	<b>0</b>	<b>NPD</b>	<b>-14</b>
F19	16	PD	12	PD	-4
F21	13	PD	20	PD	+7
<b>M08</b>	<b>12.5</b>	<b>PD</b>	<b>2</b>	<b>NPD</b>	<b>-10.5</b>
M09	37	PD	10	PD	-27
M22	56	PD	56	PD	0

It was expected that participants would remain within their original PD/NPD group with repeated testing in the absence of an intervention being applied. This was true for the majority of the participants. Neither of the two NPD participants who changed over to the PD groups on Day 2 reported zero VAS scores on Day 1. It is possible that if the standing exposure had been longer than 2-hours, these two individuals might have been classified as PD on the first collection day. The two PD participants who changed over to the NPD group on Day 2 both had VAS scores that were just over the threshold criteria for classification into the PD group on Day 1. Although there were other participants with scores in those ranges that did not change groups on Day 2, it may be that individuals who are close to that threshold criteria, which was set somewhat arbitrarily based on reports in the literature for other pain conditions, are more fluid in their day-to-day patterns. The rest of the control-assigned participants remained in their Day 1 groups and appear to be more consistent in their predisposition for experiencing, or not experiencing, pain when exposed to prolonged standing.

### **8.3. Clinical Assessment Findings**

As was previously reported in Study 3, there were no significant changes on the majority of the clinical assessment measures between days, regardless of intervention group.

Clinical assessment findings for the control groups only were first entered separately into 3-way general linear models with between factors of PD/NPD group and gender and within factor of collection day. The significant findings are reported here.

For lumbar extension range of motion (ROM), there was a significant interaction between gender and collection day ( $F_{1,18} = 6.162, p < 0.05$ ), with males demonstrating a slight

decrease in ROM on Day 2 (from  $49.2 \pm 12.9^\circ$  to  $44.9 \pm 9.9^\circ$ ) and females having a slight increase (from  $49.4 \pm 14.0^\circ$  to  $52.4 \pm 13.5^\circ$ ) between days.

There were significant gender differences on hip flexion ( $F_{1,18} = 7.569, p < 0.05$ ) and extension ROM ( $F_{1,18} = 7.11, p < 0.05$ ) with males having less available ROM in both directions than females, but no significant between day differences.

As expected, there were PD/NPD group differences in the Active Hip Abduction (AHAbd) test. For the self-rated AHAbd test, there was a significant interaction between PD/NPD group and collection day ( $F_{1,18} = 7.152, p < 0.05$ ). The NPD group had no between-day changes, while the PD group reported having less difficulty with the test on the second day. There was a significant 3-way interaction between PD/NPD group, gender and collection day for the examiner rated AHAbd test ( $F_{1,18} = 14.821, p = 0.001$ ). These data are displayed in Table 8.2.

**Table 8.2 Between-day examiner rated AHAbd test scores by PD/NPD group and gender.**

<b>Group Classification</b>	<b>Gender</b>	<b>Day 1</b> Mean (SEM)	<b>Day 2</b> Mean (SEM)
<b>NPD</b>	Male	0.625 (0.224)	0.50 (0.204)
	Female	0.50 (0.259)	0.667 (0.236)
<b>PD</b>	Male	0.667 (0.366)	1.333 (0.333)
	Female	1.60 (0.284)	1.0 (0.258)

As before, there was a main effect of gender ( $F_{1,18} = 6.587, p < 0.05$ ) on time to failure in the extensor endurance test, with females being able to hold the position for a longer time than males on both collection days.

To determine the between day repeatability of these measures, intraclass correlation coefficients (ICC) were computed using a 2-way mixed model for a single examiner. Where significant gender or PD/NPD group differences were detected previously in the general linear models, the ICC was calculated for each gender and/or PD/NPD group separately as appropriate. As shown in Table 8.3, most of the measures had very good between day repeatability with ICC values  $\geq 0.80$  (Portney and Watkins 2000).

**Table 8.3 Between-day repeatability for clinical assessment tools. Measures that had poor between day repeatability are indicated in *bold italic*.**

Assessment Tool		ICC value	
Lumbar Flexion		0.943	
Lumbar Extension	Male	0.926	
	Female	0.919	
Lumbar Lateral Flexion		0.797	
Hip Flexion	<i>Male</i>	<i>0.611</i>	
	Female	0.695	
Hip Extension	<i>Male</i>	<i>0.479</i>	
	<i>Female</i>	<i>0.502</i>	
Hip Internal Rotation		0.905	
Hip External Rotation		0.737	
Straight Leg Raise		0.869	
Active Straight Leg Raise (ASLR)		0.790	
Self Rated AHAbd	NPD	0.874	
	PD	0.849	
Examiner Rated AHAbd	<i>Male</i>	NPD	0.920
		<i>PD</i>	<i>0.667</i>
	<i>Female</i>	NPD	0.828
		<i>PD</i>	<i>0.769</i>
Extensor Endurance Time	Male	0.876	
	Female	0.685	
Side Support Time		0.908	
4-week Activity Level (MPAQ)		0.901	

Between-day measures of hip extension were poor for both genders. Hip flexion measurements had fair between-day repeatability for males. The examiner-rated AHAbd had fair between day repeatability for female PD, but was poor for male PD, while it was

very good for NPD of both genders. Because only a single rater performed these assessment measures, it is uncertain whether the between-day differences are due to between day changes within the individuals themselves, or are due to intra-rater reliability issues. For the between day differences in males for hip flexion, it is probable that there were actual changes within individuals given that standard goniometric techniques were used for all range of motion measures and there were no differences detected in the females. It is unlikely that the examiner would have introduced a systematic error in this measurement in a single group. Intra-rater ICC values for hip goniometric measurements have been reported in the literature previously. Holm and colleagues (2000) found intra-rater ICC values to range from 0.80 to 0.94 for hip flexion, extension, internal and external rotation. Other researchers have reported lower intra-rater reliability scores for hip extension (ICC = 0.56) and external rotation (0.58) (Klassabo, Harms-Ringdahl et al. 2003). Given this wide range of reported intra-rater ICC values for hip extension, it is likely that the between day differences observed in this study are a function of examiner error rather than variability in the sample.

Participants were highly repeatable in their self-assessment of AHAbd Test difficulty, however the examiner rated score had poor repeatability for PD groups. Again, whether this was due to actual differences in the individuals' test performance or was a reflection of poor intra-rater reliability is difficult to say. The examiner was no longer blinded to the participant's PD/NPD group on the second day, and may have therefore had some expectation of what the test result should be, therefore introducing some bias. However, the fact that the male PD group had higher average scores on Day 2 (indicating poorer test performance) and the female PD group had lower Day 2 scores (indicating better test

performance) tends to refute this. As this is a new test in the very initial stages of development, there needs to be both systematic inter- and intra-rater reliability studies conducted on it beyond this single examiner small sample size initial study.

#### **8.4. Extensor Endurance Test**

As already presented in section 8.3, time to failure on the extensor endurance test was very similar between testing days for the control group participants. Peak and average EMG data as well as  $MPF_{\text{slope}}$  and  $rms_{\text{slope}}$  data for the control group were also entered into 3-way general linear models as described previously. As was found previously, there was a main effect of gender ( $F_{1,18} = 9.594, p < 0.01$ ) on the  $MPF_{\text{slope}}$  for the lumbar erector spinae (LES) muscles, with males having steeper negative slopes, indicating greater fatigability than the females.

For the thoracic erector spinae (TES) muscles, there was a significant PD/NPD group by collection day interaction ( $F_{1,18} = 6.318, p < 0.05$ ) on the  $rms_{\text{slope}}$ . On this measure, the NPD group had lower positive slopes on Day 2, indicating lower fatigability, and the PD group had higher positive slopes on Day 2, indicating greater fatigability of the TES.

There was a significant gender by collection day interaction ( $F_{1,17} = 2.062, p < 0.05$ ) for the  $rms_{\text{slope}}$  of the gluteus maximus muscles. Males showed lower fatigability of this muscle group on Day 2 (lower slope), while females were unchanged between days.

ICC values were then calculated to determine the between day repeatability of these measures as described previously. Where there were gender and/or group differences detected in the general linear models, the data were split and ICCs were calculated for

each group respectively. Table 8.4 shows the between day ICC values for the extensor muscle fatigability measures.

**Table 8.4 Intraclass correlation coefficients for muscle fatigability during extensor endurance test between days. Measures that have poor between day repeatability are indicated by *bold italic*.**

<b>Muscle Group</b>	<b>Measure</b>		<b>ICC</b>
<b>Thoracic Erector Spinae</b>	MPF <sub>slope</sub>		0.760
	<i>rms<sub>slope</sub></i>	<i>NPD</i>	<b><i>0.604</i></b>
		<i>PD</i>	<b><i>0.694</i></b>
<b>Lumbar Erector Spinae</b>	MPF <sub>slope</sub>	Male	0.935
		Female	0.930
	<i>rms<sub>slope</sub></i>		0.905
	<b><i>MPF<sub>slope</sub></i></b>		<b><i>0.024</i></b>
<b>Gluteus Maximus</b>	<i>rms<sub>slope</sub></i>	<i>Male</i>	<b><i>0.605</i></b>
		<i>Female</i>	<b><i>0.378</i></b>

The LES muscles had excellent repeatability on both the MPF<sub>slope</sub> and *rms<sub>slope</sub>* measures with ICC values exceeding 0.90. Repeatability of gluteus maximus data for these fatigability measures was uniformly poor, especially for the MPF<sub>slope</sub>, with an ICC of only 0.024. Because the MPF<sub>slope</sub> ICC values were excellent for both the TES and LES, and identical methodology was utilized, it can be assumed that there were real between-day differences in this measure for the gluteus maximus muscles, and that these were independent of PD/NPD group or gender.

Peak and average muscle activation levels were first entered into 4-way general linear models with between factors of PD/NPD group and gender and within factors of collection day and muscle group (3) for the control group only. There were no significant differences detected. Each individual muscle group was then entered into 3-way general linear models as previously described. There were no significant between day differences for average or peak EMG during the extensor endurance test. ICC values were calculated



for peak and average EMG, with the data being split by gender and/or group where there were significant differences in these factors detected on the general linear models. As shown in Table 8.5, between days repeatability was generally poor to fair for the peak and average EMG activation levels, particularly for the gluteus maximus muscles, with ICC values of 0.499 and 0.311 for the peak and average EMG respectively.

**Table 8.5 Between-day repeatability for peak and average EMG during the extensor endurance test. Measures with poor repeatability are indicated with *bold italic*.**

<b>Muscle Group</b>	<b>EMG Measure</b>		<b>ICC</b>
<i>Thoracic Erector Spinae</i>	<i>Peak</i>		<b><i>0.447</i></b>
	<i>Average</i>	Male	0.667
		<i>Female</i>	<b><i>0.473</i></b>
<i>Lumbar Erector Spinae</i>	Peak		0.863
	<i>Average</i>	<i>Male</i>	<b><i>0.339</i></b>
		Female	0.891
<i>Gluteus Maximus</i>	<i>Peak</i>		<b><i>0.499</i></b>
	<i>Average</i>		<b><i>0.311</i></b>

### **8.5. Flexion Relaxation Ratio**

Day 1 and Day 2 flexion relaxation ratios during the pre-standing exposure forward bending trials were entered into 3-way general linear models as described previously for the control groups. There were no significant between day differences detected. ICC values were then calculated and are reported in Table 8.6. Repeatability was good for the lumbar erector spinae (LES), however it was very poor for both thoracic erector spinae and gluteal muscles.

**Table 8.6 Between-day repeatability for flexion relaxation ratio. Measures with poor repeatability are indicated with *bold italic*.**

<b>Muscle Group</b>	<b>ICC</b>
<i>Thoracic Erector Spinae</i>	<i>0.421</i>
Lumbar Erector Spinae	0.725
<i>Gluteus Maximus</i>	<i>0.219</i>

Although increased FRR of the gluteal muscles was determined to be a discriminating factor between PD/NPD groups in Study 1, these findings suggest that this may not be a reliable or stable measure for repeated testing sessions.

### **8.6. Single Leg Stance**

There were two main measures during single leg stance (SLS) that were found to be of importance in discriminating between PD/NPD groups. These were co-contraction index (CCI) for the right lumbar erector spinae-left internal oblique muscle pair during right SLS (RSLS), and muscle activation of the gluteus medius muscle ipsilateral to the stance limb. As before, Day 1 and Day 2 data for the control groups were entered into 3-way general linear models with between factors of gender and PD/NPD group and within factor of collection day. Between-day ICC values were also calculated for each measure.

There were no significant differences between days detected in the general linear model for CCI of the RLES-LIO pair. Between-day repeatability for this measure was excellent, with an ICC = 0.933,  $p < 0.001$ .

For average left gluteus muscle activation during left SLS, there was a significant PD/NPD group by collection day interaction ( $F_{1,19} = 6.269$ ,  $p < 0.05$ ), with the NPD<sub>CON</sub> group increasing their average muscle activation on Day 2 (from  $4.55 \pm 0.97$  % MVC to

7.6 ± 1.0 % MVC) and the PD<sub>CON</sub> group decreasing their average muscle activation between days (from 7.3 ± 1.4 % MVC to 4.8 ± 1.4 % MVC). Between day ICC values for left gluteus medius muscle activation were very poor (ICC = 0.047,  $p = 0.456$ ) indicating the control groups used very different muscle activation strategies during LSLS on the 2 collection days. In contrast to LSLS, there were no significant differences detected in average right gluteus medius muscle activation during RSLS with the general linear model, and between-day repeatability was moderate (ICC = 0.519,  $p = 0.047$ ).

### **8.7. Vertebral Joint Rotation Stiffness During Squatting**

There were significant PD/NPD group differences detected in Study 1 in the relative contribution of the external oblique (EO) muscles to vertebral joint rotation stiffness (VJRS) during both the ‘up’ and ‘down’ phase of squatting. Therefore, these data were entered into 3-way general linear models with between factors of PD/NPD group, and within factors of collection day and vertebral level (5) for each rotation axis. As noted previously, gender was not included as a factor due to insufficient data for each subgroup. ICC values were then calculated for each vertebral level and rotation axis combination.

For the ‘up’ phase of the squat, there were no significant between day differences detected in the general linear model peak or average EO contribution for any of the rotation axes. The ICC values for each vertebral level and rotation axis combination for average EO contribution to stiffness are presented in Table 8.7, and ICC values for peak EO contribution are presented in Table 8.8. Average EO contribution to stiffness about the lateral bend ( $x$ ) axis was dissimilar between days (all  $p > 0.05$ ). EO contribution to stiffness was very similar between days about the axial twist ( $y$ ) and flexion/extension ( $z$ )

axes, with the exception L<sub>4</sub>L<sub>5</sub> flexion/extension. Similarly, repeatability for peak EO contribution to stiffness during the ‘up’ phase of squatting was excellent, with the exception of contribution about the lateral bend axis at L<sub>1</sub>L<sub>2</sub> and L<sub>2</sub>L<sub>3</sub> and about the flexion/extension axis at L<sub>4</sub>L<sub>5</sub>.

**Table 8.7 Between-day repeatability for average external oblique contribution to vertebral joint rotation stiffness during the ‘up’ phase of the squat. Measures that were different between days are indicated with *bold italic*.**

Vertebral Level	Rotation Axis	ICC
L <sub>1</sub> L <sub>2</sub>	<i>Lateral Bend (x)</i>	<i>0.320</i>
	<i>Axial Twist (y)</i>	<i>0.517</i>
	Flexion/Extension (z)	0.647
L <sub>2</sub> L <sub>3</sub>	<i>Lateral Bend (x)</i>	<i>0.335</i>
	Axial Twist (y)	0.552
	Flexion/Extension (z)	0.668
L <sub>3</sub> L <sub>4</sub>	<i>Lateral Bend (x)</i>	<i>0.371</i>
	Axial Twist (y)	0.578
	Flexion/Extension (z)	0.734
L <sub>4</sub> L <sub>5</sub>	<i>Lateral Bend (x)</i>	<i>0.424</i>
	Axial Twist (y)	0.588
	<i>Flexion/Extension (z)</i>	<i>0.527</i>
L <sub>5</sub> S <sub>1</sub>	<i>Lateral Bend (x)</i>	<i>0.465</i>
	Axial Twist (y)	0.605
	Flexion/Extension (z)	0.654

**Table 8.8 Between-day repeatability for peak external oblique contribution to vertebral joint rotation stiffness during the ‘up’ phase of the squat. Measures that were different between days are indicated with *bold italic*.**

Vertebral Level	Rotation Axis	ICC
L <sub>1</sub> L <sub>2</sub>	<i>Lateral Bend (x)</i>	<i>0.519</i>
	Axial Twist (y)	0.606
	Flexion/Extension (z)	0.679
L <sub>2</sub> L <sub>3</sub>	<i>Lateral Bend (x)</i>	<i>0.510</i>
	Axial Twist (y)	0.650
	Flexion/Extension (z)	0.748
L <sub>3</sub> L <sub>4</sub>	Lateral Bend (x)	0.539
	Axial Twist (y)	0.683
	Flexion/Extension (z)	0.728
L <sub>4</sub> L <sub>5</sub>	Lateral Bend (x)	0.589
	Axial Twist (y)	0.703
	<i>Flexion/Extension (z)</i>	<i>0.114</i>
L <sub>5</sub> S <sub>1</sub>	Lateral Bend (x)	0.624
	Axial Twist (y)	0.722
	Flexion/Extension (z)	0.765

There were no significant between day differences detected in the general linear models for either average or peak contribution of EO to VJRS during the ‘down’ phase of the squat. ICC values, however, were uniformly poor, as can be seen in Table 8.9 and Table 8.10, indicating that there was poor reliability in this measure between days for the ‘down’ phase of squatting.

**Table 8.9 Between-day repeatability for average external oblique contribution to vertebral joint rotation stiffness during the ‘down’ phase of the squat. Note that all measures were different between days.**

<b>Vertebral Level</b>	<b>Rotation Axis</b>	<b>ICC</b>
<b>L<sub>1</sub>L<sub>2</sub></b>	Lateral Bend ( <i>x</i> )	0.373
	Axial Twist ( <i>y</i> )	0.259
	Flexion/Extension ( <i>z</i> )	0.260
<b>L<sub>2</sub>L<sub>3</sub></b>	Lateral Bend ( <i>x</i> )	0.378
	Axial Twist ( <i>y</i> )	0.248
	Flexion/Extension ( <i>z</i> )	0.182
<b>L<sub>3</sub>L<sub>4</sub></b>	Lateral Bend ( <i>x</i> )	0.396
	Axial Twist ( <i>y</i> )	0.232
	Flexion/Extension ( <i>z</i> )	0.196
<b>L<sub>4</sub>L<sub>5</sub></b>	Lateral Bend ( <i>x</i> )	0.420
	Axial Twist ( <i>y</i> )	0.234
	Flexion/Extension ( <i>z</i> )	0.229
<b>L<sub>5</sub>S<sub>1</sub></b>	Lateral Bend ( <i>x</i> )	0.441
	Axial Twist ( <i>y</i> )	0.232
	Flexion/Extension ( <i>z</i> )	0.223

**Table 8.10 Between-day repeatability for peak external oblique contribution to vertebral joint rotation stiffness during the ‘down’ phase of the squat. Note that all measures were different between days.**

Vertebral Level	Rotation Axis	ICC
<b>L<sub>1</sub>L<sub>2</sub></b>	Lateral Bend (x)	0.351
	Axial Twist (y)	0.218
	Flexion/Extension (z)	0.482
<b>L<sub>2</sub>L<sub>3</sub></b>	Lateral Bend (x)	0.356
	Axial Twist (y)	0.300
	Flexion/Extension (z)	0.438
<b>L<sub>3</sub>L<sub>4</sub></b>	Lateral Bend (x)	0.386
	Axial Twist (y)	0.355
	Flexion/Extension (z)	0.394
<b>L<sub>4</sub>L<sub>5</sub></b>	Lateral Bend (x)	0.446
	Axial Twist (y)	0.328
	Flexion/Extension (z)	0.238
<b>L<sub>5</sub>S<sub>1</sub></b>	Lateral Bend (x)	0.517
	Axial Twist (y)	0.424
	Flexion/Extension (z)	0.444

### **8.8. Muscle Co-Contraction During Prolonged Standing**

One of the primary findings from Study 1 was that individuals who were likely to develop LBP during standing exhibited a pattern of co-contraction of the bilateral gluteus medius muscles and trunk flexor/extensor muscles (to a lesser degree) during standing. Therefore, CCI values for these muscles were entered into 4-way general linear models with between factors of PD/NPD group and gender, and within factors of time (8 repeated measures) and collection day for the individuals assigned to the control group. ICC values were then calculated for the 8 repeated measures on each collection day, and if these were found to be statistically similar, these 8 repeated measures were averaged to yield a single CCI average value for each day. Between day ICC values were then calculated using the average CCI values for each collection day. The between day ICC

values were calculated for the entire control group sample, and also for the PD and NPD groups separately.

There were no significant between day differences detected for gluteus medius CCI in the general linear model. As shown in Table 8.11, within-day repeatability was excellent for both collection days, and between-day repeatability was also very good for gluteus medius CCI.

**Table 8.11 Within-day and between-day repeatability for gluteus medius co-contraction during standing.**

	<b>Day 1 ICC</b>	<b>Day 2 ICC</b>	<b>Between Days ICC</b>
<b>Control Group</b>	0.946	0.919	0.886
<b>NPD<sub>CON</sub></b>			0.869
<b>PD<sub>CON</sub></b>			0.899

There was a main effect of collection day ( $F_{1,17} = 4.831, p < 0.05$ ) for trunk flexor/extensor CCI, with individuals in the control group having an overall decrease in CCI between collection days,  $2184 \pm 229$  % MVC on Day 1 to  $1626 \pm 196$  % MVC on Day 2. As with the gluteus medius CCI, within day repeatability was excellent, however the between day repeatability was only moderate for the control group combined. As can be seen in Table 8.12, this was due to the poor between-day repeatability of the NPD group. When the PD/NPD groups were separated, the PD group was found to be very consistent in their between-day trunk co-contraction patterns while the NPD group was found to be very dissimilar between the collection days.



**Table 8.12 Within-day and between -day repeatability for trunk flexor/extensor co-contraction during standing. Poor repeatability is indicated in *bold italic*.**

	<b>Day 1 ICC</b>	<b>Day 2 ICC</b>	<b>Between Days ICC</b>
<b><i>Control Group</i></b>	0.891	0.939	<b><i>0.517</i></b>
<b><i>NPD<sub>CON</sub></i></b>			<b><i>0.094</i></b>
<b><i>PD<sub>CON</sub></i></b>			0.817

## **8.9. Muscle Activation Patterns During Prolonged Standing**

### ***8.9.1. Average EMG During Standing***

Average EMG values for the five muscle groups that were found to have PD/NPD group differences in Study 1 were entered into 4-way general linear models as previously described. ICC values were also calculated for within day and between repeatability as described in section 8.8. There were no significant between day differences detected in the general linear models for any of the muscles under consideration. As can be seen in, the within-day and between-day repeatability was excellent for the average muscle activation levels during standing.

**Table 8.13 Within-day and between-day repeatability for average muscle activation during standing.**

<b>Muscle Group</b>	<b>Day 1 ICC</b>	<b>Day 2 ICC</b>	<b>Between Days ICC</b>
<b>R Lumbar Erector Spinae</b>	0.858	0.860	0.712
<b>R Gluteus Medius</b>	0.971	0.994	0.868
<b>R Gluteus Maximus</b>	0.888	0.966	0.818
<b>L Gluteus Medius</b>	0.975	0.927	0.659
<b>L Gluteus Maximus</b>	0.965	0.955	0.815

### ***8.9.2. Total Gap Length During Prolonged Standing***

The primary measure on the Gaps analyses that was found to be predictive of LBP during standing in Study 1 was the total Gap length for each 15-minute window over the 2-hour

standing exposure, for the following six muscles. These values were entered into 4-way general linear models as previously described, and ICC values calculated to determine within-day and between-day repeatability.

There were no significant between days effects in total Gap length detected for the right external oblique (REO), left internal oblique (LIO), right gluteus medius (RGMed), left gluteus medius (LGMed) or left gluteus maximus (LGMax) muscles. There was a significant gender by collection day interaction ( $F_{1,17} = 5.212, p < 0.05$ ) in total Gap length for the right gluteus maximus (RGMax) muscle. Males had an average increase in total Gap length (from  $563.0 \pm 74$  to  $647.8 \pm 85$  seconds) and females had an average decrease (from  $563.0 \pm 69$  to  $470 \pm 79$  seconds) between the collection days. As can be seen in Table 8.14, the within-day and between-day repeatability was very good for the total Gap length for all of the muscle groups under consideration.

**Table 8.14 Within-day and between-day repeatability for total Gap length during standing.**

<b>Muscle Group</b>	<b>Day 1 ICC</b>	<b>Day 2 ICC</b>	<b>Between Days ICC</b>
<b>R External Oblique</b>	0.983	0.980	0.667
<b>R Gluteus Medius</b>	0.967	0.980	0.619
<b>R Gluteus Maximus</b>	0.944	0.967	0.866
<b>L Internal Oblique</b>	0.978	0.976	0.727
<b>L Gluteus Medius</b>	0.962	0.949	0.661
<b>L Gluteus Maximus</b>	0.961	0.976	0.857

## **8.10. Conclusions and Discussion**

The repeatability of the assessed outcome measures between days in the control group was, in general, very good. While not all of the participants remained in their initial

PD/NPD groups on the second day of testing, the majority (83%) of them did, supporting the first hypothesis. It seems that individuals who are predisposed to develop LBP during a standing exposure remain fairly consistent in this response. As stated earlier, the cutoff threshold of  $\geq 10$  mm change in VAS, while based on findings from the literature, was largely arbitrary and was chosen *a priori* to this data collection.

The between-day repeatability of the assessment measures was generally very good, with the exception of hip extension range of motion and the examiner-rated hip abduction test. As noted previously, it is unclear whether this is a reflection of true day-to-day variability in the participants, or due to variability within the examiner. Because the clinical assessment includes interaction with an examining individual, and in the case of the AHAbd test requires a judgment to be made by the examining individual, this variability cannot be separated. As already discussed, intra-rater ICC values for hip extension range of motion range from fair to excellent in studies that were designed to specifically address issues of intra-rater reliability (Holm, Bolstad et al. 2000; Klassabo, Harms-Ringdahl et al. 2003). The ICC values reported here fall within the previously reported ranges, so it is possible that these differences are a function of the examiner rather than changes in the participants between days. The AHAbd test is a new test, and as such has not yet had reliability studies conducted on it. This is an area for future research and will be an important step in determining the future utility of this test in discriminating between repeated measurements.

Measures of fatigability during the extensor endurance test had mixed results. Time to failure and  $MPF_{\text{slope}}$  for the thoracic and lumbar erector spinae had very good between-day reliabilities (ICC > 0.80). Reliability of fatigability measures for the gluteus maximus

was poor for both  $MPF_{slope}$  and  $rms_{slope}$ . ICC values for peak and average muscle activation during the extensor endurance test ranged from poor for the thoracic erector spinae and gluteal muscles ( $< 0.50$ ) to very good ( $> 0.80$  for peak EMG) for the lumbar erector spinae muscles. Repeatability of the flexion relaxation ratio (FRR) was similar in that it was good for the lumbar erector spinae (ICC  $> 0.70$ ), but poor for the thoracic erector spinae and gluteal muscles (ICC  $< 0.50$ ). This could be due to between-day differences in electrode placement or in quality of the MVICs that were elicited for normalization purposes. Given that other EMG measures in this study had very good repeatability between days however, these findings may reflect true day-to-day variability in these measures. It is possible that individuals vary their muscle activation patterns significantly from day-to-day when performing goal-directed tasks (bending forward, maintaining the extension position), and caution should be used in interpretation of day-to-day comparisons between these measures.

There were two measures that were examined for between-day repeatability during single leg standing. Co-contraction of the right lumbar erector spinae and left internal oblique (RLES-LIO) muscle pair during right SLS was found to be highly repeatable, with ICC  $> 0.90$ . There was a discrepancy between sides for repeatability of the gluteus medius muscle activation however. For LSLS, the average left gluteus medius muscle activation was very different between the two collection days (ICC  $< 0.10$ ), while it was more similar for the right gluteus medius during RSLs (ICC = 0.5). Most of the participants in this study were right leg dominant, and it is possible that they had a more established muscle activation pattern during RSLs because of this.

Relative contribution of the external oblique (EO) muscles to vertebral joint rotation stiffness (VJRS) during squatting was found to be different between PD/NPD groups in Study 1. There were marked differences in the between-day repeatability of this measure according to task phase. For the ‘down’ phase of the squat, there was very poor between-day repeatability both in average and peak contribution of the EO muscles to stiffness. At all 5 lumbar vertebral levels and about all 3 rotation axes, between-day repeatability was non-significant. In contrast, for the ‘up’ phase of the squat, participants had very similar average and peak relative contributions of the EO to VJRS between days, especially about the *y*-axis (axial twist) and *z*-axis (flexion/extension). While the unloaded squat is not a particularly challenging task, individuals may require more muscle engagement and control during the upward (return to stand) phase as they are moving their body mass against gravity (concentric phase). During the downward phase, especially since it is unloaded and they do not have to balance or control an external weight, they may not use their trunk muscles as much to stabilize or control the motion. This may have resulted in more variability during the ‘downward’ phase of the squat since less precision was required to be successful in the movement. It may be that reliability increases with more challenging tasks, and variability of performance is higher when the physical demand is lower. It would be of interest to repeat this study with a loaded squat and see if the variability between the phases changes.

Muscle activation patterns during prolonged standing were very repeatable, with very few between-day differences noted. For co-contraction of the gluteus medius muscles, ICC values exceeded 0.80. For co-contraction of the trunk flexor/extensor muscles, between-day ICC for the PD group was very good (ICC > 0.80), however it was poor for the NPD

group ( $ICC < 0.10$ ). This indicates that there is more day-to-day variability in trunk muscle co-activation in individuals who are not predisposed to develop LBP during standing, while pain developers tend to utilize the same muscle co-activation pattern more consistently. This is consistent with reports in the literature that people with LBP have decreased variability in muscle onsets of the internal oblique with a self-initiated arm-raise perturbation (Jacobs, Henry et al. 2009). There have been similar findings in healthy individuals who have had acute, experimentally induced LBP (hypotonic saline injection) (Moseley and Hodges 2006). The conclusions that have been made from these studies are that people with LBP have a limited number of strategies they can draw upon, thereby limiting their ability to adapt to changing physical demands and circumstances. The other measures of muscle activation patterns during standing that were previously found to have PD/NPD group differences (average EMG levels and total Gap length), were all very repeatable between days with ICC values ranging from 0.62 to 0.87 for the control groups.

The second hypothesis that there would be good between-day repeatability for these measures was largely supported, as most of the variables were found to have good-to-excellent between-day ICC values. These findings greatly increase confidence that any observed changes in these measures in response to the exercise intervention were truly related to the intervention rather than due to natural between day variability.

## 9. GENERAL DISCUSSION AND CONCLUSIONS

The primary theme for this thesis was to investigate and characterize motor control, clinical and biomechanical factors in individuals who develop transient LBP during a functional standing task. The assumption was that these factors would occur prior to pain development, and therefore could be considered to be predisposing rather than adaptive to the pain state. Potentially, these factors could then be used to identify at-risk individuals *a priori* and possibly be useful in early intervention or workplace modification. To expand upon previous work, and to increase the clinical relevance and utility of this study, a biopsychosocial framework was utilized, including administration of psychosocial questionnaires and a standardized physiotherapy clinical assessment protocol. The results of this research confirmed earlier findings that people who develop LBP during this standing protocol exhibit elevated co-contraction of the gluteus medius and trunk musculature. Additionally, the LBP developers modulated their muscle activation patterns differently throughout the standing exposure, and had less time that the gluteal muscles were in the ‘resting’ state compared with those who did not develop LBP during prolonged standing.

This study provides support for the idea that the LBP experienced by individuals in this study may be due to a low-level muscle fatigue brought on by the sustained standing posture. While specific mechanisms for pain development may be debatable, a combination of the sustained mechanical loading with accumulation of metabolites as described in the peripheral pain generator model may be the driving factor in this scenario. Psychosocial factors did not seem to be important in the sample that participated in these studies, although it is impossible to ascertain whether there may

have been some heightened sensitization to pain stimuli centrally within the PD group due to factors that were unforeseen or uncontrollable within this study design (such as participant's individual pain histories). It is unlikely that there is a patho-anatomical mechanism for the LBP that was experienced by these individuals since this was a low-demand task, no trauma was involved, and participants reported that their pain resolved immediately once they were able to sit down and rest following the standing protocol.

It is clear that there are predisposing factors for LBP development during standing that are present prior to the onset of pain perception. Some of these factors may be modulated in adaptation to the pain response, as in decreasing or increasing trunk co-activation.

Trunk muscle co-activation does appear to be a beneficial adaptation as a static posture is sustained, however the presence of high co-activation initially seems to be a predisposing factor for pain development. It has been suggested that there may exist a motor control gene that may potentially contribute to excessive muscle guarding, and decreased movement in patients with pain (Mishra, Weu et al. 2007). While these authors focused their studies on 14 specific genes in people who already had a LBP problem (sciatica), the idea that there may be a genetic predisposition for increased muscle tone, and potentially co-activation, is an interesting one in the context of the current study. The presence of gluteus medius muscle co-activation may be a maladaptive response as individuals are attempting to compensate for an inability to adequately or appropriately utilize the trunk musculature for postural stability, and may be a useful marker to indicate elevated risk for LBP development during occupational standing.

A secondary theme of this thesis was to investigate the impact of a commonly utilized physiotherapy administered exercise intervention program on both subjective pain



development, and the previously identified factors. It is clear that muscle activation patterns can be modified through an exercise intervention, and there was a positive subjective low back pain response to exercise intervention as seen in this study. Less clear is whether the changes that were observed were related directly to the decrease in low back pain reported, particularly since there were gender differences in the muscle activation responses, but no gender differences in VAS measured LBP changes. The fact that the control groups were highly repeatable in their between day measures lends confidence to the conclusion that the changes observed were in fact due to the intervention. The duration of the exercise intervention was necessarily short (4-weeks) for this study. Greater changes may have been observed had the intervention been continued for a time period that was more similar to clinical rehabilitation scenarios (8-12 weeks). The fact that positive changes were observed with a relatively short intervention duration is encouraging. Future work should focus on clinical LBP populations to determine whether similar muscle activation patterns as observed in the PD group in these studies exists, and how these may be modified in response to an exercise intervention.

There are several limitations to this research that must be addressed. The findings may not be generalizable to clinical or elderly populations since the participants in this study consisted of healthy, physically active and young individuals. It is unknown at this point if the presence of LBP during a single standing exposure indicates an elevated risk of developing LBP at a clinical level in the future. A longitudinal study has been started to follow the participants in this study through surveys over the next 5 years to determine if those classified as PD in this study report a higher incidence of LBP reporting in the

future. Ethical review for this longitudinal study has been completed and the first year followup has been distributed. While the data collections involved in these studies were extensive, they were of course not completely inclusive and it is possible that there were important factors that were not measured or assessed. There are limitations, as already noted, with surface EMG in that many of the stabilizing muscles cannot be directly monitored (i.e. quadratus lumborum or psoas). Accurate between-day comparisons are also highly dependent on consistency of electrode placement and obtaining true maximum voluntary contractions for normalization purposes. There are also many underlying assumptions and limitations in the models used to calculate the vertebral joint rotation stiffness, most notably the lack of gender specificity within the models. This combined with the small sample size once participants were assigned to sub-groups, prevented gender comparisons from being made in this outcome measure. Participants were not asked if they had an expectation of LBP development during the standing exposure. Their personal histories or expectations about the protocol may have influenced their subjective pain reporting.

The findings from these studies provide a foundation for continued work in this area, like most research endeavours the work has raised as many questions as have been answered. Future work will attempt to more clearly isolate factors that are predisposing to pain development as well as the motor control and muscle activation responses to exercise intervention. By narrowing down some of the muscle factors that may be of greater importance (gluteus medius, lumbar erector spinae, internal and external oblique muscles), it may be possible to perform workplace screenings and longitudinal studies in people who are involved in standing occupations. Early intervention exercise programs

can then be implemented, and cost-benefit analyses applied. Gender differences appear to be present as well, and it would be of interest to further explore how gender influences response to commonly applied interventions. Preliminary findings in these studies of the predictive ability of a novel assessment tool of active hip abduction are also encouraging. Studies that are designed to specifically investigate the utility of this measure in clinical populations, as well as reliability, will be another area for future focus.

## REFERENCES

- Abenhaim, L., M. Rossignol, et al. (2000). "The role of activity in the therapeutic management of back pain: Report of the International Paris Task Force in Back Pain " Spine 25(4): 1S-33S.
- Adams, M. A., A. F. Mannon, et al. (1999). "Personal Risk Factors for First-Time Low Back Pain." Spine 24(23): 2497-2505.
- Airaksinen, O., J. I. Brox, et al. (2006). "European guidelines for the management of chronic non-specific low back pain." European Spine Journal 15(Chapter 4): S192-300.
- Anders, C., S. Bretschneider, et al. (2005). "Activation characteristics of shoulder muscles during maximal and submaximal efforts." European Journal of Applied Physiology 93(5): 540-546.
- Andersen, J. H., J. P. Haahr, et al. (2007). "Risk Factors for More Severe Regional Musculoskeletal Symptoms." Arthritis & Rheumatism 56(4): 1355-1364.
- Ayotte, N. W., D. M. Stetts, et al. (2007). "Electromyographical Analysis of Selected Lower Extremity Muscles During 5 Unilateral Weight-Bearing Exercises." Journal of Orthopaedic and Sports Physical Therapy 37(2): 48-55.
- Beach, T. A. C., S. J. Howarth, et al. (2008). "Muscular contribution to low-back loading and stiffness during standard and suspended push-ups." Human Movement Science 27(3): 457-472.
- Bijur, P. E., C. T. Latimer, et al. (2003). "Validation of a Verbally Administered Numerical Rating Scale of Acute Pain for Use in the Emergency Department." Academic Emergency Medicine 10(4): 390-392.
- Binkley, J., P. Stratford, et al. (1995). "Interrater reliability of lumbar accessory motion mobility testing." Physical Therapy 75: 786-95.
- Bogduk, N. (1995). "The anatomical basis for spinal pain syndromes." Journal of Manipulative and Physiological Therapeutics 18(9): 603-605.
- Brennan, G. P., J. M. Fritz, et al. (2006). "Identifying subgroups of patients with acute/subacute "nonspecific" low back pain: results of a randomized clinical trial." Spine 31(6): 623-631.
- Brereton, L. and S. McGill (1998). "Frequency response of spine extensors during rapid isometric contractions: effects of muscle length and tension." Journal of Electromyography & Kinesiology 8(4): 227-232.
- Brown, S. H. M. and J. R. Potvin (2007). "Exploring the geometric and mechanical characteristics of the spine musculature to provide rotational stiffness to two spine joints in the neutral posture." Human Movement Science 26: 113-123.
- Brumagne, S., L. Janssens, et al. (2008). "Persons with recurrent low back pain exhibit a rigid postural control strategy." European Spine Journal 17: 1177-1184.
- Burke, S. M., A. V. Carron, et al. (2005). "Physical activity context and university student's propensity to meet the guidelines Centers for Disease Control and Prevention/American College of Sports Medicine." Med Sci Monit 11(4): CR171-176.

- Burnett, A. F., M. W. Cornelius, et al. (2004). "Spinal kinematics and trunk muscle activity in cyclists: a comparison between healthy controls and non-specific chronic low back pain subjects-a pilot investigation." Manual Therapy 9(4): 211-9.
- Callaghan, J. P. and N. M. Dunk (2002). "Examination of the flexion relaxation phenomenon in erector spinae muscles during short duration slumped sitting." Clinical Biomechanics 17(5): 353-360.
- Callaghan, J. P., J. L. Gunning, et al. (1998). "The Relationship Between Lumbar Spine Load and Muscle Activity During Extensor Exercises." Physical Therapy 78(1): 8-18.
- Capdevilla Ortis, L., J. Ninerola Maymi, et al. (2007). "Exercise motivation in university community members: a behavioural intervention." Psicothema 19(2): 250-5.
- Cappozzo, A., U. Della Croce, et al. (2005). "Human movement analysis using stereophotogrammetry Part 1: theoretical background." Gait and Posture 21: 186-196.
- Chapman, C. R. and P. J. Dunbar (1998). "Measurement in pain therapy: is pain relief really the endpoint?" Current Opinion in Anaesthesiology 11(5): 533-7.
- Childs, J. D., J. M. Fritz, et al. (2004). "A Clinical Prediction Rule To Identify Patients with Low Back Pain Most Likely To Benefit from Spinal Manipulation: A Validation Study." Ann Intern Med 141(12): 920-928.
- Cholewicki, J. and S. M. McGill (1995). "Relationship Between Muscle Force and Stiffness in the Whole Mammalian Muscle: A Simulation Study." Journal of Biomechanical Engineering 117: 339-342.
- Cholewicki, J. and S. M. McGill (1996). "Mechanical stability of the *in vivo* lumbar spine: implications for injury and chronic low back pain." Clinical Biomechanics 11(1): 1-15.
- Cook, A. J. and D. E. DeGood (2006). "The Cognitive Risk Profile for Pain: Development of a Self-report Inventory for Identifying Beliefs and Attitudes That Interfere With Pain Management." Clin J Pain 22(4): 332-345.
- Crane, B. A., M. B. Holm, et al. (2005). "Test-retest reliability, internal item consistency, and concurrent validity of the wheelchair seating discomfort assessment tool." Assistive Technology 17(2): 98-107.
- da Silva, R. A., A. B. Arsenault, et al. (2005). "Back Muscle Strength and Fatigue in Healthy and Chronic Low Back Pain Subjects: A Comparative Study of 3 Assessment Protocols." Archives of Physical Medicine and Rehabilitation 86: 722-729.
- Dankaerts, W., P. O'Sullivan, et al. (2006). "Altered patterns of superficial trunk muscle activation during sitting in nonspecific chronic low back pain patients: importance of subclassification." Spine 31(17): 2017-23.
- Dankaerts, W., P. O'Sullivan, et al. (2006). "Differences in sitting postures are associated with nonspecific chronic low back pain disorders when patients are subclassified." Spine 31(6): 698-704.

- Dankaerts, W., P. B. O'Sullivan, et al. (2007). "The use of a mechanism-based classification system to evaluate and direct management of a patient with non-specific chronic low back pain and motor control impairment--a case report." Manual Therapy 12(2): 181-91.
- Dankaerts, W., P. B. O'Sullivan, et al. (2004). "Reliability of EMG measurements for trunk muscles during maximal and sub-maximal voluntary isometric contractions in healthy controls and CLBP patients." Journal of Electromyography and Kinesiology 14(3): 333-42.
- Danneels, L. A., B. J. Cagnie, et al. (2001). "Intra-operator and inter-operator reliability of surface electromyography in the clinical evaluation of back muscles." Manual Therapy 6(3): 145-153.
- Dark, A., K. A. Ginn, et al. (2007). "Shoulder Muscle Recruitment Patterns During Commonly Used Rotator Cuff Exercises: An Electromyographic Study." PHYS THER 87(8): 1039-1046.
- De Luca, C. J. (1997). "The Use of Surface Electromyography in Biomechanics." Journal of Applied Biomechanics 13: 135-163.
- de Oliveira Sato, T. and H. J. Cote Gil Coury (2009). "Evaluation of musculoskeletal health outcomes in the context of job rotation and multifunctional jobs." Applied Ergonomics 40(4): 707-712.
- Dempster, W. T. (1955). Space requirements for the seated operator. Wright-Patterson Air Force Base, Ohio, WADC Technical Report: 55-159.
- DeVahl, J., R. King, et al. (2005). "Academic incentives for students can increase participation in and effectiveness of a physical activity program." Journal of American College Health 53(6): 295-8.
- Drake, J. D. M. and J. P. Callaghan (2006). "Elimination of electrocardiogram contamination from electromyogram signals: An evaluation of currently used removal techniques." Journal of Electromyography and Kinesiology 16(2): 175-187.
- Ferguson, S. A., W. S. Marras, et al. (2004). "Differences in motor recruitment and resulting kinematics between low back pain patients and asymptomatic participants during lifting exertions." Clinical Biomechanics 19(10): 992-999.
- Ferreira, M. L., P. H. Ferreira, et al. (2007). "Comparison of general exercise, motor control exercise and spinal manipulative therapy for chronic low back pain: A randomized trial." Pain 131(1-2): 31-37.
- Fitts, R. H. (1994). "Cellular Mechanisms of Muscle Fatigue." Physiological Reviews 74(1).
- Fleischer, A. E., A. A. Didyk, et al. (2009). "Combined Clinical and Laboratory Testing Improves Diagnostic Accuracy for Osteomyelitis in the Diabetic Foot." The Journal of Foot and Ankle Surgery 48(1): 39-46.
- Flynn, T., J. Fritz, et al. (2002). "A clinical prediction rule for classifying patients with low back pain who demonstrate short-term improvement with spinal manipulation." Spine 27(24): 2835-43.

- Folsom, A. R., D. R. Jacobs, et al. (1986). "Test-retest reliability of the Minnesota Leisure Time Physical Activity Questionnaire." Journal of Chronic Diseases 39(7): 505-511.
- Forkan, R., B. Pumper, et al. (2006). "Exercise Adherence Following Physical Therapy Intervention in Older Adults With Impaired Balance." PHYS THER 86(3): 401-410.
- Frazer, M. B., R. W. Norman, et al. (2003). "The effects of job rotation on the risk of reporting low back pain." Ergonomics 46(9): 904-919.
- Fritz, J., G. P. Brennan, et al. (2006). "An examination of the reliability of a classification algorithm for subgrouping patients with low back pain. ." Spine 31: 77-82.
- Fritz, J., J. A. Cleland, et al. (2007). "Subgrouping Patients With Low Back Pain: Evolution of a Classification Approach to Physical Therapy." Journal of Orthopaedic and Sports Physical Therapy 37(6): 290-302.
- Fritz, J. and S. Z. George (2000). "The use of a classification approach to identify subgroups of patients with acute low back pain. Interrater reliability and short-term treatment outcomes. ." Spine 25: 106-114.
- Fritz, J., S. R. Piva, et al. (2005). "Accuracy of the clinical examination to predict radiographic instability of the lumbar spine." European Spine Journal 14: 743-750.
- Fritz, J., J. Whitman, et al. (2004). "Factors related to the inability of individuals with low back pain to improve with spinal manipulation." Physical Therapy 84(2): 173-190.
- Fritz, J. M., A. Delitto, et al. (2000). "Interrater reliability of judgments of the centralization phenomenon and status change during movement testing in patients with low back pain." Archives of Physical Medicine and Rehabilitation 81(1): 57-61.
- Fritz, J. M. and R. S. Wainner (2001). "Examining Diagnostic Tests: An Evidence-Based Perspective." Physical Therapy 81(9): 1546-1564.
- George, S. Z., E. A. Dannecker, et al. (2006). "Fear of pain, not pain catastrophizing, predicts acute pain intensity, but neither factor predicts tolerance or blood pressure reactivity: An experimental investigation in pain-free individuals." European Journal of Pain 10(5): 457-465.
- George, S. Z. and A. Delitto (2005). "Clinical examination variables discriminate among treatment-based classification groups: a study of construct validity in patients with acute low back pain." Physical Therapy 85(4): 306-14.
- George, S. Z., V. T. Wittmer, et al. (2007). "Sex and Pain-Related Psychological Variables Are Associated With Thermal Pain Sensitivity for Patients With Chronic Low Back Pain." The Journal of Pain 8(1): 2-10.
- Giesecke, T., R. H. Gracely, et al. (2004). "Evidence of augmented central pain processing in idiopathic chronic low back pain." Arthritis & Rheumatism 50(2): 613-623.
- Gift, A. (1989). "Visual Analogue Scales: Measurement of Subjective Phenomena." Nursing Research 38(5): 286-288.

- Gombatto, S. P., D. R. Collins, et al. (2006). "Gender differences in pattern of hip and lumbopelvic rotation in people with low back pain." Clinical Biomechanics 21(3): 263-271.
- Gregory, D. E., S. H. M. Brown, et al. (2008). "Trunk muscle responses to suddenly applied loads: Do individuals who develop discomfort during prolonged standing respond differently?" Journal of Electromyography and Kinesiology 18(3): 495-502.
- Gregory, D. E. and J. P. Callaghan (2008). "Prolonged standing as a precursor for the development of low back discomfort: An investigation of possible mechanisms." Gait and Posture 28: 86-92.
- Grenier, S. G. and S. M. McGill (2007). "Quantification of Lumbar Stability by Using 2 Different Abdominal Activation Strategies." Archives of Physical Medicine and Rehabilitation 88(1): 54-62.
- Hagg, O., P. Fritzell, et al. (2003). "The clinical importance of changes in outcome scores after treatment for low back pain." European Spine Journal 12: 12-20.
- Hardcastle, P. and S. Nade (1985). "The significance of the Trendelenburg test." J Bone Joint Surg Br 67-B(5): 741-746.
- Hayden, J. A., M. van Tulder, et al. (2005). "Systematic Review: Strategies for Using Exercise Therapy to Improve Outcomes in Chronic Low Back Pain." Annals of Internal Medicine 142: 776-785.
- Heiss, D. G., D. S. Fitch, et al. (2004). "The interrater reliability among physical therapists newly trained in a classification system for acute low back pain." Journal of Orthopaedic and Sports Physical Therapy 34: 430-439.
- Henry, S. M., J. R. Hitt, et al. (2006). "Decreased limits of stability in response to postural perturbations in subjects with low back pain." Clinical Biomechanics 21(9): 881-892.
- Hestbaek, L., C. Leboeuf-Yde, et al. (2003). "Low back pain: what is the long-term course? A review of studies of general patient populations." European Spine Journal 12(2): 149-165.
- Hicks, G. E., J. M. Fritz, et al. (2005). "Preliminary Development of a Clinical Prediction Rule for Determining Which Patients With Low Back Pain Will Respond to a Stabilization Exercise Program." Archives of Physical Medicine and Rehabilitation 86(9): 1753-1762.
- Hicks, G. E., J. M. Fritz, et al. (2003). "Interrater reliability of clinical examination measures for identification of lumbar segmental instability." Archives of Physical Medicine and Rehabilitation 84(12): 1858-1864.
- Holden, J. P., W. S. Selbie, et al. (2003). "A proposed test to support the clinical movement analysis laboratory accreditation process." Gait and Posture 17: 205-213.
- Holm, I., B. Bolstad, et al. (2000). "Reliability of goniometric measurements and visual estimates of hip ROM in patients with hip osteoarthritis." Physiotherapy Research International 5: 241-248.



- Howarth, S. J., T. A. C. Beach, et al. (2008). "Abdominal Muscles Dominate Contributions to Vertebral Joint Stiffness During the Push-Up." Journal of Applied Biomechanics 24(2): 130-139.
- Hungerford, B., W. Gilleard, et al. (2003). "Evidence of Altered Lumbopelvic Muscle Recruitment in the Presence of Sacroiliac Joint Pain." Spine 28(14): 1593-1600.
- Jacobs, J. V., S. M. Henry, et al. (2009). "People with chronic low back pain exhibit decreased variability in the timing of their anticipatory postural adjustments." Behavioral Neuroscience 123(2): 455-458.
- Jorgensen, M., K. G. Davis, et al. (2005). "Characteristics of job rotation in the Midwest US manufacturing sector." Ergonomics 48(15): 1721-1733.
- Kankaanpaa, M., S. Taimela, et al. (1998). "Back and Hip Extensor Fatigability in Chronic Low Back Pain Patients and Controls." Archives of Physical Medicine and Rehabilitation 79: 412-417.
- Keele-Smith, R. and T. Leon (2003). "Evaluation of Individually Tailored Interventions on Exercise Adherence." West J Nurs Res 25(6): 623-640.
- Kelly, A.-M. (1998). "Does the Clinically Significant Difference in Visual Analog Scale Pain Scores Vary with Gender, Age, or Cause of Pain?" Academic Emergency Medicine 5: 1086-1090.
- Kim, J. Y., C. Stuart-Buttle, et al. (1994). "The effects of mats on back and leg fatigue." Applied Ergonomics 25(1): 29-34.
- Kingma, I., M. P. de Looze, et al. (1996). "Validation of a full body 3-D dynamic linked segment model." Human Movement Science 15: 833-860.
- Klassabo, N., K. Harms-Ringdahl, et al. (2003). "Examination of passive ROM and capsular patterns in the hip." Physiotherapy Research International 8: 1-12.
- Kovacs, F. M., V. Abraira, et al. (2008). "Minimum detectable and minimal clinically important changes for pain in patients with nonspecific neck pain." BMC Musculoskeletal Disorders 9(43): 1-9.
- Kroemer, K. H. E. and E. Grandjean (1997). Fitting the task to the human: A textbook of occupational ergonomics., CRC Press.
- Kumar, S. (2001). "Theories of musculoskeletal injury causation." Ergonomics 44(1): 17-47.
- Lariviere, C., D. Gagnon, et al. (2000). "The comparison of trunk muscles EMG activation between subjects with and without chronic low back pain during flexion-extension and lateral bending tasks." Journal of Electromyography & Kinesiology 10(2): 79-91.
- Leboeuf-Yde, C., J. M. Lauritsen, et al. (1997). "Why has the search for causes of low back pain largely been nonconclusive?" Spine 22(8): 877-881.
- Leinonen, V., M. Kankaanpaa, et al. (2000). "Back and Hip Extensor Activities During Flexion/Extension: Effects of Low Back Pain and Rehabilitation." Archives of Physical Medicine and Rehabilitation 81: 32-37.
- Lewek, M. D., K. S. Rudolph, et al. (2004). "Control of frontal plane knee laxity during gait in patients with medial compartment knee osteoarthritis." Osteoarthritis and Cartilage 12(9): 745-751.

- Linton, S. J. (2000). "A review of psychological risk factors in back and neck pain." Spine 25(9): 1148-1156.
- Lund, J. P., R. Donga, et al. (1991). "The pain-adaptation model: a discussion of the relationship between chronic musculoskeletal pain and motor activity." Canadian Journal of Physiology and Pharmacology 69: 683-694.
- Ma, S. and G. I. Zahalak (1991). "A distribution-moment model of energetics in skeletal muscle." Journal of Biomechanics 24(1): 21-35.
- Mader, T. J., F. S. J. Blank, et al. (2003). "How reliable are pain scores? a pilot study of 20 healthy volunteers." Journal of Emergency Nursing 29(4): 322-325.
- Maher, C. G. and R. Adams (1994). "Reliability of pain and stiffness assessments in clinical manual lumbar spine examination." Physical Therapy 74: 801-11.
- Maitland, G. D. (1977). Vertebral Manipulation. Boston, Butterworth (Publishers) Inc.
- Maitland, G. D. (1994). The Maitland Concept: Assessment, Examination, and Treatment by Passive Movement. Physical Therapy of the Low Back. L. T. Twomey and J. R. Taylor. New York, Churchill Livingstone: 149 - 170.
- Marras, W. S., M. Parnianpour, et al. (1995). "The classification of anatomic- and symptom-based low back disorders using motion measure models." Spine 20(23): 2531-2546.
- McDonnell, M. N., M. C. Ridding, et al. (2005). "Effect of human grip strategy on force control in precision tasks." Experimental Brain Research 161: 368-373.
- McGill, S. M. (2004). "Linking latest knowledge of injury mechanisms and spine function to the prevention of low back disorders." Journal of Electromyography & Kinesiology 14: 43-47.
- McGill, S. M., A. Childs, et al. (1999). "Endurance times for low back stabilization exercises: Clinical targets for testing and training from a normal database." Archives of Physical Medicine and Rehabilitation 80(8): 941-944.
- McGill, S. M., S. Grenier, et al. (2003). "Coordination of muscle activity to assure stability of the lumbar spine." Journal of Electromyography and Kinesiology 13(4): 353-359.
- McKenzie, R. A. (1994). Mechanical Diagnosis and Therapy for Disorders of the Low Back. Physical Therapy of the Low Back. L. T. Twomey and J. R. Taylor. New York, Churchill Livingstone: 171-196.
- Meijssen, P. and H. J. J. Knibbe (2007). "Prolonged Standing in the OR: A Dutch Research Study." AORN 86(3): 399-400, 403-412, 414.
- Mello, R. G. T., L. F. Oliveira, et al. (2007). "Digital Butterworth filter for subtracting noise from low magnitude surface electromyogram." Computer Methods and Programs in Biomedicine 87: 28-35.
- Mens, J. M., A. Vleeming, et al. (2001). "Reliability and Validity of the Active Straight Leg Raise Test in Posterior Pelvic Pain Since Pregnancy." Spine 26(10): 1167-1171.
- Mens, J. M., A. Vleeming, et al. (2002). "Validity of the Active Straight Leg Raise Test for Measuring Disease Severity in Patients With Posterior Pelvic Pain After Pregnancy." Spine 27(2): 196-200.

- Mens, J. M., A. Vleeming, et al. (1999). "The active straight leg raising test and mobility of the pelvic joints." European Spine Journal 8: 468-473.
- Mishra, B. K., T. Weu, et al. (2007). "Do motor control genes contribute to interindividual variability in decreased movement in patients with pain?" Molecular Pain 3(20): 1-11.
- Mogk, J. P. M. and P. J. Keir (2003). "Crosstalk in surface electromyography of the proximal forearm during gripping tasks." Journal of Electromyography and Kinesiology 13: 63-71.
- Mok, N. W., S. G. Brauer, et al. (2004). "Hip Strategy for Balance Control in Quiet Standing is Reduced in People With Low Back Pain." Spine 29(6): E107-E112.
- Moseley, G. and P. Hodges (2006). "Reduced variability of postural strategy prevents normalization of motor changes induced by back pain: a risk factor for chronic trouble?" Behav Neurosci 120: 474 - 476.
- Nachemson, A. (1999). "Back Pain." International Journal of Law and Psychiatry 22(5-6): 473-490.
- Nadler, S. F., G. A. Malanga, et al. (2002). "Hip muscle imbalance and low back pain in athletes: influence of core strengthening." Medicine & Science in Sports & Exercise 34(1): 9-16.
- Nadler, S. F., G. A. Malanga, et al. (2000). "The Relationship Between Lower Extremity Injury, Low Back Pain, and Hip Muscle Strength in Male and Female Collegiate Athletes." Clinical Journal of Sport Medicine 10: 89-97.
- Nadler, S. F., G. A. Malanga, et al. (2001). "Relationship Between Hip Muscle Imbalance and Occurrence of Low Back Pain in Collegiate Athletes: A Prospective Study." American Journal of Physical Medicine & Rehabilitation 80(8): 572-577.
- Nelson-Wong, E. and J. P. Callaghan (2009 - submitted in review). "The Impact of a Sloped Surface on Low Back Pain During Prolonged Standing Work: A Biomechanical Analysis." Applied Ergonomics.
- Nelson-Wong, E., T. W. Flynn, et al. (2009 ). "Development of Active Hip Abduction as a Screening Test for Identifying Occupational Low Back Pain " Journal of Orthopaedic and Sports Physical Therapy In Press.
- Nelson-Wong, E., D. E. Gregory, et al. (2008). "Gluteus medius muscle activation patterns as a predictor of low back pain during standing." Clinical Biomechanics 23: 545-553.
- Nelson-Wong, E., S. J. Howarth, et al. (2009). "Application of Auto and Cross-correlation Analysis in Human Movement and Rehabilitation Research." Journal of Orthopaedic and Sports Physical Therapy 39(4): 287-295.
- Ng, J. K.-F., V. Kippers, et al. (1998). "Muscle fibre orientation of abdominal muscles and suggested surface EMG electrode positions." Electromyography and Clinical Neurophysiology 38: 51-58.
- Norman, R., R. Wells, et al. (1998). "A comparison of peak vs cumulative physical work exposure risk factors for the reporting of low back pain in the automotive industry." Clinical Biomechanics 13: 561-573.

- O'Sullivan, P. (2005). "Diagnosis and classification of chronic low back pain disorders: Maladaptive movement and motor control impairments as underlying mechanism." Manual Therapy 10: 242-255.
- Osu, R., D. W. Franklin, et al. (2002). "Short- and Long-Term Changes in Joint Co-Contraction Associated With Motor Learning as Revealed From Surface EMG." Journal of Neurophysiology 88: 991-1004.
- Panjabi, M. M. (1992). "The Stabilizing System of the Spine. Part I. Function, Dysfunction, Adaptation and Enhancement." Journal of Spinal Disorders 5(4): 383-389.
- Panjabi, M. M. (1992). "The Stabilizing System of the Spine. Part II. Neutral Zone and Instability Hypothesis." Journal of Spinal Disorders 5(4): 390-397.
- Paquet, N., F. Malouin, et al. (1994). "Hip-Spine Movement Interaction and Muscle Activation Patterns During Sagittal Trunk Movements in Low Back Pain Patients." Spine 19(5): 596-603.
- Parakkat, J., G. Yang, et al. (2007). "The influence of lift frequency, lift duration and work experience on discomfort reporting." Ergonomics 50(3): 396 - 409.
- Pirouzi, S., J. Hides, et al. (2006). "Low Back Pain Patients Demonstrate Increased Hip Extensor Muscle Activity During Standardized Submaximal Rotation Efforts." Spine 31(26): E999-E1005.
- Pope, M. H. and T. H. Hansson (1992). "Vibration of the Spine and Low Back Pain." Clinical Orthopaedics & Related Research 279: 49-59.
- Portney, L. G. and M. P. Watkins (2000). Foundations of Clinical Research, Applications to Practice. Upper Saddle River, Prentice-Hall, Inc.
- Potvin, J. R. and S. H. M. Brown (2005). "An equation to calculate individual muscle contributions to joint stability." Journal of Biomechanics 38: 973-980.
- Prince, F., D. A. Winter, et al. (1994). "Anticipatory control of upper body balance during human locomotion." Gait and Posture 2: 19-25.
- Reeves, N. P. and J. Cholewicki (2003). "Modeling the Human Lumbar Spine for Assessing Spinal Loads, Stability, and Risk of Injury." Critical Reviews in Biomedical Engineering 31(1): 73-139.
- Revill, S. I., J. O. Robinson, et al. (1976). "The reliability of a linear analogue for evaluating pain." Anaesthesia 31(9): 1191-1198.
- Roelen, C. A. M., K. J. Schreuder, et al. (2008). "Perceived job demands relate to self-reported health complaints." Occup Med (Lond) 58(1): 58-63.
- Roussel, N. A., J. Nijs, et al. (2007). "Low Back Pain: Clinimetric Properties of the Trendelenburg Test, Active Straight Leg Raise Test, and Breathing Pattern During Active Straight Leg Raising." Journal of Manipulative and Physiological Therapeutics 30(4): 270-278.
- Sahrmann, S. A. (2002). Diagnosis and treatment of movement impairment syndromes. St. Louis, MO, Mosby.
- Schmader, K. E., R. Sloane, et al. (2007). "The impact of acute herpes zoster pain and discomfort on functional status and quality of life in older adults." Clinical Journal of Pain 23(6): 490-6.

- Schwarzer, A. C., C. N. Aprill, et al. (1994). "The relative contributions of the disc and zygapophyseal joint in chronic low back pain." Spine 19(7): 801-806.
- Shum, G. L. K., J. Crosbie, et al. (2005). "Effect of Low Back Pain on the Kinematics and Joint Coordination of the Lumbar Spine and Hip During Sit-to-Stand and Stand-to-Sit." Spine 30(17): 1998-2004.
- Shum, G. L. K., J. Crosbie, et al. (2005). "Symptomatic and Asymptomatic Movement Coordination of the Lumbar Spine and Hip During an Everyday Activity." Spine 30(23): E697-E702.
- Silfies, S. P., A. Bhattacharya, et al. (2009). "Trunk control during standing reach: A dynamical system analysis of movement strategies in patients with mechanical low back pain." Gait & Posture 29(3): 370-376.
- Silfies, S. P., D. Squillante, et al. (2005). "Trunk muscle recruitment patterns in specific chronic low back pain populations." Clinical Biomechanics 20: 465-473.
- Simons, D. and J. Travell (1981). "Myofascial Trigger Points, a Possible Explanation: Letter to the Editor " Pain 10: 106-109.
- Stratford, P., J. Binkley, et al. (1998). "Sensitivity to Change of the Roland-Morris Back Pain Questionnaire. 1." Physical Therapy 78: 1186-1196.
- Stucki, G. and T. Sigl (2003). "Assessment of the impact of disease on the individual." Best Practice & Research Clinical Rheumatology 17(3): 451-473.
- Tait, R. C. and J. T. Chibnall (1997). "Development of a brief version of the Survey of Pain Attitudes." Pain 70(2-3): 229-235.
- Tait, R. C. and J. T. Chibnall (2002). "Pain in Older Subacute Care Patients: Associations with Clinical Status and Treatment." Pain Medicine 3(3): 231-239.
- Travell, J., S. Rinzter, et al. (1942). "Pain and disability of the shoulder and arm." Journal of the American Medical Association 120: 417-422.
- van Dieen, J. H., J. Cholewicki, et al. (2003). "Trunk Muscle Recruitment Patterns in Patients With Low Back Pain Enhance the Stability of the Lumbar Spine." Spine 28(8): 834-841.
- van Dieen, J. H., L. P. J. Selen, et al. (2003). "Trunk muscle activation in low-back pain patients, an analysis of the literature." Journal of Electromyography and Kinesiology 13: 333-351.
- van Dieen, J. H., E. P. Westebring-van der Putten, et al. (2008). "Low-level activity of the trunk extensor muscles causes electromyographic manifestations of fatigue in absence of decreased oxygenation." Journal of Electromyography and Kinesiology In Press.
- Veiersted, K. B., R. H. Westgaard, et al. (1990). "Pattern of muscle activity during stereotyped work and its relation to muscle pain." International Archives of Occupational Environmental Health 62(1): 31-41.
- Waddell, G. (2004). The back pain revolution. Edinburgh ; New York, Churchill Livingstone.
- Waddell, G., M. Newton, et al. (1993). "A Fear-Avoidance Beliefs Questionnaire (FABQ) and the role of fear-avoidance beliefs in chronic low back pain and disability." Pain 52(2): 157-168.

- Werneke, M. W. and D. L. Hart (2003). "Discriminant Validity and Relative Precision for Classifying Patients With nonspecific Neck and Back Pain by Anatomic Pain Patterns." Spine 28(2): 161-166.
- Werneke, M. W. and D. L. Hart (2004). "Categorizing Patients With Occupational Low Back Pain by Use of the Quebec Task Force Classification System Versus Pain Pattern Classification Procedures: Discriminant and Predictive Validity." Physical Therapy 84(3): 243-254.
- White, A. A. r. and M. M. Panjabi (1990). Clinical Biomechanics of the Spine. Philadelphia, Lippincorr.
- White, J. L., L. B. Ransdell, et al. (2005). "Factors Related to Physical Activity Adherence in Women: Review and Suggestions for Future Research." Women & Health 41(4): 123-148.
- Wilder, D., M. L. Magnusson, et al. (1994). "The effect of posture and seat suspension design on discomfort and back muscle fatigue during simulated truck driving." Applied Ergonomics 25(2): 66-76.
- Winkelstein, B. A. and J. A. DeLeo (2004). "Mechanical Thresholds for Initiation and Persistence of Pain Following Nerve Root Injury: Mechanical and Chemical Contributions at Injury." Journal of Biomechanical Engineering 126: 258-263.
- Winter, D. A. (2005). Biomechanics and Motor Control of Human Movement. Hoboken, John Wiley & Sons, Inc.
- Zipp, P. (1982). "Recommendations for the Standardization of Lead Positions in Surface Electromyography." Applied Physiology.
- Zusman, M. (2002). "Forebrain-mediated sensitization of central pain pathways: 'non-specific' pain and a new image for MT." Manual Therapy 7(2): 80-88.

# APPENDIX A: MODIFIED MINNESOTA LEISURE-TIME PHYSICAL ACTIVITY QUESTIONNAIRE

## LEISURE TIME PHYSICAL ACTIVITIES

Listed below are a series of Leisure Time Activities. Related activities are grouped under general headings. Please read the list and check 'YES' in column 3 for those activities that you have performed in the **last 4 weeks**, and 'NO' in column 2 for those you have not. Do not complete any of the other columns.

To be completed by Participant  ACTIVITY (1)	Did you perform this activity?	Do not write in this space	Week of Activity				Average # of Times per week	Time per occasion	
			1	2	3	4		Hrs.	Min.

SECTION A: Walking and Miscellaneous

NO YES

010	Walking for Pleasure			3.5														
020	Walking to Work			4.0														
030	Use stairs when elevator is available			8.0														
040	Cross-country Hiking			6.0														
050	Back Packing			7.0														
060	Mountain Climbing			8.0														
115	Bicycling to Work and/or for Pleasure			8.0														
125	Dancing-Ballroom, Square and/or Disco			4.5														
135	Dancing- Aerobic, Ballet			6.5														
140	Horseback Riding			4.0														

SECTION B: Conditioning Exercise

NO YES

150	Home Exercise			3.5														
-----	---------------	--	--	-----	--	--	--	--	--	--	--	--	--	--	--	--	--	--

To be completed by Participant ACTIVITY (1)		Did you perform this activity?		Do not write in this space		Week of Activity				Average # of Times per week			Time per occasion		
						1	2	3	4				Hrs.	Min.	
160	Health Club Exercise			7.0											
180	Jog/Walk Combination			6.0											
200	Running			8.0											
210	Weight Lifting			3.0											

SECTION C: Water Activities

NO YES

220	Water Skiing			6.0											
235	Sailing in Competition			5.0											
250	Canoeing or Rowing for Pleasure			3.5											
260	Canoeing or Rowing in Competition			12.0											
270	Canoeing on a Camping Trip			4.0											
280	Swimming (at least 50 ft) at a Pool			6.0											
295	Swimming at the Beach			6.0											
310	Scuba Diving			7.0											
320	Snorkeling			5.0											



To be completed by Participant ACTIVITY (1)	Did you perform this activity?	Do not write in this space	Week of Activity				Average # of Times per week	Time per occasion	
			1	2	3	4		Hrs.	Min.

SECTION D: Winter Activities

NO YES

340	Snow Skiing, Downhill			6.0														
350	Snow Skiing, Cross Country			8.0														
360	Ice (or Roller) Skating			7.0														
370	Sledding or Tobogganing			7.0														

SECTION E: Sports

NO YES

390	Bowling			3.0														
400	Volleyball			4.0														
410	Table Tennis			4.0														
420	Tennis, Singles			8.0														
430	Tennis, Doubles			5.0														
440	Softball			5.0														
450	Badminton			7.0														
460	Paddle Ball			6.0														
470	Racket Ball			7.0														
480	Basketball: Non-Game			6.0														
490	Basketball: Game			8.0														
500	Basketball: Officiating			7.0														
510	Touch Football			8.0														
520	Handball			12.0														

To be completed by Participant ACTIVITY (1)	Did you perform this activity?	Do not write in this space	Week of Activity				Average # of Times per week	Time per occasion										
			1	2	3	4		Hrs.	Min.									
530	Squash		12.0															
540	Soccer		7.0															

GOLF:

NO YES

070	Riding a Power Cart		3.5															
080	Walking, Pulling Clubs on Cart		4.3															
090	Walking and Carrying Clubs		4.5															

SECTION F: Lawn and Garden Activities

NO YES

550	Mowing Lawn With Riding Mower		2.5															
560	Mowing Lawn Walking Behind Power Mower		5.5															
570	Mowing Lawn Pushing Hand Mower		6.0															
580	Weeding and Cultivating Garden		4.5															
590	Spading, Digging, Filling in Garden		5.0															
600	Raking Lawn		4.0															
610	Snow Shoveling by Hand		6.0															

SECTION G: Home Repair Activities

NO YES

620	Carpentry in Workshop		3.0															
-----	-----------------------	--	-----	--	--	--	--	--	--	--	--	--	--	--	--	--	--	--

To be completed by Participant ACTIVITY (1)		Did you perform this activity?		Do not write in this space		Week of Activity				Average # of Times per week			Time per occasion		
						1	2	3	4				Hrs.	Min.	
630	Painting, Wallpapering Inside House			4.5											
640	Carpentry Outside			6.0											
650	Painting Outside of House			5.0											

SECTION H: Fishing and Hunting

NO YES

660	Fishing from River Bank			4.0											
670	Fishing in Stream with Wading Boots			6.0											
680	Hunting Pheasants or Grouse			6.0											
690	Hunting Rabbits, Prairie Chickens, Squirrels, Raccoon			5.0											
710	Hunting Large Game: Deer, Elk, Bear			6.0											

SECTION I: Other Activities

NO YES

	Ice Hockey			8.0											
--	------------	--	--	-----	--	--	--	--	--	--	--	--	--	--	--

## **APPENDIX B: CURRENT HEALTH STATUS FORM**

This questionnaire asks some questions about your health status. This information is used to guide us with your entry into the study.

Contraindications for entry into this study include: any history of low back pain where medical treatment was sought, or where > 3 days off school or work was required; previous hip surgery; inability to stand for greater than 3 hours.

---

**STUDY:** Biomechanical Predictors of Induced, non-Specific Low Back Pain and Motor Control Responses to a Stabilization Clinical Intervention

**PARTICIPANT ID CODE:**

---

**BIRTH DATE:** \_\_\_\_ - \_\_\_\_ - \_\_\_\_ (*dd - mm - year*)

**PROGRAM OF STUDY (STUDENTS):**

---

---

**OCCUPATION (INCLUDE PART-TIME EMPLOYMENT):**

---

**JOB DUTIES:**

---

---

**HOURS PER WEEK:** \_\_\_\_\_ **HOW LONG AT THIS JOB** \_\_\_\_\_

**SELF-REPORT CHECKLIST**

**Previous Problems**

*Musculoskeletal pain/disorders* Check all that apply:

Hip  Knee  Low back  Ankle

*Cardiovascular disorders/diseases* Check all that apply:

Heart Murmur  Heart Attack  Congenital Heart Disease  
 Heart Disease  Disease of the Arteries  High Blood Pressure  
 High Cholesterol

*Respiratory disorders/disease* Check all that apply:

Emphysema  Pneumonia  Asthma  Bronchitis

**Present Health Status**

*List current problems:*

---

---

*List medications now or in last 3 months:*

---

---

*List symptoms:*

Irregular Heart Beat  Fatigue  Chest Pain  Persistent  
Coughing  Shortness of Breath  Back pain/injury  Wheezing  
(Asthma)  Leg pain/injury  Dizziness  Shoulder pain/injury

*Current Physical Training Status:*

I consider my physical training status to be:  High,  Average,  Low

List the types of physical activities that you do on a regular basis:

---

---

*Habits:*

Smoking:     Never     Ex-smoker     Regular

Avg # cigarettes/day

*Current Height:* \_\_\_\_\_ *Current Weight:* \_\_\_\_\_

***Signature of Participant***

---

## APPENDIX C: THE CLINICAL ASSESSMENT FORM

Participant Identifier Number: \_\_\_\_\_

### Lumbar Active Range of Motion (Bubble Inclinometer)

Movement	Degrees	Aberrant Pattern	Check if Present
Flexion ROM		Instability Catch	
Extension ROM		Gowers Sign	
Left Sidebend ROM		Reversal of LP Rhythm	
Right Sidebend ROM			

### Hip Range of Motion (Goniometer)

Movement	Degrees
Flexion	
Left	
Right	
Extension	
Left	
Right	
Internal Rotation	
Left	
Right	
External Rotation	
Left	
Right	

### Straight Leg Raise Range of Motion (Bubble Inclinometer)

SLR ROM	Left	Right
Degrees		
Symptoms		

### Active Straight Leg Raise Test

0 = no difficulty

5 = unable

ASLR	Score
Left	
Right	
Total Score (sum)	

### Passive Segmental Mobility

0 = hypomobility, 1 = normal

2 = hypermobility

Level	0	1	2	Pain
L <sub>1</sub>				
L <sub>2</sub>				
L <sub>3</sub>				
L <sub>4</sub>				
L <sub>5</sub>				
Sacrum				

### Prone Instability Test

Level	Pain	Resolves
L <sub>1</sub>		
L <sub>2</sub>		
L <sub>3</sub>		
L <sub>4</sub>		
L <sub>5</sub>		

### Side Support Test

Side	Time to Failure
Left	
Right	

### Beiring-Sorensen Test

Time to Failure	

### Questionnaires

Assessment	Score
ODQ	
Pain Beliefs	
VAS	

## APPENDIX D: CORE STABILIZATION EXERCISE PROGRAM

### Abdominal Bracing – While Laying on Back

- Place fingers on abdominal muscles to monitor
- Tighten abdominals (think about bracing for someone to ‘punch’ you)
- Continue to breathe normally while contracting abdominal muscles
- Hold for 8 seconds, relax and repeat.

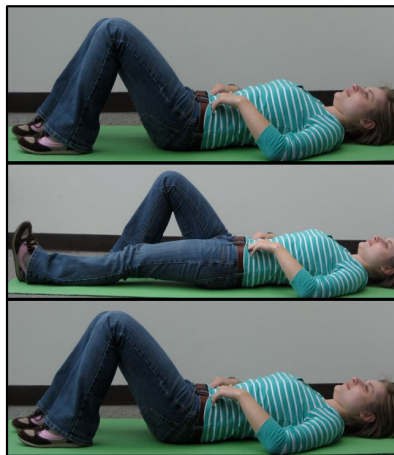


### Abdominal Bracing – While Standing

- Same as above, only while standing up.

### Abdominal Bracing – With Heel Slide

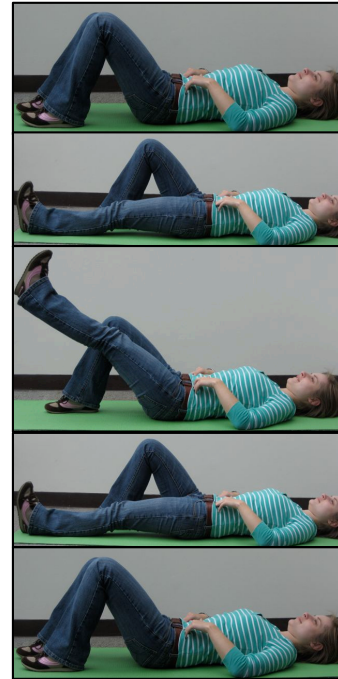
- Place fingers on abdominal muscles and contract as before.
- Slide one leg down (straight) while keeping pelvis stable and abdominals tight.
- Slide other leg down – keeping abdominals tight.
- Return by sliding one leg back at a time – keeping abdominals tight, pelvis stable.





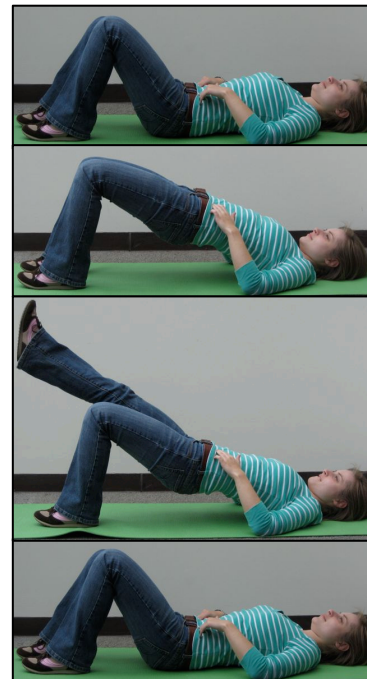
### Abdominal Bracing – With Leg Lift

- Place fingers on abdominal muscles and contract as before.
- Slide one leg down (straight) while keeping pelvis stable and abdominals tight.
- Keeping leg straight raise it off the floor toward the ceiling and lower it back to the floor, while keeping your pelvis stable and your abdominals tight.
- Do not push down into the floor with your other leg.
- Return by sliding the leg back into the bent position, and perform the exercise with the other leg.



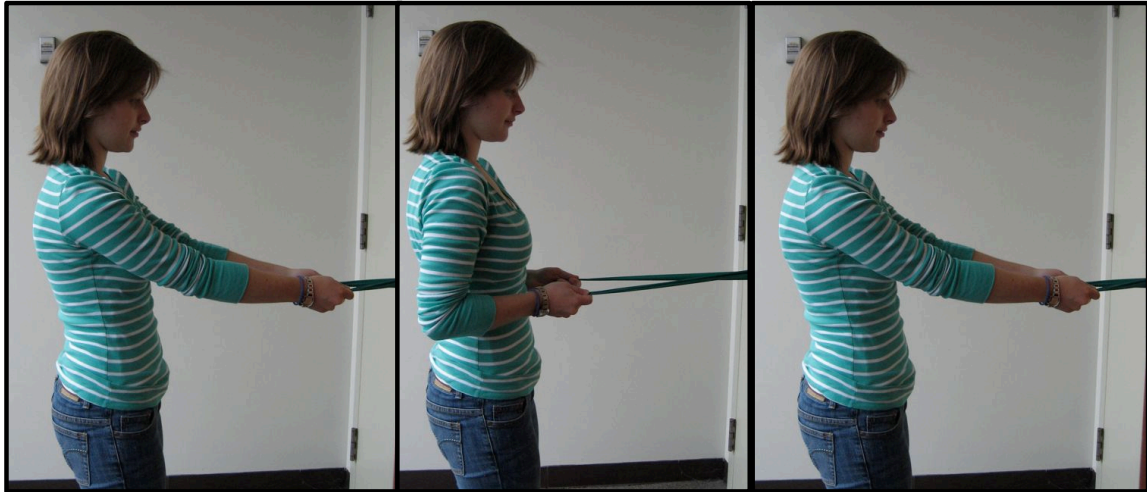
### Abdominal Bracing – With Bridge

- Place fingers on abdominal muscles and contract as before.
- Keeping abdominals tight, and breathing normally, raise hips off floor to make a straight line between your shoulders and your knees.
- Do not allow your back to round or arch.
- Hold for 8 seconds and return to floor
- Advanced progression – try straightening one leg without letting your pelvis drop.



### Abdominal Bracing – With Standing Row

- Place resistance band in the hinge of the door to secure it.
- Keeping abdominals tight, and breathing normally, perform a rowing exercise with the band.
- Note – photo shows the exercise in seated position, you will perform it in standing.
- Do not allow your back to round or arch.
- Hold the contraction for 6 seconds.



### Quadruped Arm Lifts With Abdominal Bracing

- Position on your hands and knees with hips over the knees and shoulders over the hands, spine is straight and head is in line with the body.
- Contract abdominal muscles as before.
- Lift arm overhead and hold for 8 seconds, alternate arms
- Do not let trunk move when lifting, lowering or alternating arms.



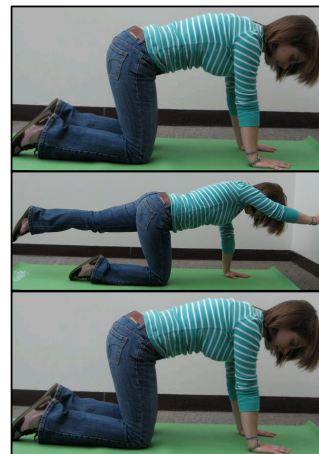
### Quadruped Leg Lifts With Abdominal Bracing

- Position on your hands and knees with hips over the knees and shoulders over the hands, spine is straight and head is in line with the body.
- Contract abdominal muscles as before.
- Lift one leg backwards so that hip and knee straighten, hold for 8 seconds.
- Return to starting position and repeat with opposite leg.
- Do not let trunk move when lifting, lowering or alternating legs.



### Quadruped Alternating Arm/Leg Lifts With Abdominal Bracing

- Position on your hands and knees with hips over the knees and shoulders over the hands, spine is straight and head is in line with the body.
- Contract abdominal muscles as before.
- Lift your opposite arm and leg at the same time, hold for 8 seconds.
- Return to starting position and repeat with opposite side.
- Do not let trunk move when lifting, lowering or alternating sides.



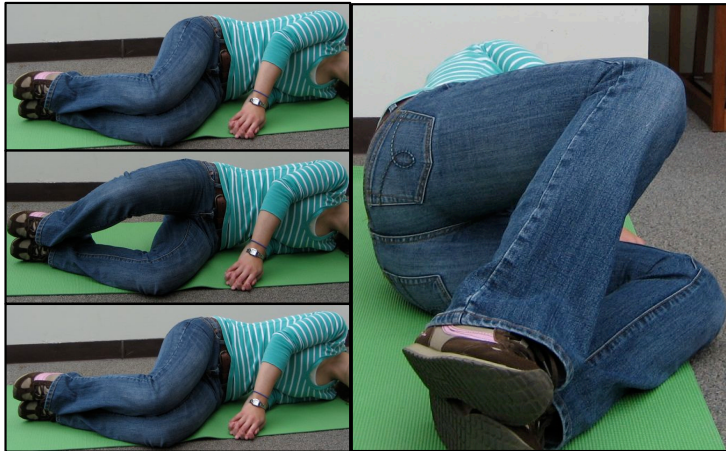
### Side Support with Knees Extended (Knees Bent for Modification)

- Lay on your side with your pelvis vertical to the floor, and your body in a straight line with your elbow underneath your shoulder.
- Contract abdominals as before, maintain your normal breathing.
- Lift up so your body is supported by your feet and elbow – don't let your pelvis rock forwards or backwards.



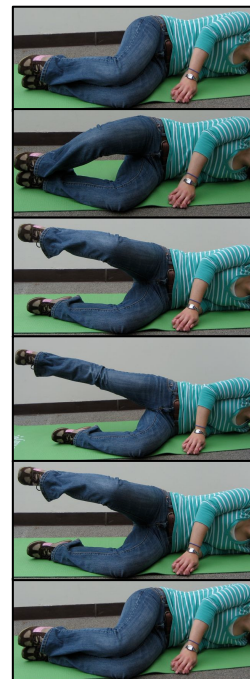
### Sidelying Clamshells With Abdominal Bracing

- Lie on your side with knees and hips bent, and pelvis vertical to floor.
- Keep ankles together, and lift top knee towards the ceiling.
- Move from the hip joint (think about rotating the hip in its socket), and do not let pelvis rock forwards or backwards.
- Keep abdominals tight, and maintain normal breathing throughout the exercise.



### Hip Abduction Progression (Clamshell + Hip Extension/Abduction/Lateral Rotation)

- Begin with clamshell as previously, keeping abdominals tight and pelvis stable.
- Simultaneously extend the knee and hip while slightly rotating the toes towards the ceiling.



### Single Leg Wall Slide

- Stand with back to a smooth wall. Perform abdominal bracing as previously. Position foot ahead of knee (should be slightly greater than 90-degree angle.)
- Extend other leg so that foot is off the floor.
- Squat down, keeping back against the wall, only as far as you can while keeping pelvis stable.





## APPENDIX E: STABILIZATION EXERCISE LOG

Please complete the log each day that you exercise. Your target goal for each week will be highlighted for you at each individual weekly session with the researcher.

Participant Number \_\_\_\_\_ Date \_\_\_\_\_ Total Time Exercising \_\_\_\_\_

Primary Muscle Group	Exercises	Goal	Actual
Transversus abdominus	Abdominal bracing	30 reps with 8-s hold	
	Bracing with heel slides	20 reps per leg with 4-s hold	
	Bracing with leg lifts	20 reps per leg with 4-s hold	
	Bracing with bridging	30 reps with 8-s hold, progress to 1 leg	
	Bracing in standing	30 reps with 8-s hold	
	Bracing with standing row exercise	20 reps per side with 6-s hold	
	Bracing with walking		
Erector spinae/multifidus	Quadruped arm lifts with bracing	30 reps with 8-s hold each side	
	Quadruped leg lifts with bracing	30 reps with 8-s hold each side	
	Quadruped alternating arm/leg lifts with bracing	30 reps with 8-s hold each side	
Quadratus lumborum	Side support with knees flexed	30 reps with 8-s hold each side	
	Side support with knees extended	30 reps with 8-s hold each side	
Oblique abdominals	Side support with knees flexed	30 reps with 8-s hold each side	
	Side support with knees extended	30 reps with 8-s hold each side	
Gluteus medius/TFL	Sidelying 'Clamshells' with bracing	30 reps each side	
	Sidelying 'clamshell' with hip abduction+extension and bracing	20 reps each side	
Glut medius/TFL	Single Leg Wall Slide	10 reps each side	
	Single Leg Wall Slide	25 reps each side	