

**Improving Frequency Reuse and
Cochannel Interference Coordination in
4G HetNets**

by

Irshad Ali Qaimkhani

A thesis
presented to the University of Waterloo
in fulfilment of the
thesis requirement for the degree of
Master of Applied Science
in
Electrical and Computer Engineering

Waterloo, Ontario, Canada, 2013

© Irshad Ali Qaimkhani 2013

Author's Declaration

I hereby declare that I am the sole author of this thesis. This is a true copy of the thesis, including any required final revisions, as accepted by my examiners.

I understand that my thesis may be made electronically available to the public.

ABSTRACT

This report describes my M.A.Sc. thesis research work. The emerging 4th generation (4G) mobile systems and networks (so called 4G HetNets) are designed as multi-layered cellular topology with a number of asymmetrically located, asymmetrically powered, self-organizing, and user-operated indoor small cell (e.g., pico/femto cells and WLANs) with a variety of cell architectures that are overlaid by a large cell (macro cell) with some or all interfering wireless links. These designs of 4G HetNets bring new challenges such as increased dynamics of user mobility and data traffic trespassing over the multi-layered cell boundaries. Traditional approaches of radio resource allocation and inter-cell (cochannel) interference management that are mostly centralized and static in the network core and are carried out pre-hand by the operator in 3G and lower cellular technologies, are liable to increased signaling overhead, latencies, complexities, and scalability issues and, thus, are not viable in case of 4G HetNets. In this thesis a comprehensive research study is carried out on improving the radio resource sharing and inter-cell interference management in 4G HetNets. The solution strategy exploits dynamic and adaptive channel allocation approaches such as dynamic and opportunistic spectrum access (DSA, OSA) techniques, through exploiting the spatiotemporal diversities among transmissions in *orthogonal frequency division multiple access (OFDMA)* based medium access in 4G HetNets.

In this regards, a novel framework named as *Hybrid Radio Resource Sharing (HRRS)* is introduced. HRRS comprises of these two functional modules: *Cognitive Radio Resource Sharing (CRRS)* and *Proactive Link Adaptation (PLA)* scheme. A dynamic switching algorithm enables CRRS and PLA modules to adaptively invoke according to whether orthogonal channelization is to be carried out exploiting the *interweave channel allocation (ICA)* approach or non-orthogonal channelization is to be carried out exploiting the *underlay channel allocation (UCA)* approach respectively when relevant conditions regarding the traffic demand and radio resource availability are met. Benefits of CRRS scheme are identified through simulative analysis in comparison to the legacy *cochannel* and *dedicated channel* deployments of femto cells respectively. The case study and numerical analysis for PLA scheme is carried out to understand the dynamics of threshold interference ranges as function of transmit powers of MBS and FBS, relative ranges of radio entities, and QoS requirement of services with the value realization of PLA scheme.

Acknowledgements

I would like to thank

- my supervisor, professor Otman Basir, for his guidance and support,
- ECE department, NSERC, and Governments of Ontario and Canada, for research funding and scholarships,
- and my family: Farhana Qaimkhani (my better half), Ammani (daughter), Saad, Farshad, and Musaab (sons), for their ever-lasting love, prayers, and support.

Dedication

I dedicate this thesis to my beloved mother, Zareena Qaimkhani, whose unconditional love, affections, sacrifices, and prayers are always the source of my real success.

Table of Contents

Author's Declaration	ii
Abstract	iii
Acknowledgements	iv
Dedication	v
Table of Contents	vi
List of Figures	ix
List of Tables	x
1 Introduction	1
1.1 Research Problem Overview	3
1.2 Motivation	5
1.3 Research Objectives	9
1.4 Scope of Research	9
1.5 Research Proposal Organization	11
2 Background and Literature Survey	12
2.1 Differentiation between 4G HetNets and Traditional Cellular Commu- nication Networks	12
2.1.1 Cellular Network Components Knowledge	12
2.1.2 4G HetNet and Beyond vs. 3G HomNet and Earlier	13
2.2 Small (Femto) Cell Architectural Standardization	16
2.2.1 3GPP Femto Cell	16
2.2.2 3GPP2 Femto Cell	18

2.2.3	WiMAX Femto Cell	19
2.2.4	OFDMA Femto Cell	20
2.3	Challenges and Technical Issues of Small Cells Deployment	22
2.3.1	Potential Interference Scenarios	24
2.4	Research Related Provisions for Small Cells Deployment in 4G HetNets	25
2.4.1	Frequency Partitioning/Reuse Approaches	26
2.4.2	Access Modes in 4G HetNets	27
2.4.3	Radio Resource Measurement	28
2.4.4	Range Measurement of Radio Frequency (RF) Entities	30
2.4.4.1	Major Positioning Approaches	30
2.4.4.2	Mobile Positioning in LTE-A	31
2.5	Channel Assignment Strategies	32
2.5.1	Fixed Channel Assignment (FCA)	33
2.5.2	Dynamic Channel Assignment (DCA)	33
2.5.2.1	Centralized DCA (C-DCA)	34
2.5.2.2	Distributed DCA (D-DCA)	34
2.5.3	Hybrid and Flexible Channel Assignment (HCA and FICA)	37
2.5.4	Reuse Partitioning (RuP) CA	38
2.5.5	Hierarchal-CA	39
2.5.6	User-based CA or Opportunistic CA	39
2.6	Research Approaches and Related Work	40
3	Research Problem: Description and Modeling	46
3.1	Problem Statement	46
3.1.1	Problem Challenging Issues: Causes and Effects	47
3.2	Solution Options, Choices, and Challenges	49
3.2.1	Solution Options	50
3.2.2	Solution Choices	52
3.2.3	Solution Challenges	53
3.3	Research Problem Modeling	55
3.3.1	Problem Scenario	55
3.3.1.1	Problem Space	57
3.3.1.2	Solution Space	58

3.3.2	Important Bounds, Metrics, and Parameters	59
3.3.2.1	Conditions for Orthogonal and Nonorthogonal Channelization	59
3.3.2.2	Radio Resource Reuse Efficiency (η)	60
3.3.2.3	Network Bounds	62
3.3.2.4	Traffic Dynamics	62
3.3.2.5	Determination of Demand and Usability of RRUs (Us)	63
4	Research Solution, Analysis, and Discussion	65
4.1	Introduction	65
4.2	Research Solution: Hybrid Radio Resource Sharing (HRRS) Framework	66
4.2.1	Cognitive Radio Resource Sharing (CRRS)	67
4.2.2	Proactive Link Adaptation (PLA)	70
4.3	Research Analysis and Discussion	73
4.3.1	CRRS versus Cochannel and Dedicated Channel Deployments: A Simulative Analysis and Comparison	73
4.3.2	Interference Range Computation for PLA	75
4.3.3	A Case Study and Analysis of PLA	80
4.4	Conclusion	84
5	Conclusion and Future Research Outline	86
5.1	Summary of Research Contributions	86
5.2	Future Research Outline	88
	Bibliography	91

List of Figures

Figure 1.1	Research Problem Scenario: Concentrated Traffic Zones.	4
Figure 1.2	Different Small Cells Architectures.	7
Figure 2.1	4G Heterogenous Cellular Network (4G HetNet) Topology.	14
Figure 2.2	Femto cell Architecture (3GPP, 3GPP2, WiMAX).	17
Figure 2.3	Typical Cochannel Interference Scenarios in 4G HetNets.	24
Figure 2.4	An example of minimum-span graph-coloring problem.	35
Figure 2.5	Legacy Power Control Approach.	42
Figure 3.1	Research Problem as a Function of Causes and Effects.	47
Figure 3.2	Research Problem: Solution Choices and Challenges.	54
Figure 3.3	4G HetNet Research Problem Scenario: Multi-tier Macro-Femto Cells Radio Resource Sharing.	56
Figure 3.4	An Illustration of Multi-dimensions in OFDMA Frame.	58
Figure 4.1	Sequence of Steps in Hybrid Radio Resource Sharing (HRRS) Framework.	68
Figure 4.2	Sequence of Steps in Proactive Link Adaptation (PLA) Scheme.	72
Figure 4.3	Probability of false channel detection vs. throughput.	75
Figure 4.4	Comparative throughput analysis of CRRS strategy.	76
Figure 4.5	Threshold interference range(s) of a MUE from FBS at the macro cell boundary.	82
Figure 4.6	Feasible region for SBS transmit powers at macro cell boundary.	83
Figure 4.7	Threshold interference range and interfering transmit power relationship.	84

List of Tables

Table 1.1	Capacity/Rate increase in successive cellular technologies. . . .	2
Table 2.1	Differentiation between HomNets and HetNets.	15
Table 3.1	Solution Options and Comparison.	51
Table 4.1	Simulation parameters.	74
Table 4.2	Input parameters.	81

Chapter 1

Introduction

In telecommunication industry, the ever increasing number of cellular users as well as the user demands for mobility and for integrated services such as delay sensitive voice, error sensitive data, and rate sensitive video, are outcomes of continuing but substantiated research and developments in telecommunication technologies that result into the emergence of robust applications and services. According to a survey of *International Telecommunication Union (ITU)* reported in the global mobile statistics 2011 [1], there was a huge increase of mobile subscriptions just in one year, i.e., 5.3 billion by the end of 2010 from 4.6 billion by the end of 2009. During this period the rise in sales of mobile devices was 18.5%. With such a huge increasing user and teletraffic base, cellular technologies have also been evolving to provide greater capacity, data rates, and low latencies over the past decade.

Major cellular technologies have evolved in the domains of 3rd generation (3G) cellular systems, such as universal mobile telecommunication system/wideband code division multiple access (UMTS/WCDMA), *cdma2000*, high speed packet access/plus (HSPA/HSPA+), and of 4th generation (4G) cellular systems and beyond, such as broadband wireless access under *IEEE 802.16m* (WiMAX) standardization, and *3G partnership project (3GPP)* standardizations, i.e., long term evolution advanced (LTE-A). Since 2003, down-link data rates offered by these cellular technologies have tremendously increased from 384Kbps in UMTS to 1Gbps in LTE-A with the round trip time latency decrease from 150 ms to lesser than 5 ms. This development trend of cellular technologies is illustrated in Table 1.1 [2]. Major technological developments that contributed to the consistent cellular capacity increase has mainly been in the dimensions of (but not limited to) higher data-rate transmission, efficient and larger bandwidth air-interface technologies, and spectrum reuse techniques.

Table 1.1. *Capacity/Rate increase in successive cellular technologies.*

	WCDMA (UMTS)	HSPA	HSPA+	LTE	LTE-A
Max downlink speed (bps)	384 K	14 M	28 M	100 M	1 G
Min uplink speed (bps)	128 K	5.7 M	11 M	50 M	500 M
Latency: round trip time (RTT)	150 ms	100 ms	50 ms	~ 10 ms	< 5 ms
Access technology	CDMA	CDMA	CDMA	OFDMA / SC-FDMA	OFDMA / SC-FDMA

High data rate transmission technologies contributing to capacity increase are high resolution modulation techniques (e.g., 16QAM, 32QAM, 64QAM and higher) and transmit diversity combining through multiple input and multiple output (MIMO) schemes. Air-interface technologies that also have impacts on capacity increase can be categorized in two groups. One is dividing the spectrum into slices or chunks such as frequency division multiple access (FDMA) and orthogonal frequency division multiple access (OFDMA), and second is consolidating the spectrum use through spread spectrum techniques deployed in code division multiple access (CDMA) based air-interface technologies such as wideband CDMA (WCDMA) and through broadband wireless access technologies. Whereas, spectrum reuse techniques such as minimal cell cluster sizing, minimal frequency reuse distance by bringing the transmitter and receiver closer, i.e., small cells (metro, pico, femto, WLAN), and efficient radio resource sharing through wireless medium access control (MAC), have impacted tremendously on wireless network capacity improvement.

A study of millionfold wireless capacity increase since 1957 contributed by each of these dimensions reveals their share in capacity increase as multiplying factors of 5, 5, 25, and 1600, respectively due to better resolution modulation, slicing the spectrum (i.e., frequency division), widening the spectrum (i.e., spread spectrum), and improving the spectrum reuse, [3][4][5]. However, these technological developments have their own limitations and challenges besides providing solutions to different extents to the pervasive growth in the demand and supply of wireless communication services.

1.1 Research Problem Overview

Recent research studies reveal that the subscribers and, thus, the teletraffic usually have asymmetric distribution in time and space over the entire coverage area. More than 50% of voice calls and 70% of data traffic originate in the indoor [6, 4]. This is due to the reason that mobile subscribers are more concentrated at work places, houses, public and metropolitan areas in different timings of the day and in different days of the week. These concentrated traffic zones account for more interference, more noise, and scarcity of radio resource. Besides, these concentrated traffic zones are more prone to radio propagation fading, i.e., path loss (distance related fading), penetration attenuation (radio propagation loss through the walls, floors, windows, doors etc.), multi-path and shadow fading (due to more and variety of obstacles between transmitter and receiver).

High resolution modulation and MIMO techniques that aim at high speed transmissions are less resilient to noise due to their peculiar designs. However, these techniques work better with the close proximity of transmitter and receiver. Similarly, the spread spectrum air interface technologies such as WCDMA, cdma2000, and HSPA/HSPA+, used in 3G and 3.5G cellular systems, cause wireless signals to fade quicker once these enter into the indoor environment. Also, the effective cell capacity with CDMA based systems is interference limited. Therefore, these high speed technological solutions are not able to provide their theoretical speeds, specially when the transmitter and receiver are located far apart, one in the indoor and the other in the outdoor.

All the factors mentioned above and some others, such as inappropriate cell node location and configuration planning and inefficient radio resource utilization, result into the shortage or even outage problem of radio coverage to the subscribers in these concentrated traffic zones (see Fig. 1.1). Consequently, the operators face problems such as loss of their networks capacities in terms of average teletraffic transport rate with their limited radio spectrum over the target coverage areas and dissatisfaction or even loss of customers due to frequent de-rating and/or outage of services in the highly competitive telecommunication market.

Therefore, the concentrated traffic zones which are mostly indoor or are highly congested metro areas of big cities account for shortage or outage of radio coverage,

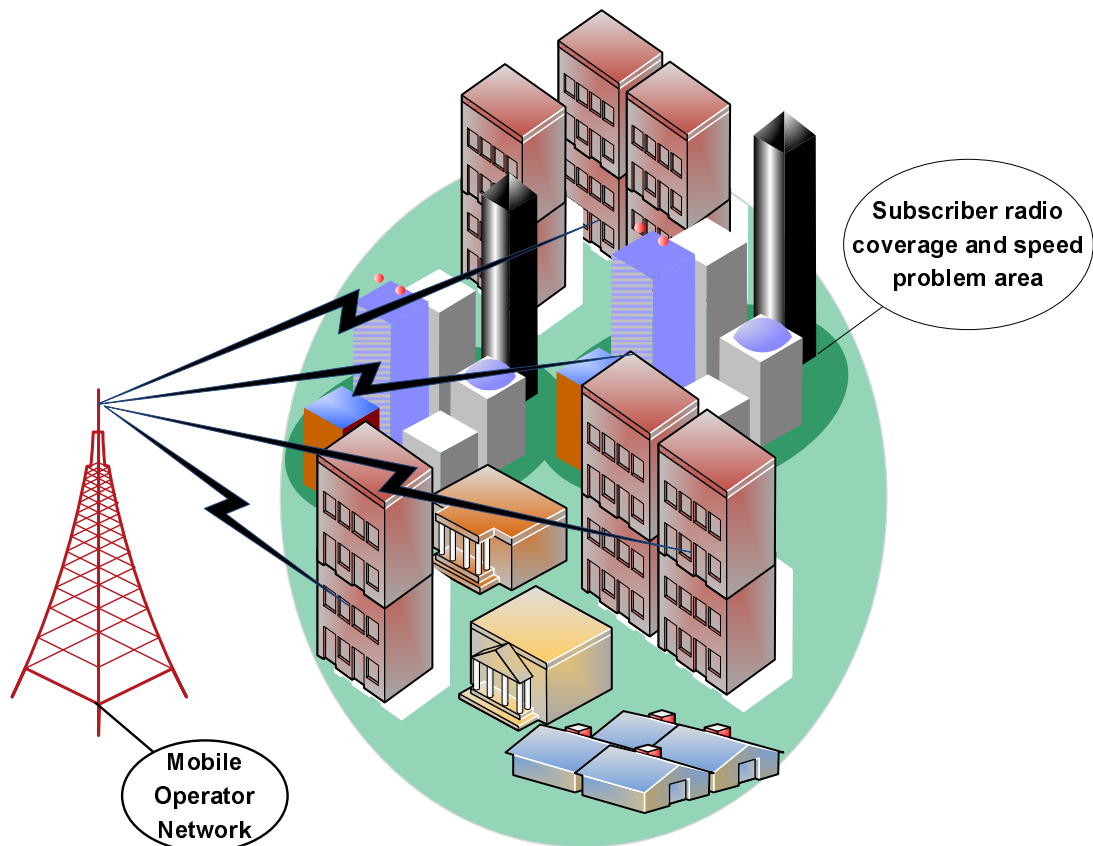

Figure 1.1. *Research Problem Scenario: Concentrated Traffic Zones.*

so called *radio coverage holes*, to the subscribers, specially for high speed wireless services that are provided over longer radio links within/across these *radio coverage holes*. In today's highly competitive telecommunication markets, cellular network operators have to resolve following two major problems for their success.

1. Elimination or minimization of *radio coverage holes* in time and space from the target coverage area to ensure continuous guaranteed services to subscribers
2. Fulfil the ever increasing services demands through scalable network capacities with the provision of efficient technological solutions within the limited available radio resources

Traditionally, the cellular network operators address these problems through improving the spectrum reuse, and thus capacity, by bringing the transmitter and receiver closer in different technological ways, thereby minimizing the radio coverage problem to some extent. These solutions which are the outcomes of extensive research

and development carried out over past two decades include: *distributed antenna systems, relays* and *remote radio heads (RRHs)*, *metro/micro cells*, *pico/femto cells*. All of these technological solutions that are employed in 2G, 3G, or in early 4G cellular systems, are planned and controlled by network operators, thereby resulting into cost-inefficient and non-scalable. Also, these solutions either do not alleviate the radio coverage problem at all or address it to some extent.

The smaller cell concepts can be viable solutions if these are deployed and operated by subscribers in their indoor environment, and cell nodes are made self-configuring and self-organizing. During the past decade, standard development organizations (SDOs) such as third generation partnership project (3GPP/3GPP2) and broadband forum (BBF), had started shaping smaller cell (femto cell) concepts for UMTS/WCDMA [11], *cdma2000* [12], and WiMAX [13][20] standardizations respectively. The emerging 4G and beyond-4G cellular air-interface technologies such as Long Term Evolution Advanced (LTE-A) and *IEEE 802.16m* based WiMAX have adopted these new approaches in multitier heterogeneous network architecture (so called *4G HetNets*) that would integrate the overlapping tiers of cells and base stations with different transmission powers and coverage sizes but sharing the same spectrum. This brings new challenges to the more complex but efficient communication technologies for: intelligent radio resource sharing among heterogeneous cell nodes and mobile subscribers; distributed cooperative control over transmissions; increased dynamics of inter-cell interworking.

1.2 Motivation

In order to cope with the ever increasing subscriber base worldwide especially for mobility and for robust applications and services within the limited available radio spectrum and with its peculiar characteristic constraints, the network operators and other stake holders always look for increasing the coverage and capacity of their wireless systems and networks. However, the largest factor contributing to capacity increase has been the increase in spectrum reuse spatially by bringing the transmitter and receiver closer which additionally enhances the coverage by improving link quality [4].

Capacity increase through higher data rate transmissions are possible with higher resolution modulation schemes and with the transmit diversity combining through MIMO schemes. However, higher resolution modulation schemes are less noise resilient due to the higher density of modulation constellation points and, therefore, require more robustness in link conditions, i.e., better signal to noise ratio (E_b/N_o) is required. As there is no other technological solution so far, the higher order modulation schemes, and thus, the higher data-rate services can only be provided effectively under robust link conditions which are naturally possible through close and clear proximity of user (subscriber) equipments (UEs) with the cell node, i.e., base station (BS).

Higher data rates, even above those predicted by *Shannon* in [82] for a single channel, are achievable with MIMO techniques through parallel transmission of multiple data streams with spatial multiplexing of multiple paths, thereby improving the network capacity. However, it requires higher carrier to interference ratio (C/I) which, again, is naturally achievable through the close proximity of transmitter and receiver. In case if the required higher C/I is not achievable and spatial multiplexing gains are not feasible, the receive diversity of MIMO can still be exploited to improve the reception of single data stream [2]. Also, the spread spectrum air interface technologies (WCDMA, cdma2000, and HSPA/HSPA+) cause wireless signals to fade quicker once these enter into the indoor environment which, again, can be resolved through close proximity of transmitter and receiver.

In view of the facts discussed above on limitations of modern high data rate transmission technologies, improving the radio links, specially in *radio coverage holes* becomes necessary not only for subscriber's and operator's benefits but also for the successful deployment of these high data rate transmission technologies in the emerging 4G cellular systems.

Bringing the transmitter and the receiver closer to each other enhances network capacity in two ways. One is through higher quality links and, thus, better coverage, especially in the indoor environment, and second is more reuse of limited spectrum spatially. Options for decreasing the transmitter-receiver distance have been successfully exploited in the recent wireless technologies such as: micro cells, distributed antenna systems, relays, WiFi hotspots, and are currently being exploited in 3G and

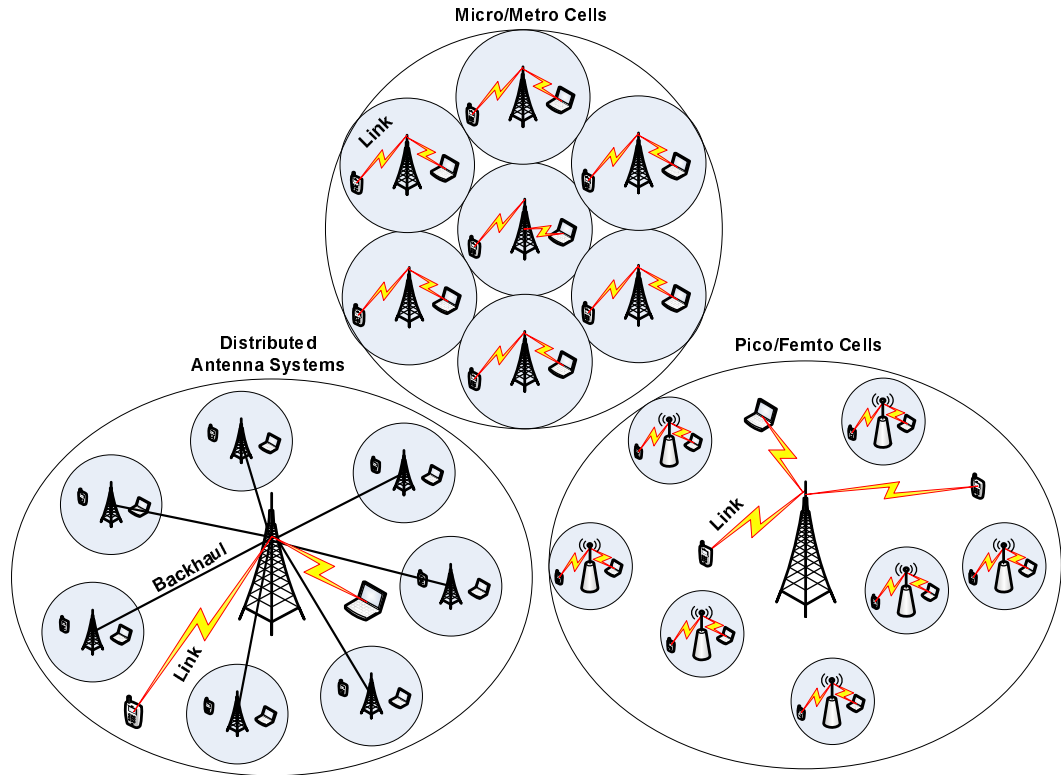

Figure 1.2. Different Small Cells Architectures.

4G cellular technologies through the deployment of femtocells/picocells overlaid by macro cell in the indoor environment (see Fig. 1.2).

In first three technologies, the network operators have complete control over the cells and, therefore, bear the cost of more infrastructure (*capex*) and of more operations on cells and frequency planning and control(*opex*). Although, capacity gains are achieved from shorter range communication between transmitter and receiver, the indoor coverage problem is not completely addressable due the peculiar architectural designs of these technologies.

The last two technologies, i.e., *WiFi* and femtocell/picocell, provide more efficient and low-cost benefits from spatial reuse of the radio spectrum as these are home-sized, very low-powered, and subscriber-operated cells [4], and generally yield signals at the noise level of macro cell. However, as *WiFi* generally operates in *ISM* frequency bands, in order for *WiFi* to work seamlessly in the emerging 4G heterogeneous wireless networks (4G HetNets), the user equipment (UE) should be dual-mode and more sophisticated hardware would be required for its inter-operability with other

technologies. With this view point, the emerging 3G and 4G small cell technologies through the deployment of femto/pico cells overlaid by macro cell in the indoor environment are strong candidates for achieving the research benefits such as: very low power usage, higher quality links, and more spatial reuse of limited radio spectrum. The subscriber gets better signal quality, greater reliability and throughput, and high data rate services. Whereas, the operator achieves greater network capacity, better spectral efficiency, and reduction in the overall network cost.

In view of the above discussion, the important motivating factors of my proposed research are summarized in the following.

1. The pervasively increasing trends of wireless mobile subscribers worldwide and the emerging highly data hungry telecommunication services warrant for consistent improvement in the radio coverage and capacities of existing and forthcoming wireless systems and networks.
2. Improving the radio links, specially in *radio coverage holes*, is necessary for successful deployment (i.e., achieving close to theoretical data rates) of high data rate transmission technologies in the emerging 4G cellular systems and networks.
3. Motivating benefits of the proposed research are: very low power usage, higher quality links, and more spatial reuse of limited radio spectrum. The subscriber gets better signal quality, greater reliability and throughput, and high data rate services. Whereas, the operator achieves greater network capacity, better spectral efficiency, and reduction in the overall network cost.
4. The 4G HetNets with the deployment of user operated small cells, i.e., femto/pico cells, WLANs, can become effective game play for switching the traffic from/to macro-cellular access network to/from the broadband wireline access networks at homes or in the offices, thereby offloading some of the macro cell capacity on to the small cells through the considerably less expensive broadband wireline networks. In this way, it constitutes a potentially very lucrative opportunity for mobile operators to deliver new services.

1.3 Research Objectives

The ultimate objective is a research study on efficient radio resource sharing jointly with the inter-cell interference coordination in the emerging *4G heterogeneous networks (4G HetNets)*. In this regard, my research targets to propose a novel framework of improving the radio resource sharing and inter-cell interference coordination through the enhancement of full/fractional frequency reuse approaches with spatiotemporal exploitation of OFDMA based transmissions. The framework will be comprised of multiple solution components functioning harmoniously in distributed and cooperative manner at individual cell nodes and UEs for dynamic and adaptive spectrum access with orthogonal and/or non-orthogonal channelization. The research on the objective framework would mainly focus on relevant aspects such as follows.

1. Improvement of radio resource utilization, and thus network capacity, by way of effective frequency reuse through exploiting the spatiotemporal diversities among transmissions in OFDMA based medium access control
2. Improvement of two dimensional inter-cell interworking of small and large cells in 4G HetNets, i.e., horizontal across small cell boundaries and vertical within the overlaid large cell, and thus, having the increased dynamics of user mobility and data traffic trespassing the multi-layered cell boundaries
3. The resulting inter-cell interference coordination and the radio coverage and link quality improvement specially in the indoor and congested traffic scenarios
4. The technical and monetary costs of the solution works, where the monetary expense involves infrastructure (capex) and operational (opex) costs, and technical expense involves working complexity and, thus, reliability of the framework, and increased signaling overhead that accounts for latencies and/or inefficient utilization of radio resources.
5. The research work validation plan through analysis and discussion

1.4 Scope of Research

More frequency reuse through closer transmitter and receiver and full frequency reuse approaches in the multi-tier *4G HetNets* for capacity and coverage improvement war-

rants efficient management of the resulting multi-tier cochannel interference (i.e., small-large cells and small-small cells). This issue can be addressed with two approaches. One is to cancel or suppress the accumulated cochannel interference at receiver through hardware provisions such as advanced signal processing and error detection and correction techniques. With this approach, the source of interference, i.e., the interfering transmitter, is not addressed. The work through this approach is usually done at physical (PHY) layer. Second approach is to address the source of interference, i.e., the interfering transmissions and the interfering medium access where the same radio spectrum is multiply accessed under efficient medium access control (MAC) schemes. With the second approach, dynamic and efficient radio resource sharing and scheduling schemes work on MAC layer in order to manage/avoid the interference besides providing capacity enhancement gains through efficiently increasing the radio resource utilization. Motivated with the benefits of second approach, my proposed research study would address the issue of multi-tier cochannel interference through this second approach.

However, generally speaking, the scope of my proposed research is spanned over first two layers, i.e., layer 1 (PHY) and medium access control (MAC) part of layer 2, with some possible network layer assistance, with the defining of functionalities of these layers which are to be improved as a result of this research work and their expected gains in terms of spectrum reuse benefits and inter-cell interference avoidance. Nevertheless, my proposed research is MAC layer-centric. PHY layer contribution is to provide the required information about the dynamics of radio spectrum and of interfering radio entities such as channel state information through spectrum sensing and/or signal measurement reports (MRs), transmission and interference range estimation etc. In my understanding, the network layer assistance may not be required in 4G HetNets that are designed on flat type network architecture, such as in LTE-A, the information flow between the radio access part, i.e., cell node, and the network core part, i.e., mobility management entity (MME) and service gateway (S-GW) in the evolved packet core (EPC), is direct through the relay functionality of cell node gateway, and it can be carried out as layer 2 functionality.

The objective framework of schemes target to empower the functionalities of medium access control (MAC) part of layer 2 mainly with the provision of dynamic

and adaptive scheme for radio resource management, sharing, and scheduling that will work in distributed but coordinated manner at individual cell nodes in coalition with the interfering cell nodes. For this purpose, the framework would exploit the already provisioned functionalities of the underlying standard and will also propose new functionalities where needed.

1.5 Research Proposal Organization

The rest of the report is organized as follows. *Chapter 2* presents my study on the background knowledge and literature survey such as: cellular network components knowledge; *4G HetNet* multi-layered architecture and issues; differentiation between *3G HomNet* and earlier technologies and *4G HetNet* and beyond technologies; a critical study of well-known spectrum access and frequency reuse approaches; and a survey and qualitative analysis of recent works on radio resource allocation and inter-cell interference coordination in 4G HetNets. In *chapter 3*, the research problem is stated with the description of challenging issues, my solution options, choices, and challenges. The chapter also describes the research problem modeling with the defining of important bounds, parameters, and metrics necessary for the problem resolution. In *chapter 4*, I describe my solution approaches and strategies. In this regard, the chapter introduces a novel framework named as *Hybrid Radio Resource Sharing (HRRS)* framework for efficient radio resource sharing along with the analysis and discussion. *Chapter 5* concludes my research thesis by highlighting its contributing aspects and by outlining my future research plans.

Chapter 2

Background and Literature Survey

This chapter covers the study of the emerging 4G HetNets focusing on important aspects relevant to my research objectives such as: a differentiation between 4G HetNets and traditional communication networks; architectural development and standardization of small cells (femtocell) for its co-deployment with the existing 3G technologies such as WCDMA/UMTS (3GPP), cdma2000 (3GPP2), emerging 4G HetNet technologies (LTE-A) and broadband wireless access technologies such as WiMAX; the research related provisions within the standardizations; challenges and technical issues of small cells deployment; radio resource sharing approaches and methods; related research work.

2.1 Differentiation between 4G HetNets and Traditional Cellular Communication Networks

2.1.1 Cellular Network Components Knowledge

Traditionally, a cellular network is differentiated between two major parts as described in the following.

1. *Radio access network (RAN) part:* RAN comprises of all radio specific entities such as *base station (BS)* (also called cell node); *user equipment (UE)* (also called mobile subscriber); *radio controller (RC)* (also called base station controller, radio network controller etc.); and interfaces that connect communication medium between radio entities. The RAN part deals with all the radio related functions such as maintenance of radio connections in the coverage area,

radio transmissions control, radio access control, radio resource allocation, and UE mobility management across the neighboring cells.

2. *Core network (CN) part*: CN comprises of all back-haul network entities such as high performance switches/routers, e.g., *mobile services switches center (MSC)*, *serving GPRS support node (SGSN)*, *serving gateway (S-GW)*; UE location and services/profile registers, security and identity entities, and network operation control entities, e.g., *home/visitor location register (H/V-LR)*, *authentication center (AuC)*, *equipment identity register EIR*, *GPRS register (GR)*, *mobility management entity (MME)*, *enhanced mobile subscriber location center (EM-SLC)*, *operation and maintenance (O&M) entity*. The CN part deals with the functions such as switching and routing calls and data connections to external network, protection and security, and network operation management.

The two major cellular network parts, as mentioned above, have differences in nomenclature, architecture, and in terms of their component entities and their functionalities when seen as parts of 2G, 3G, or 4G cellular networks, and accordingly, have different network planning aspects and requirements.

2.1.2 4G HetNet and Beyond vs. 3G HomNet and Earlier

In homogeneous cellular networks (HomNets), cells are developed in well-planned single-tier layouts with similar characteristics such as transmit powers, antenna patterns, receiver noise floors etc., and are controlled centrally in the network core, whereas the traditional heterogenous wireless networks have been dealing with the interworking of wireless local/metro area networks and cellular networks for last one decade. On these parameters, 3G and earlier cellular systems can be categorized as HomNets, and there interworking with other wireless networks such as WLANs and WiMAX, constituted traditional heterogenous wireless networks.

As envisioned in 4G standardizations that are carried out by 3G Partnership Projects (3GPP/3GPP2) and IEEE organization, the emerging and the future cellular systems and networks such as LTE-A, IEEE 802.16m (WiMAX), are based on a new paradigm in cellular networks domain, named as 4G heterogenous wireless network (*4G HetNet*). *4G HetNet* are aimed for a big leap of achieving huge capacity, speed, and coverage gains in order to meet with the service requirements of

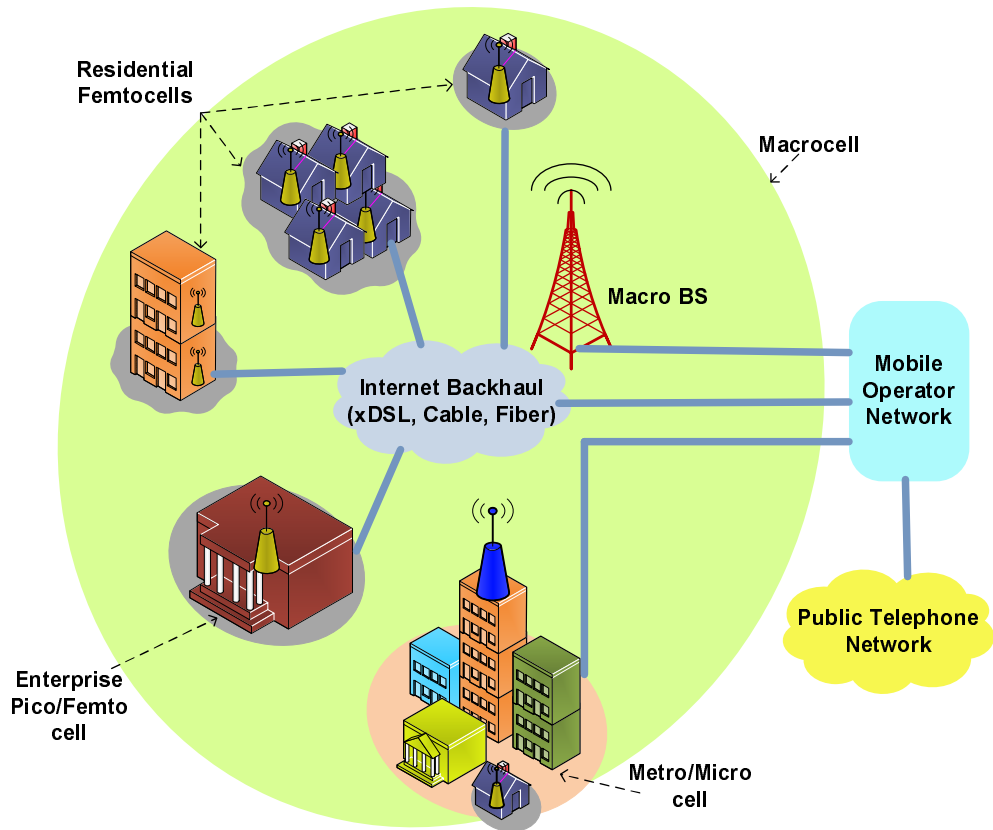

Figure 2.1. *4G Heterogenous Cellular Network (4G HetNet) Topology.*

highly data hungry applications specially in coverage holes, i.e., indoor environment, inter-cell boundaries, and thickly populated areas such as center of metro cities. The HetNet is a complex multi-tier cellular topology where multiple cells are developed with dissimilar characteristics such as radio frequency entities with varying transmit powers, transmission and radio access technologies, individual cell architectures etc. Small cells with low powers (typically $\sim 10mW - 5W$ per carrier) such as femtocells, picocells, microcells/metrocells, are combined with the improved and densified large cells, i.e., macrocell, with high powers (typically $\sim 20W - 40W$ per carrier). This heterogenous combination of small and large cells wherein the same radio spectrum is shared in the same geographical area, is managed by the same operator.

In short, a 4G HetNet is a mix of multi-layered cells where the layer of well-planned high power large cells, i.e., macrocells, is overlaid with the layers of less-planned low power small cells, i.e., femto, pico, micro/metro cells [7][8]. In some cases, a HetNet may also contain integrated femto/Wi-Fi solutions, remote radio

Table 2.1. *Differentiation between HomNets and HetNets.*

	HomNets	HetNets
Cell site planning	Single layered large cells (macrocells) pre-planned by the operator, thus deterministic number and locations of cells	Multi-layered cells, where large cell (macrocell) layer and a part of small cell layer (micro/metro cells) is pre-planned by the operator, and the remaining part of the small cell layer (indoor femto/pico cells) is subscriber-planned and deployed, and thus has non-deterministic number and locations of small cells.
Spectrum/frequency planning, i.e., frequency reuse factor (FRF), for inter-cell interference coordination (ICIC)	Statically pre-calculated by the operator in the central control, usually $FRF = 3, 4,$ or 7 , with reciprocating frequency reuse gains	Inter-macro layer same as in HomNets, however, due to the self-organizing and self-optimizing capabilities of small cell nodes, centralized and static frequency planning not feasible
Capacity enhancement through spectrum reuse	Cost-inefficient due to heavy capital and operational expenses (Capex, Opex) of new macrocell infrastructure	Cost-efficient due to minimal capex/opex expenses of new self-organizing and self-optimizing small cell infrastructure
Coverage enhancement	Coverage holes (indoor and metro public areas) not necessarily eliminated	Coverage holes (indoor and metro public areas) mostly eliminated due to close proximity of transmitter and receiver both in the indoor environment
Radio resource allocation	Centrally controlled by the operator through static spectrum and transmit power allocation schemes	Scalability and complexity issues with complete central control of the operator due to heavy overhead of signaling and latencies, and static spectrum and transmit power allocation schemes not feasible due to the increased dynamics of multi-layered interworking of heterogenous cells
UE mobility management	Centrally controlled by the operator through simple hand-off/hand-over (HO) schemes	Central control by the operator not feasible due to increased frequency of HOs in two dimensions, i.e., in the intra-layer cells and in the cross-layer cells

heads (RRH) and/or relay nodes. A typical 4G HetNet topology is illustrated in Fig. 2.1. However, a comparative analysis carried out in [9] shows that the small cell deployment in 4G HetNets offers significantly better user experience, system capacity improvement, and better support for mobility/handoff, QoS, security, self organizing network (SON) capabilities, than Wi-Fi deployed 4G HetNets.

A qualitative differentiation between 3G and earlier cellular networks (HomNets) and 4G HetNets with respect to planning and control is given in Table 2.1.

2.2 Small (Femto) Cell Architectural Standardization

Third Generation Partnership Project (3GPP) and Broadband Forum (BBF) are two standard development organizations (SDO's) shaping the standard for femto cell for 3GPP (i.e., UMTS/WCDMA). 3GPP2 and BBF are SDO's shaping the femto cells for cdma2000 [12]. Besides, as non-SDO, Femto Forum (later named as Small Cell Forum) and Next Generation Mobile Network (NGMN) took active role. WiMAX Forum [20] is an other standardization body for shaping femto cells for WiMAX deployment. It is the adapted and customized version *Iu* architecture called *Iuh* interface in 3GPP femtocell architecture, however, there is no such analogous interface in 3GPP2 femto cell [12]. Different architectural aspects of femto cells are demonstrated in Fig.2.2 and explained in the following.

2.2.1 3GPP Femto Cell

The *Iuh* interface (based on *IuPS* and *IuCS* for packet and circuit services respectively) and the BBF TR-069 family of standards (for femto cell device management) constitutes 3GPP femto cell architecture. However, 3GPP2 suggests that legacy voice/circuit services for femto cells can best be provided using a Session Initiation Protocol (SIP)/IP multimedia subsystem (IMS) based core network (CN) architecture with the SIP user agent (UA) in the femto cell base station (FBS) itself. In 3GPP specifications (Release 9), considerations are to integrate better with IMS-based CNs [11].

- 3GPP defined Home Node-B (HNB/FBS) interface corresponding to the Node-B interface, i.e., BTS (base transceiver station), in 3G macro cell architecture (UMTS). HNB works as customer premises equipment (CPE) that interfaces with the handset by standard air interface Uu and interfaces to the operators network over the Iuh (by Femto forum) interface.
- 3GPP specifications define four traffic types QoS: conversational, streaming, interactive, and background. Since femto cell is being deployed using non-dedicated fixed broadband technology such as xDSL, QoS aspect requires special

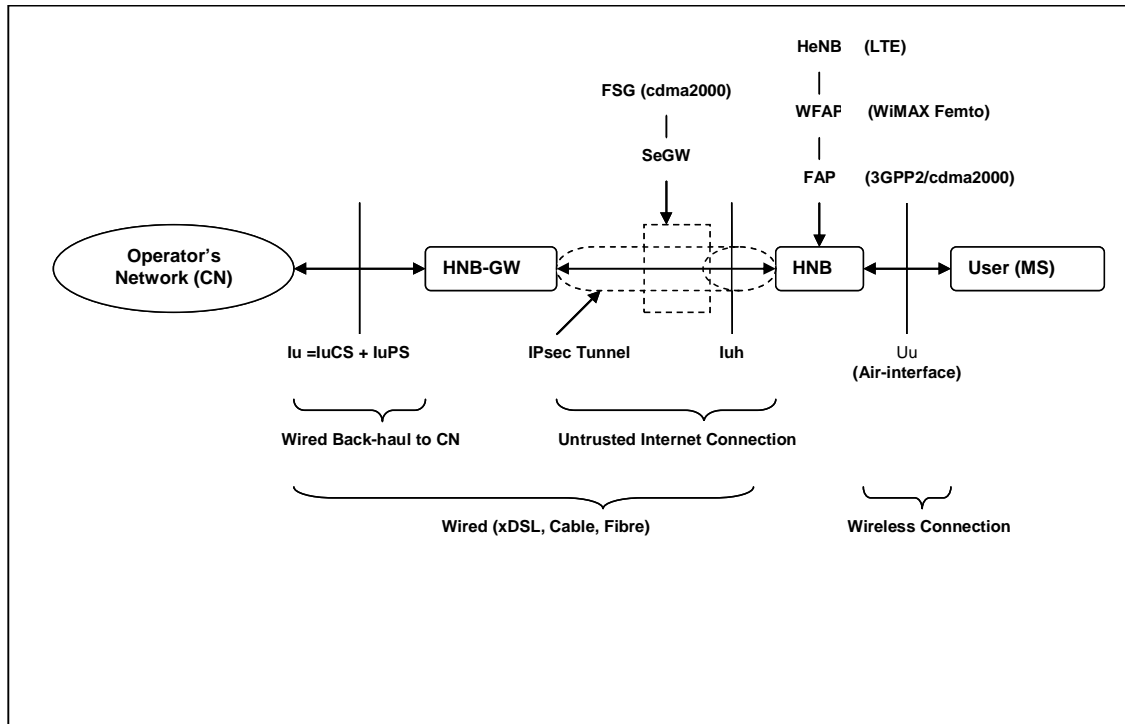

Figure 2.2. Femto cell Architecture (3GPP, 3GPP2, WiMAX).

attention to preserve and maintain service quality, specially in the up link which has usually less quality.

- Management: The BBF has created TR-069 specifications that define a generic framework to establish connection between the CPE (HNB) and the automatic configuration server (ACS) to provide auto-configuration of the CPE. Fundamental functionalities of TR-069 are:
 - Auto-configuration of the CPE and dynamic service provisioning
 - Software/firmware management and upgrade
 - Status and performance monitoring
 - Diagnostics

2.2.2 3GPP2 Femto Cell

It deals with the cdma2000 family of standards. Voice services in femto cell 3GPP2 are to evolve toward an all-IP architecture based on SIP signaling from the FBS and IMS core network where the femto cell convergence server (FCS) acts as IMS application server in the capacity of a gateway for the FBS. Femto security gateway (FSG) in 3GPP2 is analogous to the security gateway (SeGW) in 3GPP [12].

- Femto AAA provides access, authorization, and accounting functions for FBSs.
- The FCS serves as a gateway between the SIP/IMS core network (with which the FBSs communicate to obtain legacy circuit services) and the actual ANSI-41 MAP legacy core network.
- Femto cell management system (FMS) in 3GPP2 is closely aligned to the HMS in femto cell 3GPP and provides management and configuration functions for the FBSs.
- The 3GPP2 Enhanced System Selection (ESS) capability allows enhanced 1x MS or EV-DO access terminal (AT) devices to be provisioned with new data structures that will greatly improve the ability of mobile devices to discover and register with authorized femto cell devices as quickly and efficiently as possible.
- Minimum performance specifications (MPS) for macro BSs are inappropriate for low-cost low-power femto cell devices. 3GPP2 is undertaking following work items to modify the MPS specifications for femto cell devices.
 - Support for single-antenna femto cell devices (i.e., without receive diversity)
 - Modified receiver dynamic range
 - Relaxation of receiver sensitivity
 - Inter-modulation spurious response attenuation
 - Single tone desensitization
 - Transmitter frequency tolerance
 - Spurious emissions
 - Femto cell output power classes
- In [21], cell selection and re-selection ways and criterion by the MS's are discussed with a view on the pilot signal and beacon design.

2.2.3 WiMAX Femto Cell

The first phase of WiMAX femto cell architecture in which the MS has either no support or is just aware of the femto cell is based on IEEE 802.16Rev2, network release 1.6, and system profile release 1 or 1.5 [20]. The second phase of WiMAX Femto cell deployment that would provide full network and MS support is to be introduced in the network Release 2 based on 802.16m air interface. WiMAX network architecture for femto cell systems [13] is based on the WiMAX basic network reference model that differentiates the functional and business domains into NAPs (network access provider) and NSPs (network service provider) respectively, where:

- The NAP is a business entity that provides and manages WiMAX radio access infrastructure and is composed of access service networks (ASNs) gateways and BSs
- The NSP is the business entity that manages user subscriptions and provides IP connectivity and WiMAX services to subscribers according to negotiated service level agreements (SLAs) with one or more NAPs. NSP includes home agent, authentication, authorization, and accounting (AAA), and other relevant servers and databases.

Issues and requirements for WiMAX femto cells are as follows.

- Local area coverage
- Stand-alone femto cell network operation
- Self-organization/self-configuration
- Operator controlled remote integration, activation, and deactivation
- Synchronization and interference management
- Exclusive or preferential access
- Differentiated accounting
- Scalability and density
- Handover

Deployment model for FBS: Following are FBS deployment modes.

- A single operator with both macro and femto cells

- A single operator with femto cells only: A femto-NSP and femto-NAP may be deployed and managed by the same business entity as an independent network.
- A femto cell operator providing access only: Such a femto cell network with a femto-NAP and femto-NSP may be deployed independently by the femto cell access provider that has a business relationship with one or multiple NSPs to deliver their services.

Synchronization methods in Femto cells: In femto cells, synchronization methods can be categorized into two following types.

1. Network-based: such as IEEE 1588, Network Time Protocol (NTP) (RFC 1305), Simple Network Time Protocol (SNTP) (RFC 2030)
2. Air-interface-based such as GPS and air-interface snooping: Snooping synchronization channels (i.e., preambles) from the neighboring macro cell BSs is a simple but accurate solution to self-synchronizing femto cells without any additional hardware [20].

2.2.4 OFDMA Femto Cell

In OFDMA Femto cells Deployment, following main challenges and their solutions are addressed in [10].

1. Interference avoidance among FBSs and MBSs: OFDMA femto cells can exploit channel variations in both frequency and time domains for the avoidance of interference using orthogonal sub-channels, while CDMA can only exploit the time domain using the Pseudo random codes.
2. Spectrum resource allocation:
 - One solution is the orthogonal channel assignment, i.e., divide the licensed spectrum into two exclusive parts one for the macro cell and the other for the femto cell that completely eliminates the cross-layer interference but is not efficient in terms of spectrum reuse.
 - Other solution is the cochannel assignment to macro and femto layers that can be made efficient with robust technical approaches such as: centralized sharing at the macro cell (such as the spectrum may be divided into x

subgroups, the macro cell uses all the groups while each femto cell picks a group randomly reducing the collision probability by a factor of x) or distributed channel sharing at each femto cell that may be cooperative or non-cooperative.

The methods of self-configuration and self-optimization are proposed in [10] for OFDMA femto cell deployment. Due to the non-deterministic scenario with regards to femto cells number in the neighborhood and their locations, femto cell technology certainly needs efficient self-configuring and self-optimizing techniques to avoid/mitigate interference and fading. It would require sensing the air-interface and tuning the parameters to adapt to the variant channel and network conditions (i.e., network architecture, load, interference and fading). Following course of actions is suggested in [10] in this regard.

- Sensing Phase: For distributed cooperative spectrum assignment, spectrum sensing or network listening capability in the FBS is one option. And second option is the information exchange among the neighboring FBSs. Question would then be whether the information exchange should be through the FBS gateway (such as X2 interface in LTE) or directly broadcasting or relaying through the MSs. These ways are not helpful in case of hidden terminal scenario. Measurement reports (containing information such as received signal strengths and active sub-channels) that can avoid hidden terminal problem is the 3rd option that are periodically performed by the MSs and sent back to FBSs. Other way-outs such as the number of mobility event and packet drop rate can consolidate the sensing phase.
- Tuning Phase: It involves self-configuration and self-optimization with the difference that self-configuration does the initial setting of FBS to some default parameters and self-optimization updates the configuration of FBS in order to adapt its parameters to the environment.

2.3 Challenges and Technical Issues of Small Cells Deployment

In order to achieve desirable coverage and capacity with the spectrum reuse, following are important challenges and issues that the developing 4G cellular systems need to overcome before its wide-spread deployment can take place [11][10][25].

1. Indoor small cells have core issue of interference mitigation and management that includes inter-tier and intra-tier cochannel and adjacent channel interferences as, unlike large cells, there is no centralized and coordinated radio planning and control in indoor small cells.
2. Most of the radio related configurations such as maximum transmit power, primary scrambling codes, and UMTS absolute radio frequency channel number (UARFCN) in case of UMTS service operator, for a specific small cell need to be determined on a case to case basis in order to minimize interference with the surrounding cells. Adjustments and changes in the radio configurations to conform to the changing radio environment is also a major concern. For this purpose, features such as radio resource measurement and radio environment measurement (REM) or *HNB Sniffer* are envisioned in small cells [23][22].
3. Due to full frequency reuse in large and small cells, and unknown number and positions of small cell nodes, the traditional planning and optimization techniques will not help. Therefore, to mitigate this impact, several aspects of this new technology such as the access methods, frequency band allocation, timing and synchronization, and self-organization, need further investigation before these get widely deployed.
4. Time synchronization is needed to minimize multi-access interference, improper cross-tier hand-offs, and carrier frequency offset. Timing offset may be resulted due to the overlapping of uplink and down link periods of different cells causing inter-cell interference. Time base that is immune to packet jitter is difficult with an IP back-haul. In this context, ranging procedures to achieve timing (1 micro sec) and frequency accuracy (250 ppb) are needed for two reasons.
 - Loss of subcarrier orthogonality due to the inter-carrier interference caused by carrier offset and frequency errors of handsets having poor oscillators

- In TDD systems, small cells will require an accurate reference for coordinating the absolute phases for forward and reverse link transmissions and bounding the timing drift.
5. The reuse of physical cell identity (PCI) which is normally used to identify a cell for radio purposes among the neighboring small cells causes PCI confusion.
 6. Neighboring cell list would need dynamic management.
 7. Increased hand-overs (small to large cells) and hand-ins (large to small cells), due to the short range in small cells, cause increased network signaling and more challenges, specially on hand-ins. Although, 2G and 3G systems broadcast neighboring user lists, these technologies are not scalable to account for a large number of underlying small cells. Thus, 4G systems should address this issue. In open access small cells, channel fluctuations may cause a passing mobile equipment to perform multiple handovers. Thus, an open research area is to develop low complexity algorithms for predicting the dwell (sojourn) time and mobility patterns for defining velocity thresholds before handing off a mobile equipment onto a nearby small cell.
 8. System selection and access control
 9. Management, user installation, auto-configuration, plug-and-play
 10. Security aspects
 11. Network architecture and scalability
 12. Network and frequency planning
 13. Integration with the operator's core network
 14. Miniaturization, product cost reduction, design of integrated components, architectures and components for low-cost radios to be deployed in small cells
 15. Regulatory constraints and minimum performance radio requirements, including output power requirements, timing accuracy requirements, and out-of-band emission requirements: such as detection and verification of the physical location where the small cell is being installed as part of the service authorization step during possibly each initialization is a major regulatory concern. For this purpose, location/position determination methods for radio entities are being envisioned in LTE/LTE-A standardizations [26][27].

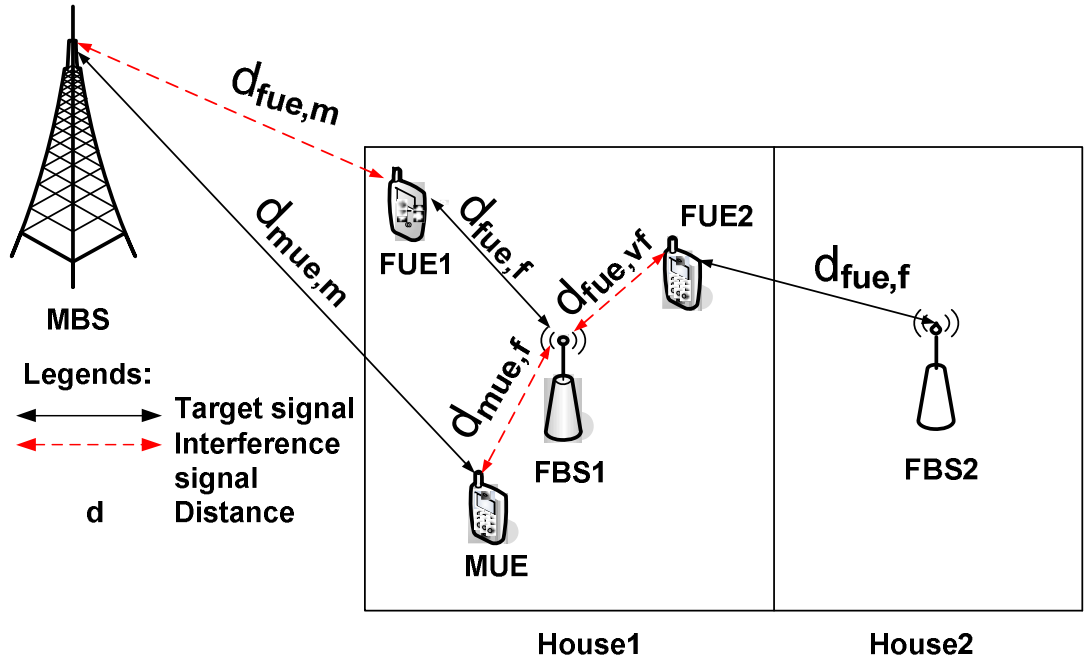

Figure 2.3. Typical Cochannel Interference Scenarios in 4G HetNets.

2.3.1 Potential Interference Scenarios

With full frequency reuse approach, the challenge of inter-cell interference cooperation becomes very important. Fig. 2.3 illustrates six typical cochannel interference scenarios as studied in detail in [86]. In the down-link, the signal from macro base station (MBS) may interfere with femto cell user equipment (FUE) which is in the direct bore-sight of MBS, and signal from femto cell base station (FBS) may interfere with the visiting macro cell user equipment (MUE) or FUE. In the uplink, the signal from a close-by FUE which is in close proximity of MBS in its direct bore-sight may interfere with MBS reception, and signal from a visiting MUE or FUE may interfere with FBS reception. Interference across the inter-tier, i.e., macro cell and femto cells, is due to near-far effect of uneven distribution of received power and is more challenging, while interference across intra-tier, i.e., small-small cells, has relatively smaller intensity due to low transmit power and low penetration losses.

Among all typical 6 interference scenarios in Fig. 2.3, the femtocell downlink cochannel interference to the MUE receiver is more challenging and worthy of our interest. In this scenario, MUE(s) is located in the same room where FBS is located which is fully loaded in the down-link, i.e., transmitting at full transmit power limit.

The capacity reduction in the MUE reception over the shared carriers due to the FBS is up to 16%, and it can be reduced to 2% if MUE is engaged on an adjacent channel. To avoid this interference the operators should have dedicated carrier that is only for the femto cell or adaptive CPICH (common pilot channel) power control should be used within the femto cell to balance the macro cell coverage.

Femto cell down-link cochannel interference to the FUE receiver is another challenging scenario. Femto cell user lives close to other femto cell users and there is at least one wall between the two femtocells/apartments, i.e., a FUE visits the neighboring house/apartment, so there is a cross-wall penetration loss for the visiting FUE. In this way, the throughput of the femto cell in the down-link will be affected by the down-link of neighboring femto cells and may result in dead zones in extreme cases. The use of adaptive pilot power control can help in mitigating this interference to some extent by making the femto coverage to single apartment only. In such a case, the visiting FUE can be handed over to the macro cell.

In the scenario of femto cell uplink cochannel interference to nearby FBS receivers, if no power management is deployed, this visiting FUE interference could reduce the effective range of the visiting femto cell.

2.4 Research Related Provisions for Small Cells Deployment in 4G HetNets

High frequency ranges in CDMA based 3G systems cause attenuation and deterioration of the signal quicker once the signal reaches indoors. Also, the effective cell capacity of WCDMA is interference limited. With these two problems, the effective data rates in macrocell environment are much less than the theoretical maximum data rates [11]. The drawbacks of CDMA based air-interface technologies are overcome to an extent in the orthogonal frequency-division multiple access (OFDMA) based air-interface technologies which can exploit channel variations in both frequency and time domains with fine granularity using orthogonal sub-channels, whereas the CDMA can only exploit time domain using pseudo random codes. With this characteristic, OFDMA has better intra-cell interference avoidance property and robustness to multipath fading [10]. Due to these benefits, OFDMA is provisioned in almost all the

emerging higher data-rate 4G cellular standardizations such as Long Term Evolution (Advanced) (LTE/LTE-A) and IEEE 802.16m (WiMAX).

When capacity, i.e., high traffic volume, is the driving potential or the spectrum is too limited to simply fulfill the requirement, then efficient reuse of spectrum is considered inevitable through cell planning and radio resource management for controlling the inter-cell interference. For example, with regards to inter-cell interference control, cooperation schemes between the co-layer/cross-layer cells such as *soft handover* in WCDMA release-99, *inter-cell interference coordination (ICIC)* in LTE release-8/9, and *enhanced inter-cell interference coordination (eICIC)* in LTE-A, are provisioned.

2.4.1 Frequency Partitioning/Reuse Approaches

The *ICIC* techniques exploit only frequency domain through partial use of radio spectrum, i.e., frequency partitioning, and/or transmit power domain through link power adaptation. Whereas, the *eICIC* scheme along with the advanced interference cancellation (IC) capabilities in the terminal receivers enables operators to deploy low-power small cells under the coverage of high-power macro cells using same channel. The typical frequency partitioning methods used for *ICIC* and *eICIC* techniques are briefly explained in the following [83][15][16][17].

1. **Full Frequency Reuse:** There is no frequency partitioning, i.e., frequency reuse factor (FRF) is 1, among the macro BSs of the same network, and each macro BS transmits with uniform power using the entire system bandwidth substantially creating inter-cell interferences at the cell edges both in the down-links and in the up links. The 4G small cells such as femto cells, have been provisioned with this approach under the name *Cochannel Deployment*, wherein the same spectrum is reused simultaneously among the radio frequency (RF) entities of macro cell and femto cells in the same geographical area.
2. **Hard Frequency Reuse:** In this approach, which is typically used in GSM and LTE release 8/9, the entire sub-carriers are partitioned into 3, 4 or 7 disjoint sets, i.e., with FRFs of 3, 4 or 7 respectively, and are assigned to the individual macro BSs in such a way that any adjacent macro cells pair must use disjoint, i.e., orthogonal, set of partitioned sub-carriers. This approach is the basis for cell clustering engineering. This approach maximally eliminates

cell edges interference but causes decrease in the spectrum reuse efficiency by a factor equal to FRF. The 4G small cells such as femto cell technology, has been provisioned with this approach under the name *Dedicated Channel Deployment*, wherein femto base stations (FBSs) and the macro base station (MBS) utilize radio spectrum orthogonal to each other, and there is no spectrum re-use benefits and no co-channel interference issues.

3. ***Fractional Frequency Reuse:*** With this approach the system bandwidth is divided into two parts. One part is used through *Full Frequency Reuse* method, typically for the central cell UEs, and the second part is used through *Hard Frequency Reuse* method, typically for the cell edge UEs. Therefore, this approach combines the benefits of the first two methods while avoiding their drawbacks, and is useful in the uplink scenario where cell-edge UEs experience severe inter-cell interference. The 4G small cells such as femto cell technology, has been provisioned with this approach under the name *Partial Cochannel Deployment*, wherein some parts of radio spectrum utilized by the FBSs are orthogonal to that of the MBS, while other parts of radio spectrum are shared among FBSs and MBS.
4. ***Soft Frequency Reuse:*** This is the same as *Full Frequency Reuse* approach but with the use of non-uniform transmit power spectrum, and is useful in the down-link.

These frequency assignment approaches adopted in the conventional cellular concept are static, i.e., these take place after careful planning as long term configurations, and these does not take into account network dynamics through active information exchange among the interfering nodes. The HetNets can exploit these approaches through dynamic configurations with the network information exchange that can be done with separate signaling interface *X2* which is provisioned for *eICIC* functionality in each 4G HetNet node both in frequency and time domains [18][19].

2.4.2 Access Modes in 4G HetNets

With *cochannel/full* and *partial/fractional cochannel deployment* approaches, exploring the spatiotemporally available spectrum is easy by enabling spectrum sharing

among the radio frequency (RF) entities in the same geographical area. In particular, these two approaches can be adopted under one of the last two service access modes described in the following, which specifically define how an individual cell node would respond in a given cochannel interference scenario [20][10][21].

- ***Closed service group (CSG)***: This group is not open for public access such as a home deployment. In this mode, a macro cell user equipment (MUE) may camp on a small cell node (FBS) but not necessarily allowed to make or receive calls through the small cell node [24].
- ***Open access mode***: This mode is open for public such as in hospitals, shopping malls etc. Admission control and the QoS policies are same as in the macro cellular network.
- ***CSG-open/hybrid mode***: In this mode, public users can be admitted for limited services and QoS besides providing full services to CSG members.

The *open access* mode provides opportunities for hand-offs and hand-ins, and thus leading to a higher degree of freedom in manipulating the available spectrum. The *closed service groups (CSG)* mode imposes restrictions on close-by visiting user equipments (UEs) which does not help in avoiding cochannel interferences through hand-offs.

For the deployment of roughly planned small cells along with the well-planned macro cells in 4G HetNets, the envisioned *self organizing network (SON)* features include *automatic neighbor relations (ANR)*, *mobility robustness optimization (MRO)*, and *mobility load balancing (MLB)*. The ANR feature helps automatic discovery of new neighbor cell node with the UE assistance. The MRO feature finely tunes the mobility parameters, i.e., handover hysteresis and trigger-time, in order to monitor failed handovers, while the MLB feature tunes the handover thresholds between macro cell and small cells for balancing the load among them.

2.4.3 Radio Resource Measurement

The radio resource (signal) measurement in LTE networks may have multiple objectives such as to mitigate interference (co-channel or adjacent channel) and to maintain the coverage. Connected Mode UEs attached to the FBS and DL receiver function

within the FBS, also called Network Listen Mode (NLM), Radio Environment Measurement (REM) or "HNB Sniffer", are a few ways to collect some types of measurements [22].

Measurements such as cochannel and adjacent carrier RSSI is performed at FUEs to calculate down-link interference from the neighboring cells, and similar type is CPICH E_c/N_0 that HUEs perform to calculate down-link interference from nearby MBS. Receive total wide-band power (RTWP) measurement is performed by the FBS at its physical layer to calculate the uplink interference from nearby MUE(s) [22]. In case of LTE, i.e., (HeNB), the FBS uplink receiver carry out the measurement called received interference power to calculate the uplink interference from nearby MUE(s) [23].

There are some measurement types which are made as decoded system information IEs, performed by FBSs such as: PLMN ID, cell ID, location area code (LAC), routing area code (RAC). Purposes of such measurements are: identification of operator and surrounding MBSs, and distinction between MBS and FBS [22]. In case of LTE, i.e., (HeNB), the FBS down-link receiver carry out the measurements to obtain cell reselection priority information in closed subscriber group (CSG) status and cell ID for distinction between cell types, cell layers, based on frequency layer priority and on CSG respectively, and for self-construction of neighbor list [23].

Measurements such as cochannel and adjacent-channel CPICH RSCP are performed by FBSs to calculate down-link (to MUEs and neighboring FUEs) and up-link (MBS and neighboring FBSs) interferences from nearby FBSs and FUEs. P-CPICH Tx power is the measurement made as decoded system information IEs, rather than a direct physical layer measurement, in order to calculate the path-loss to MBS [22]. In LTE, the FBS carry out measurements from its surrounding macro cells and neighboring FBSs, such as: reference signal received/transmit power (RSRP/RSTP), co-channel reference signal received quality (RSRQ), physical and global cell ID (PCID and GCID), for calculation of DL/UL cochannel interferences across the inter-tier (macro-femto) cells and the intra-tier (femto-femto) cells respectively [23]. In a CSG deployment, one technique is to utilize location area update/routing area update procedure for performing UE authentication.

2.4.4 Range Measurement of Radio Frequency (RF) Entities

In this section we describe briefly the purpose, approaches, performance metrics, topologies, and the underlying technologies, both in the research academia and in the standardization efforts in 3GPP (LTE-A), that corresponds to the up to date developments in range calculation/estimation of radio frequency entities.

The purposes of UE positioning is categorized as in the following [26].

- Calculation of the geographical position and/or velocity of a UE
- UE positioning knowledge can be useful for a number of applications/services such as Radio Resource Management (RRM), location-based services (LBS).

There are be two phases of the range measurement of the UE, i.e., one is signal measurements, and second is position estimation and optional velocity computation based on the measurements.

2.4.4.1 Major Positioning Approaches

As stated above, signal measurement is first and important step in positioning the UE. However, the performance of the system is directly dependent on the accuracy of wireless signal measurement which is very difficult, especially in the indoor environment due to severe multipath from numerous reflecting surfaces, non-line of sight (non-LOS), moving objects etc. Therefore, there is no good model that can account for indoor radio multipath precisely [37]. There are three following positioning approaches adopted in the research academia. These approaches use a number of technologies each with the variety of techniques proposed in the literature which are cited against each technology for ready reference.

Triangulation: In this approach geometric properties of triangles are exploited. Triangulation has two sub-approaches. One is called **Lateration** (also called range measurement techniques). Lateration is an approach for calculating the position of an object from multiple reference points instead of directly calculating through RSS. It uses technologies such as: time of arrival (TOA) [38][38][39][40][41][42], time difference of arrival (TDOA) measurement [43][44][38][45]; computing the attenuation of the emitted signal strength (i.e., RSS based) [46][47]; multiplying the radio signal

velocity and the travel time; Round-trip time (RTT) of flight (RTOF) [48][49][50][51]; received signal phase [37]. The second sub-approach is called **Angulation** (AoA or DoA). Angulation locates an object by computing angles relative to multiple reference points, i.e., the intersection of several pairs of angle direction lines, each formed by the circular radius from a base station or a beacon station to the mobile target. This method would need directional antennae or an array of antennae. Details of angulation methods can be found in [52][53].

Scene Analysis: features, i.e., fingerprints, of a scene that are somehow location dependent are collected as a priori information and then online measurements of the target object are matched with the closest a priori location fingerprints to estimate the target location. Usually, RSS-based location fingerprinting is deployed in scene analysis. Indoor environment is not efficient due to diffraction, reflection, and scattering affecting the received signal strength measurement. Location fingerprinting-based positioning algorithms that use pattern recognition techniques are: probabilistic methods [54], k-nearest-neighbor (kNN), neural networks, support vector machine (SVM) [55][56][57], and smallest M-vertex polygon (SMP) [58].

Proximity: Proximity algorithms are symbolic in nature for relative location measurement. Most of the times, these deploy a dense grid of antennas with known position. The proximity of a mobile target to a specific BS/antenna is considered relatively with other BSs/antennae with regards to RSSs at these BSs/antennae. The target mobile is considered to be co-located with the BS/antenna that has comparatively higher RSS. Proximity algorithms may use different physical media such as: infrared radiation (IR), and radio frequency identification (RFID) [59][60]. Another example of proximity algorithms is the cell identification (Cell-ID) or cell of origin (COO) method [61][62]. The approximate position of a UE is found with the knowledge of cell-ID of the cell site the UE is currently residing in.

2.4.4.2 Mobile Positioning in LTE-A

Standard positioning methods defined in LTE-A are [26]:

1. Network assisted Global Navigation Satellites Systems (GNSS): Examples are

GPS and modernized GPS [28][29][30], Galileo [31], GLONASS [32], Quasi Zenith Satellite System (QZSS) [33], and Satellite Based Augmentation Systems (SBAS) [34].

2. Down-link Positioning: Downlink positioning methods make use of the measured timing of downlink signals received from multiple BSs at the UE using the assistance data received from the positioning server along with knowledge of the geographical coordinates of the measured FBSs and their relative downlink timing. The UE make use of assistance data received from the E-SMLC such as: physical cell IDs (PCIs) and global cell IDs (GCIs) of candidate cells for measurement, timing relative to the serving FBS of candidate cells. Similarly, FBS may transfer assistance data to the E-SMLC such as: PCI and GCI of the cells under the FBS, timing information on the FBS, and the geographical coordinates of the FBS. UE may also transfer these information to the E-SMLC.
3. Enhanced cell ID methods: The position of a UE in the Cell ID (CID) positioning method is estimated with the knowledge of its serving BS, i.e., its geographical coordinates, and cell. This knowledge is obtained by paging, tracking area update, or other methods. Enhanced Cell ID (E-CID) positioning refers to techniques which use additional UE and/or E-UTRAN radio resource and other measurements to improve the UE location estimation. UE measurements may include RSRP, RSRQ, the time difference between UE receiver and transmitter. E-UTRAN measurements may include the time difference between FBS receiver and transmitter, Timing Advance (TADV), and AoA [35][36].
4. Hybrid of any of these methods is also supported.

2.5 Channel Assignment Strategies

First of all, the difference between the *channel assignment (CA)* and *frequency planning (FP)* should be noted. Channel assignment strategies define how the available channels are efficiently allocated or utilized. Whereas, frequency planning is determining and making arrangements of the minimum number of channels required to accommodate the traffic demand given the traffic profile of the system and predefined quality of service (QoS) parameters such as blocking or dropping probabilities,

transmission speed, delays. Since channel assignment strategies are more worthy of interest and of relevance to the context of this survey, a brief discussion of well-known and well-studied CA strategies is given in the following. However for detailed insight, the reader may refer to [63][64][65][66] and to the references therein.

2.5.1 Fixed Channel Assignment (FCA)

This is the basic and far most CA strategy in which a group of equal number of channels is assigned to each cell as a long-term configuration following a fixed channel reuse pattern through static cell clustering patterns. Due to its static and uniformity nature, the FCA does not conform to the changing behaviors of traffic and users in time and space as is the practical case in mobile networks, and thus gives poor radio resource utilization efficiency and increased call blocking and call dropping probabilities. In this regard, a variety of solution strategies are adopted within FCA. Without going into details, two major approaches among others are worth mentioning. One is *load sharing* in which cell-edge calls, and thus traffic load, of a congested cell is transferred over to the spare channels of a neighboring cell that has overlapping cell-edge areas through hand-overs, thereby creating space to accommodate new calls. Second is *channel borrowing* in which instead of handing over the calls to neighboring cells, spare channels are borrowed from cell-sectors or from neighboring cells to accommodate excessive calls. Limitations of FCA schemes are: the central controller has to keep the updated global knowledge of the dynamics of channel utilization and traffic condition which may lead to a slow response and heavy signaling overhead; FCA require complex and labor intensive frequency planning.

2.5.2 Dynamic Channel Assignment (DCA)

This CA strategy requires no planning (i.e., no long-term configuration) of channel reuse. Instead of pre-assignment of channels to the cells as is the case in FCA, all channels are kept in the central pool, and a channel or a group of channels is dynamically assigned to a particular cell only for the duration of calls, and after completion these are returned to the central pool. Thus, a channel can be used in any cell provided the SINR constraints are satisfied. The basic approach of a DCA scheme

is determining the cost of usability of all the available channels and then selecting the least-cost channel for usage that can fulfil the minimum SINR requirement. The cost function usually accounts for, but may not be limited to: future blocking/dropping probability, channel occupancy distribution under current traffic conditions, frequency of usage of candidate channel, frequency reuse distance, radio resource measurements at radio entities. DCA schemes using such an approach are termed as call-by-call DCA schemes. However, an adaptive type DCA also takes into account the past traffic conditions and other statistics. Although, DCA schemes attempt to alleviate the limitations of FCA strategies, there is always a trade-off among certain basic metrics such as quality of service (QoS), implementation complexity of the scheme, radio resource utilization efficiency etc. DCA needs knowledge of channel occupancy in other cells but FCA does not. Therefore, high speed computing and signaling is needed in DCA to counter the increased call set up delays.

Due to its more flexible nature in controlling the channel assignments, DCA schemes are primarily differentiated into two following main categories.

2.5.2.1 Centralized DCA (C-DCA)

In C-DCA, the central controller assigns channels to cells as is the case in FCA, but the difference is that this channel assignment is temporary on short-term basis until the connection call is over and is decided based on the evaluation of a cost function. C-DCA schemes are considered capable of providing near-optimal CA, however, trade-off cost of increased complexity and centralization overhead is high. Specially, in case of high-speed heterogeneous mobile networks C-DCA approach may not be viable where very dynamic and two dimensional inter-cell inter-working of multi-layered cells, i.e., vertical across macro and small cells and horizontal across asymmetrically located and asymmetrically powered small-small cells, is required.

2.5.2.2 Distributed DCA (D-DCA)

In D-DCA, there is no central controller and each cell is responsible for its CA. Thus, D-DCA alleviates the complexity and centralization overhead of C-DCA. D-DCA schemes have following two sub-categories depending on how (cooperative or non-cooperative) the control over CA is performed in distributed manner.

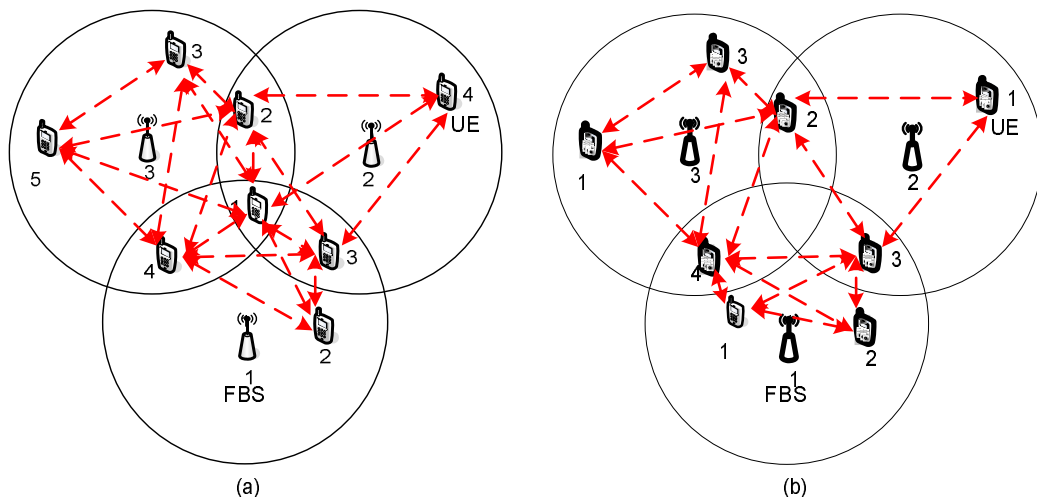

Figure 2.4. An example of minimum-span graph-coloring problem.

1. **Cell-based D-DCA:** Each cell base station (BS) performs channel assignment to its own calls based on the periodically updated channel availability information in its coverage area which is updated by exchanging the status information of channel usage patterns among the neighboring base stations. In this way, cell-based D-DCA schemes are cooperative. Among the earliest cell-based D-DCA schemes proposed in literature, an important example is *Local Packing Dynamic Distributed Channel Assignment (LP-DDCA)* [67] scheme that uses augmented channel occupancy (ACO) matrix at each BS containing channel usage patterns at itself and at neighboring BSs for making CA decisions. Such type of schemes give near-optimal CA, but at the cost of excessive channel pattern status exchanges among the neighboring BSs specially during heavy traffic conditions. LP-DDCA scheme assumes that all neighboring cells have all links interfering. Thus, occupancy of a channel in one link is assumed to be its unavailability for all other links in the neighboring BSs. This approach may result in inefficient radio resource utilization in case if all links among neighboring cells are not interfering. To understand this, look at Fig. 2.4(a) that illustrates an example of 3 neighboring FBSs. There are total 8 UEs located in the transmission ranges of these FBSs. Some of the UEs are located on overlapping

areas. The number at each UE represents the channel/code assigned to it. The arrow lines between UEs represent links (desired or interference links). It can be observed that the requirement of 8 channels is fulfilled by 5 channels with three of these being re-used. As in mobile networks, the links, whether desired or interference links, may change due to the user mobility and/or due to the changes in transmit powers. Likewise, consider the UE with channel number 1 moves into the mutually exclusive transmission area of FBS1 where it has no more links with UEs located in mutually exclusive areas of FBS2 and FBS3. In such a situation, see Fig. 2.4(b), the channel number 1 can be re-used instead of using the channel number 4 in FBS2 and the channel number 5 in FBS3. Therefore, for better radio resource utilization, there is need of D-DCA schemes that would adopt a link-to-link based approach instead of cell-based approach.

2. ***Received signal strength (RSS) measurement based D-DCA (RSS-based D-DCA) or interference adaptation D-DCA:*** Each BS performs CA to its own calls based only on the locally available information of channel usage patterns without having exchanged the channel status information with neighboring BSs. In this way, RSS-based D-DCA schemes are usually non-cooperative. Such type of schemes are termed as self-organizing that allow fast real-time processing due to minimal signal exchange overhead which is only at local level, and, as a result, it increases the channel packing at local level. However, due to their non-cooperative nature, RSS-based D-DCA schemes have limitations such as: sub-optimal channel assignment with global perspective, i.e., at macro cell level; increased cochannel interference probability; successive call interruptions; network instability.

Among the earliest RSS-based D-DCA schemes proposed in literature, an important example is *Digitally Enhanced Cordless Telephone (DECT)* system [63] that uses location information to maximize channel packing by way of estimating the signal to interference ratio (SIR) at UEs and BS. If predicted SIR is above a threshold SIR, the reusability of channel is established. In this approach the chances of successive call interruptions, service dead-lock, and instability in the system are high. An other worth-mentioning scheme is *Channel segregation (CS)* [68][69] which claimed to be a self-organizing, autonomous, and adaptive

RSS-based D-DCA scheme. In CS, each BS independently scans all channels in the order of channels selectivity probability p_i of channel i to determine the usability of channels based on acceptable interference levels. The channel selectivity probability p_i is renewed through learning process. If the scanned power, and thus the measured SIR, is below or above the threshold SIR, the scanned channel is considered idle or busy respectively. The benefits of CS scheme are: fully distributed dynamic CA; autonomous, i.e., no channel reuse planning required; adaptive to the changes in radio environment; decreased intra-cell hand-offs and call blocking probabilities. However, its limitations are: convergence of sub-optimal CA is quicker whereas the optimal global CA is an issue; the SIR threshold is assumed constant (same) in all cells that confines the applicability of CS scheme to one specific type of service rather than to differentiated services; the network model used in CS scheme is linear and one-dimensional that also limits its applicability in the multi-dimensional and multi-layered network topology such as in 4G HetNets.

2.5.3 Hybrid and Flexible Channel Assignment (HCA and FICA)

The DCA strategy gives flexibility and traffic adaptability at the cost of complexity, but it gives lesser radio resource utilization during higher traffic environment as opposed to FCA strategy. Therefore, favorable aspects of FCA and DCA strategies are combined in hybrid channel assignment (HCA) strategy. Each BS is pre-assigned with sufficient number of nominal channels (i.e., FCA) for its light traffic requirements and rest of the channels are kept in the central pool for flexible CA through DCA to cope with the increased traffic conditions. Flexible channel assignment (FICA) approach is more or less same as that of HCA approach, wherein FICA, DCA part can be of two types. One is *scheduled DCA* which is applied in determined peaks or determined distribution of traffic. Second is *predictive DCA* where traffic intensity is measured constantly at each BS. The performance metric of FICA strategy is the ratio of fixed and dynamic channels.

2.5.4 Reuse Partitioning (RuP) CA

These type of CA strategies are also well-studied in literature. In *Reuse Partitioning (RuP)* channel assignment concept, macro cell is divided into two or more concentric sub-cells called zones. The idea is, as the received power level in successive zones increases in proportion to the increasing distance, the channel reuse distance for channels allocated in the inner (i.e., smaller) zones is smaller than that for channels allocated in the outer (larger) zones when smaller and larger transmit powers are used for inner and outer zones respectively. A number of schemes have been proposed in the literature under following two major categories of RuP.

1. **Fixed-RuP:** Its one example is *simple fixed-RuP* [70] where all channels are exclusively divided among a number of overlaid cell plans with different reuse distances. A UE with better SIR gets channel from the cell plan with smaller reuse factor value and vice versa. In this way, SIRs of inner-side UEs are tuned down as these usually have more than the minimum required SIRs, whereas the SIRs of outer-side UEs are enhanced to the level of their minimum required SIRs in order to achieve increased capacity with overall improved SIRs distribution but with the same SIR targets throughout the cell. *Simple fixed-RuP* had two issues: capacity allocation, i.e., how many channels to be allocated to each zone; and real-time channel assignment to a call. These issues were taken up in the *simple sorting CA* algorithm [71]. *Fixed-RuP* strategy handles some of the drawbacks of FCA such as it gives almost optimal CA with improved radio resource utilization efficiency. However, it carries some of the important limitations of FCA such as: inefficiency in handling time-variant traffic; reuse pattern design complexity and complicated deformed cell shapes in small cells.
2. **Adaptive-RuP (ARP):** These schemes perform CA with RuP approach adaptively instead of fixed CA as in *fixed-RuP*. The main idea is that any channel can be used in any cell provided that the minimum required SIR is maintained. Within this category, different approaches have exploited the fact that traffic handling capacity of channels can be improved with the reduction in channels SIR margins. Some of the worth-mentioning approaches are in the following. One such approach is *autonomous-ARP* [72], wherein all BSs examine all channels in the same order and first channel that satisfies the SIR

requirement is assigned to the requesting call. Thus, each channel is reused at a minimum distance with respect to the received desired signal strength. This scheme enhances the traffic handling capacity of system and reduces cochannel interference at the cost of channels SIR margins. The *flexible-ARP* [73] scheme is an improvement of *autonomous-ARP* scheme, wherein the requesting call is assigned the channel with the smallest CIR margin. The excessive CIR measurements is an issue of *flexible-ARP* scheme in small cells with heavy traffic. The *self-organizing ARP (SORP)* [74] scheme proposed a table in each BS to contain average RSS measured in its own cell and in the the neighborhood. The table is updated periodically. In this way, a BS determine the location, i.e., the sub-cell or zone, of a calling UE and assigns a channel having the average RSS closest to the measured RSS of calling UE. The grouping (partitioning) of channels is done autonomously in the table based on average RSS value belonging to each channel. As opposed to *autonomous-ARP* scheme that always senses channels in the same order until a channel is found appropriate for assignment, the SORP scheme reduces overhead of finding appropriate channel through learning.

2.5.5 Hierarchal-CA

These type of schemes are for hierarchal cellular networks such as macro cells overlaid over the clusters of micro cells (small cells), also called *overlay schemes* [75]. The basic FCA and/or DCA approaches are usually adopted in such type of schemes, however, these schemes and their approaches need to be revisited for improvement keeping in view the versatile service requirements and network topologies of emerging 4G HetNets.

2.5.6 User-based CA or Opportunistic CA

Besides all CA categories discussed above, CA can also be categorized as *user-based CA or opportunistic CA* based on opportunistic type of spectrum sharing techniques which depend on spectrum sensing results and are widely deployed in *cognitive radio* technologies [76]. The basic idea is the type of UE that may access the channel. A UE can be a direct service subscriber (called primary user) of the operator, or it

can be a non-subscribed user (called as secondary user) but with some service access privileges under defined terms. User-based CA schemes can be further sub-categorized depending on the privileges the secondary users may have as in the following.

1. ***Underlay CA (UCA)***: Where both primary and secondary users are allowed to access the channel simultaneously while the generated interference has to be kept below a given threshold value.
2. ***Overlay CA (OCA)***: Where the secondary user is assumed to have a priori information of primary user's signal and of channel gains, and it can also be used to perform signal relay functionality among primary users. The secondary user exploits these information to either cancel or mitigate interference at both primary and secondary users sides.
3. ***Interweave CA (ICA)***: Where secondary user transmits opportunistically only in spectrum holes. That is, during its persistent spectrum sensing, the secondary user finds inactivity periods of primary user and performs its transmissions during these inactivity periods only. If, during in-band sensing, a secondary user detects a primary user activity arrival, it stops its transmission.

2.6 Research Approaches and Related Work

The problems of cochannel interference management and efficient radio resource utilization are correlated. If interference is mitigated or avoided efficiently, transmission loss of the radio resource is reduced that gives rise to the radio resource utilization. On the other way, if radio resource is utilized efficiently, transmission loss and thus interference is again reduced. Therefore this problem can be addressed with two approaches.

One is the technology advancement in the hardware that enables enhanced signal processing, data transmission, and error detection and correction possibly through PHY layer, but with the additions, modification, or tuning in the hardware. With that, the user is able to subtract out the strongest neighboring interferers from their received signals, but cancellation errors quickly degrade its usefulness [77].

With the other approach, efficient radio resource allocation to individual transmitters is achieved under the agreed hardware service conditions through MAC layer

schemes such as dynamic channel assignment at each FBS and MBS. However, in dedicated channel deployment, such solutions can only be effective when radio resource demand is less than its availability. In this approach, the RF entity avoids rather than suppressing the mutual interferences.

Based on the later approach, following are some sub-approaches for interference management. Also, some important interference management techniques proposed in the literature are discussed in the following.

Frequency and Time hopping:

- Slow frequency hopping in GSM enables femtocell users and nearby transmitting macrocell users to avoid consistent mutual interference. Similarly, frequency-hopped OFDMA networks can use random sub-channel assignments in order to decrease the probability of persistent collision with neighboring femtocells.
- In time-hopped CDMA, the CDMA duration $G \times T_c$ (G is the processing gain and T_c is the chip period) is divided into N_{hop} hopping slots, where each user randomly selects a hopping slot for transmission and remains silent during the remaining slots. Random time-hopping reduces the average number of interfering users by a factor of N_{hop} , while trading-off the processing gain.

Directional Antennas: Directional antennas inside femtocells would offer interference avoidance by restricting radio interference within an antenna sector. Providing a reasonable unit cost and easy end user deployment are the key challenges confronting this approach.

Link Adaptation: Interference link between the interferer and the receiver can be tuned such as through adaptive power control (APC) and adaptive modulation and coding (AMC) schemes. In these approaches, the receive power target can be varied under some agreed QoS requirement accomplishment (Q) in terms of minimum acceptable (threshold) signal to interference and noise ratio (SINR).

In case if the radio resource elements are not available enough to satisfy the traffic/user demand, the link adaptation (also called underlay based) solutions become more effective with the exploitation of adaptive power control (APC) and adaptive modulation and coding (AMC) which has also been provisioned in the LTE-A standard. In the legacy APC approach, the receiver measures SINR in terms of received signal strength indicator (RSSI), interference, and noise signals (see Eq. 3.1) and

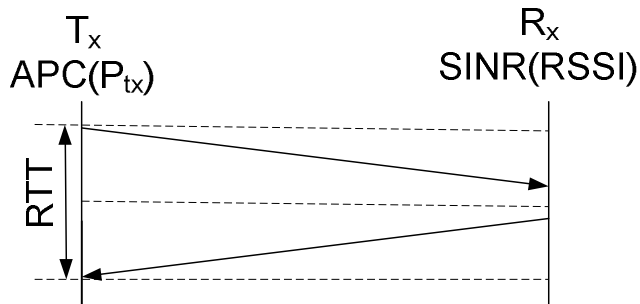

Figure 2.5. *Legacy Power Control Approach.*

report it to the transmitter, where the power control action is initiated so as to keep the measured SINR above the minimum required SINR. In the AMC approach, the measured SINR is compared with the minimum required SINR of each modulation scheme, where the modulation scheme with the highest resolution, i.e., highest transmission rate, that meets the current SINR threshold is employed in the data transmission. However, the transmitter requires at least one round trip time (RTT) to initiate power or modulation control action (see Fig. 2.5) after its last transmission. Also, the transmitter can identify the optimal transmit power only by way of an iterative method, which is at the expense of taking extra time to converge. To do this in one RTT, i.e., one iteration, the transmitter needs to know the environment parameters and distance/range between the transmitter and receiver. This leads to a fact that the APC legacy approach alone cannot work efficiently in the multitier cochannel deployment scenarios.

In place of the legacy APC approach that can only work reactively, proactive approaches via dynamic and seamless power control are required. Ideally, with a proactive approach, the power control action is taken on the basis of a priori statistical forecast of the received SINR, that is the function of a posteriori information gathered in the recent past. Therefore, the power control action is independent of the receiver current feedback, i.e., it can be initiated and completed before realizing that the received SINR is less than the threshold.

The study in [90] introduced both centralized and non-cooperative distributed solutions of power control. It was based on the legacy reactive APC approach for achieving the distributed solution, while targeting at minimizing the power utilization

of FBSs and MBS in the centralized solution via proactive APC. It is clear that most studies on cochannel interference management through power control have attempted in finding the dynamic range of downlink transmission power, but a detailed analytical framework of power control schemes has rarely been suggested.

The solutions introduced in [79] calculated the dead zone distance (i.e., threshold interference range) through so called instantaneous dynamic range ($= P_{tx_max}/P_{rx_min}$) for switching between overlay and underlay modes of spectrum access, where P_{tx_max} and P_{rx_min} are two fixed parameters that characterize the dead zone distance. The former is set by the regulatory authority while the later characterizes the sensitivity of the receiver (i.e., hardware limitation). Therefore, without any APC scheme, the switching between overlay and underlay modes is static. Whereas, if the model would take into account the changing relative positions, and thus the sensitivities, of other primary and/or secondary receivers, the practical power transmission range would change accordingly. In terms of spectrum reuse, the model does not provide optimal switching criterion between the overlay and underlay modes as the call is simply dropped if $SINR_{measured} < SINR_{threshold}$, whereas $SINR_{threshold}$ can be manipulated with APC and/or AMC schemes.

In view of the above discussion, it would be important to determine how the secondary radio resource, i.e., the transmit power and multi-resolution modulation and coding such as in APC and AMC respectively, as envisioned in the LTE-A standards, can be exploited proactively for in-time link adaptation between the interferer and the interfered, i.e., FBS and possible MUE(s) and FUE(s) (see Fig 3.3). The solution approaches to this problem resolution are: the legacy APC as discussed above, but it is reactive with its iterative nature; The other would be a proactive approach of using the legacy APC through statistical forecast of the dynamic interference range using mobility models for the UEs and then finding feasible minimum transmit powers set for each FBS to be scheduled among the radio resource elements and the UEs efficiently.

MIMO Femtocells: MIMO technology exploits the spatial diversity of wireless channels. While, femtocells can perform temporal link adaptation through adaptive modulation and coding (AMC), MIMO spatial link adaptation will enable a femtocell to switch between high SINR links for providing high data rates and robust

transmission.

The work in [80] suggests a sniffing function in FBS to perform RF measurements on UE on both macro and femto downlink channels such as: received signal strength indicator (RSSI), i.e., total received power spectral density (I_o), common pilot channel energy (CPICH E_c), and then the ratio, CPICH E_c/I_o . With this measurement, one solution for inter-femto interference issue in the dense femto deployment is using multiple carriers for FBSs, with each neighboring FBS assigned different frequency carrier as preferred carrier. During self-calibration, if FBS experiences significant interference on this carrier, it can operate on the secondary carrier. One solution for femto-macro interference management is to divide the available carriers among MBS and FBS. However, it is inefficient in terms of spectrum utilization, specially in case when deployment density of FBSs is less.

Femtocell downlink transmit power self-calibration is suggested through the sniffing function measurement of CPICH E_c/I_o at FBS assuming the same RF conditions at FUE and MUE. However, more accurate way would be to devise efficient mechanism to have RF measurement reports feed-back from FUE and MUE at FBS through some mechanism for efficient downlink transmit power self-calibration of FBS.

For uplink interference management to FBS and MBS, one approach is the adaptive uplink attenuation, with that the large noise figure value (attenuation) is used at FBS front-end to bring the signal at appropriate level for further processing. In this regard, the work in [81] suggests an algorithm that poses slow but smooth decay in attenuation as opposed to the sudden birth and death of interference sources requiring quick actions.

OFDMA femtocells can exploit channel variations in both frequency and time domains for the avoidance of interference using orthogonal sub-channels, while CDMA can only exploit the time domain using the pseudo random codes. The work in [10] suggests orthogonal channel assignment, i.e., divide the licensed spectrum into two exclusive parts one for the macrocell and the other for the femtocell, that completely eliminates the cross-layer interference but is not efficient in terms of spectrum reuse. An other solution suggested by this work is the cochannel assignment to macro and femto layers that can be made efficient with robust technical approaches such as: centralized sharing at the macro cell (i.e., spectrum may be divided into x number

of subgroups, the macro cell uses all the groups while each femtocell picks a group randomly reducing the collision probability by a factor of x); or distributed channel sharing at each femtocell that may be cooperative or non-cooperative.

Chapter 3

Research Problem: Description and Modeling

3.1 Problem Statement

On the face of emerging 4G integrated high speed wireless communication services, related technical constraints or inefficiencies, and pervasively increasing subscriber base worldwide, as discussed in previous chapters, my research problem relates to both the subscribers and the operators and is stated in the following.

1. The subscribers face the problem of frequent shortage or even outage of radio coverage due to various natural reasons such as increased obstacles in the indoor, in the underground, and in the congested metropolitan areas with the increased teletraffic in peak hours, and due to highly data hungry services which causes fast degradation to radio propagation accounting for multiple physical phenomenon that result into de-rated service or even outage of service.
2. Consequently, the operators face problems such as:
 - loss of their networks capacities in terms of average teletraffic transport rate with their limited radio spectrum over the target coverage areas, and
 - dissatisfaction or even loss of customers due to frequent de-rating and/or outage of services in the highly competitive telecommunication market.

The concentrated traffic zones (see Fig. 3.3) which are mostly in the indoor or are highly congested metro areas of big cities, account for shortage or outage of radio coverage, so called *radio coverage holes*, to the subscribers, specially for high speed wireless communication services that are provided over longer radio links within/across

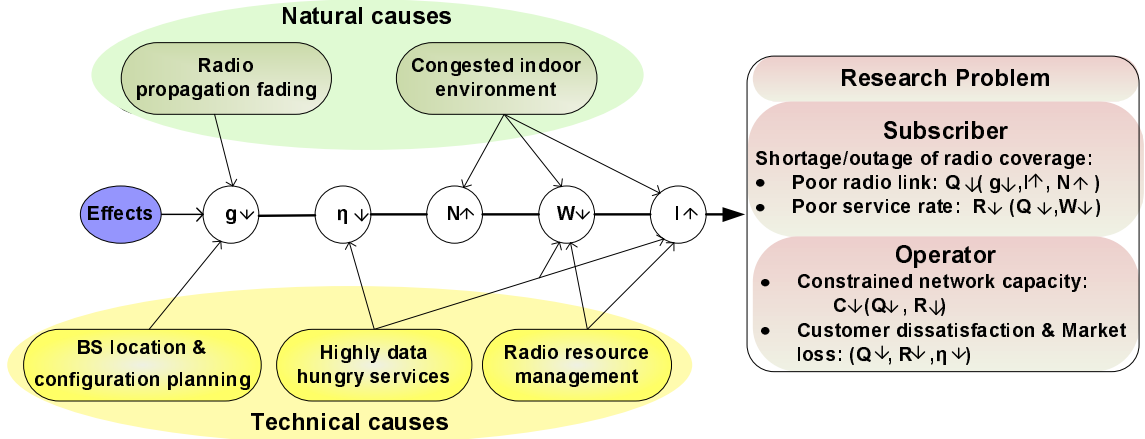

Figure 3.1. *Research Problem as a Function of Causes and Effects.*

these *radio coverage holes*. In today's highly competitive telecommunication markets, cellular network operators have to resolve following two major problems for their success.

1. Elimination or minimization of *radio coverage holes* in time and space from the target coverage area to ensure continuous guaranteed services to the subscribers
2. Fulfil the ever increasing services demands through scalable network capacities with the provision of efficient technological solutions within the limited available radio resources

3.1.1 Problem Challenging Issues: Causes and Effects

My proposed research problem is described in Fig. 3.1 as function of some natural and technical causes and their effects. The problems of shortage and/or outage of radio coverage, constrained network capacity, and customer dissatisfaction can be translated into poor (\downarrow) link quality (Q), poor service rate, i.e., *data rate* (R), and poor energy efficiency (η). The outage of radio coverage is characterized by the poor link quality ($Q \downarrow$) which is defined as the *signal to interference and noise ratio (SINR)* in Equation 3.1 and is a function of channel gain g , interference I and noise N , i.e., *radio coverage outage* \leftrightarrow *poor radio link quality*: $Q \downarrow (g \downarrow, I \uparrow, N \uparrow)$. The shortage of radio coverage is characterized by poor data rate ($R \downarrow$), as defined in Equation 3.2 on the basis of *Shannon-Hartley* formulation on capacity of a channel having bandwidth W with the average transmit power P_{tx} and interfered only by

the *Additive White Gaussian Noise (AWGN)* with the received power N [82], i.e., *radio coverage shortage* \leftrightarrow *poor data rate*: $R \downarrow (Q \downarrow, W \downarrow)$. The constrained network capacity ($C \downarrow$) is characterized by both the poor link quality and the poor data rate, i.e., $C \downarrow (Q \downarrow, R \downarrow)$. And the subscriber dissatisfaction is characterized by poor link quality, poor data rate, and poor energy efficiency, i.e., *dissatisfaction*($Q \downarrow, R \downarrow, \eta \downarrow$).

$$Q = \frac{gP_{tx}}{I + N} \quad (3.1)$$

$$R = W \log_2(1 + Q) \quad (3.2)$$

Where, g is the channel gain between the target transmitter and the receiver, and I is cumulative interference power received at the receiver.

Important natural causes and their effects that contribute to the research problem are described in the following.

1. There are a number of following radio propagation fading types that characterize poor channel gain ($g \downarrow$).
 - Distance (d) dependent path loss that is exponentially proportional, i.e., d^n where n is path loss exponent, to the distance d between the transmitter and the receiver
 - Multi-path and shadow fading that depend on the environment such as indoor, outdoor, and on the quantity and nature of obstacles between the transmitter and the target receiver
 - Larger spectrum ($W \uparrow$) propagation, such as wideband/broadband, that is more vulnerable to path loss, specially in case of outdoor to indoor propagation
2. Asymmetric distribution of mobile subscribers and, thus, teletraffic, due to following reasons, over the coverage area in time and space results into concentrated traffic zones that account for more interference ($I \uparrow$), more noise ($N \uparrow$), and scarcity of radio resource ($W \downarrow$).
 - More traffic originate in the indoor than in the outdoor [6, 4].
 - Mobile subscribers are more concentrated on work places, houses, public and metropolitan areas in different timings of the day and in different days

of the week.

Important technical causes and their effects that contribute to the research problem are described in the following.

1. Inappropriate radio coverage planning, that result from the following important factors, also characterizes poor channel gain ($g \downarrow$).
 - Cell node location determination
 - Selection/determination of cell node characterization and configuration parameters such as bounds on transmit power, antenna height, tilt, azimuth, etc.
2. Inappropriate capacity planning or radio resource management, that result from the following important factors, accounts for the increased intercell interference ($I \uparrow$) and decreased radio resource utilization ($W \downarrow$).
 - Determination of radio frequency requirement to meet with the agreed services demands
 - Arrangement/exploration of the required radio resource such as frequency reuse planning
 - Utilization of the available radio resource, i.e., frequency assignment problem (FAP)
3. Highly data hungry services that result from the following factors
 - High resolution modulation schemes such as $64QAM$ account for more transmit power, i.e., less energy efficiency ($\eta \downarrow$), and more interference ($I \uparrow$) to the neighboring cells.
 - Broadband air-interface technologies such as OFDMA that can use more radio spectrum through radio resource blocks for higher data rates, consume more bandwidth ($W \downarrow$)

3.2 Solution Options, Choices, and Challenges

In the recent history of wireless communications spread over last two decades, my proposed research problem has had vital attention from the researchers and has been

addressed with a number of solution options with different approaches. Each of the solution options and approaches has its own pros and cons, and scope and limitations.

3.2.1 Solution Options

One of the options is improving the signal reception and processing at the receiver. This option includes advanced signal detection and signal processing techniques such as advanced error detection and error correction techniques, i.e., automatic repeat request (ARQ), hybrid-ARQ, forward error correction (FEC), and advanced digital signal processing (ADSP) techniques. These techniques usually work at the receiver and target in alleviating the effect part of the problem, i.e., interference and noise cancelation, and thus, in improving the subscriber link quality and service rate. Techniques such as ARQ work at the transmitter as feed-back error control mechanism for the same purpose but with the increased signaling and bandwidth cost. Pros and cons of this solution option are: it is based on reactive approach as it does not address the problem causes directly; it has limited scope as it does not contribute to the operator capacity problem resolution; it incurs increased processing cost in terms of energy, time, and price; the only benefit of this solution is that it alleviates the subscriber problem to some extent.

Installing relay nodes and/or remote radio heads (RRH) in between the cell node and the mobile node is an other option that target in alleviating the cause of the problem by compensating for the radio propagation fading through creating shorter range wireless links. However, this solution account for the increased capital (capex) and operational (opex) expenditures, complexity and scalability issues, and for the only benefit of subscriber problem alleviation to some extent. Sufficient radio resource provisioning through buying more radio spectrum is an other option which is not only very expensive but also is limited in scope and scalability as it alleviates the operator's capacity problem but does not address subscriber's coverage problem, and it can not be scaled to meet with the pervasively increasing data demand.

The most widely studied and adopted option is improving the utilization of limited radio spectrum in a target coverage area through so called spectrum reuse techniques. There are different approaches which have been applied for improving the reuse of limited spectrum but, again, with their own pros and cons. One approach is reducing

Table 3.1. *Solution Options and Comparison.*

Options	Target (Causes or Effects)	Limitations/Challenges	Benefits/Choices
Advanced signal detection & processing at receiver: ADSP, error detection & correction	Effects: interference (I) & noise (N) cancelation	<ul style="list-style-type: none"> • Reactive: no address to problem causes • Little contribution to operator capacity • High processing cost (energy, time) 	Subscriber problem (QoS) alleviation
Relay nodes & remote radio heads (RRH)	Cause: Radio propagation fading (g) compensation	<ul style="list-style-type: none"> • Increased capex & opex • Complexity & scalability issues 	Subscriber problem (QoS) alleviation
Buy more spectrum	The common effect of all problem causes, i.e., constrained W	<ul style="list-style-type: none"> • Very expensive, not scalable • No help to subscriber coverage problem due to propagation fading 	Operator capacity & subscriber rate improved
More spectrum reuse: Minimal cell cluster sizing	The common effect of all problem causes, i.e., constrained W	<ul style="list-style-type: none"> • More intercell interference • No help to subscriber coverage problem due to propagation fading 	Operator capacity & subscriber rate improved
More spectrum reuse: Closer $T_x R_x$, i.e., small cells (metro, pico, femto, WLAN) with minimal frequency reuse distance	<ul style="list-style-type: none"> • Cause: Radio propagation fading (g) compensation • Common effect of all problem causes, i.e., constrained W 	<ul style="list-style-type: none"> • If centrally planned and controlled: increased capex & opex, signalling, latencies, complexity, scalability issues • If deployed by the subscriber, issues: self-organization, asymmetric locations, inter-cell interworking, fairness 	Operator capacity & subscriber rate & QoS improved
More spectrum reuse: Efficient radio resource sharing through MAC, e.g., dynamic & opportunistic spectrum accesses (DSA, OSA)	The common effects of all problem causes, i.e., constrained radio resource (W) & intercell interference (I)	<ul style="list-style-type: none"> • Continuous radio environment status with fine granularity of each radio channel • Intercell coordination: interfering links, traffic patterns, spectrum status • Increased signalling, energies, latencies 	Operator capacity & subscriber rate & QoS improved

the cell cluster size, i.e., increasing the frequency reuse factor. This approach alleviates the constrained bandwidth effect of all the relevant problem causes. With this approach, inter-cell interference is increased and the subscriber coverage problem due to propagation fading is not addressed. Another approach is bringing the transmitter and the receiver closer, i.e., reducing frequency reuse distance through the deployment of smaller cells such as metro/micro cells, pico/femto cells, as illustrated in Fig. 1.2. In this approach, with the closeness of transmitter and receiver, the issue of radio propagation fading that contributes to the radio coverage problem, is addressed, and

at the same time, with the reduction in frequency reuse distance, the issue of constrained radio resource that contributes to the operator's network capacity problem, is addressed.

However, the deployment of smaller cells can be broadly split in two categories. In one category, small cells such as metro or micro cells are centrally planned and controlled by the operator, thereby creating the issues of more capex and opex, signalling, latencies, complexity, scalability. In the second category, small cells such as pico or femto cells and WLANs are deployed and operated by the subscriber, thereby creating the issues of self-organization, self-configuration, asymmetric locations and link budgets, cross-layer inter-cell interworking, and fairness.

The most important approach of my interest for improving the radio resource utilization is efficient radio resource sharing through medium access control (MAC), e.g., dynamic and opportunistic spectrum accesses (DSA, OSA) techniques, in smaller cells especially those which are deployed by the subscribers. With this solution approach, common effects of all the relevant problem causes, i.e., constrained radio resource and inter-cell interference that contributes to my research problem, are addressed.

All the solution options discussed above are compared qualitatively in Table 3.1.

3.2.2 Solution Choices

A deliberate consideration of various solution options in the last sub-section led me to a comprehensive set of solution choices for the proposed research problem in terms of all the three options on more spectrum reuse, i.e., minimal cell cluster sizing (full frequency reuse), closer transmitter and receiver (small cells), and last but the most important, dynamic spectrum access through efficient medium access. This set of solution can easily be translated into following problem solution statement.

“The problem solution lies in efficient reuse of limited but precious radio spectrum in 4G HetNets through the exploitation of spatiotemporal diversities among transmissions in orthogonal frequency division multiple access (OFDMA) based medium access, i.e.,

- *doing orthogonal channelization to meet with data demands on interfering links in the interfering cells,*

- *doing non-orthogonal channelization to meet with data demands on non-interfering links in the interfering cells, and*
- *doing non-orthogonal channelization to meet with data demands on interfering links in the interfering cells through interference range adaptation with power and/or data rate control within the minimum service requirement constraints in situations such as scarcity of usable spectrum due to environment and/or peak traffic conditions.”*

In this solution, multi-tier inter-cell interference and coverage holes are avoided resulting into the improved links quality and data rates for the subscriber and improved network capacity for the operator in terms of carrying more traffic in unit time with the same radio spectrum in the same area.

3.2.3 Solution Challenges

Capacity and coverage gains from spectrum reuse are conditioned on efficiently addressing the following new challenges that are specific to the peculiar design and operational complexities of 4G HetNets.

1. 4G HetNets are designed with multi-layered cellular topology (see Fig. 2.1) and with dissimilar characteristics, wherein a number of small cells with the variety of cell architectures (see Fig. 1.2) are overlaid by a large cell with some or all interfering wireless links.
2. Small cells such as pico/femto cells and WLANs are in-door, user-deployed and user-operated, and, thus, are asymmetrically located with asymmetric very low link power budgets, and are self-organizing. Whereas, large cells (macro cells) are high-powered, and other small cells such as metro and micro cells are medium-powered, and both are planned and controlled by the operator.
3. Small and large cells have two dimensional inter-cell interworking, i.e., horizontal across the small cell boundaries and vertical within the overlaid large cell, and thus, have increased dynamics of user mobility and data traffic trespassing the multi-layered cell boundaries. Therefore, the conventional cell selection/association techniques for managing user mobility across the multi-tier cell boundaries would not work.

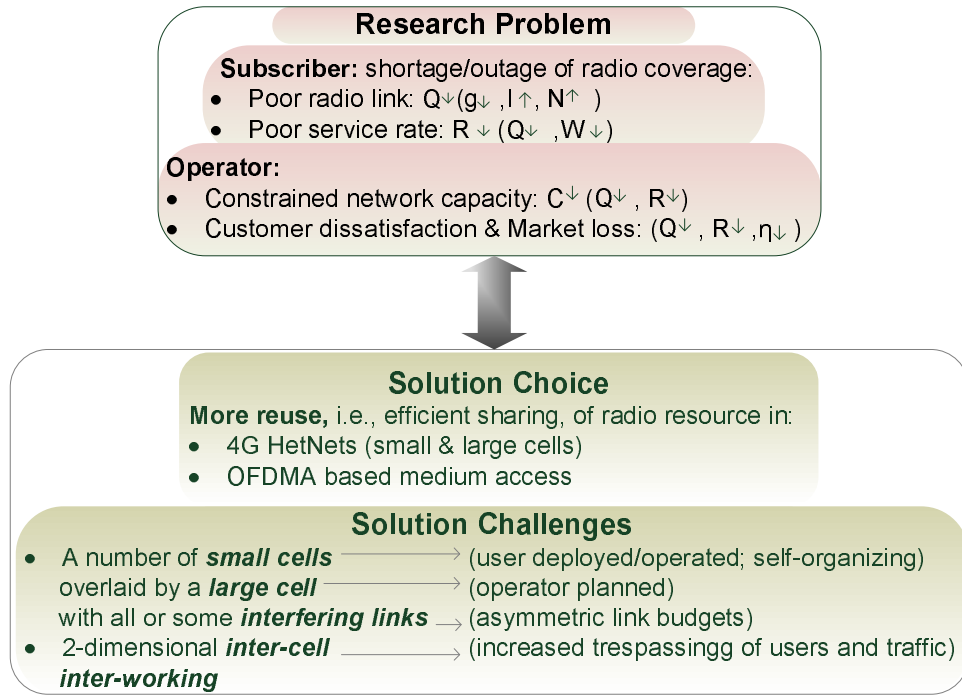

Figure 3.2. *Research Problem: Solution Choices and Challenges.*

4. Due to non-deterministic number and locations of in-door small cells, and due to multi-layer inter-cell interworking of 4G HetNets, the traditional approaches for radio resource planning and inter-cell interference coordination that are mostly centralized and static in the network core and are carried out pre-hand by the operator in 3G and lower cellular technologies, are liable to increased signalling overhead, latencies, complexity, and scalability issues and, thus, are not viable.
5. Self-organizing small cell should be able to explore the availability and optimize the utilization of radio resource at its own to meet with its users traffic demands, but it should also regard the traffic demands in its neighboring small cells and overlaid macro cell for overall network capacity gains.

My research problem, now transformed into my solution choices and related challenges, is illustrated in Fig. 3.2. In view of the above considerations, 4G HetNets bring new challenges for more complex but efficient communication technologies to deal with the complex interworking of low-powered small cells and high-powered large cells. In this context, there is a dire need for new research and development of theoretical and technological base for dynamic, intelligent, and joint radio resource and interference management in 4G HetNets. It would need the design and develop-

ment of dynamic and distributed schemes for asymmetric spectrum sharing among heterogeneous base stations with interference management and power adaptation to traffic variations. Also, viable collaborative transmission strategies that are robust to limited channel information feedback are needed for enhanced spectrum utilization.

3.3 Research Problem Modeling

3.3.1 Problem Scenario

Fig 3.3 illustrates the target scenario of the problem, wherein I consider 4G HetNet scenario that deploys femto (small) cells along with the macro cell in LTE-A network. A radio access network part of the E-UTRAN plane is shown below the straight line, and it comprises of a MBS M_o , a number of femto cell base stations (FBSs) F_k ($k = 1, 2, \dots, K$), a number of macro user equipments (MUEs) m_i ($i = 1, 2, \dots, I$), a number of femto cell user equipments (FUEs) n_j ($j = 1, 2, \dots, J$). The solid arrow lines correspond to the radio links between the target transmitter and receiver and the broken arrow lines correspond to the interference links between the interferer transmitter and the interfered receiver.

In this radio access part, I illustrate two interference scenarios. Scenario 1 corresponds to the combined interferences involving multiple FBSs F_k , and multiple macro and femto cell UEs m_i and n_j respectively. This is a typical scenario that closely correspond to the femto cells deployment as public hot-spots such as in shopping malls, hospitals, corporate buildings etc., with possibly *open access* and *cochannel deployment*, i.e., *full frequency reuse*, modes, and this is the ultimate target scenario of my research problem resolution. Scenario 2 corresponds to a private femto cell deployment such as in private homes with possibly *closed service group (CSG)* and *cochannel deployment* modes. However, scenario 2 may correspond to interferences involving one or more than one very closely located private FBSs F_k along with one or more than one MUEs m_i and multiple FUEs n_j .

The LTE-A core network part of its evolved packet core (EPC) plane is shown above the straight line, and it comprises of a service gateway (S-GW) and the mobility management entity (MME). With this illustration of the core network part, it should be noted that in LTE-A network architecture, the radio access network (E-UTRAN)

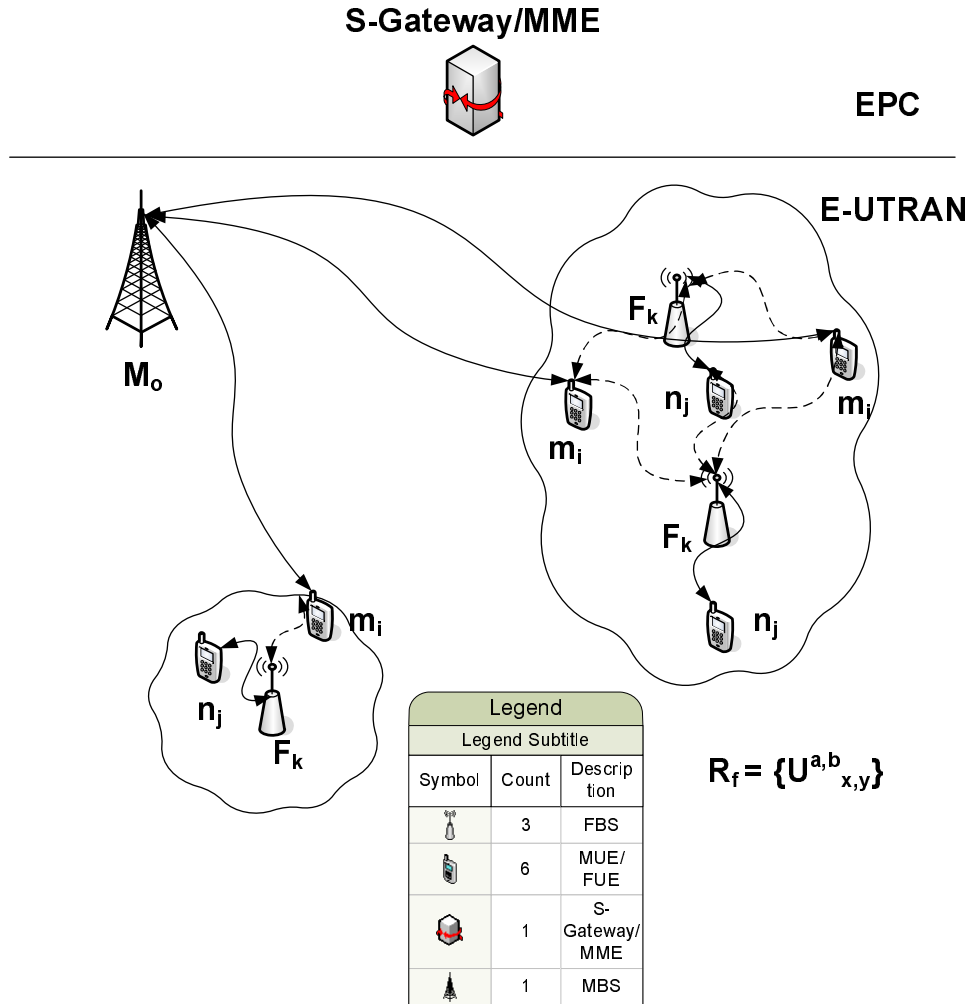

Figure 3.3. *4G HetNet Research Problem Scenario: Multi-tier Macro-Femto Cells Radio Resource Sharing.*

has flat architecture as apposed to that in GSM which has hierarchal architecture. The benefit of this flat architecture is that the radio access entities such as MBS and FBS are directly connected to S-GW and MME as single hop with the only difference that the FBS has a gateway (HeNB-GW) and a virtual security gateway (seGW) in between. The FBS gateway has the same interface $S1$ at its both ends to connect to the FBS at one end and to the S-GW/MME at the other end, and thus can play the role of a signal relaying node when needed. This flat network architecture

with the provision of using the HeNB-GW as a relay node would greatly reduce the signalling and processing overhead between the FBS and the central control unit . Therefore, with the virtually single hope centralized assistance as layer 2 functionality via *S1* interface that accounts for the relaying feature of HeNB-GW between FBS and S-GW/MME, and with the cooperation among the neighboring cell nodes with interfering links as MAC part of layer 2 functionality via *X1* signaling interface, distributed and cooperative radio resource sharing and scheduling as MAC part of layer 2 solutions is easy with the reduced overhead.

3.3.1.1 Problem Space

Definition 3.1: The OFDMA radio frame which is provisioned in LTE-A standardization and is uniquely characterized by the frame number f is the *problem space* R_f^k for a target BS k . The whole *problem space* R_f^k is modeled into multidimensional *problem space units* $U_{x,y}^{a,b}$, each corresponding to the specific radio resource element in OFDMA radio frame f such that

$$R_f^k = \{U_{x,y}^{a,b}\}. \quad (3.3)$$

The subscripts x and y in $U_{x,y}^{a,b}$ correspond to the primary radio resources, i.e., OFDMA frame time slot and sub-carrier frequency, each with equal length, respectively, and these take positive integer values from finite sets $\{x|X \geq x \in I^+\}$ and $\{y|Y \geq y \in I^+\}$ respectively. Whereas, the superscripts a and b correspond to the secondary radio resources, i.e., transmit power (P_{tx}) and data rate (r) respectively, at a target BS k and take discrete values from finite length vectors \mathbf{A} and \mathbf{B} . ■

Figs. 3.4(a) and 3.4(b) respectively illustrate the time-frequency and time-RSSI (received signal strength indicator) dimensional views of the problem space R_f^k in the radio access interface of a target BS k as concatenation of the perceived views of its individual problem space units $U_{x,y}^p$, where the superscript p correspond to the perceived RSSI reflecting on the secondary radio resources, i.e., transmit power (P_{tx}) and data rate (r).

Note that each problem space unit $U_{x,y}^{a,b}$ is uniquely characterized by the time slot number x and the sub-carrier number y . However, its transmit power (P_{tx}) and data

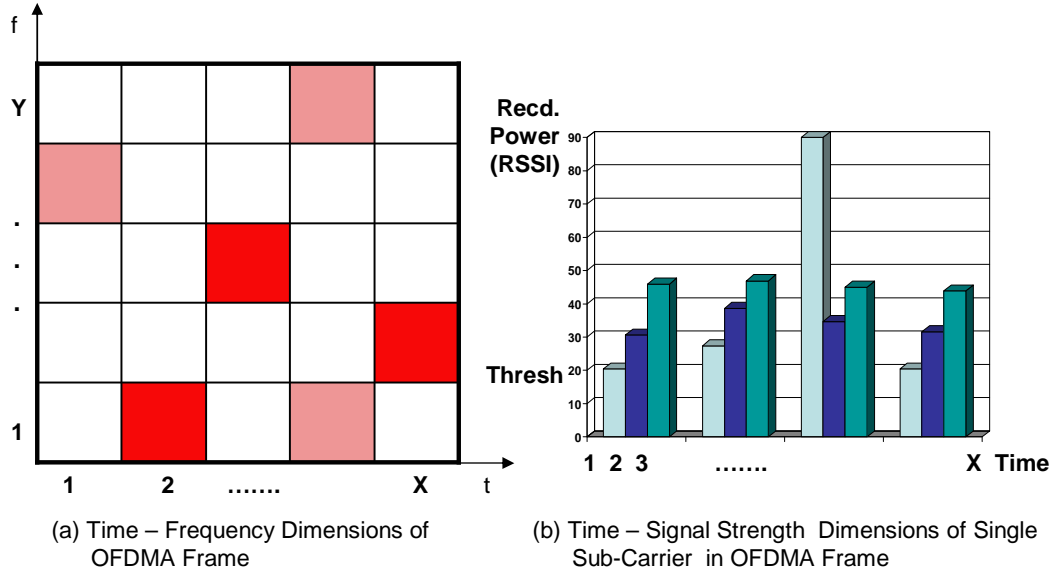

Figure 3.4. An Illustration of Multi-dimensions in OFDMA Frame.

rate (r) characterizations are not unique, i.e., these can vary with the adaptive power and modulation control techniques corresponding to superscripts a and b respectively as functions of the perceived views of its individual problem space units $U_{x,y}^p$.

3.3.1.2 Solution Space

It can be noted that an undesired link through a particular problem space unit $U_{x,y}$ between a target transmitter and a target receiver is due to the power filling into $U_{x,y}$ from concurrent transmissions in the neighborhood. Denote the undesired link detection in a particular problem space unit $U_{x,y}$ with $U_{x,y}^{p*}$, which means its perceived interference power strength is above a quality defining threshold p_{thr} .

Definition 3.2: An arbitrary problem space unit $U_{x',y'}^{a,b}$ amount for the *solution space* S_f^k to the undesired problem space unit $U_{x,y}^{p*}$ such that $U_{x',y'}^{a,b}$ is orthogonal to $U_{x,y}^{p*}$ in at least one unique dimension whether time (x) or frequency (y), i.e.,

$$\begin{aligned}
& S_f^k = \{U_{x',y'}^{a,b}\} & (3.4) \\
\text{s.t., } & S_f^k \subseteq R_f^k, \\
& U_{x',y'}^{a,b} \perp U_{x,y}^{p^*}, \\
\text{i.e., } & \text{if } x' = x \quad ; \quad y' \neq y \quad \text{orthogonal in frequency dimension,} \\
& \text{if } x' \neq x \quad ; \quad y' = y \quad \text{orthogonal in time dimension,} \\
& \text{if } x' \neq x \quad ; \quad y' \neq y \quad \text{orthogonal in frequency and time dimension,}
\end{aligned}$$

and if, for any reason such as due to the scarcity of OFDMA radio resource elements, orthogonal radio resource sharing can not be done, i.e., $x' = x$ and $y' = y$, the solution space S_f^k also contains the undesired problem space unit $U_{x,y}^{p^*}$ for non-orthogonal radio resource sharing through transmission range control with transmit power adaptation techniques. ■

3.3.2 Important Bounds, Metrics, and Parameters

3.3.2.1 Conditions for Orthogonal and Nonorthogonal Channelization

The cardinality of problem space R_f , i.e., total number of uplink and down-link problem space units (Us) in R_f would be $N_{R_f} = X \times Y$ (X : total number of time slots in the radio frame f ; Y : total number of sub-carriers in the radio frame f). However, the number of effective, i.e., usable, Us at an FBS k in a target frame f would be $\eta.N_{R_f}$. Here, η is the *frequency reuse efficiency* to be defined later. In a target frame f , represent the demand for uplink and down-link problem space units (Us) for power fill-up in a target FBS k with $D_{U_f^k}$, i.e., the number of Us desired by k during f , and in a target macrocell o with $D_{U_f^o}$, i.e., the number of Us desired by o during f . For stable network operation in *cochannel deployment* mode, usually these demands should not surpass the number of usable Us in k , i.e., $D_{U_f^o} \leq \eta.N_{R_f} \geq D_{U_f^k}$.

In Fig. 3.4(b), the set R_{fUL}^k represents the uplink perceived Us in frame f at SBS k that are useable, i.e., the measured interference is below the quality defining threshold, and the set $R_{fDL}^{n_j^k}$ represents the down link perceived Us that are useable in frame f at a target FUE n_j associated with FBS k . Accordingly, the set of down

link perceived Us in frame f that are commonly useable at all FUEs n_j associated with FBS k in the down link can be given in Eq. (3.5). Note that FBS and FUEs can exchange these perceived/measured information through *measurement reports (MRs)* in the neighborhood.

$$R_{fDL}^{\forall n_j^k} = \bigcap_{j=1}^J R_{fDL}^{n_j^k} \quad (3.5)$$

Note that the set $R_{fDL}^{n_j^k} \setminus R_{fDL}^{\forall n_j^k}$ is also usable at user n_j^k only besides the set $R_{fDL}^{\forall n_j^k}$ which is commonly usable by all users $\forall n_j^k$. However, keeping in view the small ranges of low powered FBSs, the user reception diversity is assumed to be negligible, and therefore, the set $R_{fDL}^{n_j^k} \setminus R_{fDL}^{\forall n_j^k}$ is ignored. In case of comparatively larger cells such as metro/micro cells, the set $R_{fDL}^{n_j^k} \setminus R_{fDL}^{\forall n_j^k}$ can also be taken into account.

The set R_{fDUL}^k of useable Us both in uplink and down link of the frame f at FBS k is given in Eq. (3.6).

$$R_{fDUL}^k = R_{fUL}^k \bigcup R_{fDL}^{\forall n_j^k} \quad (3.6)$$

Therefore, total number of useable Us in the target FBS k for both uplink and down link is $N_{U_f^k}^{useable} = |R_{fDUL}^k|$. In order for the underlying spectrum access scheme at target FBS k to explore and be able to provide orthogonal radio resource sharing to all its demand services in their down link and uplink, the condition in Eq. (3.7) should generally be satisfied.

$$N_{U_f^k}^{useable} \geq D_{U_f^k} \quad (3.7)$$

In case where $N_{U_f^k}^{useable} < D_{U_f^k}$, the excess demand, i.e., $D_{U_f^k} - N_{U_f^k}^{useable}$, for radio resource can be fulfilled through nonorthogonal radio resource sharing, i.e., with the undesired Us through the dynamic interference range control approaches such as adaptive power and/or data rate control under the accepted constraints.

3.3.2.2 Radio Resource Reuse Efficiency (η)

If all the problem space units Us in the problem space R_f are usable, i.e., there is no interfering link, the macro cell maximum channels capacity is $C_{max} = (K + 1).N_{R_f}$.

With interfering links, the macro cell net channels capacity is $C_{net} = \sum_{k=1}^{K+1} N_{U_f^k}^{useable}$, where $K + 1 = o$ represents one macro base station (M_o). The radio resource reuse efficiency (η) is defined as in the following.

Definition 3.3: The radio resource reuse efficiency (η) is defined as the ratio of macro cell net channels capacity and macro cell maximum channels capacity, i.e., $\eta = \frac{C_{net}}{C_{max}}$. ■

Let: N_i = the number of Us allocated to a MUE i ; N_{j_k} = the number of Us allocated to a FUE j associated with FBS k ; N_{S^i} = the number of FBSs interfering with the MUE i ; $N_{S_l^j}$ = the number of FBSs l , such that $l \neq k$, interfering with the SUE j associated with FBS k ; N_{M^j} = the number of MBS, that is only one, interfering with the FUE j associated with FBS k . The loss of Us due to MUE i is $L_i = N_i \cdot N_{S^i}$. The loss of Us due to all MUEs I is $L_I = \sum_{i=1}^I N_i \cdot N_{S^i}$. The loss of Us due to a SUE j_k is $L_{j_k} = N_{j_k} \cdot N_{S_l^j} + N_{j_k} \cdot N_{M^j}$. The loss of Us due to all FUEs j_k is $L_k = \sum_{j=1}^J N_{j_k} \cdot N_{S_l^j} + \sum_{j=1}^J N_{j_k} \cdot N_{M^j}$. The loss of Us due to all FUEs j_k in all K FBSs is $L_K = \sum_{k=1, l \neq k}^K \sum_{j=1}^J N_{j_k} \cdot N_{S_l^j} + \sum_{k=1}^K \sum_{j=1}^J N_{j_k} \cdot N_{M^j}$. The total loss of Us is $L_T = L_I + L_K$. The macro cell net channels capacity is $C_{net} = \sum_{k=1}^{K+1} N_{U_f^k}^{useable} = C_{max} - L_T$. The radio resource reuse efficiency (η) is formulated as in Eq. (3.8).

$$\eta = \frac{C_{max} - L_T}{C_{max}} = 1 - \frac{\sum_{i=1}^I N_i \cdot N_{S^i} + \sum_{k=1, l \neq k}^K \sum_{j=1}^J N_{j_k} \cdot N_{S_l^j} + \sum_{k=1}^K \sum_{j=1}^J N_{j_k} \cdot N_{M^j}}{(K + 1) \cdot N_{R_f}} \quad (3.8)$$

However, the radio resource reuse efficiency (η_T) in traditional frequency planning is given as: $\eta_T = \frac{1}{N}$. Where, N is the fixed size of cells cluster, i.e., the radio resource reuse efficiency (η_T) in traditional frequency planning is a static and pre-planned function $f(N)$ of the cluster size N which is time invariant. Whereas, in dynamic spectrum sharing approach, Eq. (3.8), the radio resource reuse efficiency (η) is a dynamic function $f(N_{S^{ij}})$ of the number of interfering femto and/or macro cells ($N_{S^{ij}}$) which is variable in real time, and it can be maximized by minimizing these interfering numbers through intelligent and dynamic radio resource sharing among the multi-tier 4G HetNets cells. Therefore, $f(N_{S^{ij}})$ supports self-deployment and self-organizing capabilities in 4G HetNets small cells, and it captures real time dynamics of interactions between the interfering nodes. Whereas, $f(N)$ is inefficient in all these respects.

3.3.2.3 Network Bounds

The limited radio resource in an arbitrary *problem space*, i.e., OFDMA radio frame f , is modeled in the terms of frequency, time, transmit power, and transmission rates, as in the following.

1. **Available radio spectrum:** The total available radio spectrum bandwidth is C Hzs such that: $C = \sum_{y=1}^Y c_y = Yc_y$. Where, c_y is the bandwidth of sub-carrier y ; $c_y = c_z \forall y \neq z, y, z \in I^+$; $Y \in I^+$ is the total number of sub-carriers.
2. **Available time:** The total available time period is T units such that: $T = \sum_{x=1}^X t_x = Xt_x$. Where, t_x is the time period of sub-period (time slot) x ; $t_x = t_w \forall x \neq w, x, w \in I^+$; $X \in I^+$ is the total number of sub-periods (time slots).
3. **Transmit power groups:**
 - Femto cells:** The range of transmit power for an arbitrary femto cell is defined with the transmit power vector \mathbf{p}_F^p that comprises of discrete integer values. Where, $p = 1(1)s, s \in I^+$, such that \mathbf{p}_F^p contains increasing values with increasing values of super-script p .
 - Macro cells:** The range of transmit power for an arbitrary macro cell is defined with the transmit power vector \mathbf{p}_M^q that comprises of discrete integer values. Where, $q = 1(1)m, m \in I^+$, such that \mathbf{p}_M^q has increasing values with increasing values of super-script q .
4. **Transmission rates:** The available transmission rates are defined in transmission rate vector \mathbf{r}_{α_v} that comprises of discrete values. Where, the rate element is a function of specific modulation scheme α_v which is an element of modulation schemes vector $\alpha = \{\alpha_v\}$ as provisioned in PHY layer of RF entities in 4G HetNets. The subscript v takes values in positive integers set I^+ , and each value has correspondence to the specific modulation scheme in the modulation schemes vector $\{BPSK, QPSK, QAM, 8QAM, 16QAM, 64QAM \text{ etc}\}$.

3.3.2.4 Traffic Dynamics

Traffic arrival rate (λ): The traffic arrival rate $\lambda(AppType)$ is a function of application or service type, e.g., voice, streaming audio and video, live video data etc. λ_{UE} represents the traffic arrival rate at a mobile user equipment (UE) in bps. λ_{BS}

represents the traffic arrival rate at a base station (BS) in bps. Usually, $\lambda_{BS} \gg \lambda_{UE}$.

Service/departure rate (μ): The service or the departure rate $\mu(r_{\alpha_v}, p_b, p_{out})$ is a function of transmission rate r_{α_v} , blocking (queueing) rate p_b , and error (outage/dropping) rate p_{out} . Besides, μ also depends on signal processing and signal propagation rates. μ_{UE} represents the service rate at an UE in bps. μ_{BS} represents the service rate at an BS in bps.

User service profile (F): Each subscriber, whether MUE (m_{io}) or FUE (n_{jk}), has a service profile, F_{io} or F_{jk} respectively, that contains these respective parameters: transmission rate vector ($\mathbf{r}_{io}^{\alpha_v}, \mathbf{r}_{jk}^{\alpha_v}$), where α_v is an element of the modulation schemes vector $\{BPSK, QPSK, QAM, 8QAM, 16QAM, 64QAM \text{ etc}\}$; transmit power vector ($\mathbf{p}_{io}^q, \mathbf{p}_{jk}^p$); traffic arrival rate ($\lambda_{io}, \lambda_{jk}$); minimum threshold SINR ($\gamma_{io}^{\alpha_v}, \gamma_{jk}^{\alpha_v}$); maximum allowed probability of outage ($\varepsilon_{io}, \varepsilon_{jk}$); a wireless link with its parent BS (l_{io}, l_{jk}). These service profiles are represented in Eqs. (3.9) and (3.10) respectively.

$$F_{io} = \{\mathbf{p}_{io}^q, \mathbf{r}_{io}^{\alpha_v}, \lambda_{io}, \gamma_{io}^{\alpha_v}, \varepsilon_{io}, l_{io}\} \quad (3.9)$$

$$F_{jk} = \{\mathbf{p}_{jk}^p, \mathbf{r}_{jk}^{\alpha_v}, \lambda_{jk}, \gamma_{jk}^{\alpha_v}, \varepsilon_{jk}, l_{jk}\} \quad (3.10)$$

The respective BS (MBS or FBS) stores their associated user's profiles, F_{io}, F_{jk} . Copies of these profiles are also stored in the network controller.

3.3.2.5 Determination of Demand and Usability of RRU's (Us)

With the help of Eq. (3.2), the radio spectrum bandwidth W_{jk} required by a user equipment n_j associated with the FBS k (i.e., n_{jk}) is computed in Eq. (3.11) in terms of the number of radio resource units (N_{jk}) such that $W_{jk} = N_{jk}c_y$.

$$N_{jk} = \frac{r_{jk}^{\alpha_v}}{c_y \log_2(1 + \gamma_{jk}^{\alpha_v})} \quad (3.11)$$

The usability of an arbitrary radio resource unit (U) is modeled, by manipulating Eq. (3.1) in terms of defining bounds on the *received signal strength indicator (RSSI)* and on the *received signal strength (RSS)*, for a user equipment n_j associated with the FBS k (i.e., n_{jk}) at a reference transmit power level p_{jk}^p of FBS on the wireless link

l_{jk} between n_{jk} and FBS k when the channel gain g_{jk} is assumed as already known. Since, $RSSI = I_{jk} + N_{jk} + g_{jk}p_{jk}^p$, an upper bound on RSSI in an arbitrary U is derived from Eq. (3.1) in Eq. (3.12).

$$RSSI_{jk} < RSSI_{jk}^{th} = \frac{g_{jk}p_{jk}^p(1 + \gamma_{jk}^{\alpha_v})}{\gamma_{jk}^{\alpha_v}} \quad (3.12)$$

Note that Eq. (3.12) provides threshold $RSSI_{jk}^{th}$ when the BS k is transmitting to user n_{jk} with transmit power p_{jk}^p . In case when the BS k is not transmitting to user n_{jk} , and n_{jk} senses/measures the interference signal $RSS_{jk} = I_{jk} + N_{jk}$ only, the threshold RSS_{jk}^{th} is derived from Eq. (3.12) as in the following Eq. (3.13).

$$RSS_{jk} < RSS_{jk}^{th} = \frac{g_{jk}p_{jk}^p}{\gamma_{jk}^{\alpha_v}} \quad (3.13)$$

Chapter 4

Research Solution, Analysis, and Discussion

4.1 Introduction

In view of the problem defined in the previous chapter, the current chapter contributes in studying the problem of inter-cell interference coordination (ICIC) in macro-femto multitier network topology jointly with the exploitation of spectrum reuse benefits in presence of cochannel interferences. The objective is to enhance the utilization of radio spectrum with the satisfaction of negotiated QoS of individual services by way of cognitive radio resource sharing among multitier macro-femto cell entities which are supposed to be empowered with the spectrum sensing/inference techniques for general case and added with the proactive power and modulation control schemes for special case, aiming to achieve seamless multitier services. For this purpose, the chapter introduces a novel framework named as *Hybrid Radio Resource Sharing (HRRS)*.

The HRRS framework comprises of two functional modules, referred to as *Cognitive Radio Resource Sharing (CRRS)* and *Proactive Link Adaptation (PLA)* scheme. The HRRS framework works as a dynamic switching algorithm, wherein CRRS and PLA modules adaptively invoke according to whether orthogonal channelization is to be carried out exploiting the *interweave channel allocation (ICA)* approach or non-orthogonal channelization is to be carried out exploiting the *underlay channel allocation (UCA)* approach respectively when relevant conditions regarding the traffic demand and radio resource availability as defined and modeled in the last chapter are met. In this way, both temporal and spatial reuse benefits of cochannel or partial cochannel deployment of small (femto/WLAN) cells are maximized through ICA and

UCA approaches respectively. The simulation results demonstrate that the proposed HRRS framework can substantially empower the legacy cochannel and/or partial cochannel deployment of femto cells with improved utilization of radio resource.

4.2 Research Solution: Hybrid Radio Resource Sharing (HRRS) Framework

The section introduces the proposed HRRS framework that enables dynamic alternation between the interweave-like and underlay-like modes for femto transmissions. Without loss of generality, in this framework the legacy cochannel and partial cochannel deployment modes of femtocells that would cause cochannel interferences are considered only. Whereas, the case of legacy dedicated channel deployment of femtocells is left as there is no motivation for exploring the radio resource reuse benefits, and it is assumed, for the sake of completeness, that the already provisioned resource allocation and link adaptation methods would work such as envisioned in the legacy 3GPP standardizations for LTE-A [83]. Thus, cochannel or partial cochannel deployment of femtocells is the scenario of more interest and worthy of my efforts. The objective of the framework is to maximize the spectrum utilization jointly with the cochannel interference avoidance. The spectrum utilization is firstly exploited in the dimensions of primary radio resources, i.e., OFDMA frame time slots and sub-carrier frequency, while satisfying the negotiated QoS of individual services by way of orthogonal channelization through cognitive radio resource sharing. Also, the spectrum utilization is exploited in the dimensions of secondary radio resources, i.e., transmit powers and data rates, while satisfying the negotiated QoS of individual services by way of non-orthogonal channelization through proactive link adaptation. The steps of HRRS framework are illustrated in the flowchart shown in Fig. 4.1.

It should be noted that the proposed HRRS framework always uses interweave-like spectrum access mode via CRRS module in a target femto cell if the spectrum utilization is not greater than a threshold, i.e., the un-used radio resource elements (RREs) can be explored or arranged in required quantity and quality in the target femto cell. Otherwise, HRRS turns to underlay-like access mode via PLA module. In the following, working steps in HRRS framework are described followed with the

details of two functional modules CRRS and PLA.

1. If radio resource elements (RREs) are available in enough quantity and quality in any or in both primary dimensions, i.e. frequency and time dimensions, the CRRS scheme takes into place and performs orthogonal channel allocation (CA) according to the availability of RREs with respect to its primary dimensions through cochannel or partial cochannel deployments.
2. If RREs are not sufficiently available in primary dimensions, the CRRS scheme adapts to the interweave-like spectrum access mode, i.e., ICA, where FBSs exploit temporal diversities among OFDMA based transmissions to continue performing orthogonal channel allocation (CA) through cochannel or partial cochannel deployments.
3. If orthogonal channelization is not feasible after the CRRS is exhausted in ICA mode, the PLA scheme takes over in underlay-like spectrum access mode, i.e., UCA, where FBSs exploit spatial diversities among OFDMA based transmissions to continue performing non-orthogonal channel allocation (CA) through cochannel or partial cochannel deployments.
4. After the PLA scheme performs tuning down the threshold interference range among the interfering links through a link adaptation mechanism, and if target receiver (e.g., the interfered MUE) that is closest to the interferer transmitter (e.g., FBS in the down-link) becomes beyond the tuned-down new threshold interference range, the PLA scheme continues performing non-orthogonal channel allocation (CA) through cochannel or partial cochannel deployments. Otherwise, the service is dropped or other transmission diversity techniques such as directional antenna and/or MIMO may be exploited if already provisioned.

4.2.1 Cognitive Radio Resource Sharing (CRRS)

The CRRS scheme achieves efficient interweave-like spectrum access operation, i.e., ICA, when there is more radio resource demand than its availability. The novelty of the scheme is that it enhances radio resource utilization by way of joining the two dimensions of orthogonal channelization as discussed in the previous chapter, i.e., time slot and subcarrier frequency in the OFDMA frame. In addition to that, the

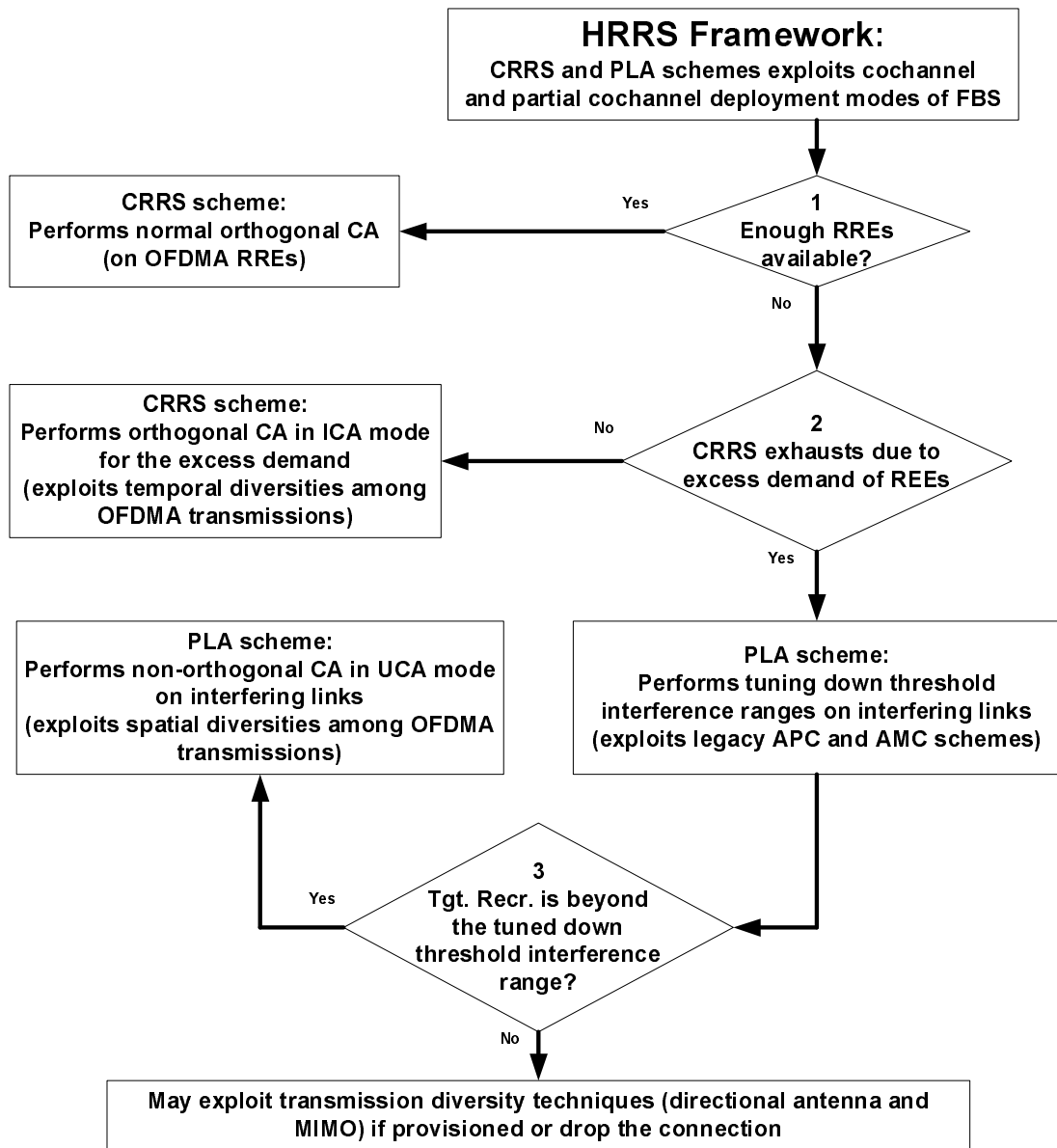

Figure 4.1. *Sequence of Steps in Hybrid Radio Resource Sharing (HRRS) Framework.*

scheme exploits the idea of interweave channel allocation (ICA), i.e., opportunistic spectrum access (OSA) in cognitive radio technology [66].

However, in CRRS, as opposed to cognitive radios, the concept of primary and secondary users is not adopted as both MUEs and FUEs are supposed to be the primary subscribers of the same network operator and, thus, both are primary users.

Whereas, in the OSA approach adopted in cognitive radios, the secondary user can only transmit as far as the primary user has nothing to transmit. Whether or not the secondary user has completed its transmission, it stops transmission as soon as the primary user has some data to transmit.

For CRRS efficient working, each cell node should have the capability of perceiving spectrum usability a priori at each cell node with the fine granularity of each radio resource element in OFDMA radio frame on a persistent time scale. This task can be done through appropriate carrier sensing at PHY-layer such as wide-band sensing through energy detection in [87], measuring the received signal strength (RSS) in WiFi systems [84][85]. These sensing/measuring results would be sent by UEs to their respective BSs through *measurement reports (MRs)*, which is already provisioned as envisioned in 4G HetNets standardizations. Also, logical carrier sensing at MAC-layer can also be used for this purpose such as *network allocation vector (NAV)* in WiFi systems [84][85]. It is assumed that FBSs and both FUEs and MUEs have such features installed in their hardware to perform the tasks of CRRS.

Note that the terminologies FUE and MUE used in this report are interchangeable depending on the current service provisioning affiliation of a user equipment (UE), i.e., whether with a FBS or with a MBS respectively. The cost of CRRS added feature in terms of money, hardware complexity, and power efficiency would depend on how accurate the carrier sensing results are required in order to keep OFDMA based transmissions orthogonal. The generally used approaches for accuracy performance metrics are the probabilities of correct and false alarms of the availability of a target radio resource element in a target OFDMA frame. Therefore, this parameter is considered as a performance measure in the CRRS scheme.

The CRRS module generally works at the level of individual FBS and its affiliated FUEs in distributed manner. The CRRS scheme works intelligently on as is required basis and is always in one of these two states *OFF* or *ON*. A FBS and its FUEs keeps their CRRS feature in *OFF* state in *dedicated channel deployment* mode of femto cell. Otherwise, the CRRS feature is in *ON* state except when PLA feature is in place. In PLA state, the CRRS feature is partially functioning, i.e., the carrier sensing mechanism keeps on functioning but the cognitive radio resource sharing mechanism is in *OFF* state. The reason for keeping the carrier sensing mechanism in functioning

state during the PLA phase is to know when the required quantity and quality of RREs can be found through carrier sensing mechanism and a seamless transition can take place from PLA functioning phase to a complete *ON* phase of CRRS scheme. It should be noted that the rationale of designing the alternating HRRS framework between its two functional modules CRRS and PLA is to keep the signalling and processing overhead incurred by HRRS framework as low as possible.

4.2.2 Proactive Link Adaptation (PLA)

The PLA scheme targets to achieve an efficient underlay-like operation when interweave-like mode via CRRS scheme is not viable, and transmissions can be initiated by manipulating transmit powers under the service constraints such as error rate, speed, delays etc. In other words, the threshold interference range between target MUE(s) and interfering FBS is dynamically tuned so as to support the desired transmissions. The PLA scheme exploits widely deployed power control techniques such as APC and AMC, also envisioned in [83], and its steps are illustrated in the flowchart shown in Fig. 4.2 and functions are explained in the following.

Note that with the proposed PLA module, a central control unit (CCU) such as the mobility management entity (MME) in the EPC (evolved packet core) plane (as envisioned in the LTE-A architecture with the deployment of FBS as HeNB [83]) is enabled to estimate a priori and update periodically the interference range between the target MUE(s) and the interfering FBS through a scheme based on statistical methods using some mobility model for target MUE(s). This scheme would take into account the posteriori interference range information that is provided periodically by the interfering FBS via the secured wired backhaul Internet connection between CCU and FBS through measurement reports (MRs) as envisioned in [83]. For now, it is assumed that FBSs are provisioned with hardware/software capabilities of detecting and measuring the interference range(s) of target MUE(s) periodically in a distributed way with the assistance data provided by relevant entity such as the service gateway (sGW) and/or MME in the EPC plane of 4G cellular networks architecture [83]. For the sake of completeness, a survey is incorporated in chapter 2 on possible options of interference range measurement approaches and techniques proposed in academia and within the LTE-A standardization efforts. The important thing to note in this survey

is that the value of range measurement and its exploitation between the RF entities of the emerging 4G wireless networks is realized by the standardization bodies.

With the enactment of PLA module, the central control unit (CCU) is also enabled to calculate the threshold interference range(s) periodically between the target MUE(s) and the interfering FBS with the current input data such as transmit powers of MBS and FBS, QoS requirement of target MUE(s) in terms of minimum required SINR, range of target MUE(s) from MBS measured at MBS and provided to CCU periodically in the same way as done by interfering FBS. Based on the estimated a priori knowledge of interference range(s) and the calculated threshold interference range between the target MUE(s) and the interfering FBS, the proposed proactive link adaptation (PLA) module works at CCU in the following steps.

1. If transmit power of interfering FBS is within the maximum and minimum power limits, new value of transmit power is calculated so that the threshold interference range can be tuned down. And if transmit power is already on its limits, low resolution modulation can be used. Note that low resolution modulation can satisfy the same QoS requirement with comparatively lower transmit power but at the cost of lower data rates, and in that way it creates room to further tune down the threshold interference range.
2. If new transmit power is able to tune down the threshold interference range such that the actual interference range is greater than the new threshold interference range, FBS works in cochannel deployment mode through PLA. Otherwise, the scheme checks whether manipulation through lower resolution modulation schemes can be done.
3. If, by using possible low resolution modulation, the transmit power can further be lowered to an extent such that the actual interference range is greater than the new threshold interference range, cochannel deployment would still prevail through PLA. Otherwise, either the service is dropped or transmission diversity techniques such as directional antenna and MIMO may be exploited if already provisioned.

Note that in this framework, the PLA module only take place in a special case when the carrier sensing results are not sufficient to fulfill the services requirement of femtocell. However, if it is assumed that FBS hardware is capable of exploiting the

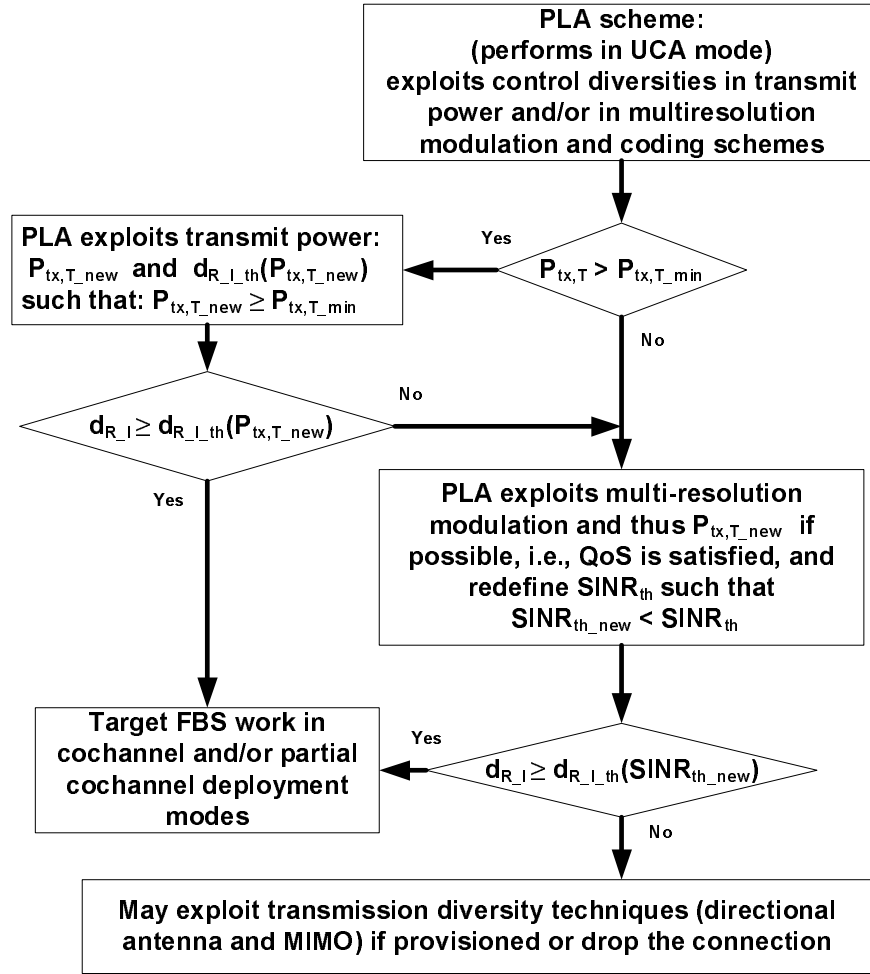

Figure 4.2. Sequence of Steps in Proactive Link Adaptation (PLA) Scheme.

whole spectrum bandwidth of the operator, the chances of availability of the required un-used RREs are always expected to be high enough in low range FBS area (i.e., in less than 20m radius) to fulfill the limited radio resource demand of its affiliated a few FUEs (i.e., more or less 4) in *closed service group* mode that is usually in a private area like home. In such a case, the PLA module may rarely be used, but in a case when FBS is used as a hot-spot in public area such as shopping center, hotel, hospital etc., the *open access* deployment mode of FBS is supposed to be capable of serving comparatively large number of FUEs which reduces the chances of availability of the required un-used RREs through CRRS module all the times. In such a case, the effectiveness of the proposed PLA module is expected to be more.

4.3 Research Analysis and Discussion

4.3.1 CRRS versus Cochannel and Dedicated Channel

Deployments: A Simulative Analysis and Comparison

This section provides comparative analysis that I carried out through simulations at system level on the benefits of my solution strategy and approach, i.e., cognitive radio resource sharing (CRRS) strategy at individual cell nodes, in comparison to the legacy full and hard frequency reuse approaches such as *cochannel* and *dedicated* deployments of femto cells respectively. A cell node with CRRS feature is supposed to be capable of perceiving spectrum usability a priori, thereby improving the utilization of OFDMA radio resource units temporally. Thus, CRRS strategy empowers the legacy cochannel deployment with cognitive capabilities, thereby substantially increasing the radio resource utilization in terms of throughput as opposed to that achieved from legacy cochannel deployment and very close to that of dedicated channel deployment. Note that the throughput performance of dedicated channel deployment is at the cost of utilizing extra radio resource units. I developed simulation models for these three approaches in *Matlab* with following considerations.

For this simulation study, I take into account the specific down-link cochannel interference scenario in Fig. 2.3 when MUEs having no access to a FBS visit to its home area located at the edge of macro cell boundary under severe interfering transmissions from FBS. A teletraffic model is used with *ON-OFF* periods having geometric distribution. I consider TDD-type radio frame in E-UTRA (LTE), [83], for down-link traffic of this scenario. It is assumed that the radio frames and its sub-frames (slots) at MBS and FBS are synchronized. I also assume that the down-link transmissions from MBS and FBS that use the same radio resource units result in severe interference at the respective MUE, and as a result the transmitted packet from MBS is lost. User equipments are assumed to have cognitive capabilities such as wide-band sensing through energy detection in [87] and send the sensing results to their respective BSs through measurement reports (MRs). I used false-ve and false+ve probability model for detection of the availability or non-availability of radio resource units with certain probabilities of false alarms as an accuracy measure. Input parameters of simulations are given in Table 4.1. FBS has four connected FUEs and

Table 4.1. *Simulation parameters.*

Parameter	Value
E-UTRAN UE class	2 Mbps
Radio frame size	10 ms
slot size	0.5 ms
DL packet size	125 Bytes
Average silence period	1.35 sec
Average talk-spurt period	1.15 sec
Prob. of false-ve; false+ve alarm	0.01 – 0.5

varying numbers of visiting MUEs having no service access to the host FBS. In the following, I evaluate the down-link throughput of this scenario deploying each scheme separately as mentioned above.

One important consideration on CRRS strategy would be the accuracy of carrier sensing results that ultimately affects the performance. The results in Fig. 4.3 compare the throughput performance of interference scenarios with the increasing number of MUEs in the transmission range of FBS and with the increasing probability of false alarm, i.e., the probability of false channel detection. As can be expected, the results demonstrate that the throughput deteriorates with the decrease in accuracy of channel detection mechanism, i.e., the increase in the probability of false channel detection. One important but intuitive result shown in Fig. 4.3 is that the increasing number of MUEs further affect throughput deterioration. As can be seen, the rate of decrease in throughput is faster with the increasing probability of false channel detection when there are more MUEs in the transmission range of FBS with cochannel deployment mode. The reason for this is that there are more false channel detections which are falsely utilized by more MUEs giving rise to the packet loss.

As can be seen in the performance results in Fig. 4.4, the throughput performance of legacy cochannel deployment scheme is very poor which deteriorates further as the number of MUEs increases in the transmission range of the host FBS. This is due to the increasing cross-tier cochannel interference at MUEs. The performance of the legacy dedicated channel deployment scheme looks better in Fig. 4.4, however, note that the throughput increase is at the cost of more radio resource units which are used

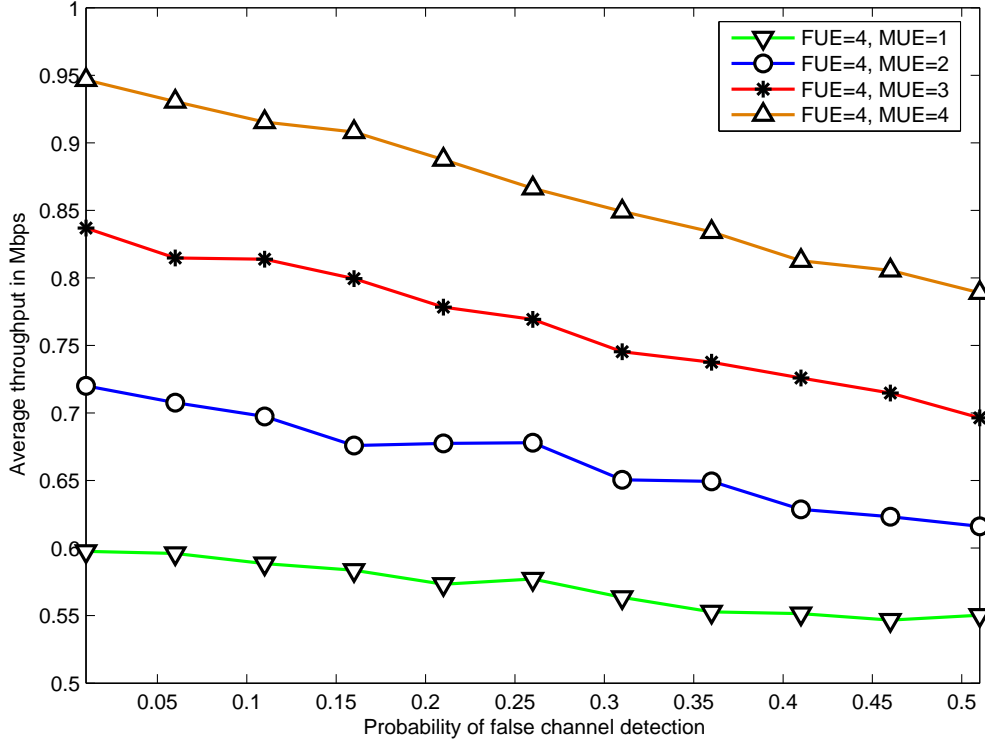

Figure 4.3. *Probability of false channel detection vs. throughput.*

separately by MBS and FBS. On the other hand, the proposed CRRS strategy has substantially empowered the legacy cochannel deployment. According to the results in Fig 4.4, with the proposed CRRS strategy, 10% to 30% more throughput can be provisioned with the utilization of same number of radio resource units as in the legacy cochannel deployment. This result provides important insights of the proposed strategy in relation to its resolution of vital challenges of the research problem, i.e., multi-tier inter-cell interference coordination, efficient radio resource allocation and spectrum utilization.

4.3.2 Interference Range Computation for PLA

In the following, I define bounds and thresholds on some important network metrics such as ranges and transmit powers of RF entities.

Receive/Transmit Power Bounds: These values are control parameters and are assumed as known a priori.

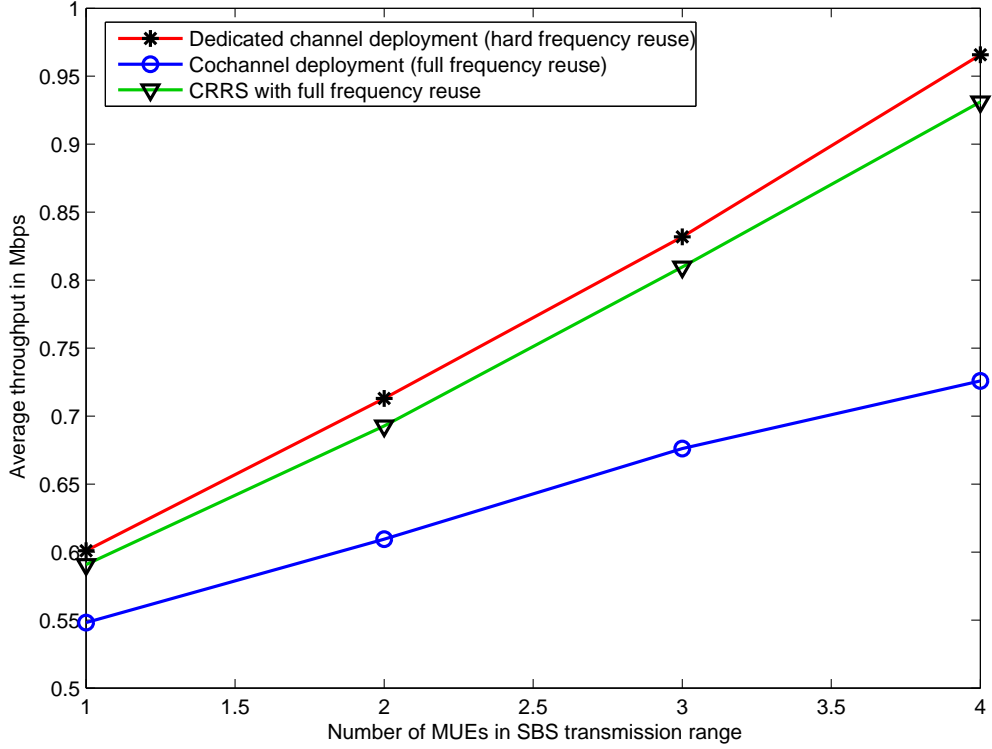

Figure 4.4. *Comparative throughput analysis of CRRS strategy.*

- Sensitivity of receiver ($P_{rd,min}$): It is defined as minimum power level that can be detected by a receiver. $P_{rd,min}$ also defines the minimum transmit bound on transmitter power, i.e., $P_{tx,min}$.
- Maximum transmit power ($P_{tx,max}$): It is the upper bound on transmit power sets, i.e., \mathbf{p}_{io}^q and \mathbf{p}_{jk}^p , by the regulatory authority. It is also used to limit the interference.
- Pilot power: It defines the cell edge and is equal to 10% of $P_{tx,max}$.
- At a target transmitter T : $P_{tx,T,min} \leq P_{tx,T} \leq P_{tx,T,max}$
- At an interferer transmitter I : $P_{tx,I,min} \leq P_{tx,I} \leq P_{tx,I,max}$

Ranges between RF Entities:

- Range between a receiver R and a target transmitter T : $d_{R,T}$
- Range between a receiver R and an interferer I : $d_{R,I}$
- $d_{R,T,th}(P_{tx,T}) (\geq d_{R,T})$: Maximum threshold range at transmit power $P_{tx,T}$ that a receiver should be located at or below this threshold range in order to detect

and to camp on the transmitter T . This is the coverage range within that a receiver R can establish a link with the transmitter T at some acceptable QoS (i.e., SINR) level.

- $d_{R,I,th}(\cdot) (\leq d_{R,I})$: Threshold interference range that a target receiver R should be located at or farther from it in relation to the interferer I in order to avoid interference from going above a certain level. The condition $SINR \geq \gamma_{th}$ can not be fulfilled within this threshold interference range by simply adaptive power control (APC) due to upper and lower bounds on it or by adaptive modulation and coding (AMC) due to minimum bounds on the guaranteed QoS (such as BER, data rate) that can not be maintained because of the hardware limitations on resolution of modulation and coding schemes.

Definition 4.1: Threshold interference range $d_{R,I,th}(\cdot)$ is the largest range between the receiver R and the interferer I for which $SINR \leq \gamma_{th}$. ■

In this section, I formulate analytical solutions for computing threshold interference ranges, i.e., $d_{R,I,th}(\cdot)$, in all possible down-link cochannel interference scenarios as illustrated in Fig.2.3. Then, I present the case study analysis that I carried out for one such scenario in order to understand the dynamics of threshold interference range as function of transmit powers of target and interfering transmitters, range from the target transmitter, and SINR requirement of the interfered UE. At a target UE, the received signal powers $P_{rd,f}$ and $P_{rd,m}$ respectively from SBS and MBS are modeled using the ITU-R, P.1238 [88] indoor propagation model and ITU P.1411 [89] outdoor to indoor propagation model as follows.

$$P_{rd} = P_{tx} + G_{bs} - L_c - PL + G_{ue} - L_{c,u} \quad (dBm) \quad (4.1)$$

In case if the transmitter is FBS, above equation can be written as:

$$P_{rd,f} = P_{tx,f} + G_f - L_{c,f} - PL_f + G_{ue} - L_{c,u} \quad (dBm) \quad (4.2)$$

Where:

$P_{tx,f} = 75\%$ of the total transmit power, i.e., equivalent isotropic radiated power (EIRP) (dBm)

$PL_f = 20 \log f - N \log d_{ue,f} - L_f(n) + 28$ (dB), ITU-R, P.1238 indoor-propagation

model [88]

G_f = FBS antenna gain (dBi)

G_{ue} = UE antenna gain (dBi)

f = Carrier frequency (MHz)

$L_{c,f}$ = FBS feeder/connector loss (dB)

$L_{c,u}$ = UE connector and body loss (dBi)

$d_{ue,f}$ = Range between the UE and FBS (m)

$L_f(n) = [4n, 15 + 4(n - 1), 6 + 3(n - 1)] = [residential, official, commercial]$ = Floor penetration loss factor (dB) as a function of the number of floors (n) between UE and FBS

$N = [28, 30, 22] = [residential, official, commercial]$ = Distance power loss coefficient depending on the type of building

In case if the transmitter is MBS, above equation can be written as:

$$P_{rd,m} = P_{tx,m} + G_m - L_{c,m} - PL_m + G_{ue} - L_{c,u} \quad (dBm) \quad (4.3)$$

Where:

$P_{tx,m}$ = 75% of the total transmit power, i.e., equivalent isotropic radiated power (EIRP) (dBm)

G_m = MBS antenna gain (dBi)

$L_{c,m}$ = MBS feeder/connector loss (dB)

$PL_m = L_{bp} + c_1 + c_2 \log\left(\frac{d_{ue,m}}{d_o}\right) + L_w$ (dB), ITU P.1411 outdoor to indoor propagation model [89]

$L_{bp} = \left|\frac{20 \log \lambda^2}{8 \Pi h_m h_u}\right|$ = Basic transmission loss at d_o (dB)

$d_{ue,m}$ = Range between the UE and MBS (m)

$d_o = \frac{4h_m h_u}{\lambda}$ = Break-point distance beyond which the rate of change in the path loss increases

λ = Wave-length of f (m)

h_m = Height of MBS (m)

h_u = Height of UE (m)

L_w = Window penetration loss

$$c_1 = \left\{ \begin{array}{ll} 0 & \text{if } PL_m \text{ corresponds to lower bound} \\ 20 & \text{if } PL_m \text{ corresponds to upper bound} \end{array} \right\} \text{ (dB)}$$

$$c_2 = \left\{ \begin{array}{ll} 40 & \text{if } d_{ue,m} > d_o \\ 20 & \text{if } d_{ue,m} \leq d_o, \text{ if } PL_m \text{ corresponds to lower bound} \\ 25 & \text{if } d_{ue,m} \leq d_o, \text{ if } PL_m \text{ corresponds to upper bound} \end{array} \right\} \text{ (dB)}$$

Threshold interference range computation for a MUE from FBS: With equations (4.2) and (4.3), I manipulate equation (3.1) and come up with the following inequality in terms of threshold interference range, $d_{mue,f,th}(\cdot)$, for MUE in the vicinity of FBS. Equation (4.4) models the threshold interference range scenario when the MUE visits a FBS house, given the femto and macro BSs transmit powers, threshold SINR, and the range from the MBS. MUE must be at or farther away than this threshold interference range from the FBS where it is visiting as a guest.

$$\begin{aligned} d_{mue,f} &\geq 10^{\frac{1}{N}} \left[P_{tx,f} - P_{tx,m} + \gamma_{mue,th} + c_2 \log\left(\frac{d_{mue,m}}{d_o}\right) + C_{mf} \right] \\ &= d_{mue,f,th}(\cdot) \quad (m) \end{aligned} \quad (4.4)$$

Where:

$$C_{mf} = -G_m + L_{c,m} + L_{bp} + c_1 + L_w + G_f - L_{c,f} - 20 \log f - L_f(n) + 28 = \text{a constant}$$

Threshold interference range computation for a FUE from MBS: With equations (4.2) and (4.3), I manipulate equation (3.1) and come up with the following inequality in terms of threshold interference range, $d_{fue,m,th}(\cdot)$, for FUE especially in the vicinity of MBS in its direct bore-sight.

$$\begin{aligned} d_{fue,m} &\geq d_o 10^{\frac{1}{c_2}} \left[P_{tx,m} - P_{tx,f} + \gamma_{fue,th} + N \log(d_{fue,f}) + C_{fm} \right] \\ &= d_{fue,m,th}(\cdot) \quad (m) \end{aligned} \quad (4.5)$$

Where:

$$C_{fm} = -C_{mf} = \text{a constant}$$

Threshold interference range computation for FUE visiting a neighbor FBS: Again, with equations (4.2) and (4.3), I manipulate equation (3.1) and come up with the following inequality in terms of threshold interference range, $d_{fue,vf,th}(\cdot)$, for a FUE that is visiting a neighboring FBS.

$$\begin{aligned} d_{fue,vf} &\geq d_{fue,hf} 10^{\frac{1}{N} [P_{tx,vf} - P_{tx,hf} + \gamma_{fue,th}]} \\ &= d_{fue,vf,th}(\cdot) \quad (m) \end{aligned} \tag{4.6}$$

4.3.3 A Case Study and Analysis of PLA

In this subsection, I present and discuss the case study analysis of very important down-link cochannel interference scenario, i.e., when a MUE enters the transmission range of a FBS which is located at the edge of macro cell boundary at about 1000 meters. This numerical analysis is done in *Matlab* by implementing the analytical models developed in previous sub-section for proactive link adaptation (PLA) strategy to achieve non-orthogonal channelization through interference range adaptation. Input parameters used in this numerical analysis are given in Table 4.2.

The results in Fig. 4.5 show threshold interference range for the MUE reception which is visiting a FBS home that is located at the macrocell edge at different FBS interference levels due to different FBS transmit powers and at the MBS maximum transmit power limit. The curved lines in Fig. 4.5 represent FBS interference levels at MUE at different FBS transmit powers as opposed to the straight lines which represent MBS received signal power at its maximum transmit power limit and at the minimum level of received signal power from MBS required, i.e., -103dBm (line with marker \blacklozenge), to support -20dB SINR for maintaining a call. For example, at 10dBm maximum transmit power of FBS at its primary common pilot channel (P-CPICH) (line with marker \blacktriangle), the MUE must be at least 20m away from the FBS to maintain the required SINR of at least -20dB .

The results shown in the Fig. 4.6 demonstrate the upper and lower bounds on the transmit power of FBS as function of the relative ranges of MUE and FUE from FBS. At FBS, I use the adaptive power control (APC) algorithm in [90], i.e., $Max\{P_{tx_min_bound}, P_{tx_min_theoretical}\} \leq P_{tx_practical} \leq Min\{P_{tx_max_bound}, P_{tx_max_theoretical}\}$,

Table 4.2. *Input parameters.*

Parameter	Value
MBS maximum transmit power limit ($P_{tx,max,m}$)	43 dBm
FBS maximum transmit power limits ($P_{tx,max,f}$)	[10, 15, 21] dBm
Min SINR for voice call at UE on PCPICH, ($E_c/N_o = \gamma_{th}$)	-20 dB
$E_b/N_o = \gamma_{th}$	5 dB
Min recd. signal limit at UE on PCPICH ($RSCP_{pcp,min}$)	-103 dBm
MBS antenna gain (G_m)	17 dBi
FBS antenna gain (G_f)	0 dBi
UE antenna gain (G_{ue})	0 dBi
MBS feeders and cable loss ($L_{c,m}$)	3 dB
FBS feeder/connector loss ($L_{c,f}$)	1 dB
UE connector and body loss ($L_{c,u}$)	3 dB
Window loss (L_w)	5 dBm
MBS height (h_m)	25 m
UE height (h_u)	1.5 m
Range between MUE and MBS ($d_{mue,m}$)	1000 m
Speed of light (c)	$3 * (10^8)$ m/s
Frequency of the signal (f)	1920 (MHz)
Chip rate (W)	$(3.84)(10^6)$ cps
Bit rate of AMR voice data (R)	$(12.2)(10^3)$ bps
Processing gain ($G_{W,R}$)	$10\log_{10}(W/R)$ dB

in order to choose its practical minimum and maximum transmit power limits. Accordingly, the practical minimum transmit power limit is chosen from the minimum transmit bound and the minimum theoretical limit at a given interference level, whichever is higher. As can be seen in Fig. 4.6, the line with marker + that represents higher value than the line with marker \square is chosen as the practical minimum transmit power limit. The practical maximum transmit power limit is chosen from the maximum transmit bound and the maximum theoretical limit at a given interference level, whichever is lower. According to the results in Fig. 4.6, the line with marker \circ that presents lower value than the line with marker \triangleright is chosen as the practical

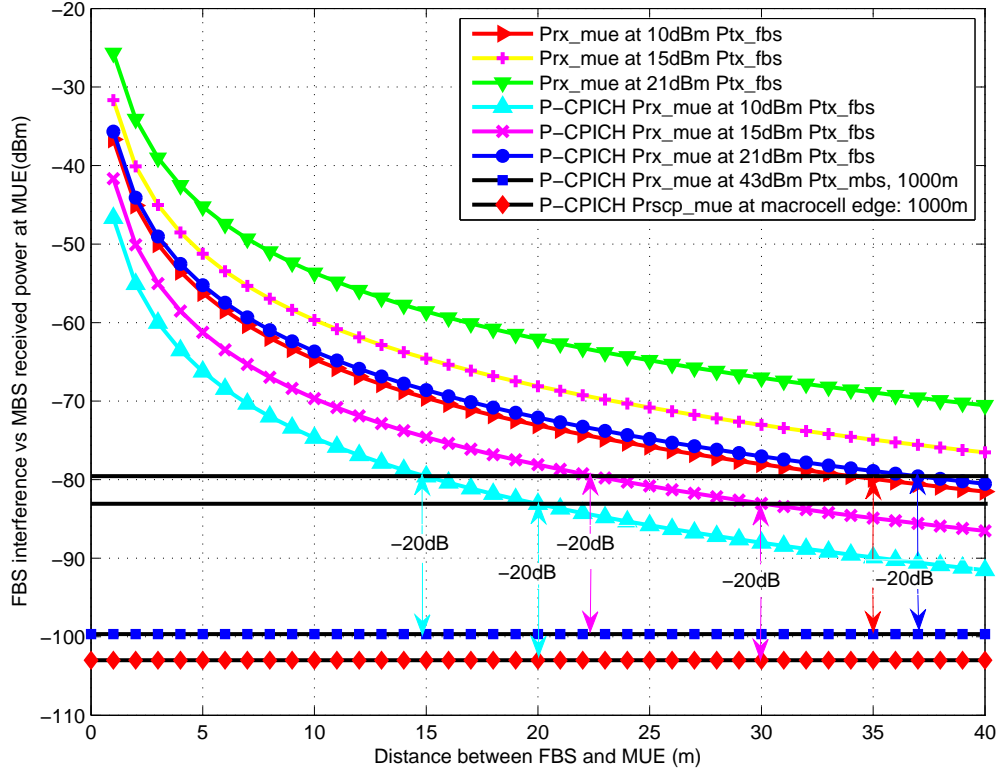

Figure 4.5. *Threshold interference range(s) of a MUE from FBS at the macro cell boundary.*

maximum transmit power limit. For example, if a FUE is 5 meters away from FBS, the practical minimum FBS transmit power limit is the line with marker ∇ . In this scenario, the feasible region for FBS transmit power is the area above the line with marker ∇ and below the line with marker \circ which shows that a MUE has threshold interference range of 8m distance from FBS.

These results provide the understanding of the dynamics of threshold interference ranges as function of transmit powers and relative ranges of radio entities with the value realization of my proposed interference range control strategy, i.e., proactive link adaptation (PLA). There are a number of factors that affect the realization of threshold interference range and its proactive tuning through the proposed PLA strategy. Hard limits are constraints on the transmit powers, i.e., maximum transmit power limit set by the regulatory authority and the minimum transmit power limit which

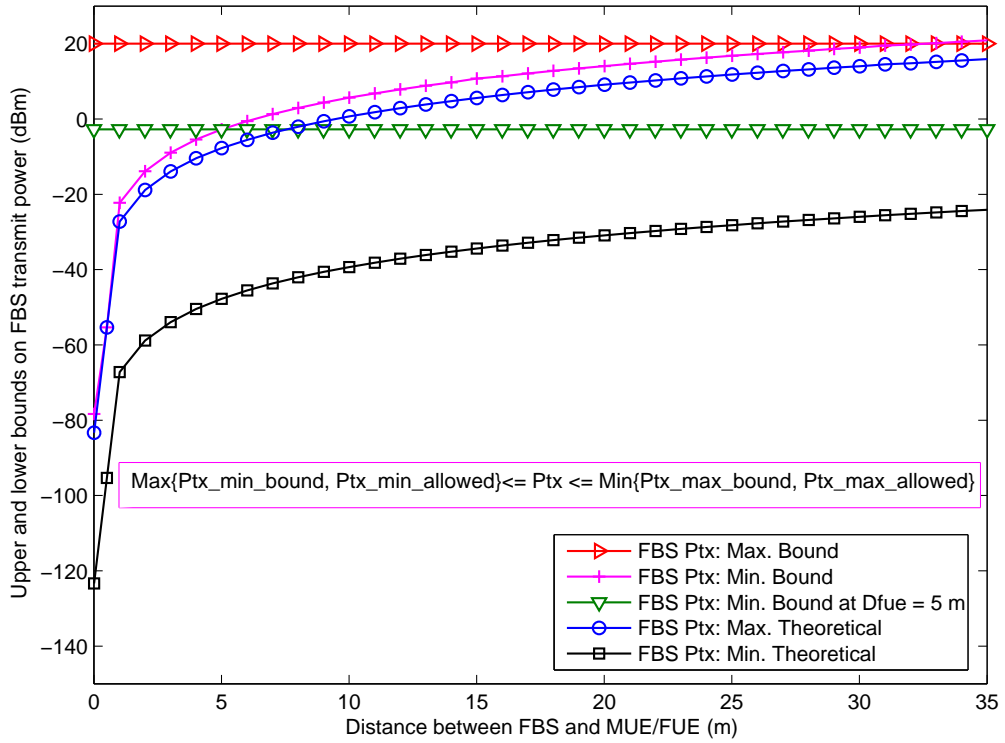

Figure 4.6. Feasible region for SBS transmit powers at macro cell boundary.

is characterized by the receiving ability (sensitivity) of the receiver hardware. There are theoretical limits on maximum and minimum transmit powers, i.e., the maximum theoretical limit is characterized dynamically by the interference level at target MUE and the minimum theoretical limit is characterized by the highest interference level at a FUE among the other active FUEs. Theoretical limits are changing with the change in relative ranges. The results in Fig. 4.6 demonstrate that the feasible region for FBS transmit power would be the region within the practical limits, i.e., the minimum practical limit would be the greater value from the minimum hard and theoretical limits, and the maximum practical limit would be the lower value from the maximum hard and theoretical limits.

The result in Fig. 4.7 presents threshold interference ranges of a MUE from FBS at different FBS transmit power levels. In the proposed PLA strategy, the computation of threshold interference range(s) between the target MUE(s) and the interfering FBS would be required periodically with the current input data such as: transmit powers of MBS and FBS, QoS requirement of target MUE(s) in terms of minimum required

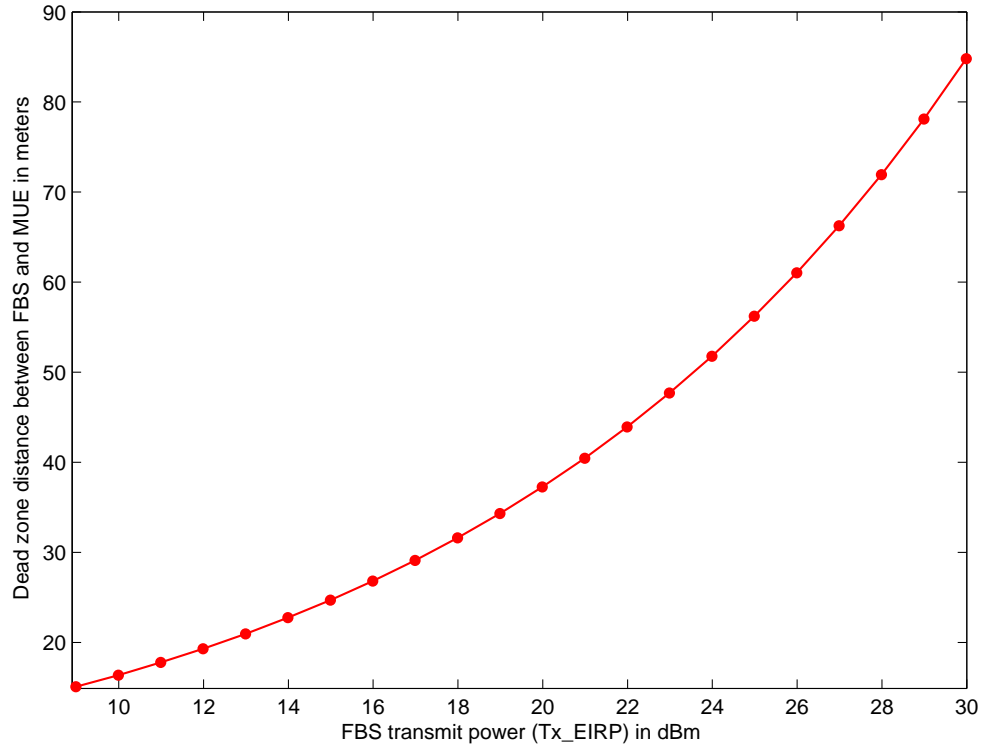

Figure 4.7. *Threshold interference range and interfering transmit power relationship.*

SINR, range of the target MUE(s) from MBS measured at MBS and provided to the computing unit in the same way as done by the interfering FBS. As can be seen in the result, the threshold interference range for MUE has non-linear relationship with FBS transmit power levels, and it increases exponentially with increasing FBS transmit powers.

4.4 Conclusion

The chapter presents research study and analysis of down-link multitier cochannel interference management in femto cell deployment for achieving seamless multitier services in 4G cellular networks. A novel framework, named as Hybrid Radio Resource Sharing (HRRS), is introduced and analyzed at system level. The proposed HRRS framework comprises of two functional modules, referred to as Cognitive Radio Resource Sharing (CRRS) and Proactive Link Adaptation (PLA), that are dynami-

cally invoked according to whether cochannel or partial cochannel deployment can be in place in overlay or underlay like spectrum access modes respectively. Analytical modeling and computation of threshold interference ranges in specific but important downlink interference scenarios is carried out with a case study analysis so as to understand the dynamics of threshold interference ranges as function of transmit powers of MBS and FBS, relative ranges of radio entities, and QoS requirement of services with the value realization of our PLA scheme. Also, a simulative analysis of the proposed CRRS functional module carried out in comparison with the legacy dedicated and cochannel deployments of femtocells concludes valuable results. The results validate that the CRRS strategy substantially empowers the legacy cochannel deployment and provides between 10% to 30% more throughput with the utilization of same number of radio resource elements as in the legacy cochannel deployment. My on-going research is focusing on further consolidating the functional modules, i.e., CRRS and PLA, of the proposed framework through modeling and analysis of intelligent, distributed but cooperative schemes.

Chapter 5

Conclusion and Future Research Outline

The research work presented in this thesis report targeted efficient radio resource sharing jointly with cochannel interference management in multi-tier heterogeneous cellular topology, i.e., 4G HetNets. The general objective of research work is to augment the efforts for better and continuous radio coverage and greater network capacity to support robust and high speed wireless access services. In the following, the chapter-wise summary of research contributions and my future research outline is given.

5.1 Summary of Research Contributions

The chapter-wise summary provided in the following concludes the research report and its contributions.

- ***Introduction:*** I presented an introduction of my research work and an overview discussion on the small cells (femto/WLAN etc.) deployment in the emerging 4G HetNet technologies. The chapter focused on important aspects such as: motivation for the research work, its objectives, and scope.
- ***Background and Literature Survey:*** In this chapter, I presented my research endeavors on background study of the research area and related literature survey. In the background study, I figured out the differentiation between 4G HetNets and traditional 3G and earlier cellular technologies specific to the issues such as radio resource allocation and sharing, network capacity and radio cover-

age requirements, that are related to respective network dynamics, designs, and topologies. Further in this regard, I pointed out architectural aspects, standardization, and research related provisions for small cells (femto cells) deployment in different 3G and 4G cellular networks highlighting the challenges and issues. Recent research approaches and solutions suggested in the literature for efficient radio resource sharing and interference management are also explored and discussed. I also carried out a qualitative research analysis on the benefits and limitations of channel assignment strategies and important techniques proposed in literature.

- ***Research Problem: Description and Modeling:*** I have explained three main aspects of my research work in this chapter. One is defining the research problem, i.e., in precisely manner, subscriber's radio coverage and/or poor link quality problems in radio coverage holes that result into de-rated service or even outage of service, and, in consequence, operator's problems of under-utilized network capacities and loss of market due to poor service. The challenging issues, their causes and effects, related to the research problem, are diagnosed and categorized for determining the directions for improvement. Second, I have presented my research study and analysis on possible solution options and approaches with relevant pros and cons and scopes in relation to my research problem resolution, thereby, justifying the solution choices along with the identification of research challenges affiliated with the research solution choices. Third, research problem scenario is defined with the identification of benefiting architectural provisions in 4G HetNets. Modeling of various aspects of the research problem is carried out such as modeling of: the system; problem and solution spaces. Important bounds, metrics, and parameters related to my solution strategy, are defined and analytically modeled such as: conditions for orthogonal and nonorthogonal channelization; radio resource reuse efficiency; traffic and services dynamics; determination of demand and usability of radio resource elements.
- ***Research Solution, Analysis, and Discussion:*** In this chapter, I introduced a novel research solution to the problem defined in the previous chapter, i.e., efficient radio resource sharing and inter-cell interference coordination

in macro-femto multitier network topology of 4G HetNets, with the research methodology of exploiting spatiotemporal diversities among macro-femto and femto-femto transmissions through OFDMA based medium access. The research solution is named as *Hybrid Radio Resource Sharing (HRRS)* framework that comprises of these two functional modules: *Cognitive Radio Resource Sharing (CRRS)* and *Proactive Link Adaptation (PLA)* scheme. A dynamic switching algorithm is introduced for CRRS and PLA modules to adaptively invoke according to whether orthogonal channelization is to be carried out exploiting the *interweave channel allocation (ICA)* approach or non-orthogonal channelization is to be carried out exploiting the *underlay channel allocation (UCA)* approach respectively when relevant conditions regarding the traffic demand and radio resource availability as defined and modeled in chapter 3 are met.

I carried out a comparative analysis through simulations at system level on the benefits of my CRRS strategy at individual cell nodes in comparison to the legacy full and hard frequency reuse approaches, i.e., *cochannel* and *dedicated* deployments of femto cells respectively.

With regards to the PLA scheme, I defined and modeled threshold interference ranges between radio entities for computations of these to be used in PLA scheme. Then, I carried out a case study and numerical analysis for the PLA scheme so as to understand the dynamics of threshold interference ranges as function of transmit powers of MBS and FBS, relative ranges of radio entities, and QoS requirement of services with the value realization of PLA scheme.

5.2 Future Research Outline

In the pursuit of my defined research problem resolution and subsequent HRRS framework that I proposed in this thesis report, my future research preference would be to develop a framework of schemes named as *Distributed Cooperative Planning and Control (DCPC)* framework for dynamic and adaptive radio resource sharing. The framework provides following four specific components for future research.

- Each cell node would be made capable of having a priori knowledge to some extent on usability or non-usability of radio spectrum with the fine granularity of

each radio resource element in each OFDMA radio frame on a persistent time scale. This capability would be the autonomous but cooperatively acquired intelligence at each cell node. Candidate tools for this solution strategy are: statistical exploitation of recent history of spectrum usage in its own cell and in the interfering cells through software agent (SA) that would enable the cell node with the cooperatively learning capability about the radio spectrum usability status; radio environment listening/sensing the current spectrum usage pattern through spectrum sensing hardware and/or software agent.

- Neighboring cell nodes would be made capable of exchanging knowledge of their interfering links, each others service requirement, and each others radio spectrum utilization status for inter-cell interference coordination. The solution strategy would be the formation of cognitive cell clustering among these cell nodes. Candidate tools for this solution strategy are Intelligent and distributed cooperative approaches such as: multi-agents and coalition game theory.
- Developing the pay-off and cost optimization scheme for the search and determination of the required radio resource is an other research component of DCPC framework. Solution strategy can be a dynamic optimizing scheme under some optimal stopping criterion that would optimize the net pay-off in terms of getting knowledge of the required usable bandwidth at the affordable cost of exploring it in terms of time and energy. Candidate tools can be the dynamic programming techniques to design an optimal stopping criterion based optimization tool to work as a software agent at each radio access entity whether cell node or UE.
- Design of an interference range adaptation mechanism for non-orthogonal radio resource sharing through transmit power and data rate control is another DCPC framework component for future research. The solution strategy would be the design of a proactive link adaptation mechanism that would be augmented with intelligent attributes such as: learning the radio environment, i.e., the dynamics of interference trends on interfering links, based on a posteriori statistics of interference and mobility patterns; and adapting to the radio environment a priori, i.e., range extension or contraction of interfering links through transmit power control, thereby keeping the expected SINR above the target. Candidate

tools are: exploiting the legacy APC and AMC schemes as envisioned in 4G HetNets standardizations; and intelligent software agent (ISA) techniques that would provide learning and adapting attributes to solution.

Bibliography

- [1] *Global mobile statistics 2011*. <http://mobithinking.com/mobile-marketing-tools/latest-mobile-stats#smartphone-shipments>
- [2] *Radio-Electronics.com*, Resources and analysis for electronics engineers. <http://www.radio-electronics.com/info/cellulartelecomms/index.php>
- [3] *Small Cell Forum*, “Small cells – what’s the big idea?” Feb. 15, 2012. www.smallcellforum.org
- [4] Vikram Chandrasekhar, Jeffrey G. Andrews, “Femtocell Networks: A Survey,” *IEEE Communications Magazine*, pp. 59-67, Sept. 2008.
- [5] *Coopers Law*: <http://www.arraycomm.com/technology/coopers-law>
- [6] Presentations by ABI Research, Picochip, Airvana, IP.access, Gartner, Telefonica Espana; *2nd International Conference on Home Access Points and Femtocells, 2007*. http://www.avrenevents.com/dallasfemto2007/purchase_presentations.htm
- [7] Sara Landström, Anders FuruskÅr, Klas Johansson, Laetitia Falconetti and Fredric Kronestedt, “Heterogeneous networks – increasing cellular capacity,” *Ericsson Review, the communications technology journal since 1924*, 1/2011. http://www1.ericsson.com/kr/res/thecompany/docs/publications/ericsson_review/2011/Ericsson-Review-2011-1.pdf#page=4
- [8] Volker Pauli, Juan Diego Naranjo, Eiko Seidel, “Heterogeneous LTE Networks and Inter-Cell Interference Coordination,” A *White Paper* from: *Novel Mobile Radio (NOMOR) Research*, Dec. 2010. http://www.nomor.de/uploads/a4/81/a4815c4dc585be33c81f0ec7a15deed7/2010-12-WhitePaper_LTE_HetNet_ICIC.pdf
- [9] “A Comparison of LTE Advanced HetNets and Wi-Fi,” *Qualcomm Incorporated*, Oct. 2011. <http://www.qualcomm.com/media/documents/comparison-lte-advanced-hetnets-and-wifi>
- [10] David Lopez-Prez, Alvaro Valcarce, Guillaume de la Roche, and Jie Zhang, “OFDMA Femtocells: A Roadmap on Interference Avoidance,” *IEEE Communications Magazine*, V47, Issue 9, pp. 41-48, Sept. 2009.
- [11] Douglas N. Knisely, Takahito Yoshizawa, Frank Favichia, “Standardization of Femtocells in 3GPP,” *IEEE Communications Magazine*, V47, Issue 9, pp. 68-75, Sept. 2009.

- [12] Douglas N. Knisely, Frank Favichia, "Standardization of Femtocells in 3GPP2," *IEEE Communications Magazine*, V47, Issue 9, pp. 76-82, Sept. 2009.
- [13] *WiMAX Forum*, "Requirements for WiMAX Femtocell Systems, Version 1.0.0," April 2009.
- [14] *3rd Generation Partnership Project*, LTE: Evolved Universal Terrestrial Radio Access (E-UTRA) and Evolved Universal Terrestrial Radio Access Network (E-UTRAN); Overall description (Release 10); Stage 2, 3GPP TS 36.300 V10.2.0, Jan. 2011.
- [15] *3rd Generation Partnership Project*, Technical Specification Group Radio Access Network, Evolved Universal Terrestrial Radio Access (E-UTRA), FDD Home eNode B (HeNB) Radio Frequency (RF) requirements analysis (Release 9), 3GPP TR 36.921 V9.0.0, March 2010.
- [16] *3rd Generation Partnership Project*, Technical Specification Group Radio Access Networks, FDD Home NodeB RF Requirements Work Item Technical Report (Release 8), 3GPP TR 25.967 2.0.0, Feb 2009.
- [17] *3GPP* R4-091976, LTE-FDD HeNB interference scenarios, RAN4 No.51, May 2009.
- [18] TS 36.420, "E-UTRAN: X2 General Aspects and Principles," *Release 9*, Dec. 2009.
- [19] RP-101229, RAN2, "CRs on Core part: Enhanced ICIC for non-CA based deployments of heterogeneous networks for LTE RAN2," *3GPP TSG*, RAN meeting No.50.
- [20] Ronny Yongho Kim, Jin Sam Kwak, Kamran Etemad, "WiMAX Femtocell: Requirements, Challenges, and Solutions," *IEEE Communications Magazine*, V47, Issue 9, pp. 84-91, Sept. 2009.
- [21] Pierre Humblet, Balaji Raghothaman, Anand Srinivas, Srinivasan Balasubramanian, Chirag Patel, and Mehmet Yavuz, "System Design of cdma2000 Femtocells," *IEEE Communications Magazine*, V47, Issue 9, pp. 92-100, Sept. 2009.
- [22] *3rd Generation Partnership Project*, "Home Node B Radio Frequency (RF) Requirements (FDD) (Release 9)," 3GPP TR 25.967 V900, May 2009.
- [23] "Evolved Universal Terrestrial Radio Access (E-UTRA); TDD Home eNode B (HeNB) Radio Frequency (RF) requirements analysis (Release 9)," *3GPP* TR 36.922 V9.1.0, June 2010.
- [24] Assen Golaup, Mona Mustapha, and Leo Boonchin Patanapongpibul, "Femtocell Access Control Strategy in UMTS and LTE," *IEEE Communications Magazine*, V47, Issue 9, pp. 117-123, Sept. 2009.
- [25] Fabio M. Chiussi, Dimitris Logothetis, Indra Widjaja, Deepak Kataria, "GUEST EDITORIAL," *IEEE Communications Magazine*, V47, Issue 9, pp. 66-67, Sept. 2009.
- [26] "LTE; Evolved Universal Terrestrial Radio Access Network (E-UTRAN); Stage 2 functional specification of User Equipment (UE) positioning in E-UTRAN (Release 10)," *3GPP* TS 36.305 V10.0.0, January 2011.

- [27] LTE; Evolved Universal Terrestrial Radio Access (E-UTRA); LTE Positioning Protocol (LPP), (Release 10), 3GPP TS 36.355 V10.0.0, January 2011.
- [28] IS-GPS-200, Revision D, Navstar GPS Space Segment/Navigation User Interfaces, March 7, 2006.
- [29] IS-GPS-705, Navstar GPS Space Segment/User Segment L5 Interfaces, September 22, 2005.
- [30] IS-GPS-800, Navstar GPS Space Segment/User Segment L1C Interfaces, September 4, 2008.
- [31] Galileo OS Signal in Space ICD (OS SIS ICD), Draft 0, Galileo Joint Undertaking, May 23, 2006.
- [32] Global Navigation Satellite System GLONASS Interface Control Document, Ver. 5, 2002.
- [33] IS-QZSS, Quasi Zenith Satellite System Navigation Service Interface Specifications for QZSS, Ver.1.0, June 17, 2008.
- [34] Specification for the Wide Area Augmentation System (WAAS), US Department of Transportation, Federal Aviation Administration, DTFA01-96-C-00025, 2001.
- [35] 3GPP TS 36.214: “Evolved Universal Terrestrial Radio Access (E-UTRA); Physical layer Measurements.”
- [36] 3GPP TS 36.302: “Evolved Universal Terrestrial Radio Access (E-UTRA); Services provided by the physical layer.”
- [37] K. Pahlavan, X. Li, and J. Makela, “Indoor geolocation science and technology,” *IEEE Communication Magazine*, V40, No. 2, pp. 112118, Feb. 2002.
- [38] X. Li, K. Pahlavan, M. Latva-aho, and M. Ylianttila, “Comparison of indoor geolocation methods in DSSS and OFDM wireless LAN,” *IEEE Vehicular Technology Conference*, V6, pp. 30153020, Sept. 2000.
- [39] B. B. Peterson, C. Kmiecik, R. Hartnett, P. M. Thompson, J. Mendoza, and H. Nguyen, “Spread spectrum indoor geolocation,” *J. Inst. Navigat.*, V45, No. 2, pp. 97102, 1998.
- [40] N. S. Correal, S. Kyperountas, Q. Shi, and M. Welborn, “An ultrawideband relative location system,” in Proceedings, *IEEE Conference of Ultra Wideband Systems Technology*, pp. 394397, Nov. 2003.
- [41] M. Kanaan and K. Pahlavan, “A comparison of wireless geolocation algorithms in the indoor environment,” in Proceedings, *IEEE Wireless Communications Networking Conference*, V1, pp. 177182, 2004.
- [42] B. Fang, “Simple solution for hyperbolic and related position fixes,” *IEEE Transactions Aerosp. Electron. Syst.*, V26, No. 5, pp. 748753, Sep. 1990.
- [43] C. Drane, M. Macnaughtan, and C. Scott, “Positioning GSM telephones,” *IEEE Communication Magazine*, V36, No. 4, pp. 4654, 59, Apr. 1998.

- [44] D. Torrieri, "Statistical theory of passive location systems," *IEEE Trans. Aerosp. Electron. Syst.*, V20, No. 2, pp. 183197, Mar. 1984.
- [45] R. J. Fontana, E. Richley, and J. Barney, "Commercialization of an ultra wideband precision asset location system," *IEEE Ultra Wideband Systems Technology Conference*, Reston, VA, pp. 369373, Nov. 2003.
- [46] A. Teuber and B. Eissfeller, "Atwo-stage fuzzy logic approach for wireless LAN indoor positioning," *IEEE/ION Position Location Navigation Symposium*, V4, pp. 730738, April 2006.
- [47] J.Zhou, K. M.-K.Chu, and J. K.-Y. Ng, "Providing location services within a radio cellular network using ellipse propagation model," *International Conference on Advanced Information Networking and Applications*, pp. 559564, March 2005.
- [48] A. Gunther and C. Hoene, "Measuring round trip times to determine the distance between WLAN nodes," in *Proceedings, Netw. 2005*, Waterloo, ON, Canada, pp. 768779, May 2005
- [49] M. Kossel, H. R. Benedickter, R. Peter, and W. Bachtold, "Microwave backscatter modulation systems," *IEEE MTT-S Dig.*, V3, pp. 14271430, June 2000.
- [50] R. J. Fontana, "Recent system applications of short-pulse ultra-wideband (UWB) technology," *IEEE Transaction on Microwave Theory and Technology*, V52, No. 9, pp. 20872104, Sept. 2004.
- [51] S. Gezici, Z. Tian, G. V. Giannakis, H. Kobaysahi, A. F. Molisch, H. V. Poor, and Z. Sahinoglu, "Localization via ultra-wideband radios: A look at positioning aspects for future sensor networks," *IEEE Signal Processing Magazine*, V22, No. 4, pp. 7084, July 2005.
- [52] B. Ottersten, M. Viberg, P. Stoica, and A. Nehorai, "Exact and large sample ML techniques for parameter estimation and detection in array processing," in *Radar Array Processing*, S. S. Haykin, J. Litva, and T. J. Shepherd, Eds. New York: Springer-Verlag, pp. 99151, 1993.
- [53] B. D. Van Veen and K. M. Buckley, "Beamforming: A versatile approach to spatial filtering," *IEEE ASSP Magazine*, V5, No. 2, pp. 424, Apr. 1988.
- [54] P. Kontkanen, P. Myllymaki, T. Roos, H. Tirri, K. Valtonen, and H. Wettig, "Topics in probabilistic location estimation in wireless networks," *15th IEEE Symposium Pers., Indoor, Mobile Radio Communication, Barcelona, Spain*, V2, pp. 10521056, Sep. 2004.
- [55] V. Vapnik, "The Nature of Statistical Learning Theory," New York: Springer, 1995.
- [56] V. Kecman, "Learning and Soft Computing," Cambridge, MA: MIT Press, 2001.
- [57] M. Brunato and R. Battiti, "Statistical learning theory for location fingerprinting in wireless LANs," *Computer Networking, Elsevier*, V47, Issue 6, pp. 825845, 2005.
- [58] P. Prasithsangaree, P. Krishnamurthi, and P. K. Chrysanthis, "On indoor position

- with wireless LANs,” *IEEE Int. Symp. Pers. Indoor, Mobile Radio Communications*, V2, pp. 720724, Sept. 2002.
- [59] L. M. Ni, Y. Liu, Y. C. Lau, and A. P. Patil, “LANDMARC: Indoor location sensing using active RFID,” *Wireless Networking, Springer*, V10, No. 6, pp. 701710, Nov. 2004.
- [60] J. Hightower, R. Want, and G. Borriello, “SpotON: An indoor 3D location sensing technology based on RF signal strength,” University of Washington, Seattle, Tech. Rep. UW CSE 200002-02, Feb. 2000.
- [61] J. J. Caffery and G. L. Stuber, “Overview of radiolocation in CDMA cellular system,” *IEEE Communication Magazine*, V36, No. 4, pp. 3845, April 1998.
- [62] V. Otsason, A. Varshavsky, A. LaMarca, and E. de Lara, “Accurate GSM indoor localization,” UbiComp 2005, Lecture Notes Computer Science, Springer-Verlag, V3660, pp. 141158, 2005.
- [63] I. Katzela, M. Naghshineh, “Channel Assignment Schemes for Cellular Mobile Telecommunication Systems: A Comprehensive Survey,” *Communications Surveys & Tutorials, IEEE Journal*, V3, Issue 2, pp. 10-31, April, 2000.
- [64] E. L. Bodanese, “A Distributed Channel Allocation Scheme for Cellular Networks using Intelligent Software Agents,” *PhD Thesis, University of London, London, UK*, Nov. 2000.
- [65] Ying-Chang Liang, Kwang-Cheng Chen, Geoffrey Ye Li, and Petri Mahonen, “Cognitive Radio Networking and Communications: An Overview,” *IEEE Transactions on Vehicular Technology*, V60, Issue 7, pp. 3386-3407, Sept. 2011.
- [66] Antonio De Domenico, Emilio Calvanese Strinati, and Maria-Gabriella Di Benedetto, “A Survey on MAC Strategies for Cognitive Radio Networks,” *Communications Surveys & Tutorials, IEEE Journal*, V14, Issue 1, pp. 21-44, First Quarter, 2012.
- [67] Chih-Lin I, Pi-Hui Chao, “Local Packing - Distributed Dynamic Channel Allocation at Cellular Base Station,” *IEEE GLOBECOM*, V1, pp. 293-301, 1993.
- [68] Y. Furuya, Y. Akaiwa, “Channel Segregation, a Distributed Adaptive Channel Allocation Scheme for Mobile Communication Systems,” *IEICE Transactions*, V.E74, pp. 1531-1537, June 1991.
- [69] Y. Akaiwa, H. Andoh, “Channel Segregation - A Self-organized Dynamic Channel Allocation Method: Application to TDMA/FDMA Microcellular System,” *IEEE Journal on Selected Areas in Communications (JSAC)*, V11 NO. 6, pp. 949-954, Aug. 1993.
- [70] S.W. Halpern, “Reuse Partitioning in Cellular Systems,” *IEEE Transactions on Vehicular Technology*, pp. 322-327, 1983.
- [71] J. Zande, and J. Frodigh, “Capacity Allocation and Channel Assignment in Cellular Radio Systems using Reuse Partitioning,” *Elect. Lett.*, V28, 1991.
- [72] T. Kanai, “Autonomous Reuse Partitioning in Cellular Systems,” *IEEE VTC*, 1985.

- [73] S. Onoe, and S. Yasuda, "Flexible Re-use for Dynamic Channel Assignment in Mobile Radio Systems," *Proc. IEEE ICC*, pp. 472-476, 1989.
- [74] H. Furukawa, Y. Akaiwa, "Self Organized Reuse Partitioning, a Dynamic Channel Assignment Method in Cellular System," *in Proc., 43rd IEEE VTC*, pp. 524-527, 1993.
- [75] W. Wong, S.A. El-Dolil, and R. Steele, "Teletraffic Performance of Highway Microcells with Overlay Macrocells," *IEEE JSAC*, pp. 71-78, 1989.
- [76] C. Stevenson et al., "IEEE 802.22: The First Cognitive Radio Wireless Regional Area Network Standard," *IEEE Communication Magazine*, V47, no. 1, pp. 13038, Jan. 2009.
- [77] S. Weber, J. G. Andrews, X. Yang, and G. de Veciana, "Transmission Capacity of Ad Hoc Networks with Successive Interference Cancellation," *IEEE Transactions on Information Theory*, V53, No. 8, pp. 2799 - 2814, Aug. 2007.
- [78] Xiangfang Li, Lijun Qian, Deepak Kataria, "Downlink Power Control in Co-channel Macrocell Femtocell Overlay," *Information Sciences and Systems, CISS 2009, 43rd Annual Conference*, 2009.
- [79] Hasari Celebi, Huseyin Arslan, "Cognitive Positioning Systems," *IEEE Transactions on Wireless Communications*, Vol. 6, NO. 12, pp. 4475-4483, Dec. 2007.
- [80] Mehmet Yavuz, Farhad Meshkati, Sanjiv Nanda, Akhilesh Pokhariyal, Nick Johnson, Balaji Raghothaman, and Andy Richardson, "Interference Management and Performance Analysis of UMTS/HSPA+ Femtocells," *IEEE Communications Magazine*, V47, Issue 9, P 102-109, Sept 2009.
- [81] Y. Tokgoz et al. "Uplink Interference Management for HSPA+ and 1x EVDO Femtocells," *IEEE GLOBECOM Conference Proceedings, Honolulu, HI*, pp. 1-7, Dec. 2009.
- [82] C. Shannon, "A Mathematical Theory of Communication," *Bell System Technical Journal*, V27, pp. 379-423, 623-656, Oct. 1948.
- [83] *3rd Generation Partnership Project*, LTE: Evolved Universal Terrestrial Radio Access (E-UTRA) and Evolved Universal Terrestrial Radio Access Network (E-UTRAN); Overall description (Release 10); Stage 2, 3GPP TS 36.300 V10.2.0, Jan. 2011.
- [84] *IEEE std. 802.11-1999*, Wireless LAN Medium Access Control (MAC) and Physical Layer (PHY) specifications. 1999.
- [85] *IEEE Std. 802.11e/D13.0*, "Part 11: Wireless LAN Medium Access Control (MAC) and Physical Layer (PHY) Specifications: Amendment: Medium Access Control (MAC) Quality of Service (QoS) Enhancements," Jan. 2005.
- [86] *Femto Forum*, "Interference Management in UMTS Femtocells."
http://www.femtoforum.org/femto/Files/File/FF_UMTS-Interference_Management.pdf
- [87] T. Yücek and H. Arslan, "A Survey of Spectrum Sensing Algorithms for Cognitive

- Radio Applications,” *IEEE Communicatins Surveys & Tutorials*, V11, No. 1, pp. 116-130, First Quarter 2009.
- [88] *International Telecommunication Union*, “ITU-R Recommendations P.1238: Propagation data and prediction models for the planning of indoor radiocommunications systems and radio local area networks in the frequency range 900MHz to 100GHz,” Geneva, 1997.
- [89] *International Telecommunication Union*, “ITU-R Recommendations P.1411-3: Propagation data and prediction methods for the planning of short range outdoor radiocommunication systems and radio local area networks in the frequency range 300 MHz to 100 GHz,” Geneva, 2005.
- [90] Xiangfang Li, Lijun Qian, Deepak Kataria, “Downlink Power Control in Co-channel Macrocell Femtocell Overlay,” appears in *43rd Annual Conference on Information Sciences and Systems (CISS 2009)*, pp. 383-388, March 2009.