

Cultural Connectivity:

Design as a method to facilitate cultural exchange within the Gerrard Bazaar

by

Sundus Shaikh

A thesis
presented to the University of Waterloo
in fulfillment of the
thesis requirement for the degree of
Master of Architecture
in
Engineering

Waterloo, Ontario, Canada, 2015

© Sundus Shaikh 2015

AUTHOR'S DECLARATION |

I hereby declare that I am the sole author of this thesis. This is a true copy of the thesis, including any required final revisions, as accepted by my examiners. I understand that my thesis may be made electronically available to the public.

ABSTRACT |

As immigrants choose to reside within the suburbs and the city undergoes rapid geographical change, Toronto's ethnic enclaves are facing significant transformation in terms of their neighbourhood demographics, economic conditions and function. The Gerrard Bazaar is a prime example of an ethnic retail strip that is struggling with a changing identity and day-to-day role, as the South Asian population gradually reduces within the area, while young, non-South Asian families continue to move in. Once a thriving Indo-Pakistani retail destination, which began from a modest movie theatre, the ethnic enclave has witnessed significant economic decline leading to fluctuating levels of urban vacancy. Among the many South Asian shops, there lies an increasing presence of mainstream coffee shops and specialty stores that have replaced declining South Asian retail enterprises over time. Various social and business organizations are also situated along the strip, yet a significant number of their efforts to regenerate the enclave, operate in an isolated manner. There also remains a cultural divide within the area as well as a general lack of solidarity among the merchants and organizations within the bazaar.

This thesis suggests that the key to reviving the Bazaar as well as other declining ethnic enclaves, lies in promoting new networks of "cultural exchange" in which architecture and urban design can be a facilitator of new interactions and symbiotic relationships among different organizations and individuals. It comprises of a demographic, historic, architectural and spatial analysis as well as in-depth human research that studies how visitors and inhabitants of the Gerrard Bazaar perceive the ethnic enclave, and what culture means to them. These discovered

studies and personal insights influence the design process and are meant to serve as a new technique by which one can study the notion of culture and how it informs architecture and urban interventions. Thus, the focus of thesis is on the method by which architecture and design is produced, in response to the lack of cultural exchange.

The way in which this method translates research into design, is by the formulation of a manual of "design strategies" that serves as a template for the design intervention. This manual is applied to three different sites within the Gerrard Bazaar, for three types of unique design proposals - A re-activated plaza, an adaptively re-used square and a re-imagined senior's residential complex. These proposals are not meant to "freeze" the changes that are taking place within the Gerrard Bazaar, but rather, respond to the gentrification in a positive manner and acknowledge the demographic trend that is transpiring within the neighbourhood.

It is envisioned that these new interventions would act as catalysts in fostering a new sense of community and revitalizing the day-to-day life of the neighbourhood. In addition, they would serve to optimize the existing functions and events of the ethnic enclave and act as anchor points along the strip. Moreover, the presence of these interventions and the changes that they bring, are meant to help the bazaar pave the path to a new identity where its cultural heritage is shared and promoted, yet its demographic and cultural transition are acknowledged and integrated.

ACKNOWLEDGEMENTS |

I would like to thank my supervisor, Mona El Khaffif, for helping me initiate my thesis and continuously guiding me throughout my time of study. I would also like to thank my committee members, Adrian Blackwell and Val Rynnimeri, for helping me with my over-arching idea and path of development.

A fundamental part of this thesis involved communicating with various visitors, residents and professionals within the Gerrard Bazaar as well conducting surveys and interviews with anonymous respondents throughout the GTA. I would like to thank all of these individuals for their participation and eagerness to help.

Finally, I would like to thank my family for their continuous support and encouragement throughout my thesis. Thank you for your motivation, inspiration and care.

DEDICATION |

To my sister

*My best friend,
My role model,
My source of guidance and support.*

Love you always.

CONTENTS |

Author's Declaration	ii
Abstract	iii
Acknowledgments	iv
Dedication	v
List of Illustrations	vii

Introduction	2
---------------------	----------

Chapter 1: Diversity, Culture + Ethnic Enclaves in Toronto	7
---	----------

1.1 Glossary of Key Terminology	8
1.2 Diversity and Immigration in Toronto	9
1.3 South Asian Immigration and Establishment	12
1.4 The Discourse on Ethnic Enclaves	22
1.5 Methodology	28
Endnotes	32

Chapter 2: Historic and Demographic Analysis of Gerrard Bazaar	33
---	-----------

2.1 Site history	34
2.2 Current Demographics	49
2.3 Current Conditions and Initiatives	54
Endnotes	62

Chapter 3: Architectural and Spatial Analysis of Gerrard Bazaar	63
--	-----------

3.1 Use and programs	64
3.2 Spatial Transformation and Composition	74
3.3 Architectural and Formal Composition	84
3.4 Architectural and Spatial Analysis in Relation to Design	140
Endnotes	142

Chapter 4: Personal Perspectives of Gerrard Bazaar	143
---	------------

4.1 Perspectives of a South Asian	144
4.2 Personal Survey and analysis	146
4.3 Respondent Mapping Analysis	161
4.4 Personal Interviews and Analysis	162
4.5 Personal Input Analysis in Relation to Design	183

Chapter 5: Design Interventions and Cultural Exchange	187
--	------------

5.1 Research Analysis & Design Direction	188
5.2 Precedents	194
5.3 Networks & Siting	214
5.4 Designing for Cultural Exchange	224
5.5 Potential for Modification and Implementation	328
Endnotes	334

Conclusion	335
-------------------	------------

Bibliography	340
---------------------	------------

Appendix	350
-----------------	------------

LIST OF ILLUSTRATIONS |

*All illustrations produced by author unless otherwise noted

xix	Fig 0.01	Ethnic Enclaves within the GTA	13	Fig 1.06	Gur Sikh temple, one of the first in North America Abbotsford gur sikh temple. in Trip Advisor [database online]. 2015 [cited 03/26 2015]. Available from http://www.tripadvisor.ca/Attraction_Review-g181725-d1867352-Reviews-Abbotsford_Gur_Sikh_Temple-Abbotsford_British_Columbia.html .	24	Fig 1.16	A street in Little Portugal Almeida, Gustavo. 2008. Little portugal toronto. Skyscraper city.	42	Fig 2.09	Timeline diagrams (Gerrard Ashdale neighbourhood) 1961 - 1970
2	Fig 0.02	The Canadian flag depicting the idea of Cultural Mosaic Cultural mosaic. in Central Alberta Refugee Effort [database online]. 2014 [cited 03/26 2015]. Available from http://immigrant-centre.ca/cultural-mosaic/ .	14	Fig 1.07	SAVAC Office South asian visual arts centre. in Gallery Finder [database online]. 2013 Available from http://galleryfinder.ca/south-asian-visual-arts-centre-savac (accessed 01/29 2015).	25	Fig 1.17	Gentrification in Torontonion neighbourhoods, 1961 - 2001 Gentrification trends. [cited 03/27 2015]. Available from http://uwebip.httpcv.com/gentrification-trends.php .	43	Fig 2.10	Timeline diagrams (Gerrard Ashdale neighbourhood) 1970 - 1980
3	Fig 0.03	Article written about Gerrard Bazaar during its prosperous times Plummer, Kevin. Historicist: Nights out at the naaz theatre. in Torontoist [database online]. 2012 [cited 03/25 2015]. Available from http://torontoist.com/2012/01/historicist-nights-out-at-the-naaz-theatre/ .	15	Fig 1.08	Shahrukh Khan, a famous Bollywood actor, at the Indian International Film Awards in Toronto IIFA awards green carpet. in The Windsor Star [database online]. 2015 [cited 03/26 2015]. Available from http://www.windsorstar.com/life/Photos+IIFA+Awards+Green+Carpet/5008722/story.html .	26	Fig 1.18	Views of ethnic enclaves as presented by different scholars	44	Fig 2.11	Timeline diagrams (Gerrard Ashdale neighbourhood) 1990 - 1995
9	Fig 1.01	Word diagram of mother-tongue spoken in Toronto Language diversity across toronto's 44 wards; based on 2006 census data. in Reddit [database online]. 2015 [cited 03/26 2015]. Available from http://www.reddit.com/r/toronto/related/1c3b8l/language_diversity_across_torontos_44_wards_based/ .	16	Fig 1.09	South Asian clusters within GTA (higher to lower density)	27	Fig 1.19	Key points made by Qadeer on ethnic enclaves	45	Fig.2.12	Timeline diagrams (Gerrard Ashdale neighbourhood) 1996 - 2006
10	Fig 1.02	Percentage of immigrants in GTA over time	17	Fig 1.10	Immigration (Indians and Pakistanis) in relation to Naaz Theatre	28	Fig 1.20	Thesis methodology diagram - chapters 1 and 2	46-47	Fig 2.13	Key catalysts within historic timeline
11	Fig 1.03	Growth of visible minorities in Canada Ethnic diversity and immigration. in Statistics Canada [database online]. 2007 [cited 03/26 2015]. Available from http://www41.statcan.gc.ca/2007/30000/ceb30000_000-eng.htm .	18-19	Fig 1.11	Timeline of South Asians within the GTA	29	Fig 1.21	Thesis methodology diagram - chapters 3 and 4	49	Fig 2.14	Nearby resident within the Gerrard Bazaar
	Fig 1.04	Immigrants in selected cities Ibid.	20	Fig 1.12	Suhaag South Asian Wedding show in Toronto Suhaag show delivers again! in The Weekly Voice [database online]. 2015 [cited 03/26 2015]. Available from http://www.weeklyvoice.com/community-news/suhaag-show-delivers-again/ .	30	Fig 1.22	Thesis methodology diagram - chapter 5	50	Fig 2.15	South Asian clusters within 5km of Gerrard Bazaar
12	Fig 1.05	First arrival of Sikhs in Canada Singh Sangra, Satnam. Early 20th century canadian immigration policy and asian immigrants - the story of the komagata maru. in Vancouver Media Co-op [database online]. 2011 Available from http://vancouver.mediacoop.ca/newsrelease/7354 (accessed january 29, 2015).	21	Fig 1.13	Miss Pakistan World Beauty Pageant in Toronto Miss pakistan world 2013. 2013 [cited 03/26 2015]. Available from http://misspakistanworld.com/miss-pakistan-world-2013/ .	34	Fig 2.01	Advertisement of the Gerrard Bazaar	51	Fig 2.16	South Asian clusters within 5km of Gerrard Bazaar - key demographic information
			22	Fig 1.14	A street sign in Greektown, Toronto Border town. in Divided Cities [database online]. 2012 [cited 03/22 2015]. Available from http://dividedcities.com/post/11361304852/deb-chachra-is-one-of-the-godparents-of-border .	35	Fig 2.02	Site of the Gerrard Bazaar	52	Fig 2.17	Neighbourhoods adjacent to Gerrard Bazaar
			23	Fig 1.15	Signs in Chinatown, Toronto Chinatown's street signs toronto ontario canada. in Hicker-Stock-Photography [database online]. 2015 [cited 02/06 2015]. Available from http://www.hicker-stock-photography.com/stockphoto/chinatowns-street-signs-toronto-ontario-canada-73.htm .	36	Fig 2.03	Ashbridge's family home Bauder, Harald, and Angelica Suorineni. Toronto's Little India: A Brief Neighbourhood History. Toronto, Ont.: Ryerson University, 2010. Print.	53	Fig 2.18	Neighbourhoods adjacent to Gerrard Bazaar - key demographic information
						37	Fig 2.04	Gerrard Street, 1911 Ibid.	54	Fig 2.19	Diagram depicting evolving storefronts within the Gerrard Bazaar
						38	Fig 2.05	Gerrard Street, 1926 Ibid.	55	Fig 2.20	Evolution of the Naaz Theatre to apartments
						39	Fig 2.06	The Naaz Theatre Brown, Tyson. 2012. Paksitani heritage in toronto: Faith and family. Heritage toronto.	56	Fig 2.21	Transformation of a vacant store to non-South Asian coffee shop
						40	Fig 2.07	Timeline diagrams (Gerrard Ashdale neighbourhood) 1910 - 1919	57	Fig 2.22	Retail statistics over time - Gerrard Bazaar
						41	Fig 2.08	Timeline diagrams (Gerrard Ashdale neighbourhood) 1920 - 1946	58	Fig 2.23	Winter time at the Gerrard Bazaar
									59	Fig 2.24	Pigeons fed by storeowners
										Fig 2.25	Pigeon droppings on the street
										Fig 2.26	Large painted mural along the western part of the Bazaar
										Fig 2.27	Indian-inspired mural on library wall
										Fig 2.28	Painted murals along wall of Bombay

		Chowpatty	84	Fig 3.19	Inside of a souvenir shop
60	Fig 2.29	The Gerrard Bazaar BIA boundary	85	Fig 3.20	Clothes displayed outside of a fabric store
61	Fig 2.30	BIA operational structure	86	Fig 3.21	Analyzed stores - key axonometric diagram
64-65	Fig 3.01	Programmatic plan of the Gerrard Bazaar neighbourhood (within 0.5km)	87	Fig 3.22	Analyzed stores - key image diagram
66-67	Fig 3.02	Programmatic axonometric of Gerrard Bazaar depicting existing and potential networks	89	Fig 3.23	Meeting room Dislocations A scotiabank CONTACT featured exhibition 2013. in Wordpress [database online]. 2013 Available from https://dislocations2013.wordpress.com/ (accessed 01/30 2015).
69	Fig 3.03	Key architectural elements and key entities on site		Fig 3.24	Fair trade cafe Ibid.
70	Fig 3.04	Key entities		Fig 3.25	Rainwater garden Ibid.
	Fig 3.05	Vacant sites		Fig 3.26	Event space Ibid.
71	Fig 3.06	Designated plots		Fig 3.27	Diagram of Riverdale Hub (main level)
	Fig 3.07	Private/ fenced up plots		Fig 3.28	Riverdale Hub - analytical diagrams
72-73	Fig 3.08	Networks between key entitites	90	Fig 3.29	Tables along the rolling doors on west wall
74	Fig 3.09	People lighting fireworks during Diwali	91	Fig 3.30	Flexible open hall space upstairs
75	Fig 3.10	The Festival of South Asia	93	Fig 3.31	Service counter and food display cases within the restaurant
76	Fig 3.11	Eid diagrams and infographs		Fig 3.32	Tables along the rolling doors on west wall
77	Fig 3.12	Eid celebrations within the Gerrard Bazaar Syed, Aman. 2012. Chand raat of eid al fitr 2012 gerrard street, toronto.		Fig 3.33	Diagram of Lahore Tikka House (main level)
78	Fig 3.13	Diwali diagrams and infographs	94	Fig 3.34	Lahore Tikka House - analytical diagrams
79	Fig 3.14	Diwali celebrations within the Gerrard Bazaar	95	Fig 3.35	Retail aisle
80	Fig 3.15	Vaisakhi diagrams and infographs	97	Fig 3.36	Retail aisle
81	Fig 3.16	Vaisakhi celebrations within the Gerrard Bazaar		Fig 3.37	Exterior food display
82	Fig 3.17	Festival of South Asia diagrams and infographs		Fig 3.38	Exterior food display
83	Fig 3.18	Festival of South Asia celebrations within the Gerrard Bazaar	98	Fig 3.39	Diagram of Toronto Cash & Carry

99	Fig 3.40	Toronto Cash & Carry - analytical diagrams		Fig 3.64	Retail aisle
101	Fig 3.41	Store interior display		Fig 3.65	Clothing display
	Fig 3.42	Store interior display	118	Fig 3.66	Diagram of Sajawat
	Fig 3.43	Store interior display	119	Fig 3.67	Sajawat - analytical diagrams
	Fig 3.44	View towards store entry	121	Fig 3.68	Tables arranged in main space
102	Fig 3.45	Diagram of Jhumka		Fig 3.69	Announcements made on stage
103	Fig 3.46	Jhumka - analytical diagrams		Fig 3.70	Singing performance on stage
105	Fig 3.47	Exterior food service / preparation area		Fig 3.71	Dance performance on stage
	Fig 3.48	Exterior food service / preparation area	122	Fig 3.72	Diagram of the PCC
	Fig 3.49	Seating area	123	Fig 3.73	PCC - analytical diagrams
	Fig 3.50	Seating area	125	Fig 3.74	Art gallery area
106	Fig 3.51	Diagram of Lahore Paan Centre		Fig 3.75	Coffee shop area
107	Fig 3.52	Lahore Paan Centre - analytical diagrams		Fig 3.76	Hallway to art gallery area
109	Fig 3.53	Interior display area	126	Fig 3.77	Diagram of The Flying Pony
	Fig 3.54	Exterior display area	127	Fig 3.78	Flying Pony - analytical diagrams
	Fig 3.55	View of store from street	129	Fig 3.79	Flexible workshop space
110	Fig 3.56	Diagram of Chandan Fashion (main level)		Fig 3.80	Art display table
111	Fig 3.57	Chandan Fashion - analytical diagrams		Fig 3.81	View to store entry
113	Fig 3.58	Exterior food stall		Fig 3.82	View to private office area
	Fig 3.59	Retail aisle	130'	Fig 3.83	Diagram of Lens Work
	Fig 3.60	Retail aisle	131	Fig 3.84	Lens Work - analytical diagrams
114	Fig 3.61	Diagram of Kohinoor Foods	133	Fig 3.85	Interior retail display
	Fig 3.62	Kohinoor Foods - analytical diagrams		Fig 3.86	Exterior wooden chairs
115	Fig 3.62	Kohinoor Foods - analytical diagrams		Fig 3.87	Toys on display
117	Fig 3.63	Exterior clothing display area	134	Fig 3.88	Diagram of Swag Sisters Toy store

135	Fig 3.89	Swag Sisters Toy store - analytical diagrams	188	Fig 5.01	Diversity within the Gerrard Bazaar	Fig 5.05g	Ganga River - India Echternacht, Laura. Quiet india – the sunrise at river ganga. in Water & Megacities [database online]. 2012 [cited 01/06 2015]. Available from http://www.waterandmegacities.org/quiet-india-the-sunrise-at-river-ganga/ .	Fig 5.06f	Humayun's Tomb - India Agarwal, Ashish. Light coming through the stone lattice at humayun tomb. in Fine Art America [database online]. 2015 [cited 01/06 2015]. Available from http://fineartamerica.com/featured/light-coming-through-the-stone-lattice-at-humayun-tomb-ashish-agarwal.html .	
137	Fig 3.90	Interior seating area	190	Fig 5.02	People lining up for food					
	Fig 3.91	Back of house kitchen	192	Fig 5.03	Determining design interventions from conclusions - diagram					
	Fig 3.92	Interior seating area	195	Fig 5.04	Architectural/ design maneuvers	Fig 5.05h	Sea View Beach - Pakistan T, Yawar. Picture of SeaView karachi. in Trip Discovery [database online]. 2015 [cited 01/06 2015]. Available from http://pics.tripdiscovery.com/beaches-parks/picture-of-seaview-karachi/ .	Fig 5.06g	Traditional Courtyard House - India Pai, Mohan. Traditional hindu central courtyard houses of goa. in Sulekha [database online]. 2015 [cited 01/06 2015]. Available from http://creative.sulekha.com/traditional-hindu-central-courtyard-houses-of-go-440635_blog .	
138	Fig 3.93	Diagram of Ali Baba Restaurant	196	Fig 5.05	South Asian Vernacular Urban Design					
139	Fig 3.94	Ali Baba Restaurant - analytical diagrams		Fig 5.05a	Mughal Gardens - India Chopp, Chris. Rashtrapati bhavan mughal gardens open from 14 february. in Full Stop India [database online]. 2015 [cited 01/06 2015]. Available from http://www.fullstopindia.com/rashtrapati-bhavan-mughal-gardens-open-from-10-february/ .	Fig 5.05i	Baadshai Mosque - Pakistan Stans, Seven. Badshahi mosque, pakistan. in National Geographic [database online]. 2015 [cited 01/06 2015]. Available from http://travel.nationalgeographic.com/travel/countries/seven-stans-photos/#/badsahi-mosque-lahore-pakistan_12283_600x450.jpg .	Fig 5.06h	Traditional Courtyard House - India Mohan, Radhika. Land of fiery cuisine, saris & mansions. in Buzz in Town [database online]. 2009 [cited 01/06 2015]. Available from http://www.buzzintown.com/article-review-land-fiery-cuisine-saris-mansions/id-801.html .	
144	Fig 4.01	A typical street within the Gerrard Bazaar		Fig 5.05b	Bin Qasim Park - Pakistan Top 10 best places to visit in karachi pakistan. in Trip Discovery [database online]. 2015 [cited 01/06 2015]. Available from http://pk.tripdiscovery.com/travelguide/top-10-best-places-to-visit-in-karachi-pakistan_aid8 .	197	Fig 5.06	South Asian Vernacular Residential Architecture		
145	Fig. 402	A vacant storefront within the Gerrard Bazaar		Fig 5.05c	Minar-e-Pakistan Park - Pakistan Vicky, Vicked. Minar-e-pakistan - the national building of pakistan. in Xcite for Fun [database online]. 2010 [cited 01/06 2015]. Available from http://forum.xcitefun.net/minar-e-pakistan-the-national-building-of-pakistan-t53367.html .	Fig 5.06a	Ruwanwelisaya - Sri Lanka Sri lanka classic tour. in Lakpura Travels [database online]. 2015 [cited 01/06 2015]. Available from https://www.lanka.com/holidays/sri-lanka-classic-tour/ .	Fig 5.06i	Traditional Courtyard House - India Sundar, Nandhini. Building it scientifically. in The Hindu [database online]. 2015 [cited 01/06 2015]. Available from http://www.thehindu.com/todays-paper/tp-features/tp-propertyplus/building-it-scientifically/article5331243.ece .	
146	Fig 4.03	Survey sample size calculator as found on The Survey System		Fig 5.05d	Sunday Bazaar - Pakistan Razvi, Zainub. Sunday bazaar 006. in Flickr [database online]. 2007 [cited 01/06 2015]. Available from https://www.flickr.com/photos/zainub/468399849/ .	Fig 5.06b	Quaid-e-Azam Mosoleum - Paksitan Quaid-e-azam mazhar. 2009 [cited 01/06 2015]. Available from http://www.essexteas.com/modules/com_communicator/quaid-e-azam-mazar-1501.html .	198	Fig 5.07	China Gate in Vancouver's Chinatown L. Robertson, Scott. Vancouver chinatown gate 2. Available from http://www.slrobertson.com/galleries/canada/vancouver/chinatown/vancouver-china-town-gate-2.htm (accessed 02/04 2015).
147	Fig 4.04	Facebook recruitment method for survey		Fig 5.05e	Garden Bazaar - India Daskar : Nature bazaar 2010. in Purple Homes [database online]. 2010 [cited 01/06 2015]. Available from http://purplehomes.blogspot.ca/2010/10/daskar-nature-bazaar-2010.html .	Fig 5.06c	Taj Mahal - India Handlon, James. Foto friday – the taj mahal, agra, uttar pradesh, India. in James Handlon [database online]. 2011 [cited 01/06 2015]. Available from http://jameshandlon.com/2011/07/15/the-taj-mahal-aggra-uttar-pradesh-india/ .	Fig 5.08	Dragons in Vancouver's Chinatown Vancouver chinatown. in Definium Design Group [database online]. 2015 [cited February 5 2015]. Available from http://www.vancouver-chinatown.com/ .	
148	Fig 4.05	Survey - Summary Results - Question 1 - 4		Fig 5.05f	Clifton Bazaar - Pakistan Ahmad, Mukhtar. Markets in full bloom as kashmir braces for eid. in Rediff News [database online]. 2012 [cited 01/06 2015]. Available from http://www.rediff.com/news/slide-show/slide-show-1-markets-in-full-bloom-as-kashmir-braces-for-eid/20120818.htm .	Fig 5.06d	Lahore Fort - Pakistan Gwylm, . The world's best photos. in Flickr Hive Mind [database online]. 2015 [cited 01/06 2015]. Available from http://flickrhivemind.net/User/Gwylm/Interesting .	199	Fig 5.09	Chinatown - axonometric
149	Fig 4.06	Survey - Summary Results - Question 5 - 6				Fig 5.06e	City Palace - India Colorful kaleidoscopic cultural collage in udaipur. in Travel Pod [database online]. 2011 [cited 01/06 2015]. Available from http://www.travelpod.com/travel-blog-entries/friesendm/12/1304926290/tpod.html .	200	Fig 5.10	Streetsville main street square during the day Streetsville main street square redevelopment. 2013. Mississauga: City of Mississauga, http://www.mississauga.ca/file/COM/2013-04-25-
150	Fig 4.07	Survey - Summary Results - Question 7								
151	Fig 4.08	Survey - Summary Results - Question 8								
152	Fig 4.09	Survey - Summary Results - Question 9								
153	Fig 4.10	Survey - Summary Results - Question 10								
154	Fig 4.11	Survey - Summary Results - Question 11 - 12								
155	Fig 4.12	Survey - Summary Results - Question 13								
156	Fig 4.13	Survey - Summary Results - Question 14								
157	Fig 4.14	Survey - Summary Results - Question 15								
158	Fig 4.15	Survey - Summary Results - Question 16								
	Fig 4.16	Survey - Summary Results - Question 17								
159	Fig 4.17	Survey - Summary Results - Question 18								
160-161	Fig 4.18	Map of survey respondents								

SMSS-Public-Presentation.pdf
(accessed 02/05 2015).

www.archdaily.com/127609/seniors-residence-
alta/.

Fig 5.11	Streetsville main street square marketplace Ibid.	Fig 5.23	Exterior view of senior residence Ibid.		
201	Fig 5.12	Streetsville main street square - axonometric	209	Fig 5.24	Senior Residence - axonometric
202	Fig 5.13	Mississauga Civic Square during the day Mississauga civic centre square and mississauga central library square redevelopment. 2009. Toronto: CS&P Architects Inc., http:// www5.mississauga.ca/isf/civic_square_overview. pdf (accessed 02/05 2015).	210	Fig 5.25	Aerial view Furuto, Alison. Solund retirement community second prize winning proposal / henning larsen architects. in ArchDaily [database online]. 2012 [cited 02/05 2015]. Available from http:// www.archdaily.com/293923/solund-retirement- community-second-prize-winning-proposal- henning-larsen-architects/ .
Fig 5.14	Mississauga Civic Square during a night concert Ibid.	Fig 5.26	Exterior view Ibid.		
203	Fig 5.15	Mississauga Civic Square - axonometric	211	Fig 5.27	Solund Retirement Community - axonometric
204	Fig 5.16	Urban platform during evening time Arcilla, Patricia. "Urban platform" wins first in lisbon open room competition. in Arch Daily [database online]. 2015 [cited 04/05 2015]. Available from http://www.archdaily. com/611966/urban-platform-wins-first-in-lisbon-open- room-competition/# .	212	Fig 5.28	Exterior view to corner Plassen cultural centre / 3XN architects. ArchDaily, 2012 [cited 02/05 2015]. Available from http://www.archdaily. com/279891/plassen-cultural-center- 3xn-architects/ .
Fig 5.17	Urban platform as a place of gathering Ibid.	Fig 5.29	Exterior view to stairs Ibid.		
205	Fig 5.18	Urban platform - axonometric	213	Fig 5.30	Plassen cultural centre - axonometric
206	Fig 5.19	View to the courtyard PEGS senior / McBride charles ryan. in Arch Dail [database online]. 2014 [cited 04/05 2015]. Available from http:// www.archdaily.com/473805/pegs-senior- mcbride-charles-ryan/	215	Fig 5.31	Multifaith Walk hosted by several organizations including the Pakistani Community Centre (PCC) Adult learning and events. in Danforth Jewish Circle [database online]. 2015 [cited 02/06 2015]. Available from http://djctoronto.com/ education/programs-and-events/ .
Fig 5.20	View into occupiable threshold Ibid.	216-217	Fig 5.32	"Key entities" and networks within the Gerrard Bazaar	
207	Fig 5.21	PEGS Senior School - axonometric	218	Fig 5.33	View towards west end of retail strip
208	Fig 5.22	Courtyard view of senior residence Jordana, Sebastian. Senior residence/ a/ LTA. in ArchDaily [database online]. 2011 [cited February 5 2015]. Available from http://	220	Fig 5.34	Site analysis - Key entities & potential sites for design proposals

221	Fig 5.35	Best Site - Reactivation	255	Fig 5.76	Strategy 1 - Adaptive re-use, site images
222	Fig 5.36	Best Site - Adaptive Reuse	256	Fig 5.77	Strategy 2 - Adaptive re-use, survey results
223	Fig 5.37	Best Site - New Design	258	Fig 5.78	Strategy 2 - Adaptive re-use, personal perspectives
225	Fig 5.38	Urban strategies manual	260	Fig 5.79	Strategy 3 - Adaptive re-use, formation of new networks
228	Fig 5.39	Strategy 1 - Reactivation, identified site issues	262	Fig 5.80	Strategy 4 - Adaptive re-use, vernacular architecture inspiration
229	Fig 5.40	Strategy 1 - Reactivation, site images	264	Fig 5.81	Strategy 5 - Adaptive re-use, local architecture inspiration
230	Fig 5.41	Strategy 2 - Reactivation, survey results	266	Fig 5.82	Strategy 6 - Adaptive re-use, street and zoning axes
232	Fig 5.42	Strategy 2 - Re-activation, personal perspectives	267	Fig 5.83	Strategy 7 - Adaptive re-use, area to be resurfaced
234	Fig 5.43	Strategy 3 - Reactivation, formation of new networks	268	Fig 5.84	Strategy 8 - Adaptive re-use, modified elements
236	Fig 5.44	Strategy 4 - Reactivation, vernacular architecture inspiration	269	Fig 5.85	Strategy 9 - Adaptive re-use, new elements
238	Fig 5.45	Strategy 4 - Reactivation, vernacular architecture inspiration	270	Fig 5.86	Strategy 10 - Adaptive re-use, new elements create areas of gathering/repose
240	Fig 5.55	Strategy 6 - Reactivation, street and zoning axes	271	Fig 5.87	Adaptive re-use design maneuvers
241	Fig 5.56	Strategy 7 - Reactivation, area to be resurfaced	272	Fig 5.88	Adaptive re-use design maneuvers
242	Fig 5.57	Strategy 8 - Reactivation, modified elements	273	Fig 5.89	Adaptive re-use: on a regular Winter's day
243	Fig 5.58	Strategy 9 - Reactivation, new elements	274	Fig 5.90	Adaptive re-use: on a regular Summer's day
244	Fig 5.59	Strategy 10 - Reactivation, new elements create areas of gathering/ cultural exchange	275	Fig 5.91	Adaptive re-use: during a SAVAC art exhibit event
245	Fig 5.60	Reactivation design maneuvers	276	Fig 5.92	Adaptive re-use: during Eid
246	Fig 5.70	Reactivation, on a regular day	277	Fig 5.93	Adaptive re-use: during a Indo-Pakistani cooking workshop
247	Fig 5.71	Reactivation, during a South Asian festival for youth	280	Fig 5.94	Strategy 1 - Re-imagine, identified site issues
248	Fig 5.72	Reactivation, during Diwali/ Eid/ Vaisakhi	281	Fig 5.95	Strategy 1 - Re-imagine, site images
249	Fig 5.73	Reactivation, during a Christmas parade	282	Fig 5.96	Strategy 2 - Re-imagine, survey results
250	Fig 5.74	Reactivation, during a street market	284	Fig 5.97	Strategy 2 - Re-imagine, personal perspectives
254	Fig 5.75	Strategy 1 - Adaptive re-use, identified site issues	286	Fig 5.98	Strategy 3 - Re-imagine, formation of new networks

288	Fig 5.99	Strategy 4 - Re-imagine, vernacular architecture inspiration	314	Fig 5.123	Re-imagine: during Basant (a popular kite-flying festival celebrated in Pakistan)
290	Fig 5.100	Strategy 5 - Re-imagine, local architecture inspiration	315	Fig 5.124	Re-imagine: during Friendship's Day (a popular festival celebrated in India)
292	Fig 5.101	Strategy 6 - Re-imagine, street and zoning axes	316	Fig 5.125	Re-imagine: during a regular day
293	Fig 5.102	Strategy 7 - Re-imagine, area to be resurfaced	317	Fig 5.126	Re-imagine: during an annual Spice Festival
294	Fig 5.103	Strategy 8 - Re-imagine, modified elements	318	Fig 5.127	Re-imagine: on a regular evening in the courtyard
295	Fig 5.104	Strategy 9 - Re-imagine, new elements	319	Fig 5.128	Re-imagine: during Christmas celebrations
296	Fig 5.105	Strategy 10 - Re-imagine, new elements create areas of gathering/ repose	320	Fig 5.129	Re-imagine: during Holi, the festival of the colours celebrated in India
297	Fig 5.106	Re-imagine design maneuvers	321	Fig 5.130	Re-imagine: during Vaisakhi, a Sikh festival of the harvest
298	Fig 5.107	Re-imagine design maneuvers	322	Fig 5.131	Re-imagine: on a regular day at the teashop
299	Fig 5.108	Re-imagine design maneuvers	323	Fig 5.132	Re-imagine: during a PCC Family Night musical event
300	Fig 5.109	Main level floorplan	324	Fig 5.133	Re-imagine: during a Christmas gala dinner
301	Fig 5.110	Second level floorplan	325	Fig 5.134	Re-imagine: during a South Asian public fashion show - marketing strategy for merchants
302	Fig 5.111	Third level floorplan	326	Fig 5.135	Calendar of events for all three design interventions
303	Fig 5.112	Fourth level floorplan	330	Fig 5.136	Modified urban strategies manual
304	Fig 5.113	Fifth level floorplan	333	Fig 5.137	Envisioned phases of development
305	Fig 5.114	Longitudinal section			
306	Fig 5.115	Longitudinal section			
307	Fig 5.116	Cross-section			
308	Fig 5.117	North elevation			
309	Fig 5.118	East elevation			
310	Fig 5.119	South elevation			
311	Fig 5.120	West elevation			
312	Fig 5.121	Building from exterior			
313	Fig 5.122	Re-imagine: on a regular day			

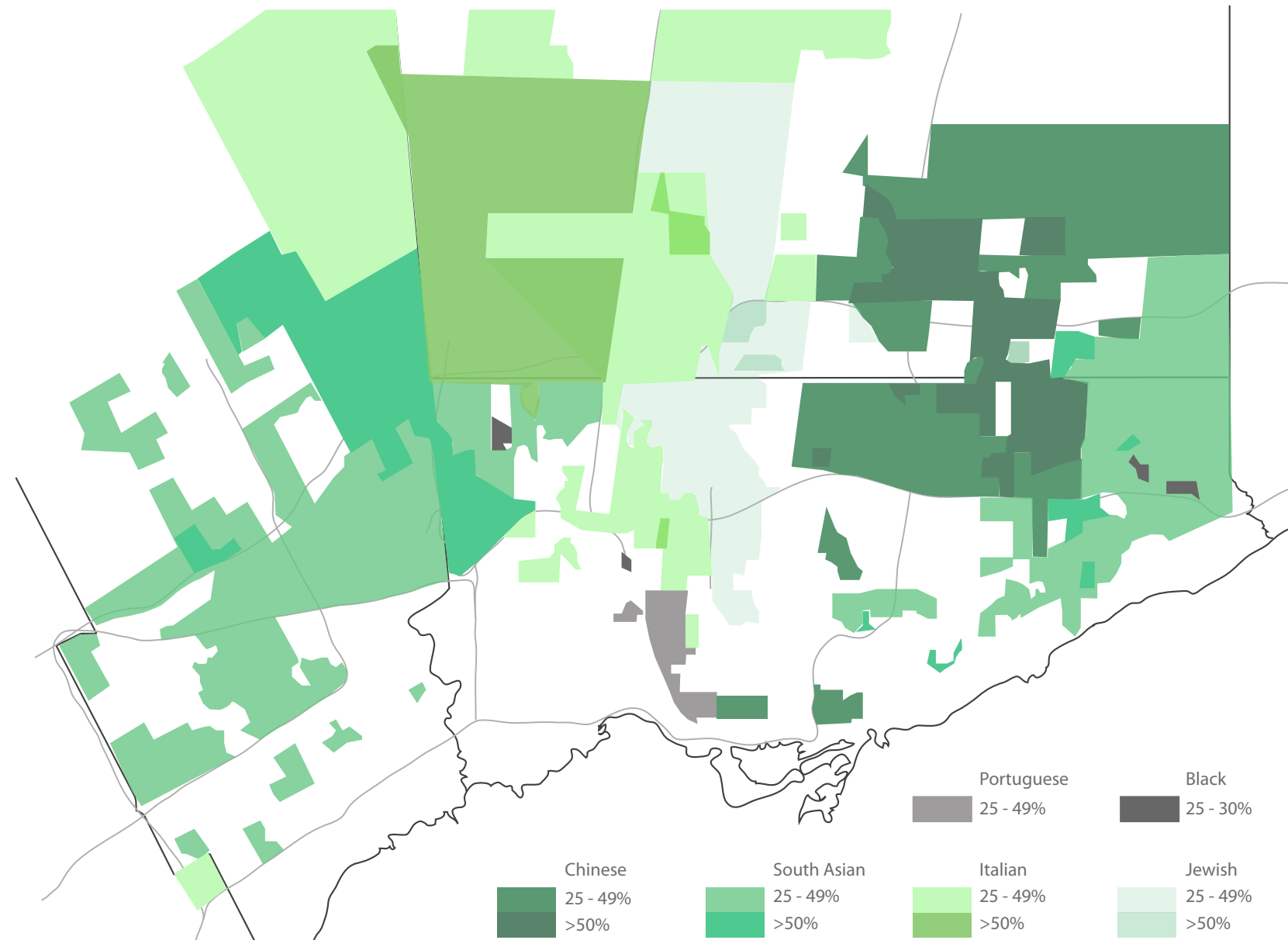


Fig 0.01: Ethnic enclaves within the GTA

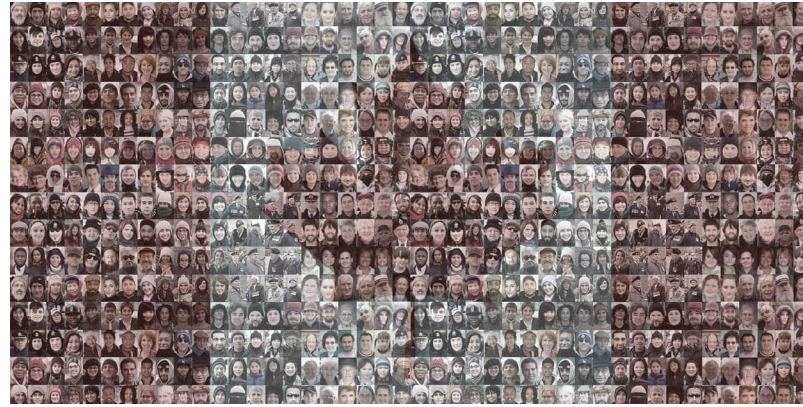


Fig 0.02: The Canadian flag depicting the idea of Cultural Mosaic

INTRODUCTION |

Known for its diversity and multiculturalism, Toronto truly embraces the Canadian concept of the “cultural mosaic”. Over the past number of decades the urban centre has witnessed a massive influx of immigrants from various nations around the globe, due to its less restrictive immigration laws and high standard of living.

When observing this phenomenon from an economic standpoint, it is evident that high levels of immigration have triggered overall economic growth. On the other hand, close examination of the urban form and structure of the city, illustrates that this inflow of people has also allowed for the formation of ethnic communities, also known as ethnic enclaves. These entities have significantly diversified the urban fabric of the city, further exposing its multi-ethnic make-up. Within the downtown core, numerous ethnic neighbourhoods have become attractor points, drawing immigrants and Torontonians to experience enticing new cultures first-hand. Serving as a reference point with which to identify with, these enclaves foster a sense of community among immigrants through the provision of goods and services in cultural ways.

Ethnic enclaves are residential or commercial communities in which a predominant group of people with the same culture, traditions and ethnic background reside and work. The role that these entities play is typical: they initially serve as reception neighbourhoods for new immigrants, then as ethnic centres which fulfill the local ethnic population’s needs, and ultimately, as ethnic centres serving an ethnic population within an entire metropolitan region or as tourist attractions.¹ Most ethnic enclaves within Toronto have followed this route, yet some have embraced their own distinct transformations.



Fig 0.03: Article written about Gerrard Bazaar during its prosperous times

Situated along Gerrard Street East, the Gerrard Bazaar is an ethnic enclave that developed in a slightly unique manner. The entity that initiated its accidental existence was a modest South Asian cinema house, established by a newcomer from India named Gian Naaz. Shortly after, various South Asian businesses sprouted along the street to cater to the growing number of visitors and immigrants. As such, the enclave developed into a retail strip that served tourists as well as the needs of local South Asian residents. Numerous years of prosperity and profit were witnessed until the early 2000’s after which the 9/11 Attacks and SARS outbreak drastically affected the image and economic success of the Bazaar.² Moreover, the large presence and continuous immigration of South Asians in suburban regions has resulted in the growth of the Indo-Pakistani retail market there. As such, the average South Asian no longer finds the need to travel to the Bazaar for ethnic goods and services, further affecting the enclave’s growth. In addition to the economic downturn, the enclave has been gradually gentrifying, leading to an influx of non-ethnic businesses such as coffee shops and art galleries. This phenomenon has brought with it a cultural divide between the predominantly Caucasian residents and South Asian bazaar. While many non-South Asian residents support gentrification in order that the bazaar aesthetically and economically develop, the average South Asian visitor supports the preservation of the retail strip’s heritage and the emphasis on more South Asian related programs. Over the past several years, key on-site organizations have organized various initiatives within the enclave that could foster a sense of community among the different groups that utilize the bazaar and promote urban regeneration through different programs. Such organizations include the Riverdale Hub, the Pakistani Community Centre (PCC), and the Business Improvement Area (BIA). However, in many instances these organizations operate in a fairly isolated manner, further exacerbating the lack of solidarity within the enclave.

This thesis establishes that the Gerrard Bazaar is in decline mainly due to its demographic change that puts its identity into question, its high levels of urban vacancy that affect its aesthetic appeal and its lack of proper programs and initiatives that work in a holistic and integrated manner. As mentioned earlier, these issues have exacerbated the cultural divide between residents and merchants, as well as that between different merchants and organizations.

As such, this thesis strongly supports the idea that the bazaar is in need of a new holistic strategy to help regenerate it aesthetically, culturally and economically. Although, as previously stated, various organizations and entities are pursuing initiatives to help the enclave, they simply are not collectively working to help the Gerrard Bazaar in a more robust and integrated manner.

It is this lack of a holistic approach that this thesis aims to achieve, particularly through a certain method, which would conclude with architecture and urban design interventions. In order to achieve this, the thesis takes a step-by-step approach to investigate and study all aspects of the Gerrard Bazaar so as to determine the most feasible solution.

This thesis first utilizes current discourses on ethnic enclaves in Toronto in order to establish a framework upon which the rest of the analysis is based. After this, it utilizes a bottom-up approach to thoroughly analyze the Gerrard Bazaar. This begins with a contextual and geographic analysis, which then zooms into an architectural and spatial analysis, and finally approaches a more personal level via the personal analysis.

The portion that bridges together the analyses and the design portion of the thesis, is a formulated "manual" of urban strategies that forms the underlying framework for three different design interventions within the ethnic enclave. This manual is not only formulated using the aforementioned research but also by studying precedents within the

Gerrard Bazaar as well as proposing new networks between existing organizations and institutions. The proposed interventions that are designed step-by-step according to this manual, are meant to serve as a catalyst for community gathering and cultural exchange. Additionally, they are meant to speak to the changing nature of the ethnic enclave - one that focuses less on preservation but more on inclusion and cultural exchange. Moreover, the method utilized to create these design interventions, is meant to serve as an exemplary solution that could be implemented within other declining ethnic enclaves in the city.

All in all, this thesis is mostly focused on the ways in which data is collected and translated into the final design. As such, its main emphasis is on the method by which the architecture is produced, and the important design maneuvers that are utilized to promote cultural exchange. In other words, the architecture is aimed to serve as a plug-in which is the outcome of a method that is designed to facilitate cultural exchange.

Endnotes

1. Jones, K. & Simmons, J. (1993). *Location, Location, Location: Analyzing the Retail Environment* (2nd ed.). Scarborough: Nelson Canada.
2. S. Chintaluri, personal communication, March 6, 2014.

1. DIVERSITY, CULTURE + ETHNIC ENCLAVES IN TORONTO |

- 1.1 Glossary of Key Terminology
- 1.2 Diversity and Immigration in Toronto
- 1.3 South Asian Immigration and Establishment
- 1.4 The Formation and Discourse on Ethnic Enclaves
- 1.5 Method of Development
- Endnotes

1.1 Glossary of Key Terminology

Certain terms are very important when looking at ethnic enclaves and the factors that create and affect their very existence. It is important to understand the underlying dynamics of the urban context within which an enclave is present. This plays a very significant role in how the ethnic enclave functions and how it evolves over time.

Business Improvement Area (BIA) | noun

: An association of commercial property owners and tenants within a defined area who work in partnership with the City to create thriving, competitive, and safe business areas that attract shoppers, diners, tourists, and new businesses.¹

Diaspora | noun

: People who have spread or been dispersed from their homeland.²

Ethnic Enclave | noun

: Immigrant groups which concentrate in a distinct spatial location and organize a variety of enterprises serving their own ethnic market and/or the general population.³

Gentrification | noun

: The process of renewal and rebuilding accompanying the influx of middle-class or affluent people into deteriorating areas that often displaces poorer residents.⁴

Ghetto | noun

: A part of a city, especially a slum area, occupied by a minority group or groups.²

Segregate | verb

: Separate or divide along racial, sexual, or religious lines.²

South Asians | noun

: Classified as those whose origins are from the Indian subcontinent, which typically includes the countries of Afghanistan, Bangladesh, Bhutan, India, Myanmar, Nepal, Pakistan and Sri Lanka.⁵

Visible Minority | noun

: Includes persons who are non-Caucasian in race or non-white in colour and who do not report being Aboriginal.⁶

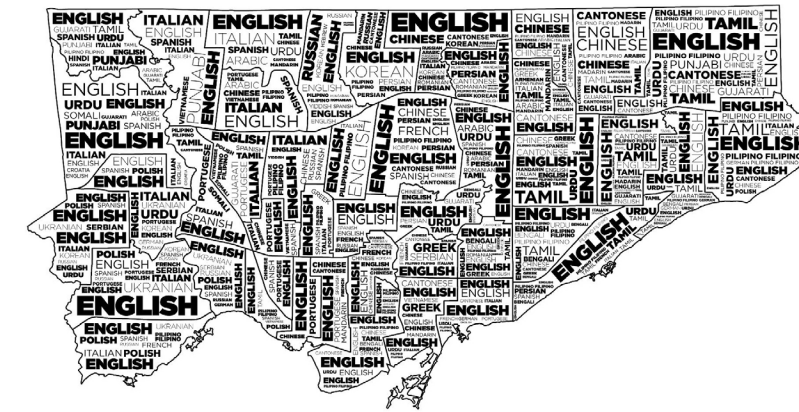
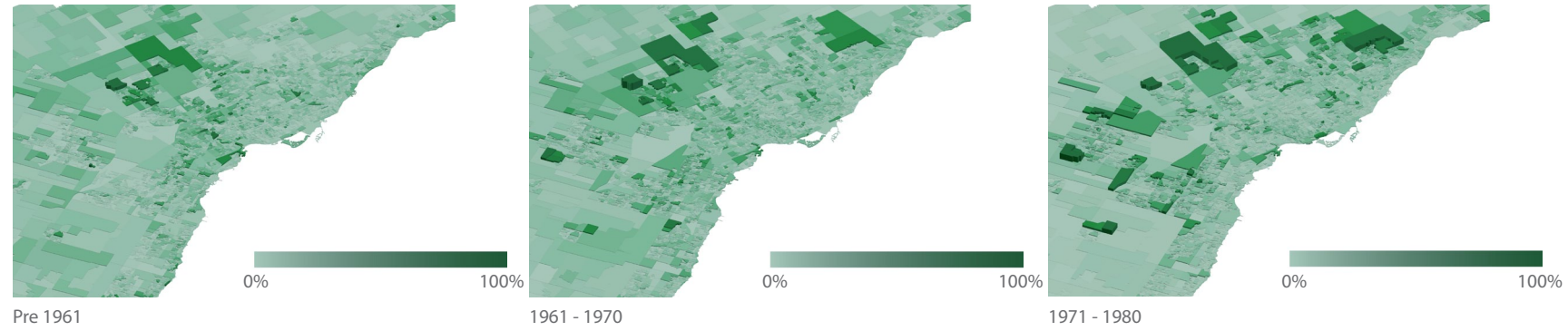


Fig 1.01: Word diagram of mother-tongue spoken in Toronto

1.2 Diversity and Immigration in Toronto

Toronto is dubbed as one of the most multicultural cities in the world with a rapidly growing immigration rate and continuously changing demographic. Based on the 2006 Census, urban areas within Canada were inhabited by more than 97% of immigrants who arrived between the years of 2001 and 2006.⁷ During this time, 1,109, 980 immigrants arrived in the country and by 2006, 68.5% of all newcomers were from China, India, Philippines, Pakistan and Sri Lanka.⁶

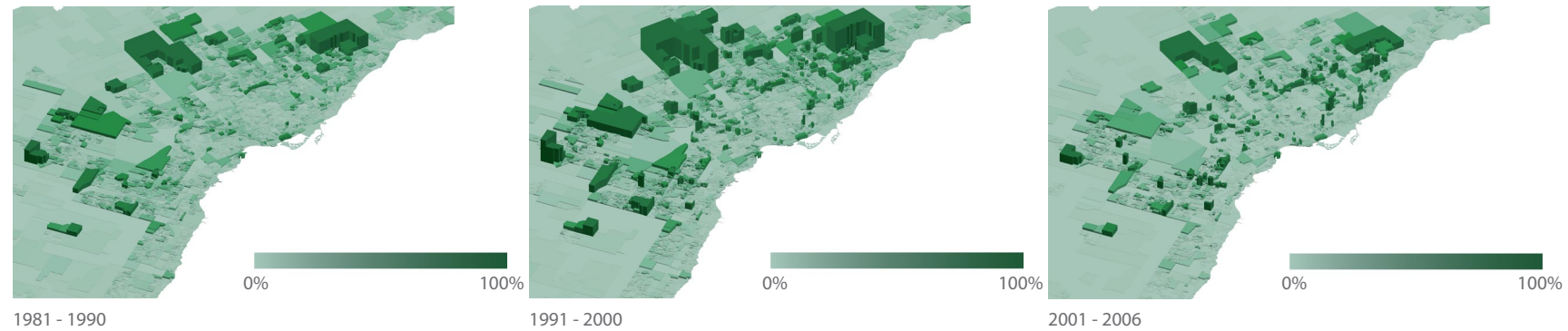
Looking closer at Toronto and its surrounding region, the demography of immigrants flowing into the GTA has varied over time as well. Prior to the 1960's, immigrants predominantly came from European nations. After this time however, there was a decline in such immigrants and a significant increase in those from Asia and the rest of the world. Additional studies conducted during the same year show that the Greater Toronto Area (GTA) was home to 30% of all recent immigrants and 20% of all immigrants to the country. Moreover, about half of GTA's population was born outside of the country and 50% of immigrants within GTA have resided within the country for less than 15 years.⁸ Further studies conducted reveal that in 2006, 45% of the GTA's population comprised of 36% of all immigrants within the province, 20% of all immigrants within the country, 42.4% of all visible minorities within the province, and 22.9% of all visible minorities within the country.



Pre 1961

1961 - 1970

1971 - 1980



1981 - 1990

1991 - 2000

2001 - 2006

Fig 1.02: Percentage of immigrants in GTA over time

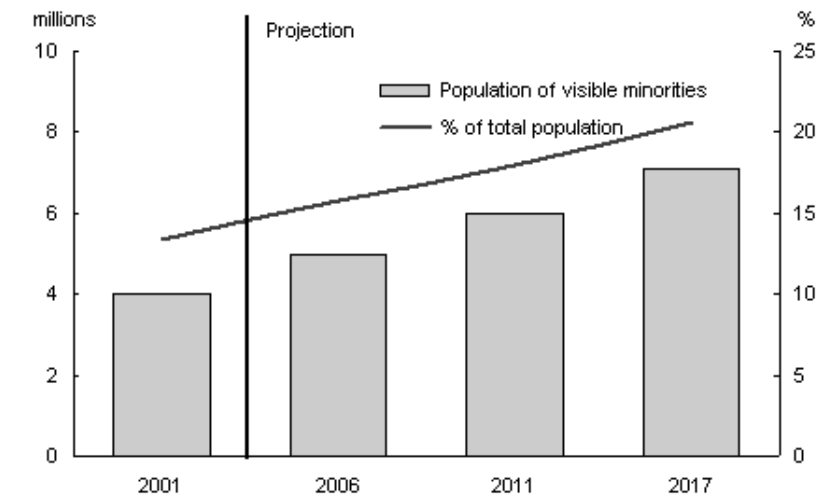


Fig 1.03: Growth of visible minorities in Canada

In terms of language, currently within the city more than 140 languages and dialects are spoken including Arabic, Hindi, Japanese, Russian and Tamil. These languages are spoken by 30% of Torontonians at home.⁶

Looking at the broader context of Toronto, the GTA region contains almost half of all visible minorities in the province and just under 25% of visible minorities in the country. The top five visible minority groups in 2006 were: South Asian (12%), Chinese (11.4%), Black (8.4%), Filipino (4.1%) and Latin American (2.6%). Relevant to these statistics is the fact that almost half of the GTA's population identify themselves as a visible minority.⁶

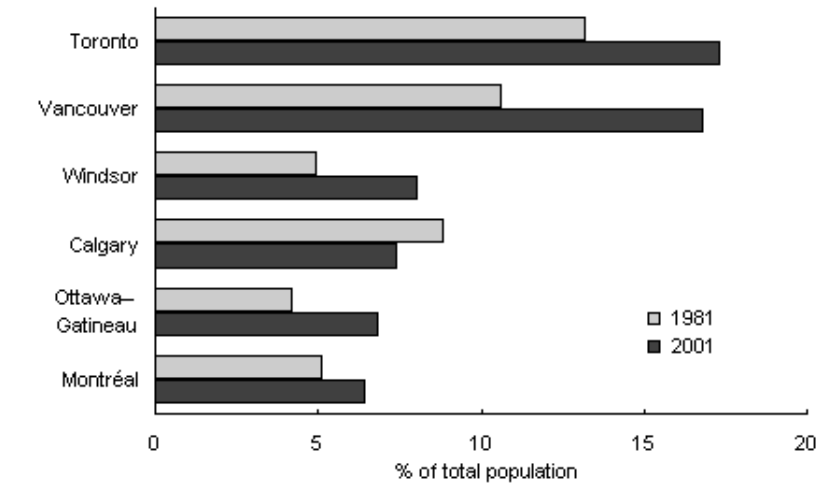


Fig 1.04: Immigrants in selected cities



Fig 1.05: First arrival of Sikhs in Canada

1.3 South Asian Immigration and Establishment

As stated earlier, South Asians make up the largest visible minority group within the GTA and are therefore a significant ethnic group within this region.

South Asians made their initial entry within Canada in 1903, when a majority of predominantly Sikhs entered Vancouver via ship. Immigration continued to grow rapidly thereafter, however, the BC government viewed it as a threat and quickly limited the rights and privileges of South Asians.⁵

During the 1920's the growth of the lumber industry allowed for better economic security for South Asians, considering their great involvement in the sector. Local support for this ethnic population also increased by the Second World War, and the partition of India into two countries (India and Pakistan), led to the removal of various restrictions for South Asians.⁵

In 1951, a quota system was established which allowed a small number of immigrants from India and Pakistan. South Asians were 2,148 in number at this time. It wasn't until the 1960's when various restrictions were eliminated from immigration policies and South Asian immigration began to increase at a rapid rate.⁵

Today, there are more than 1,500,000 South Asians within Canada and this number is gradually increasing year by year.⁵ Despite the various sub-cultures present among South Asians, one key social aspect of their culture is the emphasis placed on extended families, kinship, and community relationships. A large number of South Asians, though accepting of Canadian customs and culture, still maintain their cultural and religious ties. As the second generation of South Asians matures, however, changes in cultural rituals and values have been initiated. For example, more and more South Asian women are entering the



Fig 1.06: Gur Sikh temple, one of the first in North America

workforce, further shedding light on the advancement of South Asian women in society.

When looking at how South Asians have established themselves within Canadian society over time, an interesting pattern is observed. The first religious South Asian institution established in Ontario was a Gurdwara⁹, which is a place of worship for those belonging to the religion of Sikhism (largely in India). The Immigrant Point System was later established in 1967, which allowed for immigrants from all over the globe to enter the country, as long as they scored enough points. It was not too long after this event that the Naaz Theater opened along Gerrard Street East in 1972.¹⁰ After the Green Paper was issued in 1975, there was the establishment of various South Asian immigrant support and counseling organizations that promoted solidarity and unity. During this time, the Gerrard Bazaar's Business Improvement Area (BIA) was formed and the Bazaar was experiencing great economic and social growth, mainly through tourism.¹¹

It was after the 1990's that there was a shift in the type of organizations that were being formed as well as the events that transpired within the Gerrard Bazaar. In 1990, the Naaz Theatre closed down due to lack of business, for many large suburban theatres depicting Bollywood films, and the availability of Bollywood films on DVDs, became very common.¹¹ A year later, however, the first Miss India Canada Beauty Pageant took place¹². Moreover, other organizations such as the South Asian Visual Arts Centre, the South Asian Film Festival, various South Asian seniors' homes and South Asian political groups, formed. Meanwhile, the 9/11 Attacks and the SARS outbreak deeply affected the Gerrard Bazaar and the vacancy rate continued to rise. In efforts to revitalize the retail strip, the BIA began holding the Festival of South Asia in 2004, which led to great profit each year henceforth³. The Riverdale Hub also opened in 2013 and attempted to initiate various community revitalization initiatives. Despite these efforts, however, the



Fig 1.07: SAVAC Office

growth and prosperity that the Gerrard Bazaar enjoyed in the 1980's has not been witnessed since.¹³

The South Asian Visual Arts Centre (SAVAC) is a good example of a non-profit organization that is a response to the establishment of South Asians within the GTA. Its main purpose is to serve the South Asian art community while promoting cultural art through various events. Three paid staff members and a board of directors manages the organization, while government councils and members provide funding. In addition, the organization holds events in different locations across the GTA, indicative of the dispersed nature of the centres operations.¹⁴

In terms of promoting Indo-Pakistani culture, SAVAC is keen on "supporting identity based work and the work of people who identify as South Asian". The organization provides workshops and portfolio reviews, which are meant to help strengthen an individual's artistic capabilities and identity. Furthermore, SAVAC has undertaken a project within the Gerrard Bazaar called "Big Stories, Little India", which comprised of a series of installations reflecting key facts and historic information about the ethnic enclave.¹⁴

Toronto's South Asian Film Festival is another organization that promotes and celebrates South Asian art and culture, particularly related to cinema. Founded in 1999, the first festival was held a year later at the Harbourfront Centre in Toronto and showcased four films. Since then, the festival has expanded to showcase numerous features and films over a two-day period. This is indicative of the growth and establishment of this organization and its reinforcement of South Asian cinema among the North American film industry. This festival aims to "promote, discover and celebrate cinematic endeavours by talented South Asian filmmakers, and highlight works with South Asian themes and artists that can be brought to a mainstream audience."¹⁵



Fig 1.08: Shahrukh Khan, a famous Bollywood actor, at the Indian International Film Awards in Toronto

The Miss Pakistan World and Miss India Canada beauty pageants are also a form of celebration and promotion of South Asian beauty and culture. The Miss Pakistan World pageant is open to Pakistani girls from all across the globe and is based on "beauty, culture and being Pakistani".¹⁶ On the other hand, the Miss India Canada pageant is in the form of an annual gala, which promotes South Asian heritage through entertainment and unity. Often attended by key figures, this event aims to celebrate what is to be Indo-Canadian.¹⁷ As such, both of these pageants are aimed at South Asian youth and encourage them within Canada to grow, prosper and establish their identity.

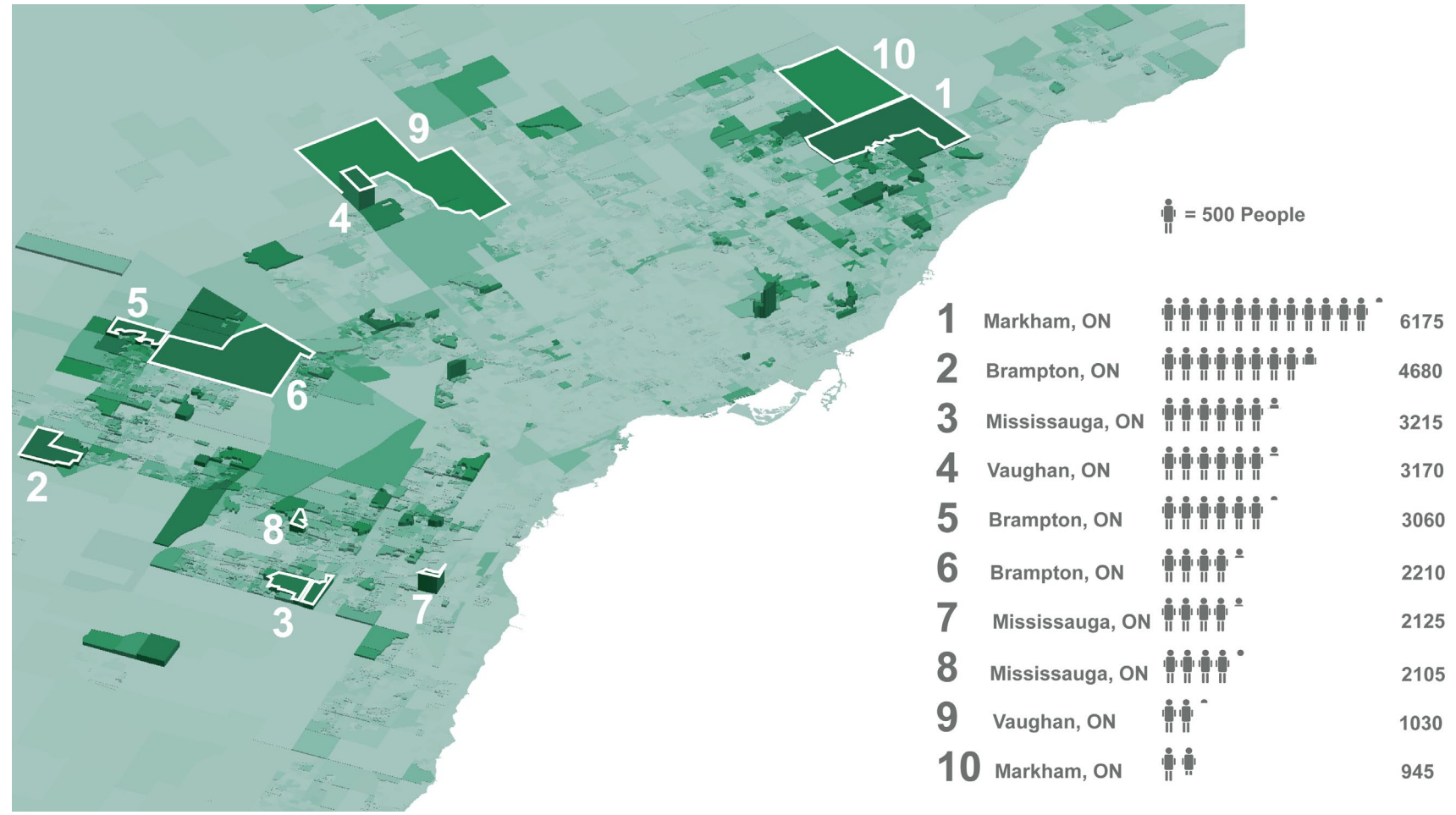


Fig 1.09: South Asian clusters within GTA (higher to lower density)

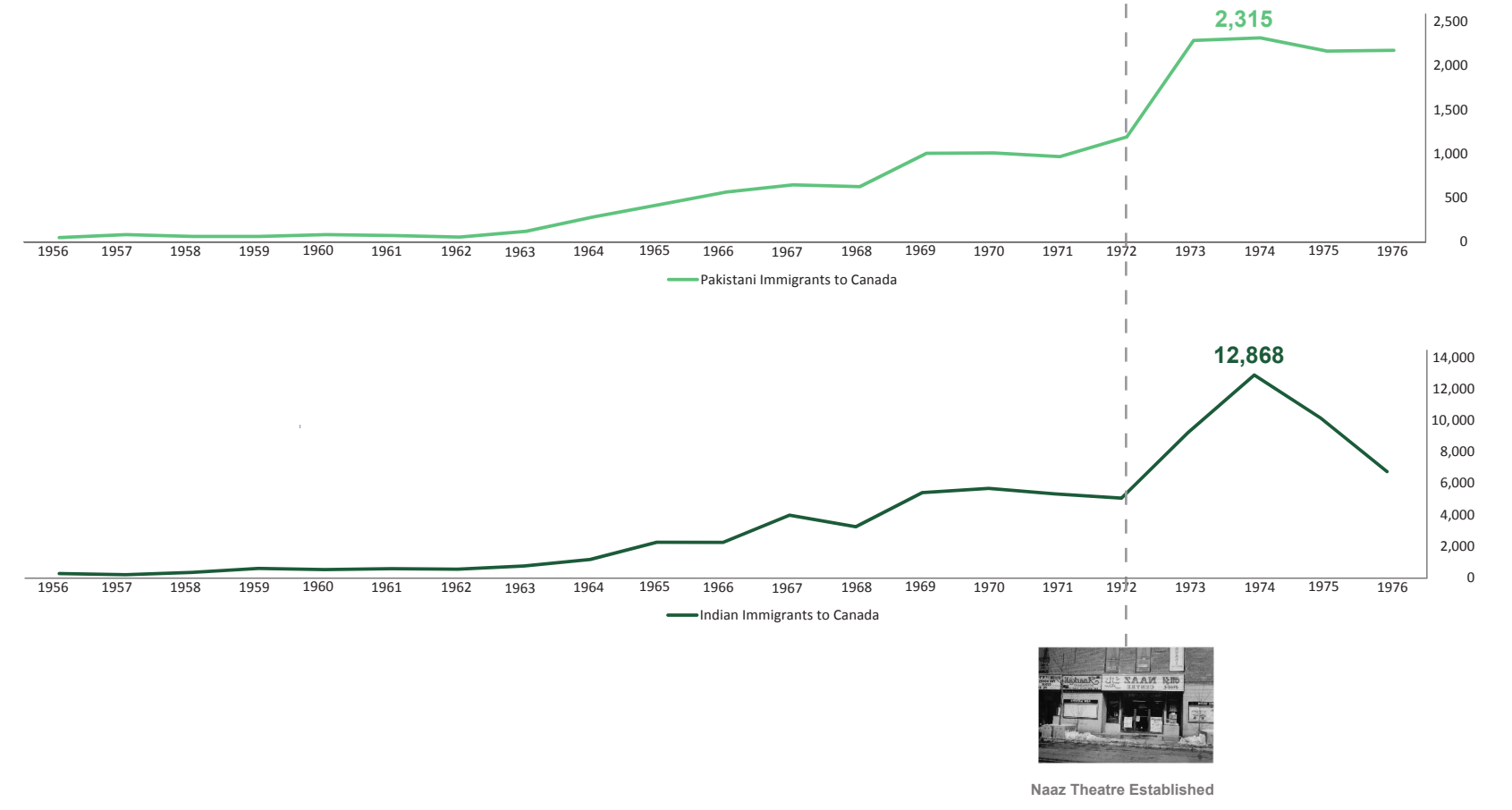
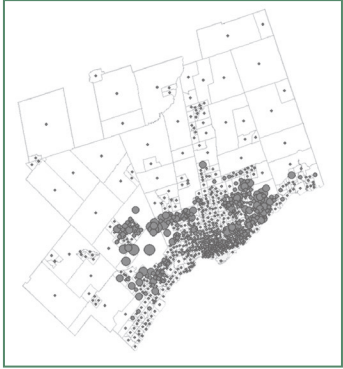


Fig 1.10: Immigration (Indians and Pakistanis) in relation to Naaz Theatre



IDENTITY + ESTABLISHMENT

SUPPORT + SERVICES

CELEBRATION + PRESERVATION OF CULTURE

POLITICAL ESTABLISHMENT

PROMOTION OF CULTURE

MULTICULTURALISM ACKNOWLEDGED + WELCOME

MULTICULTURALISM AFFECTED

GERRARD BAZAAR INITIATED

GERRARD BAZAAR ESTABLISHED

GERRARD BAZAAR PROSPERS

NAAZ THEATRE CLOSES DOWN

GERRARD BAZAAR BEGINS TO DECLINE

GERRARD BAZAAR BEGINS EFFORTS TO REVITALIZE ITSELF



Fig 1.11: Timeline of South Asians within the GTA



Fig 1.12: Suhaag South Asian Wedding show in Toronto

Within the timeline in Figure 1.11, there is a development pattern of South Asian organizations that illustrates how the needs and wants of this ethnic group have changed over the course of time. It begins with entities that focus on establishing, supporting and unifying their respective sub-cultures within society. Such organizations include places of worship but mainly, supporting organizations such as the Association of Women of India in Canada. During this time, the Gerrard Bazaar was also slowly being established, thus indicating that this time was key in that it reflects South Asians establishing a place for themselves in Canadian society.

When the Gerrard Bazaar began to decline, there was a shift from South Asian organizations that encouraged identity and solidarity, to those that promoted and celebrated culture. The birth of the first Indian Canadian beauty pageant, the South Asian Film Festival and the Bollywood Film Awards are indicative of the fact that South Asians, now well settled into Canadian society, are now comfortable with their culture and are finding ways in which they can express and promote it. In addition, from the mid 1990's to the early 2000's, there is a presence of organizations that cater to the established second and first- generations of South Asians within Toronto (i.e. senior's homes, art organizations etc.). This is followed by a presence of organizations that are related to politics, suggesting that South Asians have spearheaded into various streams of Canadian society.

Therefore it can be seen that there is, in a sense, a pattern of settlement - establishment - advancement. All of these achievements among South Asians after the 1990's coincide with the 9/11 Attacks and SARS outbreak. Given this, they also coincide with the decline of the Gerrard Bazaar which illustrates that this ethnic enclave did not play a significant role in this celebration and promotion of South Asian culture that began during the 1990's.



Fig 1.13: Miss Pakistan World Beauty Pageant in Toronto

The fact that the establishment and celebration of Indo-Pakistani culture predominantly operates separately from the Gerrard Bazaar signifies that the ethnic enclave does not serve as a key reference point for them - it is more of a tourist area that is visited on various occasions or for something specific. This could mean that there is an opportunity for the ultimate design intervention(s) to accommodate programs that promote and celebrate the Indo-Pakistani culture. This can also suggest that there is no need for the design intervention to accommodate such programs and therefore it should focus on the demographic make-up of the surrounding neighbourhood, which is predominantly Caucasian.

The aim is that the personal analysis phase of this thesis would serve as an important study that would help spearhead the design in either of these directions. To what extent this should be done and how much interest this would render from different ethnic and age groups, are key questions that would be answered during this phase.



Fig 1.14: A street sign in Greektown, Toronto

1.4 The Discourse on Ethnic Enclaves

Ethnicity may be described as a shared background, history or sense of peoplehood through certain factors such as nationality, global region, race, religion or a mixture of these.¹⁸

From the perspective of multicultural planning, culture relates to the beliefs, sentiments, norms, values, attitudes and meanings that are shared among individuals. City-development is influenced by culture because it is shared differently among different sets of people. In addition, spatial manifestations of city fabric and social activities are influenced by culture.¹⁹

According to Qadeer, Agrawal and Lovell, researchers in geography, ethnic enclaves are simply neighbourhoods where one ethnic group dominates. It is a “high-ethnic-density territory” which is surrounded by areas of lower ethnic concentration. Today, they are now slowly shifting into suburban regions, particularly the York region to the north and the Peel region to the west. This is primarily due to new and affordable housing and access to cultural amenities in these areas. Ethnic enclaves are further described as a “spatial and institutional phenomenon” in which ethnic concentration is crucial for the enclave’s existence. It is imperative for there to be a complete set of institutions in order to maintain the enclave. Despite the term enclave meaning immigrant concentrations within city centres, the term ethnic enclave typically means a neighbourhood with a dominant ethnic group in which institutions exist that reflect the cultural values and symbology of that particular ethnic group. Such institutions include: ethnic businesses, community agencies and organizations.²⁰

Looking at ethnic enclaves through the perspective of geography, race and place are strongly associated with each other.¹⁸ In his paper, *Exploring minority enclave areas in Montreal, Toronto, and Vancouver*, Hiebert explains how the “spatial arrangement” of a society and the social



Fig 1.15: Signs in Chinatown, Toronto

relationships within it, have a key relationship. Therefore, ethno-cultural or religious interaction is more likely for those who live within the same region as opposed to those who live in a dispersed manner. Moreover, interaction and understanding on a cross-cultural scale can occur through daily typical encounters. Hiebert then states how residence within an ethnic enclave allows an immigrant to eventually obtain a grasp on the operations of Canadian society. However, a complete transformation of identity or way of life does not take place too often. This is due to the connection that inhabitants have with their homeland through various goods, services and cultural practices. For this reason, immigrants acquire a “hybrid” identity. However, there is still much to explore in terms of transnational identities and residential trends since there is a lack of synthesized studies on the personal and social aspects of immigrants within ethnic enclaves.²¹

Sanjoy Mazumder, a planning and policy professor from the University of California Irvine, classifies ethnic enclaves in multiple ways. A means of adjustment is one way in which he views ethnic enclaves. When immigrants enter a new nation, ethnic enclaves serve as a means for them to adjust with members of their same ethnic group until they establish themselves in society and move out of the enclave (ethnic succession). Immigrants entering a foreign society may also long for the same sights, smells, celebrations and social circle as their previous home country. As such, ethnic enclaves can operate as a place where immigrants can exercise their previous experiences and feel at home.²²

Mazumder classifies ethnic enclaves as a socio-physical phenomenon as well, meaning that immigrants re-link themselves with their spatial environment by re-creating the built fabric. This is where architecture plays a role, in that it is modified in order to appear and function in such a way that the ethnic group is familiar with. Buildings are changed to possess meaning, symbology and cultural beliefs. This may manifest itself in the orientation of the building, its colours, its shape or its key

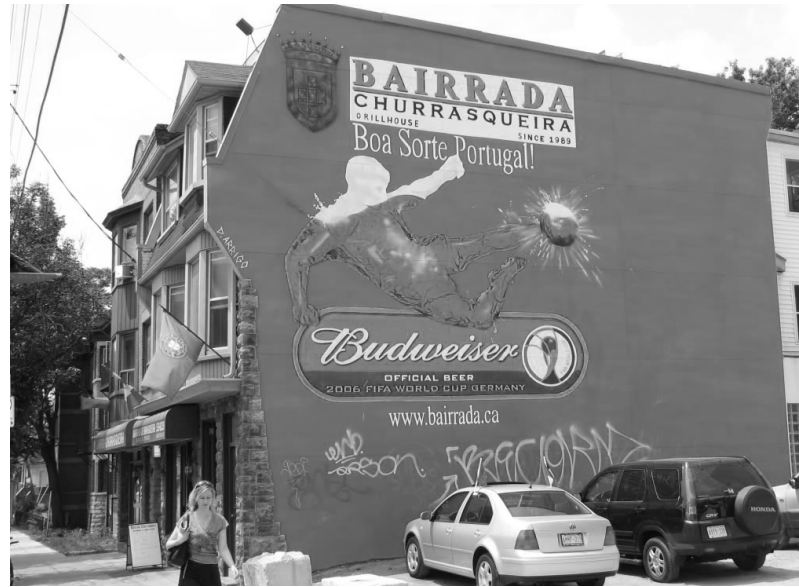


Fig 1.16: A street in Little Portugal

elements and features.²²

There are several issues regarding ethnic enclaves within Toronto. One key question, brought forth by Hiebert, Walks and Bourne, distinguished professors in the field of geography, surrounds the notion that ethnic enclaves may act as segregated entities that promote poverty and exclusion. Despite “spatial integration” being a weak indicator of how an ethnic group participates in society, the issue remains as to whether ethnic enclaves are more or less exclusive to one ethnic group.²³ This issue may be prominent in different ethnic enclaves to varying degrees. For instance, Little Portugal is an example of an ethnic community that has undergone significant gentrification over the years. Much of the Portuguese population in the area has flown outward since the 1970’s, to be replaced by middle-class professionals who seek reasonably-priced housing in close proximity to the downtown core. There is still a small population of Portuguese families in the area, and the neighbourhood still attracts its ethnic group for shopping and events. Nevertheless, the inhabitants and retail enterprises coexist in harmony. As such, Little Portugal no longer serves as an immigrant reception area or ethnic enclave, but dons a different identity²⁴.

The Gerrard Bazaar is similar to Little Portugal in that the ethnic enclave is undergoing gentrification yet there is a small population of those belonging to that ethnic group, still living in the area. However, unlike Little Portugal, the Gerrard Bazaar has been facing issues in terms of ethnic integration and cultural inclusion. There exists a divide between the South Asian merchants and the non-South Asian residents within the area. What each ethnic group desires and seeks within the Gerrard Bazaar, and how they identify with the ethnic enclave, is one of the mandates of this thesis. For this reason, personal research in the form of surveys and interviews are conducted in order to uncover a personal insight on the Gerrard Bazaar. This personal insight would be very useful in defining what types of interventions would be practical and desired. In

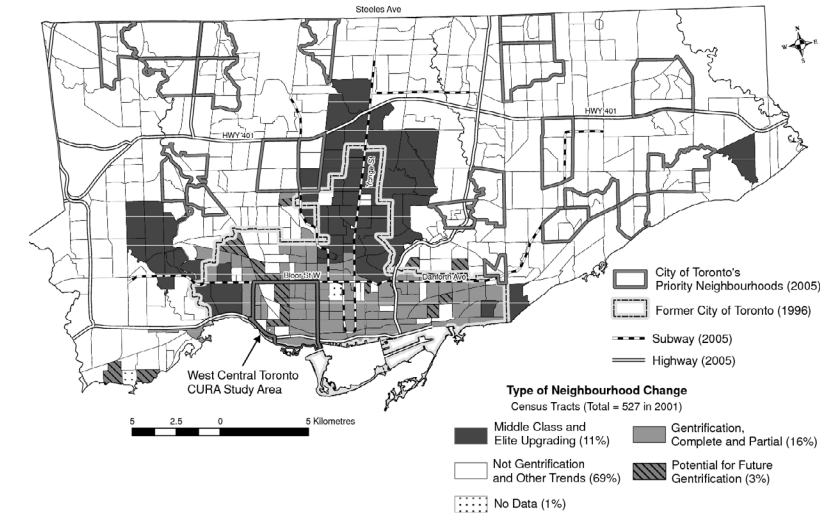


Fig 1.17: Gentrification in Torontonians neighbourhoods, 1961 - 2001

addition, these personal studies are critical in determining what cultural identity means to those who visit and inhabit the Gerrard Bazaar and how their perception and desires of learning and practicing culture can inform the design proposal.

Murdie and Teixeira, scholars who have studied Little Portugal and its demographic change, also elaborate on another related issue facing ethnic enclaves in Toronto today - gentrification. Many ethnic enclaves within the downtown core are undergoing gentrification, leading to a rise in housing and commercial prices which the average newcomer cannot afford. Though many newcomers have hopes to own their own homes within the city, their modest income compels them to live in rented properties or other regions where housing is significantly cheaper, such as the suburbs. Larger houses within the suburbs also prevent over-crowding - something that is commonly experienced by large immigrant families within smaller dwellings in the city. As a result, spatial segregation as well as income polarization occurs, and this puts low-income ethnic communities at risk for becoming ghettos.²⁴ With this occurring, the identity of the ethnic enclave is at the verge of change - would it still serve as an immigrant reception area? Would this mean its ethnic identity is at risk? What do visitors and residents desire in terms of keeping it alive and thriving?

According to Mohammed Qadeer, Toronto’s ethnic enclaves should not be confused with ghettos, which, as mentioned earlier, are areas that are involuntarily occupied by impoverished minorities or immigrants within the city. He argues that ethnic enclaves do not prevent social inclusion but rather, are voluntary places of residence for minorities. Qadeer also emphasizes the notion of social cohesion, which he defines as, “a state in the sense that societies can be more or less cohesive”. This idea of social cohesion is what he argues to be imperative in promoting social interaction, integration and equality. He continues to discuss how spatial segregation acts as an impediment to social cohesion. Furthermore, he

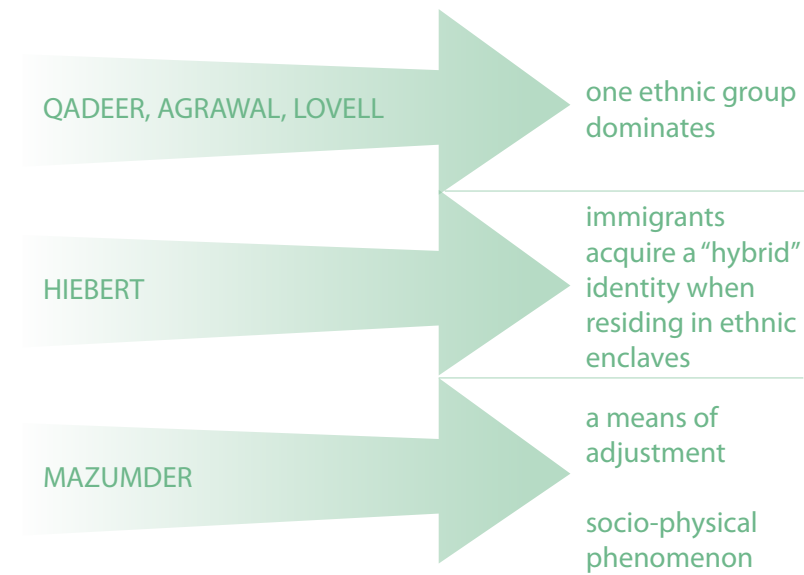


Fig 1.18: Views of ethnic enclaves as presented by different scholars

states that, "enclaves have shifted the locus of ethnicity to the suburbs". Along with Frederick W. Boal and Ceri Peach, the professor states that "ethnic neighbourhoods" provide ethnic resources and amenities, thus promoting cultural heritage and integration within the foreign social fabric.²⁴

Qadeer brings up another important topic, which relates to the role of a neighbourhood as a part of, and institutions within, an ethnic enclave. He describes a neighbourhood as an entity with symbolic meaning and a "weak organization of local interests". These local interests are fostered through schools, organizations and local services. He concludes by shedding light on how the institution is a key player in increasing equality, participation and interaction in society, for they are places where social cohesion occur. It is these institutions and organizations that need to be inclusive in all facets.²⁵

Within this thesis, the Gerrard Bazaar will be viewed through the lens of Qadeer. As the professor states, "enclaves are spatial expressions of ethnicity" which consist of ethnic institutions and organizations that "acquire a life of their own". Those who reside within these dynamic neighbourhoods are exposed to varying sights, smells and individuals of other ethnicities and cultures, and this does not pose any issue. Qadeer goes on to make a very key point which sheds light on the fact that although ethnic enclaves have such strong elements that are associated with a particular culture, they do not dissolve even if social integration occurs. This supports the very underlying idea present within this thesis - that in order to reinforce the identity of the Gerrard Bazaar, it is imperative for cultural exchange to occur. This cultural exchange would not hinder the ethnic enclave's ability to retain its South Asian identity, but rather, keep it in tact while promoting social cohesion and cultural integration. Qadeer's insight on institutions and organizations needing to be more inclusive and strongly organized is also useful to note, for this thesis will eventually look at important organizations or "key entities" that have

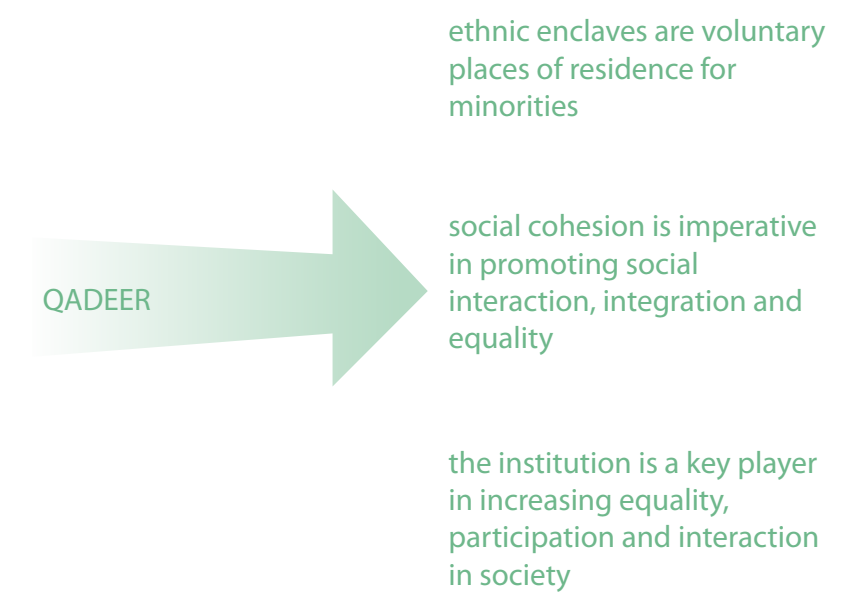


Fig 1.19: Key points made by Qadeer on ethnic enclaves

the opportunity to work in collaboration and facilitate new networks that allow for cultural exchange. The question then becomes, what role can architecture and urban design play in strengthening local interests and networks? What is the method by which research and data can be accumulated to influence this architecture? How can this method work to promote inclusion and cultural exchange within an ethnic enclave? How would it allow for a renewed identity or locus of an ethnic enclave and what would this identity be?



Fig 1.20: Thesis methodology diagram - chapters 1 and 2

1.5 Methodology

This thesis is composed of five parts in the form of five chapters, each of which serve as stepping stones towards the final design proposal in chapter 5. Chapters 1 and 2 form the macro-research component of this thesis while chapters 3 and 4 are in the form of micro-research. Both of these research components are used to analyze the Gerrard Bazaar and inform the ultimate design proposal. It is within this research that the need for “cultural exchange” within the bazaar, becomes apparent.

The first chapter aims to give background information about ethnic enclaves, diversity and immigration in general, as well as establish a discourse about ethnic enclaves that would serve as a framework within this thesis. The first few sections within this chapter shed light on important underlying facts that relate to ethnic diversity in Toronto, immigration of different ethnic groups and particularly, of South Asians. This information is crucial to bring forth since it provides a backbone upon which the analyses and main research would rest on. In addition, the information relating to the immigration and establishment of South Asians within society is imperative to understand, as it would establish very early on in the thesis how the Gerrard Bazaar plays a role in the life of a typical South Asian - Canadian, and what possible programs could be proposed as a part of the design intervention(s). Another key objective of this chapter is to explain scholarly opinions on ethnic enclaves and determine which perspective on ethnic enclaves would be utilized within this thesis. In this case, the argument that Qadeer brings forth regarding ethnic enclaves serves as the framework within which this thesis unfolds. Once again, Qadeer supports the idea of social inclusion and integration within ethnic enclaves - something that establishes very early on that the notion of culture, society, and integration are key elements to be emphasized within the rest of the study.

The second chapter serves as a historical and geographical analysis of the Gerrard Bazaar. This is the first type of method utilized to analyze

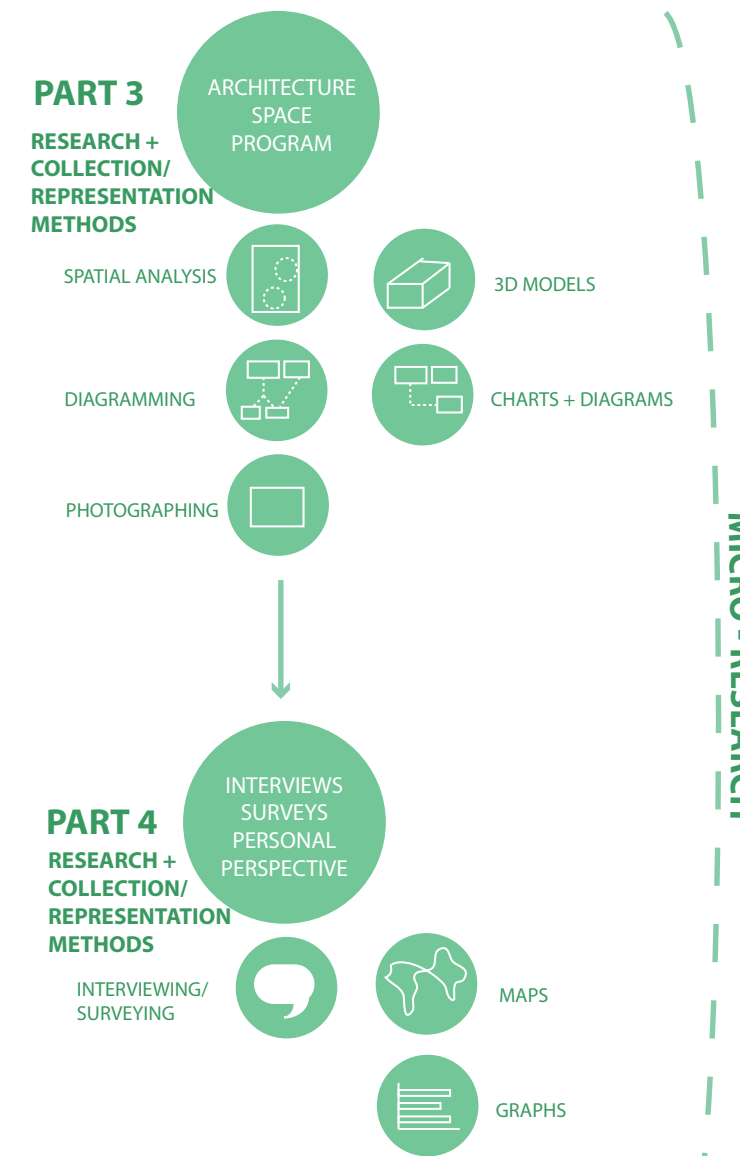


Fig 1.21: Thesis methodology diagram - chapters 3 and 4

the ethnic enclave. The site is first analyzed in terms of its historic development and early evolution into an ethnic enclave. A series of maps and diagrams then illustrate the current demographic trends within the neighbourhood of the ethnic enclave. Within these studies it becomes clear that the area of the Gerrard Bazaar is inhabited mainly by non-South Asians who are mostly affluent individuals, while there are several South Asian residential clusters in surrounding regions. This information establishes that the design proposal needs to serve not only South Asian visitors but also non-South Asian residents nearby. As such, it needs to be inclusive as well as very conscious of culture and integration. The final portion of this chapter looks at current issues that plague the bazaar including lack of aesthetic appeal, urban vacancy, and the cultural divide. This reinforces the fact that the Gerrard Bazaar is in decline. Moreover, these findings suggest that these issues have the potential to be addressed within the design proposal - however this is something that would be clarified as the thesis progresses.

The third chapter zooms into a closer scale and examines the programmatic, architectural and spatial conditions of the Gerrard Bazaar. This is the second type of method utilized to analyze the ethnic enclave. Firstly, the programs of the retail strip and the Greenwood-Coxwell neighbourhood are examined. After this, the spatial manifestations of different events and a diverse range of buildings are studied. It is within this chapter that specific architectural typologies, key organizations, and programmatic functions and variations among different organizations and merchants, become more apparent. These results are meant to serve as architectural and programmatic precedents for the ultimate design intervention(s), along with several others (to be analyzed in later chapters).

The fourth chapter gives a critical insight into the personal perceptions, opinions and relations that different individuals have of and with the Gerrard Bazaar, through surveys and interviews. This is the third type of

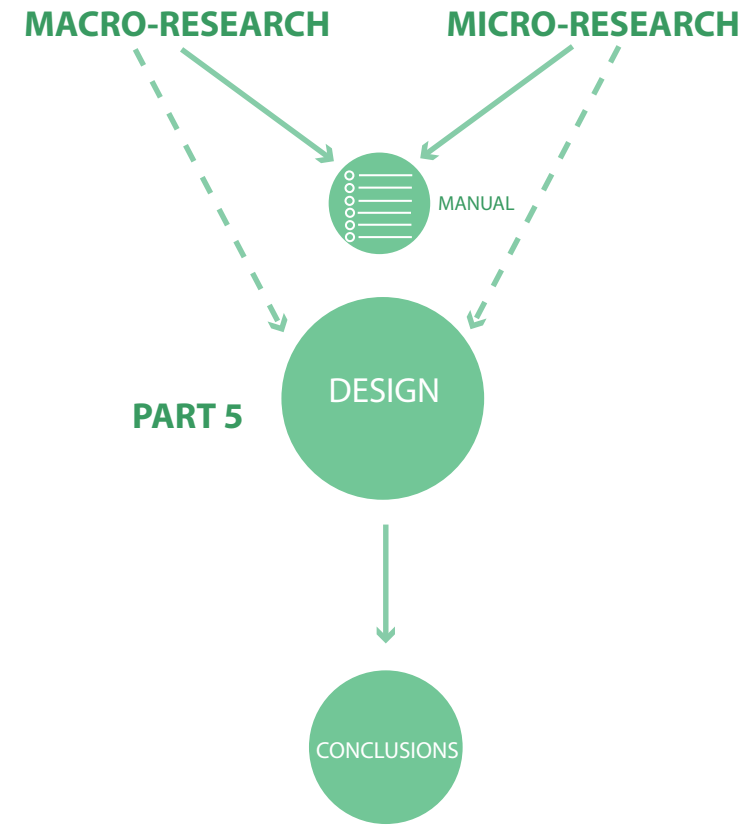


Fig 1.22: Thesis methodology diagram - chapters 5

method utilized to analyze the ethnic enclave. It opens up a completely new realm where the ethnic enclave is seen purely from a personal stance - what individuals like about the bazaar, what they dislike, what they desire to see and what programs would attract them are fundamental questions that are answered. These answers significantly influence the design decision so that it is realistic and reflects that which the users need and desire. The first part of this chapter summarizes a mass survey completed by South Asians and non-South Asians within the GTA. Once again, this survey gives a glimpse into how the perceptions, needs and desires of these two types of groups vary and how this needs to be incorporated within the design proposal. One key thing that this survey achieves is that it gives a personal insight on culture as perceived and practiced by different ethnic groups. The survey proves that culture varies from individual to individual and the needs for this culture to manifest itself, vary in terms of architectural, spatial, and programmatic needs. It is this cultural variation that is key when considering design, for it is cultural exchange that needs to be encouraged and optimized in the ultimate design intervention(s). The interviews conducted with important individuals from key organizations ("key entities") are the second part of this chapter. These interviews are crucial for the design intervention for they help determine how different important organizations and merchants work within the Gerrard Bazaar, and where adjacencies and networks exist. They also help identify where there is a disconnect between the functions and operations of these "key entities" and this is important to consider for the design phase. Areas of potential new networks are imperative to identify in order to establish new symbiotic relationships between organizations of varying type and ethnicity, which can help foster cultural exchange among different user groups.

The combination of the results found in the first four chapters is then carefully interpreted to determine what kinds of design interventions are feasible for the ethnic enclave, within the fifth chapter. Examining

precedents, their architectural configurations, methods of regeneration and ability to promote interaction and gathering, also forms a significant part of this chapter. Once these results and precedents are studied, a manual of "urban strategies" is formulated using the compiled findings. This is then utilized to create three different design interventions within the Bazaar. Once again, these interventions are meant to optimize the existing functions within the Gerrard Bazaar, as well as foster cultural exchange.

Endnotes

1. About business improvement areas. in City of Toronto [database online]. 2015 [cited 03/26 2015]. Available from <http://www1.toronto.ca/wps/portal/contentonly?vgnextoid=71571c8ab77da310VgnVCM10000071d60f89RCRD&vgnextchannel=673032d0b6d1e310VgnVCM10000071d60f89RCRD>.
2. Oxford dictionaries. in Oxford University Press [database online]. 2015 [cited 03/25 2015]. Available from <http://www.oxforddictionaries.com/definition/english/>.
3. Portes A. Modes of structural incorporation and present theories of labor immigrations. In: Kritiz MM, Keely CB, Tomasi SM, editors. Global trends in migration. Staten Island, NY: CMS Press; 1981. pp.279–297.
4. Merriam webster dictionary. 2014 [cited 03/25 2015]. Available from <http://www.merriam-webster.com/dictionary/>.
5. Buchignani, Noman. South asian canadians. in Canadian Encyclopedia [database online]. 2014 [cited 06/28 2014]. Available from <http://www.thecanadianencyclopedia.ca/en/article/south-asians/>.
6. Classification of visible minority. in Statistics Canada [database online]. 2012 [cited 03/25 2015]. Available from <http://www.statcan.gc.ca/concepts/definitions/minority01-minorite01a-eng.htm>.
7. Census snapshot – Immigration in canada: A portrait of the foreign-born population, 2006 census. 2008. Statistics Canada, , <http://www.statcan.gc.ca/pub/11-008-x/2008001/article/10556-eng.htm> (accessed 12/21 2015).
8. Toronto facts: Diversity. in City of Toronto [database online]. 2015 [cited 03/25 2015]. Available from <http://www1.toronto.ca/wps/portal/contentonly?vgnextoid=dbe867b42d853410VgnVCM10000071d60f89RCRD&vgnextchannel=57a12cc817453410VgnVCM10000071d60f89RCRD>.
9. Some significant moments in sikh-canadian history. Available from <http://explorasian.org/about-us/education/sikh-canadian-history/> (accessed 01/22 2015).
10. The Origami. Saving little india. Available from <http://theorigami.ca/2014/01/22/saving-india/> (accessed 01/23 2015).
11. Qadeer, Mohammad, Sandeep K. Agrawal, and Alexander Lovell.2010. Evolution of ethnic enclaves in the toronto metropolitan area 2001 - 2006. <http://www.missindiacanada.com/about/>.
12. About | miss india canada. [database online]. [cited 01/23 2015]. Available from <http://www.missindiacanada.com/about/>.
13. Micallef, Shawn. The riverdale hub expands on toronto's ever-evolving gerrard street. Yongestreet, <http://www.yongestreetmedia.ca/features/riverdalehub0831.aspx> (accessed 01/23 2015).
14. Interview with organization 2, 05/08 2014.
15. Toronto's south asian film festival. [cited 03/9 2015]. Available from <http://filmfestival.org/about/>.
16. Miss pakistan world 2013. 2013 [cited 03/26 2015]. Available from <http://misspakistanworld.com/miss-pakistan-world-2013/>.
17. About | miss india canada. [cited 01/23 2015]. Available from <http://www.missindiacanada.com/about/>.
18. Zucchi, John. 2007. A history of ethnic enclaves in canada. Canada's ethnic group series. Ottawa: The Canadian Historical Association.
19. Hoernig, Heidi. 2009. Planning amidst cultural diversity ; lessons from religious development. Welcoming Communities : Planning for Diverse Populations.
20. Qadeer, Mohammad, Sandeep K. Agrawal, and Alexander Lovell.2010. Evolution of ethnic enclaves in the toronto metropolitan area 2001 - 2006.
21. Hiebert, Daniel. 2009. Exploring minority enclave areas in montréal, toronto, and vancouver, ed. Daniel Hiebert.Ottawa, Ont. : Citizenship and Immigration Canada, 2009.
22. Mazumdar, Sanjay. 2005. Ethnic enclaves, diversity, and multiculturalism: Should environmental researchers care?
23. Keung, Nicholas, and Yelaja, Prithi. Knowing the neighbours.06/25 2005. Available from <http://www.dpcdsb.org/NR/rdonlyres/9AB5EDC3-4EA7-4CDE-A973-2F50A4679C08/61204/Knowingtheneighbours.pdf> (accessed 01/28 2015).
24. Murdie, Robert, and Carlos Teixeira. The Impact of Gentrification on Ethnic Neighbourhoods in Toronto: A Case Study of Little Portugal. Tech. N.p.: Urban Studies, 2011. Print.
25. Qadeer, Mohammad, and Sandeep Kumar. 2006. Ethnic enclaves and social cohesion. , <http://ejtest.uwinnipeg.ca/bitstream/handle/10680/382/a-qadeer-eng.pdf?sequence=1> (accessed 01/28 2015).

2. HISTORIC AND DEMOGRAPHIC ANALYSIS OF GERRARD BAZAAR |

2.1 Site History

2.2 Current Demographics

2.3 Current Conditions and Initiatives

Endnotes



Fig 2.01: Advertisement of the Gerrard Bazaar

2.1 Site History

The Gerrard Bazaar is situated along Gerrard Street East, between Greenwood and Coxwell Avenues, in Toronto. As such, it falls within the Greenwood-Coxwell neighbourhood and houses more than 100 South Asian shops and services.

The history of this area is best recorded from the late 1700's and onwards. In 1791, John Graves Simcoe was appointed the Lt. Governor of Upper Canada. After pursuing land surveys of the new town of York, he chose to locate the provincial government in the area, as well as reside there. Soon after, this town became home to public buildings and barracks, and new roads were constantly being built. Thirty- five township lots within the waterfront region, were created in 1796, as per the plan for the township. These were offered by Simcoe to anyone of "good character" and who was willing to swear loyalty to the British government, for no charge.¹

Arriving to the region on a small boat across Lake Ontario, the Ashbridge family was interested in obtaining this free land. They came from Pennsylvania in 1793 and consisted of a widow, Sarah Ashbridge, and her five children. Two of her daughters were already married with a family, while the rest were unmarried. After their arrival at what is now called Ashbridge's Bay, the widow and her two sons received a total of 600 acres of land. This land was divided up equally among them at 200 acres each, and was situated to the East of the Don River at a distance of approximately 1.5 miles. Parker Mills, and Paul Wilcott, who was married to one of the Ashbridge's daughters, were also among those who owned portions of land in the area. The Small family was another family that bought 500 acres of land which spanned between the edge of Lake Ontario all the way to Danforth Avenue. This land consisted of lots 6, 7 and 8 within the Township of York. Coxwell Avenue was built soon after, by Peter Small. The name referred to his son, Charles Coxwell Small, after whom the street was built. According to previous reports, Hugh Cochran, an early European settler, constructed several houses in



Fig 2.02: Site of the Gerrard Bazaar



Fig 2.03: Ashbridge's family home

the area, including one at the corner of Woodfield Avenue and Walpole Road.²

During the beginning of the 20th century, there was significant infrastructural development within the neighbourhood. New streets were paved, including Woodbridge Road, Ashdale Avenue, Rhodes Avenue, and Gerrard Street East (figure 2.04). In 1912, the first local streetcar line was put into place. This "civic car", route ran from the Toronto's Railway Parliament Line terminal at Gerrard Street, towards the eastern end of the city. Near the terminal was the East Toronto Pumping Station which provided power for the streetcar line. In 1913, the Danforth began, allowing for rapid transit development to and within the region.²

Residential development within the area began in the early 1900's and continuously evolved due to key buildings and immigration patterns. The current church, which stands along Gerrard Street East, was the result of a merger between the Presbyterian and Methodist Churches in 1924. It was constructed in 1926 (Figure 2.08) and currently houses church functions as well as a Pakistani Community Centre. In 1919, the construction of the Coxwell Stables (Figure 2.07) allowed for the accommodation of all of the horses that were utilized for the Toronto Public Works Department transportation system. These later became warehouses due to the increase of vehicular transportation. The building was branded a historical site by the Toronto Historical Board in 1981. Today, the site is a CityHome, which offers affordable rental housing by the city. The Orange Hall, along Rhodes Avenue, belonged to the Orange Order, and was rented by a Christian Gospel Group in 1917. It went through other uses, including a place of gathering for the local soccer team and a mosque for the Islamic Foundation of Toronto in 1969 (Figure 2.09).

Currently at the brink of abandonment, the Ulster Arms Tavern is situated along the western part of Gerrard Street and is named after the Ulster



Fig 2.04: Gerrard Street, 1911

Stadium, which was located south of the street. The conversion of a clay mine into Greenwood Park (Figure 2.08) was another key change that took place as a result of the evolving housing patterns. Furthermore, in 1924 the Gerrard/Ashdale branch library (Figure 2.08) opened its doors to foster a better sense of community within the neighbourhood.²

During the early 1900's, the area was inhabited by a working-class of English, Irish and Scottish origin. Occupations included transit workers and railway workers, Eaton's workers and police officers. After World War II, there became a prominence of Italians and Greeks within the area, who later moved to the suburbs. While this occurred, immigrants from China and South Asia settled into the neighbourhood, for housing was fairly affordable.² This illustrates that the gentrification has been a part of the natural evolution of the Gerrard Bazaar and as such, the design proposal must acknowledge and integrate this as opposed to try to counteract it.

The key entity that served as a catalyst for the birth of the South Asian character of the enclave was the Naaz Theatre (Figure 2.06). In 1972, a man by the name of Gian Naaz emigrated from India. He rented out the Eastwood Theatre, which was vacant at the time, and setup a Bollywood cinema house. This had the ability to reverse the decline that the commercial strip was experiencing during the late 1960's, for it resulted in the emergence of numerous South Asian businesses along the street between Woodfield and Coxwell Avenue. The theatre not only served as a place where Hindi films could be viewed but also as a venue for ethnic functions and gatherings. Various South Asian businesses opened their doors across from, and adjacent to, the cinema house, including Skylark Restaurant in 1974, Milan's Department Store, and Amitabh Shopping Mall. The mall in which the theatre was situated, had itself become a hub of mostly East Indian take-out and shopping. Over time, Indian, Pakistani, Sri Lankan and Bangladeshi businesses sprouted in various locations along Gerrard Street, allowing for significant attention from the media, and the official branding of the destination as "Little

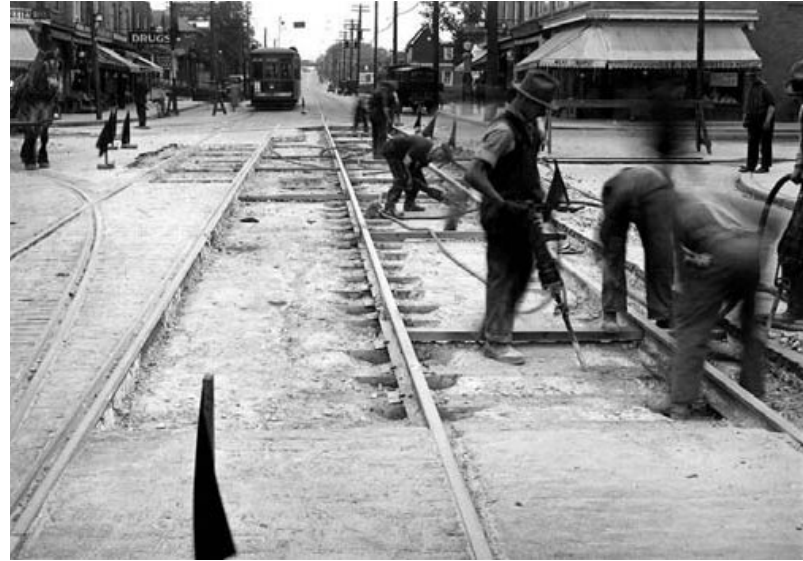


Fig 2.05: Gerrard Street, 1926

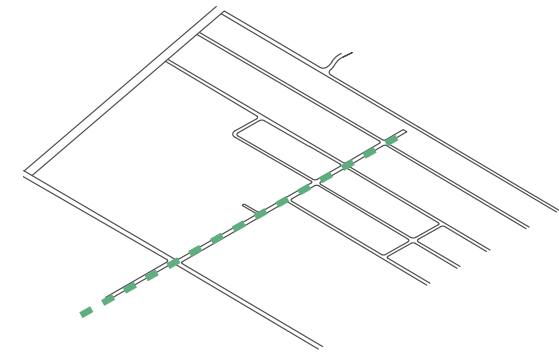
India" during the 1980's. This identity was further reinforced when the commercial property on Gerrard Street, between Craven and Woodfield Roads, became approved by the city as the Gerrard India Bazaar Business Improvement Area. In 1984, the ethnic enclave, comprised at the time of roughly 100 South Asian stores and restaurants, received an estimated 10,000 tourists from the United States.²

Aesthetics began to become a concern for the ethnic retail strip during the start of the 1980's, as buildings and facades became prone to deterioration and damage. Other issues relating to the broader context emerged, including ill-maintained sidewalks, lack of sufficient lighting, lack of adequate parking and improper parking of vehicles. As such, the BIA undertook initiatives to repair these concerns. New lights for the street, and the creation of new parking space were two initial attempts at bettering the enclave.²

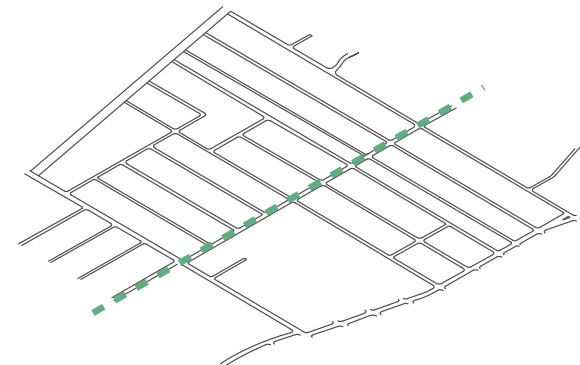


Fig 2.06: The Naaz Theatre

Timeline Diagrams - Key Buildings and Number of Houses Constructed

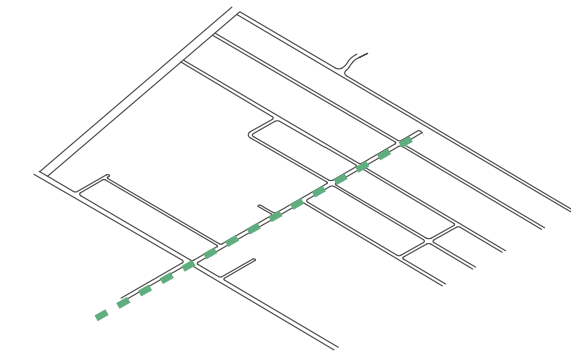


Street Morphology 1910

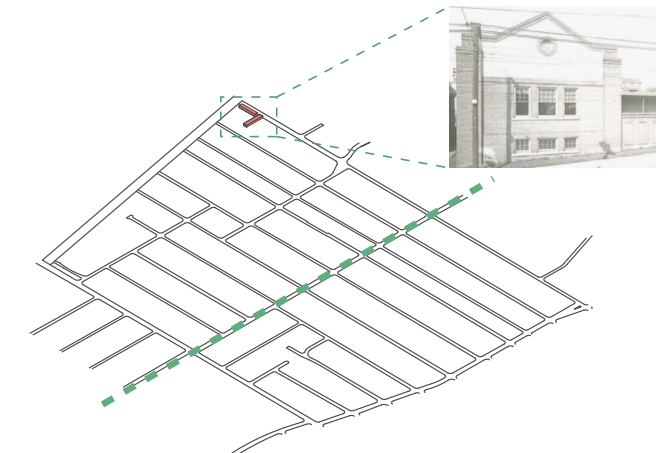


Street Morphology 1918

These maps show how the street morphology changed within the neighbourhood until the Coxwell Stables were constructed in 1919.



Street Morphology 1913



Construction of Coxwell Stables 1919

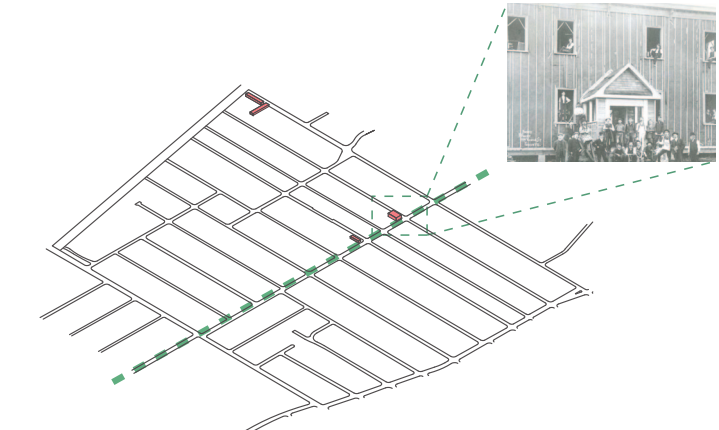
----- Gerrard Street East

Figure 2.07: Timeline diagrams (Gerrard Ashdale neighbourhood) 1910 - 1919

Timeline Diagrams - Key Buildings and Number of Houses Constructed

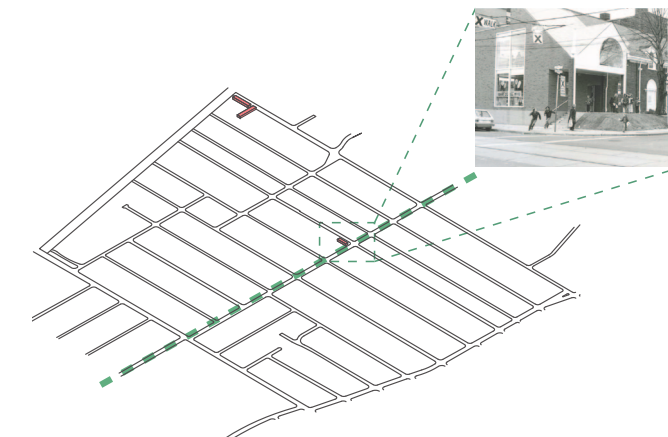


Conversion of Clay Mines to Greenwood Park 1920

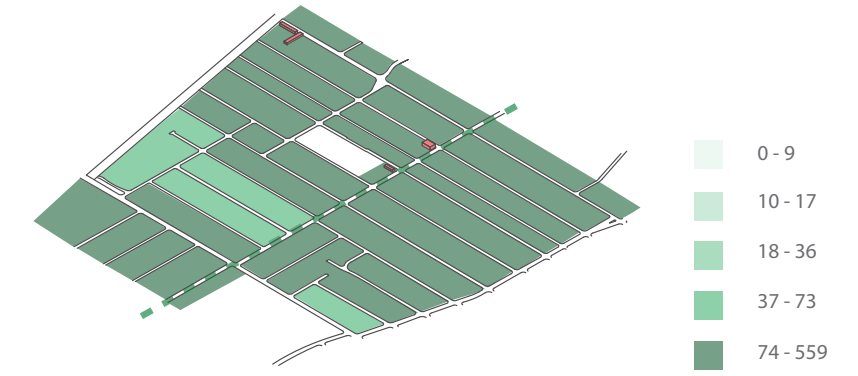


Construction of Presbyterian Church 1926

These maps show how the 1920's marked a change in the type of buildings constructed within the neighbourhood - they were mostly community-based programs. This also led to a boom in housing construction within the neighbourhood.



Gerrard/ Ashdale Library Constructed 1924

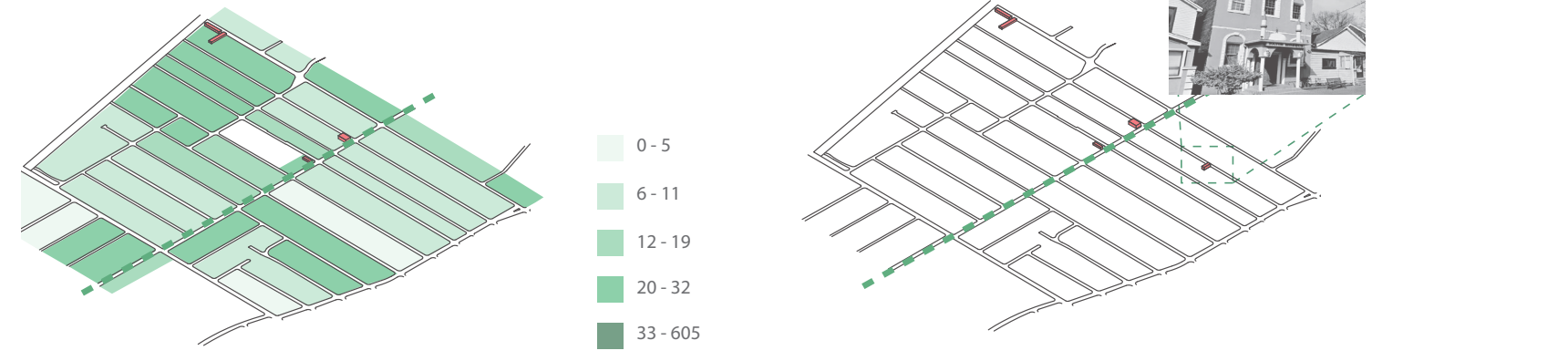


- 0 - 9
- 10 - 17
- 18 - 36
- 37 - 73
- 74 - 559

Houses Constructed Before 1946

Figure 2.08: Timeline diagrams (Gerrard Ashdale neighbourhood) 1920 - 1946

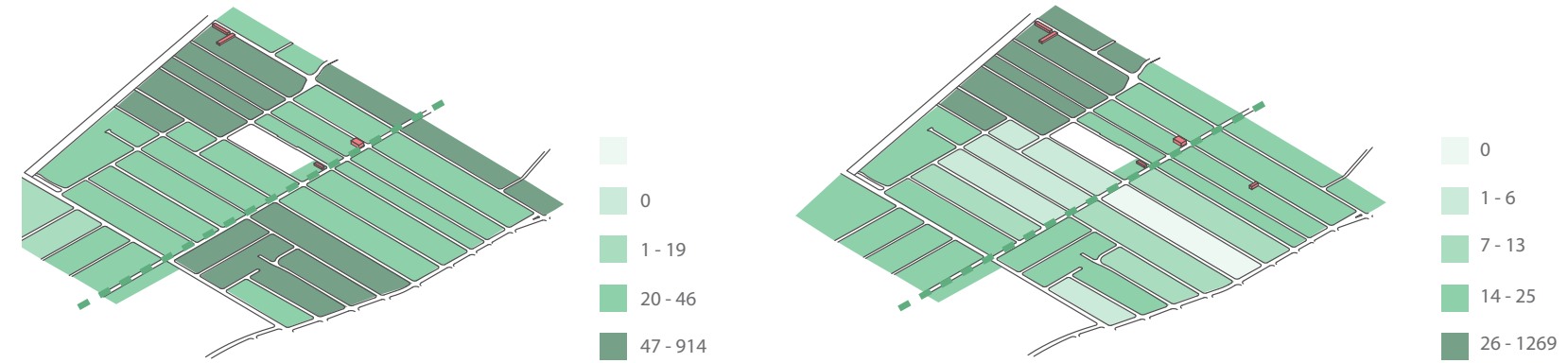
Timeline Diagrams - Key Buildings, Number of Houses Constructed, Number of Immigrants



Immigrants Before 1961

Islamic Foundation of Toronto Established 1969

These maps show how the Islamic Foundation of Toronto was built after immigrants began to move into the area. Housing construction began to decrease but immigration increased.

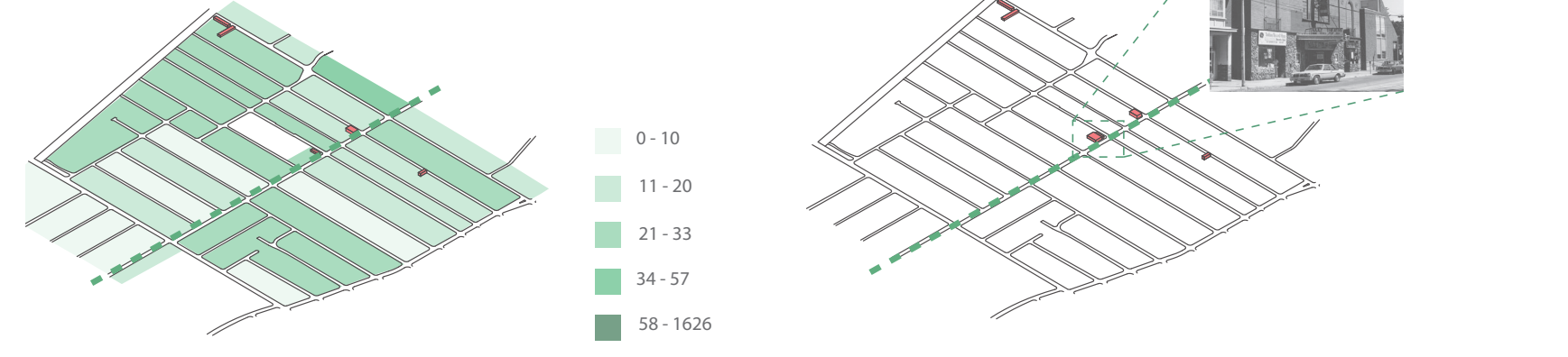


Houses Constructed 1960

Immigrants 1961 - 1970

Figure 2.09: Timeline diagrams (Gerrard Ashdale neighbourhood) 1961 - 1970

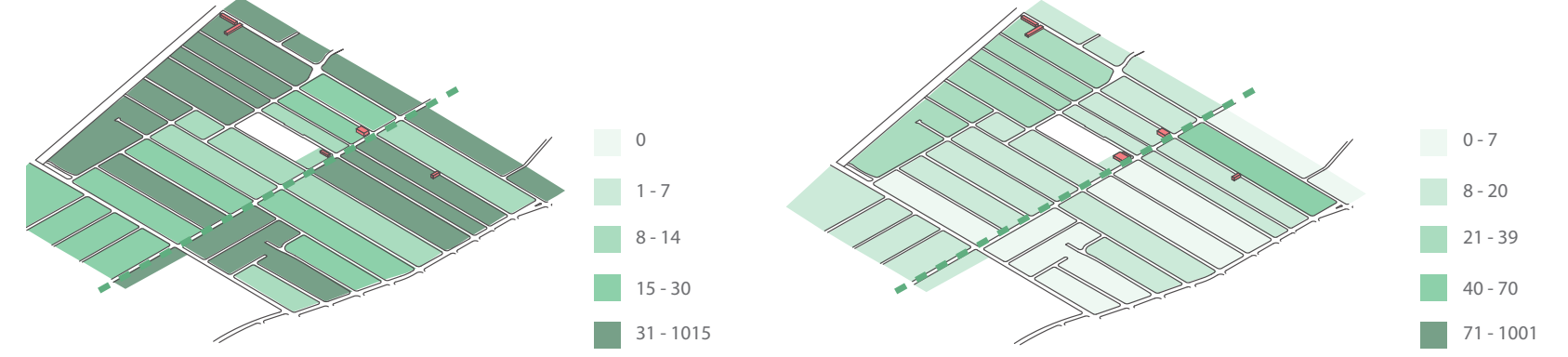
Timeline Diagrams - Key Buildings, Number of Houses Constructed, Number of Immigrants



Houses Constructed 1970

Naaz Theatre Established 1972

These maps illustrate how housing construction decreased before the construction of the Naaz Theatre, but increased once again after the retail strip became an ethnic enclave.

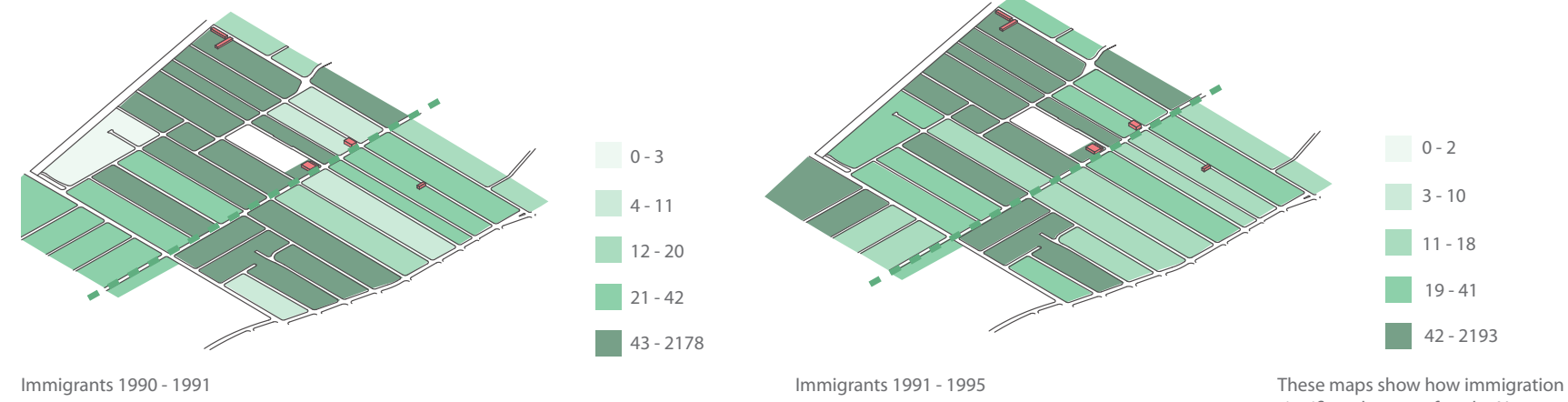


Houses Constructed 1971 - 1980

Houses Constructed 1980

Figure 2.10: Timeline diagrams (Gerrard Ashdale neighbourhood) 1970 - 1980

Timeline Diagrams - Key Buildings and Number of Houses Constructed



These maps show how immigration significantly grew after the Naaz Theatre was established, yet housing construction decreased.

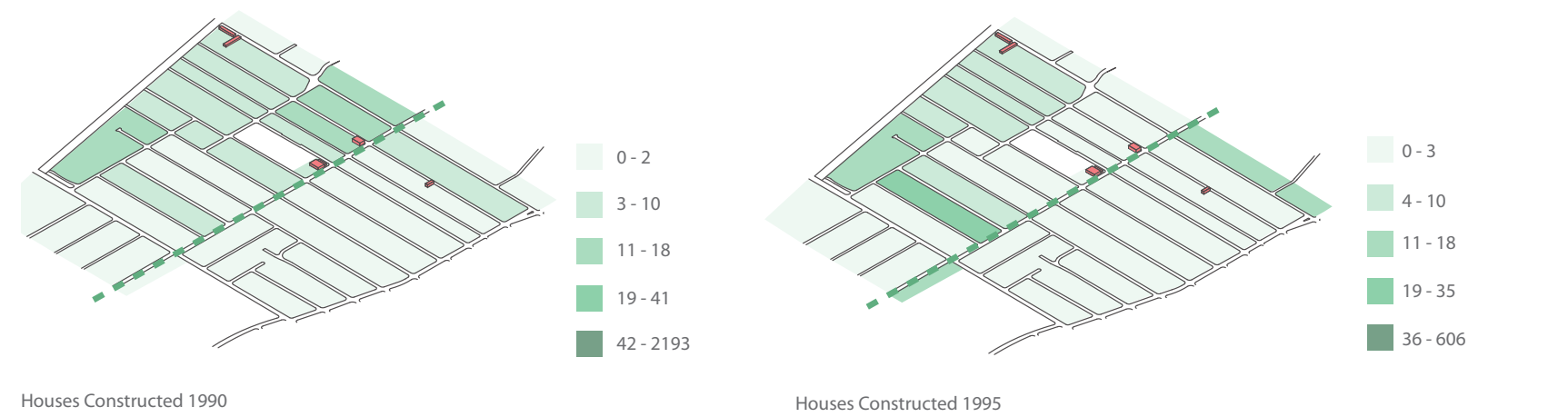
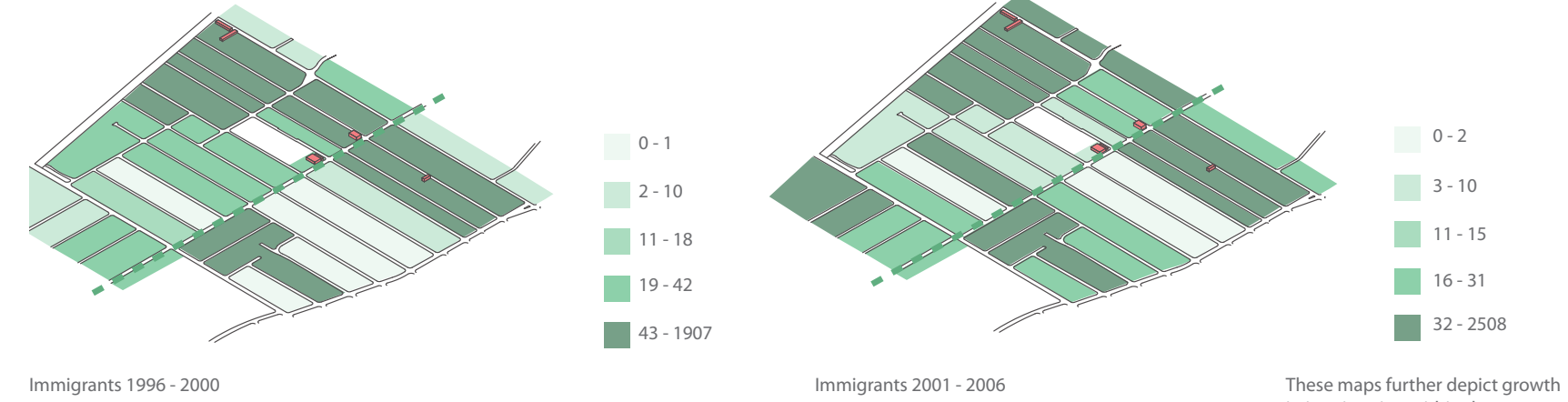


Figure 2.11: Timeline diagrams (Gerrard Ashdale neighbourhood) 1990 - 1995

Timeline Diagrams - Key Buildings and Number of Houses Constructed



These maps further depict growth in immigration within the area, but diminishing residential construction. This would also suggest that many houses within the area are old and small in size - something that would not appeal to or be functional for the average immigrant family.

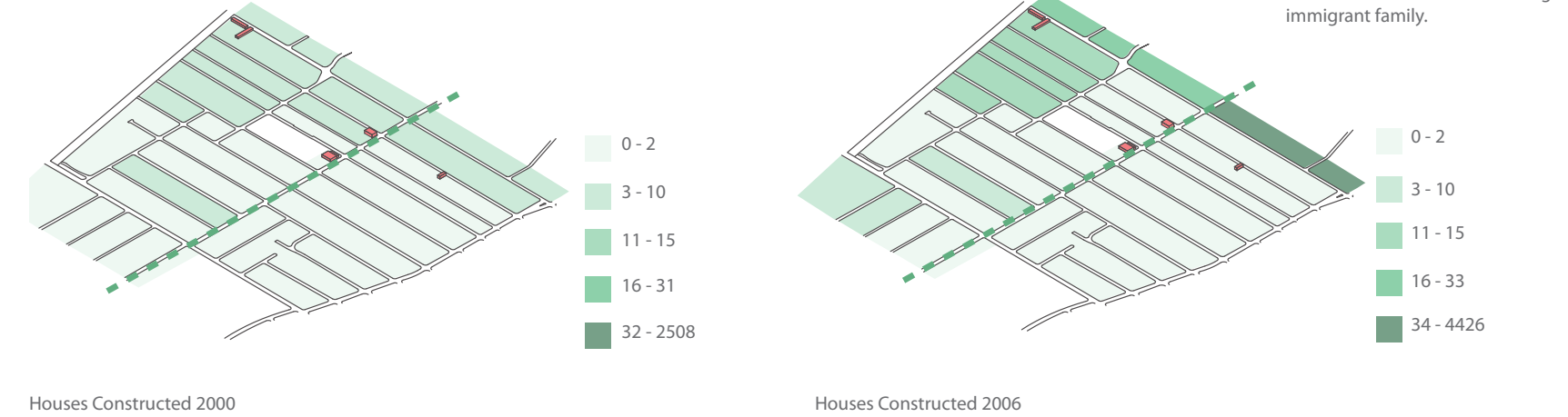
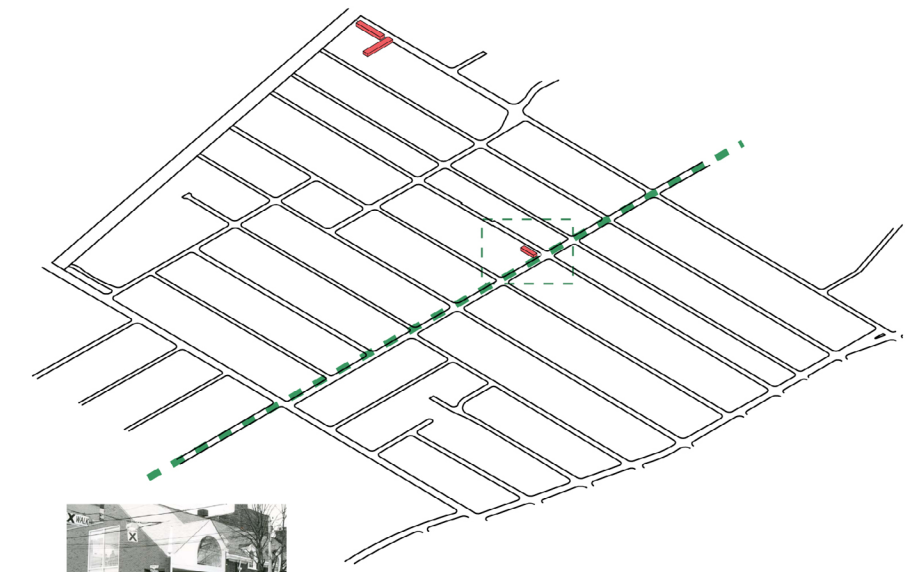


Figure 2.12: Timeline diagrams (Gerrard Ashdale neighbourhood) 1996 - 2006

CATALYST #1

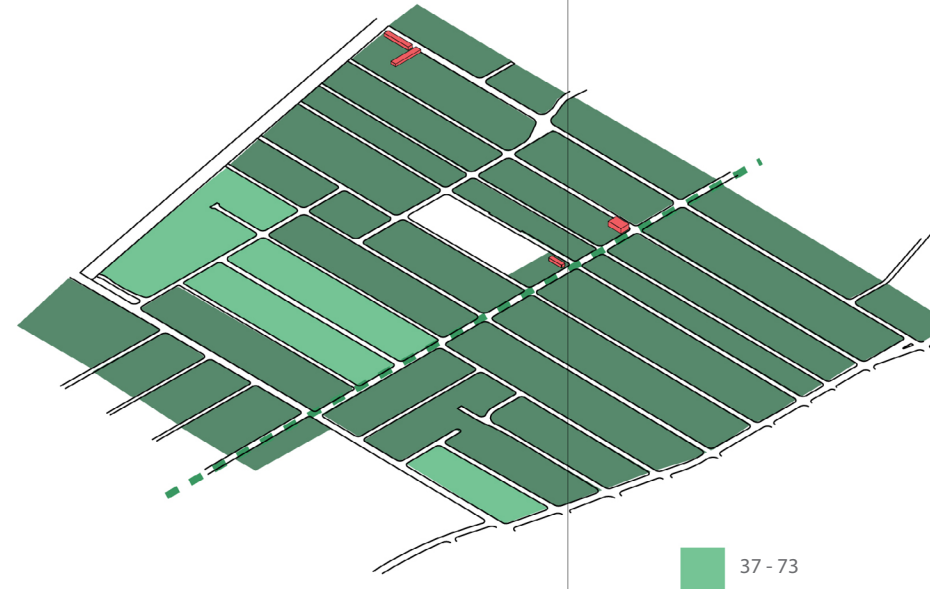
FACILITATES COMMUNITY GATHERING



Gerrard/ Ashdale Library

RESULT

COMMUNITY GROWTH



- 37 - 73
- 74 - 559

CATALYST #2

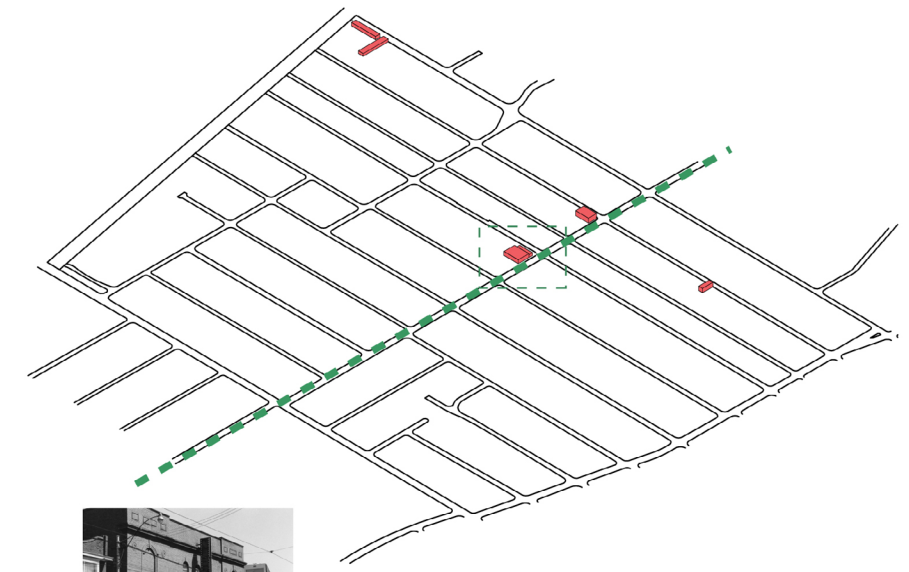
FACILITATES RELIGIOUS GATHERING



Islamic Foundation of Toronto

CATALYST #3

FACILITATES CULTURAL GATHERING



Naaz Theatre

Figure 2.13: Key catalysts within historic timeline

When looking at Figure 2.13 it can be seen that there were three key catalysts within the history of the Gerrard Bazaar that promoted different types of gathering and served to encourage social cohesion within the neighbourhood. These three entities were the Gerrard/ Ashdale Library, the Islamic Foundation of Toronto and, of course, the Naaz Theatre.

The library was the first entity that came into being in order to establish a sense of community within the neighbourhood, promote social gathering, and foster learning for all ages. As such, it served as a key entity that promoted community gathering. A sharp growth in housing construction began shortly after the library's establishment, indicating that it served as a catalyst for residential and population growth.

The second important organization was the Islamic Foundation of Toronto which encouraged religious gathering and interaction. It served as an institution that supported and guided the newly growing South Asian and Muslim community in the region. Therefore, it stood as a source of guidance and support for the ethnic community nearby.

The third important entity was the Naaz Theatre, which, as mentioned earlier, initiated the Gerrard Bazaar's very existence but also cultural and celebratory gathering. In this respect, it promoted and celebrated the South Asian culture.

These three entities shed light on the fact that a catalytic program came about within the neighbourhood as a response to a need in the community. The type of catalyst changed, due to demographic changes. This supports the objective and position of this thesis which suggests that the Gerrard Bazaar is in transition and is in need of a design intervention that would respond to the current challenges and changes within the community. However, it also suggests that institutions such as libraries are ideal places that support a well-established, family-oriented community, whereas ethnically religious or cultural organizations

support a growing ethnic community. Given that the Gerrard Bazaar caters to both these types of groups, the ultimate design interventions would do well to accommodate and incorporate these three kinds of programs so as to break down barriers between different ethnic groups and promote ethnic and cultural mixing.



Fig 2.14: Nearby resident within the Gerrard Bazaar

2.2 Current Demographics

Restaurants, specialty stores and clothiers are ample within the Gerrard Bazaar yet economic growth remains slow. The SARS outbreak as well as the 9/11 Terror Attacks deeply affected the retail strip and the rest of the city, however, competition with suburban South Asian businesses is also a key factor that has affected the prosperity of the ethnic enclave³. Gentrification is currently transpiring within the Gerrard Bazaar as within the surrounding region. In spite of this demographic change bringing more affluent individuals to stimulate the economy, it also brings with it an increase in rent expenses as well as the infiltration of non-ethnic businesses within the retail strip.

There is a reasonable presence of South Asians within the neighbourhood and there has been a recent influx of immigrants from this ethnic group within the area¹⁷. However this concentration is significantly less than the number of South Asians elsewhere within the Greater Toronto Area. As seen in Figure 2.15 - 2.18, the region within a 3km and 5km walking distance of the ethnic enclave has a low percentage of South Asian minorities in comparison to regions which are at the periphery of the 5km mark. Over time, the community has witnessed the influx of younger, predominantly Caucasian couples with young children, thus resulting in a more diverse demographic trend.

These findings reinforce the fact that the design intervention needs to consider the regular requirements and desires of non-South Asian residents and the occasional needs and desires of South Asian visitors. Moreover, once again, they suggest that the design proposal needs to cater to South Asian and non-South Asian ethnic groups in such a way that it is inclusive and promotes shared cultural and social experiences.

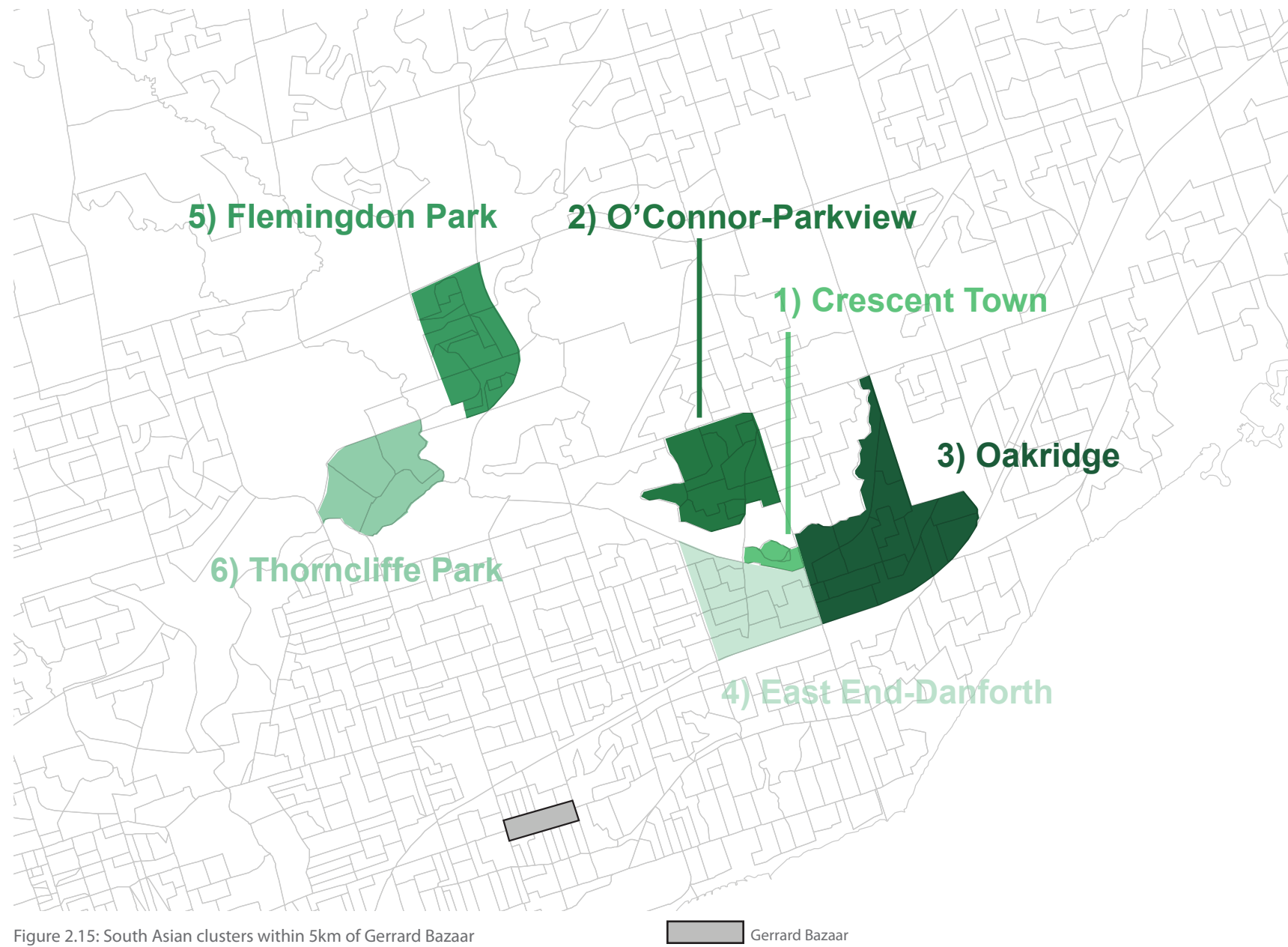


Figure 2.15: South Asian clusters within 5km of Gerrard Bazaar

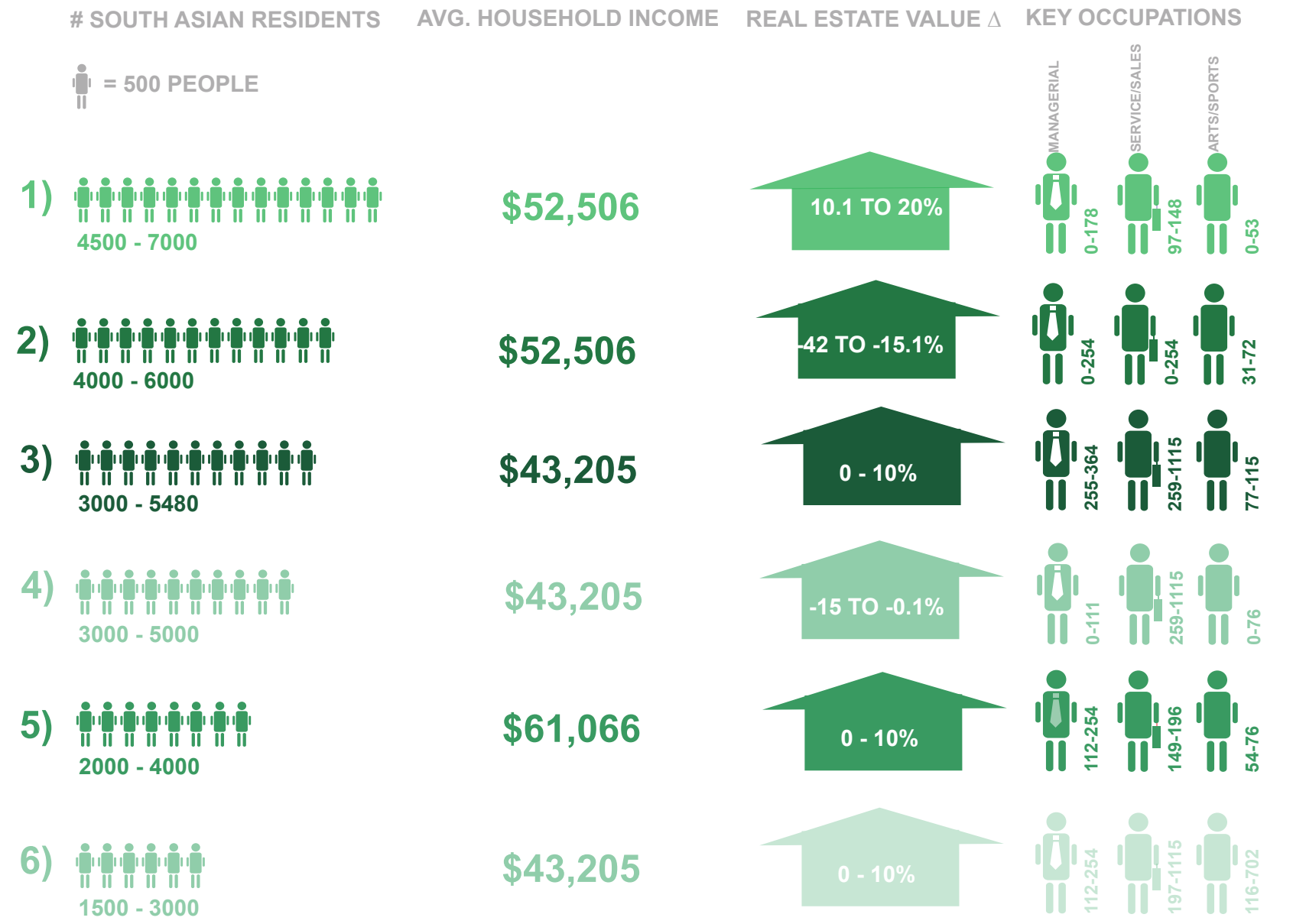


Figure 2.16: South Asian clusters within 5km of Gerrard Bazaar - key demographic information

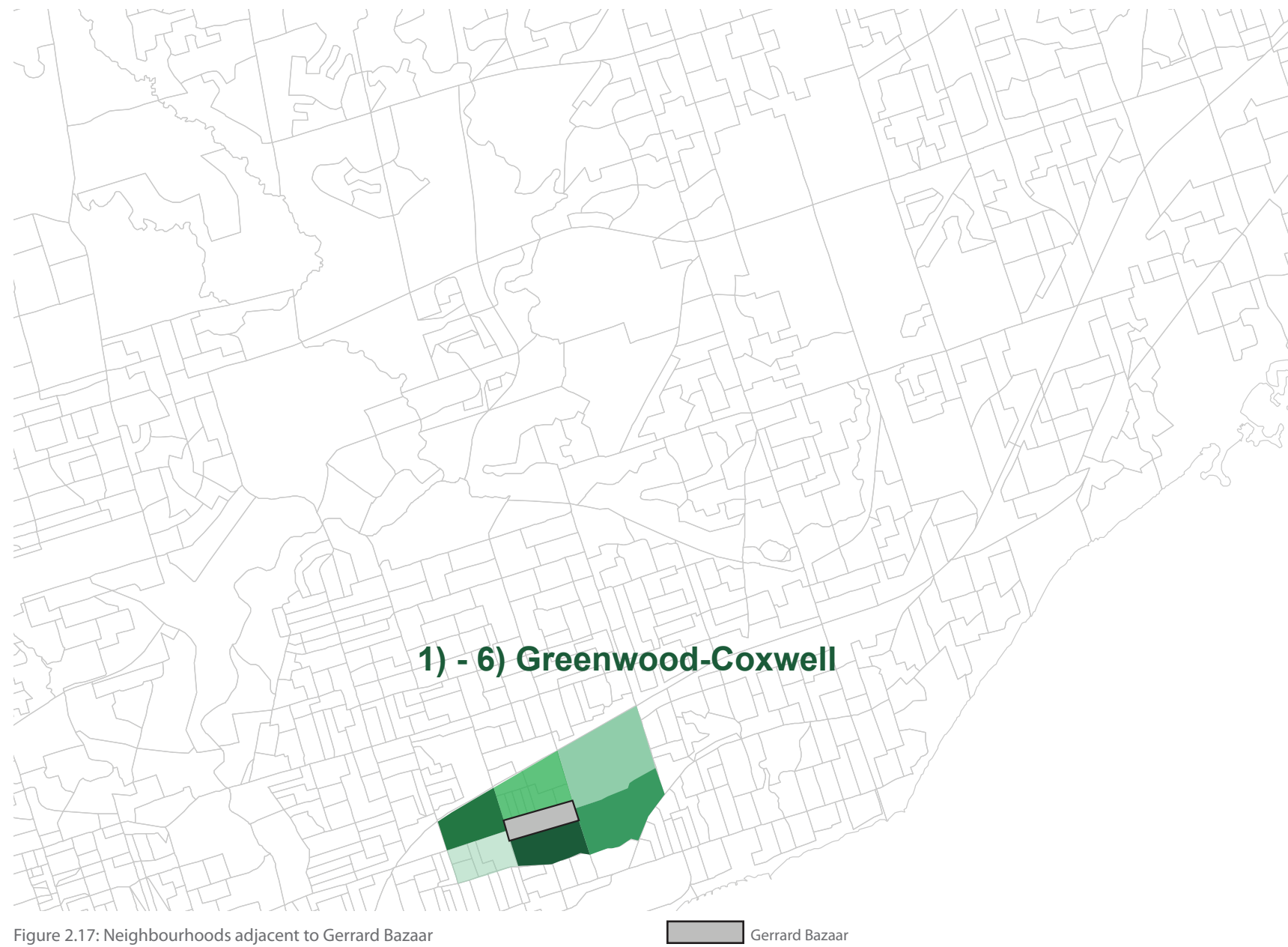


Figure 2.17: Neighbourhoods adjacent to Gerrard Bazaar

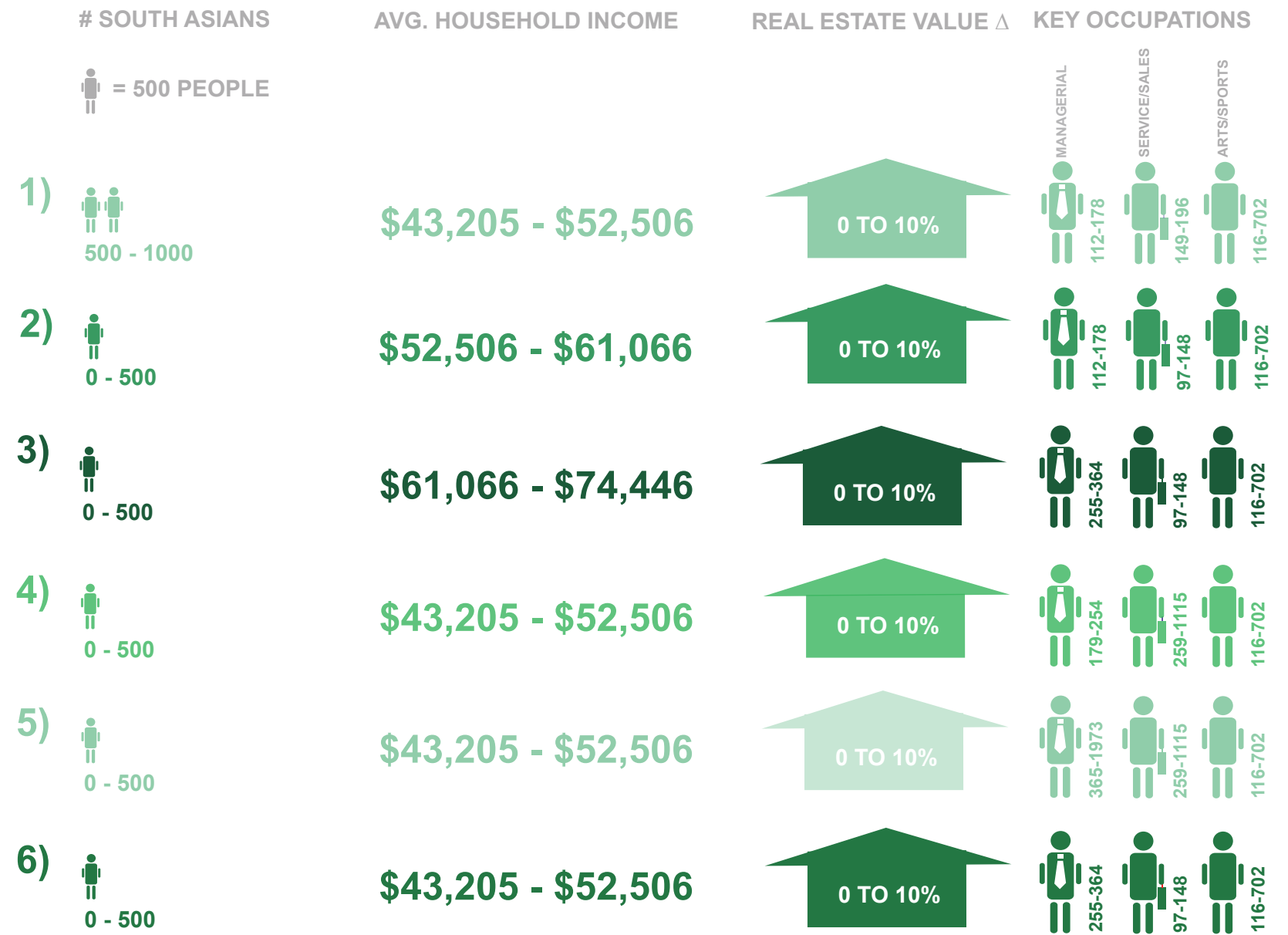


Figure 2.18: Neighbourhoods adjacent to Gerrard Bazaar - key demographic information

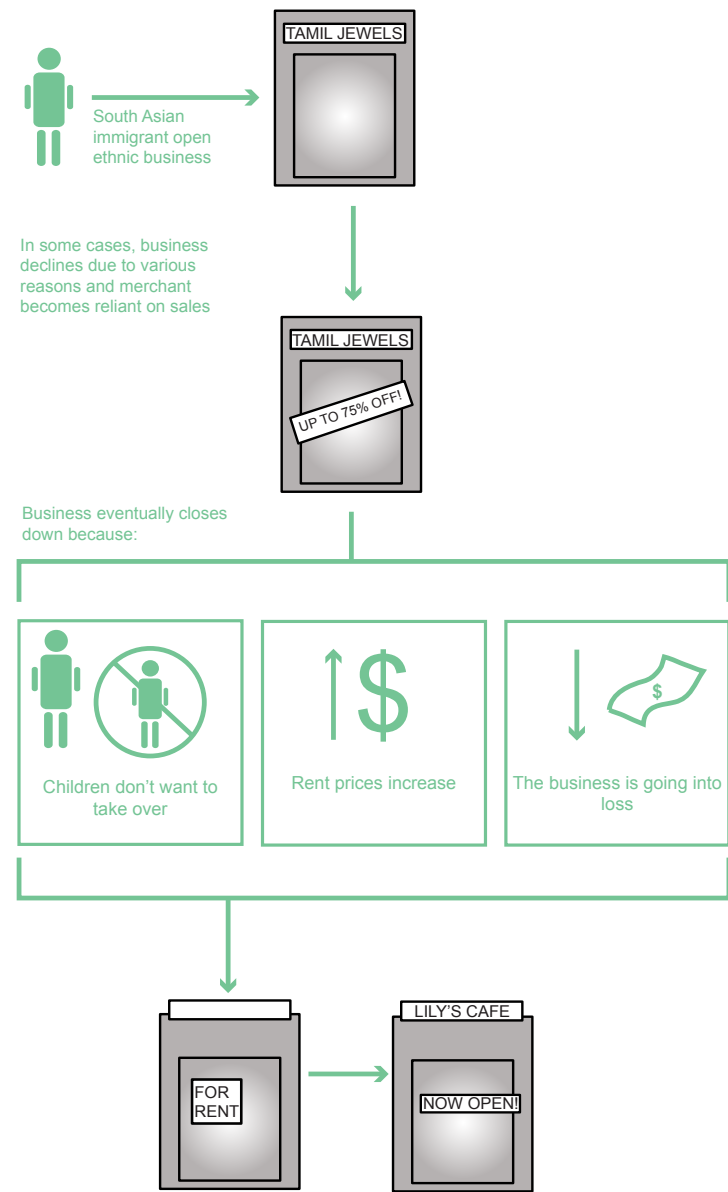


Fig 2.19: Diagram depicting evolving storefronts within the Gerrard Bazaar

2.3 Current conditions and initiatives

The issue of urban vacancy has plagued the Gerrard Bazaar for a number of years and was at its peak, a rate of 12.6%, in 2009⁴. A number of ethnic businesses within the enclave are closing down mainly due to two reasons: the rent prices are too expensive, as mentioned earlier, or their children have refrained from managing the business after their parents' retirement. In some instances, the business expands and either, re-locates within suburban regions to serve the larger South Asian population residing there, or occupies a larger retail space along the strip. Despite the efforts of the BIA to allow predominantly South Asian businesses to re-occupy vacant storefronts, a number of former ethnic businesses are being replaced with non-South Asian coffee shops, housing and institutions. For example, the building that housed the Naaz Theatre, the entity that gave birth to the South Asian character of the site, is now being converted into an apartment building (Figure 2.20). Another instance of this demographic trend is examined in the case of a current sari clothier, which is undergoing a closing down sale. Soon after the current tenants depart, the building will house a new medical centre.

Lack of aesthetic appeal and vibrancy is another factor that is prominent within the Gerrard Bazaar. One concern is the mess that is created by the large population of pigeons in the area (Figure 2.24 - 2.25). This has come about due to numerous storeowners feeding them, for it is believed to bestow good luck upon one, in South Asian culture. This, however, has taken a toll on how visitors and residents perceive the place.¹

To counteract this aesthetic issue and beautify the strip, a façade mural program was initiated by a local social enterprise, the Riverdale Hub, in the year 2012. This organization, which aims to promote social and economic development in communities, received a \$17,000 grant from StreetARToronto in 2012 in order to begin this GerrardART project. The project consists of large-scale paintings that embrace South Asian symbology as well as other cultural symbols to represent the various



Figure 2.20: Evolution of the Naaz Theatre to apartments



Figure 2.21: Transformation of a vacant store to non-South Asian coffee shop



Figure 2.22: Retail statistics over time - Gerrard Bazaar



Figure 2.23: Winter time at the Gerrard Bazaar



Figure 2.24: Pigeons fed by storeowners



Fig 2.25: Pigeon droppings on the street

cultures present on the site. Islamic calligraphy, Indian art, henna designs, animals and plants are painted in eye-catching colours on various facades, thus adding to the visual appeal of the retail strip (Figure 2.26 - 2.28). The key aim of this project is to stimulate the retail development and the growth of visitors to the area.⁵

The Gerrard Bazaar operates as a one-stop shop destination for South Asians and the general public alike. Due to this, the ethnic enclave continuously caters and promotes itself to the mainstream market while simultaneously serving its local and dedicated South Asian clientele.¹ Roughly 70% – 80% of the merchants within the Gerrard Bazaar own their property. Additionally, the South Asian entrepreneurs tend to adopt an independent business framework which helps them function within and adapt to their context. This is different from the way in which Chinese entrepreneurs operate their businesses, which are clan-based and therefore more collectively operated.¹ As seen in Figures 2.22, the number of new business ventures entering the Gerrard Bazaar roughly equals to the number of those that are terminating. There has also been a general increase of the number of business enterprises since the year 1993. These shops are both, South Asian as well as non-South Asian. There are also several East Asian retail enterprises due to the close proximity of East Chinatown and the high Chinese population in the area. There has been a significant increase in the number of Pakistani businesses along the western end of the retail street, which may lend to the large concentration of Pakistanis settled there. This portion is sometimes dubbed “Little Pakistan” and is dominated by Muslim-owned enterprises. This has resulted in slight inter-cultural conflict where the Muslim-owned enterprises are hesitant to join the Gerrard India Bazaar since they feel that it does not fully cater to their religion and culture.¹



Fig 2.26: Large painted mural along the western part of the Bazaar



Fig 2.27: Indian-inspired mural on library wall



Fig 2.28: Painted murals along wall of Bombay Chowpatty

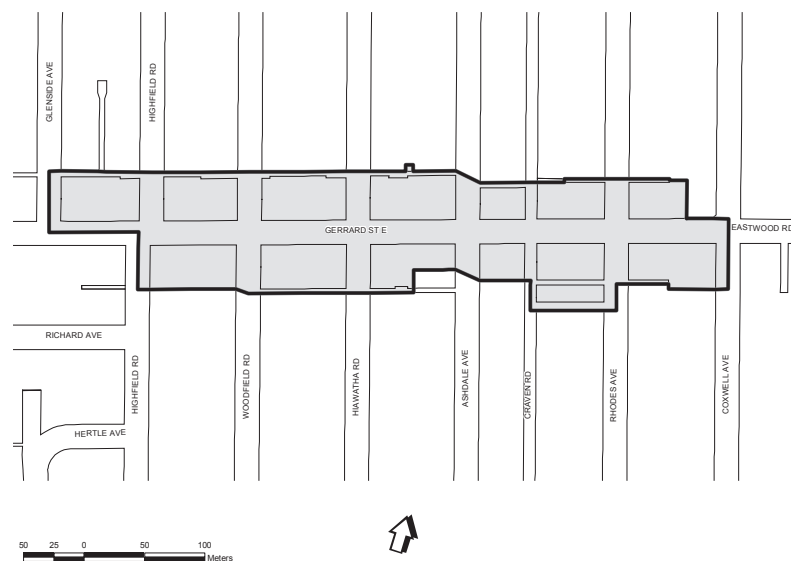


Fig 2.29: The Gerrard Bazaar BIA boundary

The Business Improvement Area (BIA) of the Gerrard Bazaar is continuously active in improving the retail strip through various means. Currently the BIA consists of fourteen property owners and store operators which are elected as board members. Other members include: two local councilors, one Commercial Area advisor and two part-time employees⁶. Those who are a part of the board, generate an internal budget which they inform the city of. The city then collects this in the form of a levy from each of the merchants involved. Merchants, who have larger properties, pay a larger levy. The city later gives this amount back to the BIA in order to allot specific funds to various improvement initiatives that indirectly are meant to benefit the merchants involved. When the BIA was newly established, the budget within the first year was \$10,000. This was utilized for the design and marketing of the logo as well the organization of various events such as movie nights and cultural celebrations.⁶

Certain areas in which the Gerrard Bazaar BIA allots money are: capital projects (streetscape and façade improvement projects), marketing and events, and administrative operations. About half of these funds are invested in capital projects so as to create a good image for the retail strip and boost its social and economic functions. Such projects include the installation of street lamps, building of planters, and production of street art. Significant funds are also invested in marketing and event planning, which once again is meant to stimulate the ethnic enclave's image and touristic function⁷.

The BIA also collaborated with the planning faculty at Ryerson University to conduct a visual re-design study on the retail strip. The purpose of this was to: re-develop the ethnic identity of the bazaar and to re-design the physical space to make it more appealing. Thirteen students undertook this urban design exercise which consisted of conducting interviews, GIS mapping, and case study analyses in order to devise a design proposal. A Bollywood theme was proposed that included various elements such as a themed streetcar, colourful murals and signage that related to cinema,

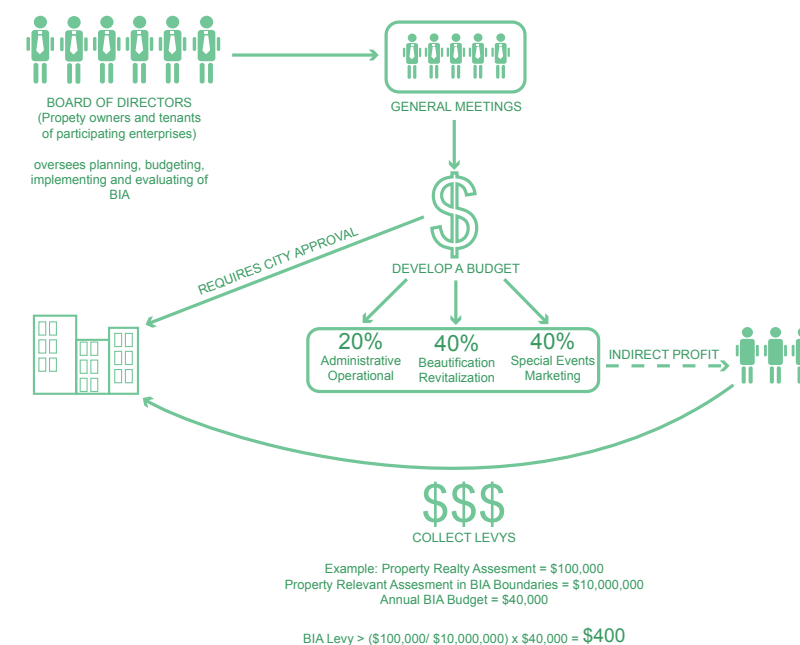


Fig 2.30: BIA operational structure

and a re-designed streetscape resembling a Walk of Fame. Although none of these proposals were ever implemented, they shed light on how it is imperative to truly understand the South Asian heritage in order to formulate a design strategy that would acknowledge both, planning principles and culture.⁸

The possibility of a South Asian cultural centre was also explored. City officials and members of the retail strip were presented with various ideas from students. This concept was also disregarded, however, due to funding issues.¹

Endnotes

1. Beverly, Ted. No year. The Neighbourhood Around Gerrard/Ashdale: An Annotated Bibliography. Introduction by Ruth E. Wallace. Toronto: Toronto Public Library, Gerrard/Ashdale Branch.
2. Bauder, Harald, and Angelica Suorineni. Toronto's Little India: A Brief Neighbourhood History. Toronto, Ont.: Ryerson University, 2010. Print.
3. Bauder, Harald, and Isabel Ritchie. 2011. Toronto's little india in residential context: A geographical analysis of census data. Toronto: Geography Publications and Research, 35.
4. Zhuang, Zhixi Cecilia. 2008. Ethnic retailing and the role of municipal planning four case studies in the greater toronto area. Waterloo, Ont. : University of Waterloo.
5. Lavoie, Joanna. GerrardART project aims to revitalize little india neighbourhood. in Inside Toronto [database online]. Toronto, 2012 [cited 05/22 2014]. Available from <http://www.insidetoronto.com/news-story/1310727-gerrardart-project-aims-to-revitalize-little-india-neighbourhood/>.
6. Zhuang, Zhixi Cecilia. 2009. Ethnic retailing and implications for planning multicultural communities. Welcoming Communities : Planning for Diverse Populations.
7. S. Chintaluri, personal communication, March 6, 2014.
8. Kumar, Sandeep, and George Martin. 2004. A case for culturally responsive urban design. The Ontario Planning Journal 19 (5): 5-7.

3. ARCHITECTURAL AND SPATIAL ANALYSIS OF GERRARD BAZAAR |

3.1 Use and Programs

3.2 Spatial Transformation and Composition

3.3 Architectural and Formal Composition

3.4 Architectural and Spatial Analysis in Relation to Design

Endnotes

3.1 Use and programs

The Gerrard Bazaar functions as a retail corridor within a predominantly residential neighbourhood. Though most of the stores are of South Asian ethnicity, there are a large number of stores on the East side of the strip that are mainstream, and a concentration of East Asian ethnic stores on the western end of the strip. As mentioned earlier, this is due to the fact that the East Chinatown ethnic enclave lies a few blocks ahead in the westerly direction.

There is a school nearby as well Greenwood Park, which further creates a sense of community within the neighbourhood.

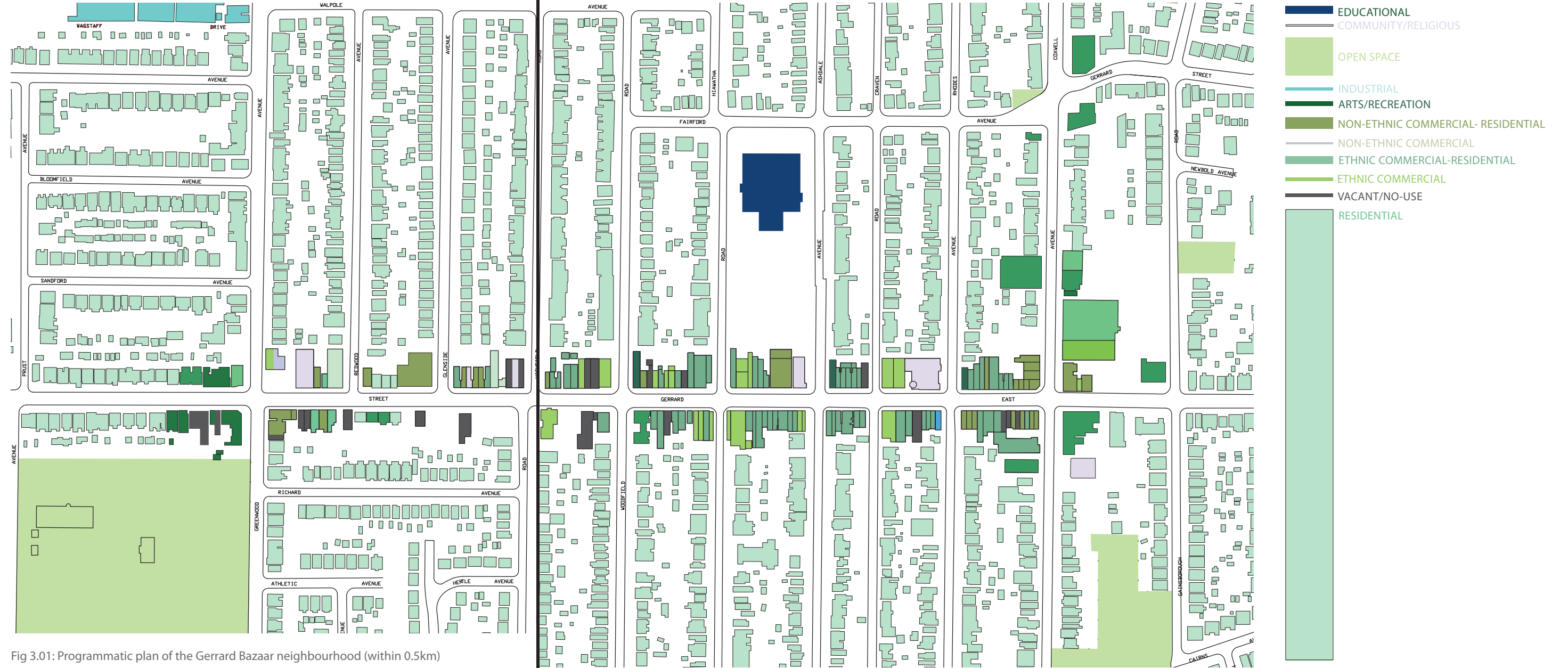


Fig 3.01: Programmatic plan of the Gerrard Bazaar neighbourhood (within 0.5km)

Program axonometric diagram of the Gerrard Bazaar

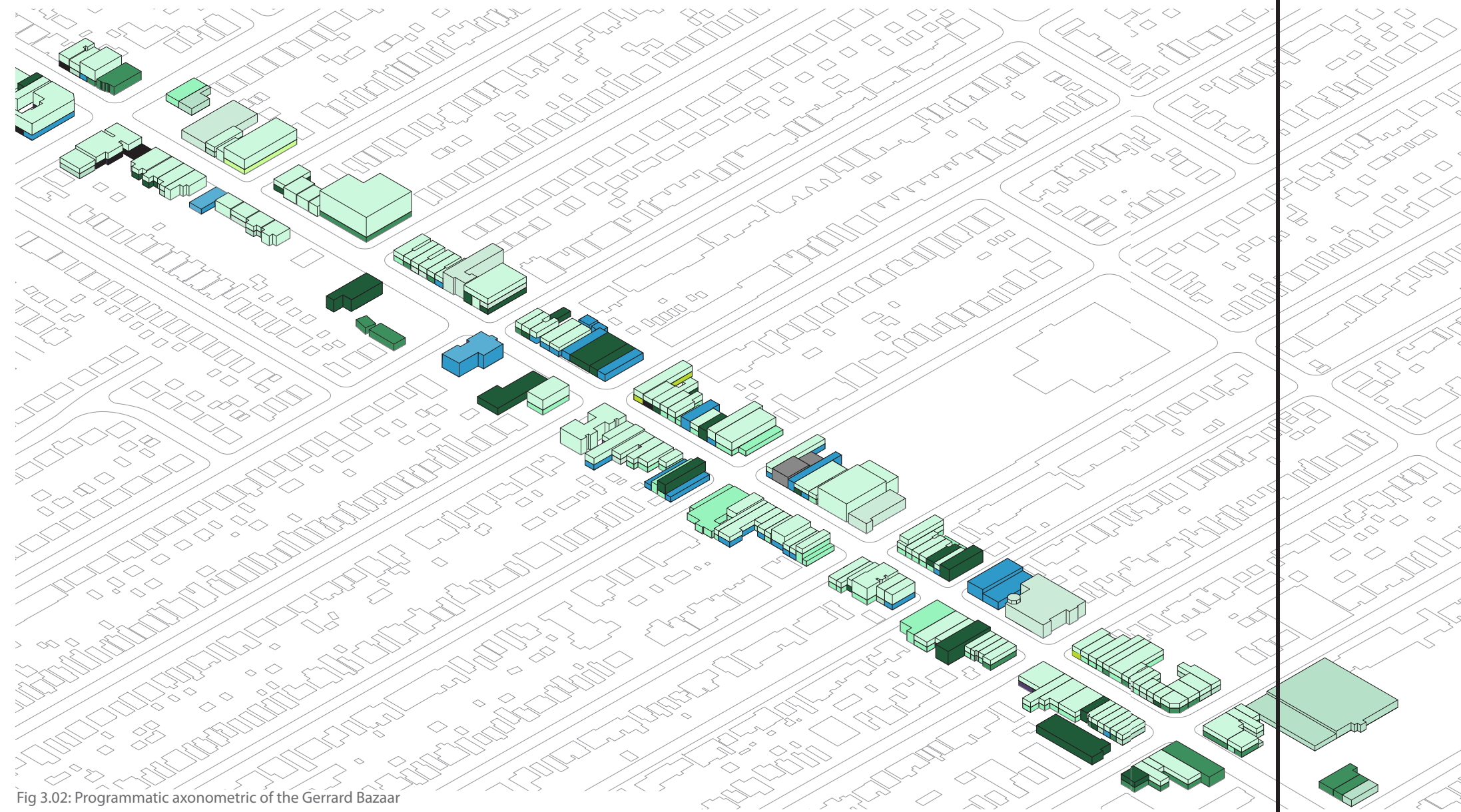
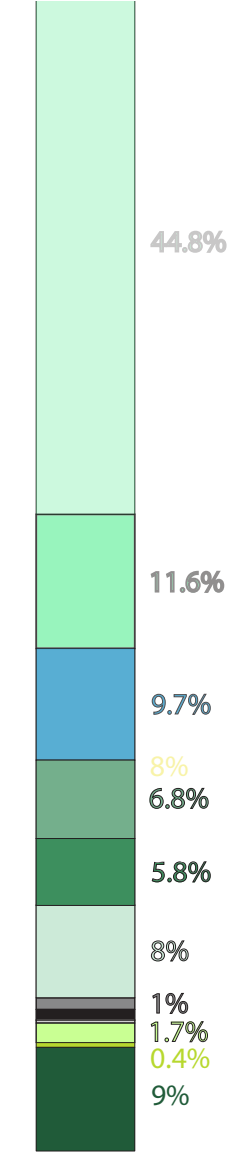


Fig 3.02: Programmatic axonometric of the Gerrard Bazaar

- Residences
- South Asian Business (Goods)
- South Asian Business (Service)
- Non-Ethnic Business (Goods)
- Non-Ethnic Business (Services)
- Community/ Religious
- Medical/Pharmaceutical
- East Asian Business (Goods)
- East Asian Business (Service)
- Theatre/ Entertainment
- Art Gallery
- Vacant



As seen in Figure 3.02, the Gerrard Bazaar's general program is similar to other retail corridors within Toronto in that the first floor is primarily retail while the upper floors are predominantly residential.

There is a diverse range of programs within the ethnic enclave that includes community organizations, art and theatre organizations and medical institutions. The diversity of these programs lends itself to the constant change of the demographics of the area over time.

Going back to how Qadeer described institutions within ethnic enclaves, he states that they encourage participation and foster social cohesion. As such, they are key players within ethnic settlements. Within this thesis, nine institutions and business have been chosen as these key players, and have been termed as "key entities" (Figure 3.03). These entities play an important role within the ethnic enclave and have the potential to be incorporated within the design proposal (to be explained in more detail in further sub-chapters). Within Figure 3.08, relationships and networks between these key entities and the rest of the retail strip are illustrated. It is evident from this diagram that these "key entities" operate in a very isolated manner and there are multiple opportunities to bridge them together - this is what the design proposal will aim to do, as the first step in initiating cultural exchange.

Within the diagram in Figure 3.03, vacant sites, designated plots and private/ fenced up plots are also depicted. Vacant sites also include buildings that are severely underutilized or closing down. Designated plots are specific regions that have a designated purpose such as authorized parking or designated seating areas. Private/ fenced up plots mainly consist of areas that are fenced-off from the public and therefore denote a private property. These can include private laneways, parking or areas that are under construction.

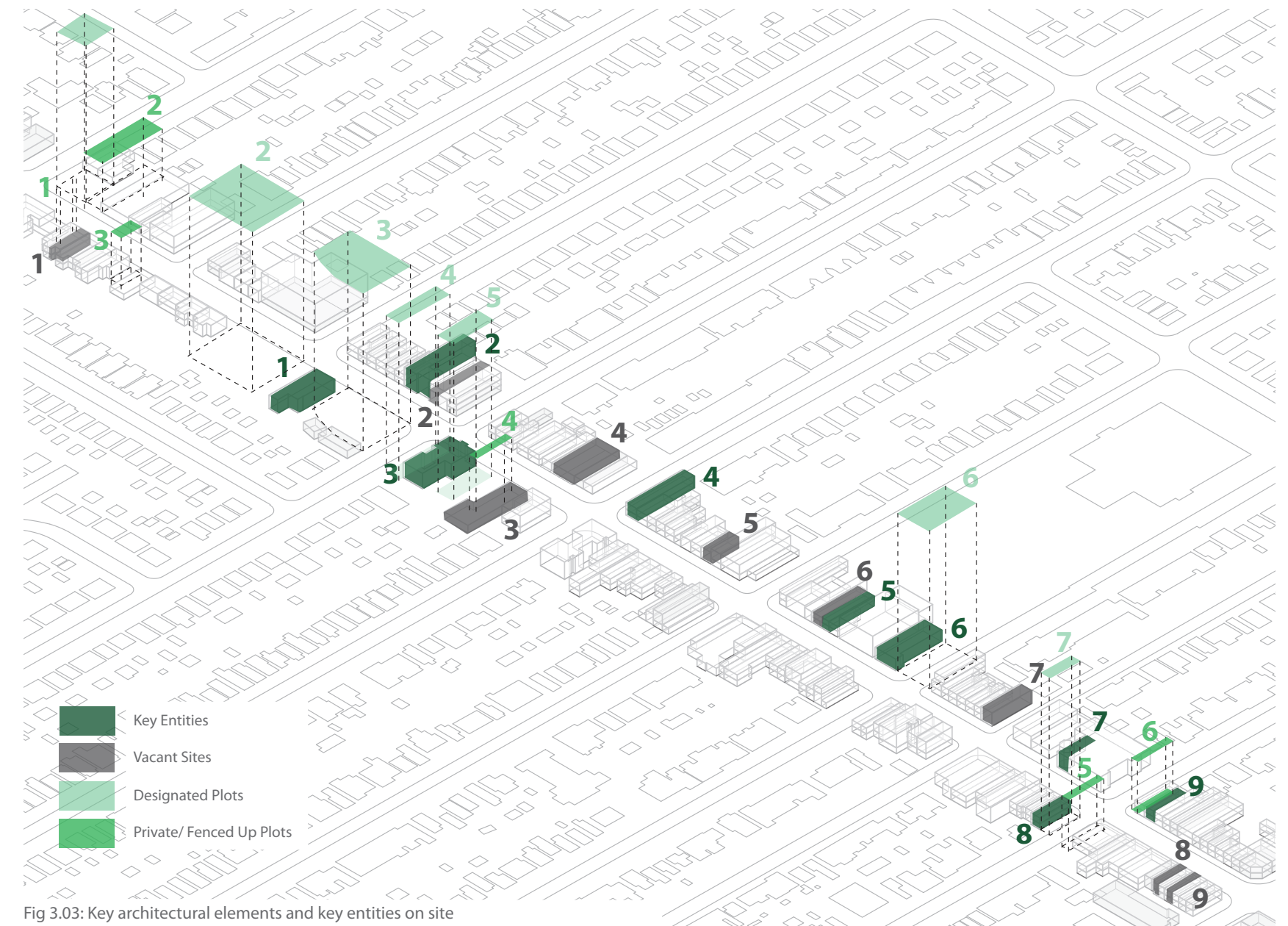


Fig 3.03: Key architectural elements and key entities on site

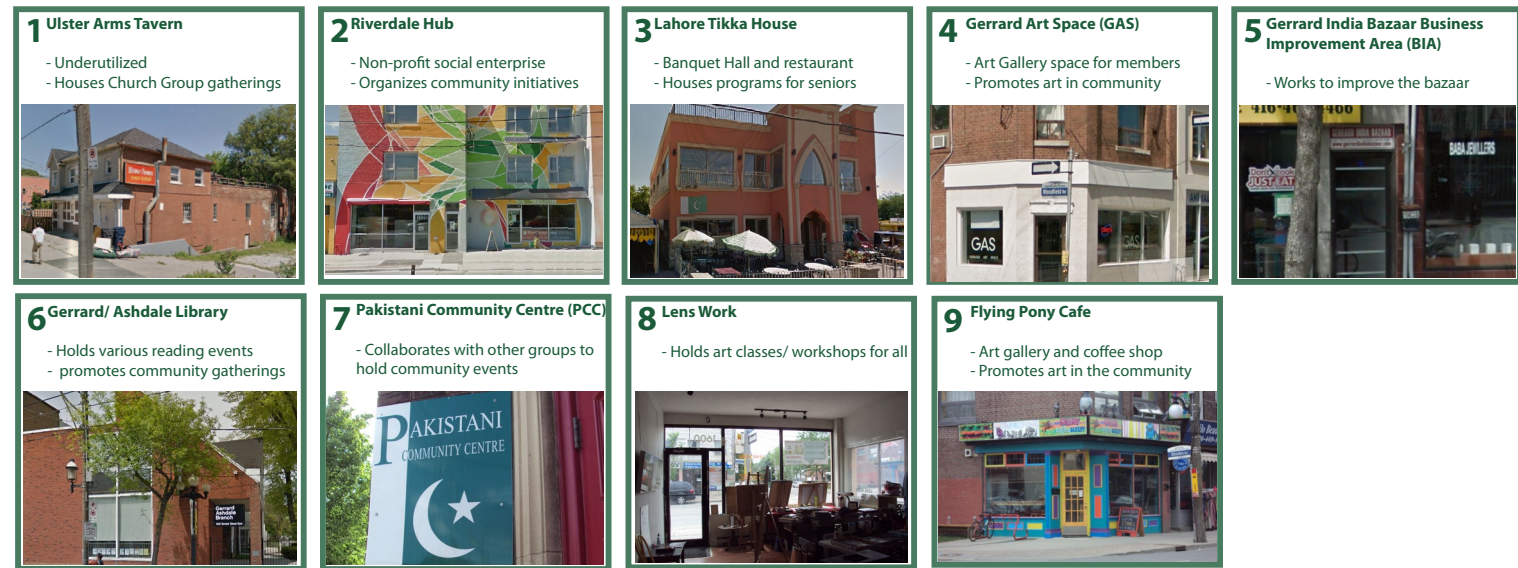


Fig 3.04: Key entities

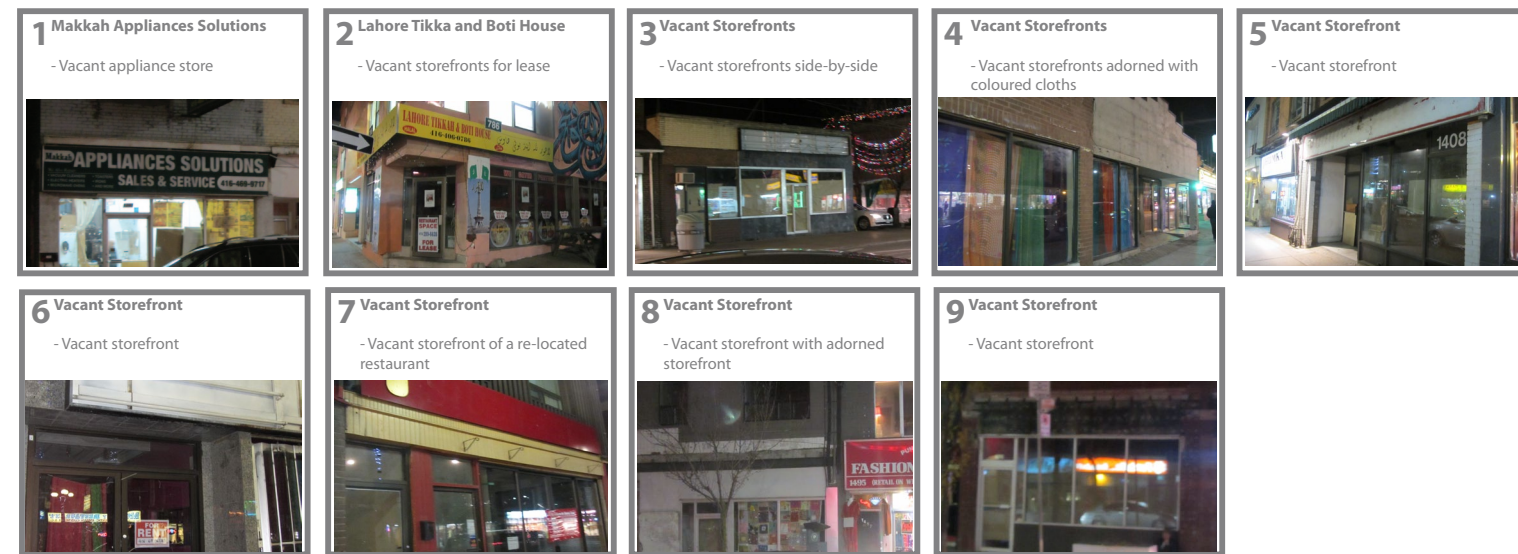


Fig 3.05: Vacant sites

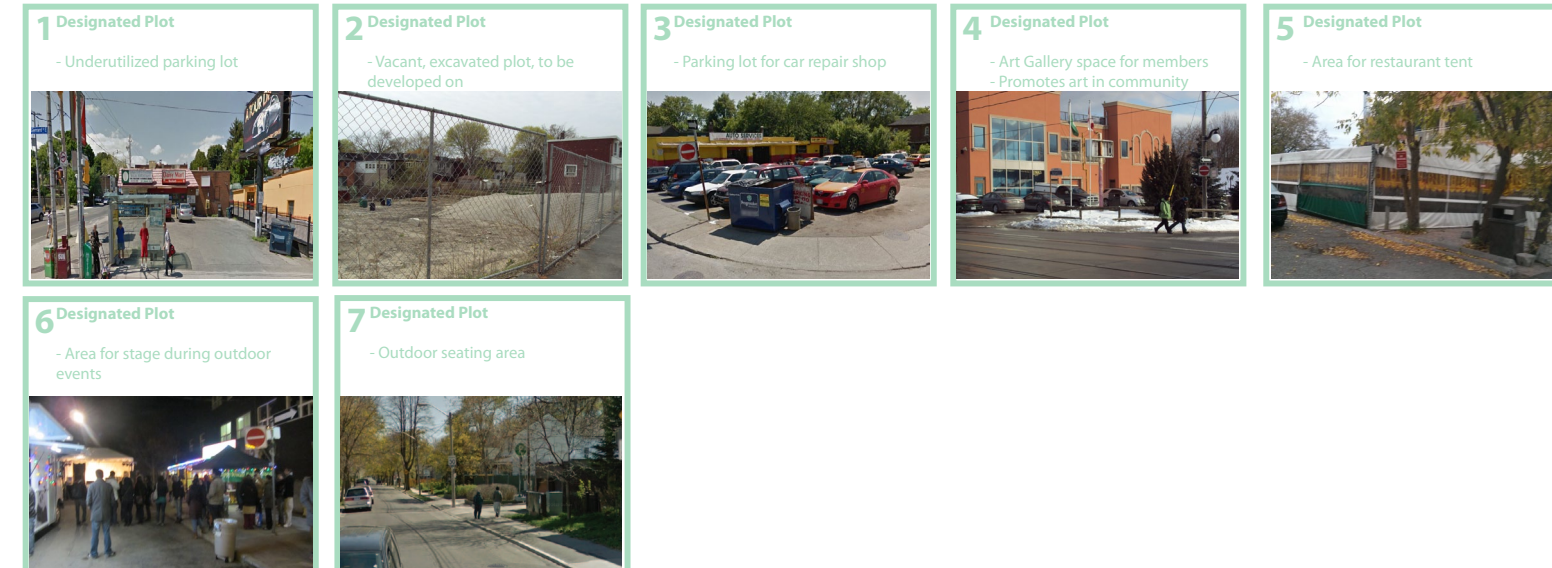


Fig 3.06: Designated plots

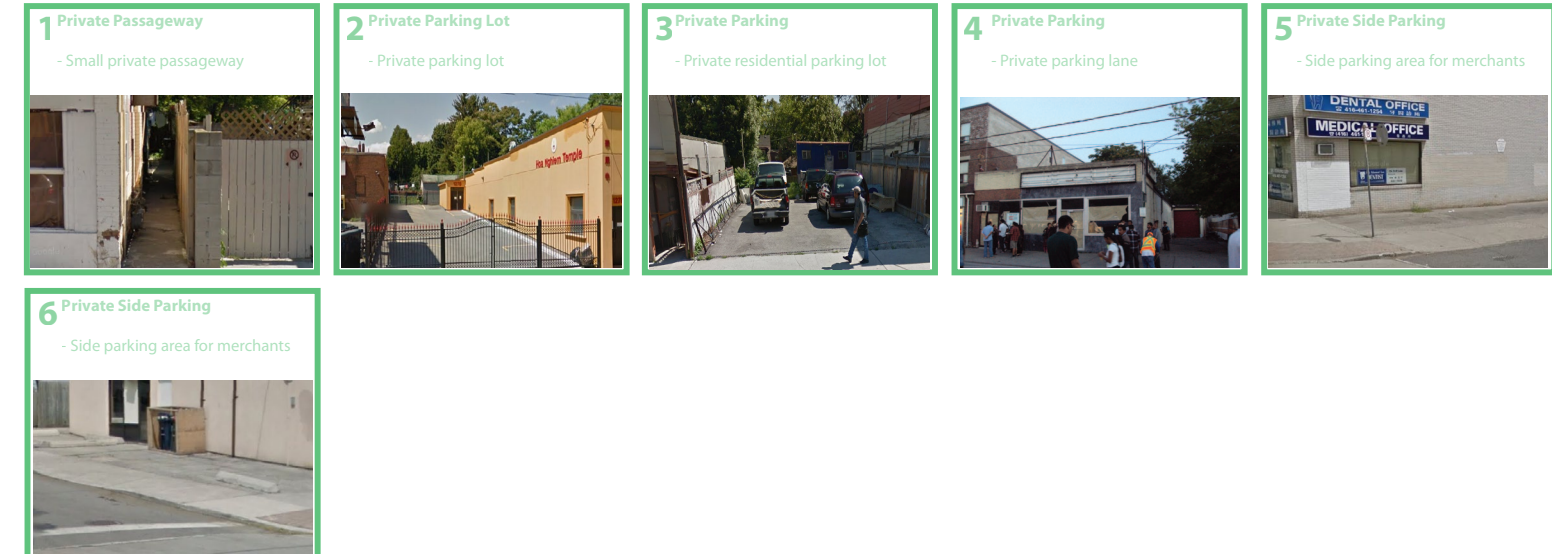


Fig 3.07: Private/ fenced up plots

Networks and programs of key entities within the Gerrard Bazaar

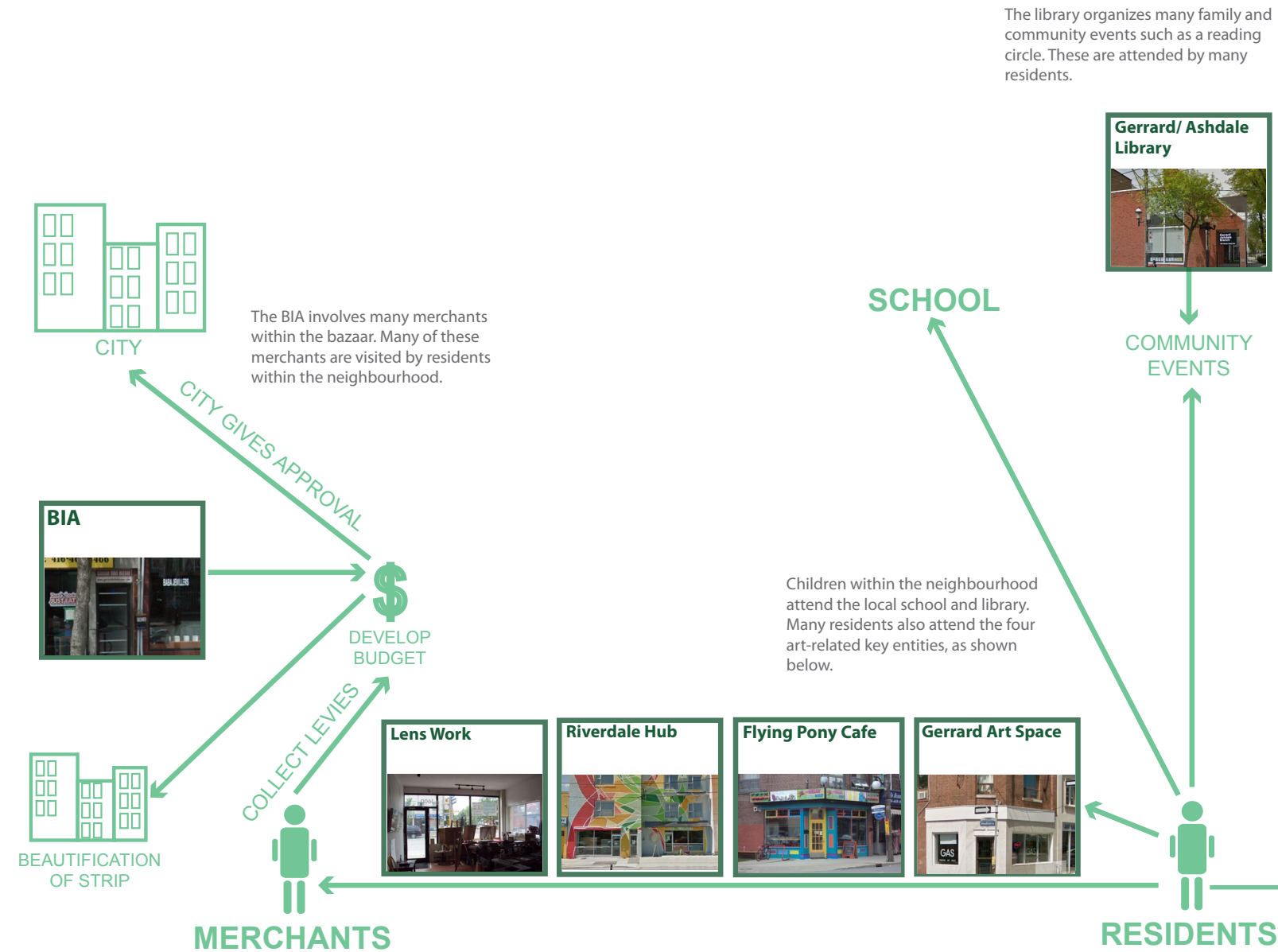


Fig 3.08: Networks between Key entities

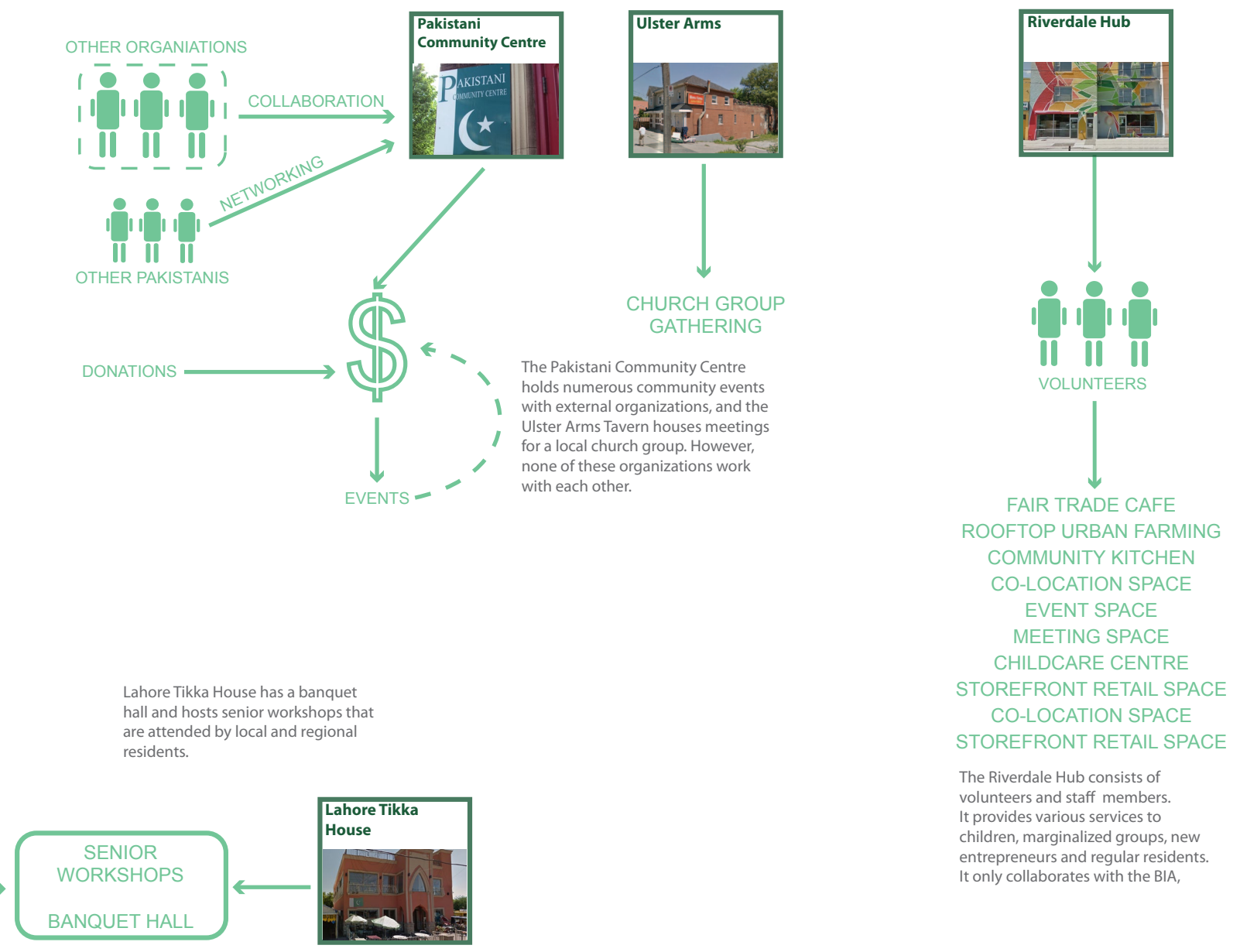




Fig 3.09: People lighting fireworks during Diwali

3.2 Spatial Transformation and Composition

Apart from the permanent retail enterprises that line the street, there are various festivals and events that are held within different parts of the enclave throughout the year, which illustrate that the programs within the Gerrard Bazaar not only vary in diversity but also in temporality.

As mentioned earlier, the BIA emphasizes the importance of these events in rejuvenating the identity of the strip and stimulating its economic functions. The aim of these events is to operate on an inter-cultural and secular agenda in order to speak to all of the cultural groups residing within the neighbourhood³.

For Diwali celebrations, a stage is set up and various promotion booths and displays are arranged at the intersection of Gerrard Street East and Ashdale Avenue. The crowd is usually concentrated within this area and various groups of people are spotted close by. Vaisakhi celebrations take place at the intersection of Gerrard Street East and Hiawatha Road. The same stage is installed for this event and promotion booths and displays are present. Eid celebrations along the Gerrard Bazaar do not have any formal set-up but render some of the largest crowds. Various stores assemble their food preparation equipment along the street to serve fresh food and snacks while some stores set up tables and chairs for long lines of women waiting to get henna applied to their hands. The sidewalks are usually crowded as well as many restaurants and several clothing stores. Finally, the Festival of South Asia - the largest event, consists of consistent rows of street vendors and a stage for dance performances. This event renders crowds from all over the Greater Toronto Area for a two-day period.

Each of these celebrations activate the street in a different manner due to their varying locations, street furnishings and equipment. In this sense, they have become a key part of the cultural essence and identity of the ethnic enclave.



Fig 3.10: The Festival of South Asia

The largest crowd is present during the Festival of South Asia which is the most major event organized by the BIA during the summer season. During this two-day event, a crowd of almost 250,000 spills the streets of the Gerrard Bazaar to experience delectable tastes and entertainment from the Indian subcontinent. Fashion catwalks, dance performances and cultural shows are diligently planned for this event, and run throughout both days¹. As such, this festival serves as a profitable image-building and economy-spurring tool for the ethnic enclave.

Spatial Configurations and Transformations during Eid

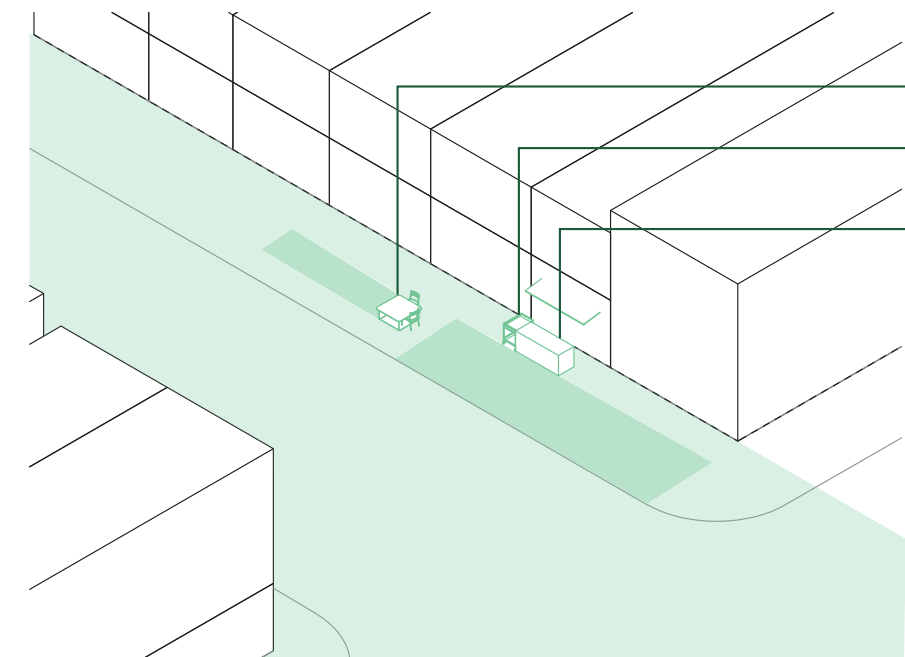
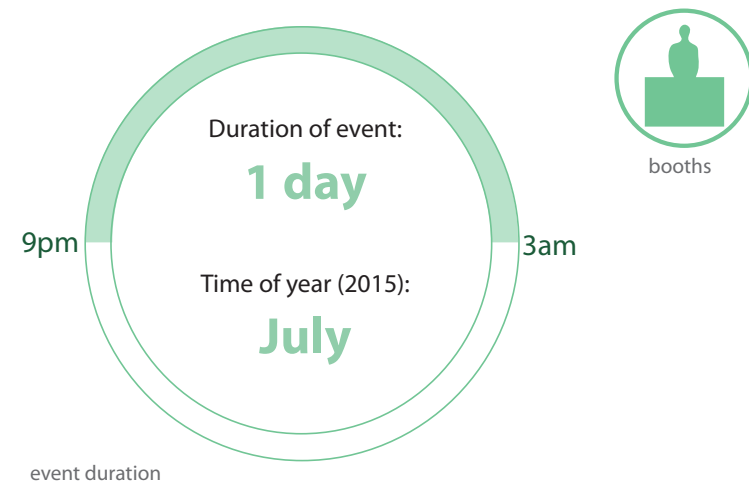
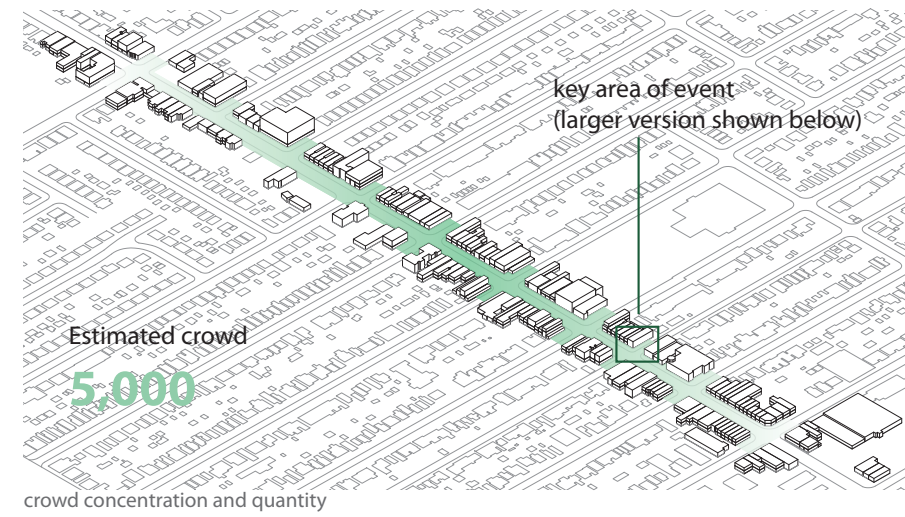
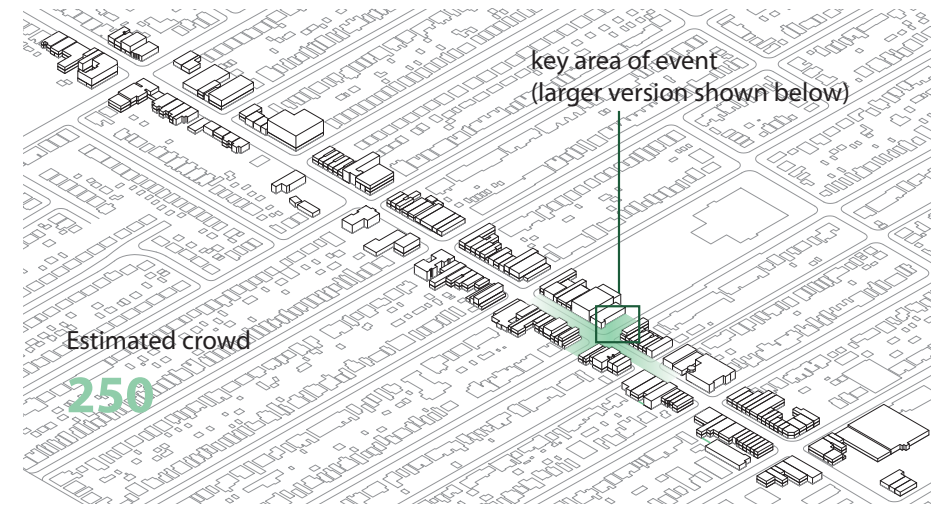


Fig 3.11: Eid diagrams and infographs



Fig 3.12: Eid celebrations within the Gerrard Bazaar

Spatial Configurations and Transformations during Diwali



crowd concentration and quantity

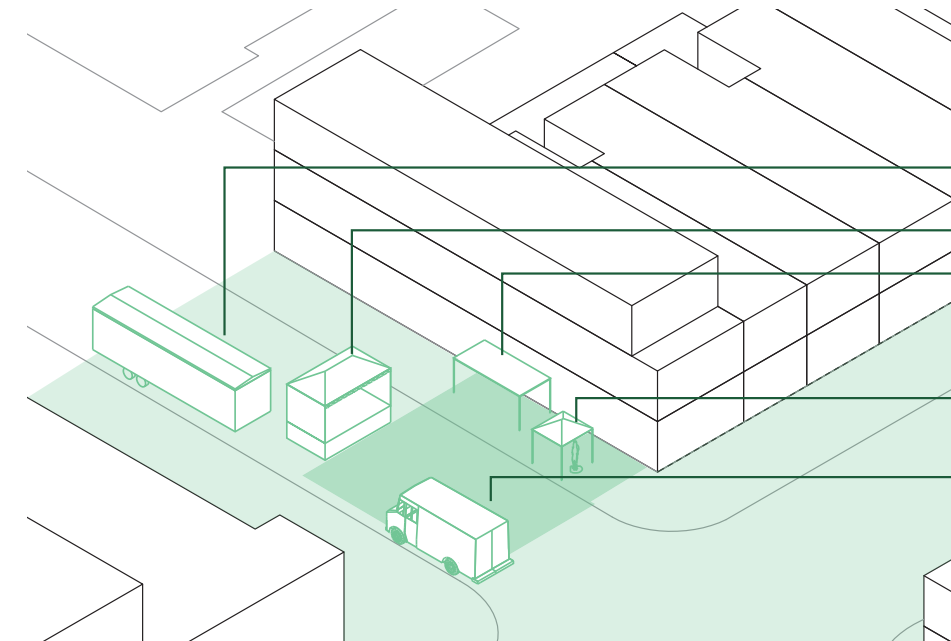


Fig 3.13: Diwali diagrams and infographs



event duration



booths



dances



key entities

storage trailer

performance stage

display / promotion booth

display / promotion booth

display / promotion vehicle

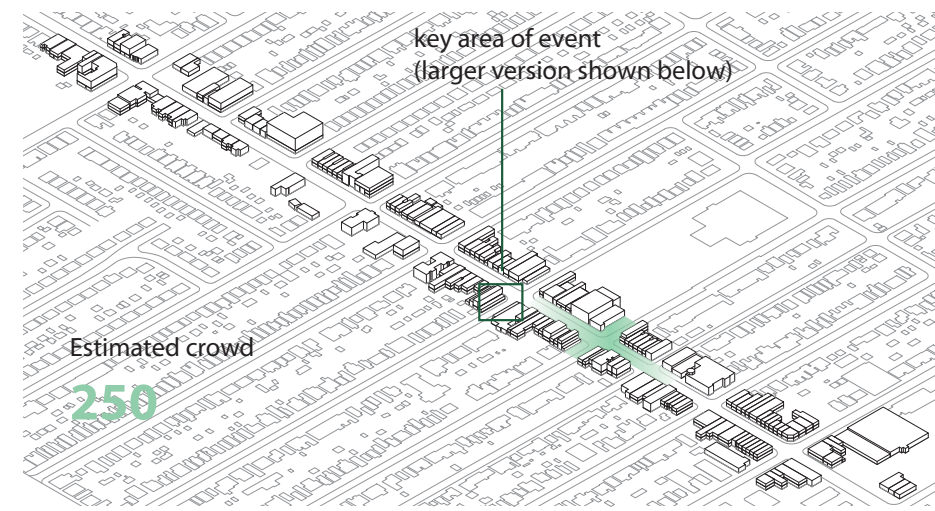
low density crowd

high density crowd



Fig 3.14: Diwali celebrations within the Gerrard Bazaar

Spatial Configurations and Transformations during Vaisakhi



crowd concentration and quantity

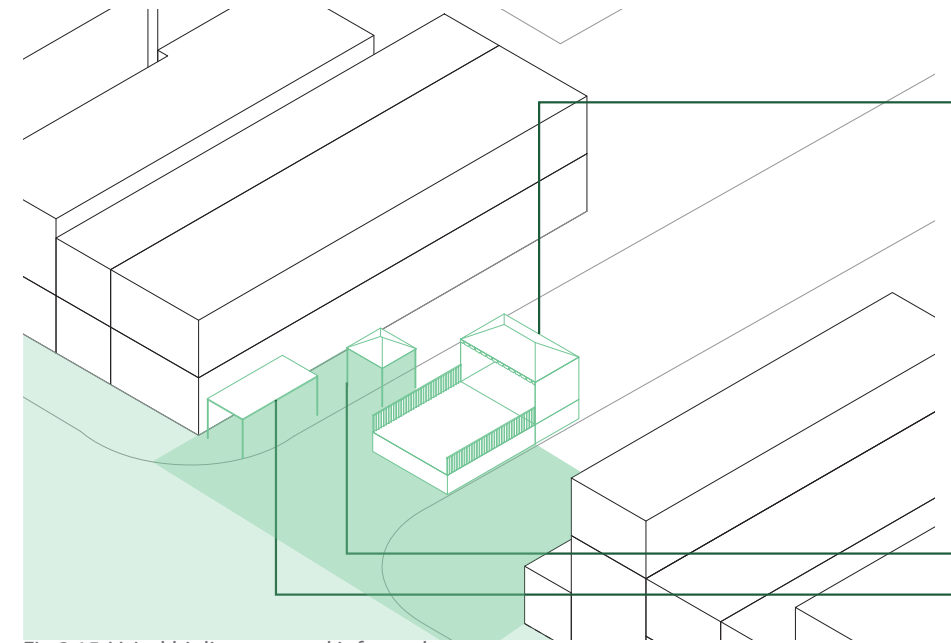


Fig 3.15: Vaisakhi diagrams and infographs



event duration

performance stage



display / promotion booth

display / promotion booth

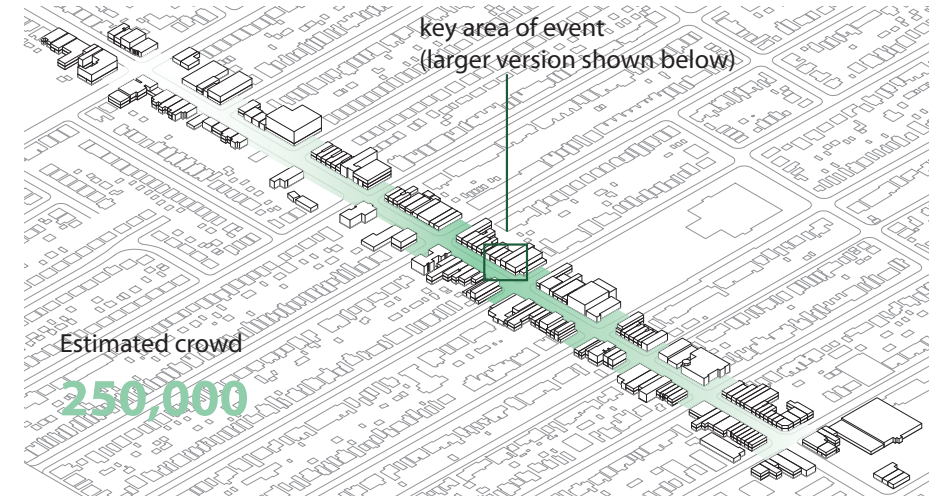
low density crowd

high density crowd

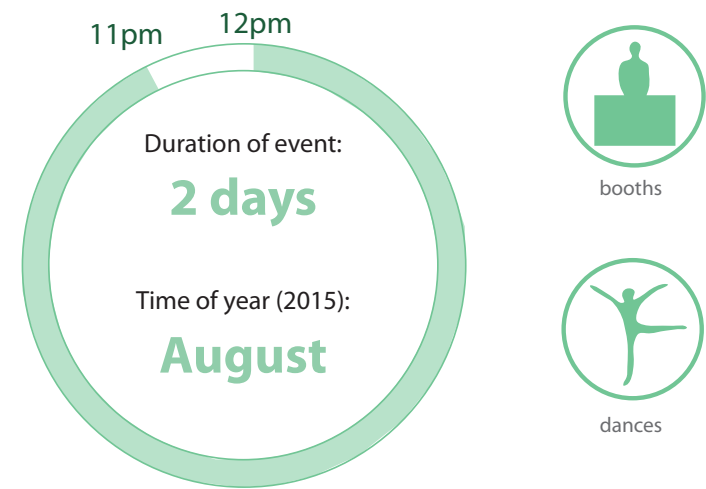


Fig 3.16: Vaisakhi celebrations within the Gerrard Bazaar

Spatial Configurations and Transformations during the Festival of South Asia



crowd concentration and quantity



event duration

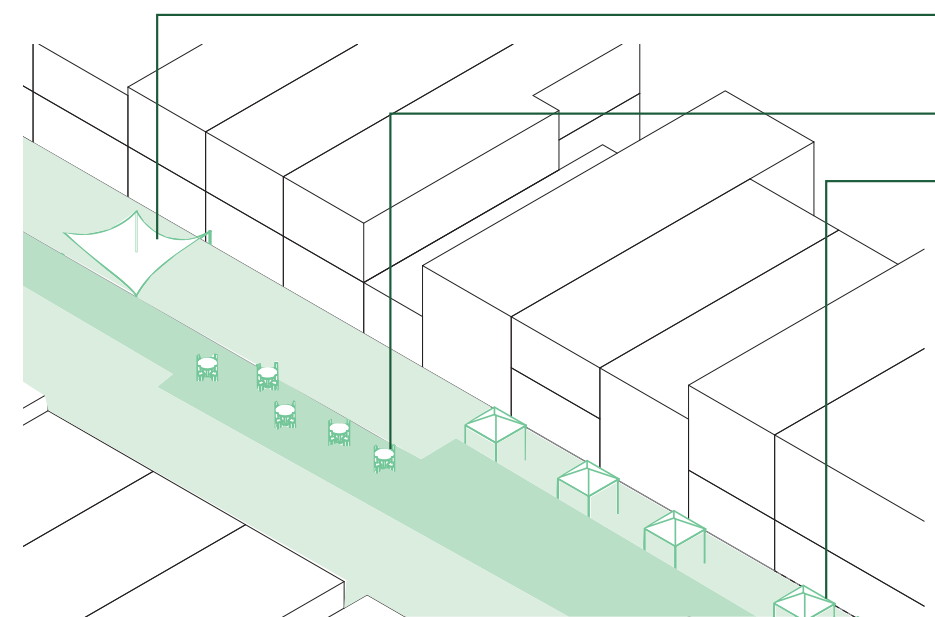


Fig 3.17: Festival of South Asia diagrams and infographs



key entities

low density crowd

high density crowd



Fig 3.18: Festival of South Asia celebrations within the Gerrard Bazaar





Fig 3.19: Inside of a souvenir shop

3.3 Architectural and Spatial Analysis in Relation to Design

The architecture within the Gerrard Bazaar has elements of old urban Toronto and South Asian markets.

A selection of 13 different stores, some of which are key entities, were analyzed in terms of their architectural composition, key characteristics that make them unique, and spaces of gathering in relation to other spaces. These 13 stores were chosen based on: willingness and availability of merchant, location along retail strip and diversity in program.

This study ultimately reveals that some enterprises within the ethnic enclave are architecturally and functionally no more than a store. As such, they embody the characteristic of **Typicality**. In contrast, many stores are able to promote their own business and/or respond to the changes taking place within the neighbourhood in a unique manner.

Some retail enterprises operate in a multi-functional manner adopting **Multiplicity** in their program. They are not only a business but also a place for other functions that engage the community or promote public gathering. As such, they have a dual nature that works to their advantage and has led to their growth within the ethnic enclave, despite its economic decline. Other enterprises rely on community gatherings and **Community Engagement** in order to grow and thrive within the ethnic enclave. In reaching out to the public, they have fostered a sense of community, tolerance and inter-connectivity within the neighbourhood. This, in turn, has led to positive social development within the Gerrard Bazaar.

Moreover, some enterprises focus on their programs and have either diversified their program or housed a unique one, to counteract the saturated market of the Gerrard Bazaar. As such, they have a **Programmatic Emphasis**. Therefore, they have the potential to thrive



Fig 3.20: Clothes displayed outside of a fabric store

within the market and continuously attract consumers. On the other hand, some enterprises have an **Architectural Emphasis**. They are housed within iconic or large built forms that allow them to make a mark within the ethnic enclave and distinguish themselves from other businesses selling the same goods/services.

Lastly, a large number of enterprises utilize the exterior realm in order to demonstrate the flexibility of their operations or to market their goods/services. As such, they use an **Expansion** of their store functions able to attract and engage passersby. This technique of marketing is also prevalent in South Asia, as moderate weather conditions permit such displays year-round.

In terms of space usage, stores either have gathering, functional or flexible space. Gathering space is where events take place that promote gathering. Functional space is where the regular operations of the store occur. Flexible space is space that can vary in use or function. These will be identified for each store.

The 13 stores have been analyzed according to specific categories. The legend for these categories is shown below:

SA	South Asian		Multiplicity
NSA	Non-South Asian		Expansion
O	Community Organization		Community Engagement
R	Restaurant		Typicality
C	Clothier		Architectural Emphasis
GS	Specialized Goods/ Services		Programmatic Emphasis

**All drawings are 3D diagrammatic representations of the stores and are not meant to serve as accurately dimensioned architectural models.*

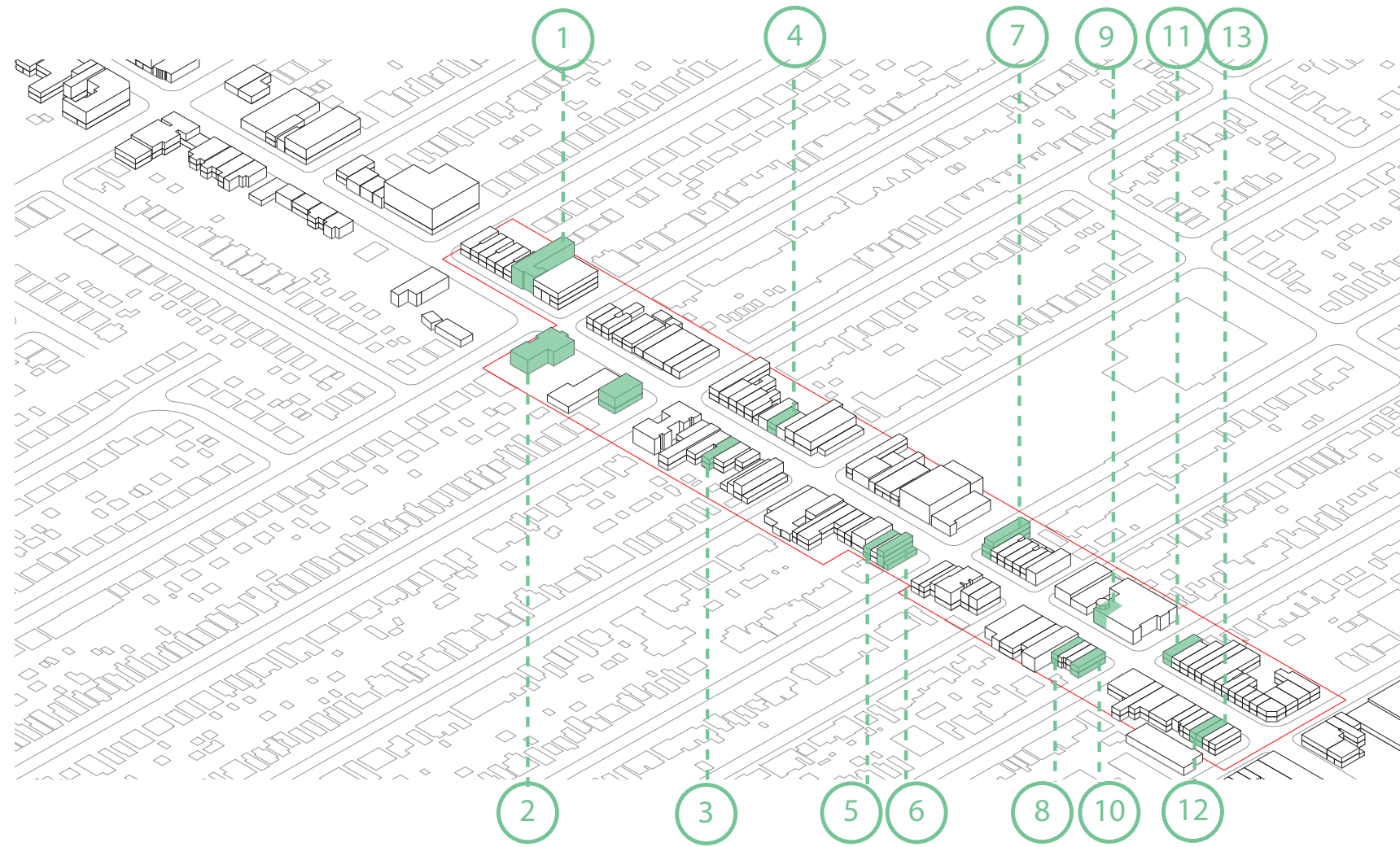


Fig 3.21: Analyzed stores - key axonometric diagram

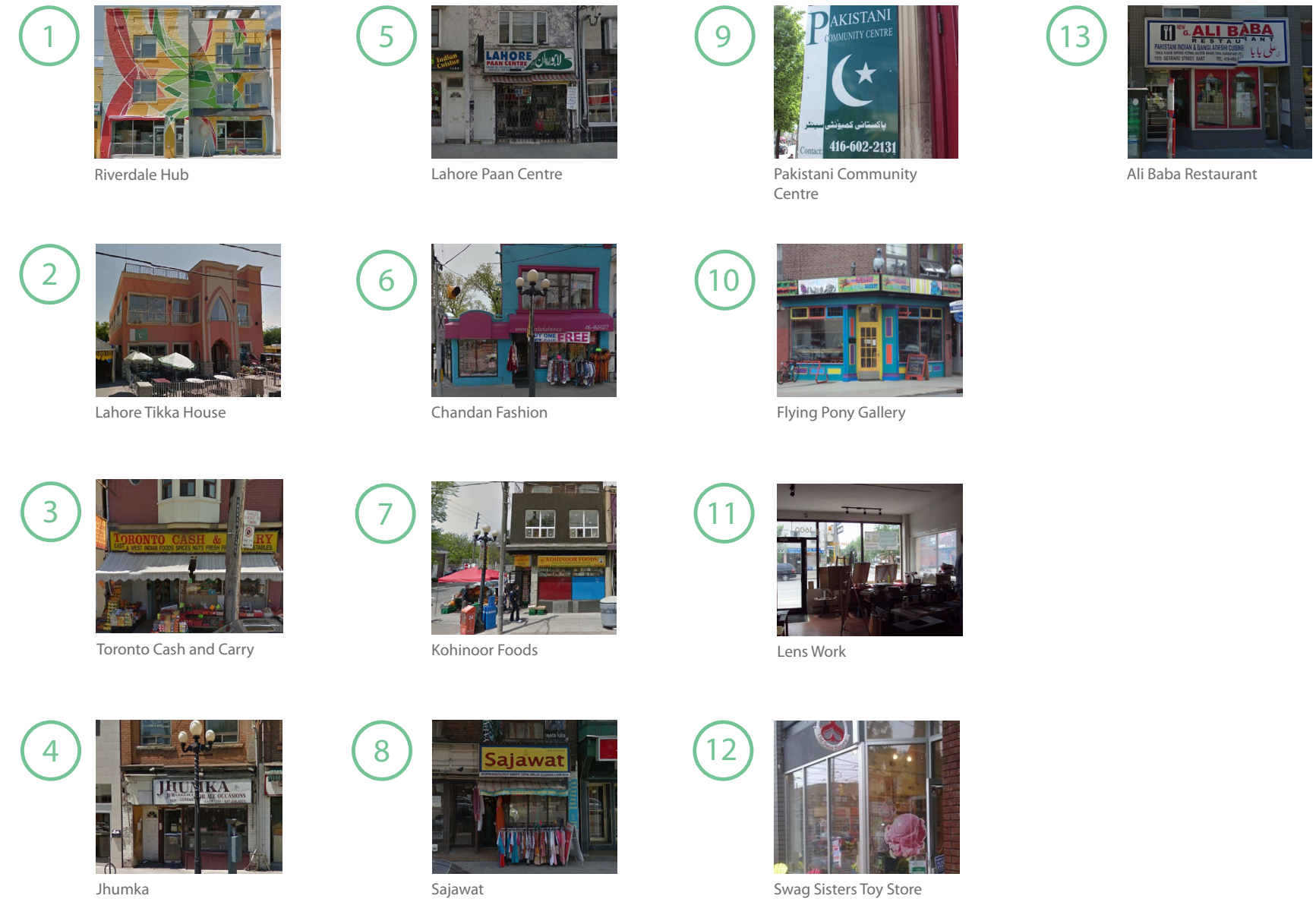


Fig 3.22: Analyzed stores - key image diagram

1) The Riverdale Hub

The Riverdale Hub is a non-profit social service that helps marginalized and low-income individuals settle within society. Housed within a historic 100-year old building within the Gerrard Bazaar, the hub aims to develop and provide sustainable programs to promote community activity, integration and participation. Current amenities include: a fair trade cafe, a community kitchen, rooftop farming space, and a Global Pantry kitchen. In addition, the hub provides various classes, workspaces for tenants to start their ventures, event space, and a storefront retail space for new entrepreneurs.²

In terms of architecture, the Riverdale Hub is a three-storey sustainably-designed building that is comprised of two joined forms - one long and the other short. The shorter form on the main level serves as an entrance reception area which leads out to a rainwater garden on the other side. The longer form houses the cafe and co-location space, as well as the washrooms and coat hanging area. On the upper floors, the shorter volume houses additional co-location and studio space, while the longer volume houses co-location and event space. Moreover, the rooftop will house a future rooftop garden.

As such, the Riverdale Hub houses multiple functions and embraces the concept of multiplicity. It is these characteristics that give it potential to survive within the ever-transforming neighbourhood.



Fig 3.23: Meeting room



Fig 3.25: Rainwater garden



Fig 3.24: Fair trade cafe

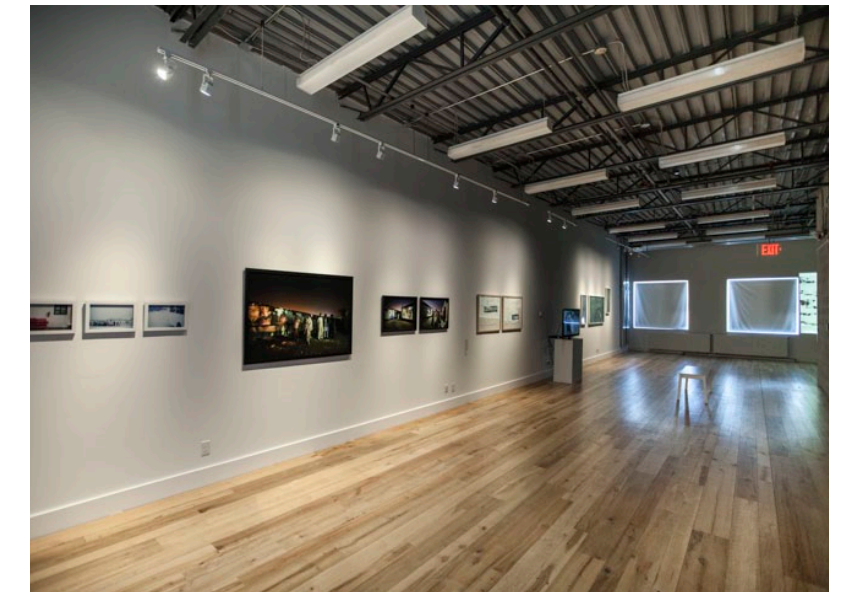


Fig 3.26: Event space

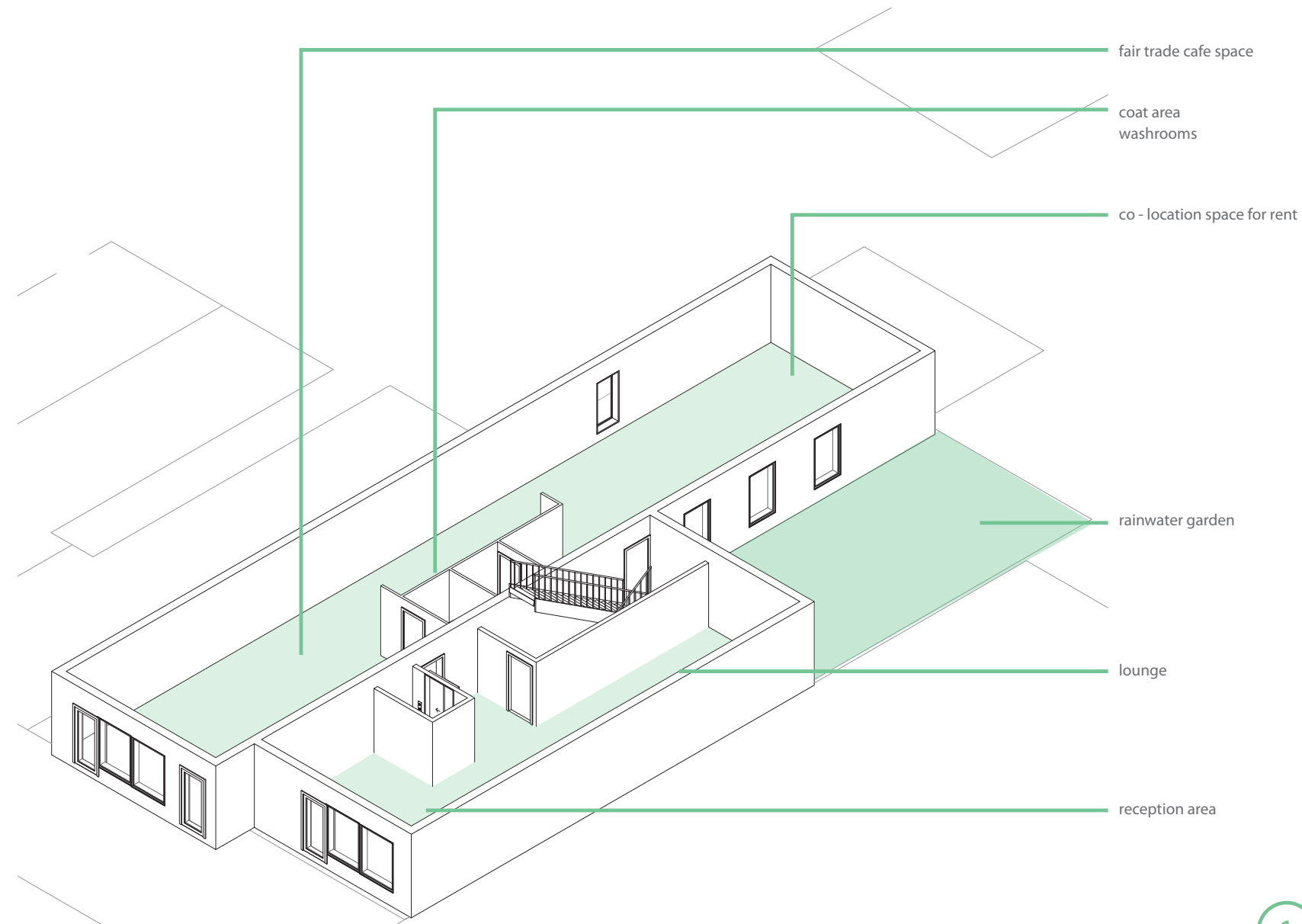


Fig 3.27: Diagram of Riverdale Hub (main level)

Ethnic Association: SA NSA

Organization Type: O R C GS

Key Characteristics: [Icons: office, bus, people, laptop, building, globe]

Key Entity: YES NO part of the BIA

Program Diversity:

Major Clients/ Visitors

[Icon: family] families/ individuals nearby

[Icon: car] families/ individuals from suburbs

[Icon: person] South Asians

[Icon: person] non-South Asians

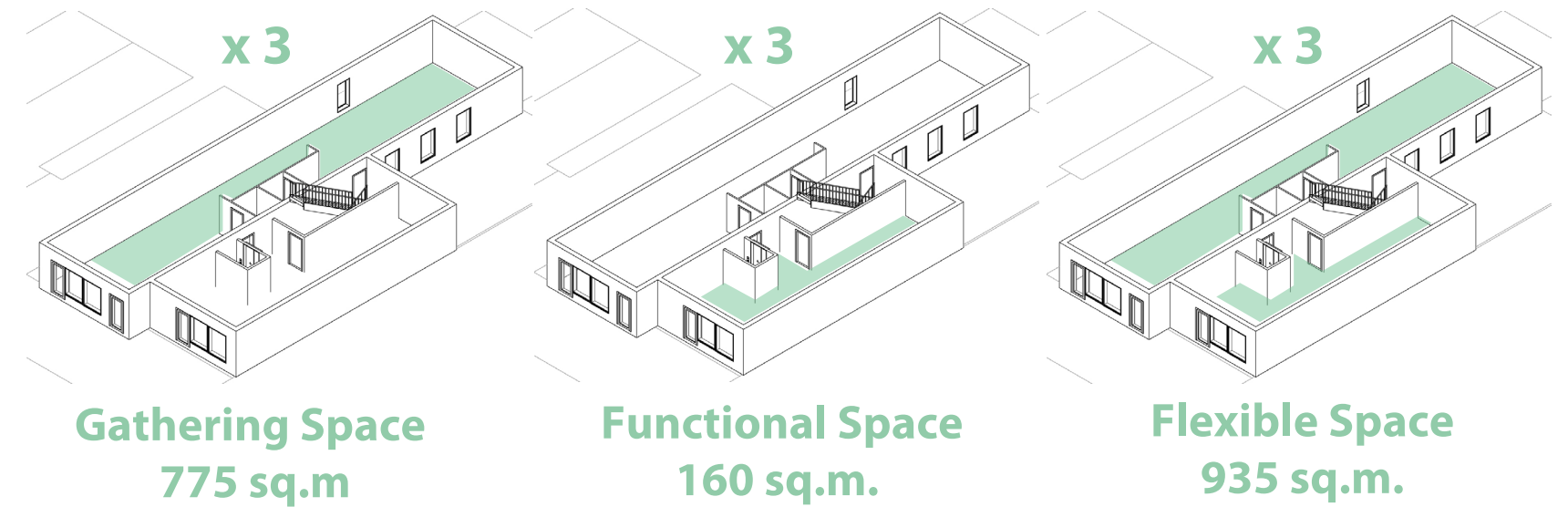


Fig 3.28: Riverdale Hub - analytical diagrams

2) Lahore Tikka house

Founded by Alnoor Siyani in 1996, Lahore Tikka House began as a modestly-sized restaurant within the Gerrard Bazaar. Over the years, the business grew and expanded into the local KFC establishment. Given this positive response, Siyani had stated that the restaurant's success is due to the tolerance and multiculturalism of the city itself.³

Today, it stands as one of the most iconic and busiest restaurants within the ethnic enclave. Various cultural elements such as: clay ovens, takhats (Pakistani stools), tents and grills, all reflect the cultural atmosphere and locus of the typical Pakistani city.

The upper level of Lahore Tikka House serves as a banquet hall for a variety of occasions and events such as weddings, birthdays, business conferences and a Family Day buffet. Clients for this banquet space are mostly from Mississauga, Hamilton and Brampton.

Moreover, its flexible tent structure serves as an outdoor dining space. In addition, it houses a senior's program during the summer months, for the Ismaili community. As such, it serves the local ethnic community.

With its ability to gather large crowds for multiple purposes, the Lahore Tikka House is often referred to as a "hub" for the South Asian community within the Gerrard Bazaar. It is this multi-functional nature that allows this entity to thrive within the Gerrard Bazaar - its iconic architecture, diverse functions and ability to cater to a diverse group of people.



Fig 3.29: Tables along the rolling doors on west wall



Fig 3.31: Service counter and food display cases within the restaurant



Fig 3.30: Flexible open hall space upstairs



Fig 3.32: Tables along the rolling doors on west wall

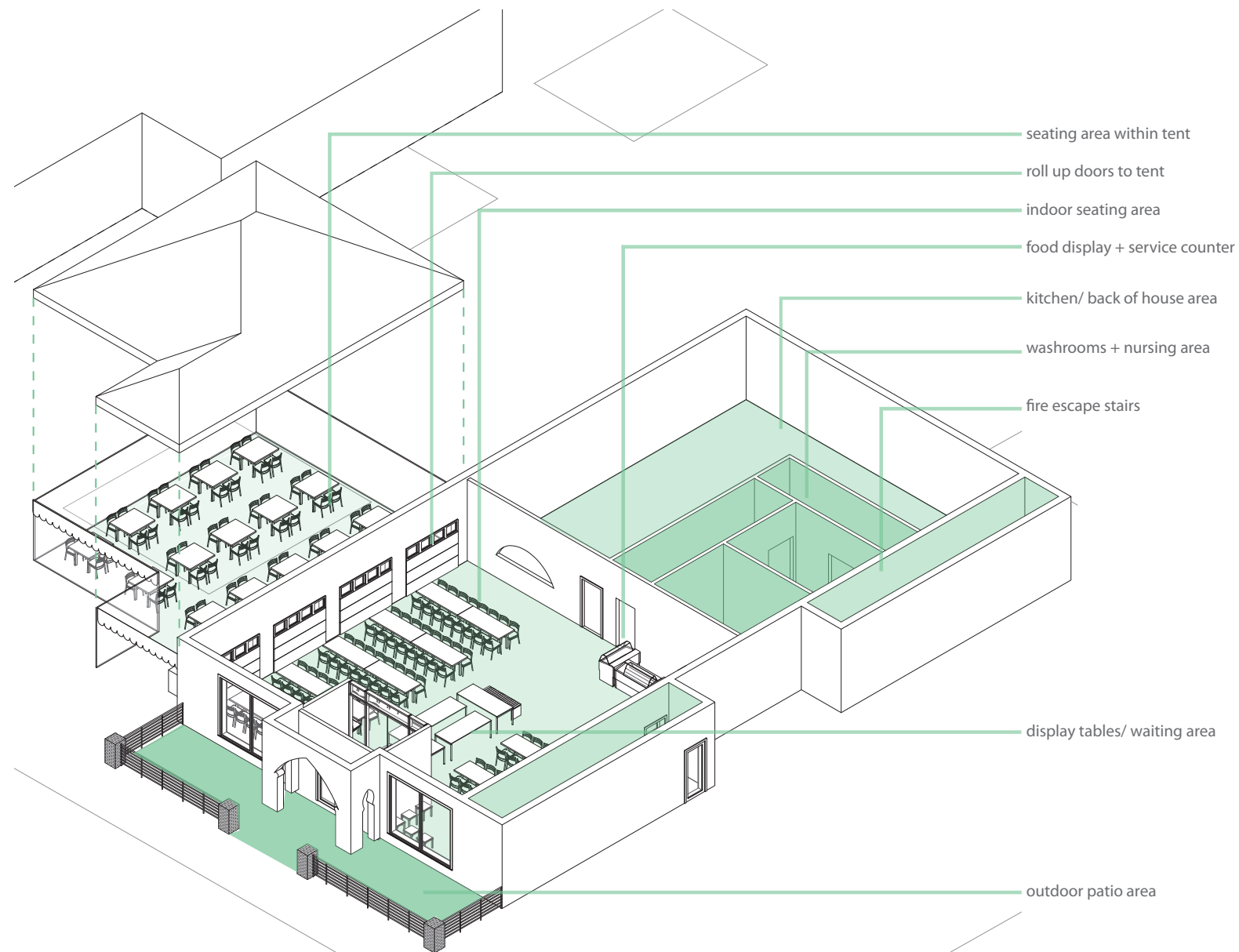


Fig 3.33: Diagram of Lahore Tikka House (main level)

Ethnic Association: **SA** **NSA**

Organization Type: **O** **R** **C** **GS**

Key Characteristics:

Key Entity: **YES** **NO** part of the **BIA**

Program Diversity:

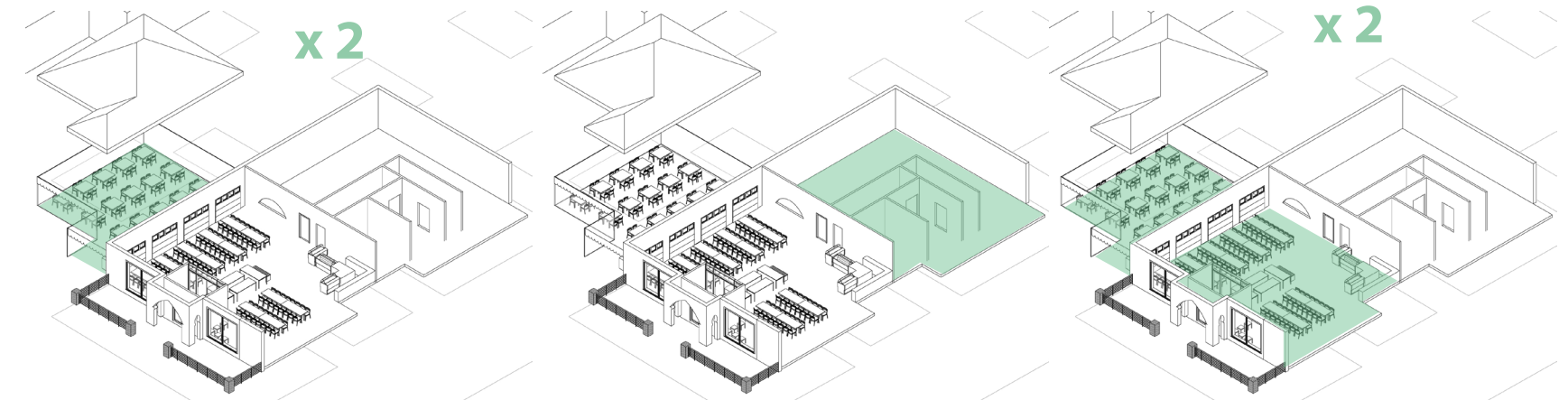
Major Clients/ Visitors

families/ individuals nearby

families/ individuals from suburbs

South Asians

non-South Asians



Gathering Space
175 sq.m

Functional Space
140 sq.m.

Flexible Space
380 sq.m.

Fig 3.34: Lahore Tikka House - analytical diagrams

3) Toronto Cash and Carry

Toronto Cash and Carry is a small supermarket selling South Asian food products. It is furnished with ample shelving and makes use of the exterior sidewalk to display fruits that are in season.

On the exterior, a long canopy spans the entire width of the store, serving as a welcoming gesture and a shading device for the items on display.



Fig 3.35: Retail aisle



Fig 3.37: Exterior food display



Fig 3.36: Retail aisle



Fig 3.38: Exterior food display

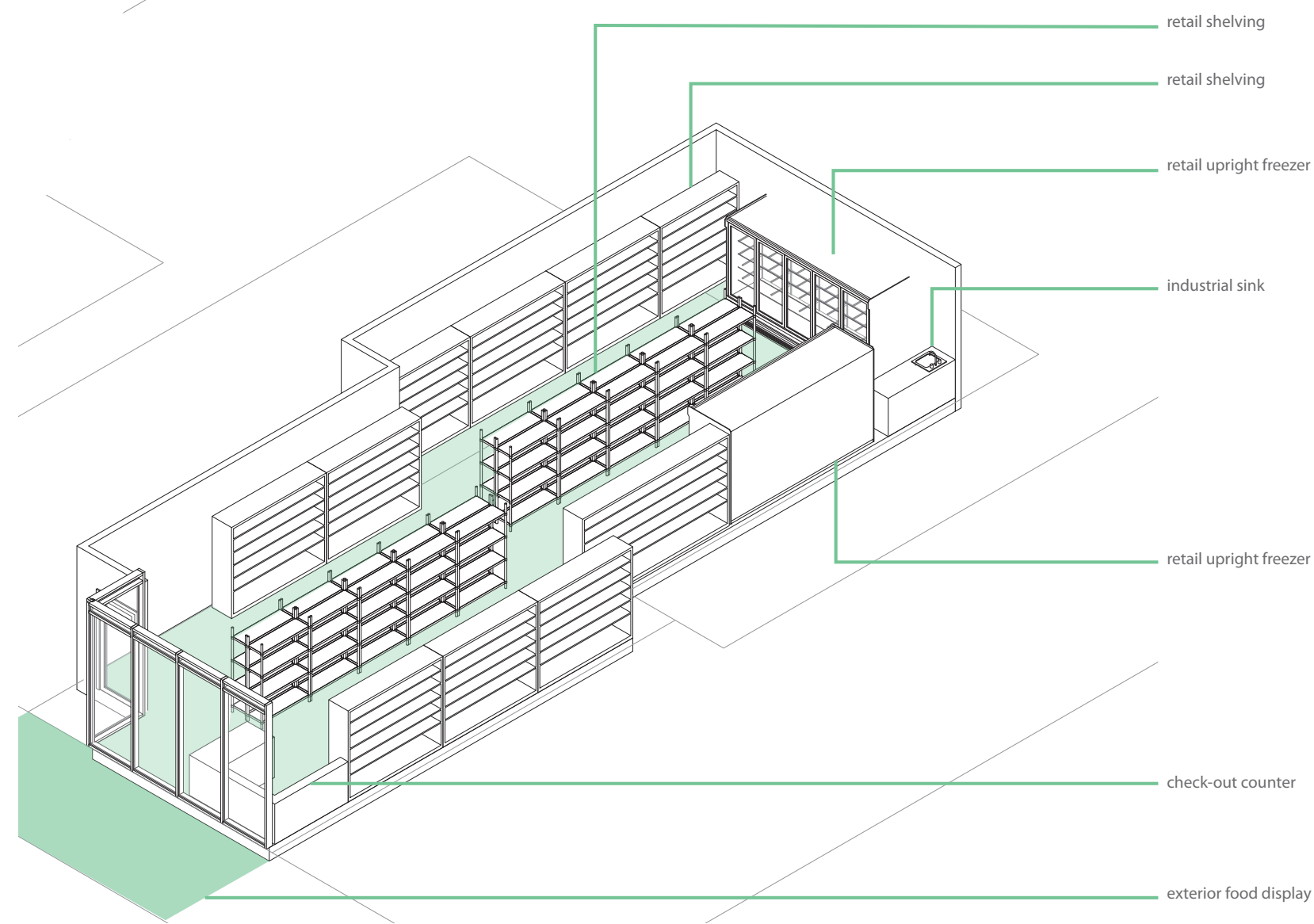


Fig 3.39: Diagram of Toronto Cash & Carry

Ethnic Association: SA NSA

Organization Type: O R C GS

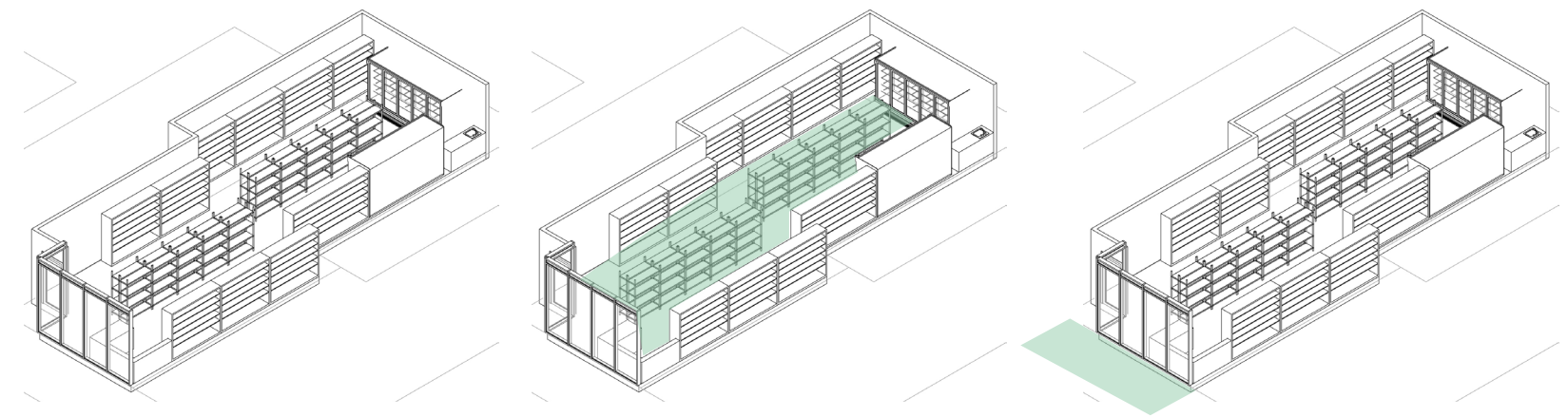
Key Characteristics: [Icons: grid, truck, people, square, calculator, square]

Key Entity: YES NO part of the BIA

Program Diversity:

Major Clients/ Visitors

- [Icon: family] families/ individuals nearby
- [Icon: car] families/ individuals from suburbs
- [Icon: person] South Asians
- [Icon: person] non-South Asians



Gathering Space
0 sq.m

Functional Space
120 sq.m.

Flexible Space
5 sq.m.

Fig 3.40: Toronto Cash & Carry - analytical diagrams

4) Jhumka

Jhumka is a small jewelry store on the West end of the Gerrard strip. The entrance is inset from the sidewalk and, upon entry, shelving and clear display cases are present all around the interior. At the back of the store is an extended area which is utilized as a storage space.

Jhumka stands as an example of a regular store within the Gerrard Bazaar that operates solely to sell a diverse range of jewelry.



Fig 3.41: Store interior display



Fig 3.42: Store interior display



Fig 3.43: Store interior display



Fig 3.44: View towards store entry

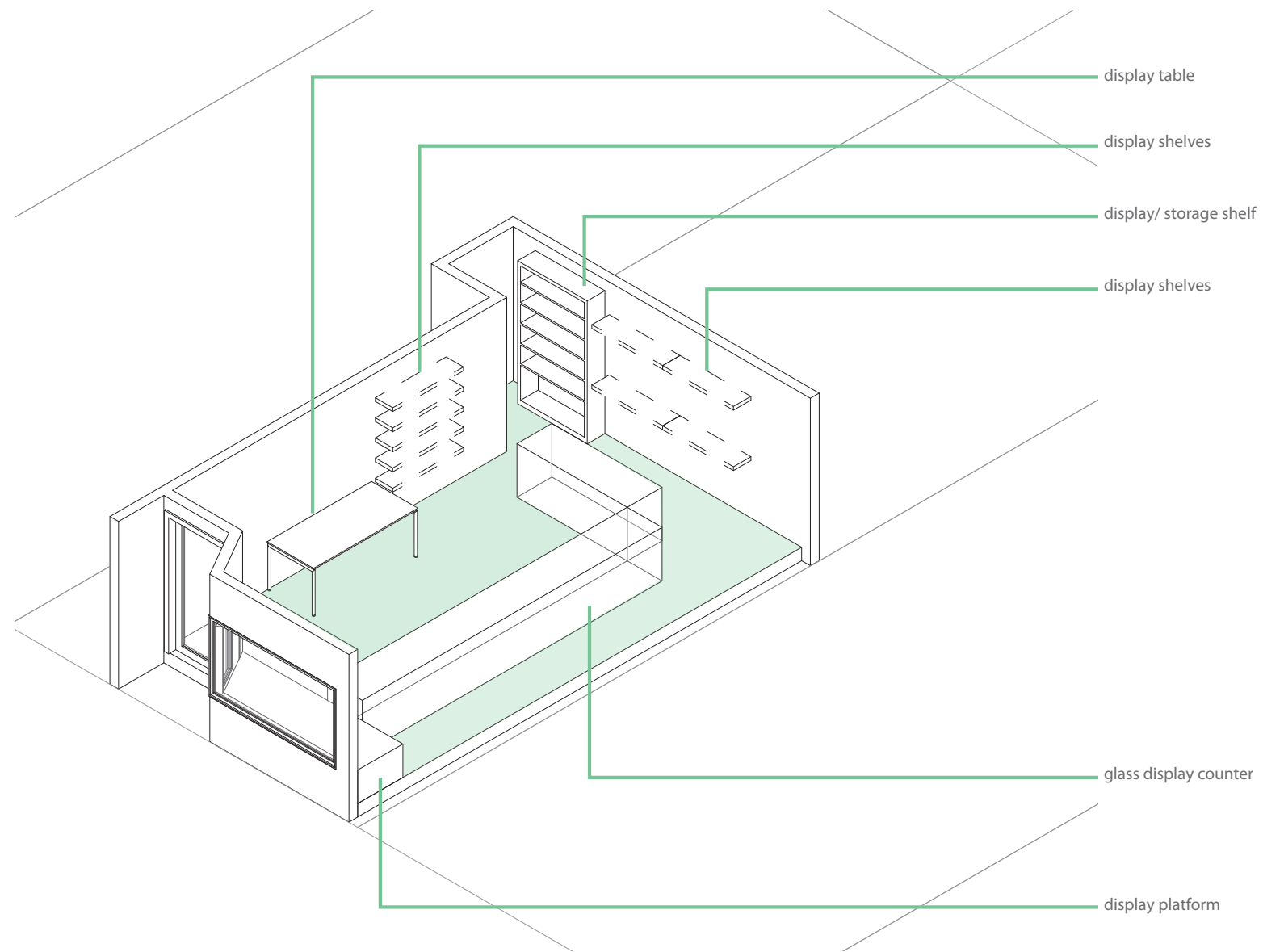


Fig 3.45: Diagram of Jhumka

Ethnic Association: SA NSA

Organization Type: O R C GS

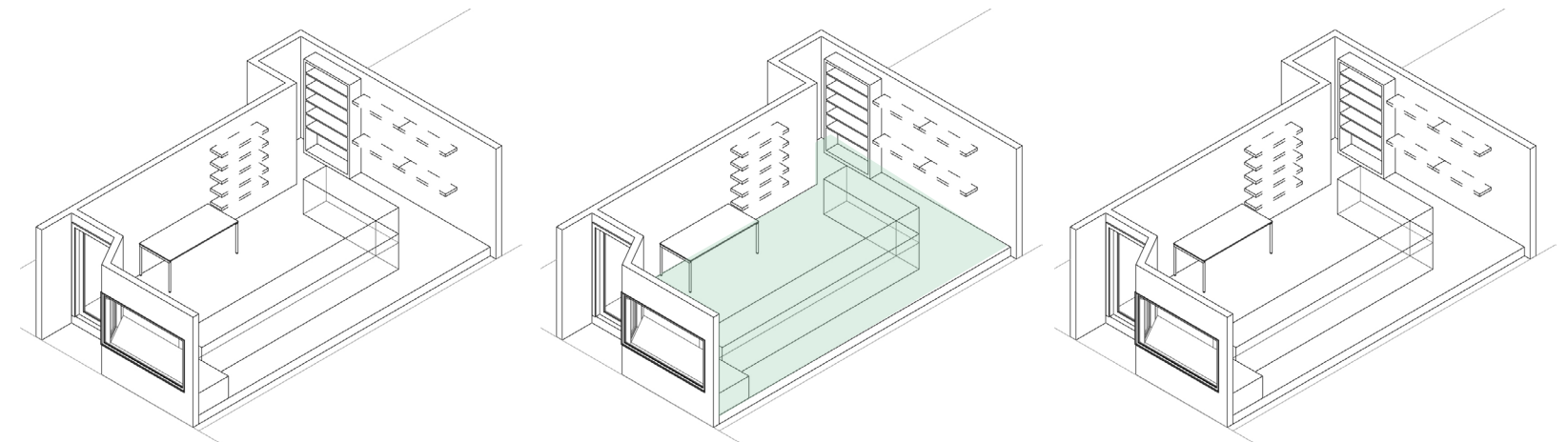
Key Characteristics: [Icons: grid, storefront, people, window, building, map]

Key Entity: YES NO part of the BIA

Program Diversity:

Major Clients/ Visitors

- families/ individuals nearby
- families/ individuals from suburbs
- South Asians
- non-South Asians



Gathering Space
0 sq.m

Functional Space
100 sq.m.

Flexible Space
5 sq.m.

Fig 3.46: Jhumka - analytical diagrams

5) Lahore Paan Centre

Once a smaller cafe within the same ethnic enclave, Lahore Paan Centre re-opened in a slightly bigger space and is an example of a modestly-sized cafe situated within the Gerrard Bazaar. The store has 3 main components - the outdoor serving area, the indoor seating/ serving area and the back-of-house/ storage room.

Looking more closely at the architecture of the small restaurant, the storefront is set-back a significant distance from the sidewalk so as to allow for various serving and food preparation equipment for the outdoor serving space. This equipment is partially situated on top of a raised floor which is accessed by a very small ramp.

This outdoor portion once again serves to expand the operations of the business and act as a means to market the goods and services to passersby. It facilitates a food vending environment which is very common in South Asia.

In comparison to other smaller cafes within the Gerrard Bazaar, this one runs fairly well possibly due to its micro-arrangement and architecture. As such, it is imperative for smaller businesses within the Gerrard Bazaar to utilize such methods in order to be competitive among more iconic and larger businesses such as Lahore Tikka House or Udupi Palace.



Fig 3.47: Exterior food service / preparation area



Fig 3.49: Seating area



Fig 3.48: Exterior food service / preparation area



Fig 3.50: Seating area

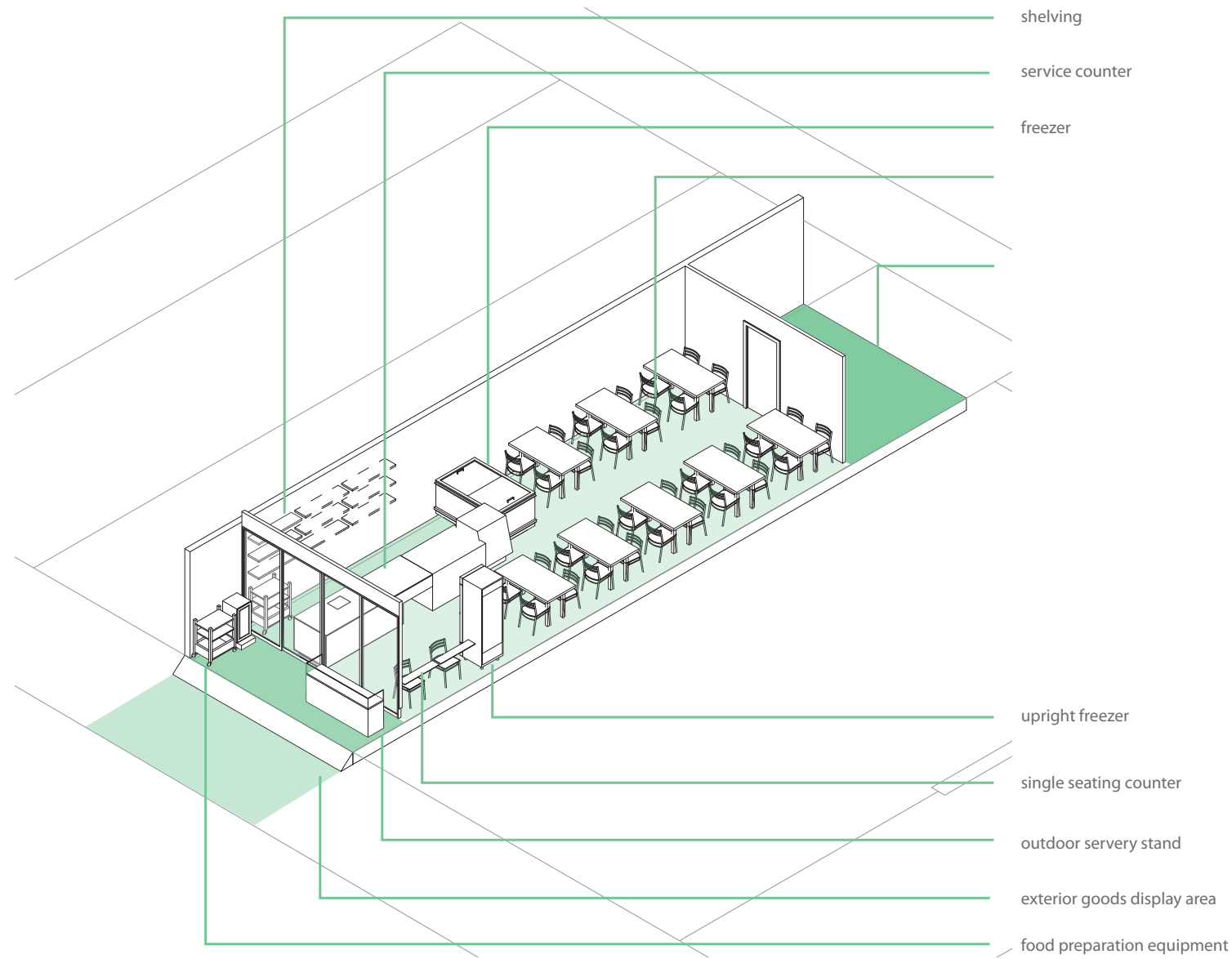


Fig 3.51: Diagram of Lahore Paan Centre

Ethnic Association: SA NSA

Organization Type: O R C GS

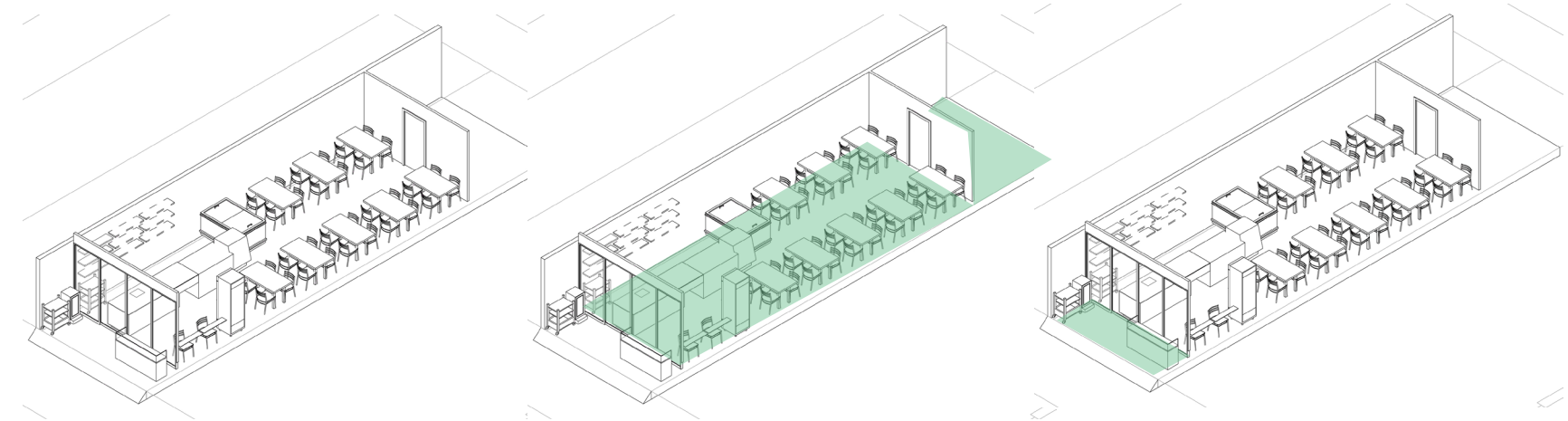
Key Characteristics: [Icons: grid, truck, people, window, building, square]

Key Entity: YES NO part of the BIA

Program Diversity:

Major Clients/ Visitors

- families/ individuals nearby
- families/ individuals from suburbs
- South Asians
- non-South Asians



Gathering Space
0 sq.m

Functional Space
100 sq.m.

Flexible Space
5 sq.m.

Fig 3.52: Lahore Paan Centre - analytical diagrams

6) Chandan Fashion

Chandan Fashion is an example of a growing clothing retail enterprise within the bazaar which has been continuously run by generations of the same family⁴. Starting off as a smaller store, two stores down the street, the clothier re-located to its current location in 1986 and rapidly expanded to include upper floors. The business is continuously growing and aims to revive itself functionally and architecturally to cater to its clients and maintain its image within the ethnic enclave.

The exterior sidewalk is utilized partially for clothing display, however, the interior of the store is intricately furnished with ample shelving, manikins and display cases. Each level houses a slightly different function - the main floor serves as a typical clothing store with displays and service areas, the second floor houses the administrative office as well as more bridal displays, the third floor aims to become a private bridal room for client appointments and trials, and the rooftop may be converted into a rooftop patio.

In addition, Chandan Fashion has undergone exterior aesthetic improvements - the store has been re-painted in bold colours in order to stand out among the rest. As such, the architecture plays a key role in making the store seem more iconic and unique. Moreover, the functional expansion of the business seems to follow the same path as Lahore Tikka House - to become more than just a business but a place where people gather; a destination or entity that serves multiple functions.



Fig 3.53: Interior display area



Fig 3.54: Exterior display area

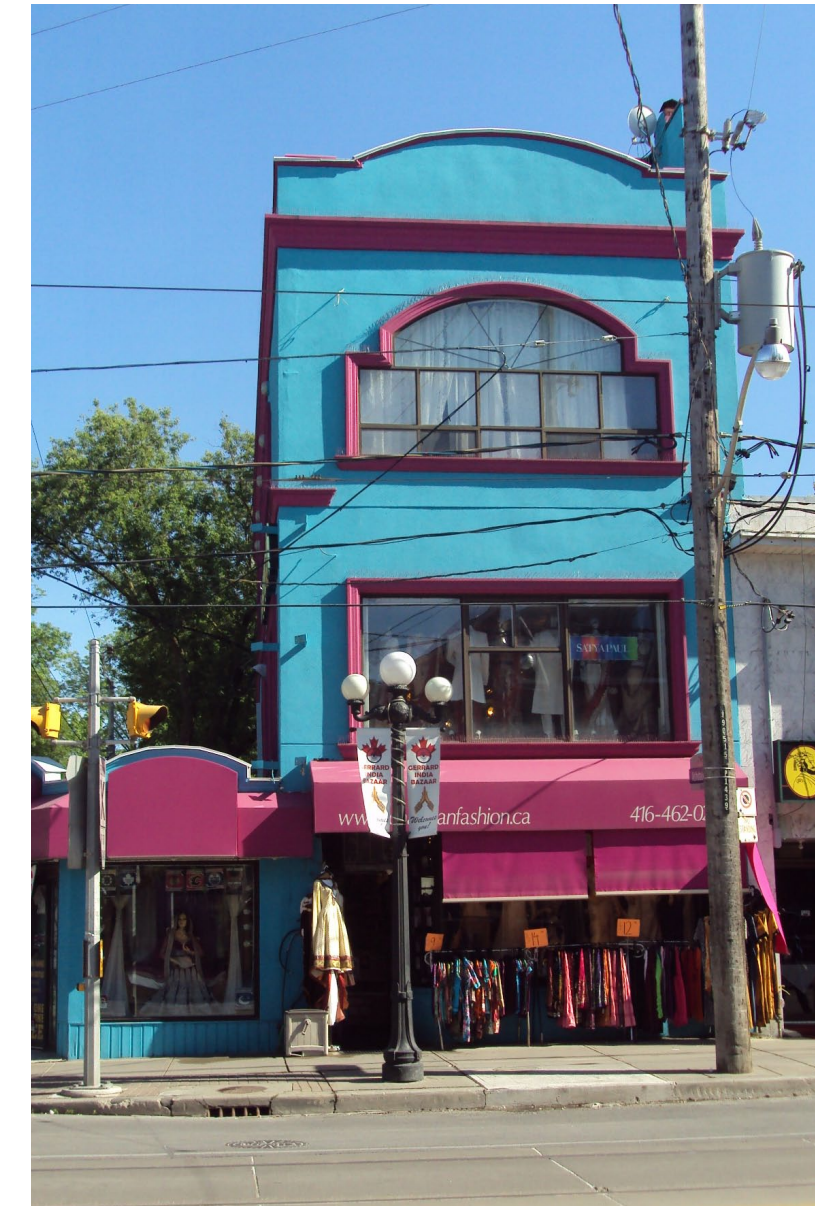


Fig 3.55: View of store from street

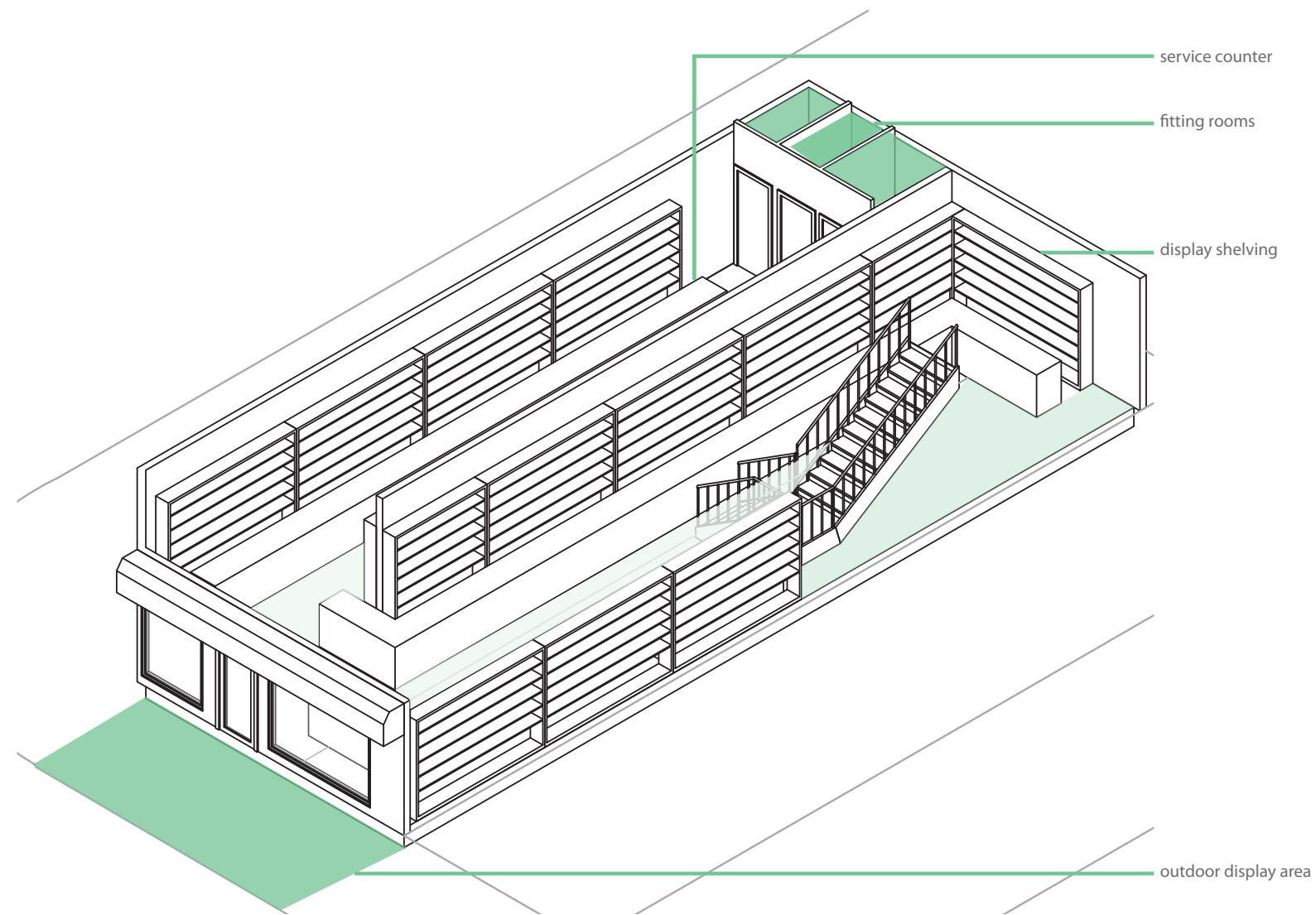


Fig 3.56: Diagram of Chandan Fashion (main level)

Ethnic Association: SA NSA

Organization Type: O R C GS

Key Characteristics: [Icons: grid, bus, wheelchair, window, calendar, map]

Key Entity: YES NO part of the BIA

Program Diversity:

Major Clients/ Visitors

[Icon: family] families/ individuals nearby

[Icon: car] families/ individuals from suburbs

[Icon: person] South Asians

[Icon: person] non-South Asians

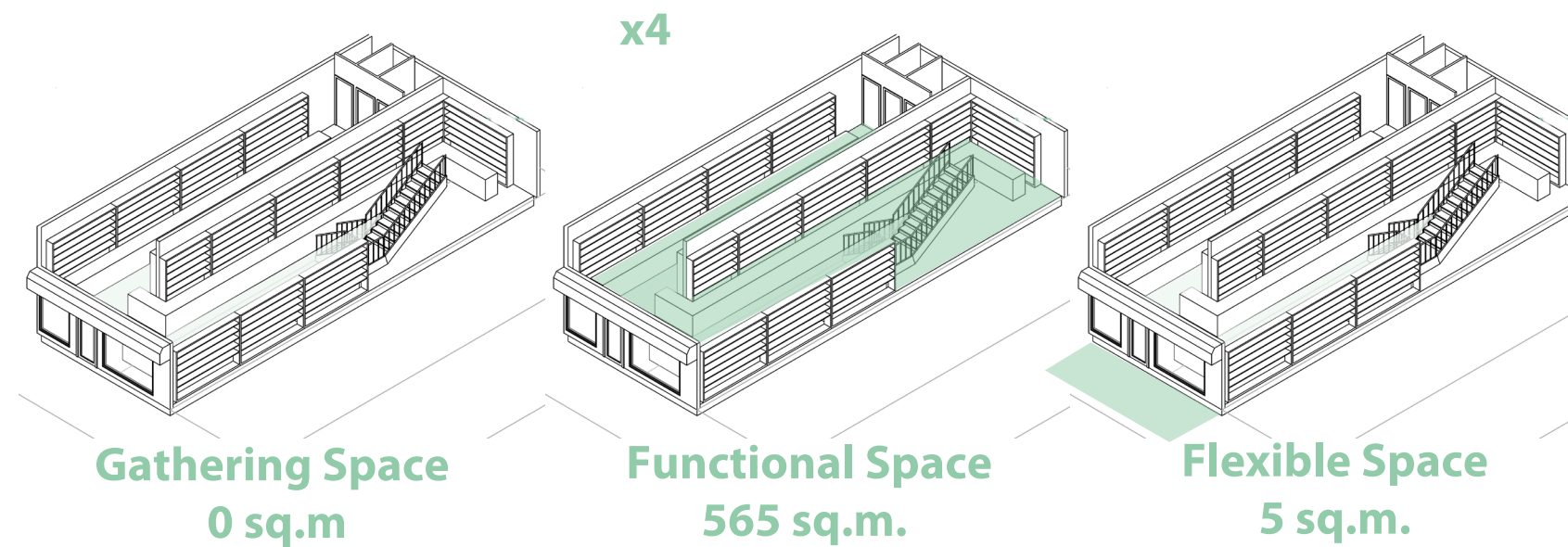


Fig 3.57: Chandan Fashion - analytical diagrams

7) Kohinoor Foods

A popular small market within the ethnic enclave, Kohinoor Foods, serves as a destination for South Asian goods. The supermarket is small and compact, with aisles of imported products from the Indian subcontinent and an underground storage room accessed by stairs at the back.

The business has declined over time due to the market being fragmented yet the summer months usually see a large number of customers.⁵ This is mainly due to better weather conditions and the possibility to display goods within a designated outdoor area. Once again, this serves as an “extension” of the stores display as well as a technique to attract customers towards the store.



Fig 3.58: Exterior food stall



Fig 3.59: Retail aisle

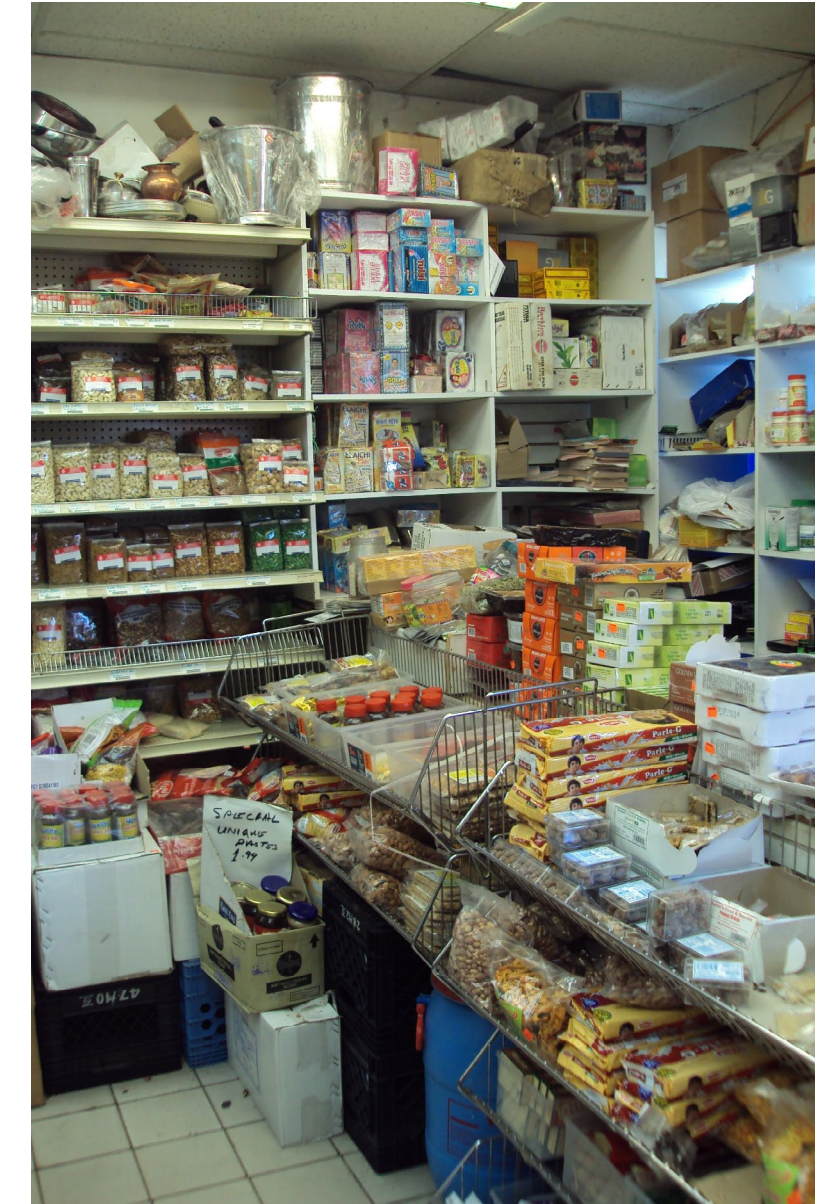


Fig 3.60: Retail aisle

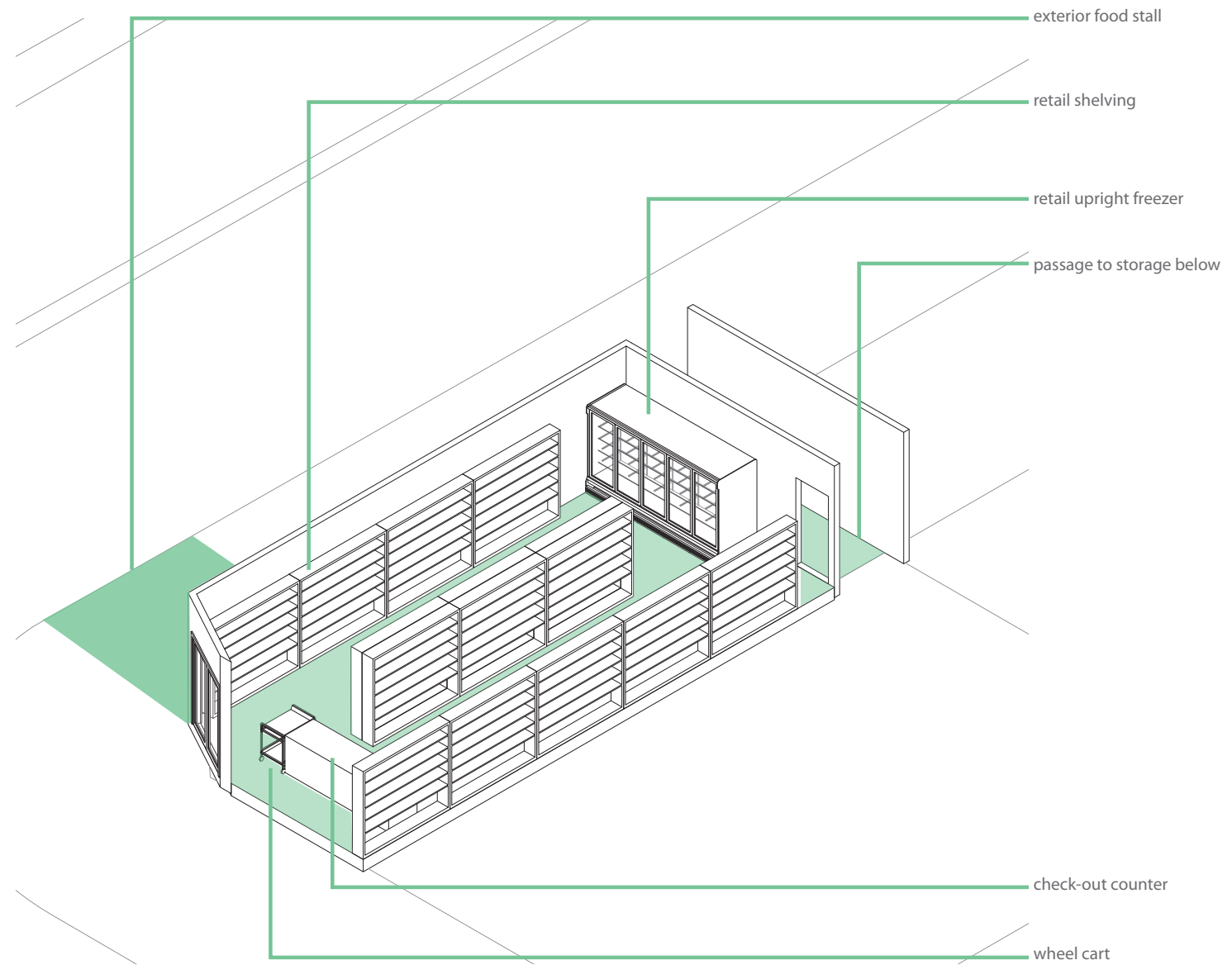


Fig 3.61: Diagram of Kohinoor Foods

Ethnic Association: SA NSA
Organization Type: O R C GS
Key Characteristics: [Icons: grid, truck, people, window, building, map]
Key Entity: YES NO part of the BIA
Program Diversity:

Major Clients/ Visitors

- [Icon: family] families/ individuals nearby
- [Icon: car] families/ individuals from suburbs
- [Icon: person] South Asians
- [Icon: person] non-South Asians

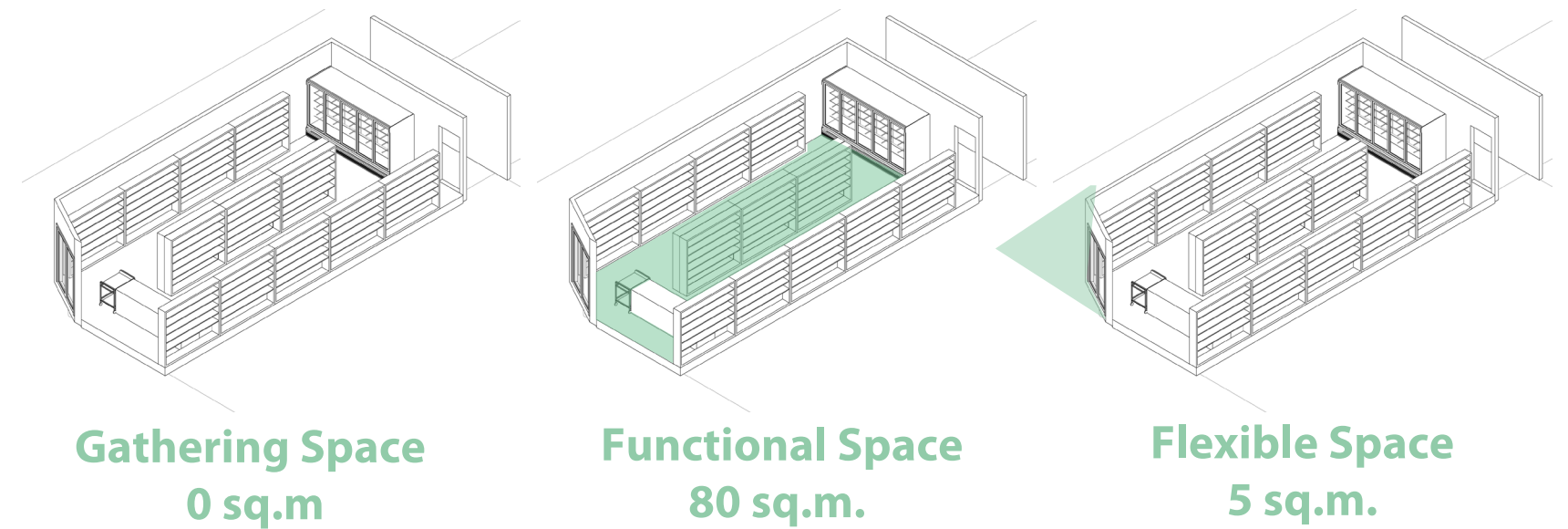


Fig 3.62: Kohinoor Foods - analytical diagrams

8) Sajawat

Sajawat is a small clothing boutique which sells traditional Indian attire and accessories. The store is fitted with ample shelving and clothing racks, with a long glass display counter along the east side. At the back is a central display element and a small change room.

Outside the store, colourful clothes are displayed so as to attract passersby. As such, the street becomes an "extension" for the store's display, as well as a marketing tool to lure customers into the shop.



Fig 3.63: Exterior clothing display area



Fig 3.64: Retail aisle

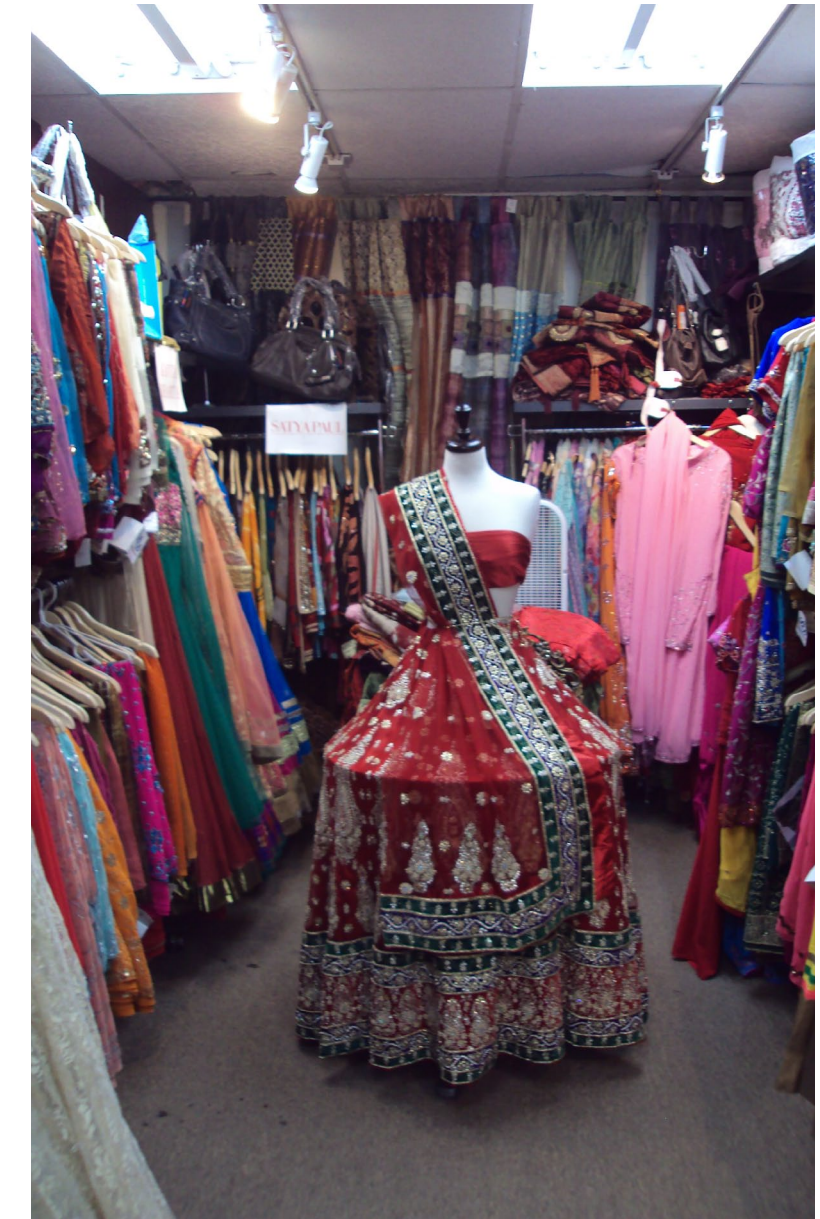


Fig 3.65: Clothing display

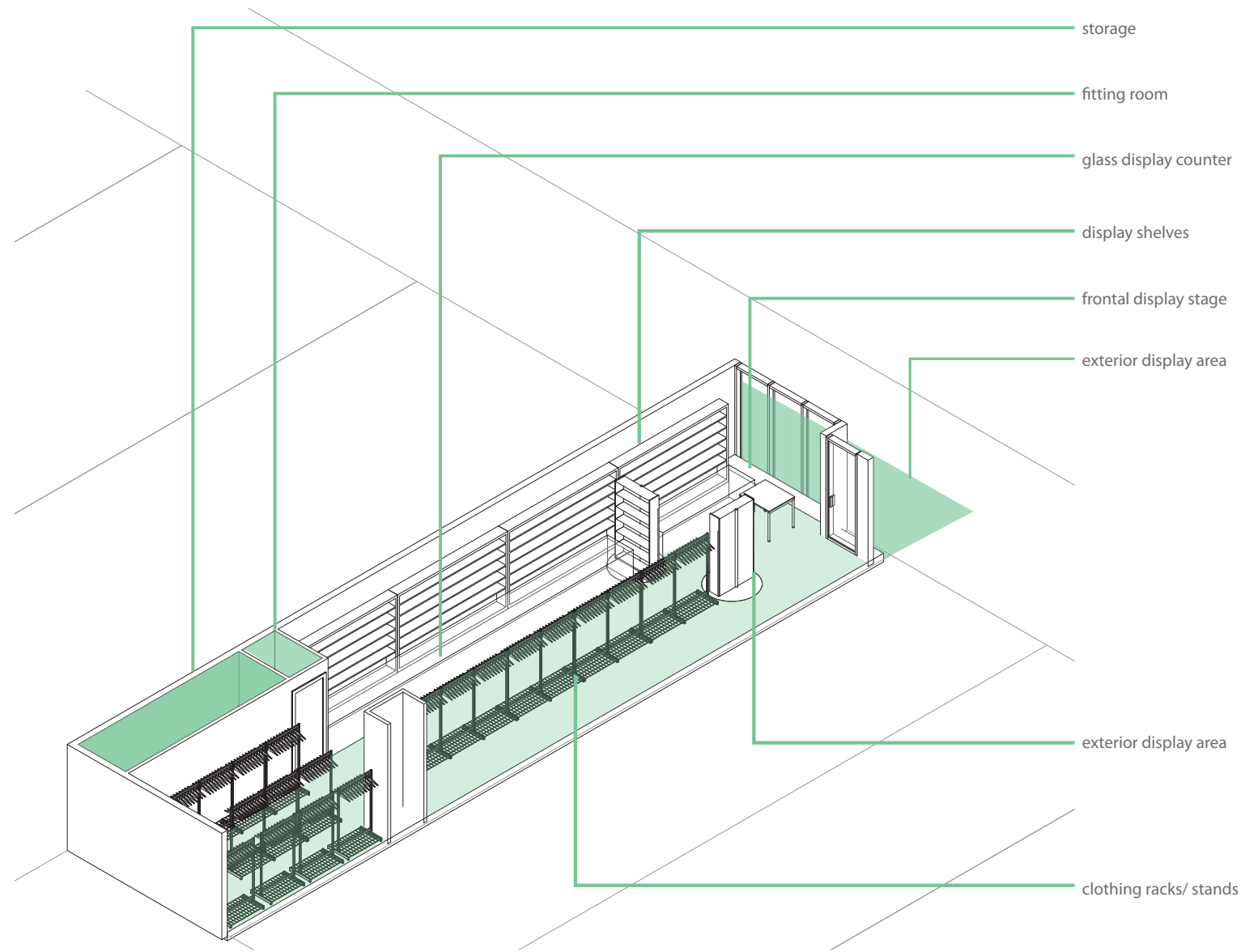


Fig 3.66: Diagram of Sajawat

Ethnic Association: SA NSA

Organization Type: O R C GS

Key Characteristics: [Icons: grid, bus, people, square, building, flag]

Key Entity: YES NO part of the BIA

Program Diversity:

Major Clients/ Visitors

- families/ individuals nearby
- families/ individuals from suburbs
- South Asians
- non-South Asians

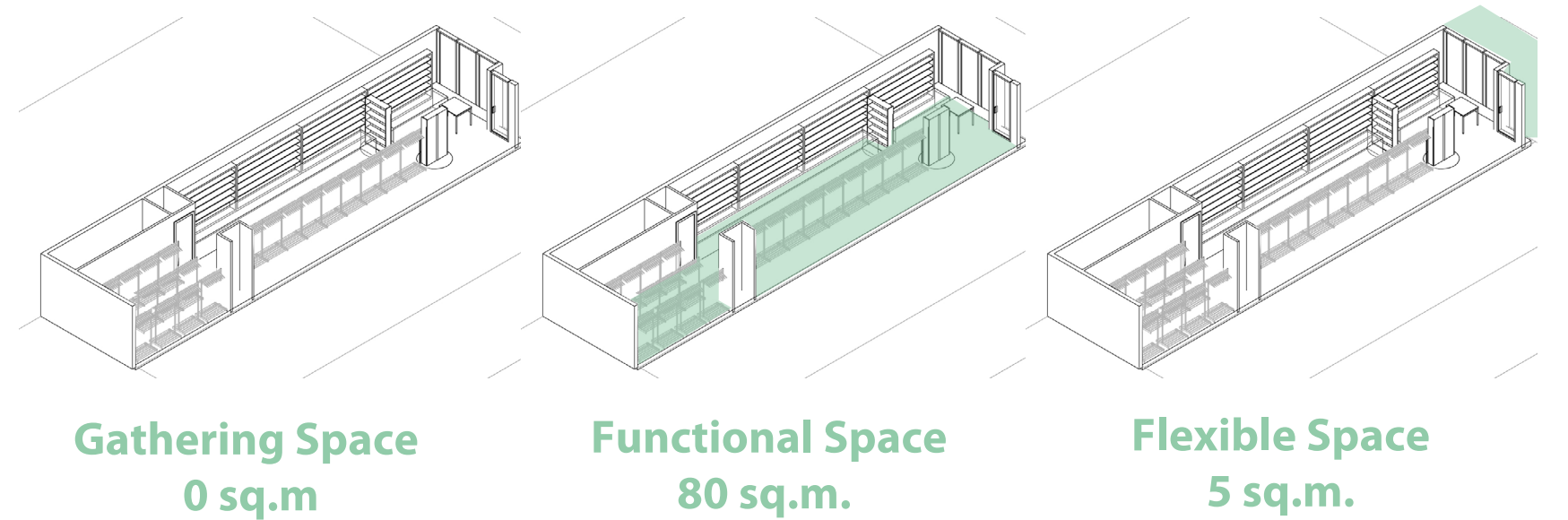


Fig 3.67 Sajawat - analytical diagrams

9) Pakistani Community Centre (PCC)

The Pakistani Community Centre (PCC), which was established in 2007, is situated within the Glen Rhodes Church. Opening occasionally for various events, the community centre has been a vital organism that brings together the local Pakistani, as well as mainstream community, together. Initially, the centre began to provide seniors with a place to gather.

Operating as a non-profit organization, the PCC provided English language classes for seniors and then began to collaborate with other organizations to host larger and more diverse events. However, the centre does not collaborate with the BIA for any community initiatives or gatherings.⁶

For every event, the interior of the PCC embraces different configurations.

For one of the events, Multi-Faith Cricket, the centre served as a lounge space where tables with snacks were arranged in the middle of the room while chairs were arranged around this table configuration as if the central part was a spectacle. Once the crowd had settled down after having snacks and receiving beverages from the kitchen, announcements were made on stage. After announcements, a large cake was cut in a ceremonial manner, and then served to the entire gathering.

For Family Night, another popular event, tables and chairs were arranged in three rows, all angled towards the stage in a symmetrical manner. The entire night was characterized by diverse cultural performances by various individuals.



Fig 3.68: Tables arranged in main space



Fig 3.69: Announcements made on stage



Fig 3.70: Singing performance on stage



Fig 3.71: dance performance on stage

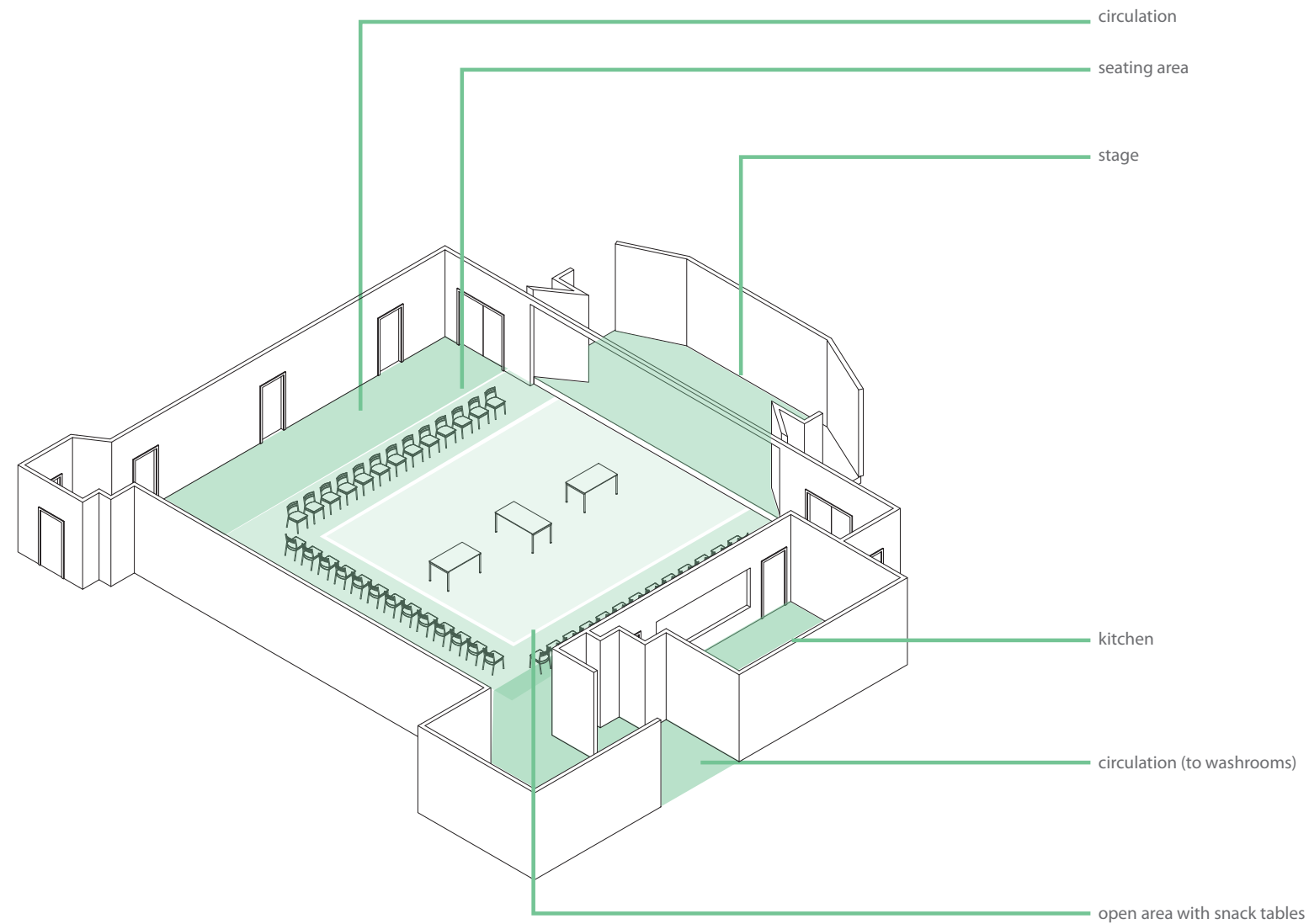


Fig 3.72: Diagram of the PCC

Ethnic Association: SA NSA

Organization Type: O R C GS

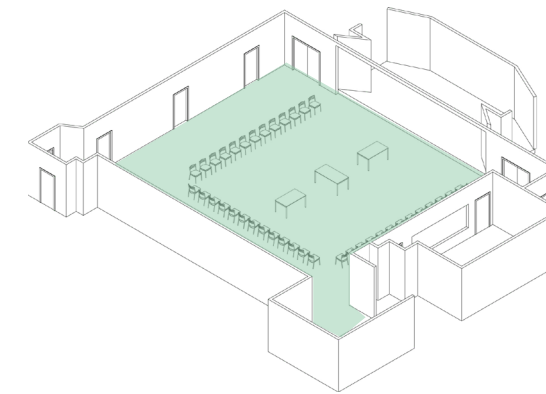
Key Characteristics: [Icons: square with plus, bus, group of people, laptop, building, flag]

Key Entity: YES NO part of the BIA

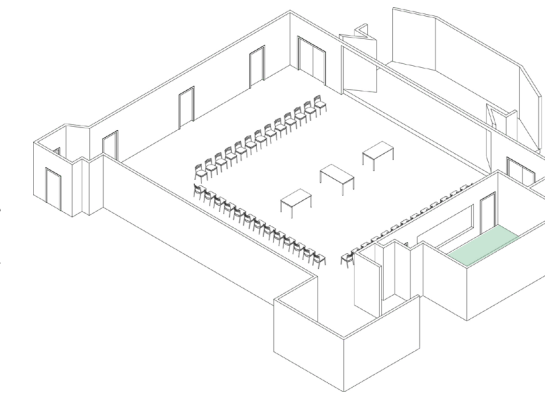
Program Diversity:

Major Clients/ Visitors

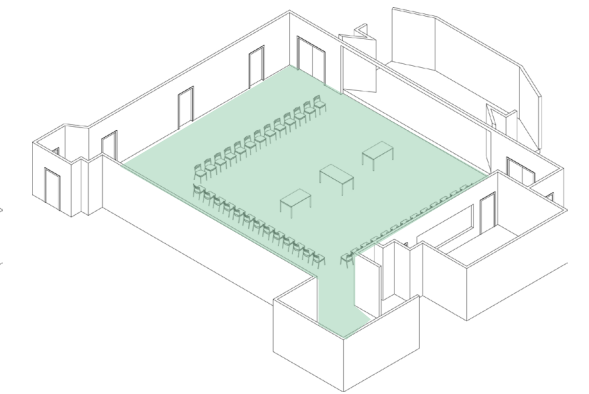
- families/ individuals nearby
- families/ individuals from suburbs
- South Asians
- non-South Asians



Gathering Space
200 sq.m



Functional Space
25 sq.m.



Flexible Space
200 sq.m.

Fig 3.73: PCC - analytical diagrams

10) Flying Pony

A classy coffee shop and art gallery, the Flying Pony opened its doors a year within a long-derelect building that was previously owned by a Greek barber.

The cafe has a corner entrance which is inset and leads to the seating area. A long hallway runs along the kitchen area to an additional lounge and art gallery space, behind which are the washrooms and employee areas.

The Flying Pony is an example of commercial change within the Gerrard Bazaar as the demographic make-up of the area transforms. This change is mostly with programs relating to art or food - two key elements that are slowly becoming trendy within the neighbourhood and nearby areas.

Once again, the notion of multiplicity is evident within the Flying Pony. The small coffee shop serves as a lounging space where one can view art or a sit in a cozy boutique coffee shop.



Fig 3.74: Art gallery area



Fig 3.75: Coffee shop area



Fig 3.76: Hallway to art gallery area

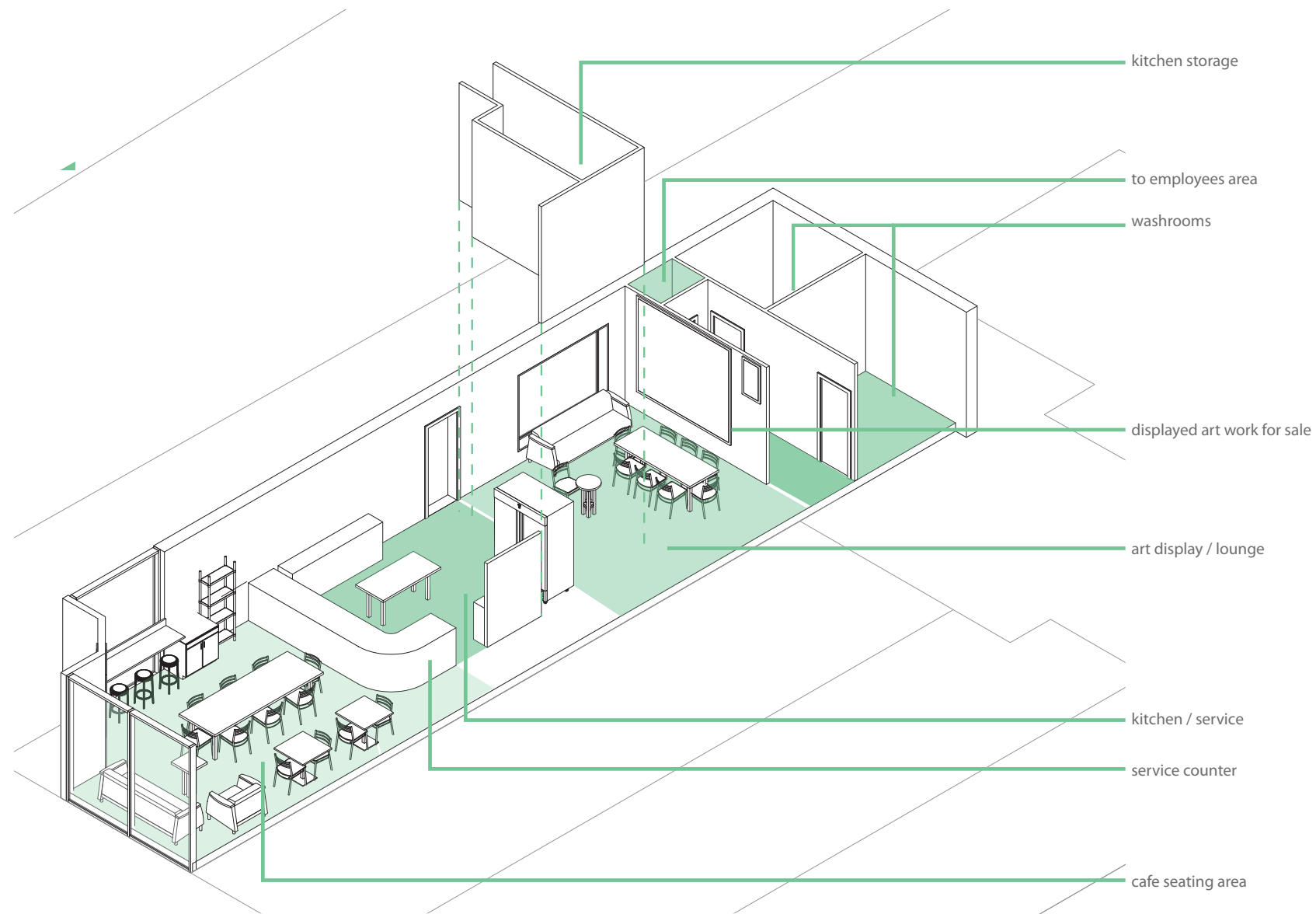


Fig 3.77: Diagram of The Flying Pony

Ethnic Association: SA NSA

Organization Type: O R C GS

Key Characteristics: [Icons: square with plus, bus, people, square with circle, building, square with plus]

Key Entity: YES NO part of the BIA

Program Diversity:

Major Clients/ Visitors

- [Icon: family] families/ individuals nearby
- [Icon: car] families/ individuals from suburbs
- [Icon: person] South Asians
- [Icon: person] non-South Asians

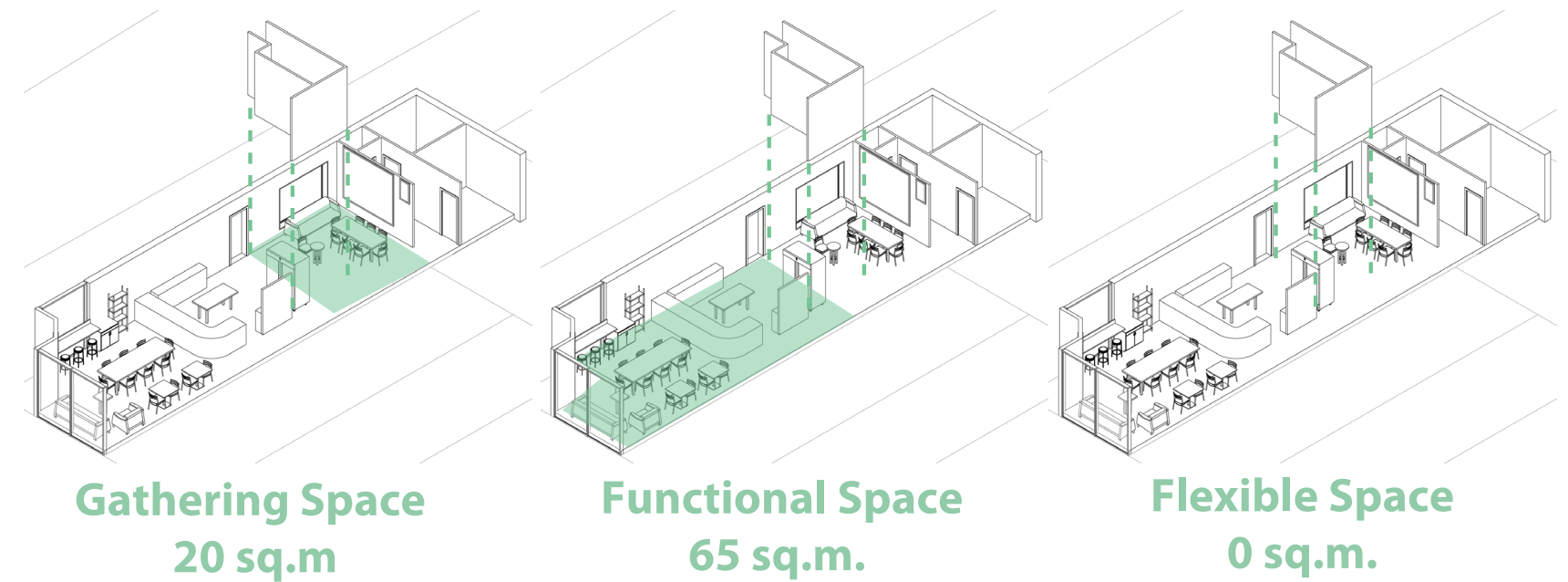


Fig 3.78: Flying Pony - analytical diagrams

11) Lens Work

Lens Work is a small art production studio and school that serves mainly children from families who reside within a 3km radius of the Gerrard Bazaar.

The layout of the rectangular store is informal and flexible with a production space near the front and a small office space near the back. Similar to Kohinoor Foods, there is a narrow staircase leading to a lower level storage area, except this passage is accessed on the east side of the store as opposed to the back end.

The store opened just a year ago in place of a South Asian textiles clothing store which closed down due to lack of business and subsequent delays in rent payments⁷.



Fig 3.79: Flexible workshop space



Fig 3.81: View to store entry



Fig 3.80: Art display table



Fig 3.82: View to private office area

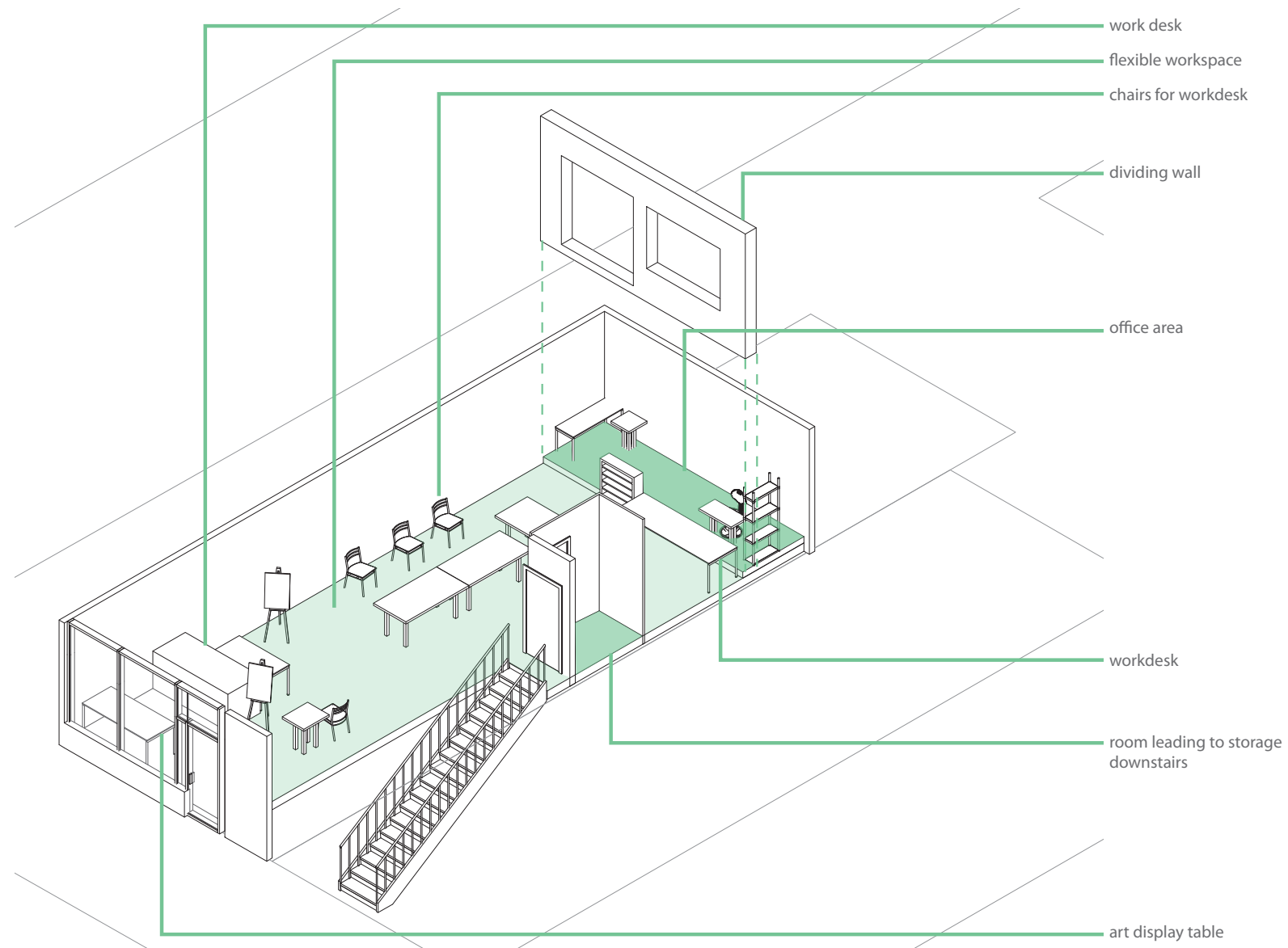


Fig 3.83: Diagram of Lens Work

Ethnic Association: SA NSA

Organization Type: O R C GS

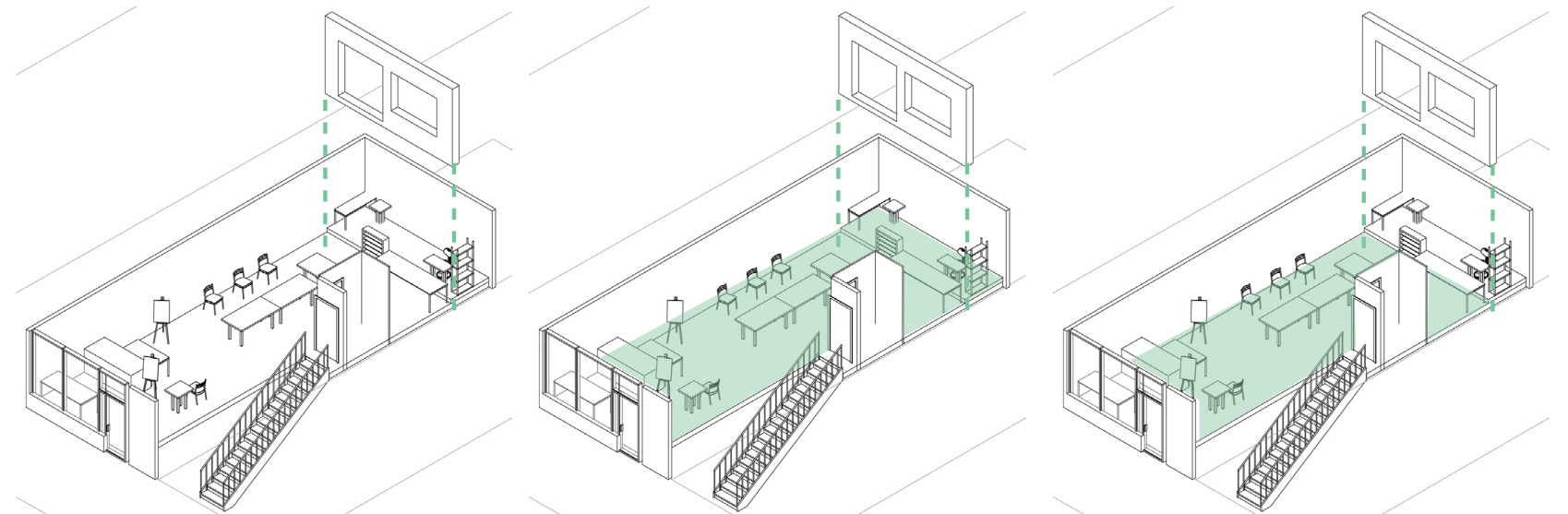
Key Characteristics: [Icons: office, bus, people, laptop, building, flag]

Key Entity: YES NO part of the BIA

Program Diversity:

Major Clients/ Visitors

- families/ individuals nearby
- families/ individuals from suburbs
- South Asians
- non-South Asians



Gathering Space
0 sq.m

Functional Space
120 sq.m.

Flexible Space
100 sq.m.

Fig 3.84: Lens Work - analytical diagrams

12) Swag Sisters Toy Store

The Swag Sisters Toy Store is an example of a new, non-ethnic business that caters to the changing demographics of the Gerrard Bazaar neighbourhood. The store opened in 2012, in place of a South Asian jewelry store, which is now re-located in a larger and busier location along the strip.

Looking at the architecture of the shop, it follows the same typology as Kohinoor Foods in that there store is on the main level while the storage is accessed by stairs leading down to a lower level near the back of the shop. There is also a back door exit. In front of the store are three colourful chairs that allow passersby to take a seat while strolling along the Bazaar. As such, the toy store also embraces the public realm and utilizes it to market its identity as well as promote a sense of community.



Fig 3.85: Interior retail display



Fig 3.86: Exterior wooden chairs

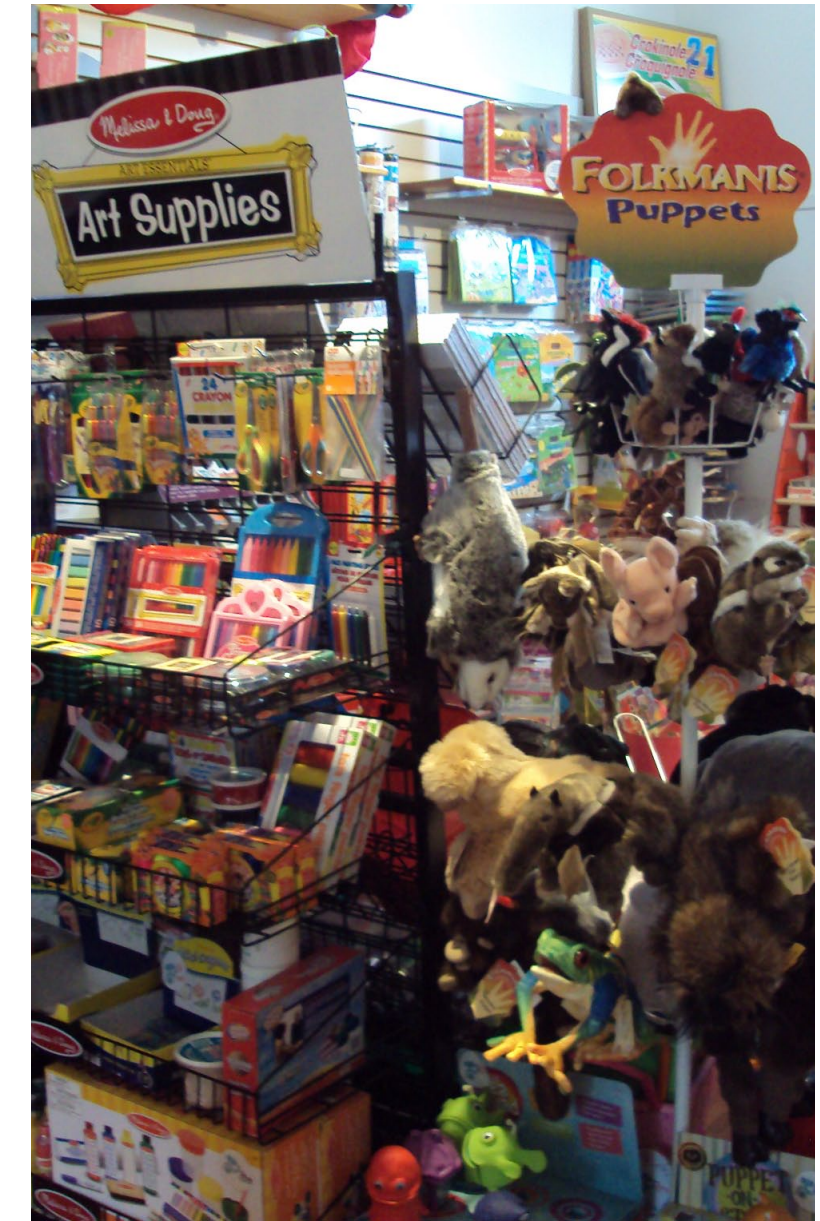


Fig 3.87: Toys on display

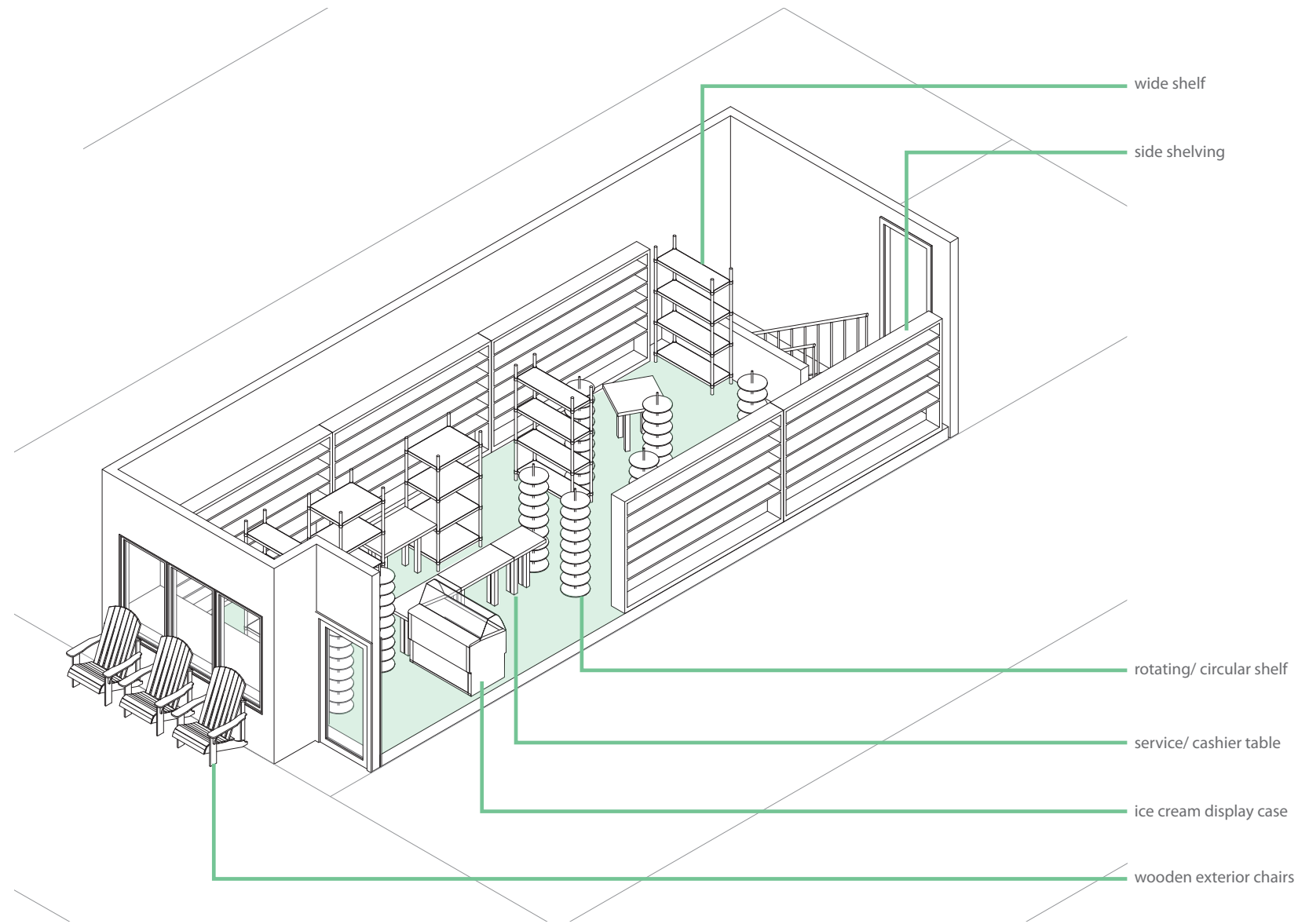


Fig 3.88: Diagram of Swag Sisters Toy Store

Ethnic Association: SA NSA

Organization Type: O R C GS

Key Characteristics: [Icons: grid, computer, people, square, calculator, globe]

Key Entity: YES NO part of the BIA

Program Diversity:

Major Clients/ Visitors

[Icon: family] families/ individuals nearby

[Icon: car] families/ individuals from suburbs

[Icon: person] South Asians

[Icon: person] non-South Asians

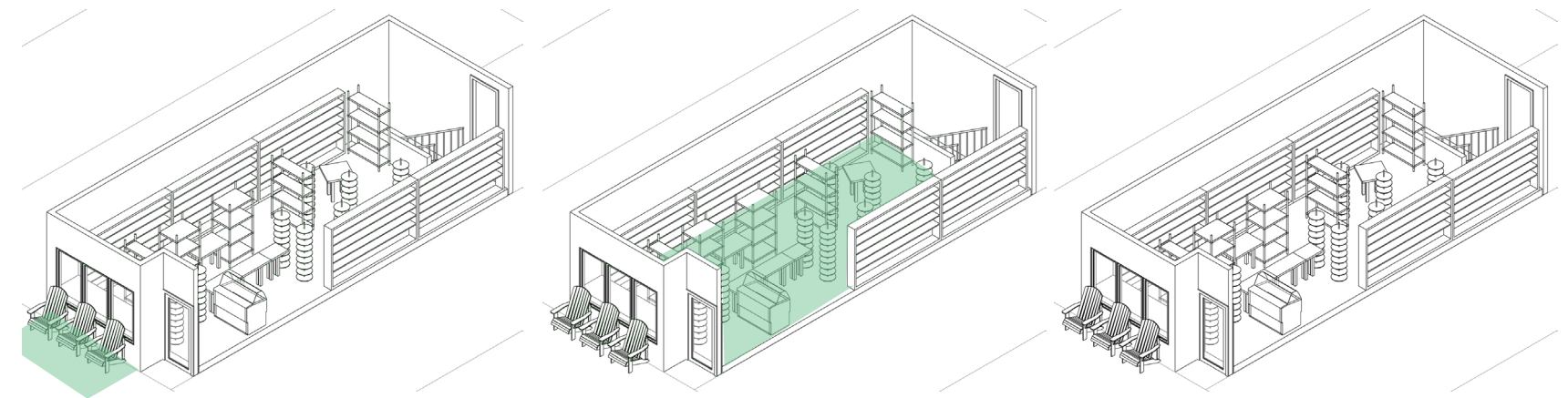


Fig 3.89: Swag Sisters Toy Store - analytical diagrams

13) Ali Baba Restaurant

Ali Baba Restaurant's architecture is similar to Jhumka jewelry store - the storefront is a standard curtain wall with an inset entrance. The interior has a generous seating area for a small cafe with a service counter near the back that leads into the kitchen/ food preparation area. On the east side of the restaurant are stairs that lead down to a large storage area - something that is typical in many stores along the strip.

Painted frames on the curtain wall mimic the design of arches found in Mughal architecture. Moreover, the light green colour of the walls reflects the ethnic origin of the restaurant.



Fig 3.90: Interior seating area



Fig 3.91: Back of house kitchen



Fig 3.92: Interior seating area

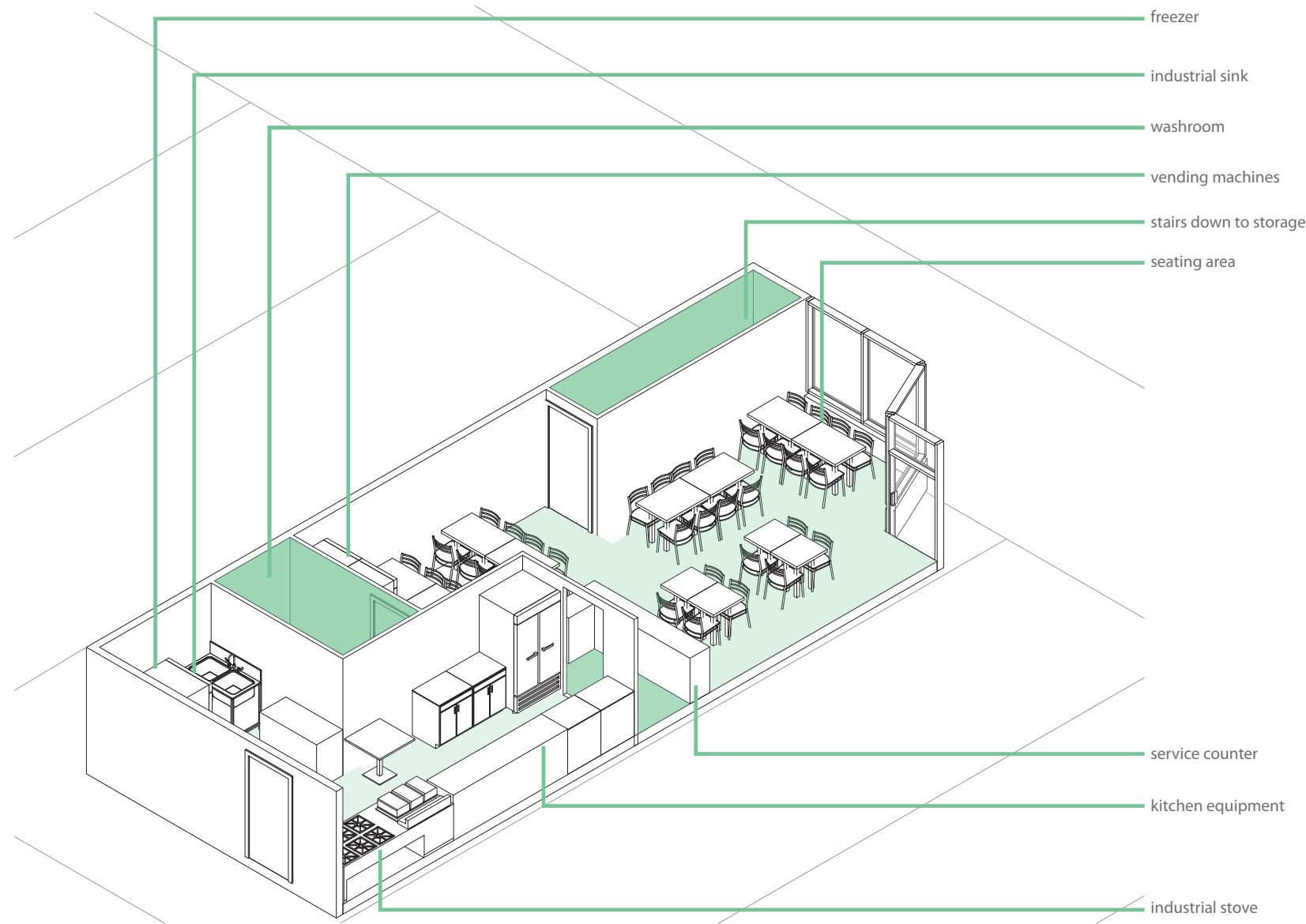


Fig 3.93: Diagram of Ali Baba Restaurant

Ethnic Association: SA NSA

Organization Type: O R C GS

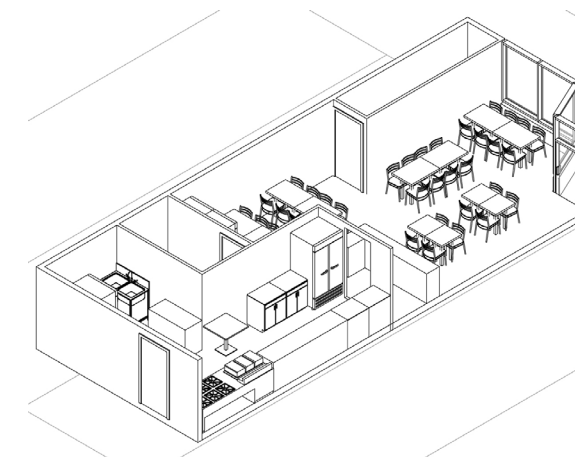
Key Characteristics: [Icons: grid, bus, group, square, building, square]

Key Entity: YES NO part of the BIA

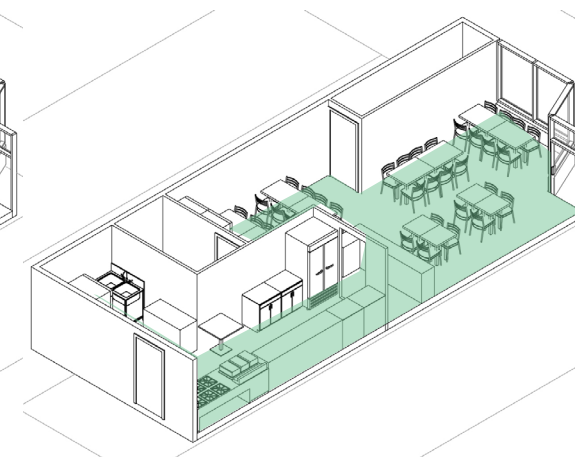
Program Diversity:

Major Clients/ Visitors

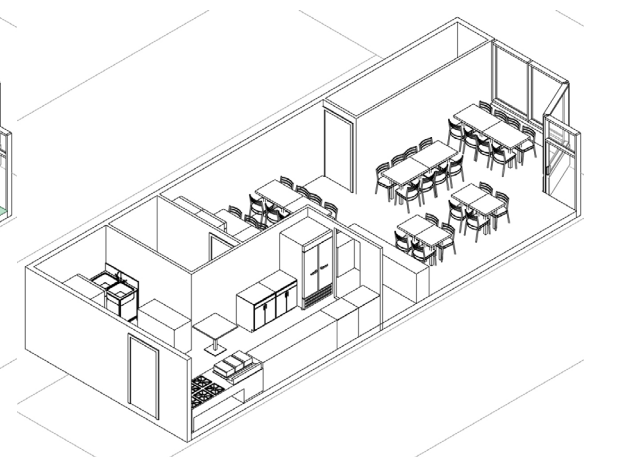
- [Icon: family] families/ individuals nearby
- [Icon: car] families/ individuals from suburbs
- [Icon: person] South Asians
- [Icon: person] non-South Asians



Gathering Space
0 sq.m



Functional Space
80 sq.m.



Flexible Space
0 sq.m.

Fig 3.94: Ali Baba Restaurant - analytical diagrams

3.4 Architectural and Spatial Analysis in Relation to Design

Analysis of this diverse range of stores clearly indicates that the Gerrard Bazaar caters to wide array of clientele and boasts a colourful variety of restaurants, clothiers, specialty stores and the like.

Some key findings from this study, however, are apparent, and these would assist with the ultimate design intervention(s).

Firstly, most of the non-South Asian stores receive predominantly non-South Asian clients. On the other hand, many of the South Asian stores receive a variety of ethnic groups from a variety of different places, near or far. This implies that many non-South Asians who live nearby or who visit the Gerrard Bazaar are keen on learning and experiencing the South Asian culture, while many South Asians come for specific goods, services or occasionally indulging in the sights, smells and taste of the retail strip. This also implies that while non-South Asians are keen about experiencing South Asian culture, many South Asians do not seem to be interested in engaging with the current trends in the neighbourhood that relate to art and culture. As such, the ultimate design proposal needs to consider this aspect and create a program that renders interest among the South Asian community. By housing programs that engage both types of ethnic groups, there is the opportunity to host a diverse spectrum of gatherings that promote cultural exchange and social cohesion.

Another interesting finding is that those shops which have an emphasis on architecture, or are architecturally large and iconic, tend to attract more interest from those who come from suburban regions. This could be due to the fact that although the programs that are offered by that specific store are important for visitors, the fact that the shop or restaurant is large and iconic seems to make it worthwhile for people to commute all the way from the suburbs. These entities tend to add to the locus of the Gerrard Bazaar and would have a tendency to remain in

ones memory.

In order to clarify these findings and gain personal insight, interviews and surveys were conducted. It is these personal responses that would give credibility to the aforementioned findings regarding the 13 examined storefronts.

Endnotes

1. Festival of South Asia, TD. Event information: Festival of south asia. 2014 [cited 05/30 2015]. Available from http://www.festivalofsouthasia.com/event_information.html.
2. Micallef, Shawn. The riverdale hub expands on toronto's ever-evolving gerrard street. Yongestreet, <http://www.yongestreetmedia.ca/features/riverdalehub0831.aspx> (accessed 01/23 2015).
3. Saeed, Humaira. Lahore tikka house: The journey. in Heritage Toronto [database online]. 2012. Available from <http://heritagetoronto.org/lahore-tikka-house-the-journey/> (accessed 07/02 2014).
4. Interview with storeowner 3, 06/07 2014.
5. Interview with storeowner 9, 06/07 2014.
6. Interview with organization 13, 06/10 2014.
7. Interview with storeowner 11, 06/27 2014.

4. PERSONAL PERSPECTIVES OF GERRARD BAZAAR |

- 4.1 Perspectives of a South Asian
- 4.2 Personal Survey and Analysis
- 4.3 Respondent Mapping Analysis
- 4.4 Personal Interviews and Analysis
- 4.5 Architectural and Spatial Analysis in Relation to Design



Fig 4.01: A typical street within the Gerrard Bazaar

4.1 Perspectives of a South Asian

When I first walked the streets of the Gerrard Bazaar in the winter of 2001, I was impressed and intrigued by how authentic and vibrant it seemed. I had visited the street with my family and cousins from New York, who saw an evident comparison of the enclave with the one situated in Jackson Heights. Although it was a bitter cold evening, we walked the entire stretch between Coxwell and Greenwood Avenues, and concluded our stroll with dinner at Moti Mahal.

In spite of my many visits to the Gerrard Bazaar after that, I travelled to the site for the first time during Eid in 2006, to experience the various festivities that were taking place. Loud music was audible from every part of the strip while shops were open till late, serving clients that swarmed the interior. Regardless of the crowded sidewalk and congested roads, it was exciting and invigorating to be a part of a much larger group of South Asians who shared the same excitement for the holiday. It felt as though we were a strong group who, despite living in a foreign nation, whole-heartedly embraced our culture and held it with pride. Our place in Canadian society was reinforced and accepted as a yet another distinct entity within its cultural fabric.

It wasn't until fairly recently that I paid another visit to the site, once again during Eid celebrations. Given my five years of experience in the realm of architecture, and my growing interest in urban design, I perceived Gerrard Street East in a different manner. Among the hustle and bustle of Eid shoppers, numerous henna stalls, crowded restaurants and wild traffic, I noticed the many buildings that were in disarray or vacant. It was as if there was a constant alternating pattern of colourful storefronts with a dull moment of urban vacancy. This observation is what triggered my initial interest in the urban and economic condition of the retail strip.

Research pursued over the past year has enabled me to become well aware of all the issues surrounding the Gerrard Bazaar and how a place that I closely identify with is affected by gentrification, economic loss and declining visual appeal.

As a Pakistani-Canadian, it is disconcerting for me to see the slow transition of the South Asian retail to mainstream businesses. Though



Fig 4.02: A vacant storefront within the Gerrard Bazaar

I feel that many of these new shops are adding a vibrant appeal to the enclave, I value my culture and its presence through this ethnic neighbourhood, despite the fact that I have never resided there.

In my perspective, it is imperative that the heritage of Gerrard Street East be maintained, for it speaks to the presence of South Asians within the city, possesses historical significance of their integration within society, and serves as an importance destination for key cultural holidays. The ethnic community holds significant importance for many South Asian minorities, within the Greater Toronto Area, and despite the availability of ethnic goods and services within other suburban centres, still has the largest number of South Asian retailers in one destination.

Given my South Asian identity, my perspective on the Gerrard Bazaar is important. However, my perspective may not be the same as others from my cultural background. It is important to determine the general perception about the ethnic enclave, not only from the South Asian population within the GTA, but also those who do not associate with that ethnic background. This would uncover a whole new personal realm of what culture, identity and the Gerrard Bazaar means to different individuals.

Determine Sample Size

Confidence Level: 95% 99%

Confidence Interval:

Population:

Sample size needed:

Find Confidence Interval

Confidence Level: 95% 99%

Sample Size:

Population:

Percentage:

Confidence Interval:

Fig 4.03: Survey sample size calculator as found on The Survey System

4.2 Personal Survey and Analysis

As mentioned earlier, surveys and interviews were conducted as a third method of research and analysis, within this thesis.

In order to understand how people perceive and frequent the Gerrard Bazaar, a survey was conducted for anyone within the GTA, which asked a series of questions relating to what people think of the Gerrard Bazaar, how it is a part of their activities and how culture is a part of their life. These questions were carefully devised so as to understand how aspects of culture, program, and demography relate to every respondent and the Gerrard Bazaar. Interviews were also conducted with key entities on site in order to understand their perception of the bazaar, their place within the strip, their function and other key aspects of their organization or enterprise.

An appropriate sample size for the surveys and interviews was determined using The Survey System survey software. Both confidence interval and confidence level were considered, as well as the total South Asian population within the Greater Toronto Area, which was the only input. A confidence interval (also referred to as the margin of error) of 8 was used. This means that if, for instance, 40 participants of Nepali descendant answered "Yes" to a specific question, then it is assumed that 40-48 participants of Nepali descendant would give the same response. The confidence level was set to 95% (used by most researchers), meaning that one can be 95% sure of the results. After these values were entered, a sample size of 150 was determined. Considering that South Asians were the main target participants and non-South Asians were secondary, a sample of size of 50 non-South Asians was utilized. There is a general understanding that many South Asian storeowners are experiencing decline, while many new stores are experiencing growth. As such, a confidence interval of 10 was utilized for storeowners as well as a confidence level of 95%.



Fig 4.04: Facebook recruitment method for survey

Once survey and interview questions were formulated and a sample size was determined, an application was submitted to the Office of Research Ethics at the University of Waterloo. Ethics clearance was imperative to obtain, prior to conducting any research with humans, to ensure that all interaction was in accordance with ethical standards. Ethics clearance was received within a few weeks time after which recruitment material was distributed for both the survey and interviews.

Participants for the survey were recruited through several methods. The main means utilized was posting on various South Asian and Gerrard Bazaar "Groups" on Facebook. Numerous South Asian cultural centres were also contacted, to distribute informative e-mails with the survey link, to members. A small number of these organizations agreed to do so via e-mail once ethics clearance was received. Within the University, South Asian clubs were contacted in order to distribute the survey to their members. In addition, survey recruitment material was posted on the School of Architecture Yahoo Group as well as the Graduate student LEARN group. Within one month, an approximate sample size for the survey was achieved.

Participants for the interviews were obtained via telephone if they are key members of an on-site organization, and via a personal survey recruitment letter if they are a merchant. Interview times were then arranged by e-mail or verbally, and then conducted within a few weeks of sending the letter.

About 50 participants were non-South Asian, while 150 were South Asian. In addition, 2 of the 20 individuals interviewed were from non-profit organizations, one of which was on-site. The rest of the interviews were conducted with merchants. Moreover, 31 respondents were residents within the immediate neighbourhood and 45 were from regions within the city of Toronto.

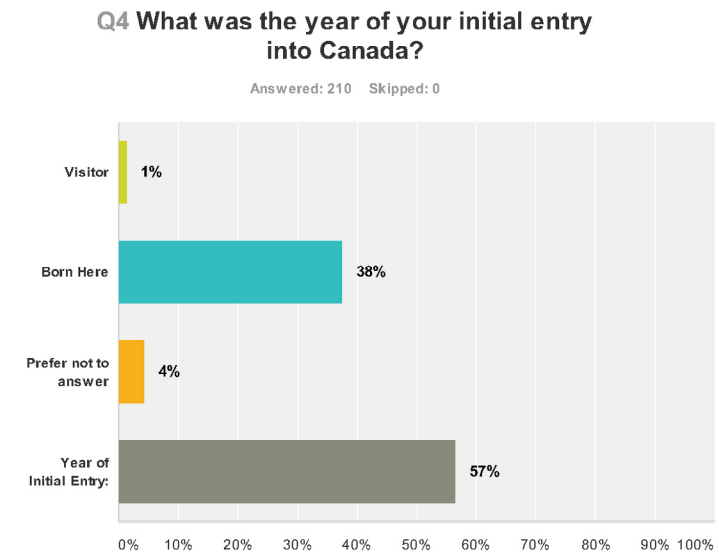
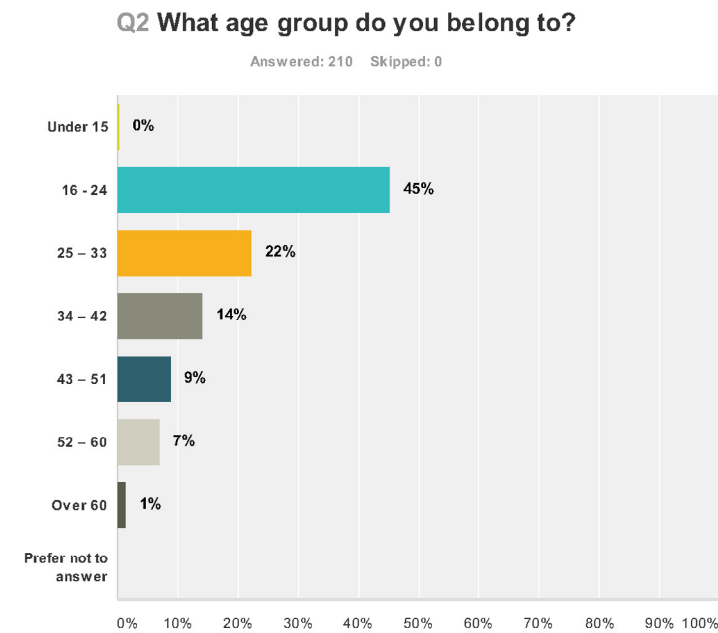
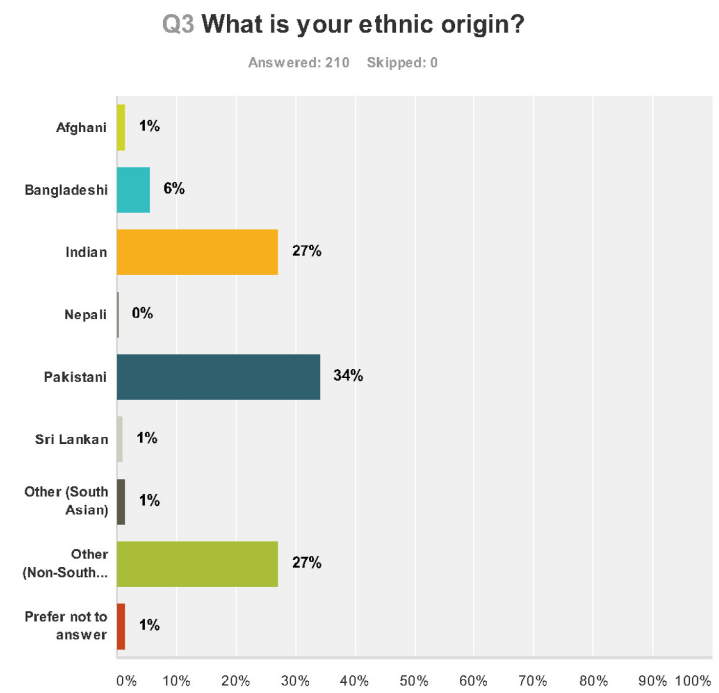
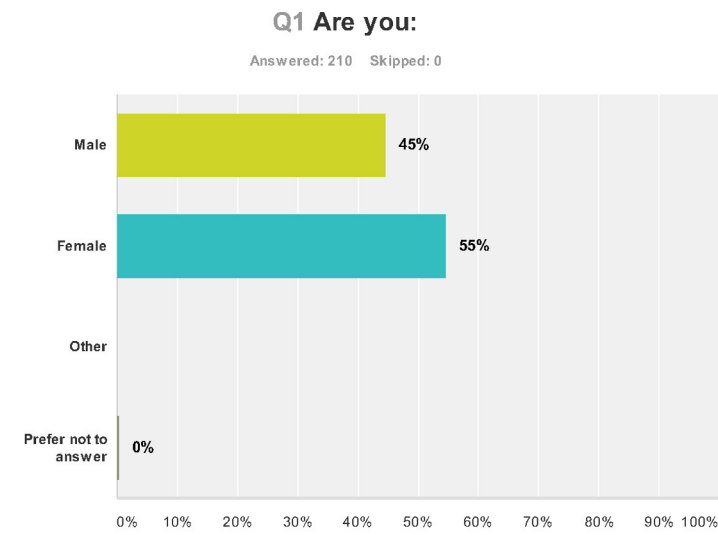


Fig 4.05: Survey - Summary Results - Question 1 - 4

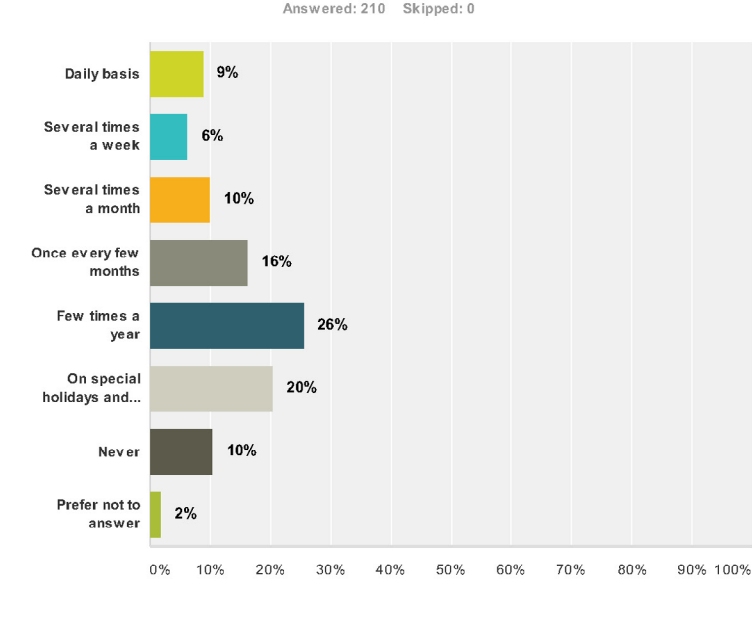
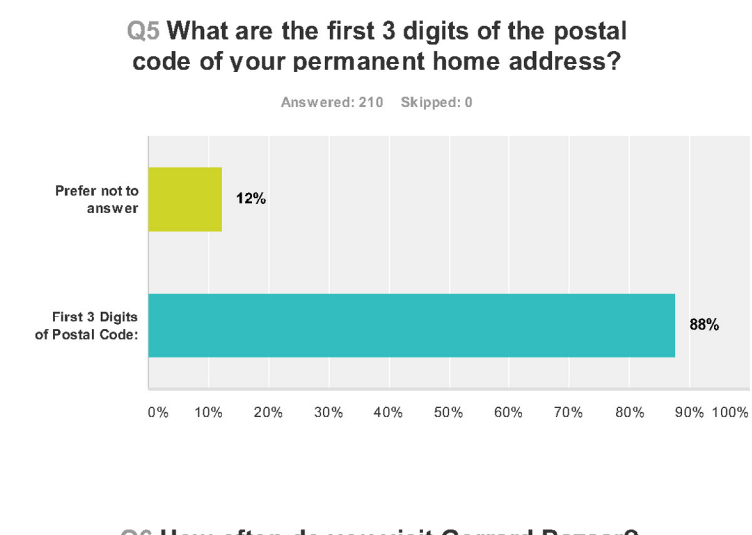


Fig 4.06: Survey - Summary Results - Question 5 - 6

The conducted survey was completed anonymously by participants. However, they had the option to provide their age group as well as ethnicity. This allowed for the survey results to be filtered by Ethnic Group and Age Group. The survey answers depicted are those that belong to the main summarizing survey that has no filters by age or ethnicity. The analysis, however, examines the survey results with and without these filters.

**For survey results filtered by Ethnicity and Age, please see Appendices.*

Majority of the respondents in the "Under 15", "16-24" and "25-33" categories, were South Asian, while the ones who were older, were mostly non-South Asian. There was a slow gradient observed – as age increased, the number of South Asian respondents decreased and non-South Asian respondents increased.

The majority of respondents answered that they visit the Gerrard Bazaar "A few times a year" (26%), followed by "On special holidays and occasions" (20%) and then "Once every few months" (16%). Majority of respondents in the "16-24" and "25-33" categories visit the Gerrard Bazaar "A few times a year" or "On special holidays and celebrations" while the majority of respondents in the "34-42" and "43-51" categories, answered "Several times a month" or "Daily basis". Those belonging to an older age group had varying responses. Most respondents of South Asian descent answered "Few times a year" and "On special holidays and occasions" when asked how often they visit the Gerrard Bazaar. The majority of non-South Asian respondents answered "Daily basis" or "Several times a month". This is indicative of the fact that the majority of residents are non-South Asian and utilize the Gerrard Bazaar much more frequently than South Asians, who come occasionally from the suburbs. This further suggests that the design intervention must cater to the frequently visiting non-South Asian and the occasionally visiting South Asian – but must also try to attract South Asians to visit more,

Q7 What types of commercial enterprises do you visit within the Gerrard Bazaar? (Please select all that apply)

Answered: 210 Skipped: 0

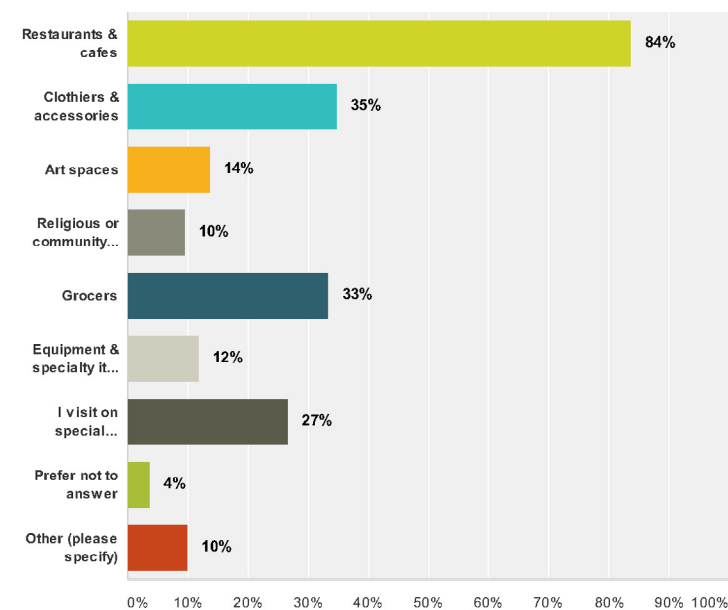


Fig 4.07: Survey - Summary Results - Question 7

particularly the younger generation. The fact that South Asians visit several times a year or on special holidays and occasions suggests that they visit the Gerrard Bazaar for a specific purpose.

The clear majority of respondents stated that they visit “Restaurants and cafes” (84%), with “Clothiers and accessories” (35%), “Grocers” (33%) and “I visit on special holidays and occasions” (27%) as other common answer choices. All age groups stated “Restaurants and cafes” as the most common enterprise visited within the Gerrard Bazaar. A significant number of respondents from the “16-24” and “25-33” categories answered “Clothiers and accessories”, “Grocers” and “I visit on special holidays and occasions”. After “Restaurants and Cafes”, those belonging to an older age group answered “Grocers” as their second highest enterprise visited. The majority of non-South Asians answered “Restaurants and cafes” and “Grocers” to this question. Other common answers included the public library. This indicates that the majority of non-South Asians use grocers possibly for specialty items from the Indian subcontinent and for dining out once in a while. On the other hand, the average South Asian utilizes the Gerrard Bazaar for eating out occasionally or buying clothing and accessories for special occasions; this is what causes them to commute to the area. As such, restaurants are common destinations for both, South Asians and non-South Asians, as well as grocery stores.

The majority of respondents answered that “Better visual appeal” (55%) would make them visit the Gerrard Bazaar more often. Followed closely by “More cultural events and festivals” (51%). “More restaurants” (39%) and “More community gathering spaces” (26%). The majority of respondents in the “Under 15”, “16-24” and “25-33” categories answered that “More cultural events and festivals”, “More restaurants” and “Better visual appeal”, would make them visit the Gerrard Bazaar more often. Many respondents in the “34-42” and “43-51” categories also answered “More community gathering spaces” would make them visit the site

Q8 What factors would make you visit the Gerrard Bazaar more than you currently do? (Please select all that apply)

Answered: 210 Skipped: 0

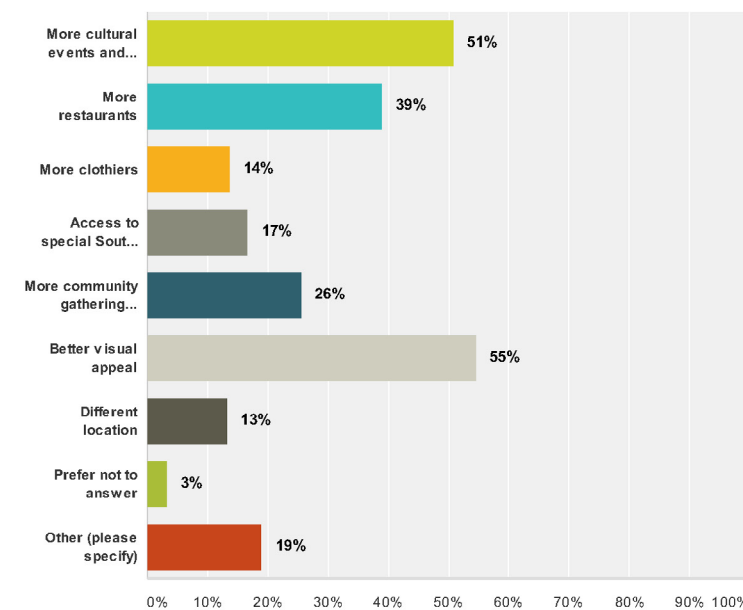


Fig 4.08: Survey - Summary Results - Question 8

more frequently. There is a slow gradient – as age increases, the number of respondents who answered “Better visual appeal” increased. In terms of ethnicity, South Asian respondents predominantly answered “More cultural events and Festivals” as the main factor that would make them frequent the Gerrard Bazaar more often. The second most popular answer was “Better visual appeal” followed by “More restaurants”. Among non-South Asians, the most popular answer was “Better visual appeal” followed by “More cultural events and festivals”. This suggests that South Asians and non-South Asians alike enjoy the festivities related to special events and festivals that transpire within the ethnic enclave. Current initiatives such as a facade improvement program, mural painting and capital projects initiated by the BIA have also been undertaken, yet the ethnic enclave is still not visually satisfying to the average visitor.

The majority of respondents said that goods and services offered within the Gerrard Bazaar “are the same” (27%) or “They are not as good” (26%) as those found in suburban areas. All age groups, except those “Over 60” answered that the goods and services found within the Gerrard Bazaar are “Not as good” or “They are the same” as those found elsewhere within the GTA. Those “Over 60” mostly stated that “They are better” or skipped the question. The majority of respondents of Bangaladeshi descent answered that South Asians goods found within the Gerrard Bazaar “are not as good” as compared to those found in the rest of the Greater Toronto Area. The majority of respondents of Indian and Pakistani descent, however, answered that “they are the same”, closely followed by “They are not as good”. The majority of non-South Asian respondents chose the “Prefer not to answer” option. These findings reinforce the fact that the South Asian market has picked up well in suburban areas and the goods and services within the Gerrard Bazaar are not something that would attract many people to the site. As such, there needs to be an emphasis on other programs that potentially promote gathering and celebration. The Gerrard Bazaar therefore must

Q9 How do the places that you visit within the Gerrard Bazaar compare to other South Asian amenities that you have utilized in other parts of the Greater Toronto - Hamilton Area?

Answered: 210 Skipped: 0

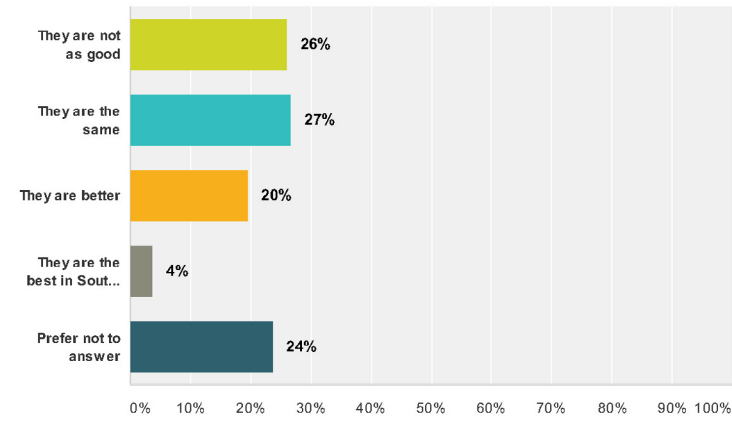


Fig 4.09: Survey - Summary Results - Question 9

exploit its other assets such as use of the street (for street festivals, one-stop shopping destination etc.).

“Yes” (71%) was the most popular answer when asked about keeping the Gerrard Bazaar alive and thriving. However, the number of respondents answering “Indifferent” increased with age group. When looking at the results by ethnicity, all ethnicities predominantly answered “Yes” to keeping the Gerrard Bazaar alive and thriving. As such, South Asians and non-South Asians alike are supportive of the Gerrard Bazaar and should therefore both be considered and acknowledged in its future.

The majority of respondents answered “Yes” (40%) and “Somewhat” (38%) when asked if they felt at home within the Gerrard Bazaar. The main reasons for this are “The cultural atmosphere” (60%) and the “Spoken language of the people” (39%). The majority of South Asian respondents felt this way mainly because of the “Cultural atmosphere” and “The spoken language of the people”. In contrast, the majority of non-South Asians selected this answer simply because they live or grew up in the area, feel a sense of belonging there, and enjoy the vibrant energy of the Bazaar. However, as age increased, the number of respondents answering “The events that happen” increased. As such, the Gerrard Bazaar is culturally associated with South Asians in many instances, but is also historically associated with non-South Asians, who are specifically familiar with the loci of the place.

The next question asked was related to the initiative undertaken by the BIA to design a South Asian cultural centre. It served as a potential option to investigate in order to reverse the decline of the strip. The four most popular programs that respondents answered, in terms of programs that they would visit for a cultural centre, include: “Cooking classes (Indo-Pakistani cuisine)” (45%), “Fashion shows and special events (e.g. South Asian bridal shows)” (44%), “Common gathering

Q10 The Gerrard Bazaar is undergoing major change. Many South Asian stores are declining and being replaced by non-South Asian retail. Do you think efforts should be made to keep the Gerrard Bazaar alive and thriving?

Answered: 210 Skipped: 0

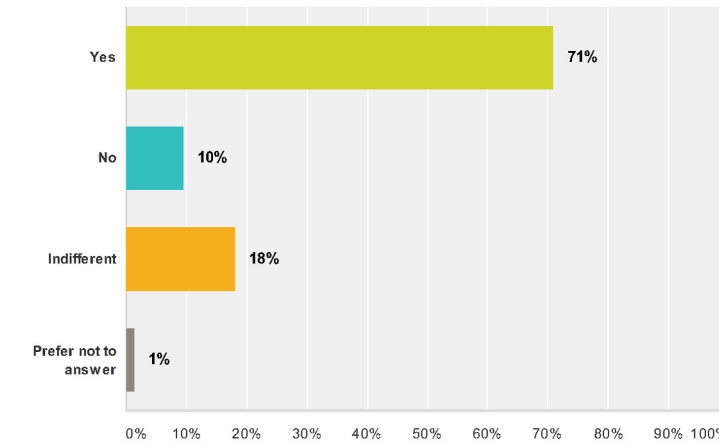


Fig 4.10: Survey - Summary Results - Question 10

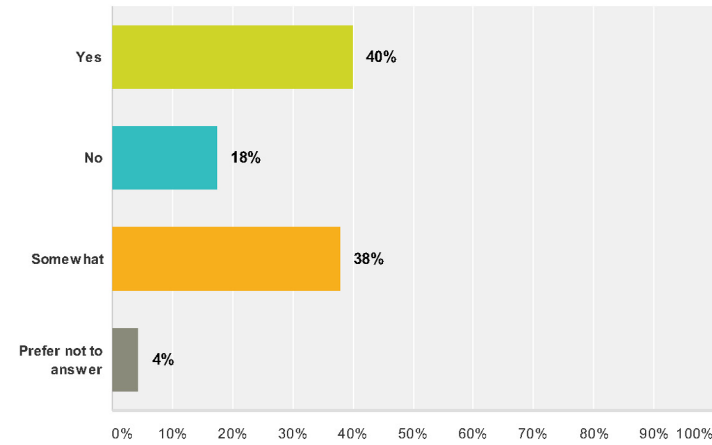
spaces” (43%) and “Art and South Asian dance workshops” (42%). The majority of respondents from the “16-24” and “25-33” categories answered that “Fashion shows and special events” within a South Asian cultural centre would make them visit the Gerrard Bazaar more often. Other popular answers included: “Art/South Asian dance workshops” and “Cooking classes”. There was a significant drop in the answer “Fashion shows and special events” as the age groups increased, yet there was an increase in the “Cooking classes” option. “Common gathering spaces” also remained a popular option among all age groups. Some non-South Asians answered that a South Asian cultural centre may be not be supportive since many South Asians do not reside within the area, nor would it be inclusive for other cultures. In addition, a number of South Asians stated that they would not travel to a cultural centre regardless of the amenities housed within it. In terms of ethnicity, “Fashion shows and special events” was the most popular answer among South Asian respondents, closely followed by “Common gathering spaces” and “Art/ South Asian dance workshops”. Among non-South Asians, the most popular answer choice was “Cooking classes (Indo-Pak cuisine). As such, many young South Asians would be attracted to cultural events and spectacle, or such activities that help them revive their South Asian roots.

Non-South Asians, on the other hand, like to learn and celebrate the culture so as to enrich their experience of living within a vibrant ethnic enclave. Generally speaking, a South Asian cultural centre does not seem to render interest for all respondents, and to some, would create a greater divide between the South Asian heritage of the area and the non-South Asians residing there. As such, the emphasis needs to be more on program as opposed to architecture.

The majority of respondents said that they “would be interested in volunteering” (35%) or that they “are not interested” (36%) in donating or volunteering for a South Asian cultural centre. Only 15

Q11 Do you feel “at home” when you visit Gerrard Bazaar?

Answered: 210 Skipped: 0



Q12 If answered “Yes” or “Somewhat” to the previous question, what makes you feel this way? (please select all that apply)

Answered: 210 Skipped: 0

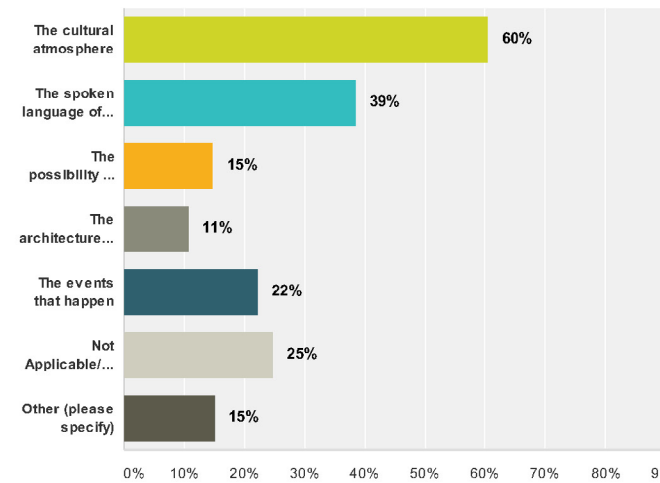


Fig 4.11: Survey - Summary Results - Question 11 - 12

respondents stated that they would be interested in donating. In terms of age groups, as age increased, the “I would be interested in volunteering” answer choice decreased, and the “Not interested” option choice increased. When analyzed in terms of ethnicity, the majority of Bangladeshi, Sri Lankan, Other South Asian and non-South Asian respondents answered that they were “Not interested” in either. On the other hand, the majority of Indian, Pakistani and Nepali respondents answered that they would be interested in volunteering. A significant number of non-South Asians (30%), however, answered that they would be interested in volunteering. This further suggests that non-South Asians are eager in partaking in South Asian cultural activities.

The majority of respondents answered “No” (55%) for being interested in social or co-operative housing, but “Yes” (62%) for visiting the Gerard bazaar for events that celebrate South Asian art and culture. This trend continued among different age groups and ethnicities.

Most respondents view the Gerrard Bazaar as “A small commercial street in Toronto with South Asian character” and “A South Asian retail destination for everyone”. Answers varied among different ethnicities when asked what the Gerrard Bazaar’s identity is, in their perspective. The most popular choice among Afghanis was “A tourist destination for everyone” (67%). The most popular choice for Bangladeshi and Indian respondents was “A South Asian retail destination for everyone” closely followed by “A South Asian retail destination for the local community”. The most common answer choice among Pakistani respondents was “A place where South Asians celebrate their unity”; closely followed by “A South Asian retail destination for everyone” and “A tourist destination for everyone”. The 2 answers for Sri Lankans were “A South Asian retail destination for everyone” and “A small commercial street in Toronto with South Asian character”, suggesting that Sri Lankans associate less with Gerrard Street than the others. These answer choices were also popular among Other South Asian respondents. Among non-

Q13 The thought is that a South Asian cultural centre may be an option for the Gerrard Bazaar. If such a building was built, what facilities/ amenities would encourage you to visit on a regular basis? (Please select all that apply)

Answered: 210 Skipped: 0

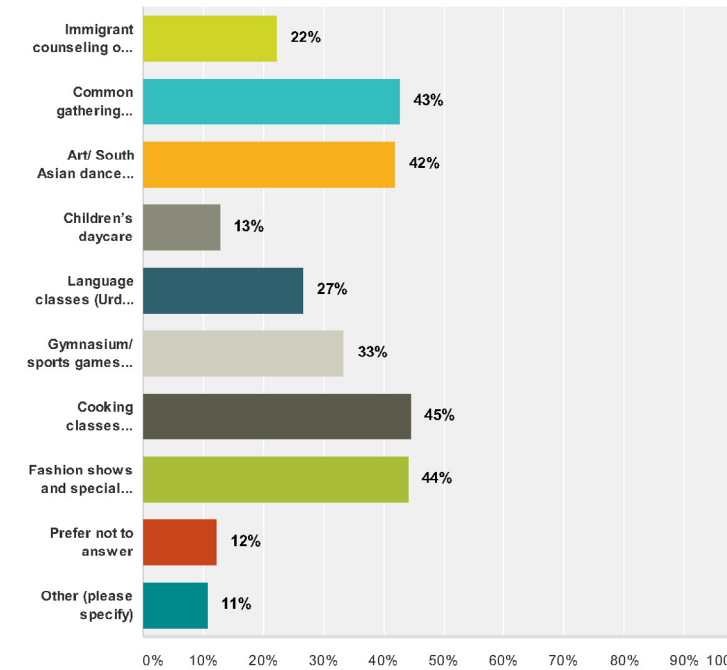


Fig 4.12: Survey - Summary Results - Question 13

South Asians, the vast majority answered “A small commercial street in Toronto with South Asian character” (81%), followed by “A South Asian retail destination for everyone” (53%). In terms of age, the most common answers for younger age groups (16-24, 25-33) were, “A South Asian retail destination for everyone” and “A place where South Asians celebrate their unity”. While the older age groups (34-42, 43-51) commonly answered “A South Asian retail destination for everyone” and “A small commercial street in Toronto with South Asian character”.

The majority of respondents answered that “Cultural celebrations” are the most important aspect of their culture to maintain. This was closely followed by “Language” and “Cultural expression through clothing, art etc.”. Majority of respondents aged “16-24” answered “Cultural celebrations” and “Language” as the most important part of their culture to maintain. Respondents from the “25-33” and “34-42” category answered “Cultural celebrations” and “Cultural expression through clothing, art etc.” as their most popular choices. “Cultural celebrations” was also the popular choice among those from the “43-51” and “52-60” age categories. However, in the “Above 60” category, “Cultural Celebrations” and “Language” became clear popular answer choices once again. Among all South Asian respondents, “Cultural celebrations”, “Language” and “Cultural expression” were the most popular choices, closely followed by “Religion”. Among non-South Asian respondents, the most popular answer was “I believe in fully integrating myself in Canadian society” (32%) followed by “Cultural celebrations” (26%), and “A little bit of everything; nothing too specific” (25%).

Other comments given by respondents lean towards the same concept – that the Gerrard Bazaar is a valuable destination but needs to be visually revived and preserve its heritage in one way or another. Gentrification is causing gradual change along the strip but this needs to occur so as to stimulate the strip’s economy. As one respondent stated:

Q14 If such a cultural centre was built, would you be willing to engage in voluntary work for any of the services/ amenities or provide a substantial donation?

Answered: 210 Skipped: 0

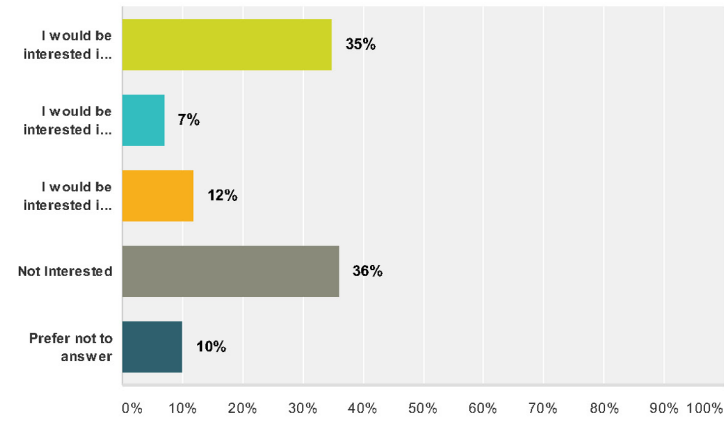


Fig 4.13: Survey - Summary Results - Question 14

"I think established South Asian businesses that do what they do well, will thrive. Unfortunately the area will continue to gentrify and opening new businesses specifically aimed at ONLY the South Asian market is doomed to fail. Better to focus on current successes and perhaps play up its historical significance to retain the character of the neighbourhood. But non-South Asian businesses NEED to be allowed to open if you want to halt the area's decline".

There is a significant mention of parking issues, urban vacancy and pigeon-feeding that all contribute to the strip's issues. Numerous participants also talked about inclusivity and how it can be beneficial for the Gerrard Bazaar. One respondent stated:

"I think they do a good job, but need to also represent the non-South Asian aspects of the community as there are less South Asians living here. We need to combine the cultures without gentrification. Keep the cultural aspects of South Asia but also incorporate Western culture. Rang is a great example: Indian home and decor accents. Flying Pony Cafe is another: western coffee shop with art for sale on the inside, but the outside is colourful fits in with the traditional South Asian stores".

Another respondent wrote:

"I think they are doing a great job of supporting the South Asian identity. They just need to modernize and clean up some of the storefronts. It would also help if some of the stores spoke English and more welcoming to non-South Asians. Make it more inclusive rather than exclusive. Don't assume people know about your culture. Be welcoming and engaging when SHARING and TEACHING others about the South Asian Culture. Embrace those who want to learn. Don't assume people are against you. Be nice!"

Q15 If there was some form of social or co-operative housing within the Gerrard Bazaar, for students, retirees, employees of the Gerrard Bazaar retail strip, or new immigrants, would you be interested in living there?

Answered: 210 Skipped: 0

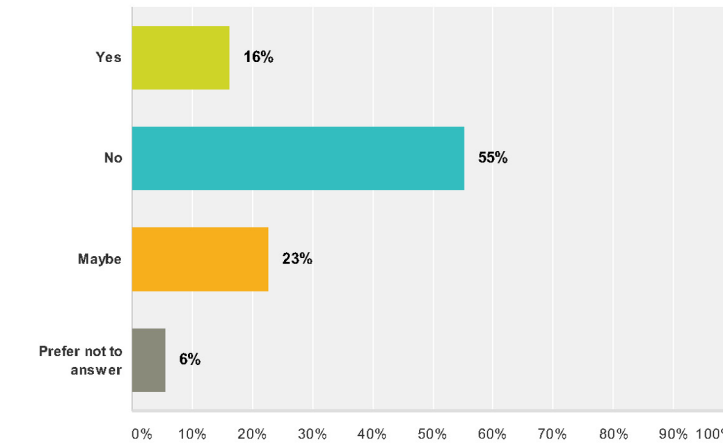


Fig 4.14: Survey - Summary Results - Question 15

This gentrification, however, is resulting in an increase in property prices which is causing harm to some business owners. One respondent stated:

"I live in the suburbs...I had a restaurant in my property that I ran for four years and they used to pick up my garbage...now the restaurant people pay extra for people to throw their garbage....the Gerrard Bazaar is a bit neglected ...I pay \$1000 per month now for my property and before, 10 years ago, it was around \$500...expense is a big reason for people leaving stores...it's hard to afford it....a lot of stores open late...12 -10pm....a lot of stores are closed on Monday....this is a residential area and local people come for shopping. Before people came from all over the place because only here, you found South Asian stores."

As a part of the survey, the first 3 digits of all participants' postal code

Q16 If art exhibits and events that celebrated South Asian art took place within the Gerrard Bazaar from time-to-time, would you be interested in attending or participating in them?

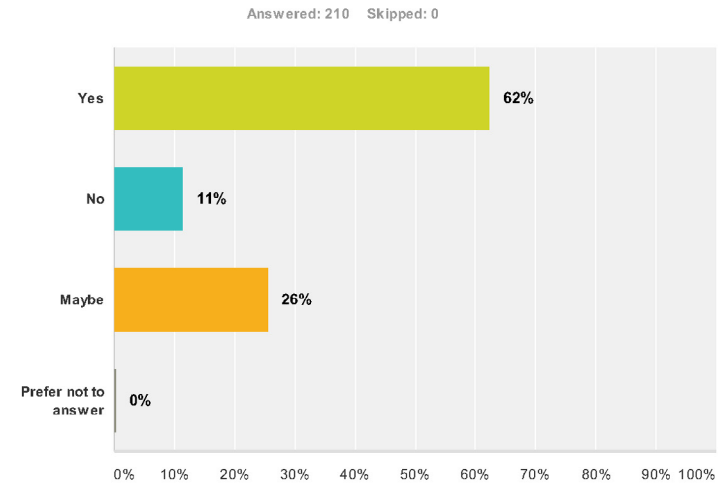


Fig 4.15: Survey - Summary Results - Question 16

Q17 What do you see the identity of the Gerrard Bazaar as? (Please select all that apply)

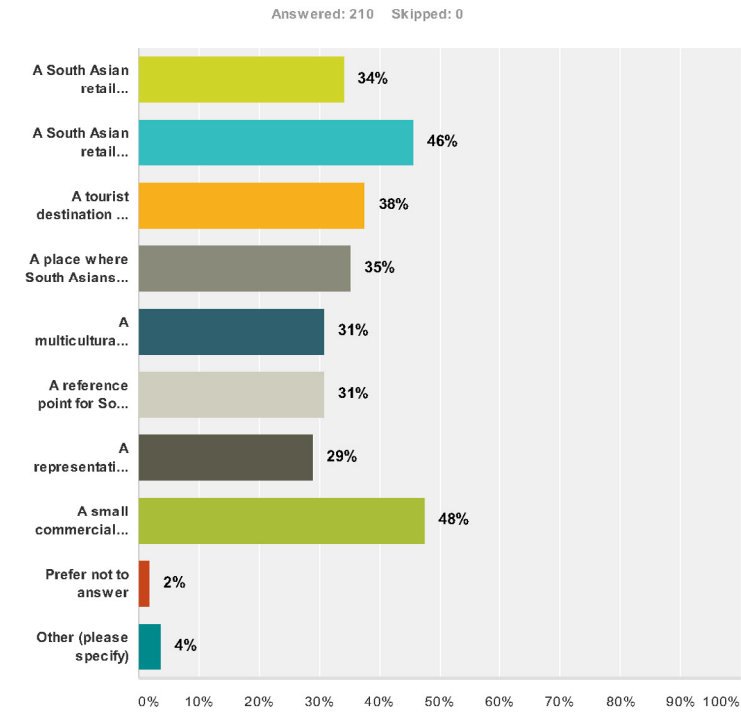


Fig 4.16: Survey - Summary Results - Question 17

Q18 What aspects of your culture are most important for you to keep/ practice? (Please select all that apply)

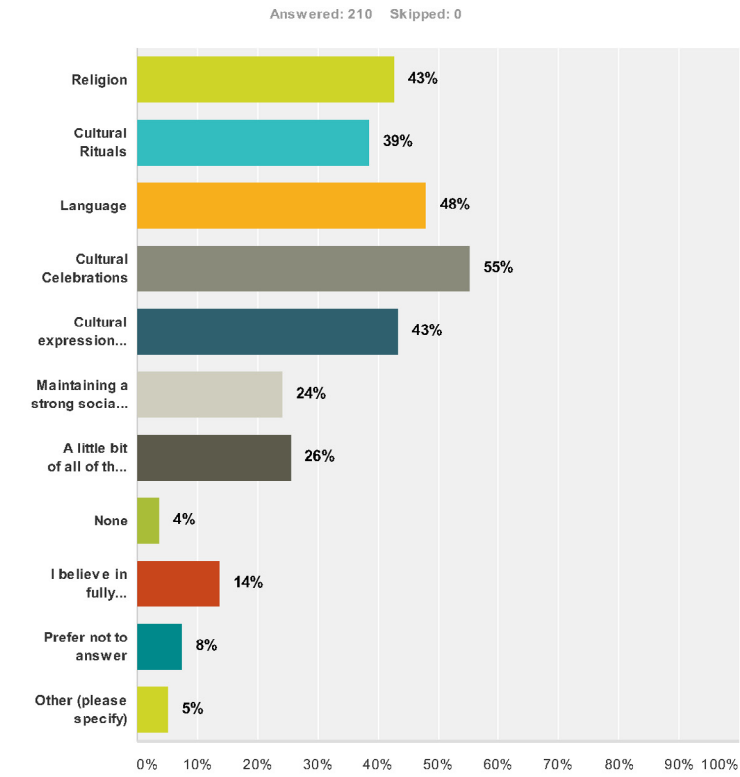


Fig 4.17: Survey - Summary Results - Question 18

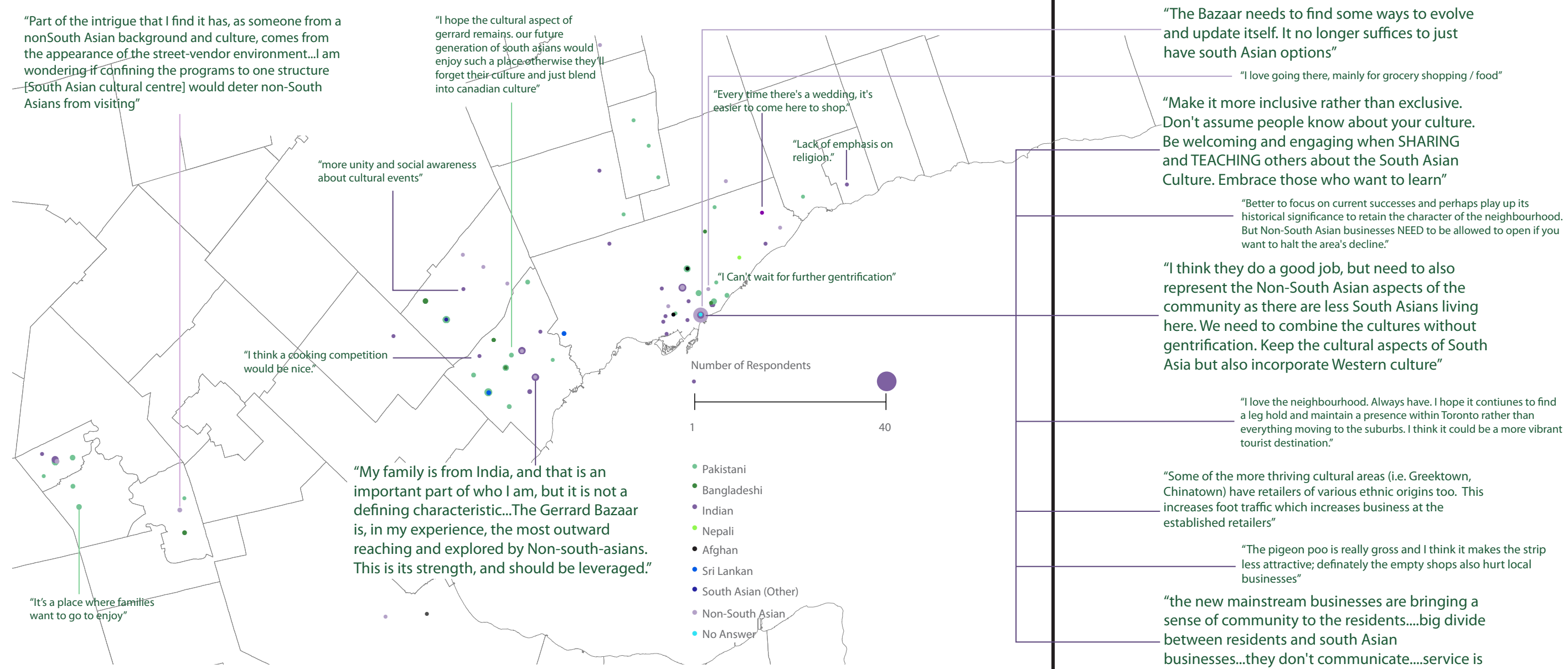


Fig 4.18: Map of survey respondents

4.3 Respondent Mapping Analysis

was collected in order to map the respondents in terms of their ethnicity and location (Figure 4.18).

The majority of non-South Asian respondents were located within the neighbourhood while the majority of South Asian respondents were dispersed within various regions. This further reflects the demographics of the Gerrard Bazaar in relation to the suburbs.

Important statements made by anonymous respondents are depicted in order to further illustrate how one's location and ethnicity relate to their perception of the Gerrard bazaar, amount of times they visit the site, reason to go there, programs that would attract them to go there, aspects they dislike, and idea of culture.

Findings show that many respondents admire and appreciate the Gerrard Bazaar and would like it to retain its South Asian character, yet be more inclusive. In addition, the farther away the respondents were, the more likely they were to visit less and view the bazaar as an exciting place to visit. As the respondent got closer and closer to the site, they were either supporting gentrification, inclusion, or the need for the bazaar to cater to non-South Asians as well.

In terms of the design proposal, this indicates that it must house programs that serves as an attraction for South Asians visitors, or at least promotes spectacle, while fulfilling the daily or weekly needs and desires of the residents.

Interview Type #1

4.4 Personal Interviews and Analysis

There were two types of interviews conducted for this study. The first one was for various storeowners that were willing to participate and available for the interview. The second one was for key organizations or “key entities”. Once again, interviews conducted with these organizations were based on their availability and willingness to participate.

The following quotations are key statements made by interviewees that reflect important aspects of their business and their perception of the bazaar.

“My in-laws [were] living here before and they came here. And they already have [a] business here. I wanted to join them. We feel comfortable here, that’s because it’s an Indian area and we are Indians too. And we feel comfortable here [be]cause all people here, they like they are Indians mostly. And we feel comfortable.”

“Like I have 40% Canadian people here. And I have lots of clients, they come when they start the business that time to now. And some clients have come from Scarborough. When they come to Gerrard Street, they come to me to see me here.”

- South Asian salon owner

“Well, clients has changed of course. We get a lot of Indians have went to Brampton, right, or Mississauga. And then merchandise has changed, designs, stuff like that has changed. As profitability has declined because if you notice in our industry there is less business cause obviously most people have went Brampton, Mississauga, opened stores there, locations. So, you know, the Brampton customers now won't come here obviously cause there's so many jewellery stores there”

“my brothers have went, moved to Brampton, I'm still in Toronto. But I'm going to open another business and possibility of doing both. I'll still be here in Toronto”

- South Asian specialty store owner

“But often times people say oh, you know, Gerrard Street is not the same anymore. Why are you gonna spend all this money into here? Well, if you keep going with that philosophy and that thinking that it's not the same and we don't do anything about it, you're just gonna give more fuel to the fire”

“Right now, downtown has become a really expensive place for a lot of people to live, right. Rents have gone really high; property values have gone really high and it's easy for a new immigrant to be able to afford to live down in this area...So I think if there was a socio demographic area set up here in Little India specifically for South Asian housing for example, I think the area would have huge immense benefits for that.”

“People who live in Mississauga and Brampton. But if we had a reason to draw people in, for example, a cultural center, it would just get people into the area. Even if they're just coming in for a cultural gathering or a social cultural gathering or social event...they're still roaming the streets and popping into stores. And even if they're not buying, i'm sure a store that they didn't know existed, for example, our store, is on their radar now”

- South Asian clothier

"I got the opportunity to open up a small place because people, my friends have all that time, I used to cook at home for them for small parties...And so that was just playing my art at that time and they decided,they said why don't you open up a place... Because there was a theatre up here."

"It is like, not many people are coming out on Gerrard Street and it is hurting businesses like me. And there is no way of promoting my business or reaching out to those people until I'm in the media or some kind of newspaper or somebody writes a review about Gerrard Street or promote it"

"So plus our kids and all today, they don't want to go down to old shabby Indian grocery store or old shabby restaurant or so. They want something that would be very clean, good looking, appropriate service, not mom and pop operation or so here"

- South Asian restaurant owner

"We are not planning [our retirement]. I just want my children to be well educated first and they will want to go their own way, whatever they like. Otherwise, I'm there."

"now everything is spread out. Like before, this was the oldest bazaar of South Asian people, right. Now everything is spread out to Scarborough, Markham, even Brampton and Mississauga, right. So everybody has to pull their own weight outside this area. That's why there's also the reason that the businesses here are declining for the last couple of years"

- South Asian specialty store owner

“Yeah, I’m on the board of the BIA. Again anecdotally there’s not many young members who want to take over their parents’ business. And a lot of the older members are getting, hitting retirement age”

“But to be fair, I had a lot of, I’ve had a lot of support from a lot of shop owners that come...The funniest one was I remember when we just opened he came in and he was a south Asian man and he came in and he says why are you opening an art gallery here, south Asian people don’t buy art. Like wow.”

“...there’s huge competition for festivals. So I think it’s good but again I would like to see them try to reinvent it and use the good elements from the rich culture, from all the south Asian diaspora and how that reflects on living in the not so rich culture that’s Canadian, mixing it up a bit. ”

- non-South cafe owner

“I live two blocks away and it needed [this kind of store] and that’s the kind of store I wanted open”

“when I first moved onto my street I had a lot of East Indian neighbours and they’ve now all moved to Brampton, so Little India is slowly but surely shrinking. The stores are changing because the demographics of the actual residential neighbourhood has changed drastically in the last few years”

“I mean we already have, the BIA here already supports different cultural events within the area. So, would more help? I think we probably have our share of them already. I think two or three a year happen right on the street. They close it down and it’s a big day for it”

- non-South Asian specialty store owner

"I find it's very interesting what's going on culturally right now...as much as we've tried to reach out to the Indian community, we don't get a lot of people coming to our events...So I don't really know what that would provide, besides the festivals and the events that go on inside the library and the IndianBazaar...So, it's a very complex situation that I don't think can be answered by putting up a community centre."

"I've been seeing a decline in the neighbourhood since I moved here. It's been revitalized by new coffee shops and my [business] and different events at the library...I've heard from the locals that people don't come to the Sari shops because there's no parking. Parking is a huge issue. They go to the suburbs.... It is very complicated...because you're dealing with people. Everyone has a different agenda and everyone has a different experience.It's a very odd neighbourhood with a lot of mixed races and classes...A lot of Indians are selling their buildings and Indians are not buying them. So that's another thing, you know? It's a complicated issue here. It's not one group moving in and pushing people out... there's some tension and I think it just comes from change"

- non-South Asian specialty store owner

"It's changed from the perspective that when I started, this was the only market that was available to the East Indian community or South Asian community. And as the years went by, different communities started building up in Scarborough and Brampton, so we have a lot of East Indians...Indian stores all over the place now so the whole market is now split up. It's much bigger also. I think we've got a lot more East Indians or South Asians here than when I started it"

"So the market has become much bigger but it's fragmented now. It's all over the place. So this is not just the main focus attraction for salvation... So what my strategy has been to introduce the more rare products which the main stream people wouldn't even know about it, so specialize in, it includes a lot of variety and increase our customer service so we can compete with Loblaws and all [those kinds of stores]"

"So in all likelihood, I'll probably be selling [the business]. I don't see it being passed on to my son or any of my relatives"

- South Asian specialty store owner

"I would say our business has been continuously picking up and growing. First we were in a small location somewhere on the same strip. And then after a few years we moved to a bigger, more open store. And business wise it's been growing and our income, obviously revenues grew...just for the last year or two we've been noticing that the market has become saturated, so a lot of Indian restaurants now that specialize in the exact same thing, we're seeing even just a lot of traffic is also going down now that there's...If you go like five, six blocks then you hit the Greek town. If you go like five, 10 minutes commute westward you'll see Chinatown, so other markets nearby"

"...whenever we have our annual festival or any special event we have noticed like the Canadian, North American community would come out and it's a blend of clientele that show up. They all want to take part in it, want to taste the food, want to learn something new about whatever culture"

"People did come over, paint and did murals all over the walls. It was very South Asian style and I believe it had very positive feedback from the neighbourhood as well, which consists of both, again, Caucasians, South Asians"

- South Asian cafe owner

"I think there is a definite room for modern well-constructed but new cooperative social type...There are a lot of shabby, I guess for lack of a better word, flop houses in this area which is changing to a degree through the facts that a lot of the houses are put up for sale, or half million dollar homes and mostly middle class families, start up families are moving in so could definitely use more condominiums as well"

"... there's been so much migration to Brampton and other areas where there are other large ethnically South Asia in communities. So there's not as many local South Asian families living here frankly as much and less a lot of them aren't coming to support the businesses. So I think [a South Asian cultural centre] would be a great idea in one sense as part of its heritage but whether or not it would be sustainable for the number of people that now come here to shop, I think that's a difficult question"

- non-South Asian specialty store owner

"We were just two blocks east, since 1994, I would say. At this location, we are since 1998.

"Like, 70 percent to 75 percent of my clients are mainstream white Canadian. And others are West Indians, Sri Lankans and a few Indian"

"The clientele has remained the same but I think there are more stores in the suburbs and also here in the Gerrard Bazaar, there's more competition. So, naturally, the business does get divided"

- South Asian specialty store owner

"Initially, we were having English language classes for seniors and then we started sister-to-sister movement where women are come together, they cook together, they do a fashion show, dancing, eating...doing so many things together...and often we are doing the cultural events like our events, the prayers. Sometimes we celebrate Independence Day. So we are doing all these types of events where we are inviting all of the community to give them an activity and to engage them in the community"

"Basically, mostly, we do cultural events because we are very behind in doing cultural stuff in this area...So we always welcome all other cultures... whoever wants to participate with us, it's wonderful"

"We are working together. Recently, we have done multi-faith cricket match. And before this we have done, many times, multi-faith walks where we visited one another's religious places and we shared food and culture together. So are very well connected"

- South Asian key organization

"I just like to live independently. And, like, we have more customers in the Gerrard India Bazaar"

"I love this neighbourhood because I have started living in this neighbourhood"

"[Clients] are South Asian... they come [from] all over"

- South Asian specialty store owner

"Well, we used to deal with, like, specific clients...this market was based on West Indian, Sri Lankan people, and people like Indian, Pakistanis but now we're dealing with mostly Pakistanis, Bengalis, Afghanis, like, all mixed communities are coming now. And lots of Canadian people, like, white people... lots of people come from Mississauga, Scarborough, Brampton, Hamilton"

"This business is here since 1990... we were in the same location, like, one store down, so we moved into a bigger one."

"When I'm retired I'm going to maybe close down or just stay home...I'm not going to let my children take over"

- South Asian clothier

"I guess...if in some way the space can be engaged with in a way that isn't just about the mostly commercial space that it is now. People who have an interest in urbanism and peoples histories and the re-emerging popularity of things...where people do want to do urban tours. I think with Gerard India Bazaar...if there was anything that engaged with those histories, it might help bring people into that space...to me at least, that's my personal perspective. We used to go there in the 90's, because it was an area inside Toronto where you could get the best food, the best groceries, everything was very reasonably priced and now it's increasing and those areas have moved further out of the city"

"Often we've been told that when artists come to us that it's a space in which represents diversity within the South Asian community in terms of it encompassing people who have immigrated here or people who have grown up here but just people who have a common set of experiences and creative concern. Even through our programming, sometimes people will come and have an interest in telling a particular story and will see work by an experimental video artist that covers identity based themes, themes of migration and themes of home"

- South Asian key organization

"Within reason...The South Asian Festival really needs to take a whole new spin and be more inclusive to everybody because the neighbourhood is changing and there isn't anything for neighbourhood children to participate in, it's too skewed to just being South Asian...It's that places like Little Greek Town, it's still known for being Little Greek Town but there's other things going on and that's the only way, and if you talk to a lot of the old timers, they get it too, the only way that this strip is going to survive is if we embrace everybody and have the South Asian flair and a mix of other things"

"Like they've asked restaurants to do cooking show nights where people can come pay to come and learn how to make two or three traditional dishes and all sit down and eat them. The neighbourhood really wants to embrace that idea...We had the Sikh Festival last year. It wasn't held this year. Nobody even knew about it. And yet it's all a harvest festival about food which this community is huge about around here and we could've done a spin on a more North American style market but with all the information as to why -- I forget the name of it but why that festival was happening and the cultural roots related to the Sikh community. But we don't do that stuff. We do a sidewalk sale and people sell clothes and that's it"

- non-South Asian specialty store owner

"I would say about 50% [of my clients] are First Nation from all over the GTA and about 30% are of European descent living within four blocks"

"How has [my business] changed? It has just become better...it grew. Probably double"

- non-South Asian specialty store owner

"I just love the area, the community feel"

"The cost of all the houses around have doubled since I've been here at least"

- non-South Asian specialty store owner

“I’ve got good reviews in some Japanese newspaper, some Bulgarian news magazine. So you know I will get those clientele too”

“Well mainly [peak time is] on the weekend but when the weather gets better I would say from April to November you get a good amount of clientele over here. And soon after Halloween people start going more into malls, you know, for shopping so that is a time which declines over here. And the Christmas holiday is one, Christmas holiday again this place gets busy and then it goes down after January 1st...Then again after March break it picks up.”

“All of [my children] might think we’re too small so I don’t know whether they would want to take over the business...when I am thinking of retiring I would ask the staff if they want to run it for me”

- South Asian restaurant owner

4.5 Personal Input Analysis in Relation to Design

It is evident from the interviews that most store owners and operators interviewed reside within or close by to the Gerrard Bazaar, regardless of their ethnicity.

In most instances, the South Asian business owners opened up their store within the ethnic enclave when it was prospering, this served as a means for them to establish themselves within the country as well as network with those from the same culture. Most of these businesses also do not envision their children taking over, as they would like them to receive a prestigious higher education. On the other hand, most non-South Asians interviewed opened up their enterprises within the past few years, given the changing demography and demand. This would also explain why many South Asian business interviewed stated that their business has declined, while many new mainstream shops have experienced growth.

In terms of clients, all of the South Asian businesses interviewed reported having clients from all across the GTA, with varying degrees of local clients and those from the suburbs. Almost all of the non-South Asian businesses stated having local clients in most cases. In addition, many South Asian businesses reported having peak times during key holidays or on weekends, as opposed to during the week, as stated by many non-South Asian businesses.

Considering the presence of South Asian markets within suburban regions, the ethnic businesses within the bazaar have naturally faced slight decline. However, many of these businesses are steadily operating due to an established client base. For instance, one South Asian store reported facing slight decline for the past 14 years. On the other hand, almost all non-South Asian businesses within the enclave are experiencing growth.

within the enclave are experiencing growth.

In several instances, the store owners interviewed have re-located along the strip into a larger and better space - once again signifying how iconic architecture plays a role in the way a store grows and markets itself. One storeowner stated having three different types of restaurants along the strip during its earlier years. This suggests that, similar to how specific stores within the Gerrard Bazaar have innovated in terms of their program and architecture, some stores have also changed in terms of size and location, suggesting that stores have continued to go through different dynamics in order to re-invent themselves and remain attractive sources for goods and services within the ever-changing South Asian and mainstream market. In addition, some stores mentioned their publicity within newspapers, which is also another marketing tactic utilized. One of the stores interviewed mentioned that they had good reviews in multi-national newspapers which helped them market their business and make it stand out from the others. In the instance where the business is family-run and second, Canadian-educated, generations are willing to take charge of the business once their elders retire, the business has innovated or grown. For example, a fashion clothing store has been continuously expanding to accommodate more goods and programs, and this has been possible with the owner's son now running the business and applying his business expertise.

General comments made by storeowners reflected some interesting patterns. Some South Asian stores are ambitious in innovating and remaining successful within the market and have, as such, continuously injected capital within their business to keep it afloat. Other businesses have accepted the change and continue to run their business as is. Several non-South Asian businesses owners interviewed emphasized the notion of inclusivity in making the Gerrard Bazaar a more successful retail strip. One store

owner stated that there needs to be a keen interest among both South Asians and non-South Asians in learning about each others' cultures and accepting the co-existence of both cultures within the area. Almost all of the storeowners interviewed supported the idea of South Asian cultural events that promote and display the vibrant culture so long as they are inclusive to everyone.

This, once again, reinforces Qadeer's opinion on how ethnic enclaves need to be inclusive and promote social cohesion so as to foster a healthy sense of community. This also reinforces the design approach, which is to promote cultural exchange.

5. DESIGN INTERVENTIONS AND CULTURAL EXCHANGE|

5.1 Research Analysis and Design Direction

5.2 Precedents

5.3 Networks & Siting

5.4 Designing for Cultural Exchange

5.5 Potential for Implementation

Endnotes



Fig 5.01: Diversity within the Gerrard Bazaar

5.1 Research Analysis and Design Direction

After analysis of all interviews, surveys and key architectural elements within the Gerrard Bazaar, it is evident that the area has undergone ample change and continues to do so. Currently, the bazaar serves as an interface between the South Asian retail and the non-South Asian residents. South Asians visit the ethnic enclave occasionally, while many non-South Asian residents visit it on a regular basis. Both ethnic groups alike utilize and appreciate the presence of the Gerrard bazaar, however, it does not serve South Asians or the nearby community in the same way it used to.

Investigation of the demographic and historic information of the Gerrard Bazaar sheds light on the underlying dynamics of the site as well as historic precedents that could serve as inspiration for the design intervention(s):

1. The Naaz Theatre acted as the primary catalyst within the Gerrard Bazaar for it acted as a hub for South Asians. The design needs to have this effect on the ethnic enclave but promote cultural exchange and not be exclusive to one ethnic group.
2. Other catalysts that promoted a sense of community and stimulated gatherings included the library and Islamic centre. These can serve as inspiration for the design intervention or be integrated into it.
3. Demographic change is a natural part of the evolution of the site and the design proposal must acknowledge it, as opposed to counteract it.

The architectural and spatial characteristics of the Gerrard Bazaar reveal certain interesting techniques utilized by various merchants in order to better market their business, respond to the changing demographics of the bazaar and promote gathering.

1. Some stores have diversified their program so that their business not only operates as a shop, but also as a place that promotes social cohesion. This notion of multiplicity is essential to consider for design proposal in order that it responds to a diverse group of people with different agendas and interests.
2. Stores that are generally larger and have placed an emphasis on the architectural design of their building tend to accommodate more programs and attract larger crowds. Examples of these would be Chandan Fashion and Lahore Tikka House.
3. Businesses or organizations that have a combination of functional and flexible space, or functional and gathering space, or all three, are in most instances, ones that operate better within the retail strip.

The survey and interview findings are essential as they open up a whole new personal perspective of the site and enable the design to be more thoughtful and considerate towards the needs and desires of major user groups. Moreover, they give a clear indication of how diverse the opinions, thoughts and experiences of different visitors and inhabitants of the ethnic enclave, are. After this important method was undertaken, the following was synthesized from the analysis:

1. Both ethnic groups alike utilize and appreciate the presence of the Gerrard bazaar, however, non-South Asians are looking for a more inclusive environment while South Asians are more about preserving the South Asian heritage and innovating to succeed within the declining economy of the strip.
2. Many people want to see the Gerrard Bazaar as a place where South Asian culture and heritage is shared and taught, in order to preserve its identity, yet respond to the demographic change surrounding it



Fig 5.02: People lining up for food

3. The neighbourhood is a very expensive place to live and work for many. As such, a significant number of people would consider living in social housing.

According to these findings:

- The design intervention needs to cater to the frequently visiting non-South Asian and the occasionally visiting South Asian – but must also try to attract South Asians to visit more
- The design intervention needs to allow for cultural engagement and inclusion where non-South Asian residents can learn more about South Asian culture and enrich their daily lives as residents within the enclave; while the culture is promoted and prevalent in symbolic, architectural and other forms
- The design intervention should reinforce the locus of the place, as a vibrant and lively neighbourhood for residents and a nostalgic destination for South Asians
- The design intervention needs to acknowledge the demographic change within the neighbourhood and respond to it in a positive manner
- The design intervention should not be confined to a building or ethnicity; it should be more open, welcome, and dispersed yet interconnected
- The design intervention needs to create spectacle, make temporal moments a part of the architecture (as this is the ethnic enclave's strength), have a robust program, and facilitate it in multiple ways

Given the aforementioned conclusions:

There needs to be more INTEGRATION within the Gerrard Bazaar, which would be possible by newly formed NETWORKS; such networks that allow for CULTURAL EXCHANGE and ENGAGEMENT. This approach would need to reinforce the South Asian identity of the ethnic enclave, yet respond to the changing demographics of the region by being inclusive.

The design question then becomes,

How can architecture or urban design be the capstone to this method of facilitating new networks for cultural exchange?

As seen in Figure 5.05, the 3 proposed design interventions are carefully derived from the three analytical methods utilized: demographic and historic analysis, architectural and spatial analysis and human research. Based on what is observed, possible programs that could promote social gathering and thus, cultural exchange, include South Asian workshops and art exhibits, public gathering space and affordable residential units. The needs of each of these programs are different, As such, three different design strategies are adopted that not only respond directly to the site conditions but also optimize the current and proposed programs.

Given that the proposed design interventions will be in the form of Public Architecture and Urban Design or Residential Architecture, the initial kinds of precedents examined include South Asian vernacular buildings and public spaces.

Other precedents examined include those that place an emphasis on public spaces and gathering, urban regeneration, and inter-cultural connectivity were given great consideration.

ANALYTICAL CONCLUSIONS

Both ethnic groups alike utilize and appreciate the presence of the Gerrard bazaar, however, non-South Asians are looking for the culture and heritage to be shared and taught, while South Asians are more about preserving the heritage and innovating to succeed within the declining economy of the strip

The Gerrard Bazaar's strength is its transient moments of cultural engagement or spectacle, suggesting that cultural events which engage everyone are its greatest asset

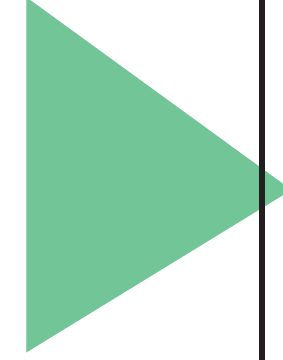
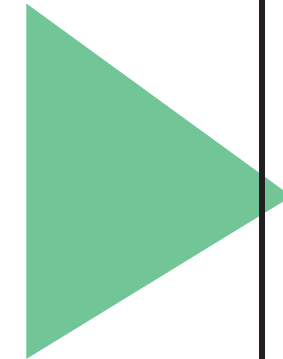
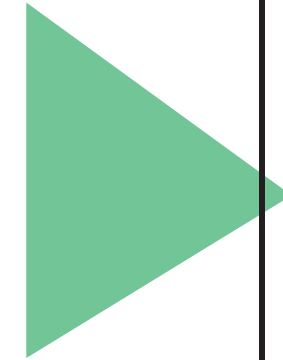
The neighbourhood is a very expensive place to live and work for many. As such, a significant number of people would consider living in social housing.

PROGRAM NEEDS

Need a program that caters to the frequently visiting non-South Asian and the occasionally visiting South Asian – but must also try to attract South Asians to visit more, particularly the younger generation

Need a program that allows for cultural engagement and inclusion where non-South Asian residents can learn more about South Asian culture and enrich their daily lives as residents within the enclave; while the culture is promoted and prevalent in symbolic, architectural and other forms

Need a program that injects a South Asian populous within the area and provides affordable housing as well as community spaces.



POSSIBLE PROGRAMS

South Asian workshops

South Asian art exhibits

Flexible space

Public gathering space

Open public plaza

Affordable residential

Seniors home

DESIGN STRATEGY

ADAPTIVE RE-USE

A vacant building that can house these programs and that is in close proximity to key entities.

RE-ACTIVATION

An exterior space that interfaces with a diverse range of programs/ entities that are South Asian and non-South Asian

RE-IMAGINE

A large open site, that is situated in a more residential zone

PUBLIC ARCHITECTURE/
URBAN DESIGN

RESIDENTIAL ARCHITECTURE

Fig 5.03: Determining design interventions from conclusions - diagram

3.2 Precedents

After analyzing all of these precedents (apart from those which are vernacular), several architectural and design maneuvers are apparent (Figure 5.04) - these maneuvers allow the designs to operate successfully as spaces of gathering, interaction and exchange - thus having the potential to promote cultural exchange. It is these maneuvers that will ultimately be utilized within the final design interventions.

These five maneuvers are:

Flexibility in design/ architecture - The design employs flexible components that can allow for variations in programs and promote different types of gathering.

Elements of repose - The design incorporates elements of repose that promote gathering and social interaction

Re-surface/ manipulated ground plane - The ground plane is specially surfaced or designed so as to accommodate a diverse range of programs and facilitate gatherings of people for events

Occupiable thresholds - The design has various niches, thresholds and interstitial spaces that serve as occupiable spaces for specific programs and events

Courtyard/ central gathering space - The design has a primary gathering space that is central, large and serves as the key area of spectacle

As such, each of the precedents studied serve as vital sources of information and inspiration and are undoubtedly valuable to explore before initiating the design phase of this thesis.

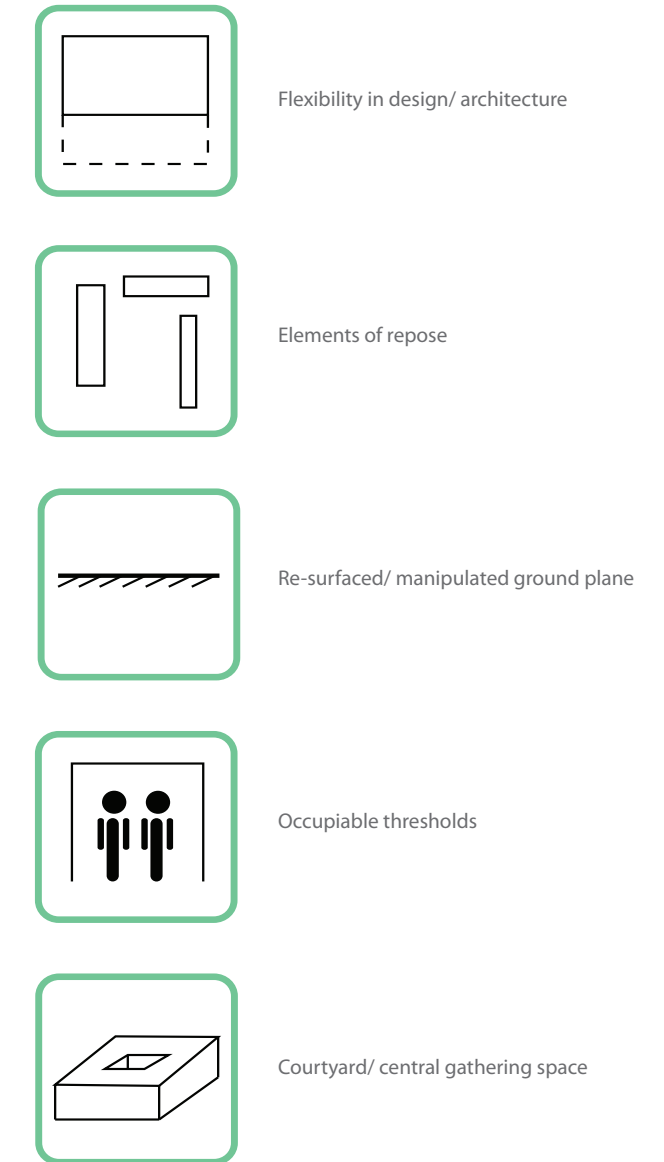


Fig 5.04: Architectural/ design maneuvers

Grid/ Rectangular
Geometry



Fig 5.05a: Mughal Gardens - India



Fig 5.05b: Bin Qasim Park - Pakistan



Fig 5.05c: Minar-e-Pakistan Park - Pakistan

Fig 5.05: South Asian Vernacular Urban Design

Fabric Shading
Device



Fig 5.05d: Sunday Bazaar - Pakistan



Fig 5.05e: Garden Bazaar - India



Fig 5.05f: Clifton Bazaar - Pakistan

Stairs



Fig 5.05g: Ganga River - India



Fig 5.05h: Sea View Beach - Pakistan



Fig 5.05i: Badshahi Mosque - Pakistan

Procession



Fig 5.06a: Ruwanwelisaya - Sri Lanka



Fig 5.06b: Quaid-e-Azam Mausoleum - Pakistan



Fig 5.06c: Taj Mahal - India

Fig 5.06: South Asian Vernacular Architecture

"Jaali" Wall/ Screen



Fig 5.06d: Lahore Fort - Pakistan

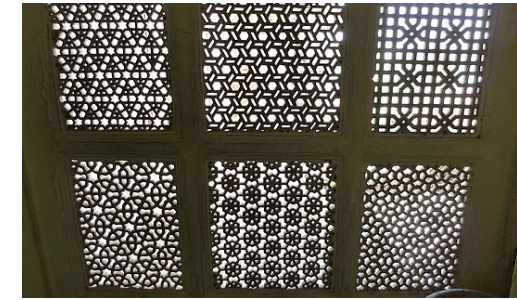


Fig 5.06e: City Palace - India

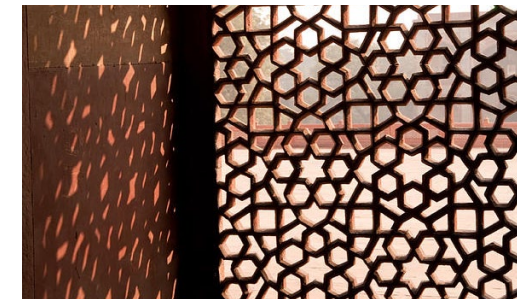


Fig 5.06f: Humayun's Tomb - India

Courtyard/Terrace



Fig 5.06g: Traditional Courtyard House - India



Fig 5.06h: Traditional Courtyard House - India



Fig 5.06i: Traditional Courtyard House - India



Fig 5.07: China Gate in Vancouver's Chinatown



Fig 5.08: Dragons in Vancouver's Chinatown

The Chinatown Revitalization Project

Location: Vancouver, Canada

Architect/ Designer: Chinatown Millennium Society

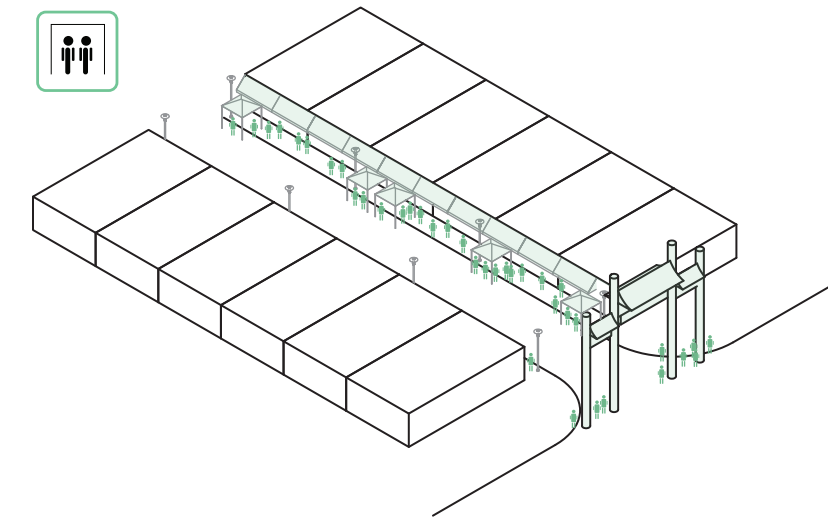
The Chinatown in Vancouver has gradually been in decline as demographic and economic changes have occurred during the past several years. As such, a revitalization project was initiated in which the main aim was to preserve the ethnic enclave's unique heritage, reinvigorate its cultural identity, and boost economic slowdown.

Revitalization initiatives included adaptive re-use of existing buildings, achieving the status of National Historic Site, residential intensification and a new marketing strategy. One key revitalization initiative was the addition of the China Gate project, which is meant to stand as a key symbol of identity and serve as an iconic threshold into the ethnic enclave.¹

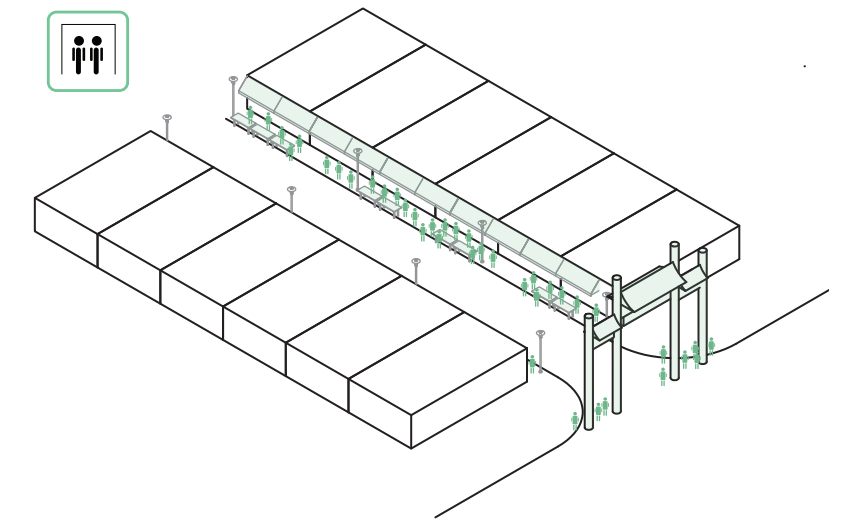
The approach of this revitalization strategy is very deliberate - it aims to mimic Chinese architecture and bring in cultural elements and decor, so as to make the visitor feel as though they are within the country. Though this approach is not what has been envisioned as the ultimate design proposal within this thesis, it is useful to examine how architectural elements have been incorporated within the urban fabric, and how some of these elements create occupiable thresholds that serve as interstitial spaces.



Chinatown - design maneuvers



Occupiable thresholds



Occupiable thresholds

Fig 5.09: Chinatown - axonometric



Fig 5.10: Streetsville main street square during the day

Streetsville Main Street Square Redevelopment
Location: Mississauga, Canada
Architect/ Designer: CS&P Architects

The key aim of this revitalization development is to promote public gatherings within the neighbourhood and optimize the current functions of the large sidewalk. Renewed components include a newly paved road and sidewalks, street furniture, new plantings and a small covered stage for concerts and other such stage shows.

This public square is meant to serve as a platform for key outdoor events all year round. Events that are envisioned to transpire at this newly developed site include: a street marketplace, an outdoor movie night, festivals, Canada Day celebrations, Remembrance Day ceremonies, and other such gatherings.² As such, it is a very useful space that can accommodate a diverse range of functions.

This urban design project is inspiring for this thesis for it depicts how re-surfacing a site while respecting its underlying geometry, and creating elements of repose within a streetscape setting, can allow for many new opportunities. It illustrates how a bland streetscape can become a new place for interaction and exchange, and how this renewed street can be activated by new programs or those that lie adjacent to it. This is something that is crucial in understanding and implementing for the ultimate design proposals.

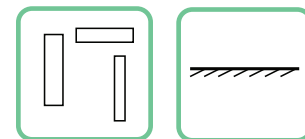
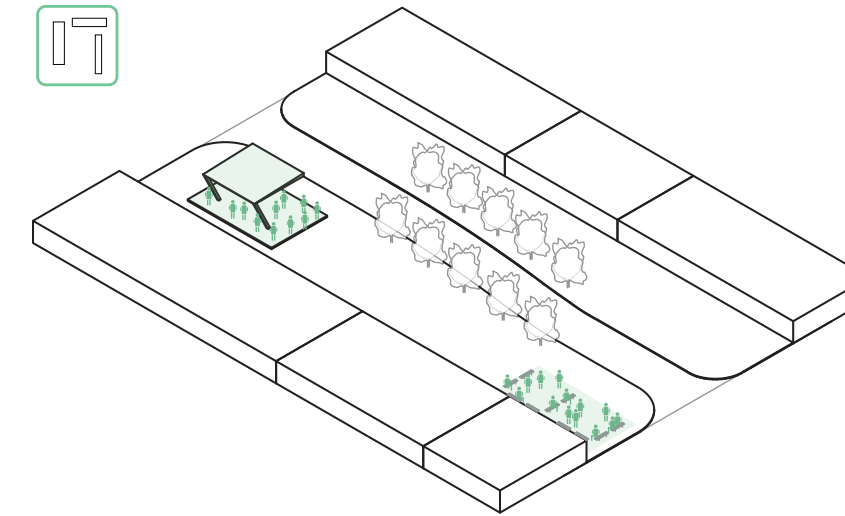
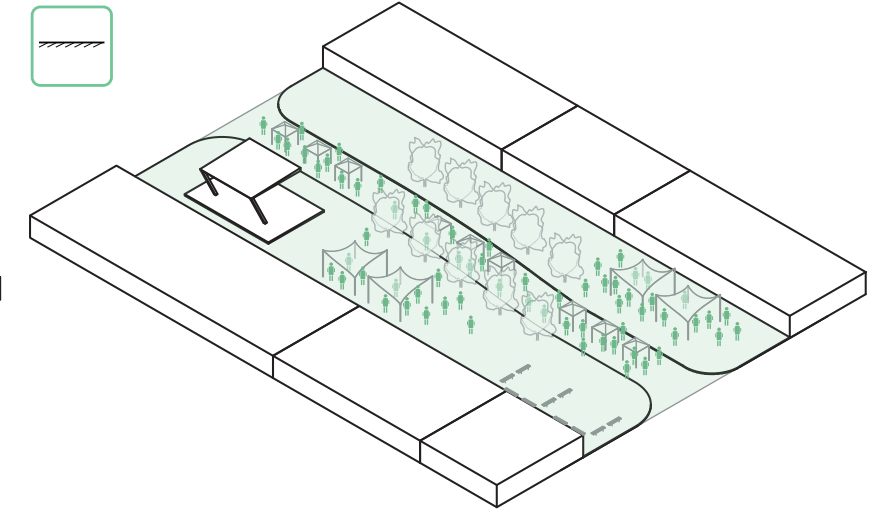


Fig 5.11: Streetsville main street square marketplace

Streetsville Main Street Square - design maneuvers



Elements of repose



Re-surfaced/ manipulated ground plane

Fig 5.12: Streetsville main street square - axonometric



Fig 5.13: Mississauga Civic Square during the day

Mississauga Civic & Central Library Square Redevelopment

Location: Mississauga, Canada

Architect/ Designer: CS&P Architects

This recent development has dramatically changed the urban fabric and locus of what once used to be a heavily underutilized open space.

The new design elements are comprised of large gathering steps along one side, a new shading device that acts as an occupiable threshold and gateway into the space and a sun-shade for a marketplace, resurfacing treatments, a memorial monument, and a “revitalized amphitheatre”. The new design aims to provide a flexible and multi-functional space where residents and visitors can stroll along on a regular basis and be a part of a large gathering during special celebrations. Events hosted include New Year’s celebrations, various festivals, Canada Day celebrations, outdoor marketplaces, match screenings, concerts, and other such gatherings.³

This project is similar to the previous one, for it also implements ground surface changes and the addition of new elements for repose. This project, however, is situated directly adjacent to two key institutions, a library and city hall, enabling it to act as a key extension to these buildings and an iconic gathering space within the heart of the city. One key aspect of this project is that it also modifies existing site elements to optimize their use and increase accessibility - this is a design strategy that can be utilized for the design interventions.

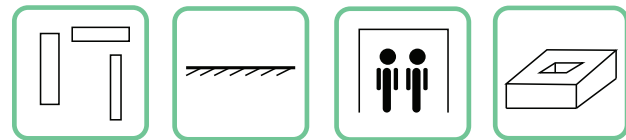
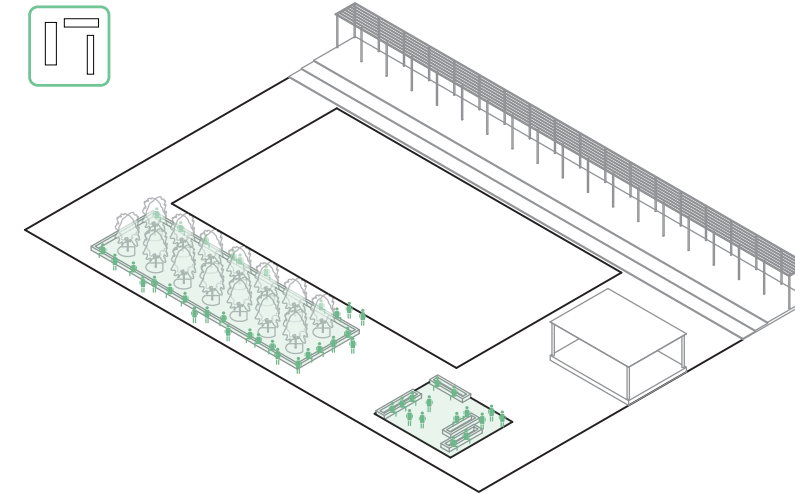
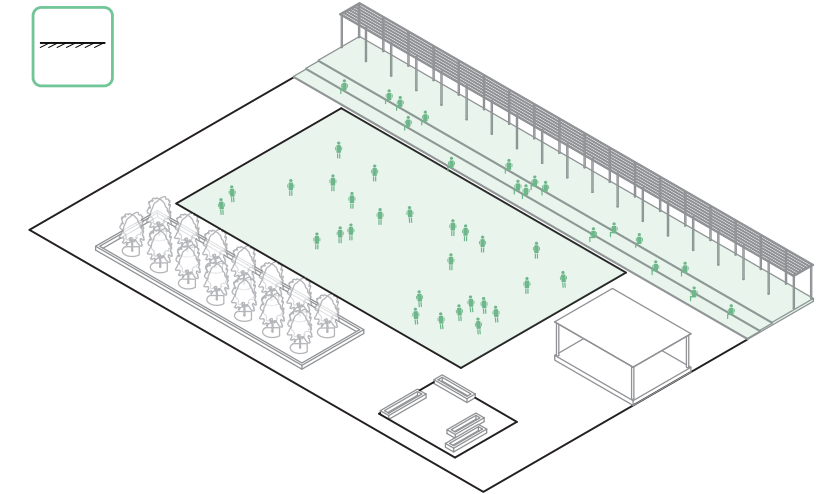


Fig 5.14: Mississauga Civic Square during a night concert

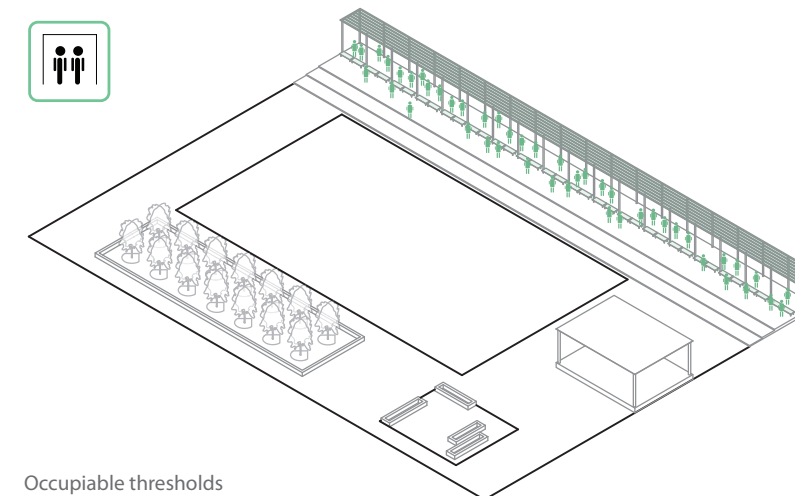
Mississauga Civic Square - design maneuvers



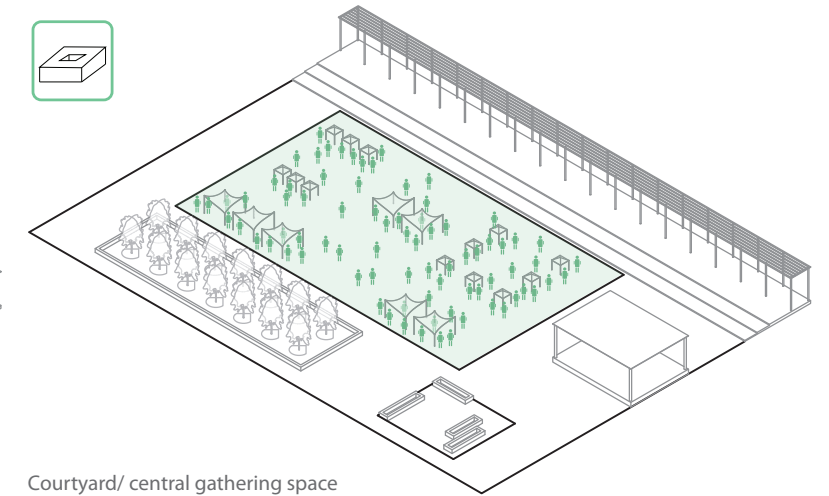
Elements of repose



Re-surfaced/ manipulated ground plane



Occupiable thresholds



Courtyard/ central gathering space

Fig 5.15: Mississauga Civic Square - axonometric



Fig 5.16: Urban platform during evening time



Fig 5.17: Urban platform as a place of gathering

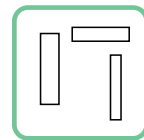
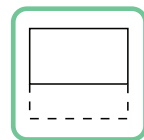
Urban Platform

Location: Lisbon, Germany

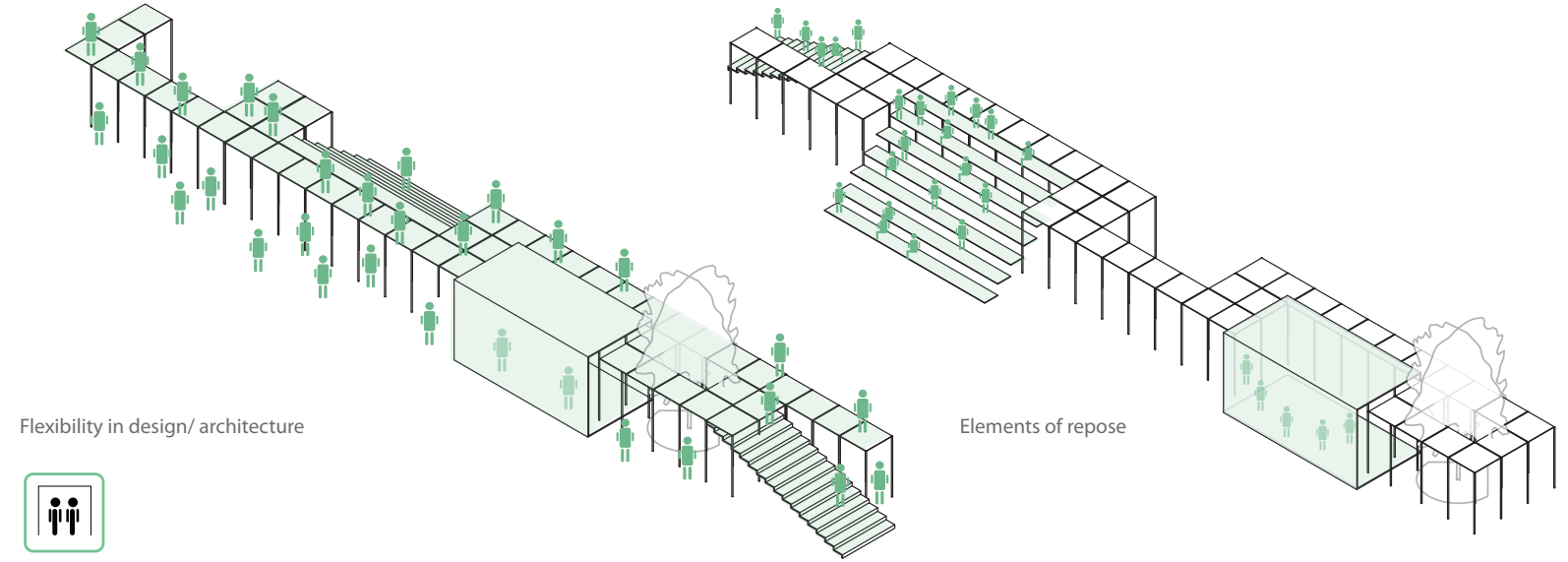
Architect/ Designer: Bumjin Kim & Minyoung Kim

This competition entry was submitted in response to the Lisbon Open Room competition which called for “good architecture for the people” in a post-recession era. Designed as an aluminum tubular structure that serves as temporary scaffolding, this elevated plaza incorporates five different modules: “steps, stage, void, enclosed space and Miradouro (a Portuguese word denoting an open-sided gallery and vantage point)”. These five modules allow for the structure to be easily built and reconfigured. In addition, they each have their own unique purpose and can be merged and arranged to give new functionalities. As such, the structure can accommodate different types of scenarios and be deployed in a diverse range of contexts.⁴

This project is interesting in that it incorporates the idea of flexibility and gathering. The dynamic structure serves as a multi-functional entity that can accommodate different activities through its varying forms including occupiable thresholds and stairs that serve as places of repose. If activated by a specific event or program, these spaces have the potential to allow for interaction and social cohesion among different people. As such, this design illustrates how several architectural elements can create a powerful system that brings people together - something that could be incorporated in the design proposal.

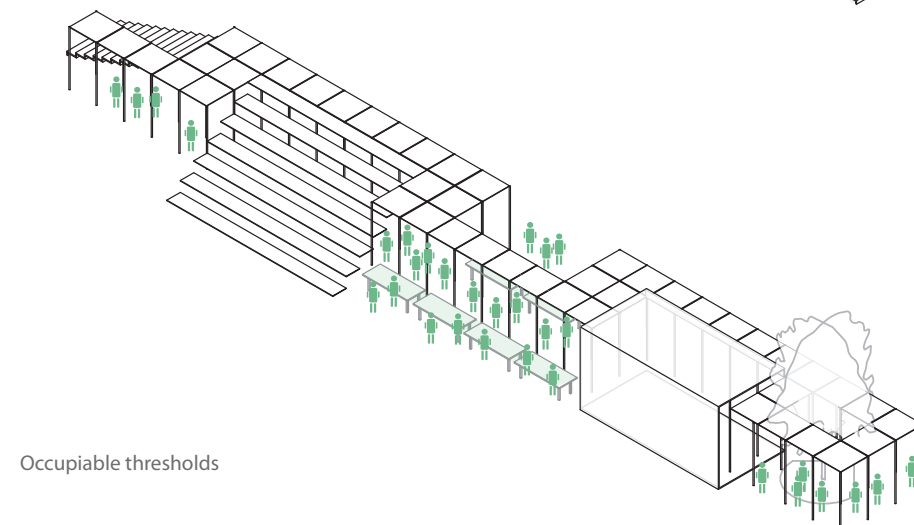


Urban Platform - design maneuvers



Flexibility in design/ architecture

Elements of repose



Occupiable thresholds

Fig 5.18: Urban platform - axonometric



Fig 5.19: View to the courtyard



Fig 5.20: View into occupiable threshold

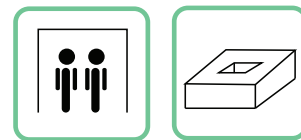
PEGS Senior School
Location: Victoria, Australia
Architect/ Designer: McBride Charles Ryan

Designed in a windy site, the PEGS Senior School merges two colleges in a design that symbolizes infinite learning. This allows for the building to encircle two courtyards which offer plenty of views and sunlight. This also enables the building to serve as a “journey” in which one seamlessly goes from one program to the next.

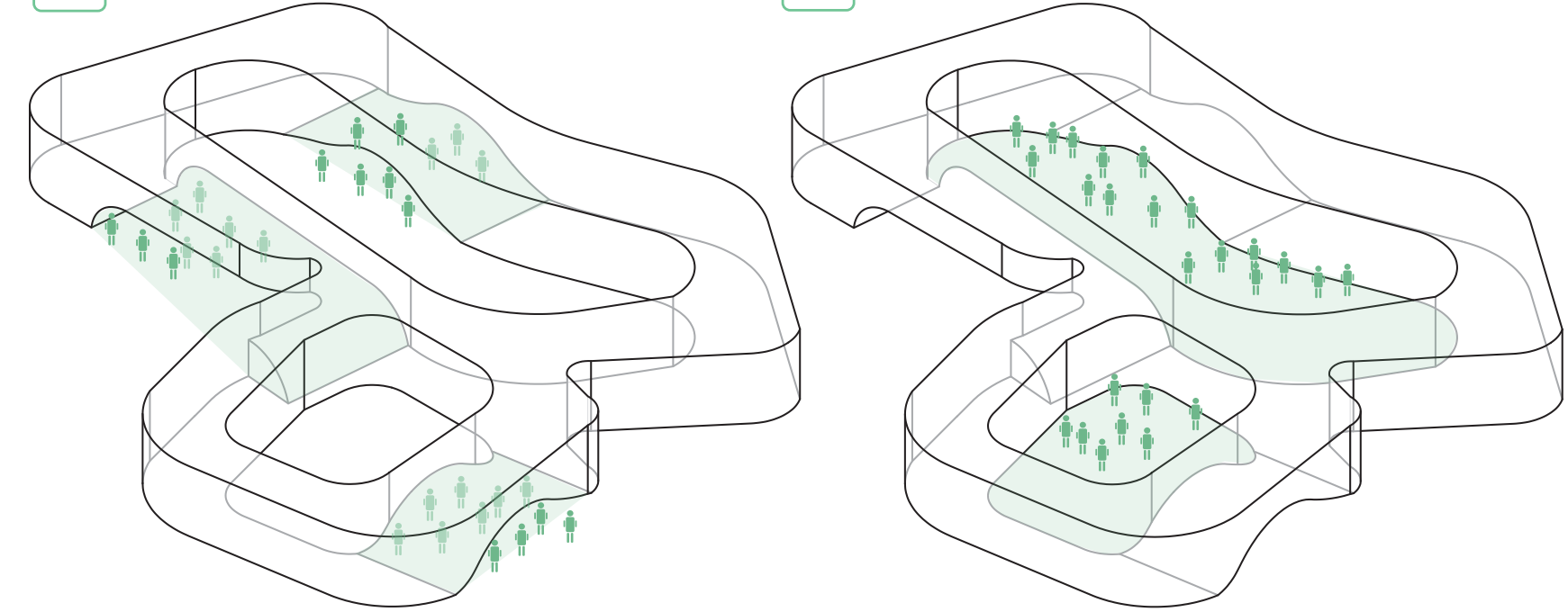
The library is the key entity within the building as it serves as the “hub”. The entire plan is meant to eventually lead to this library as a part of the experience.

The building is composed of a variety of volumes and carved out arches that blend into one unifying form.

This building depicts an interesting version of occupiable thresholds in the form of “carved out” spaces. These thresholds not only lead to the central courtyard but also serve as dynamic gathering spaces themselves. They also are situated at key junctions where different programs are adjacent to one another; this fosters more interaction among different students. This approach is useful to examine before designing the senior’s residence.



PEGS Senior School - design maneuvers



Occupiable thresholds

Courtyard/ central gathering space

Fig 5.21: PEGS Senior School - axonometric



Fig 5.22: Courtyard view of senior residence

Senior Residence

Location: Vern sur Seiche, France

Architect/ Designer: a/LTA Architects

This colourful senior home aims to promote a balance between community life, which involves exchange and forming relationships, and private life, which is more quiet and tranquil. The design embraces the concept of being like a “village with streets, a park, bridges, squares (places of exchange), a “church”, a restaurant, a hairdresser...” and other public gathering spaces. The central courtyard of the building serves as a “secure” space, yet a variation in program and form are carefully implemented to allow for a physical and visual connection to the “outside world”. The central courtyard is also the “essence of the project” in that the main idea was to encircle the entire program around it and make it serve as a park extended within the interior of the building.

The idea of freely wandering or taking a contemplative stroll is also important within the project concept. The architecture has been designed in such a way so as to allow for variation in paths of circulation and places of repose.⁵

This project illustrates how architecture can incorporate spaces of gathering for exchange and places of repose in a harmonious form. As such, it allows for public programs to create a relationship with the outside world and private programs to remain in seclusion, yet nearby public amenities.

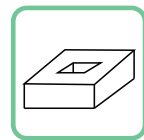
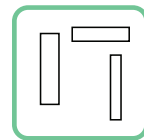
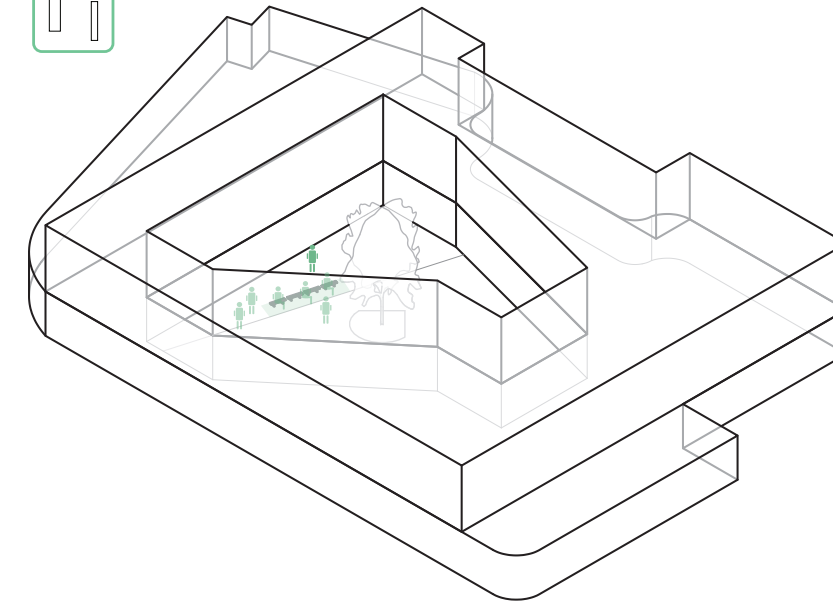
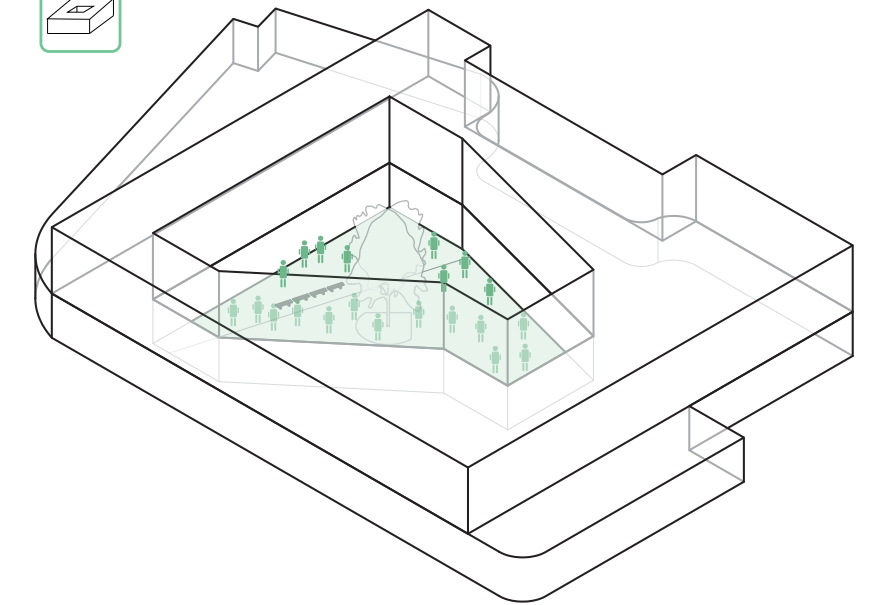


Fig 5.23: Exterior view of senior residence

Senior Residence - design maneuvers



Elements of repose



Courtyard/ central gathering space

Fig 5.24: Senior Residence - axonometric



Fig 5.25: Aerial view of retirement community



Fig 5.26: Exterior view retirement community

Solund Retirement Community

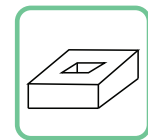
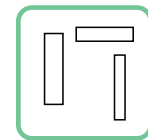
Location: Copenhagen, Denmark

Architect/ Designer: Henning Larsen Architects

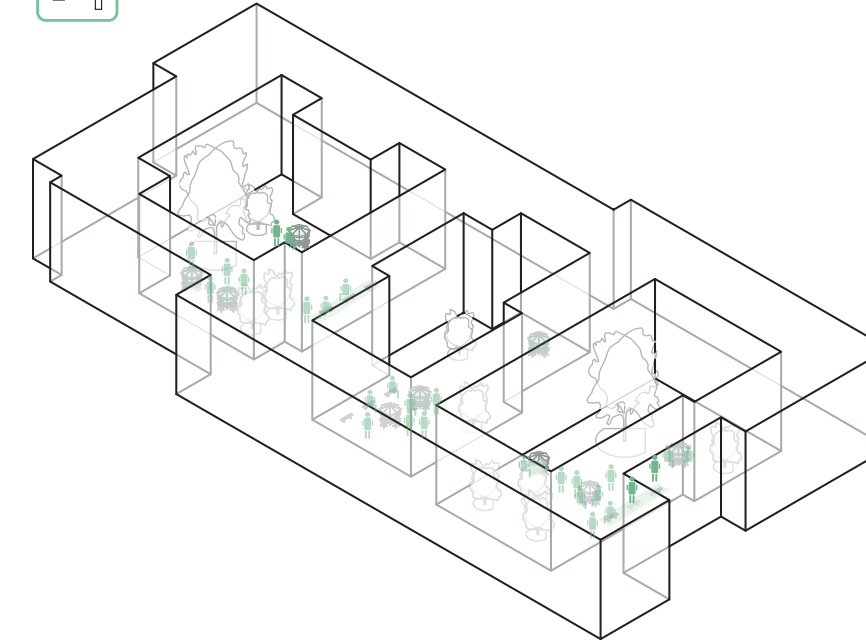
Designed as a large form with a series of continuous courtyards, this building aims to respond to the surrounding context and allow for a relationship to be formed between the interior and the exterior. In addition, the design intent was to create spacious dwellings and spaces, ample terrace space and lush green spaces which can serve as places of repose where eventful activities can unfold.

The building also houses a daycare centre and other public programs that allow for it to create a stronger bond with the public realm.⁶

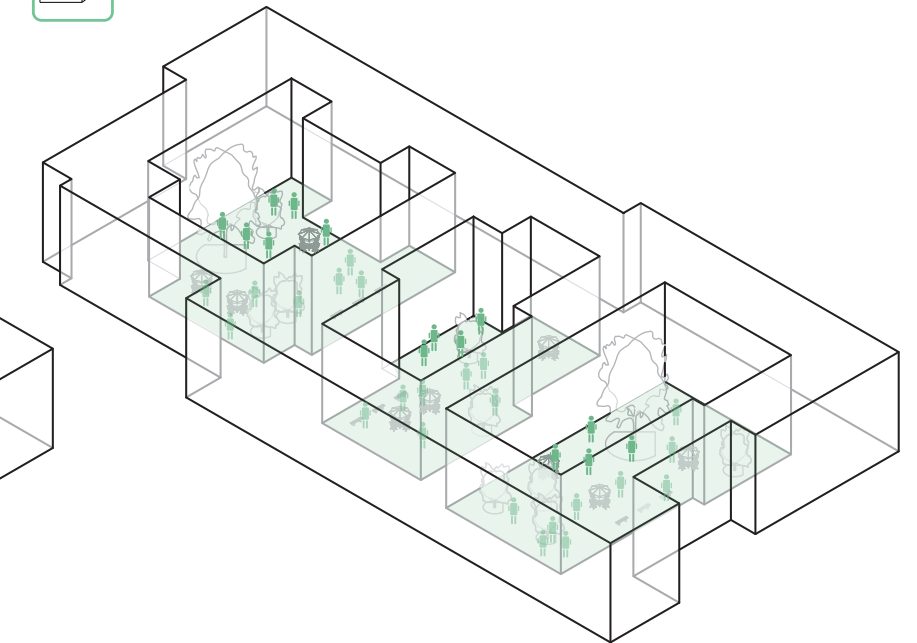
This building is inspirational because it places an emphasis on extruding and receding volumes which create different kinds of interstitial spaces and relationships between the interior and exterior. It also focuses on public spaces as key elements within the everyday life of residents and their well-being. These greenspaces are meant to instill a new sense of character within the architecture, and allow for the seniors to be stimulated and content. Such features are key when designing for “cultural exchange”.



Sound Retirement Community - design maneuvers



Elements of repose



Courtyard/ central gathering space

Fig 5.27: Solund Retirement Community - axonometric



Fig 5.28: Exterior view of corner

Plassen Cultural Centre
Location: Molde, Norway
Architect/ Designer: 3XN Architects

Located within the heart of the city, this cultural centre is meant to serve as a dynamic entity that is able to support everyday cultural life. The key idea is that celebration is important and must be present within, around, on top and outside of the building. Many events occur within this building, given that it is at the crux of key regions within the city. Every square meter is utilized to its fullest capacity to accommodate up to 100,000 people.

In terms of the actual architectural design, all the surfaces of the structure have a function. The roof and staircase form three outdoor amphitheatres during events. The roof itself also supports a cafe and recreational area. Moreover, the staircase is meant to serve as a bridge between the ground and upper realm.⁷

This building is an interesting example of how architectural form can be manipulated to create new spaces of gathering, repose, exchange and intimacy. It serves as an example of architecture blending in with the ground plane and vice versa - as such, it illustrates how a building can become dynamic and have different kinds of elements incorporated into it. This gives it an iconic character and allows it to respond to support varying activities and events. Such characteristics are essential when considering the ultimate design proposal for this project.

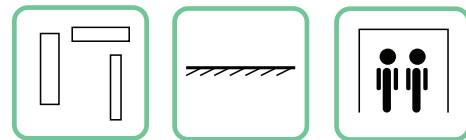
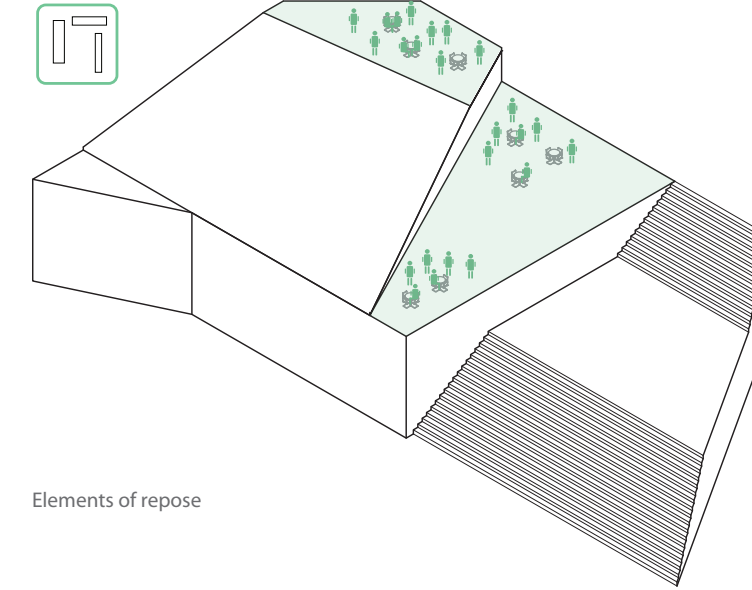
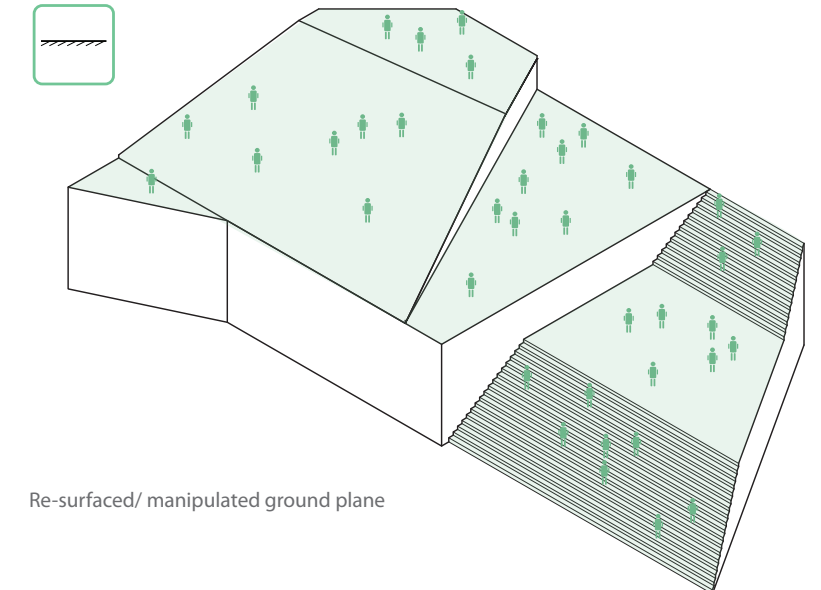


Fig 5.29: Exterior view of stairs

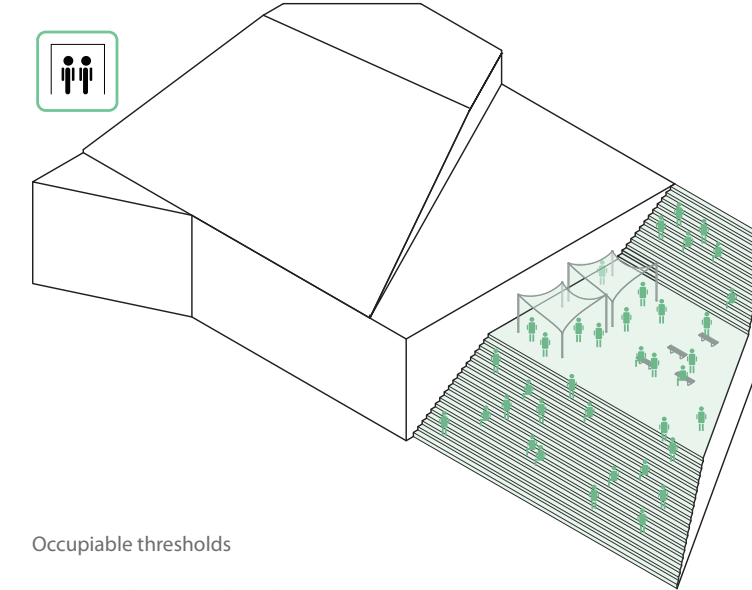
Plassen Cultural Centre - design maneuvers



Elements of repose



Re-surfaced/ manipulated ground plane



Occupiable thresholds

Fig 5.30: Plassen Cultural Centre - axonometric

5.3 Networks & Siting

Considering the aforementioned idea of promoting more integrated networks within the Gerrard Bazaar and allowing for cultural exchange to occur via these newly formed networks, it is imperative to identify what kinds of networks currently exist within the ethnic enclave and where opportunities exist for form new networks and adjacencies.

Networks would be defined as relationships that link together “key entities” within the Gerrard Bazaar. Such entities are those which, in some way, promote gathering, attempt to enrich the neighbourhood, foster community regeneration & participation, or other such neighbourhood improvement initiatives. These are imperative to incorporate within the design strategy because they could compliment the proposed programs and form a symbiotic relationship with them. This would in turn stimulate the identity and economy of the bazaar.

The aim of the design interventions is to weave their way into this complex set of relationships and networks in order to become a part of a larger system that actively works towards renewing the identity, economy, locus and interactions within the Gerrard Bazaar through cultural exchange.

Figure 5.27 depicts the previously shown networks diagram with potential areas for new networks.



Fig 5.31: Multifaith Walk hosted by several organizations including the Pakistani Community Centre (PCC)

Networks, programs and potential areas for new networks among key entities within the Gerrard Bazaar

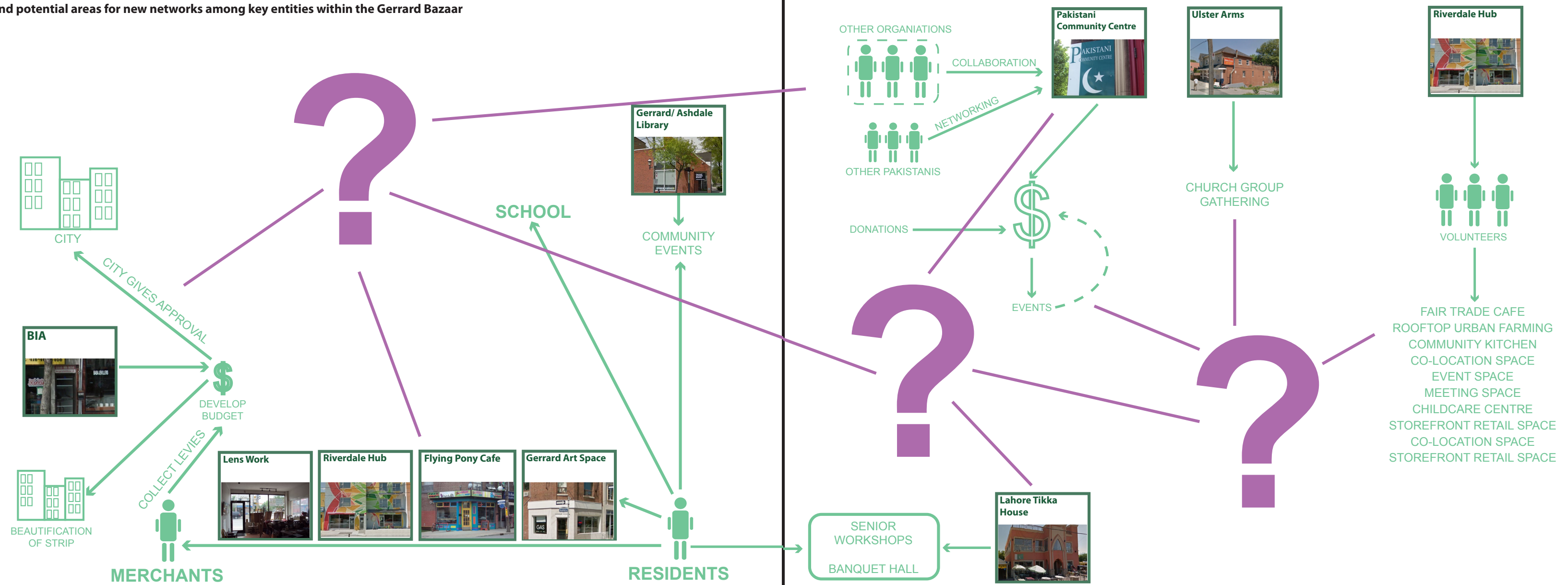


Fig 5.32: "Key entities" and networks within the Gerrard Bazaar - Opportunities for new networks



Fig 5.33: View towards west end of retail strip

Once again, it is required to look back at the site analysis and identify where the “key entities”, vacant sites, designated plots and private/fenced up plots are, in order to determine potential sites for the three design interventions.

In Figure 5.28, potential sites for each of the three types of interventions are identified based on this analysis.

Potential sites for the Re-activation intervention include mainly designated plots. Many of these plots are underutilized or have the potential to become much more robust and useful, especially if they have adjacency with “key entities” or vacant sites, for these can be symbiotically incorporated within the design intervention.

Potential sites for the Adaptive Re-use strategy mainly consist of vacant sites. These sites may be in the form of vacant storefronts, or vacant or severely underutilized buildings. Many of these sites are situated close to “key entities”, and some are situated close or adjacent to a designated or private plot. These adjacencies have a big effect on the design intervention that is ultimately proposed for this type of site.

Potential sites for the Re-Imagine design intervention are limited, since most of the retail strip is occupied by built form. The only site which is fit for this intervention lies at the western end of the strip, as an undeveloped site for a condominium.

After considering the different adjacencies, potential networks, and proximity to others “key entities” for each of the sites, three sites (Figures 5.29 - 5.31) are chosen for each intervention.

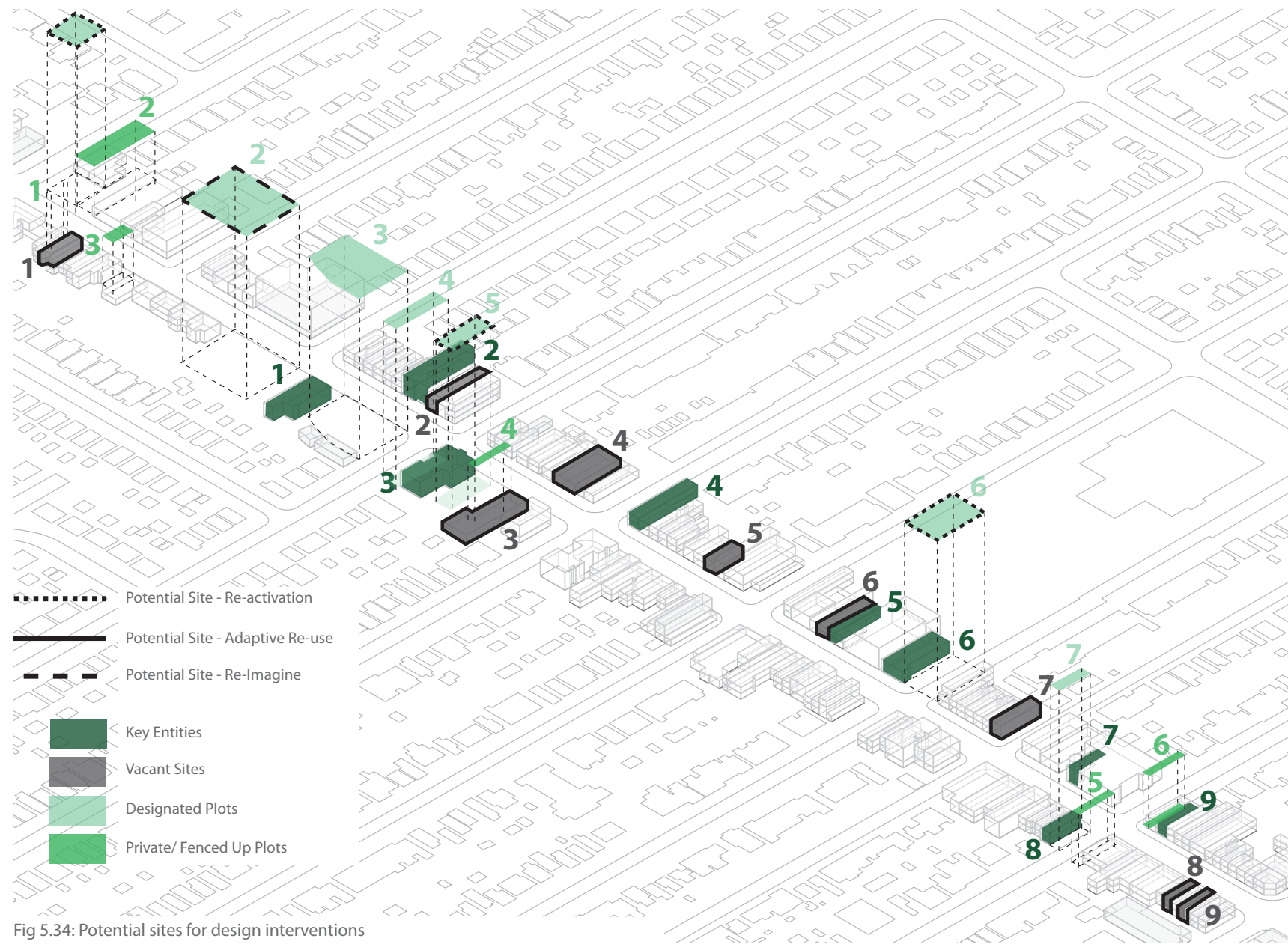


Fig 5.34: Potential sites for design interventions

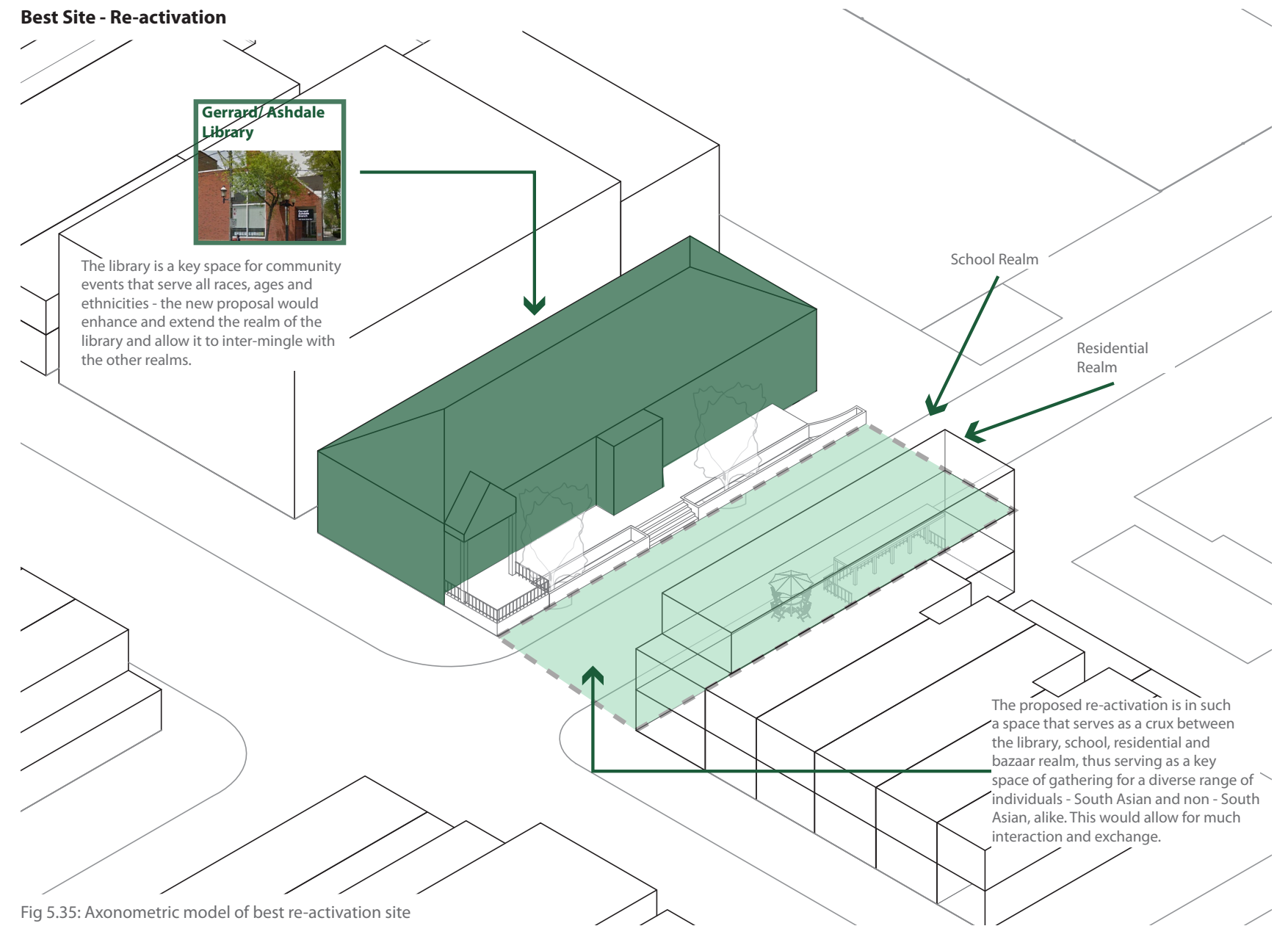


Fig 5.35: Axonometric model of best re-activation site

Best Site - Adaptive Re-use

The adaptive re-use strategy is proposed in a building that lies outside of the Gerrard Bazaar BIA region, allowing for it to draw more crowd to the western end of the strip. The proposed infill program is related to art.

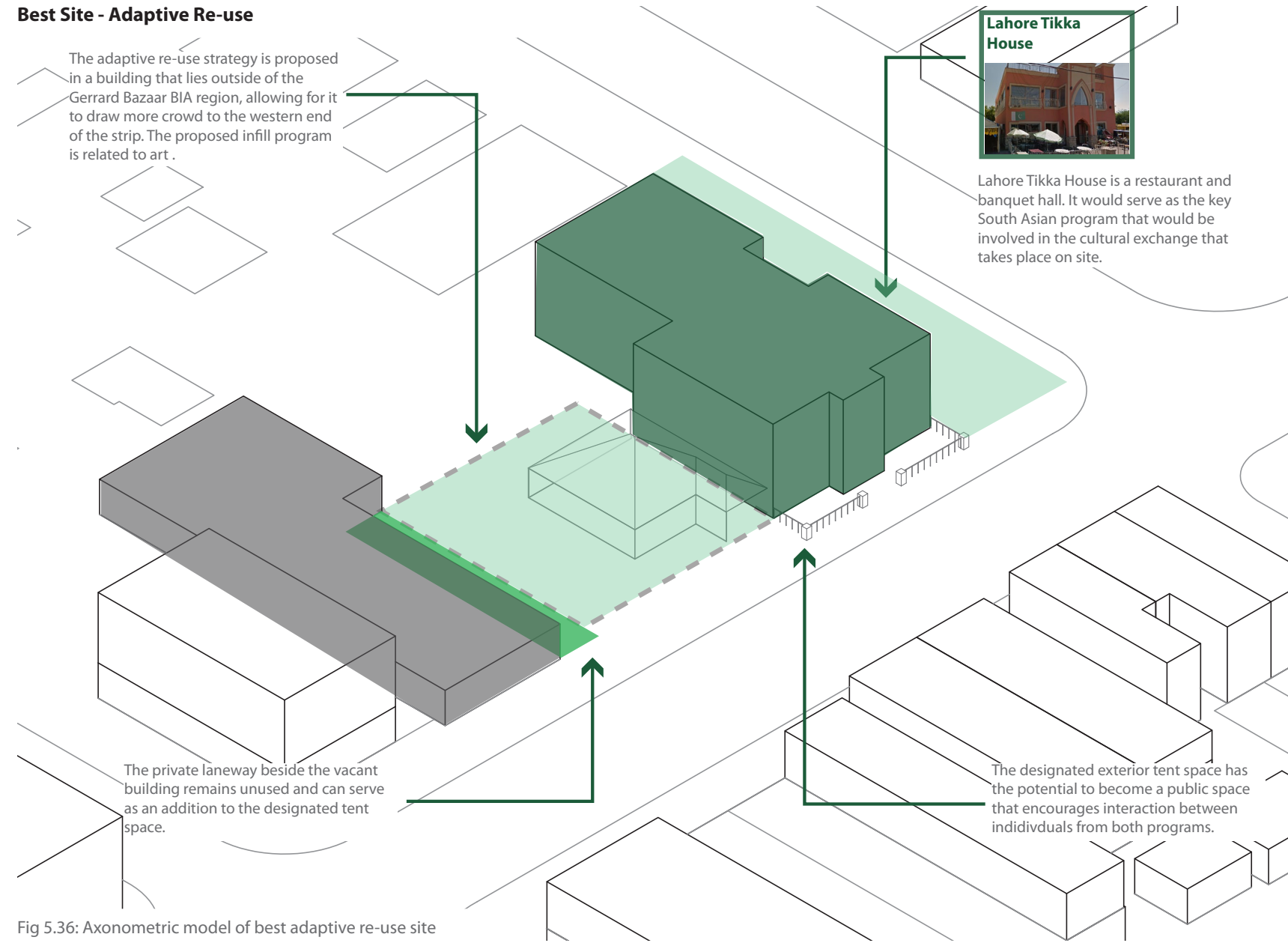
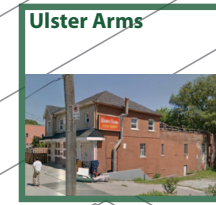


Fig 5.36: Axonometric model of best adaptive re-use site

Best Site - Re-imagine



The Ulster Arms Tavern serves as a gathering space for a local church group and the new design intervention could serve as a new place for them to hold their gatherings.

The proposed plot is close to other residential properties, yet within close proximity to the heart of the Gerrard Bazaar, enabling seniors to easily access the entire strip and reinvigorate its economy and population.

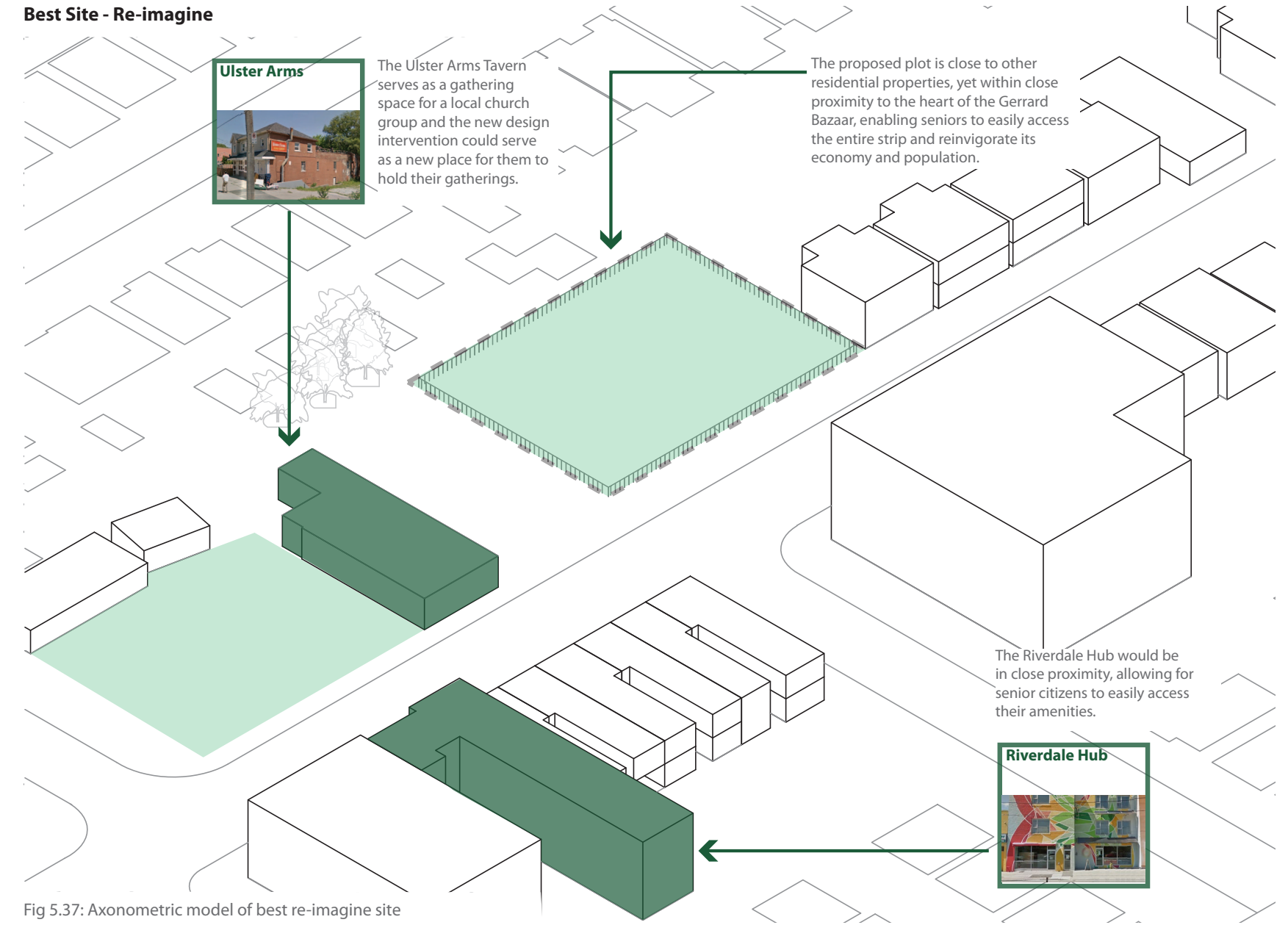


Fig 5.37: Axonometric model of best re-imagine site

5.4 Designing for Cultural Exchange

By considering all of the small-scale elements of the Gerrard Bazaar, vernacular and other precedents and site conditions, a set of urban strategies are formulated which would serve as a “manual” for every design intervention within this thesis.

1) Examine current site conditions - Depicts certain issues with the site that should be resolved.

2) Acknowledge personal input from key entities and other user groups- Selects important viewpoints of those who belong to key entities or user groups and translates them into design thought. This is an important step for it reflects back on the interviews and surveys that were conducted, and allows for the design to be influenced by different people’s perspectives on the ethnic enclave, culture and identity.

3) Define new networks among key entities and other user groups- Depicts the networking diagram once again and shows new networks that can be formed, in purple. This is another very important step for it relates to the key entities and aims to create new relationships with them in order to establish new networks and venues for cultural exchange.

4) Identify vernacular/ traditional design maneuvers - Sheds light on the architectural elements seen in traditional and vernacular architecture from the Indian subcontinent, and selects those that can inspire the design proposal for that specific site.

5) Identify local design maneuvers - Brings to light certain buildings from the architectural analysis phase, which could again, inspire certain architectural features of the design intervention.

6) Uncover underlying form/ site geometry to establish design constraints- Identifies underlying zoning setbacks, property lines, street

and other axes, to establish an underlying framework within which the building can be designed.

7) Re-surface/ modify the ground plane to create new spatial relationships- Simply a modification of the ground or ground plane, to create a surface that compliments the design and promotes gathering or the accommodation of programs that promote social cohesion.

8) Modify site elements to create connectivity and adjacency- Illustrates certain elements that are changed to better respond to the design proposal and enhance its ability to foster cultural exchange.

9) Design new architectural/ urban elements - Where the actual design is realized.

10) Refine new architectural/ urban elements to create areas of gathering/ interaction (cultural exchange)- Involves modifying the proposed elements to create new relationships and spaces that enhance cultural exchange.

Each design intervention is carefully created based on this manual, which utilizes all of the accumulated findings and incorporates them at every step. Therefore, this manual serves as a key link between all of the compiled research and the design interventions. It acts as a compact set of rules that are carefully devised based on all of the research. It is one of the most important tools designed as a part of the method proposed in this thesis, and is the threshold at which the research translates into design.



Examine current site situations



Acknowledge personal input from key entities and other user groups



Define new networks among key entities and other user groups



Identify vernacular/ traditional design maneuvers



Identify local design maneuvers



Uncover underlying form/ site geometry to establish design constraints



Re-surface/ modify the ground plane to create new spatial relationships



Modify site elements to create connectivity and adjacency



Design new architectural/ urban elements



Refine new architectural/ urban elements to create areas of gathering/ interaction (cultural exchange)

Fig 5.38: Urban strategies manual

Design Intervention 1: Re-activation

Re-activation: Examine current site situations

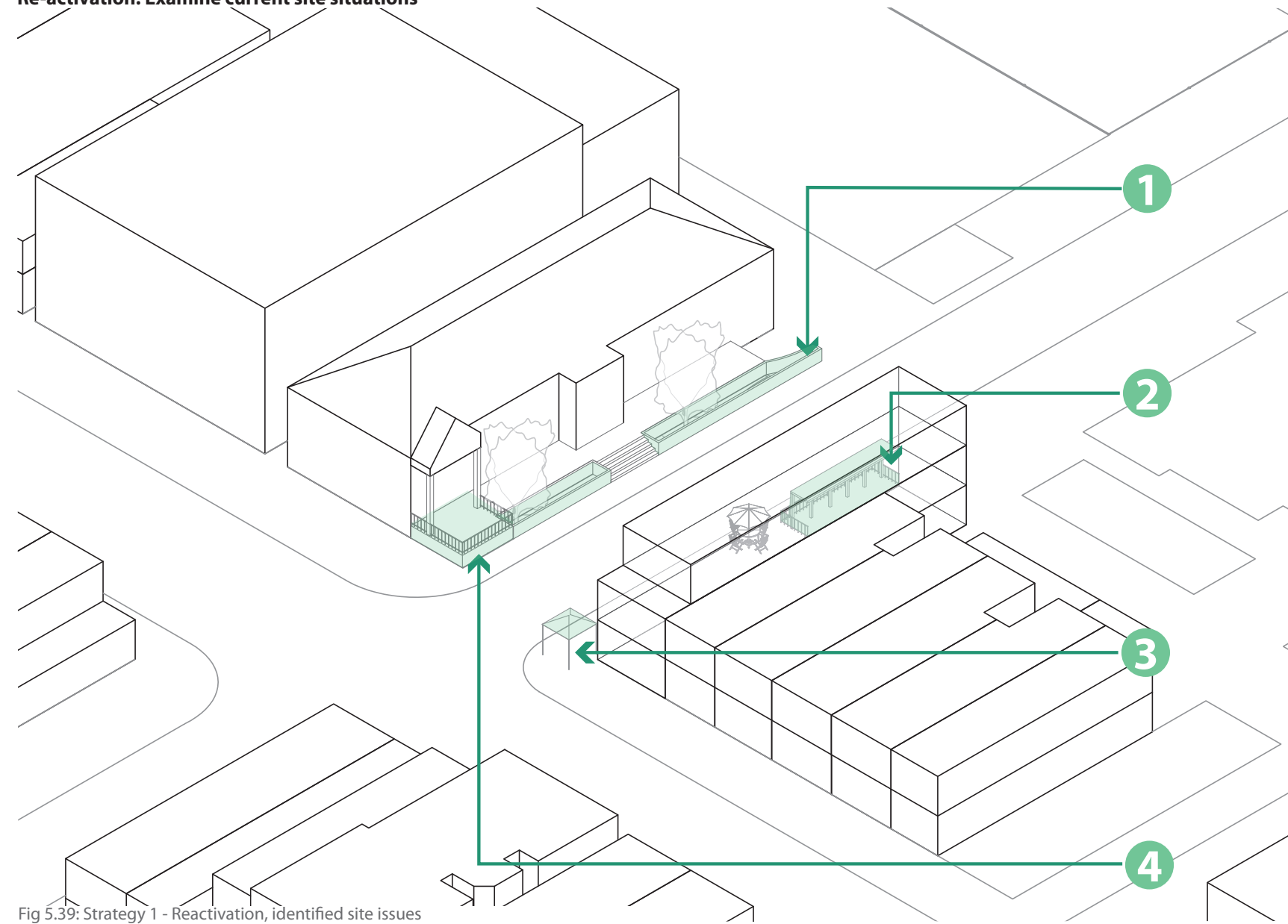


Fig 5.39: Strategy 1 - Reactivation, identified site issues



1 Planters outside of library used as seating due to lack of seating areas



2 A small poorly-maintained veranda that stands as an isolated architectural element from its context



3 Food stalls in one area of the sidewalk that stand as isolated elements from their context



4 Library terrace houses small outdoor reading events that take place in an isolated manner

Fig 5.40: Strategy 1 - Reactivation, site images

Re-activation: Acknowledge personal input from key entities and other user groups

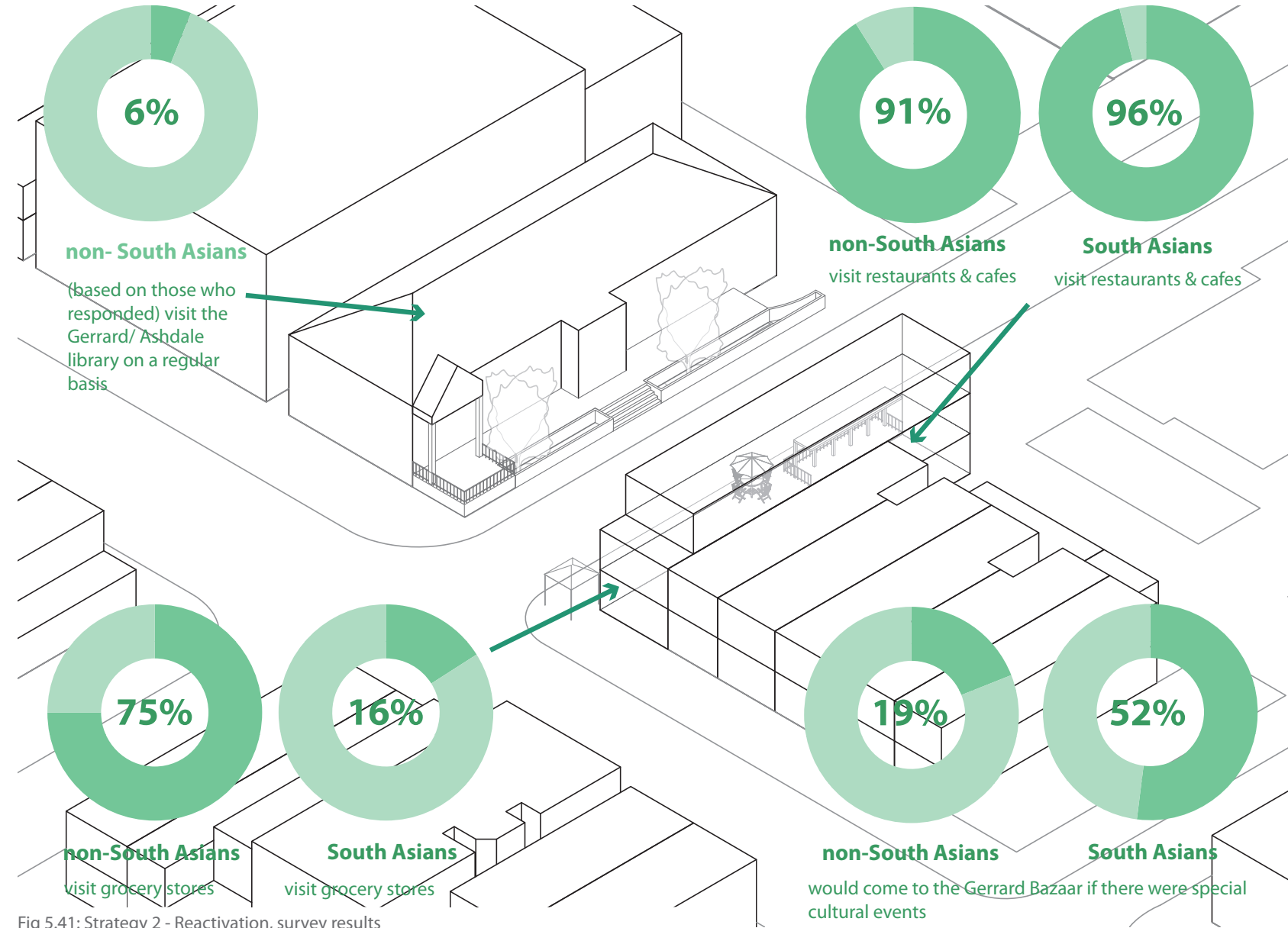


Fig 5.41: Strategy 2 - Reactivation, survey results

The site interfaces with the library, a restaurant and a grocery store - all of which are used by varying numbers of non-South Asians and South Asians. As such, it becomes a key space where different ethnicities have the potential to **interact and collaborate**. Non-South Asians are more concerned **about experiencing the culture and not feeling segregated while living their daily lives**. South Asians are more interested in **spectacle and exciting events** that make it worthwhile to drive down to the enclave. Merchants are eager to **display their goods to passersby** so as to generate more profit. If library events were to spill out onto the shared space at the same time as a South Asian food market, there would be **many opportunities for interaction and cultural engagement**.

Re-activation: Acknowledge personal input from key entities and other user groups

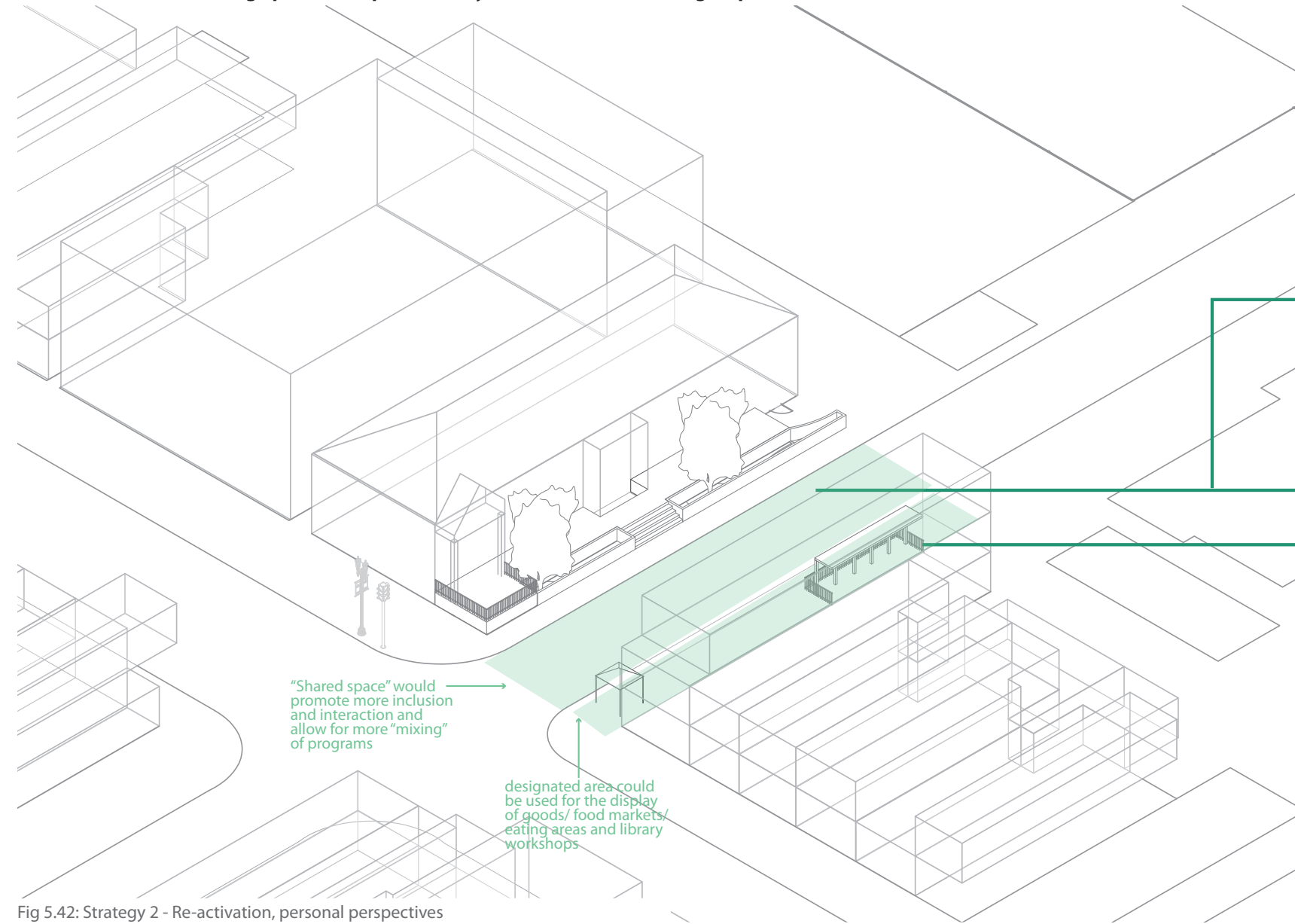
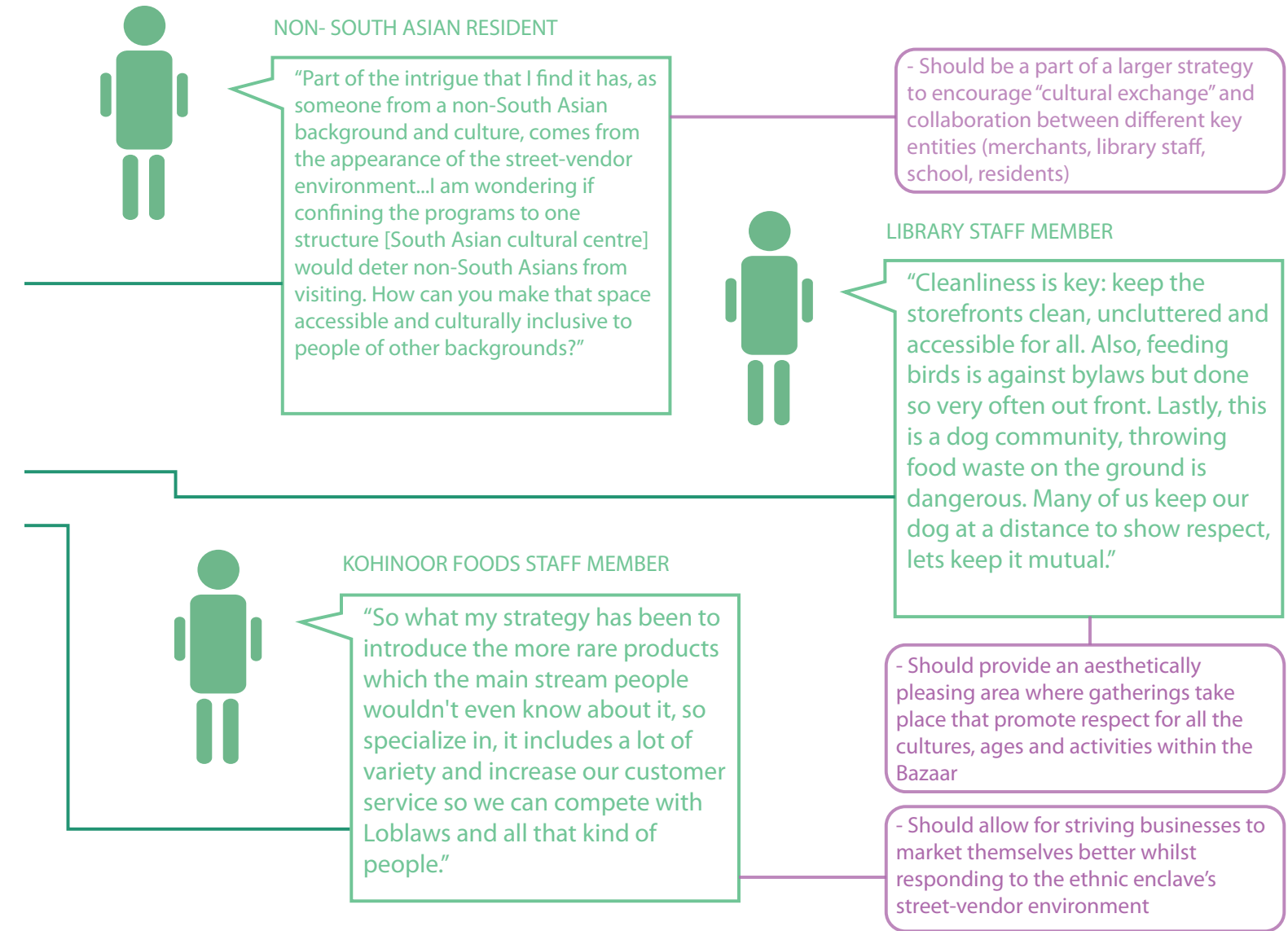


Fig 5.42: Strategy 2 - Re-activation, personal perspectives



Re-activation: Define new entities among key entities and other user groups

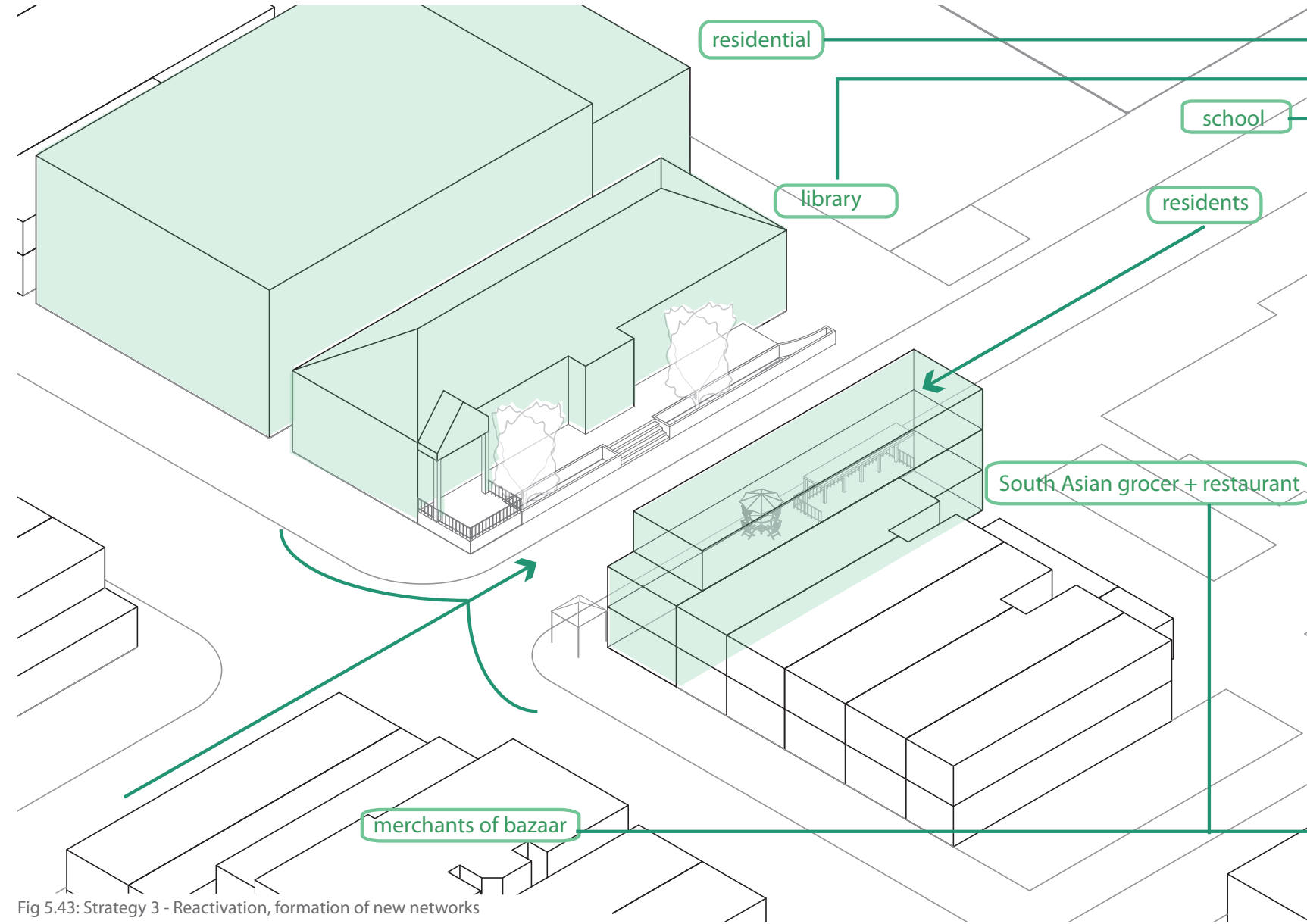
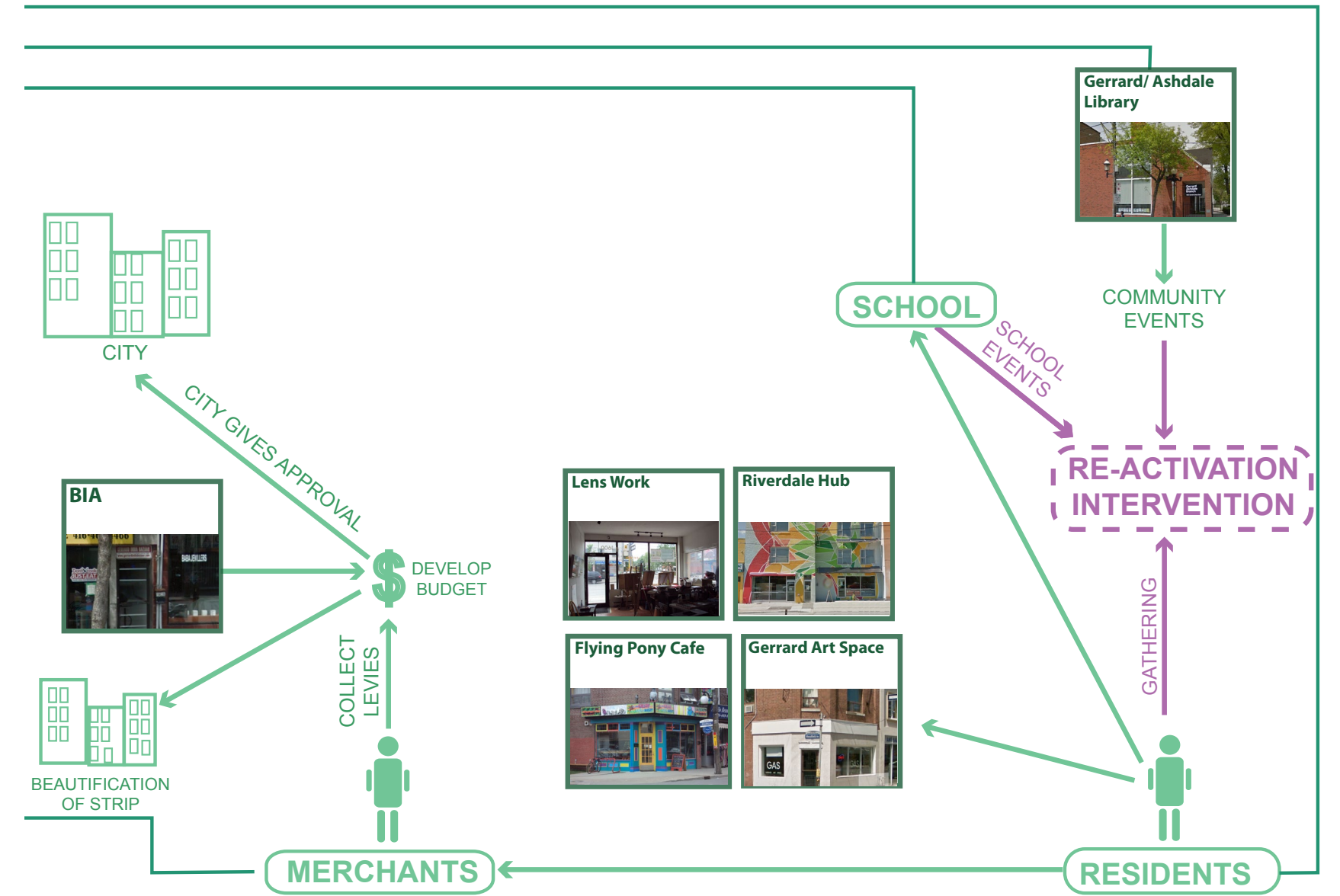


Fig 5.43: Strategy 3 - Reactivation, formation of new networks



Re-activation: Identify vernacular/ traditional design maneuvers

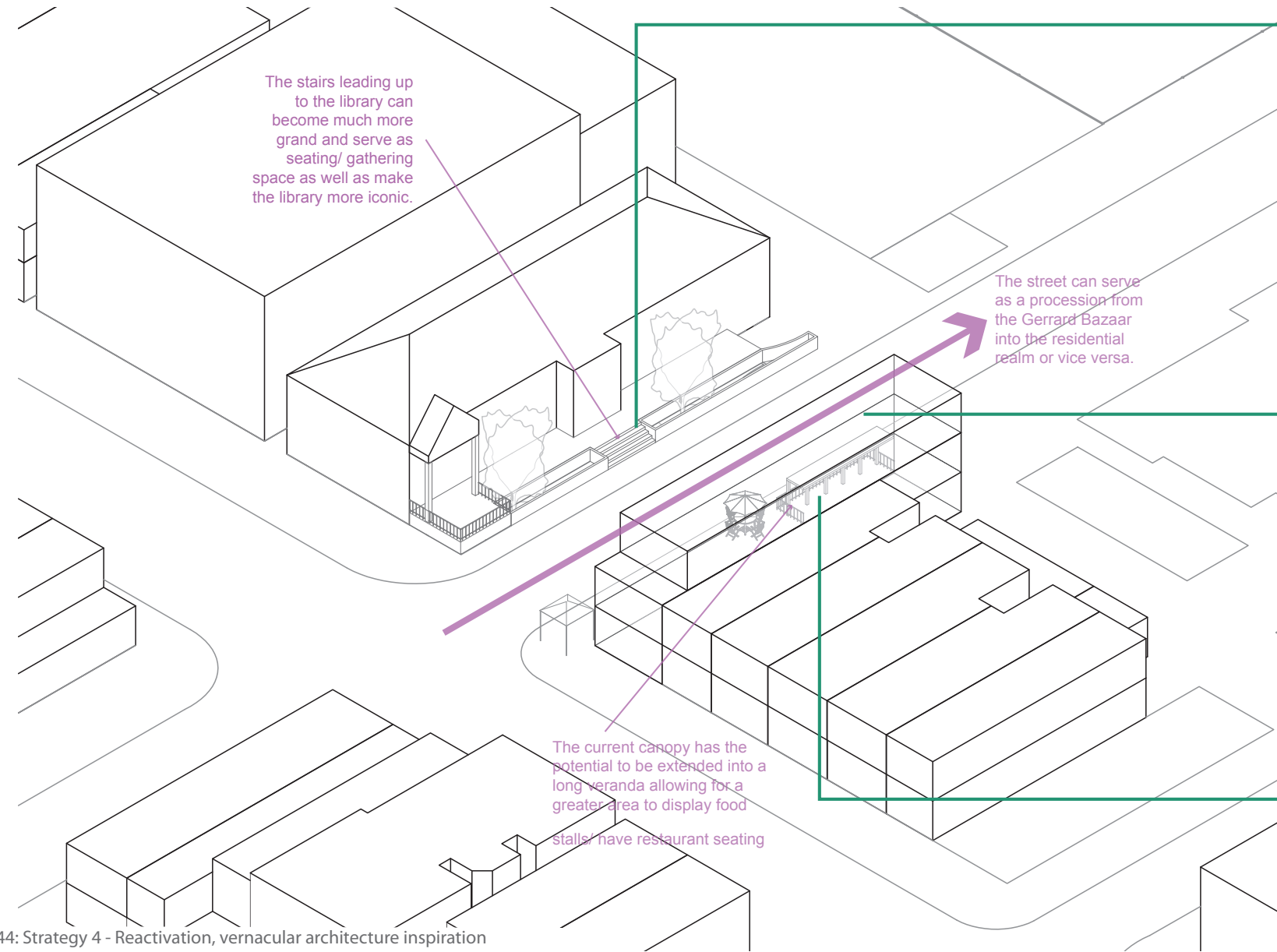


Fig 5.44: Strategy 4 - Reactivation, vernacular architecture inspiration



Stairs

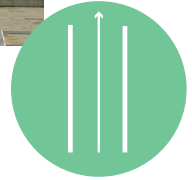
3



1



Procession



2



Veranda



Re-activation: Identify local design maneuvers

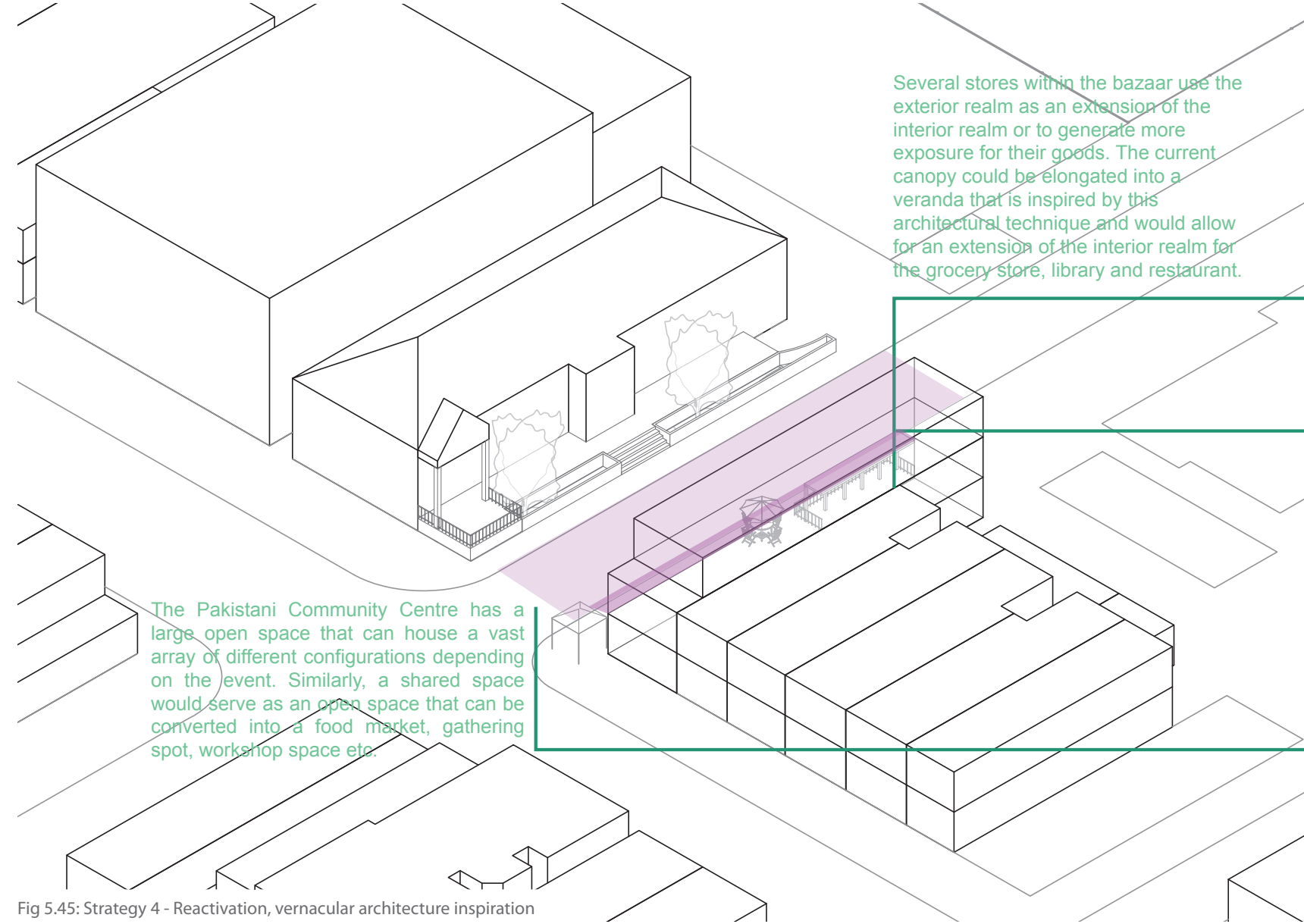
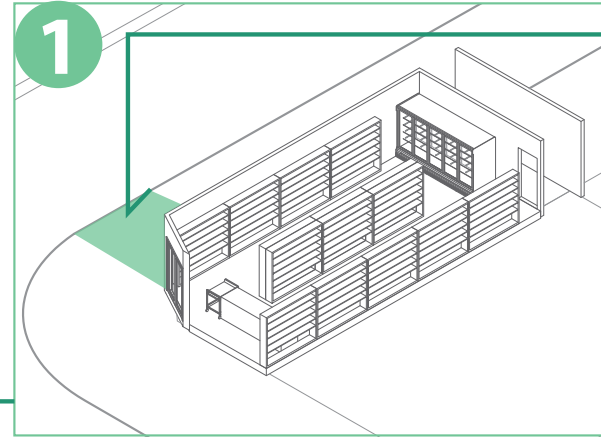
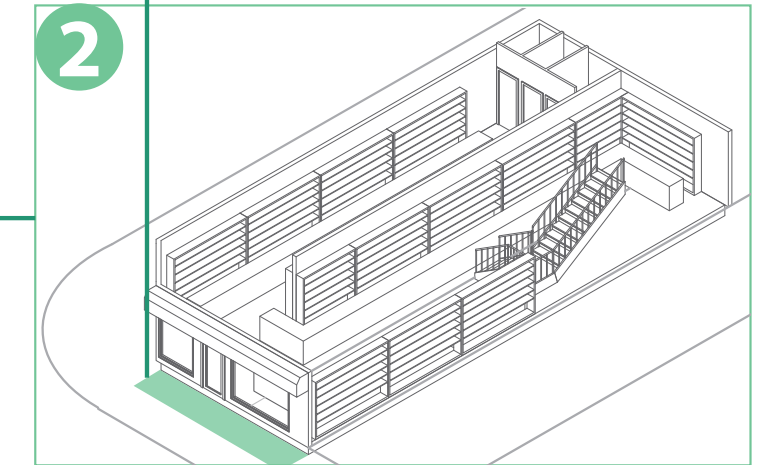


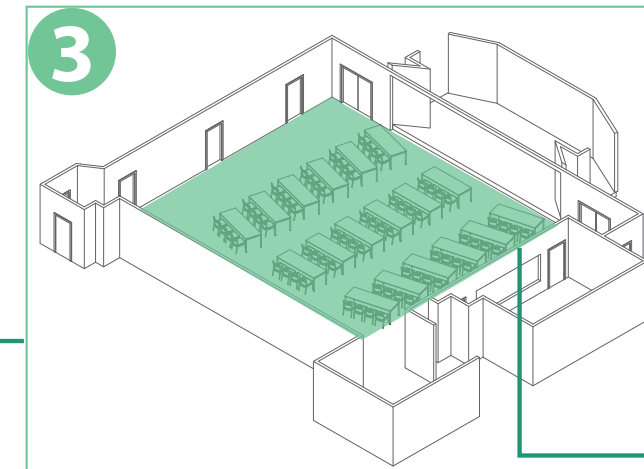
Fig 5.45: Strategy 4 - Reactivation, vernacular architecture inspiration



Kohinoor Foods -
Extension of interior realm



Chandan Fashion -
Extension of interior realm



Pakistani Community Centre -
Flexibility of space



Re-activation: Uncover underlying form/ site geometry to establish design constraints

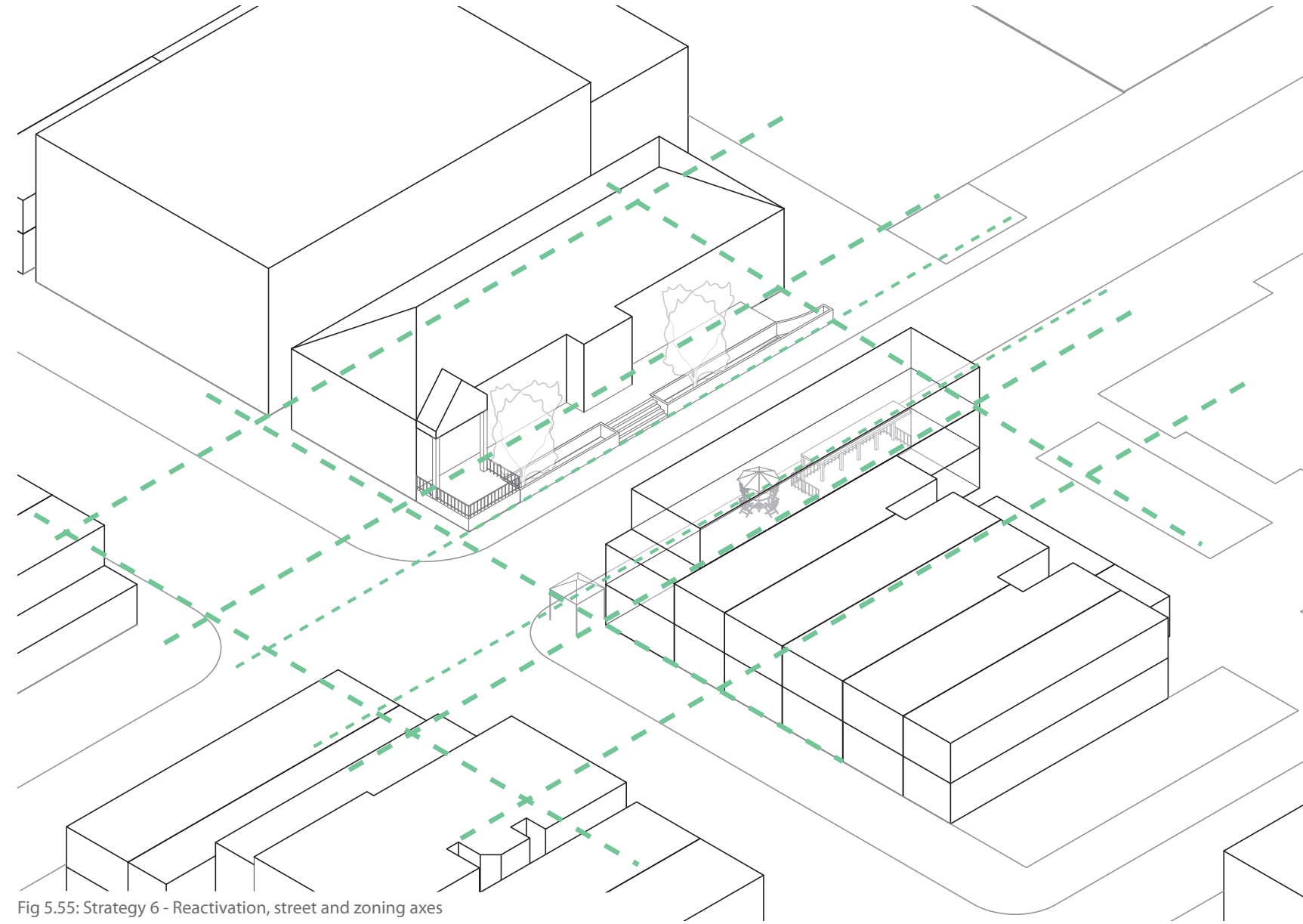


Fig 5.55: Strategy 6 - Reactivation, street and zoning axes

Re-activation: Re-surface/ modify the ground plane to create new spatial relationships

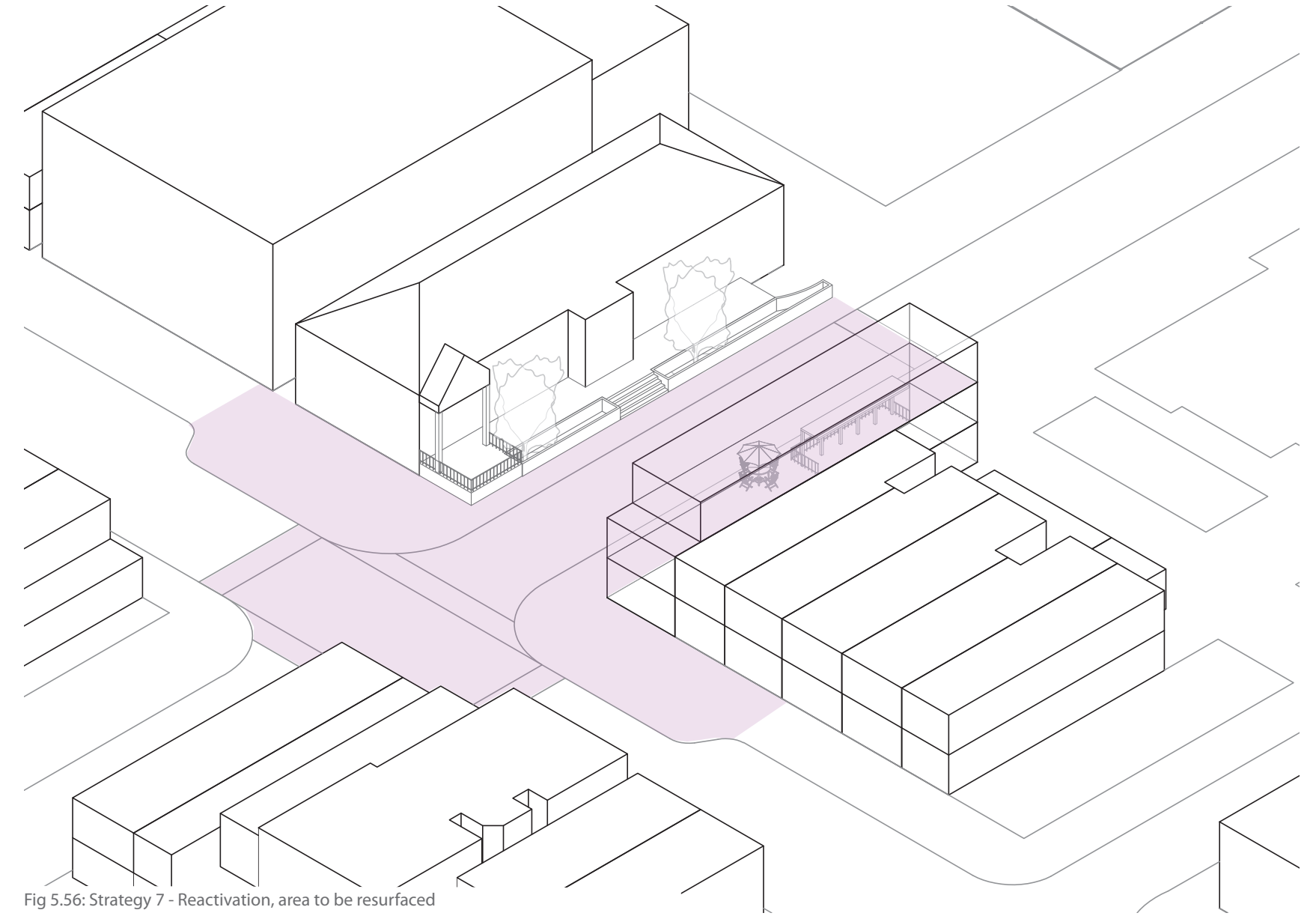


Fig 5.56: Strategy 7 - Reactivation, area to be resurfaced

Re-activation: Modify site specific elements to make them more accessible

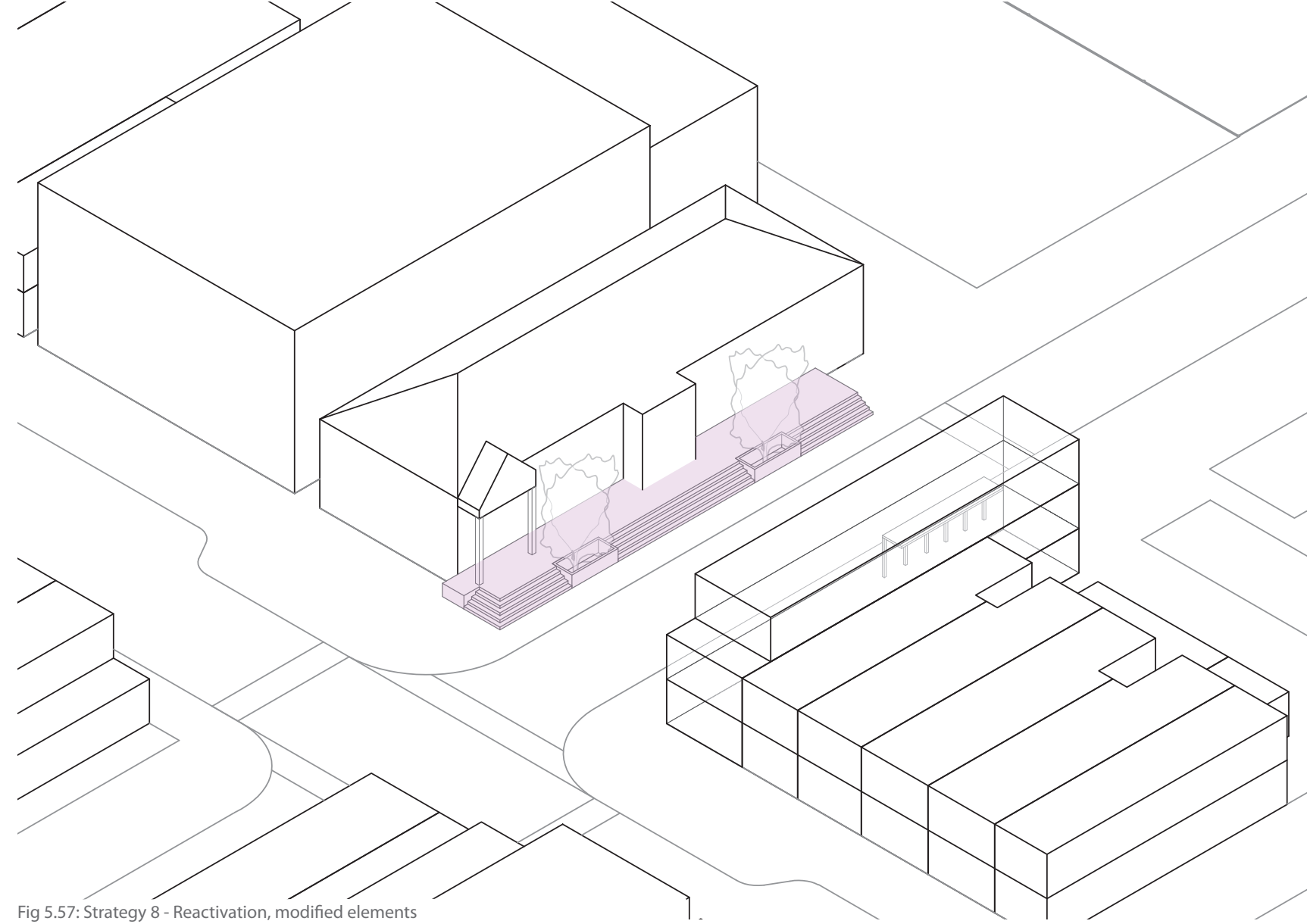


Fig 5.57: Strategy 8 - Reactivation, modified elements

Re-activation: Design new architectural/ urban elements

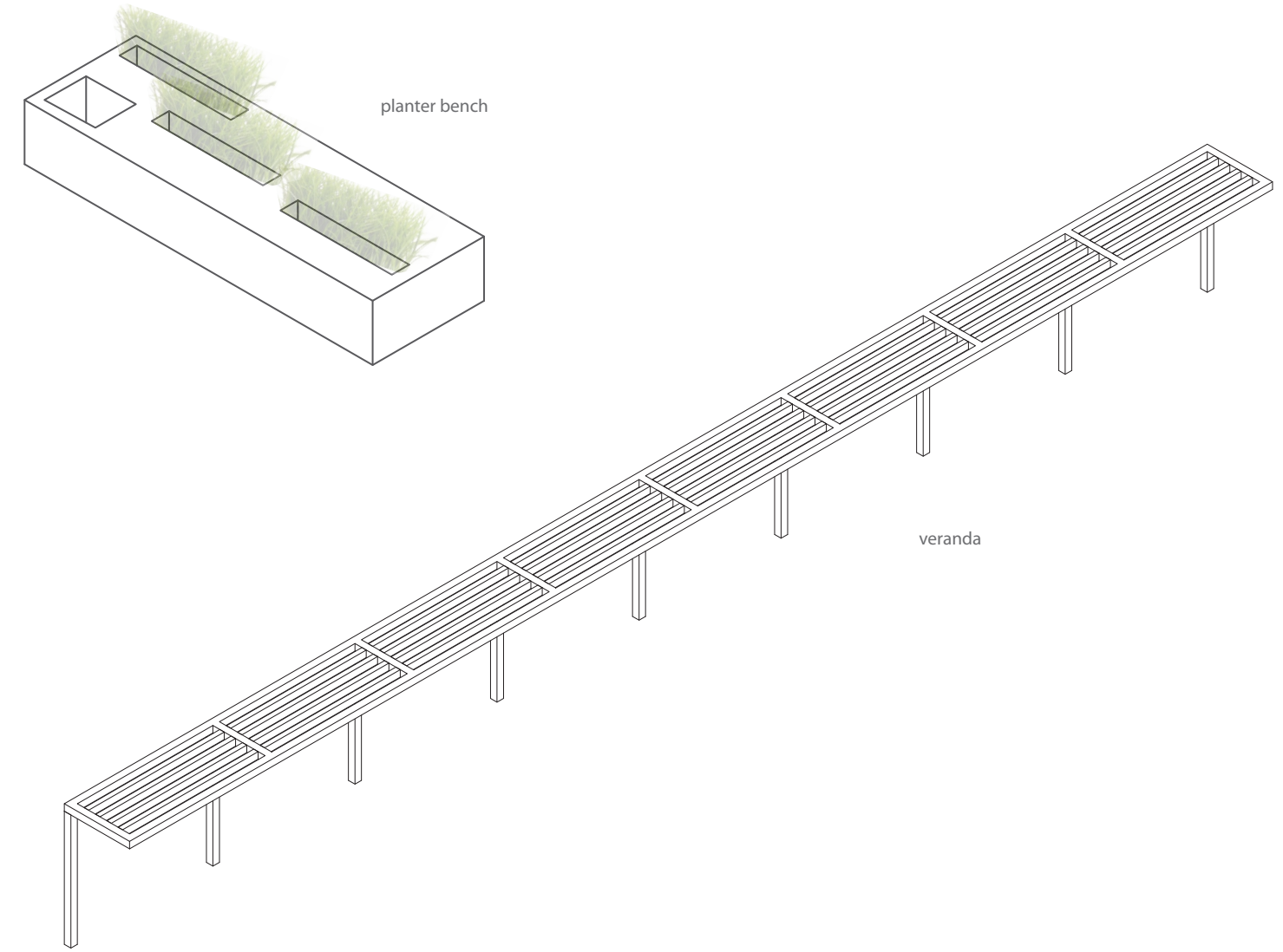


Fig 5.58: Strategy 9 - Reactivation, new elements

Re-activation: Refine new architectural/urban elements to create areas of gathering/ interaction (cultural exchange)

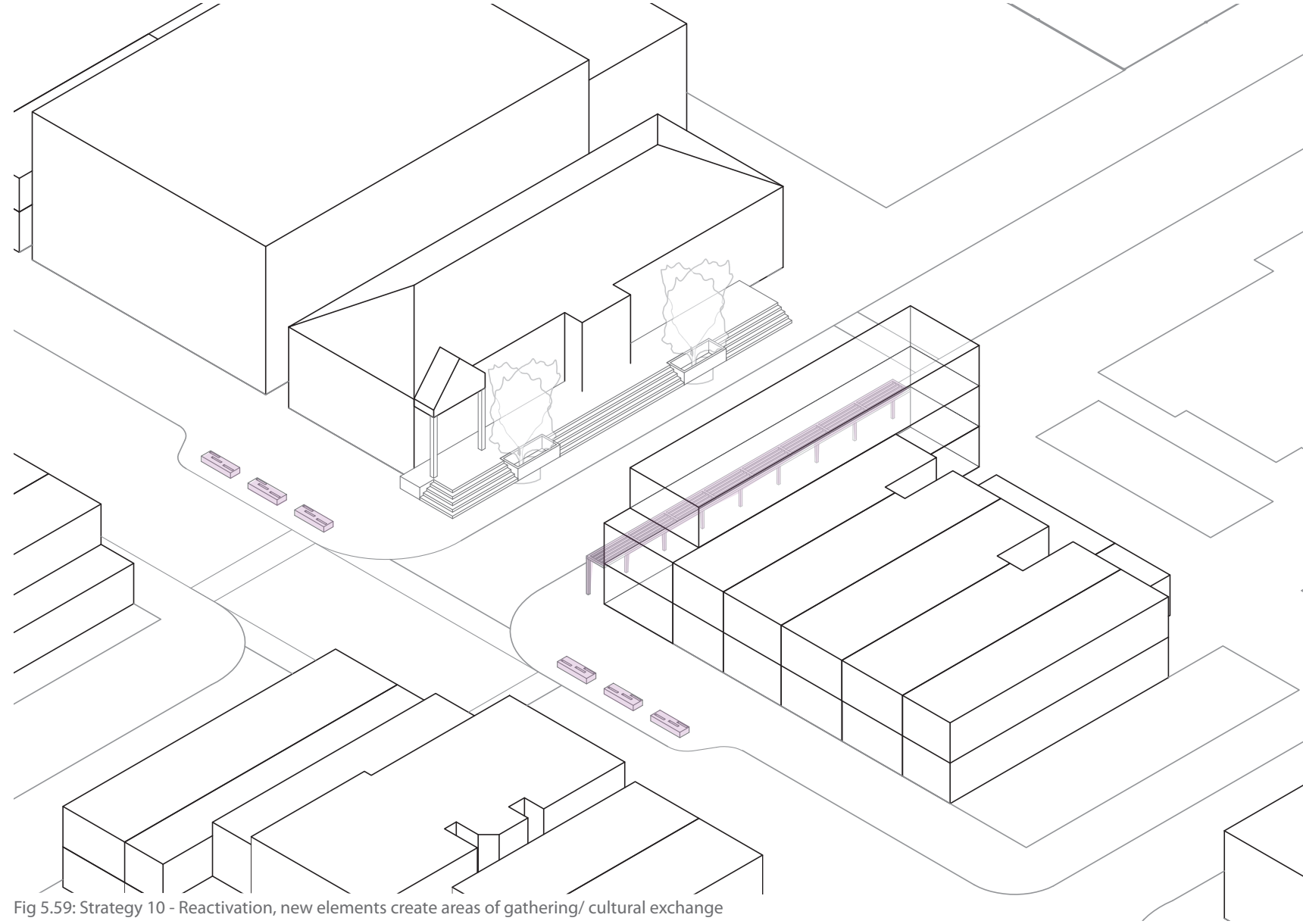


Fig 5.59: Strategy 10 - Reactivation, new elements create areas of gathering/ cultural exchange

Re-activation: design maneuvers

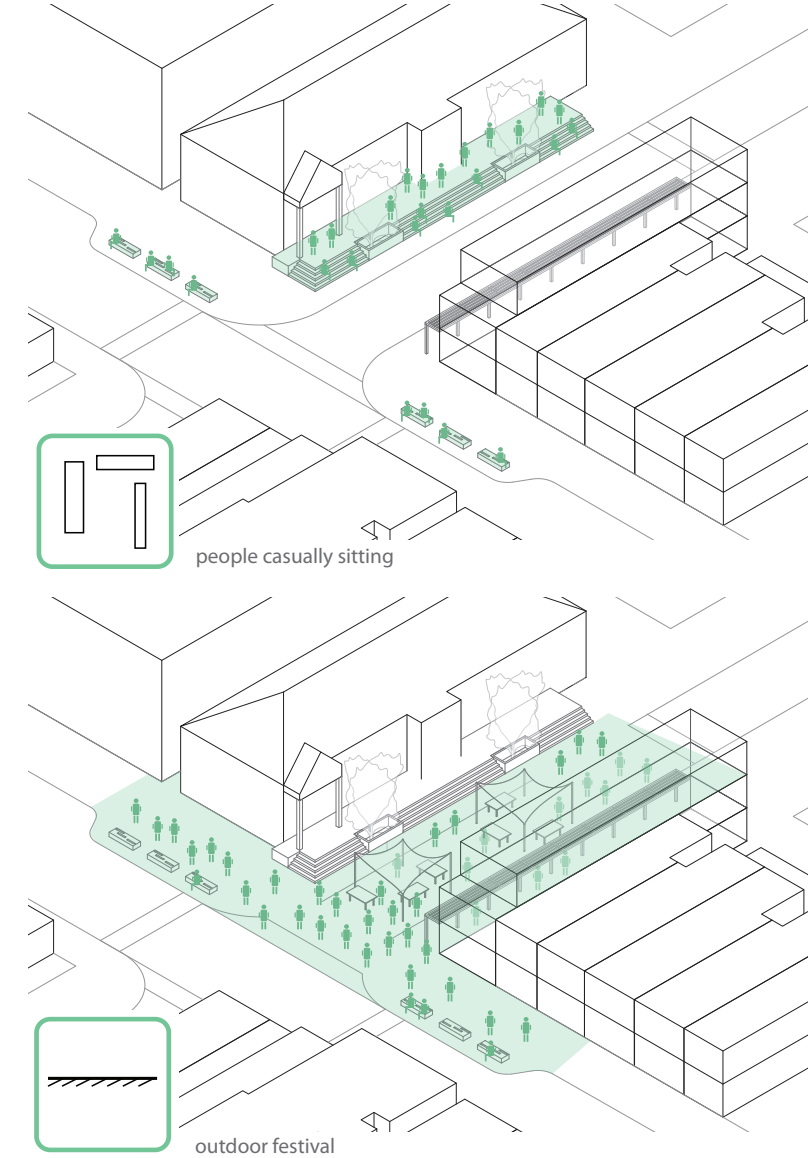


Fig 5.60: Reactivation design maneuvers

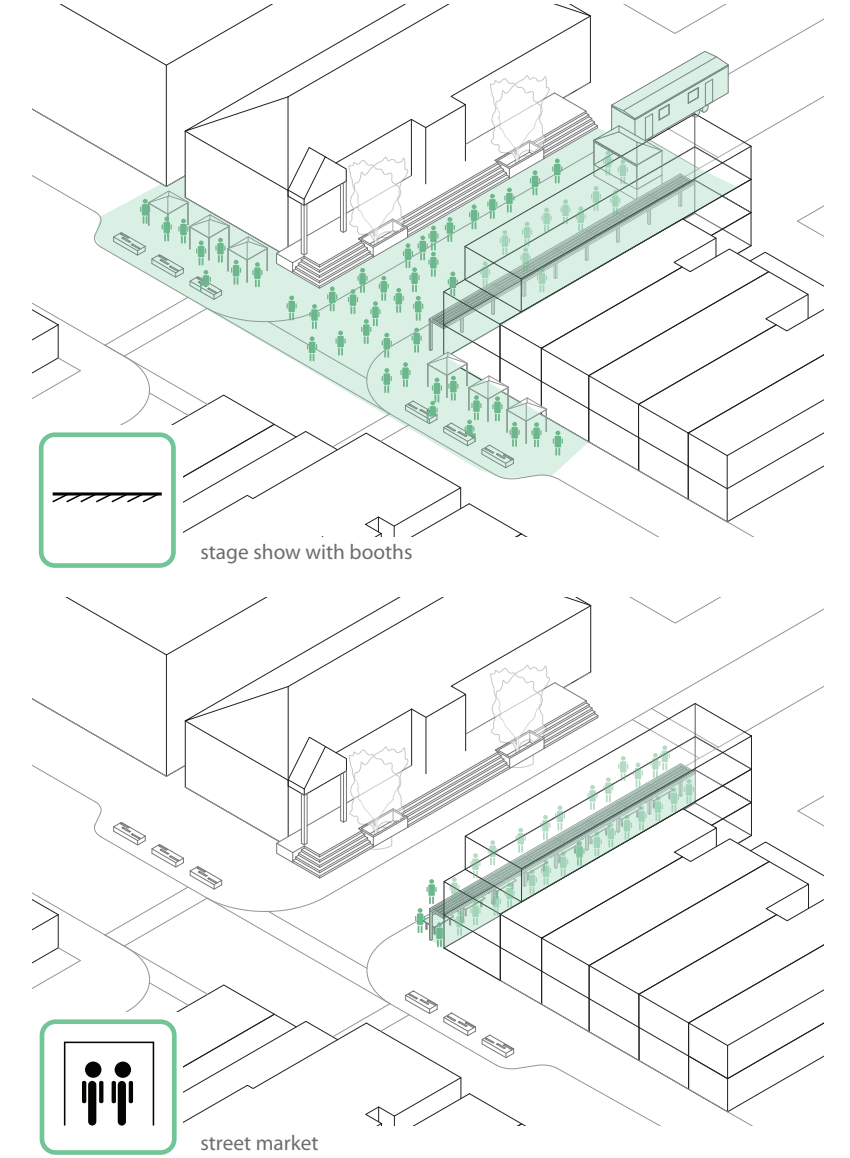




Fig 5.70: Reactivation, on a regular day



Fig 5.71: Reactivation, during a South Asian festival for youth



Fig 5.72: Reactivation, during Diwali/ Eid/ Vaisakhi



Fig 5.73: Reactivation, during a Christmas parade



Fig 5.74: Reactivation, during a street market

Design Intervention 2: Adaptive Re-use

Adaptive Re-use: Examine current site situations

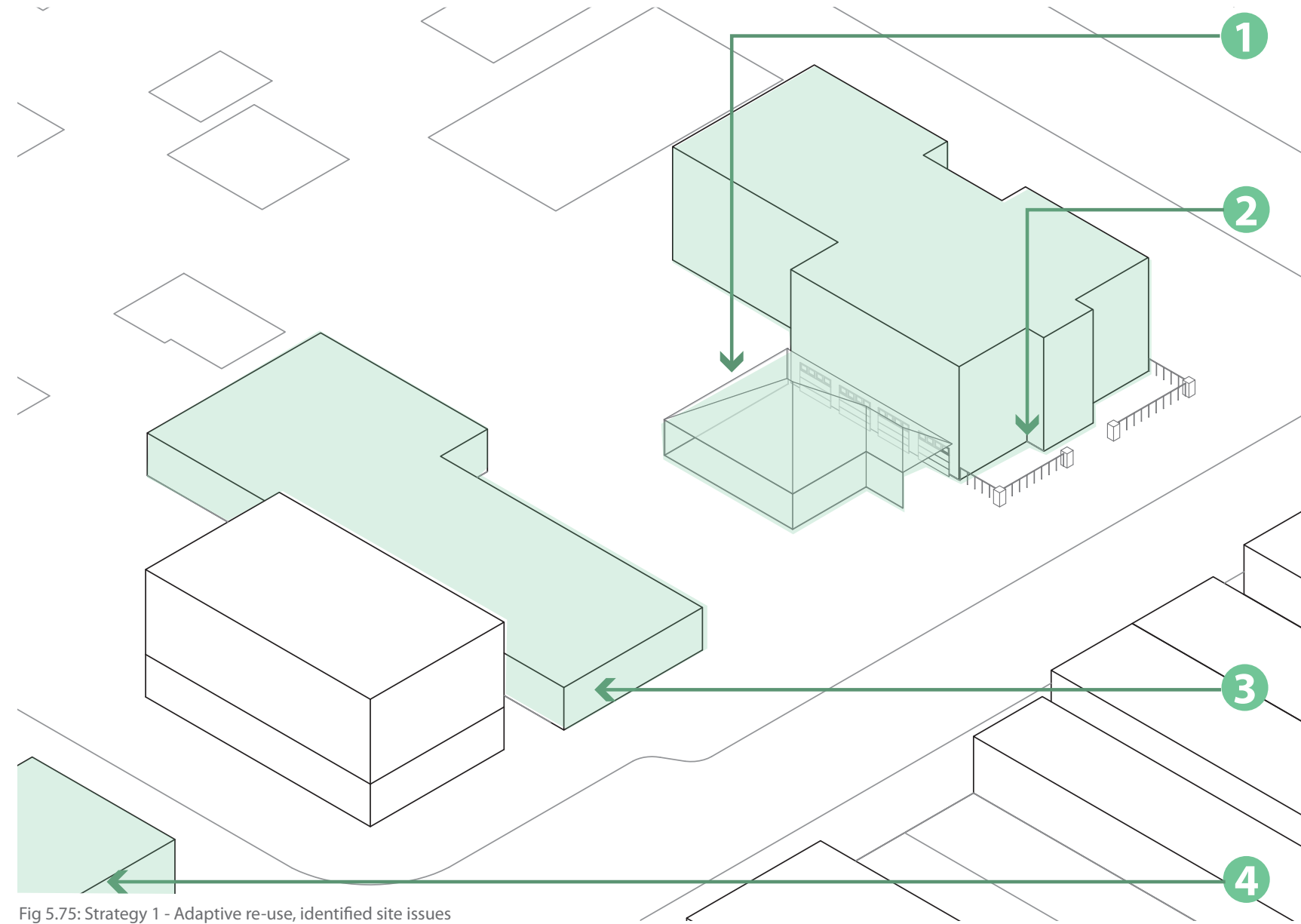


Fig 5.75: Strategy 1 - Adaptive re-use, identified site issues



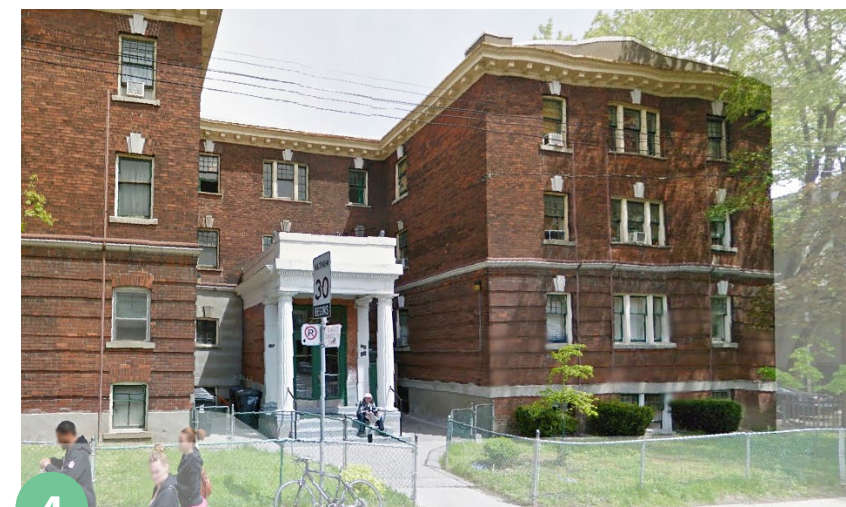
1 Tent outside of Lahore Tikka House restaurant isolates the lively dining crowd from the rest of the strip



2 Interesting cultural artifacts/ sculptures are only accessible to restaurant-goers



3 A vacant storefront contributes negatively to the image of the strip



4 Residents nearby don't have access to a common space of gathering for interaction among different user groups

Fig 5.76: Strategy 1 - Adaptive re-use, site images

Adaptive Re-use: Acknowledge personal input from key entities and other user groups

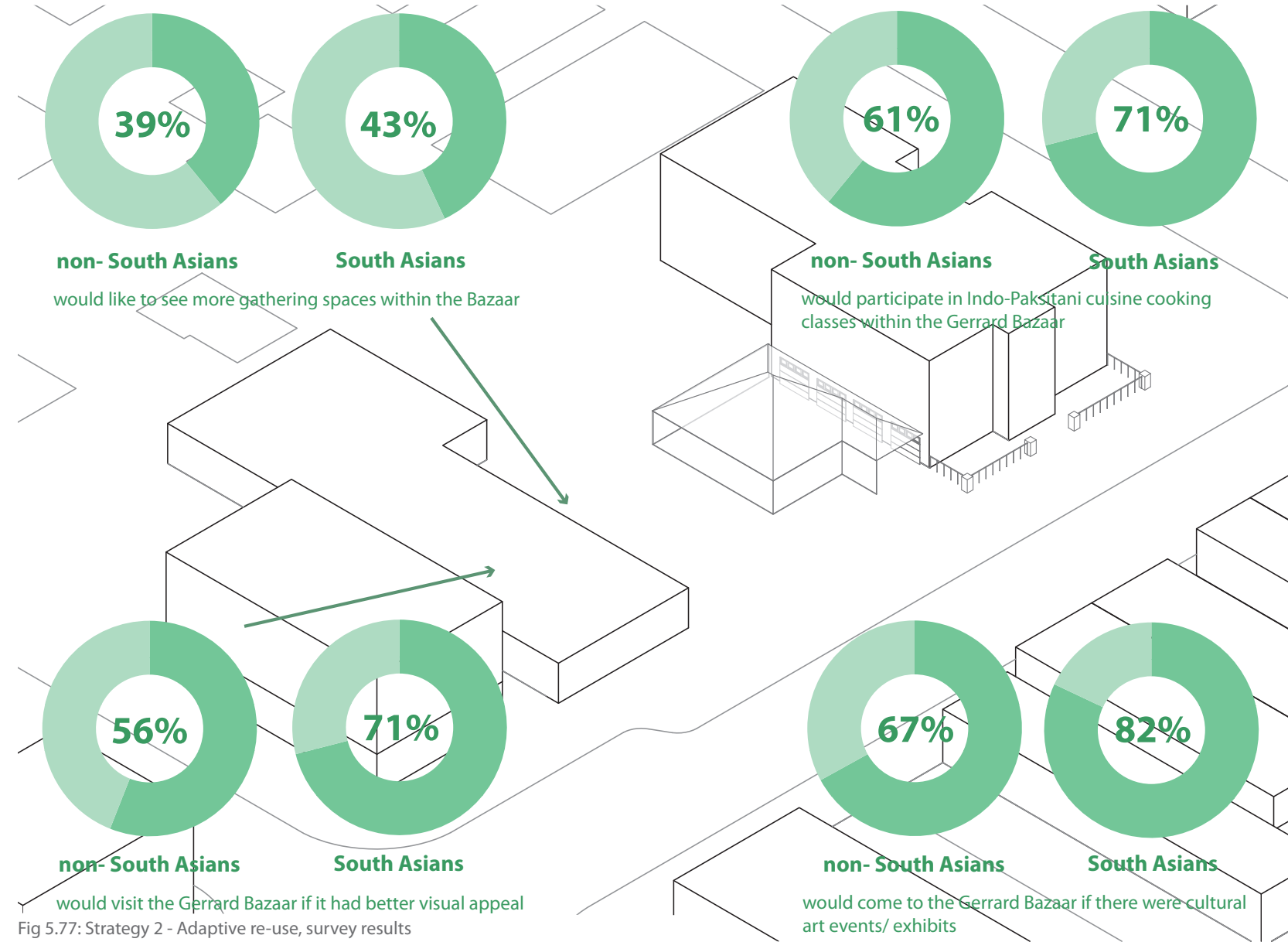


Fig 5.77: Strategy 2 - Adaptive re-use, survey results

The site interfaces with one of the most popular restaurants on the strip as well as an open, underutilized area of land that is used by this very restaurant. The restaurant is frequented by South Asians and non-South Asians alike. If a key program were to be housed within the site, not only would that building become **architecturally regenerated**, but a new complimentary public space can allow for a **synergy between the programs** housed within the new site as well as those that “spill out” from the restaurant. Survey results indicate that **non-South Asians are the most interested in South Asian cuisine** and would be **eager to engage** in related activities. The proposed design would serve as a platform for such activities to take place as well as those relating to art - thus **harmoniously blending South Asian cuisine with the newly developing arts scene along the strip.**

Adaptive Re-use: Acknowledge personal input from key entities and other user groups

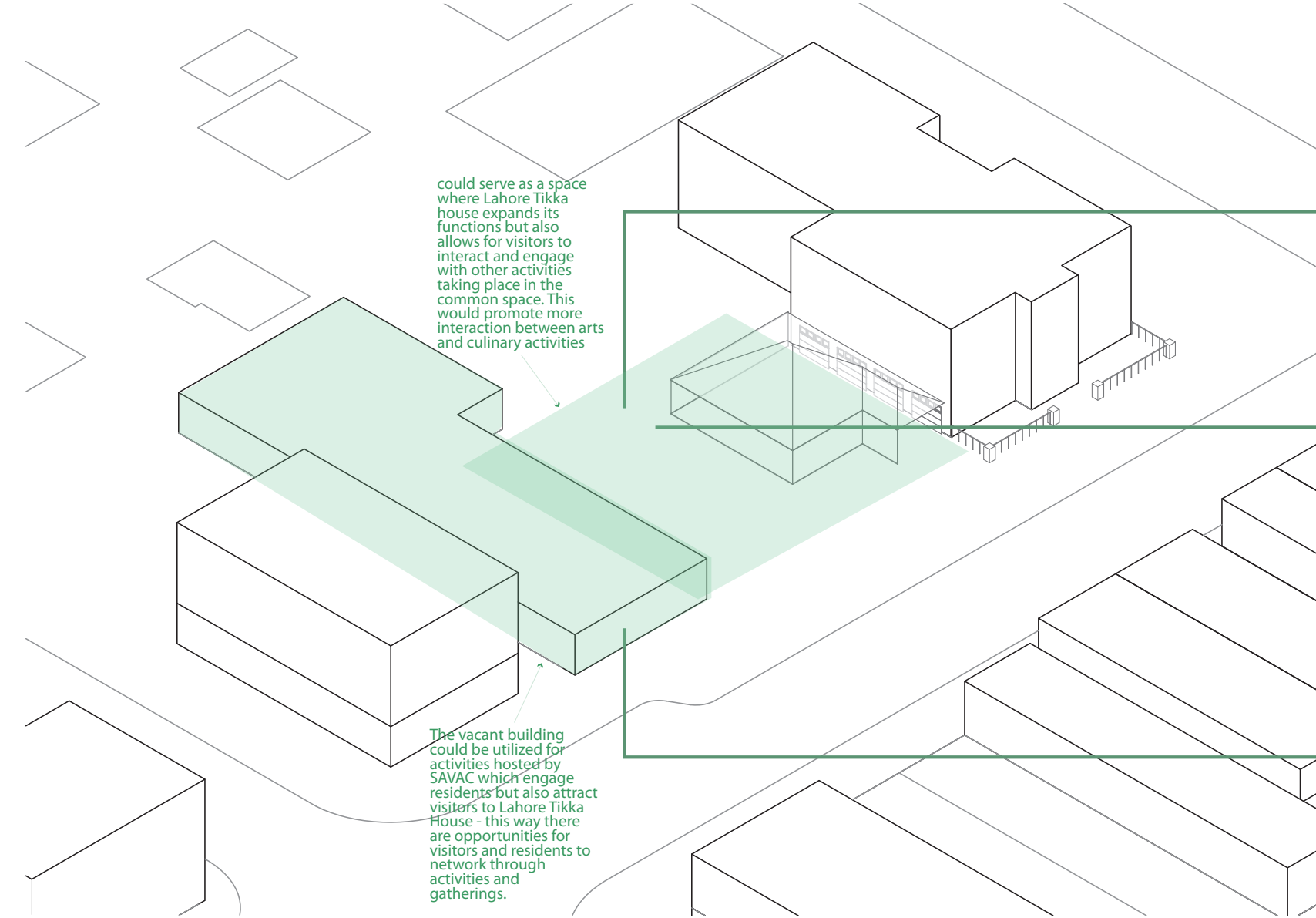
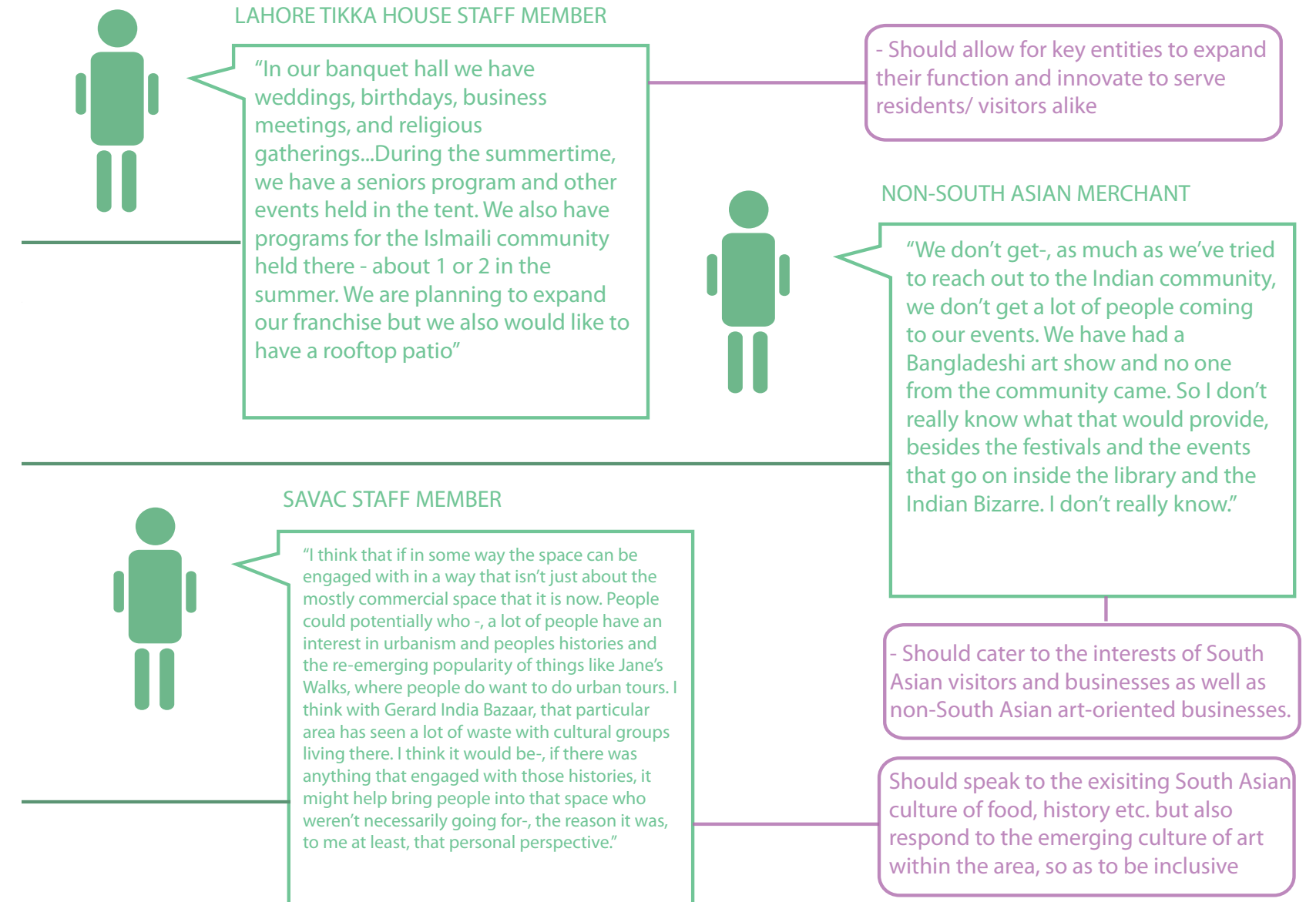


Fig 5.78: Strategy 2 - Adaptive re-use, personal perspectives



Adaptive Re-use: Define new entities among key entities and other user groups

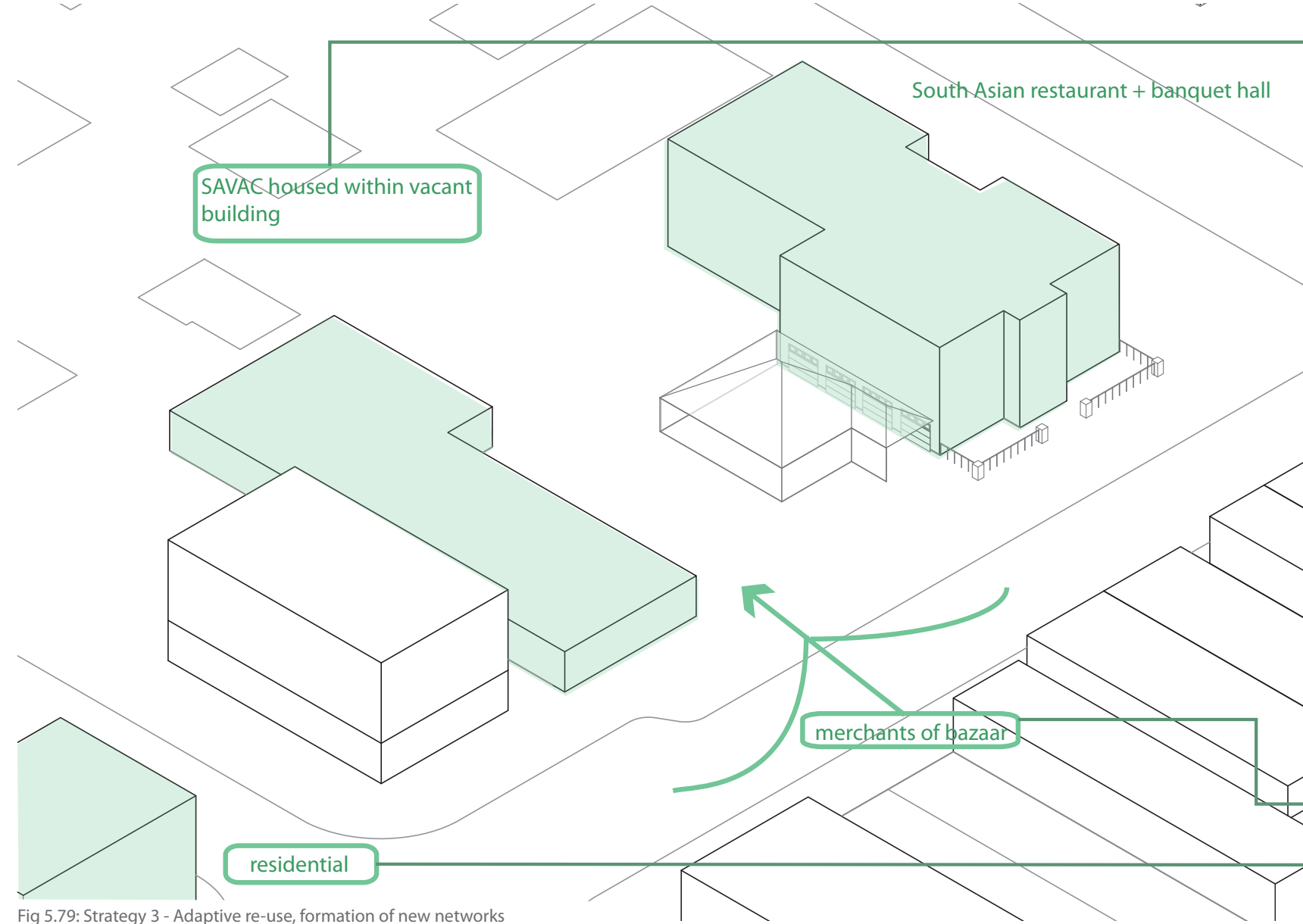
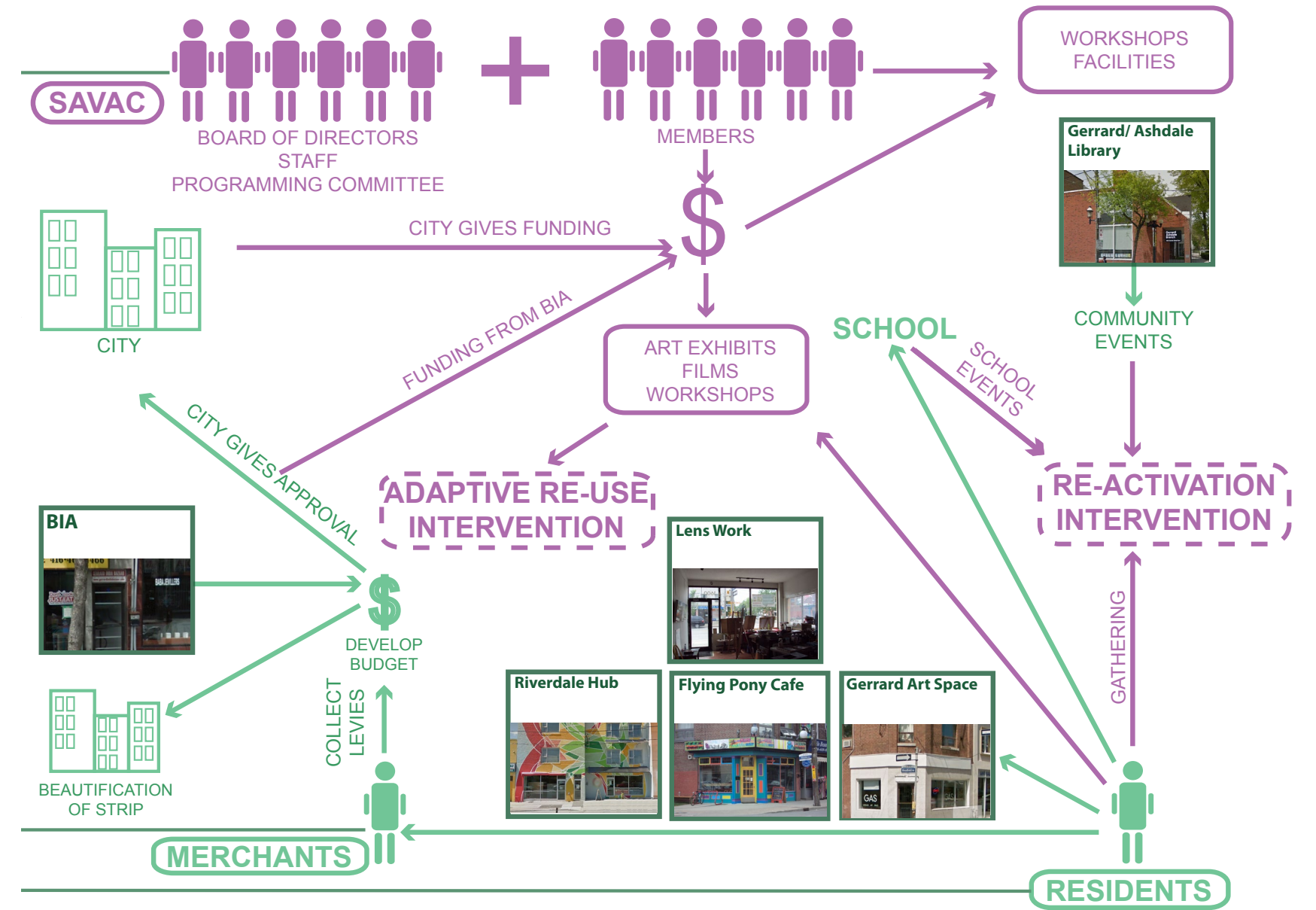


Fig 5.79: Strategy 3 - Adaptive re-use, formation of new networks



Adaptive Re-use: Identify vernacular/ traditional design maneuvers

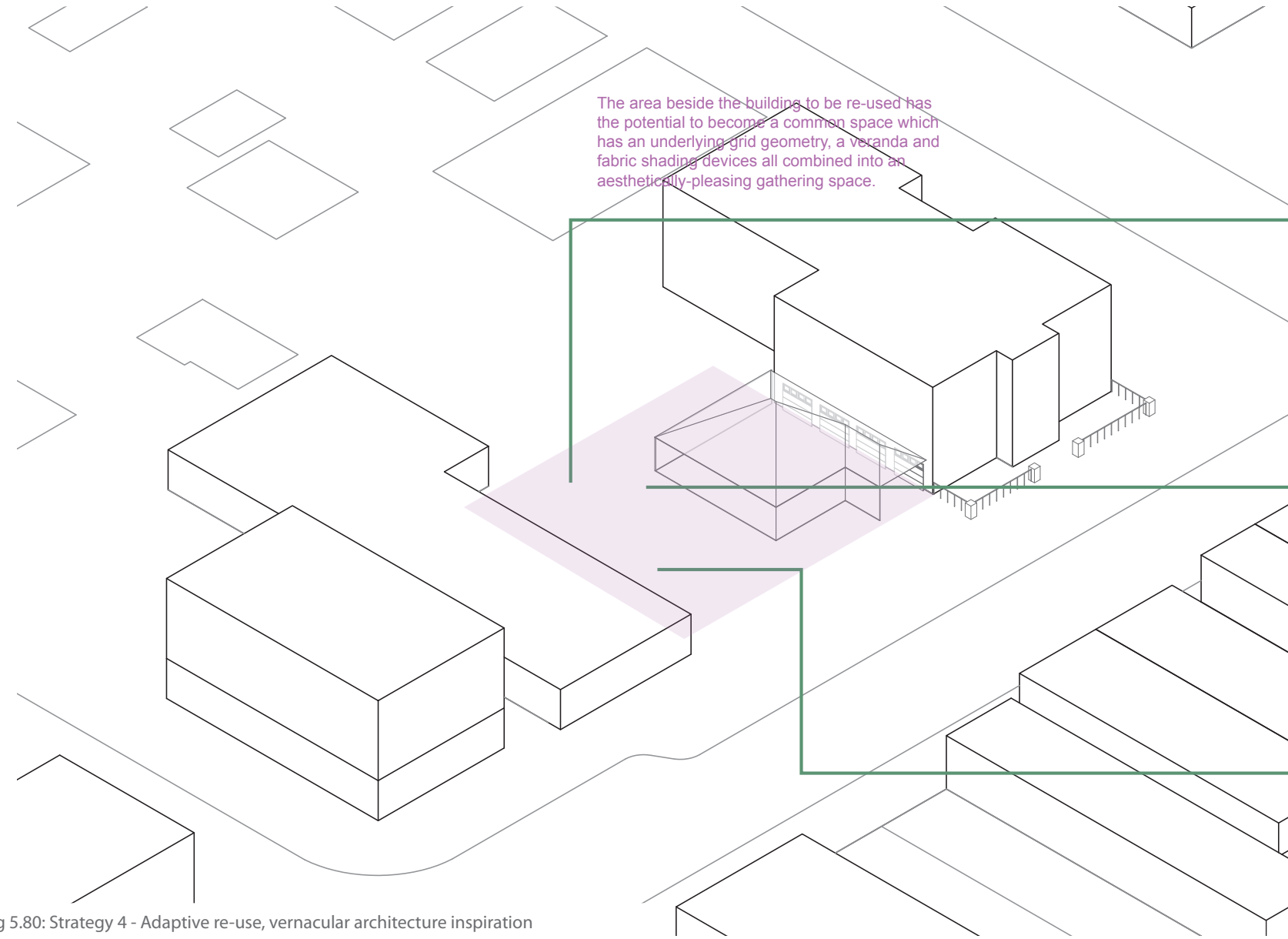


Fig 5.80: Strategy 4 - Adaptive re-use, vernacular architecture inspiration



Grid



Veranda



Fabric Shading Device



Adaptive Re-use: Identify local design maneuvers

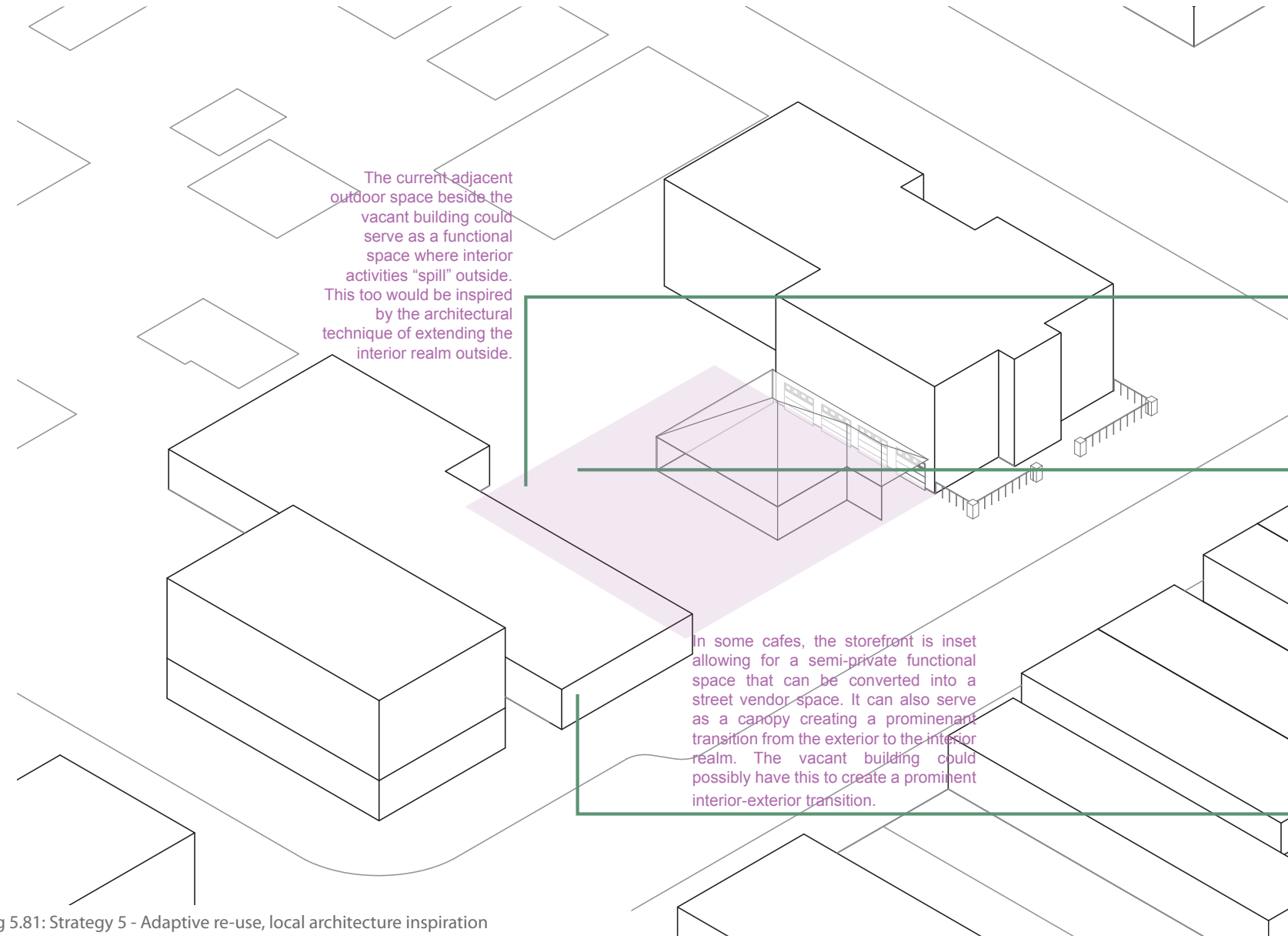
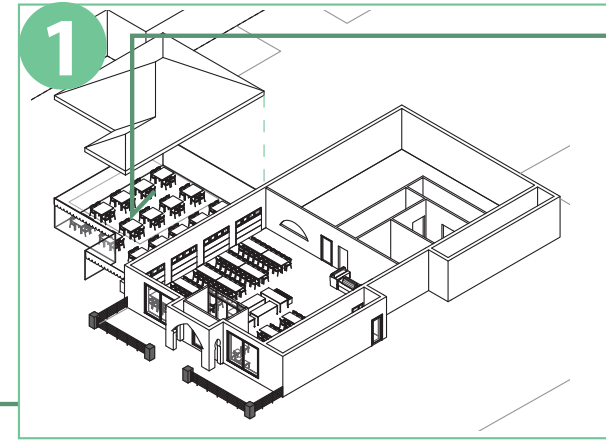
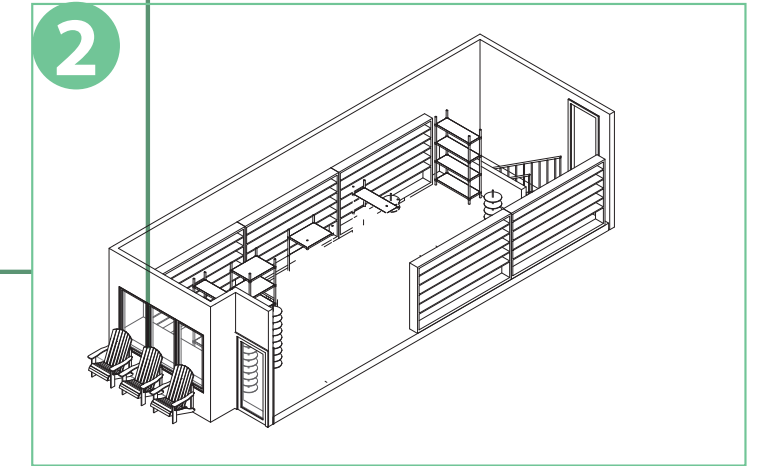


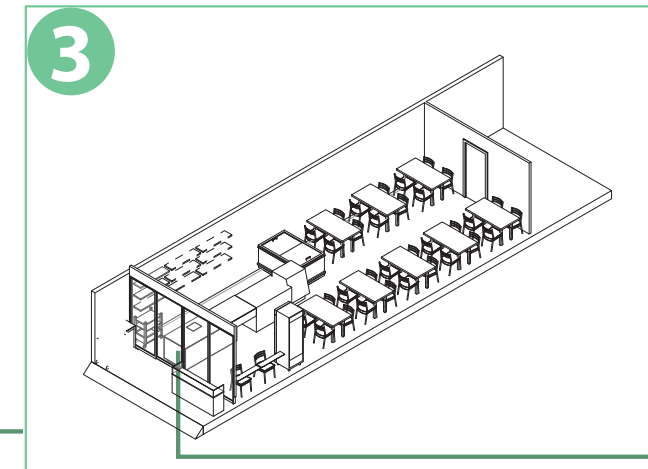
Fig 5.81: Strategy 5 - Adaptive re-use, local architecture inspiration



Lahore Tikka House -
Extension of interior realm



Swag Sisters Toy Store -
Extension of interior realm



Lahore Paan Centre -
Semi-private flexible space



Adaptive Re-use: Uncover underlying form/ site geometry to establish design constraints

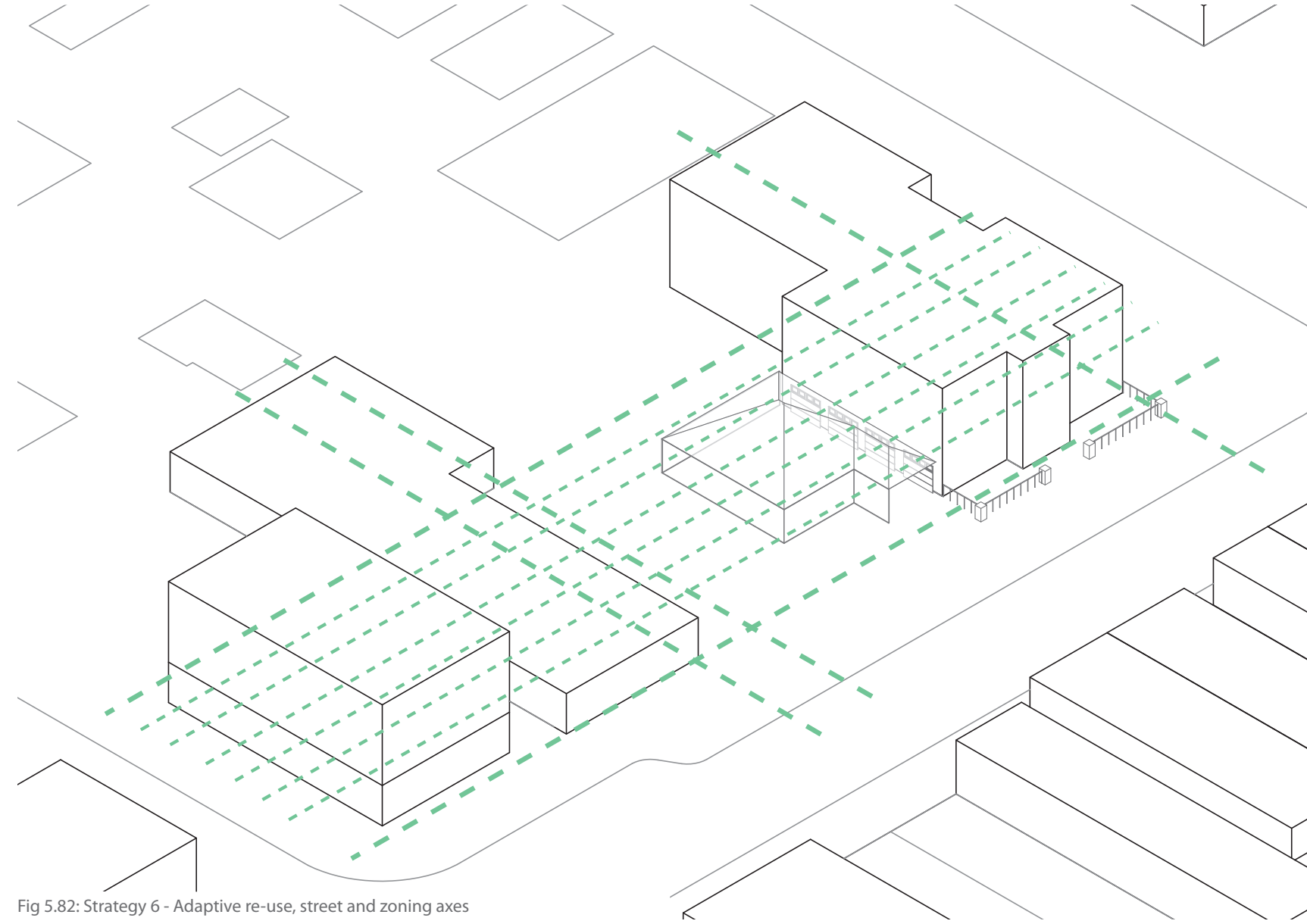


Fig 5.82: Strategy 6 - Adaptive re-use, street and zoning axes

Adaptive Re-use: Re-surface/ modify the ground plane to create new spatial relationships

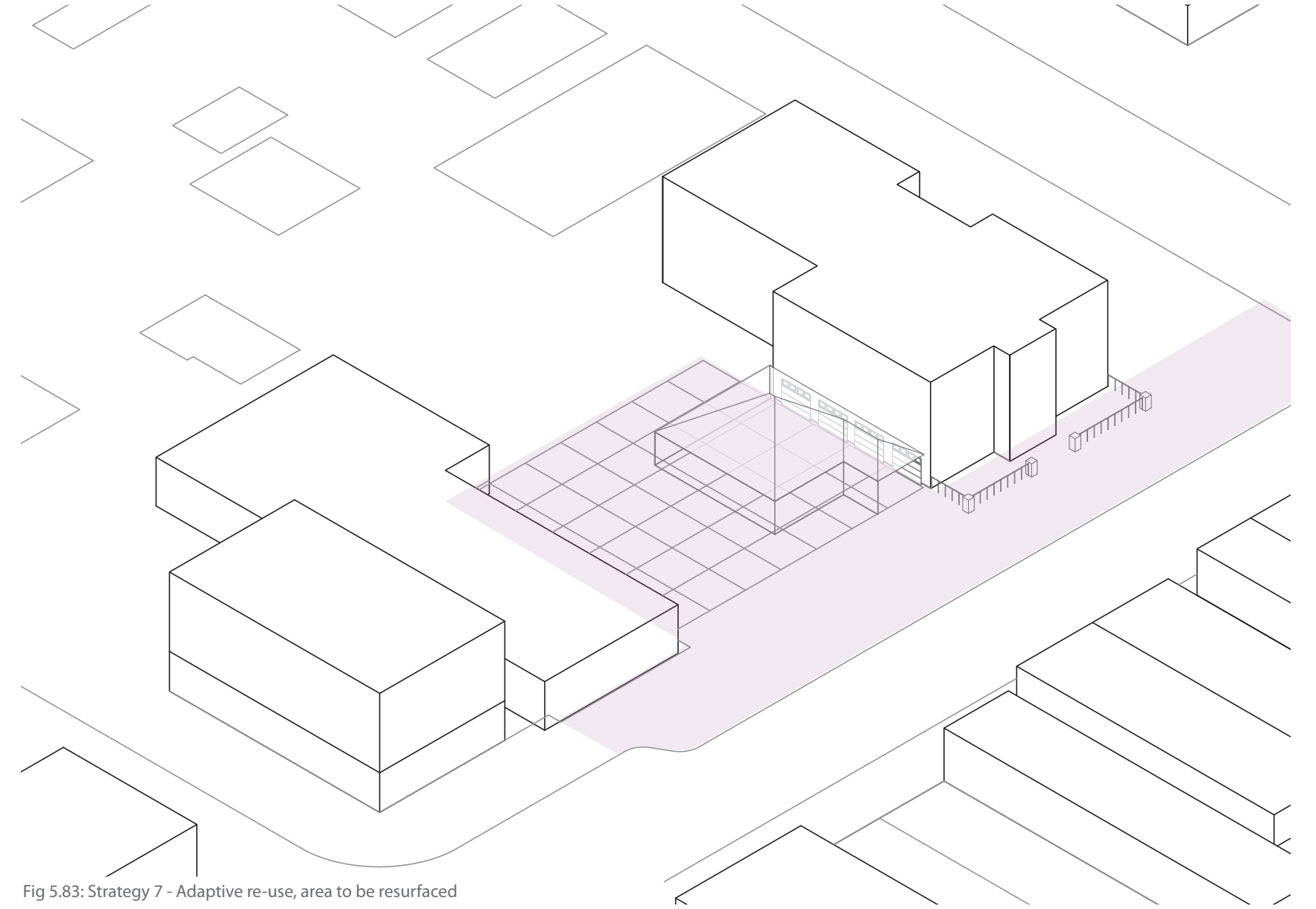


Fig 5.83: Strategy 7 - Adaptive re-use, area to be resurfaced

Adaptive Re-use: Modify site specific elements to make them more accessible

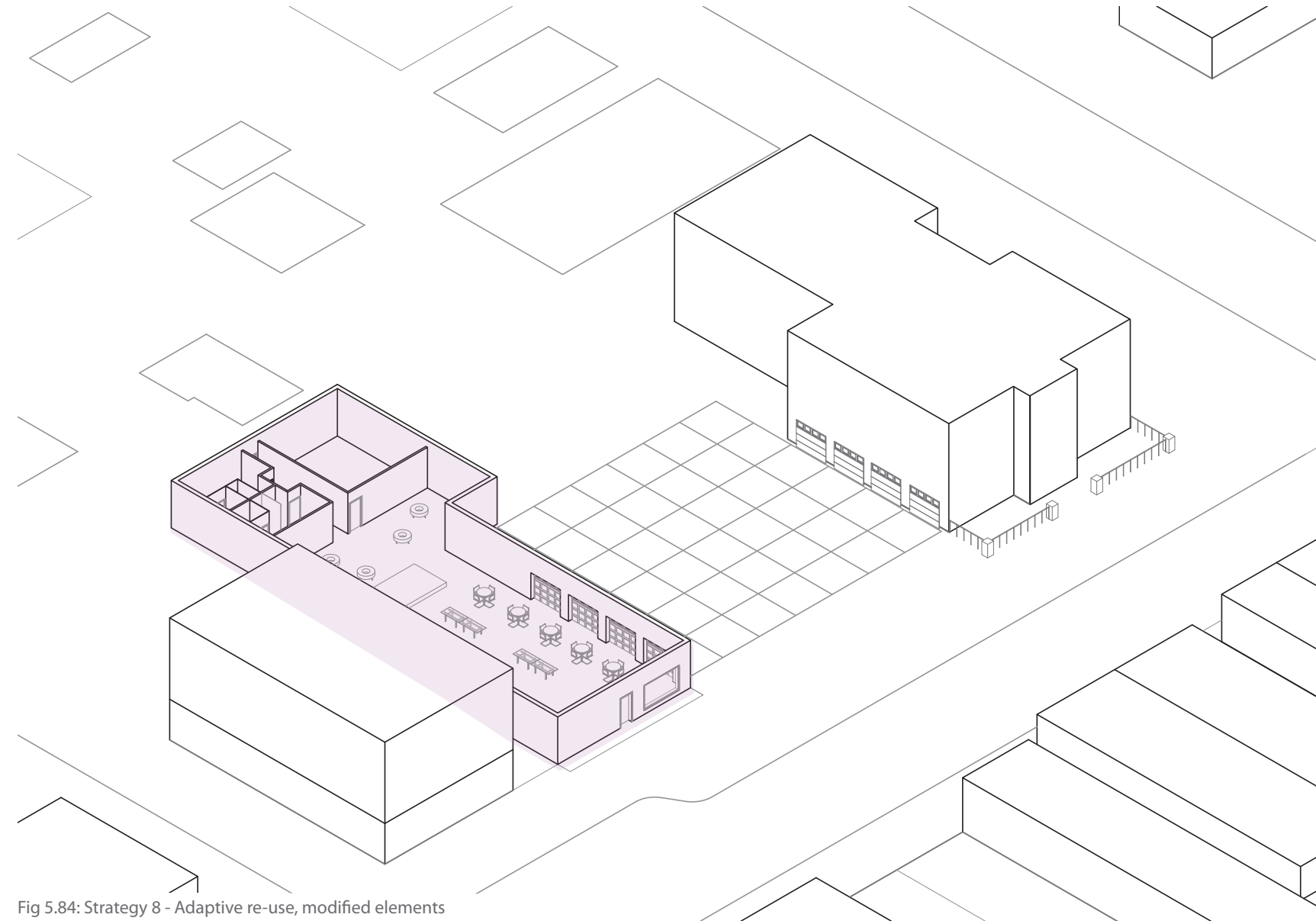


Fig 5.84: Strategy 8 - Adaptive re-use, modified elements

Adaptive Re-use: Design new architectural/ urban elements

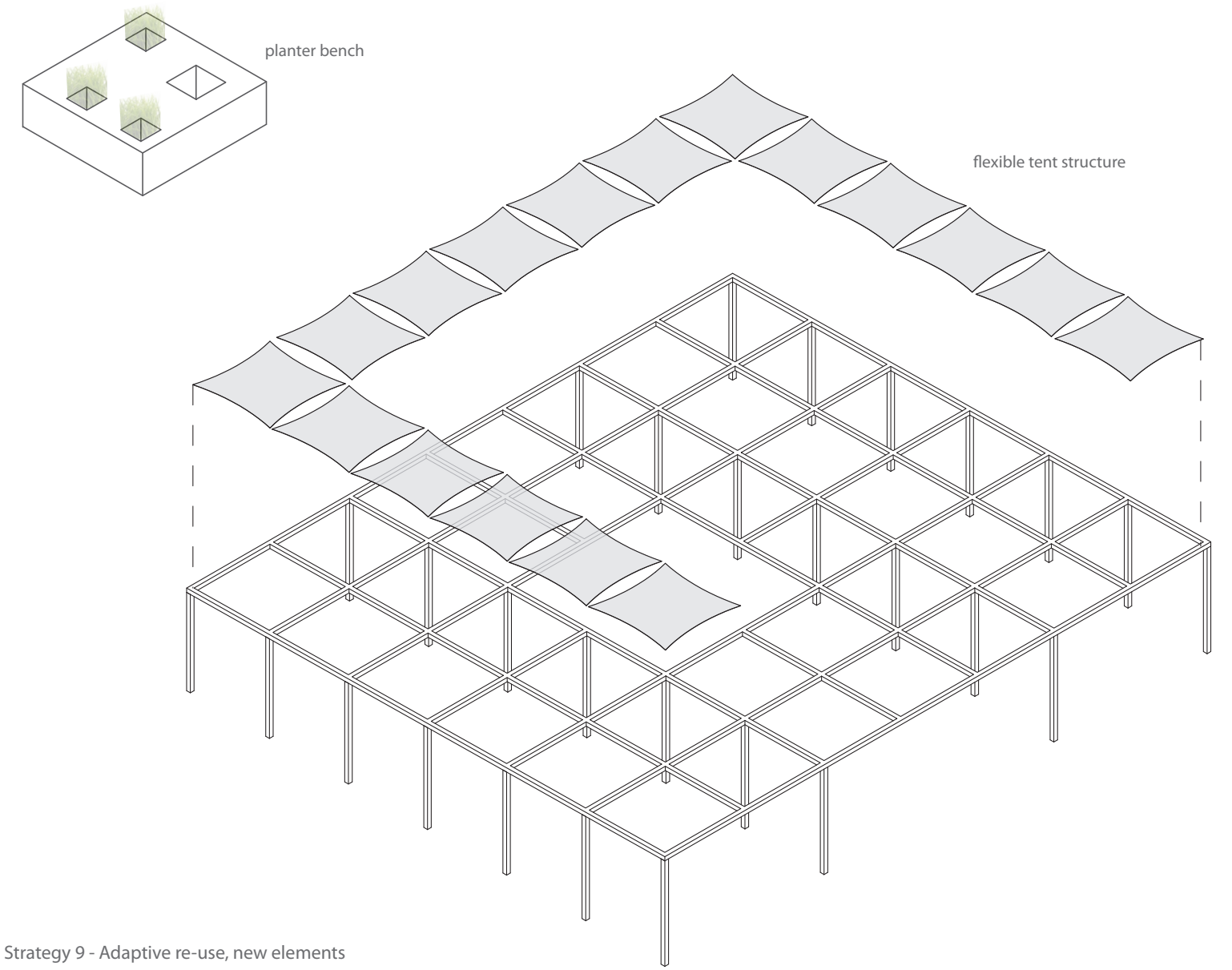


Fig 5.85: Strategy 9 - Adaptive re-use, new elements

Adaptive Re-use: Refine new architectural/urban elements to create areas of gathering/ interaction (cultural exchange)

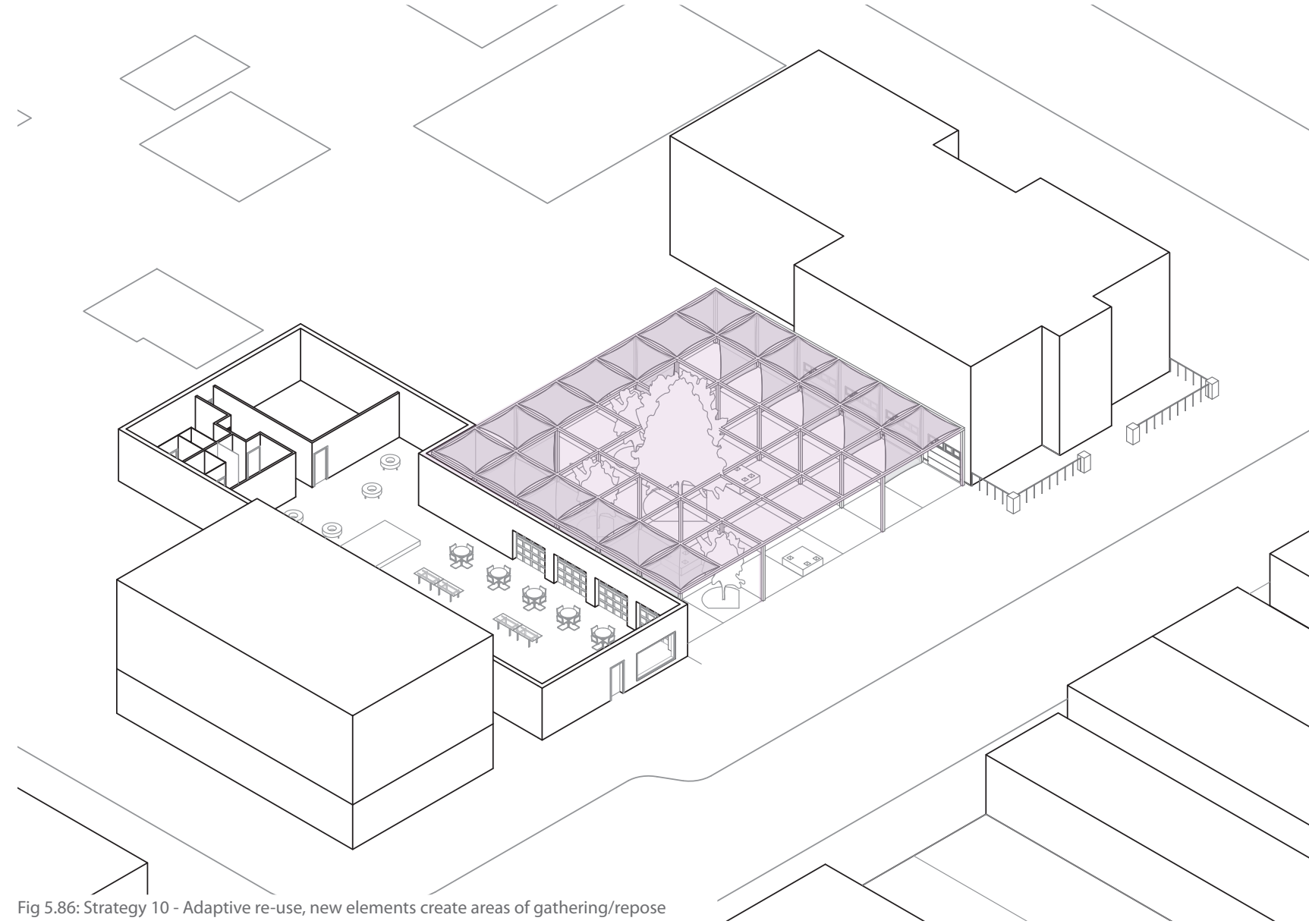


Fig 5.86: Strategy 10 - Adaptive re-use, new elements create areas of gathering/repose

Adaptive re-use: design maneuvers

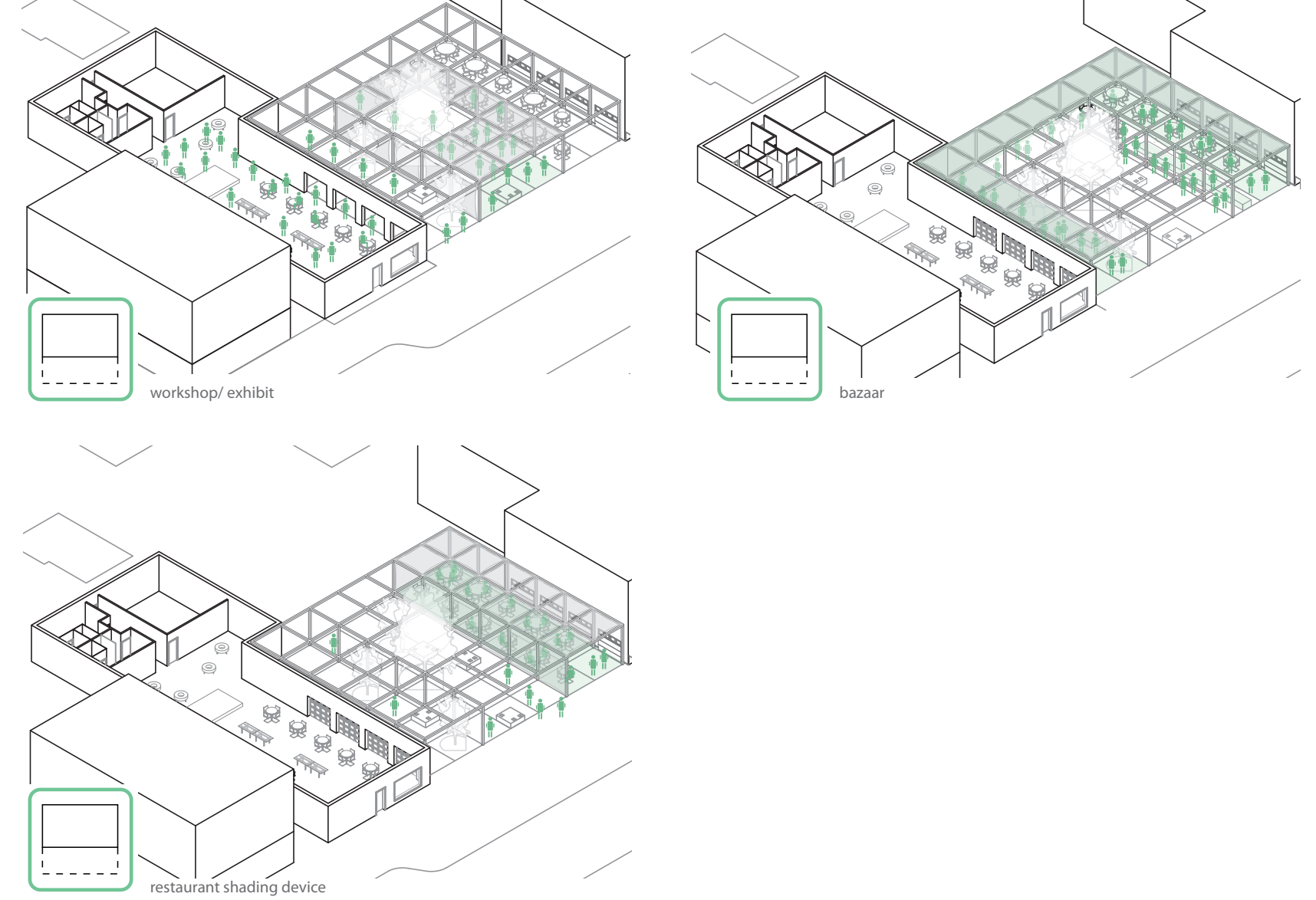


Fig 5.87: Adaptive re-use design maneuvers

Adaptive re-use: design maneuvers

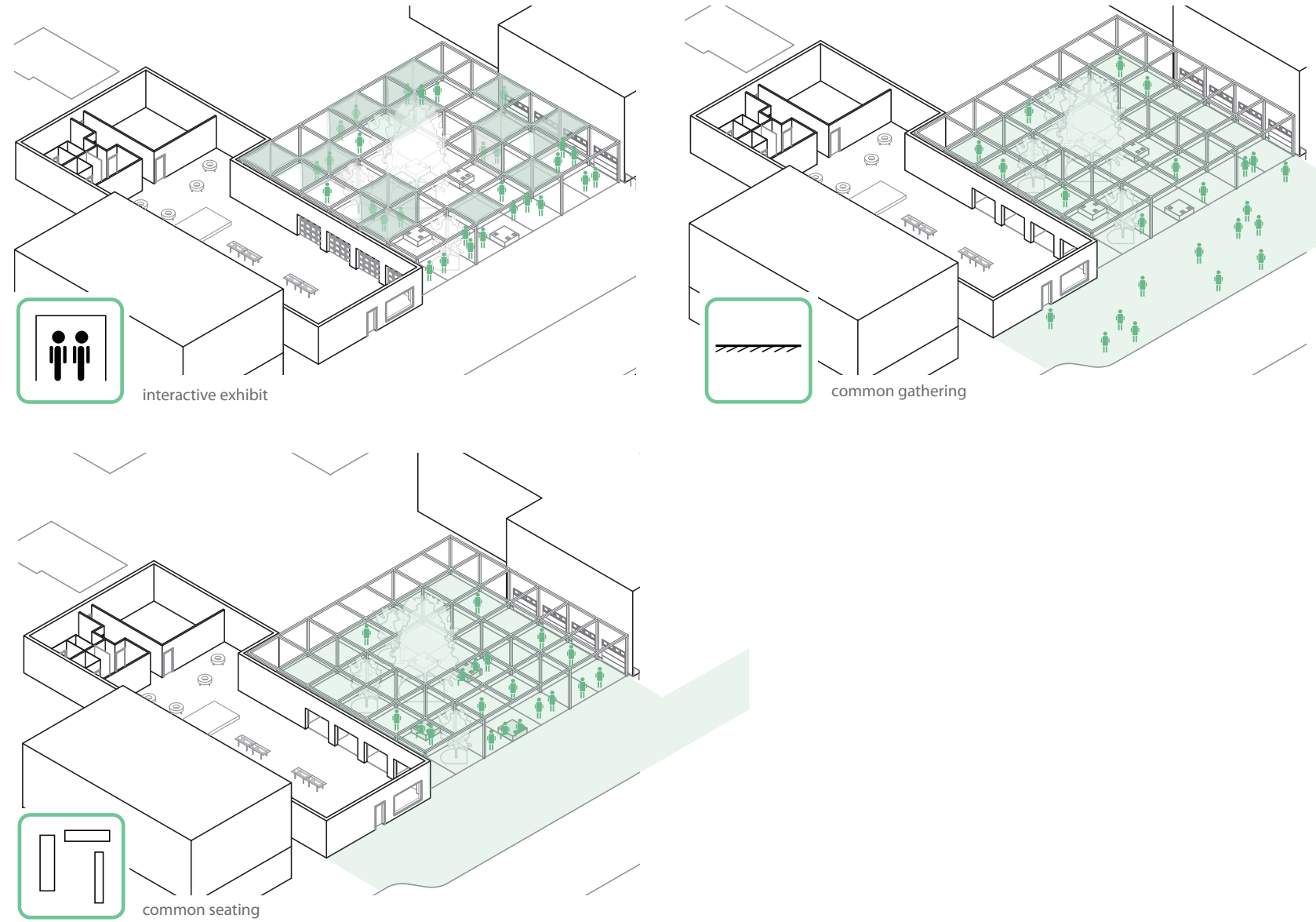


Fig 5.88: Adaptive re-use design maneuvers



Fig 5.89: Adaptive re-use: on a regular Winter's day



Fig 5.90: Adaptive re-use: on a regular Summer's day



Fig 5.91: Adaptive re-use: during a SAVAC art exhibit event



Fig 5.92: Adaptive re-use: during Eid



Fig 5.93: Adaptive re-use: during a Indo-Pakistani cooking workshop

Design Intervention 3: Re-imagine

Re-Imagine: Examine current site situations

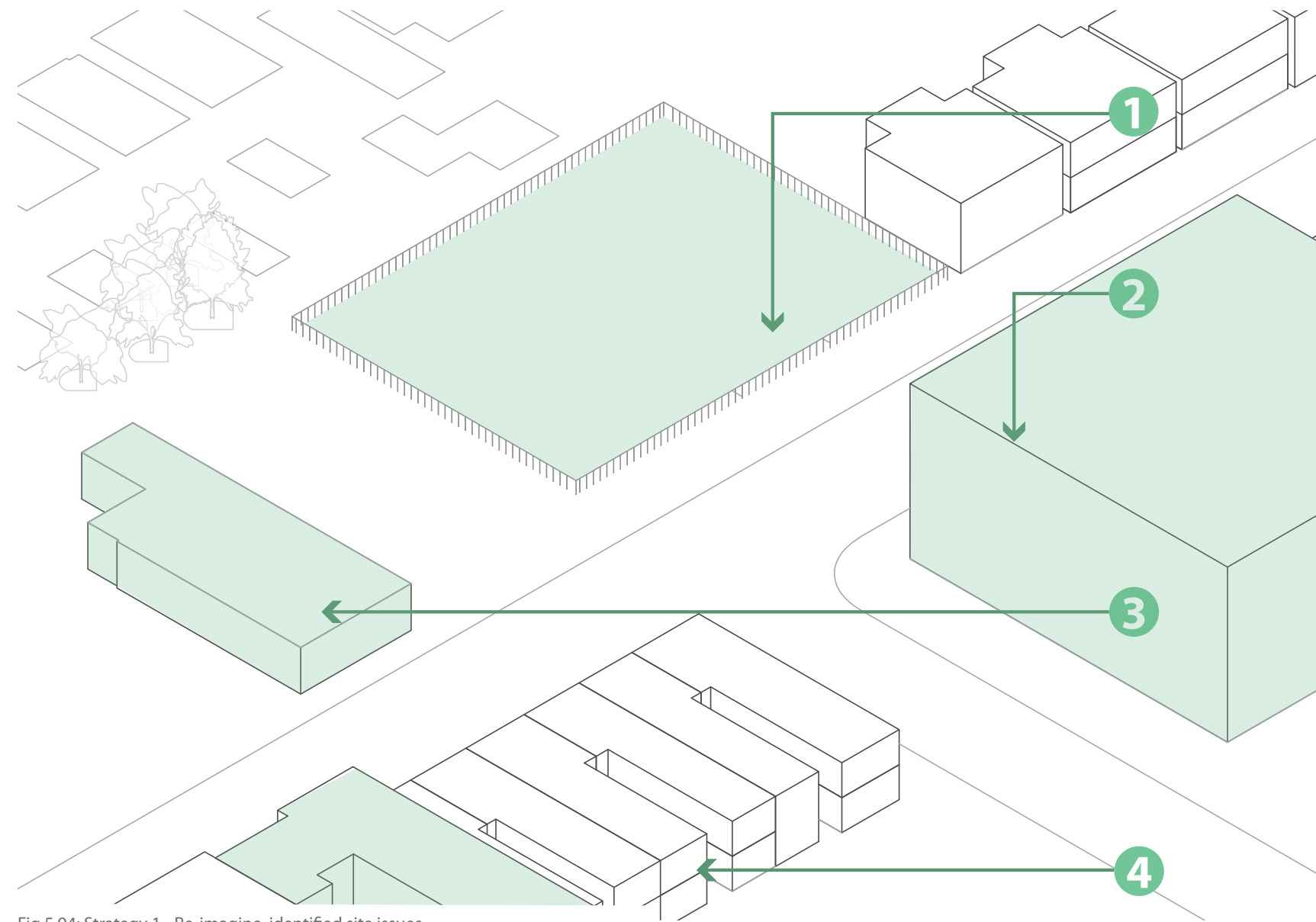


Fig 5.94: Strategy 1 - Re-imagine, identified site issues



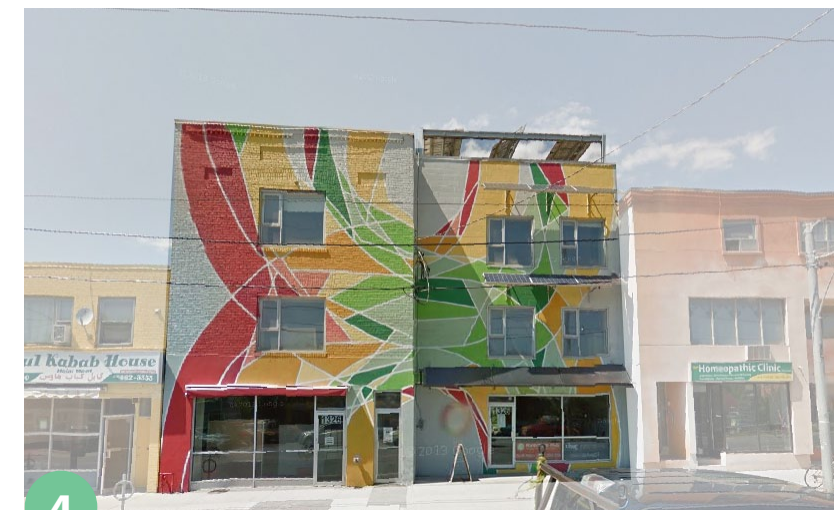
1 Area to be developed is fenced off and contributes to lack of aesthetic appeal in the area



2 A mixed-use residential building is directly opposite the site which can compliment the senior residential complex



3 A vacant tavern lies to the east of the site. It is used by a church group, for their regular meetings.



4 The Riverdale Hub stands opposite and can be a key player in the operations of the new design intervention

Fig 5.95: Strategy 1 - Re-imagine, site images

Re-Imagine: Acknowledge personal input from key entities and other user groups

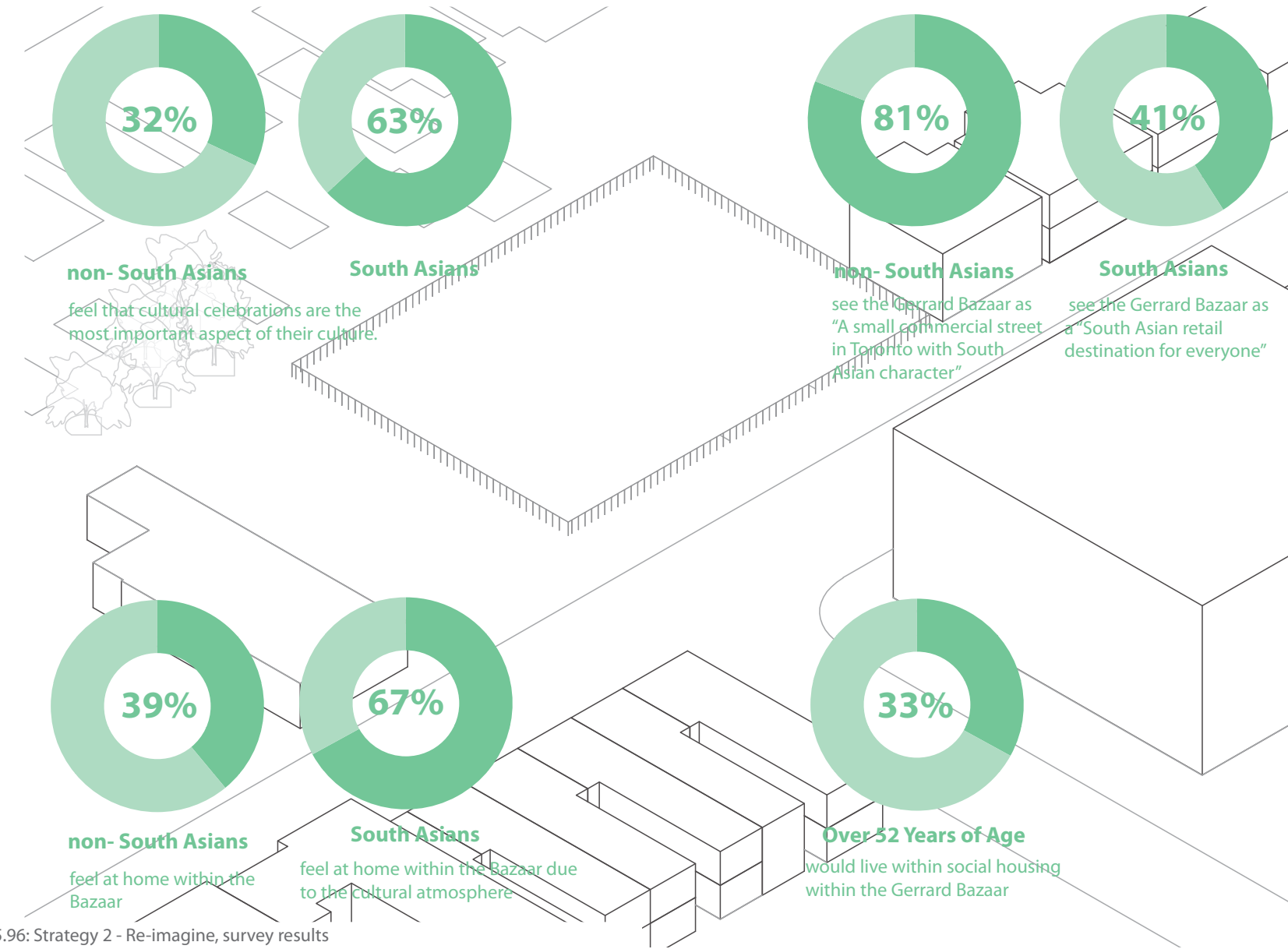


Fig 5.96: Strategy 2 - Re-imagine, survey results

It is obvious that the majority of residents are non-South Asian and that gentrification is slowly transforming the strip. The cultural celebrations and other important events attract South Asians to visit even though they feel at home when they are within the ethnic enclave. If South Asian businesses are no longer the key to saving the ethnicity of the enclave, then a solution could be to **promote more spectacle or inject a South Asian populous** within the neighbourhood. Combining this with **amenities that are catered to everyone** would allow for a powerful combination of programs that would **stimulate the function and identity of the Bazaar.**

Re-Imagine: Acknowledge personal input from key entities and other user groups

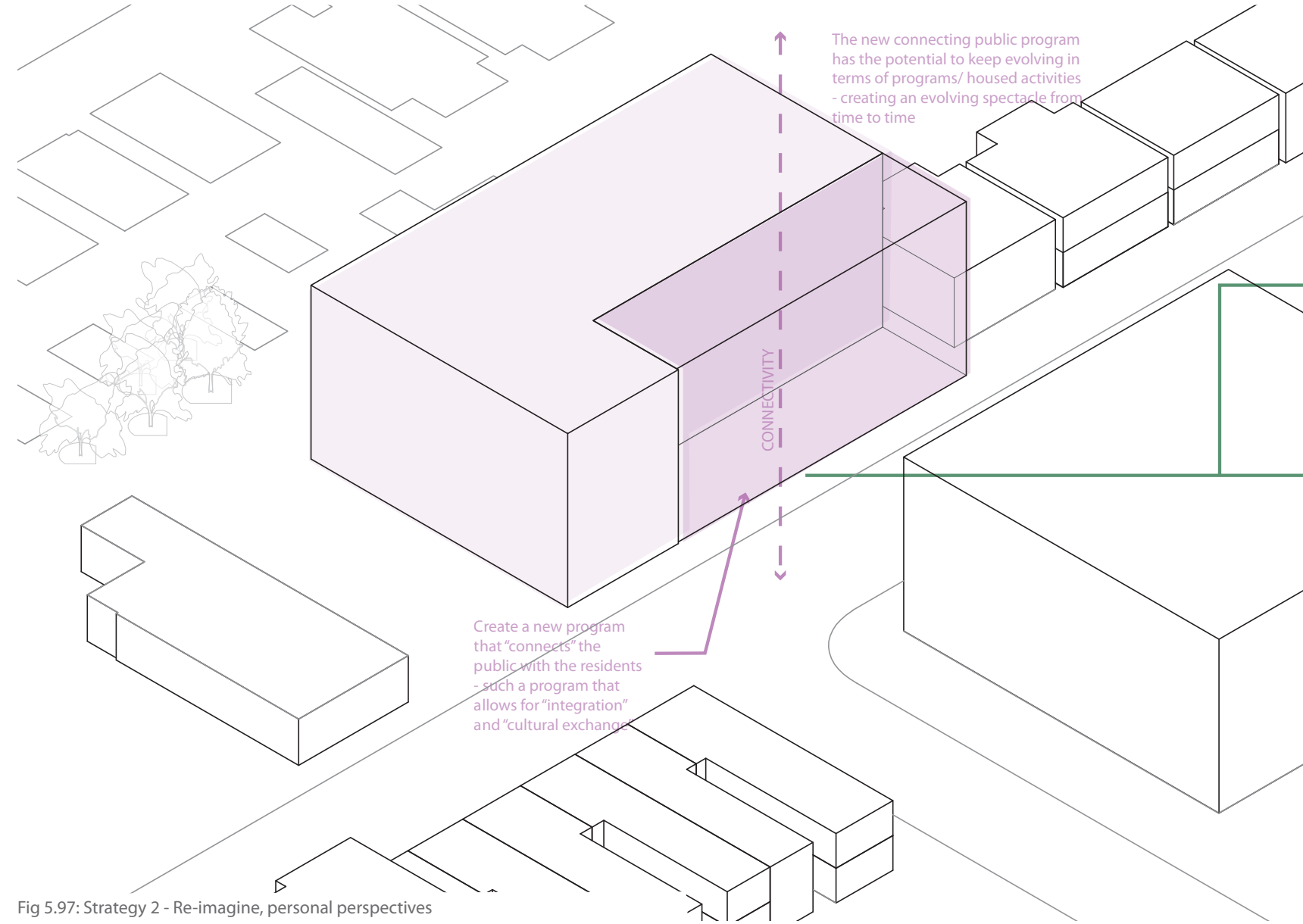
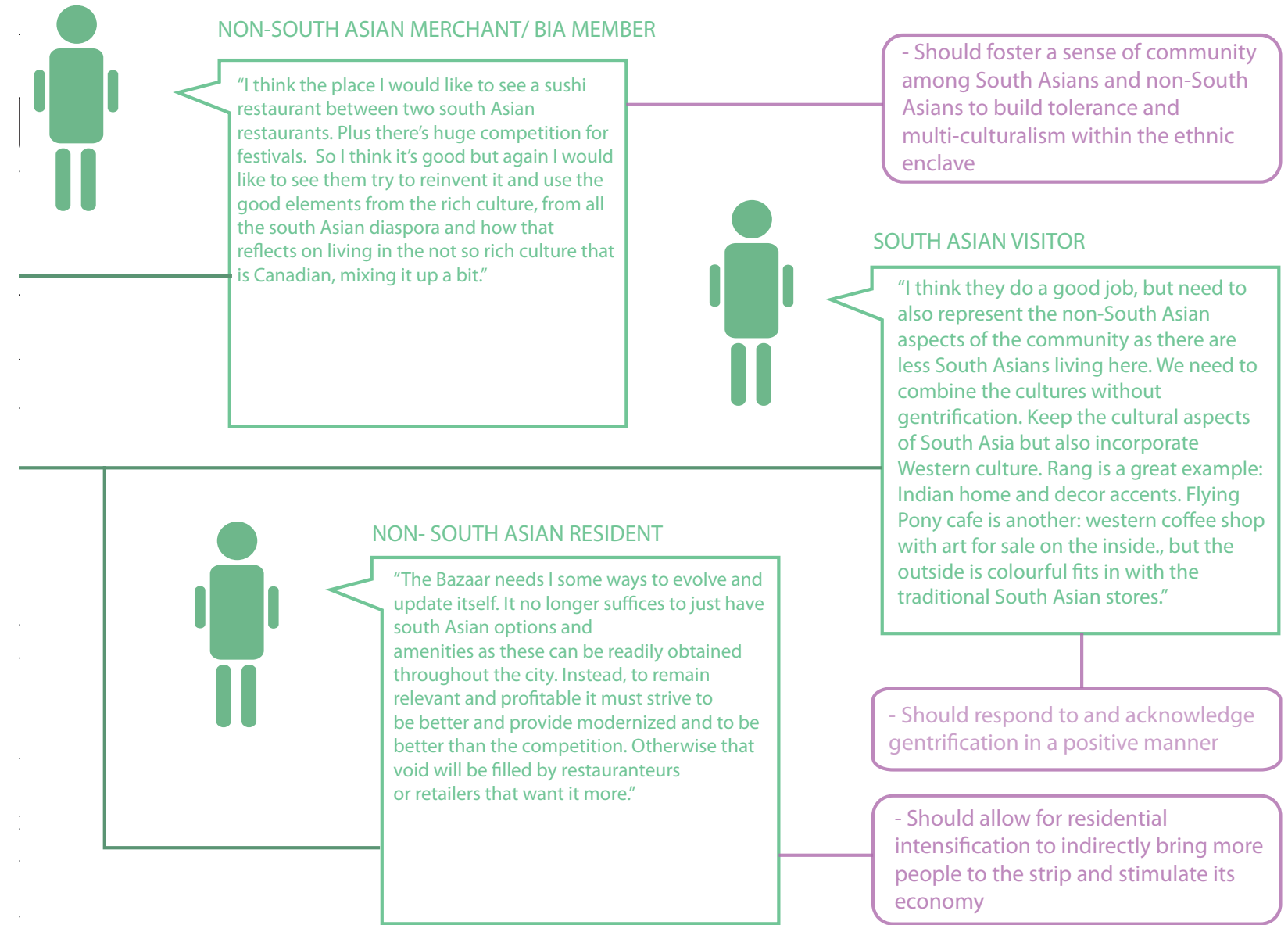


Fig 5.97: Strategy 2 - Re-imagine, personal perspectives



Re-Imagine: Define new entities among key entities and other user groups

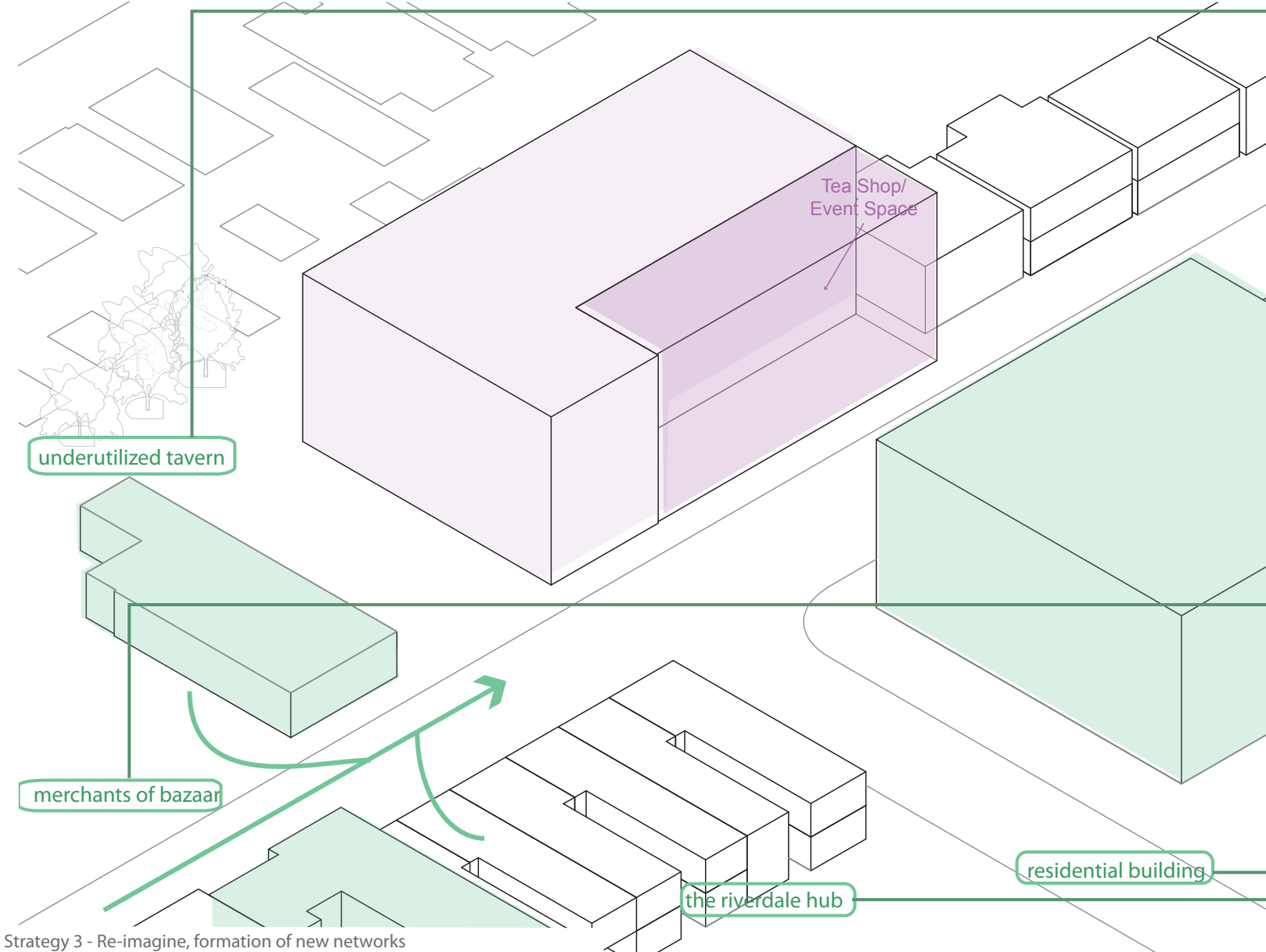
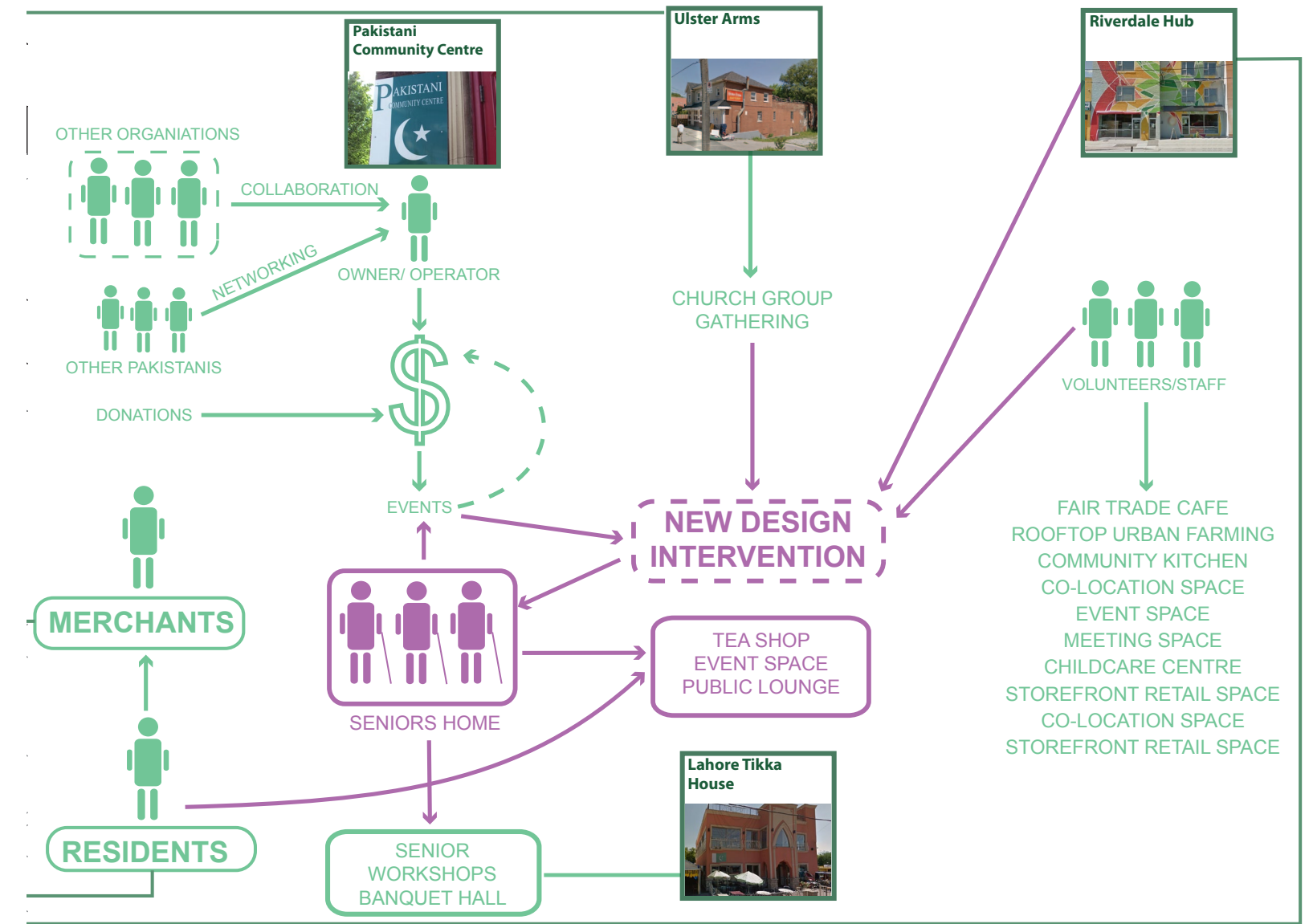


Fig 5.98: Strategy 3 - Re-imagine, formation of new networks



Re-Imagine: Identify vernacular/ traditional design maneuvers

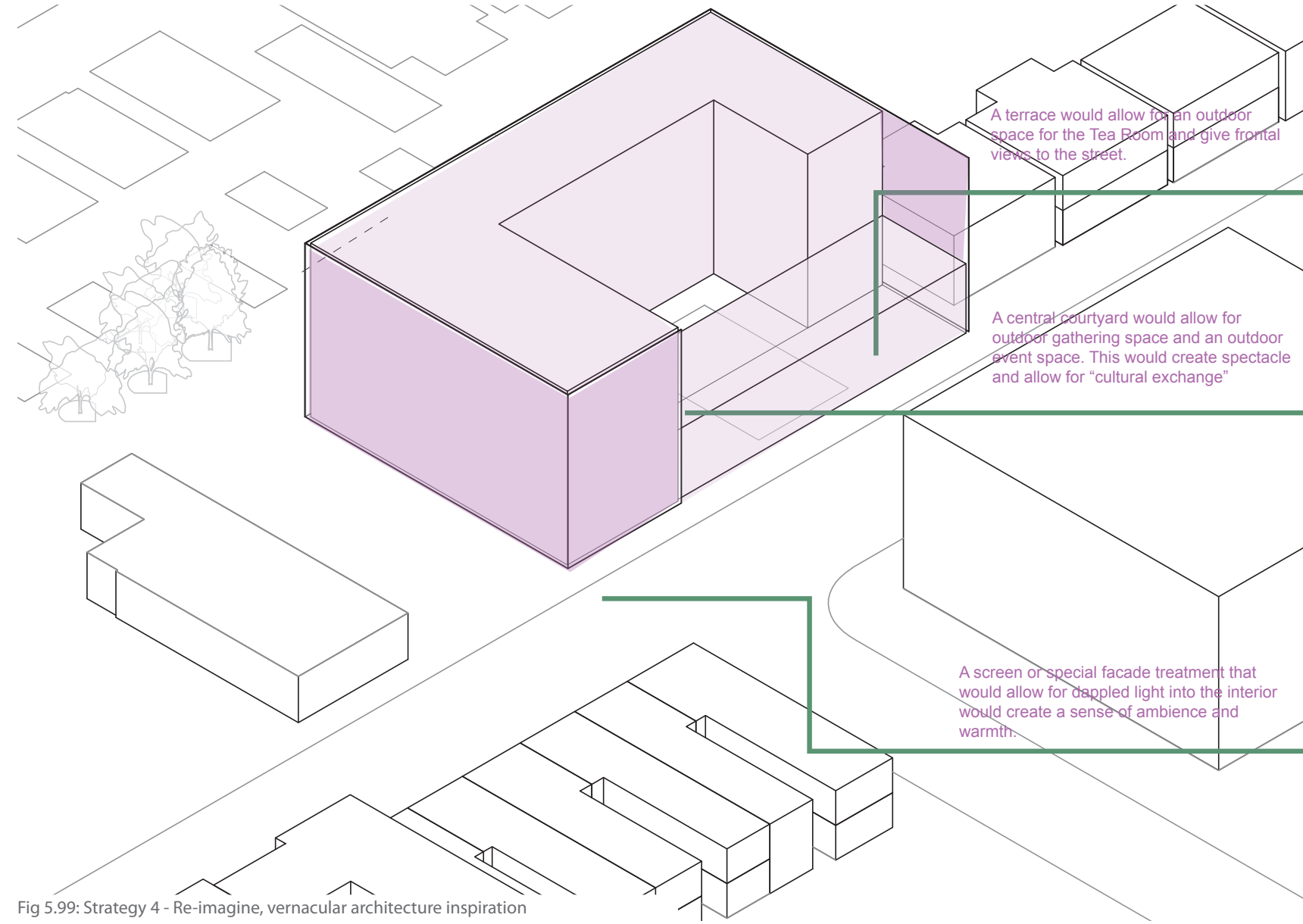
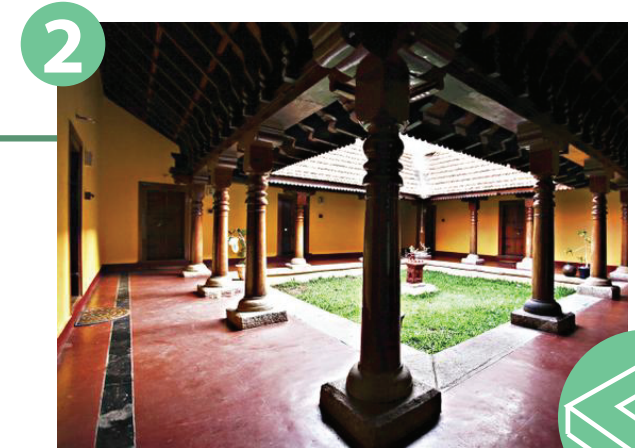
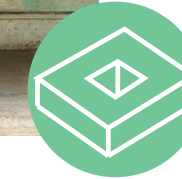


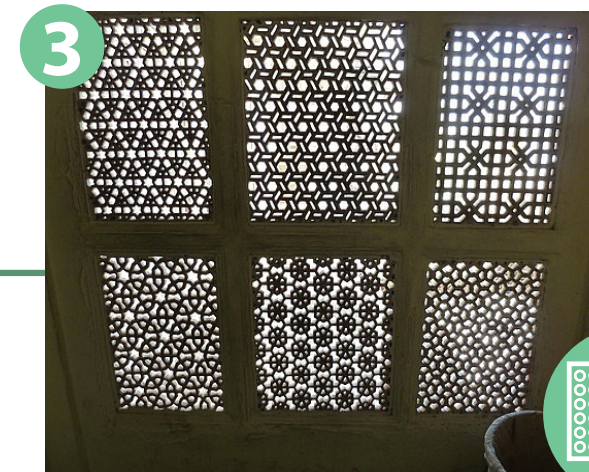
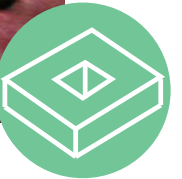
Fig 5.99: Strategy 4 - Re-imagine, vernacular architecture inspiration



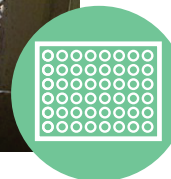
Veranda/ Terrace



Courtyard



"Jaali" Wall / Screen



Re-Imagine: Identify local design maneuvers

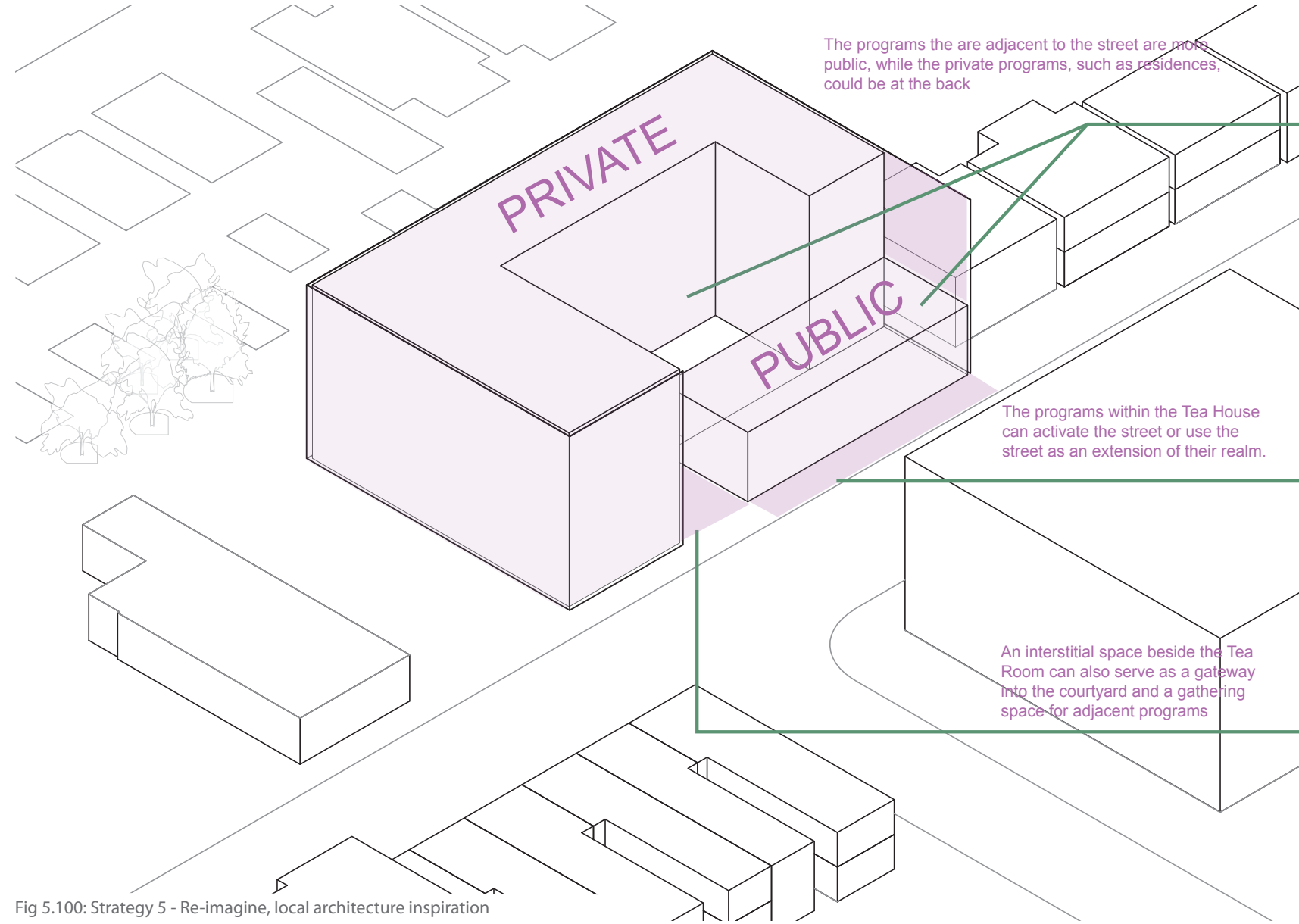
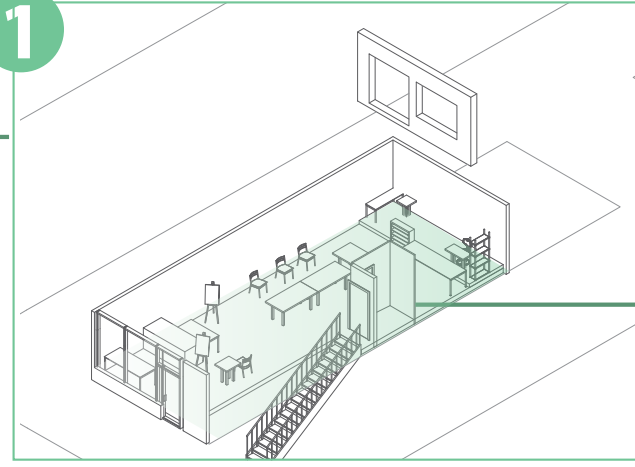


Fig 5.100: Strategy 5 - Re-imagine, local architecture inspiration

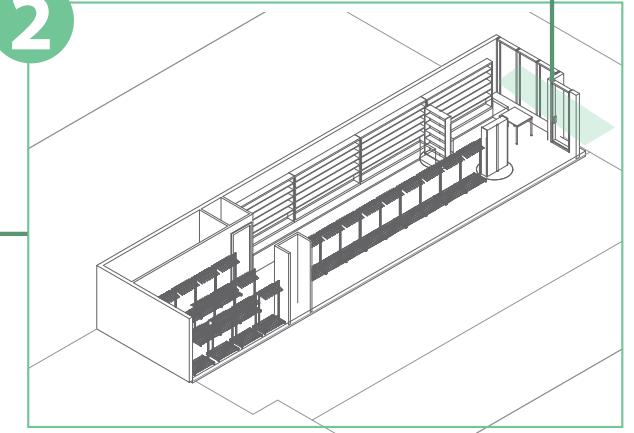
1



Lens Work -
Public to semi public

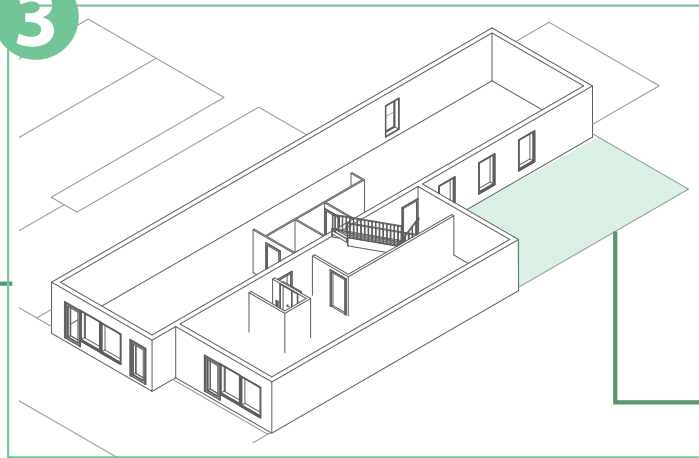


2

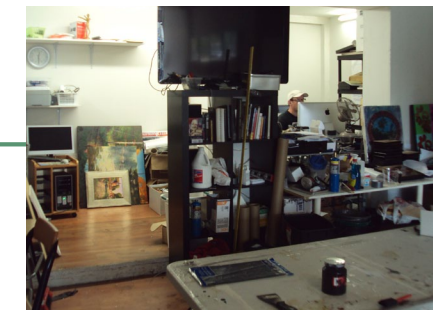


Sajawat -
Extension of interior realm

3



Riverdale Hub -
Interstitial spaces with built form



Re-Imagine: Uncover underlying form/ site geometry to establish design constraints

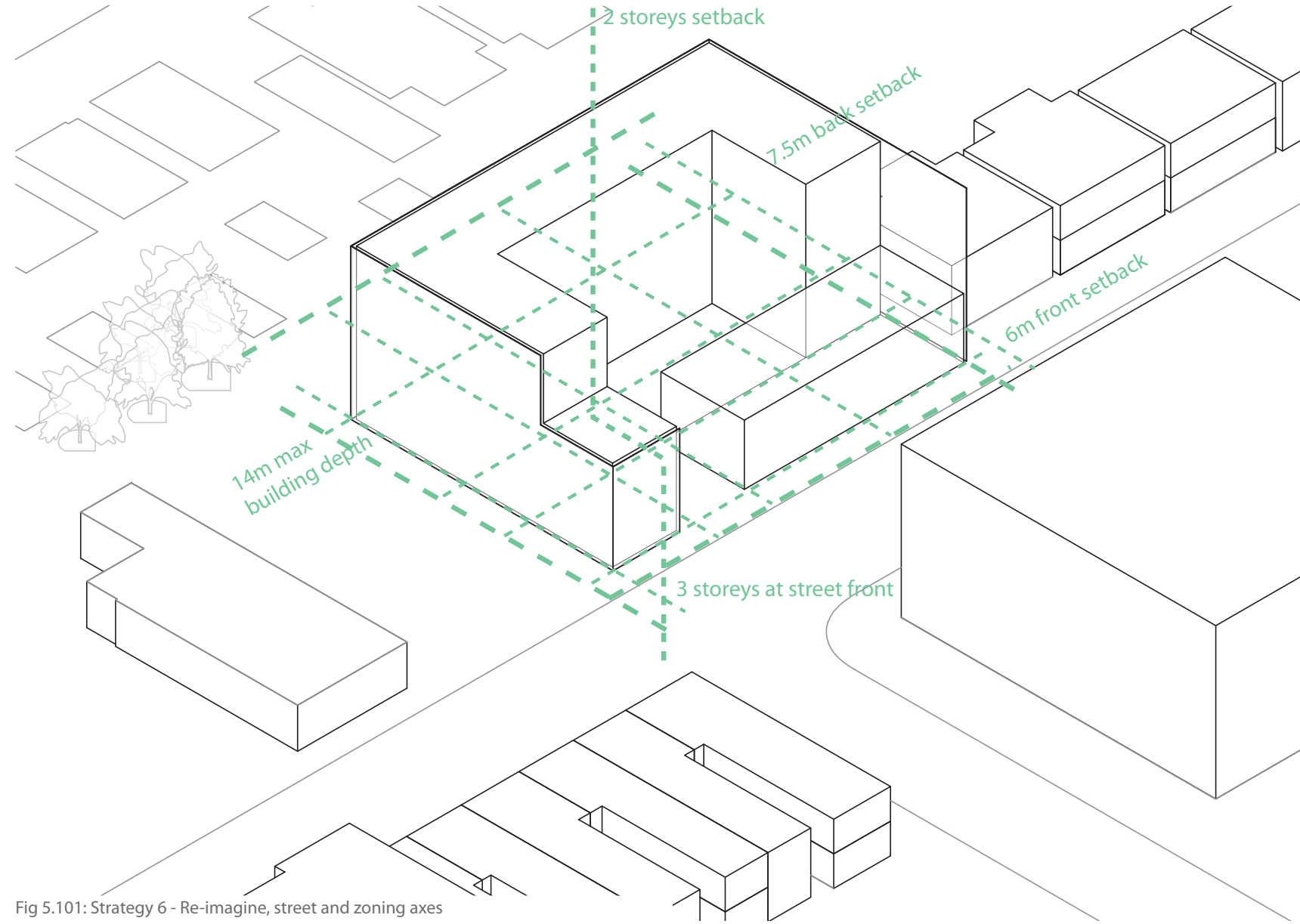


Fig 5.101: Strategy 6 - Re-imagine, street and zoning axes

Re-Imagine: Re-surface/ modify the ground plane to create new spatial relationships

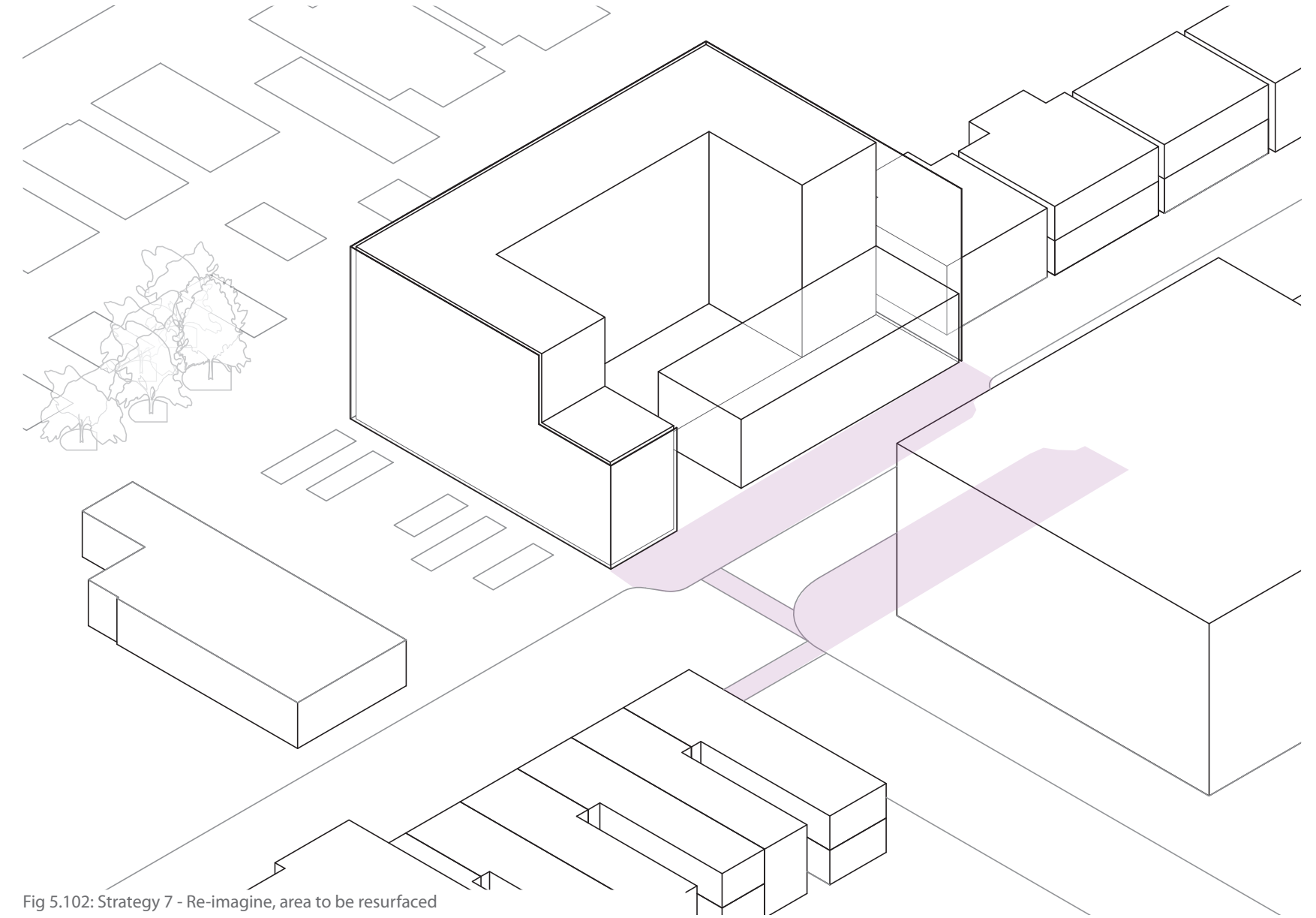


Fig 5.102: Strategy 7 - Re-imagine, area to be resurfaced

Re-Imagine: Modify site specific elements to make them more accessible

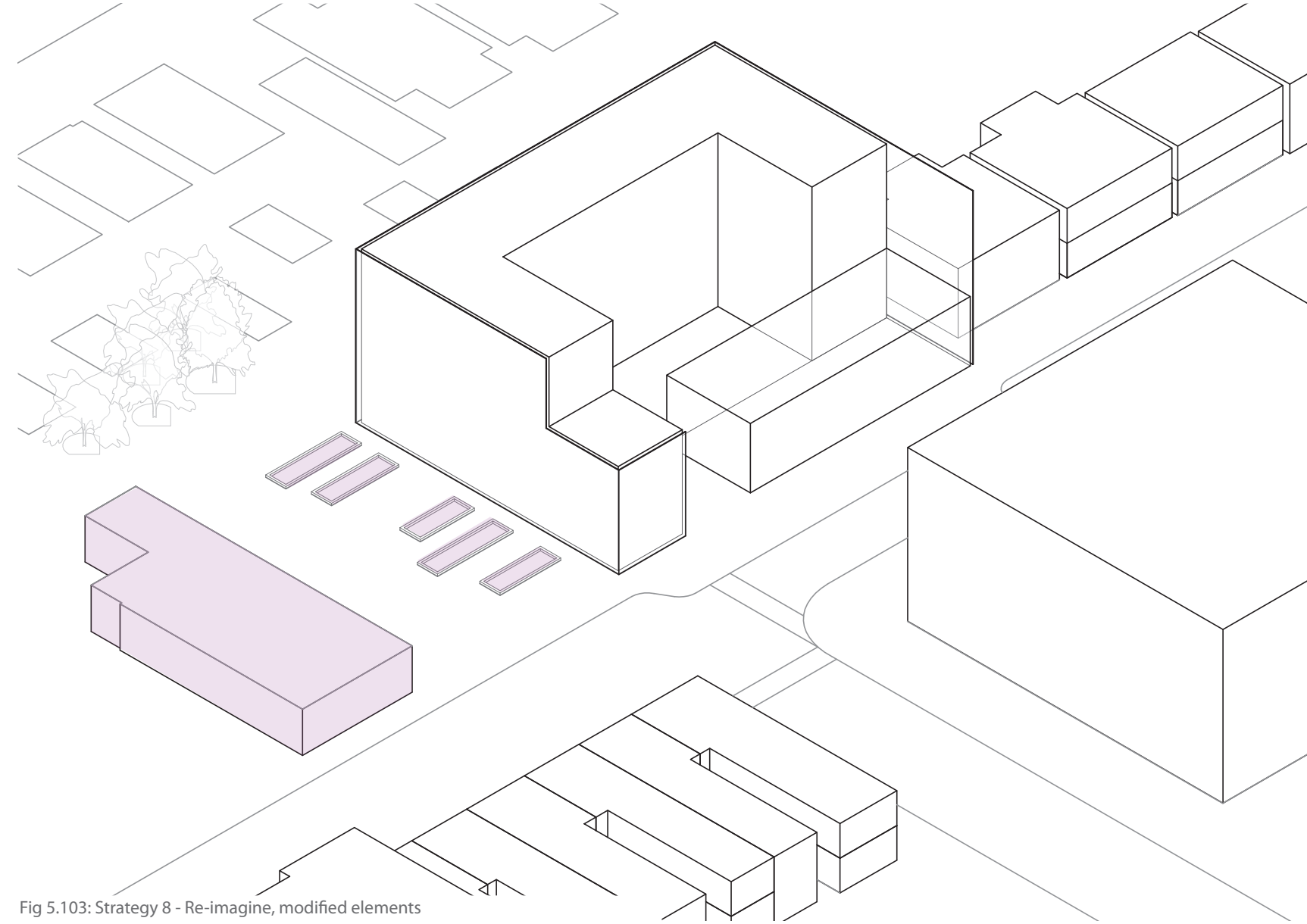


Fig 5.103: Strategy 8 - Re-imagine, modified elements

Re-Imagine: Design new architectural/ urban elements

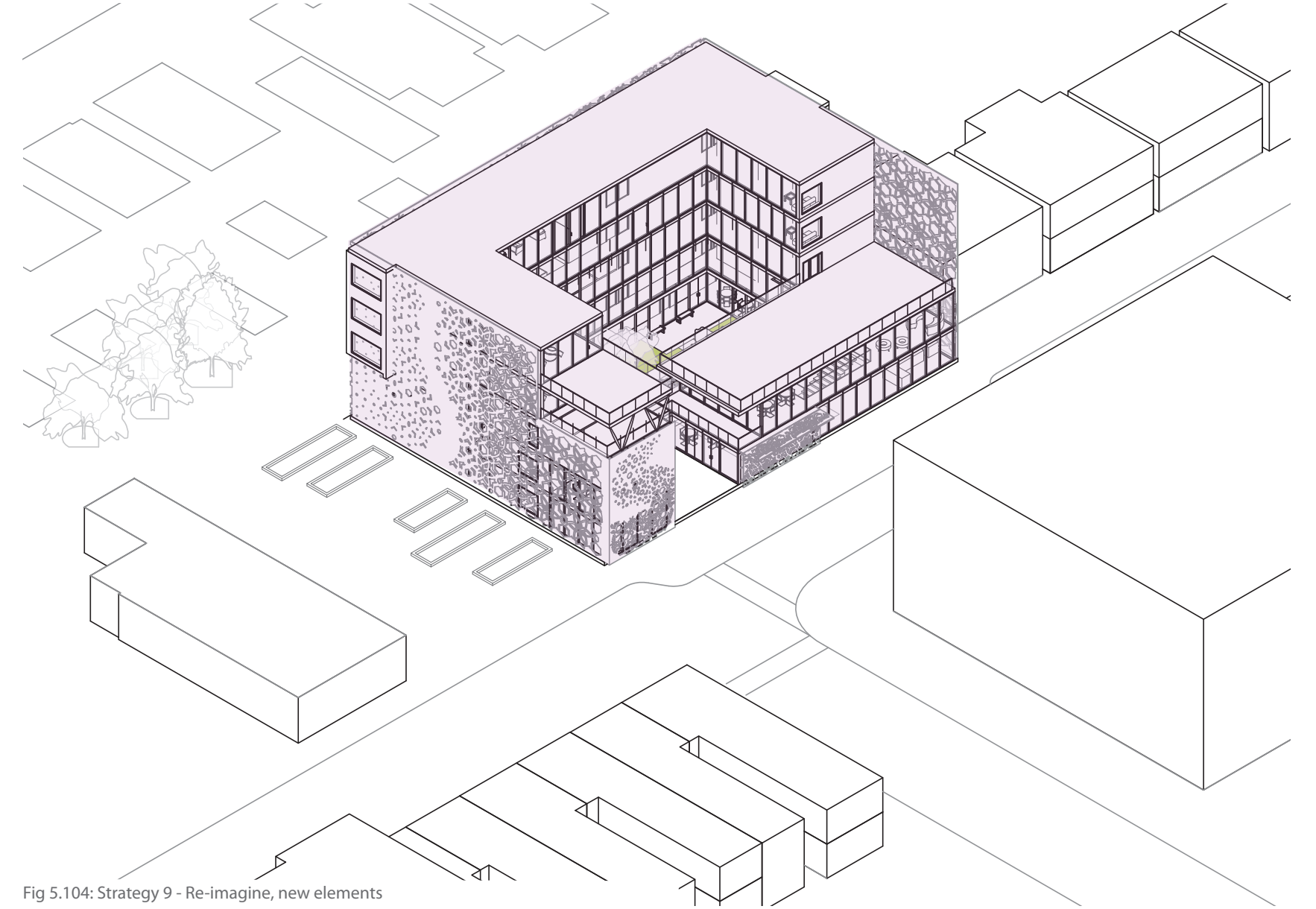


Fig 5.104: Strategy 9 - Re-imagine, new elements

Re-Imagine: Refine new architectural/urban elements to create areas of gathering/ interaction (cultural exchange)

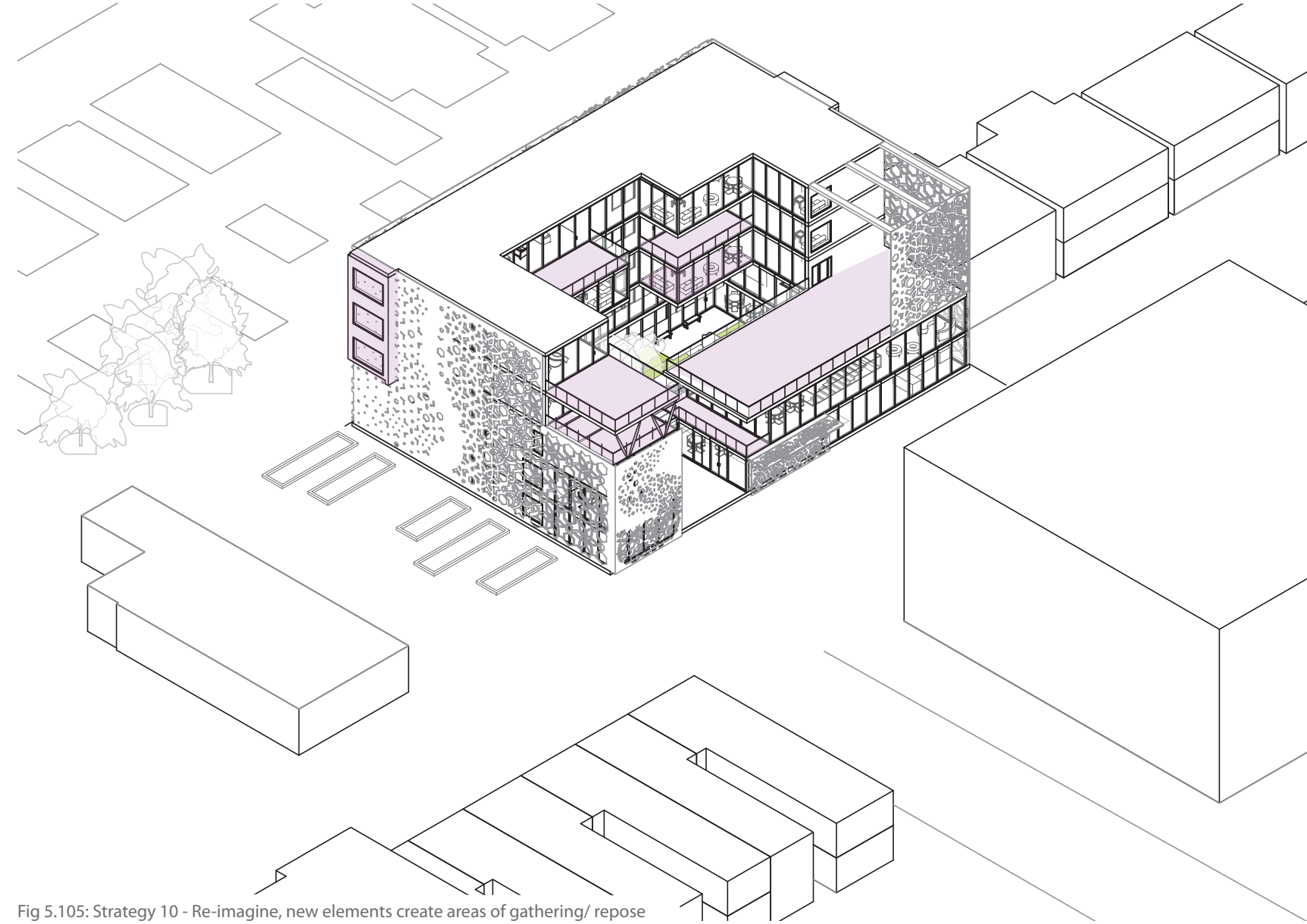
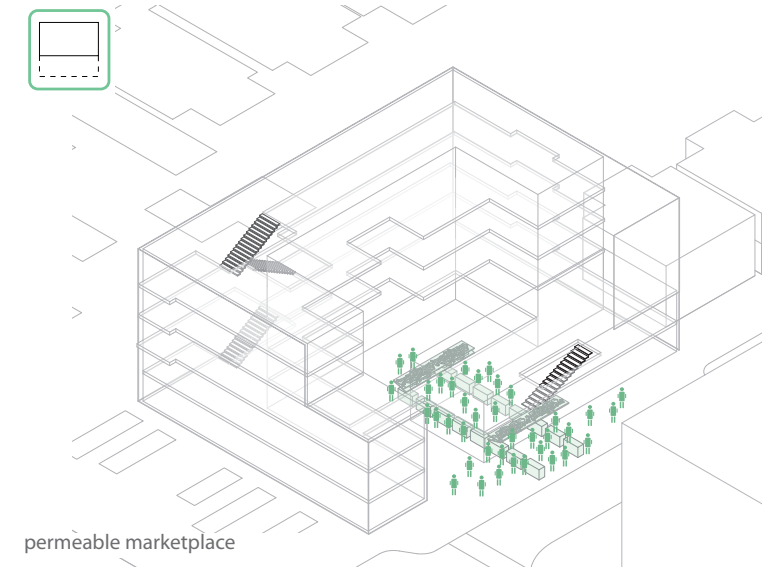


Fig 5.105: Strategy 10 - Re-imagine, new elements create areas of gathering/ repose

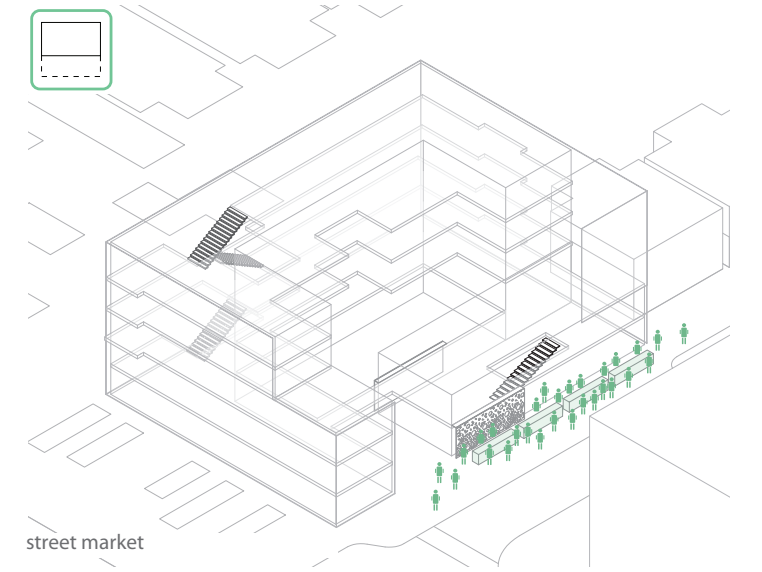


permeable marketplace

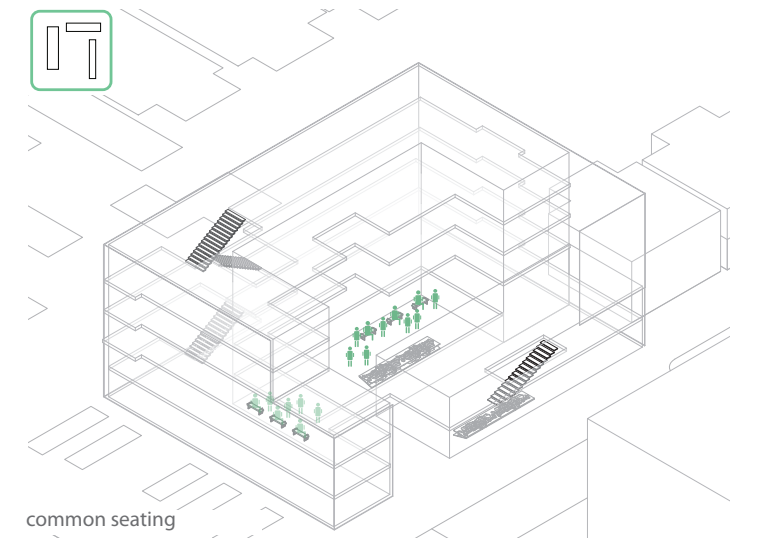


common seating

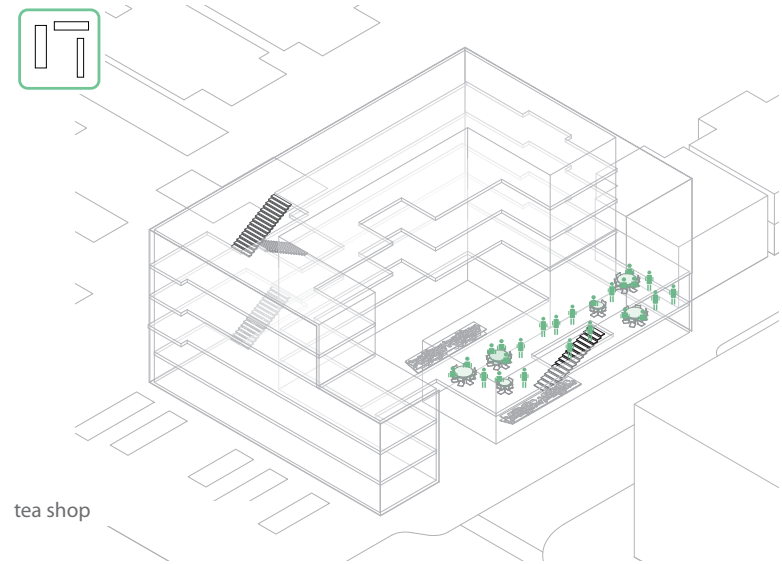
Fig 5.106: Re-imagine design maneuvers



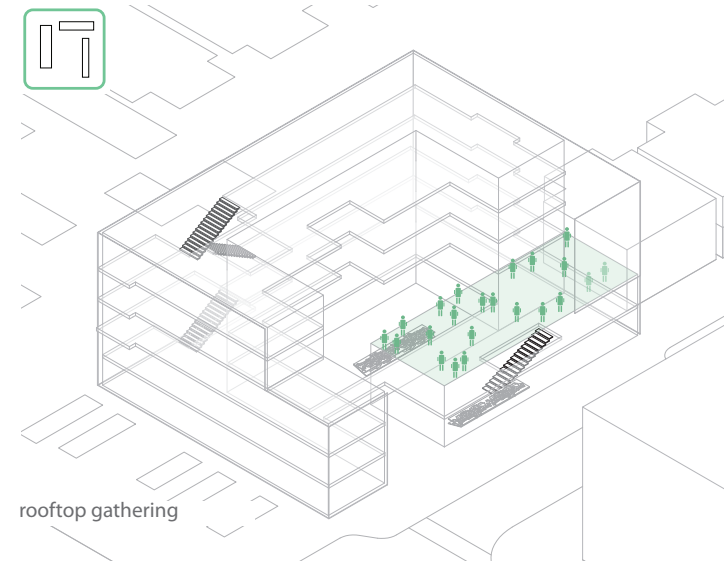
street market



common seating



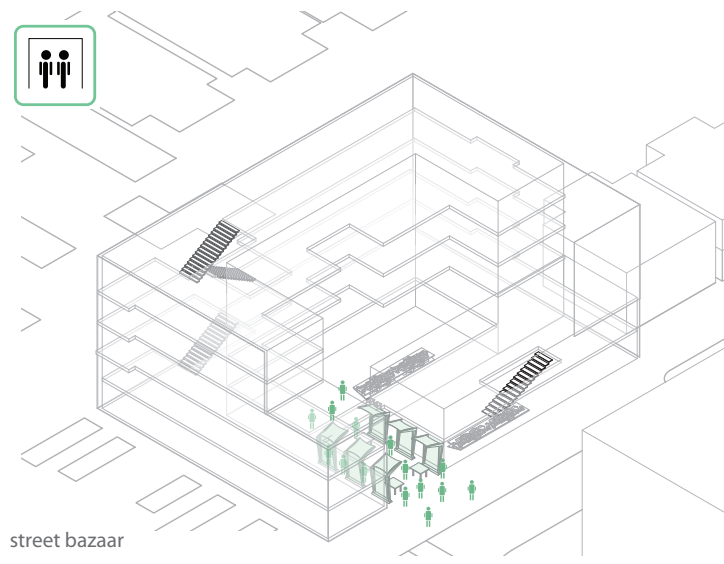
tea shop



rooftop gathering

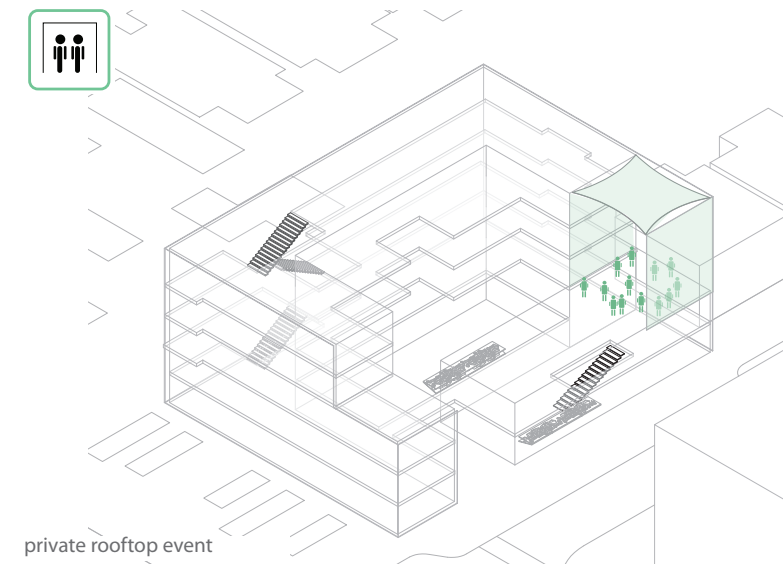


extended street market

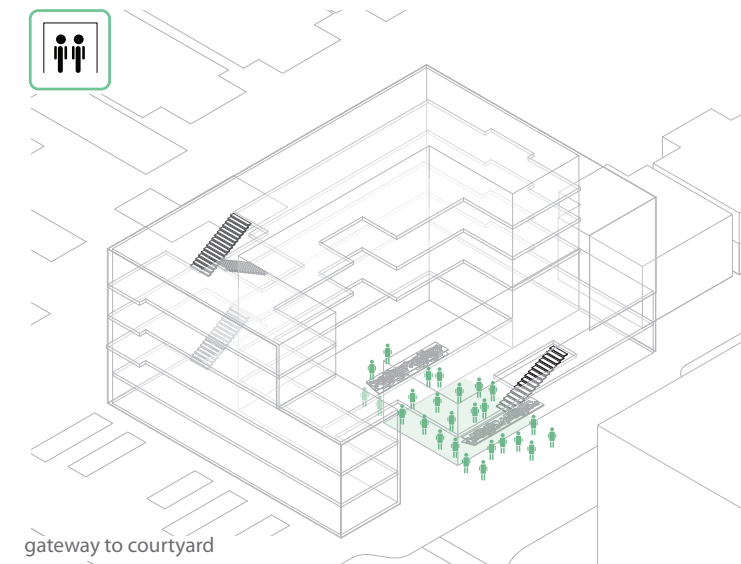


street bazaar

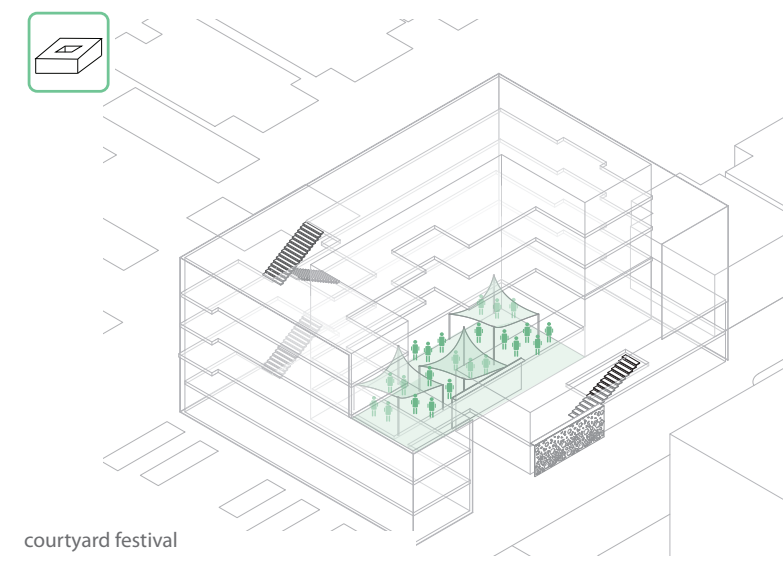
Fig 5.107: Re-imagine design maneuvers



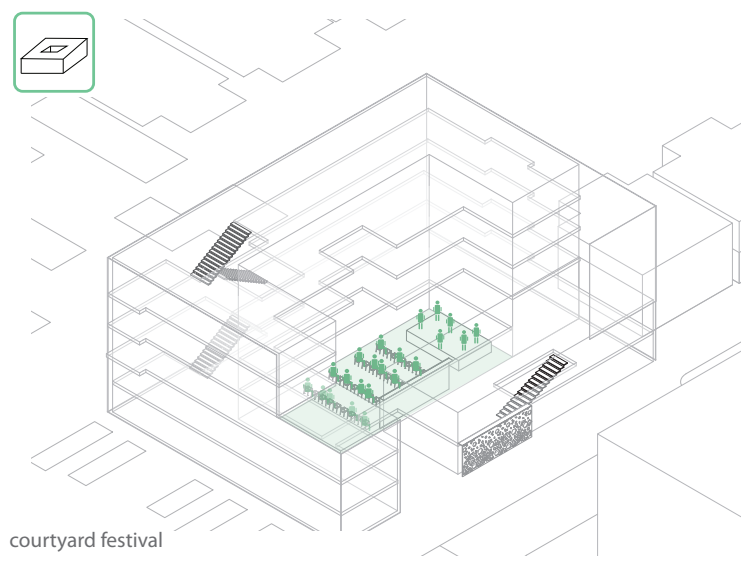
private rooftop event



gateway to courtyard



courtyard festival



courtyard festival

Fig 5.108: Re-imagine design maneuvers

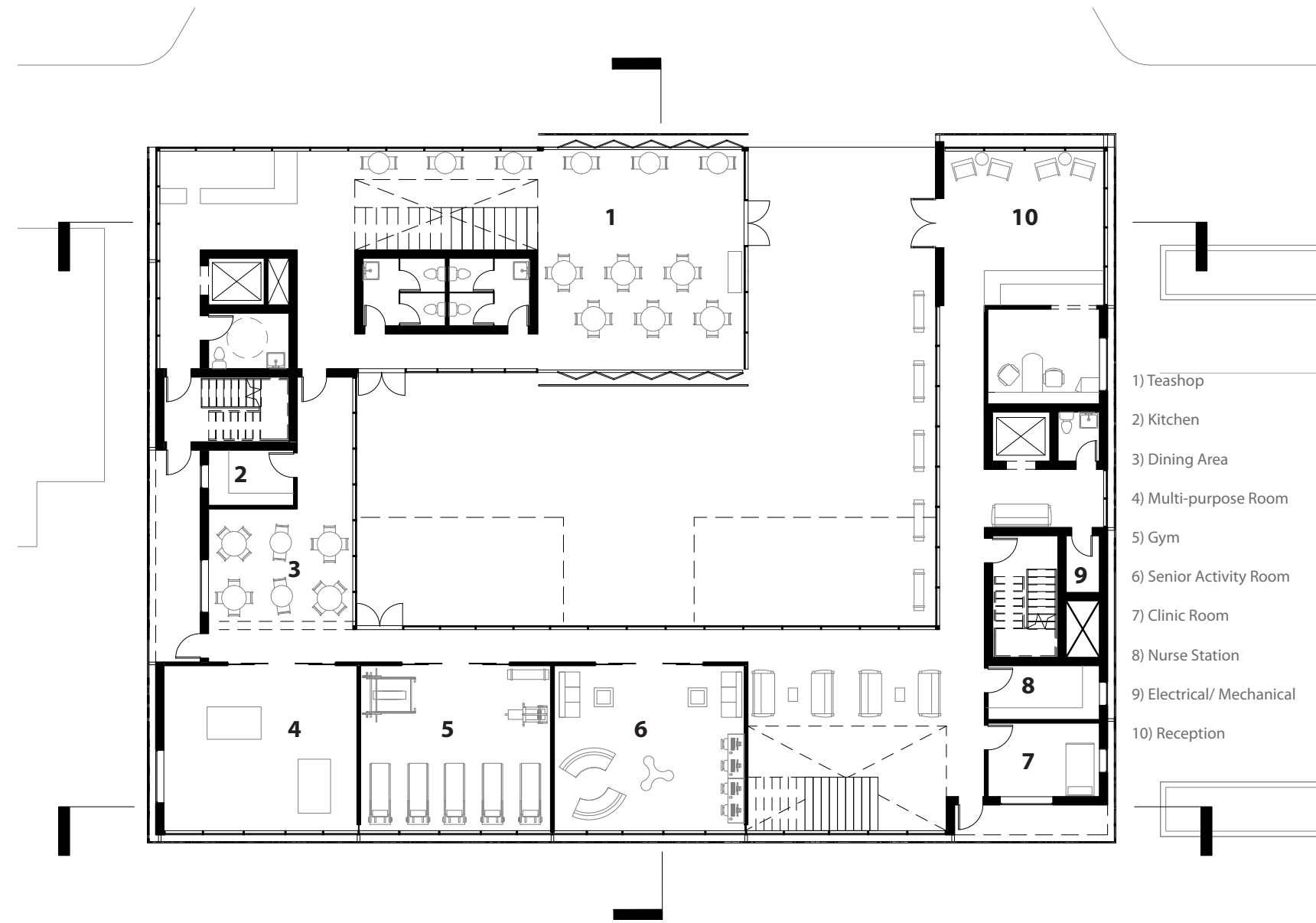


Fig 5.109: Main level floorplan



Fig 5.110: Second level floorplan

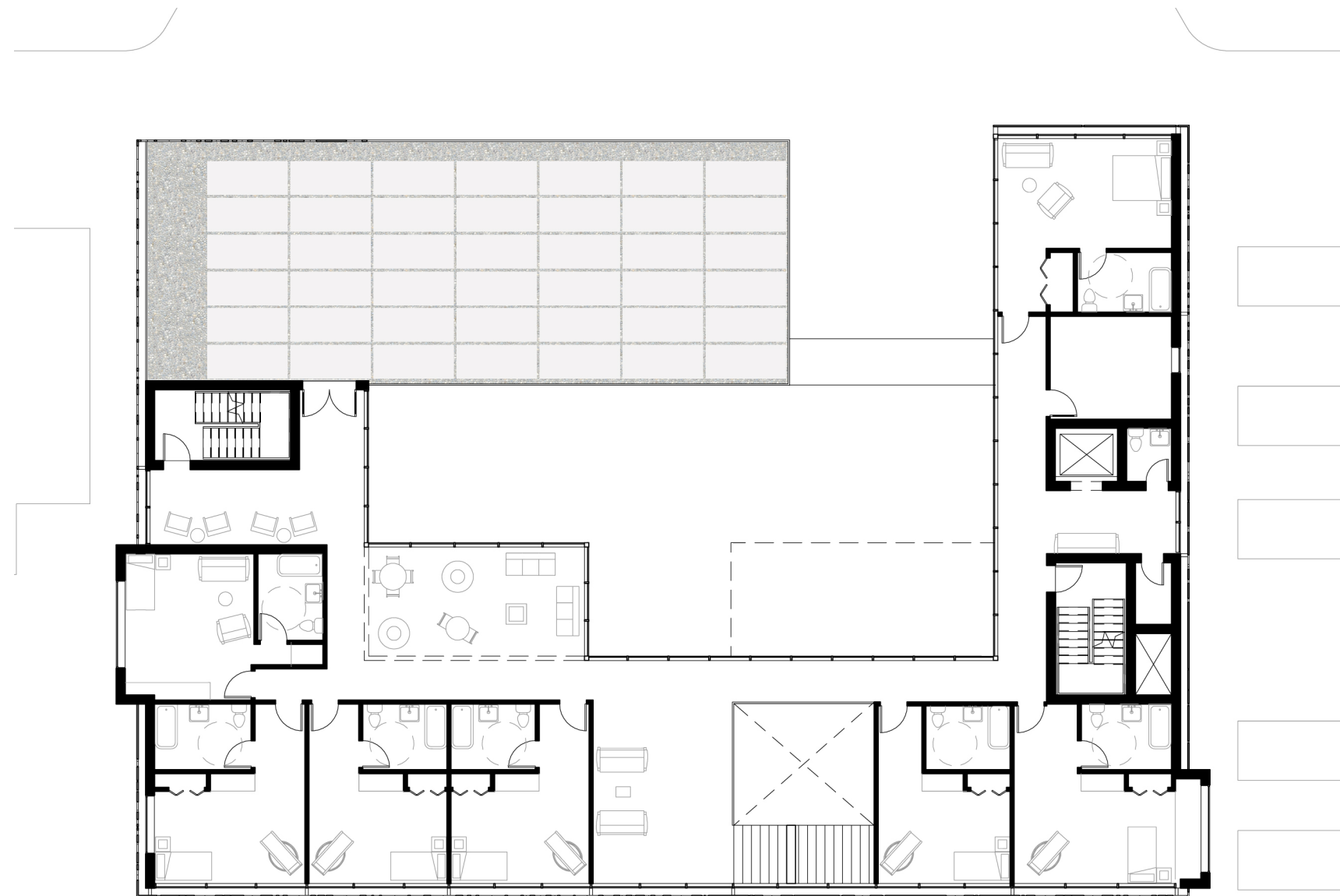


Fig 5.111: Third level floorplan

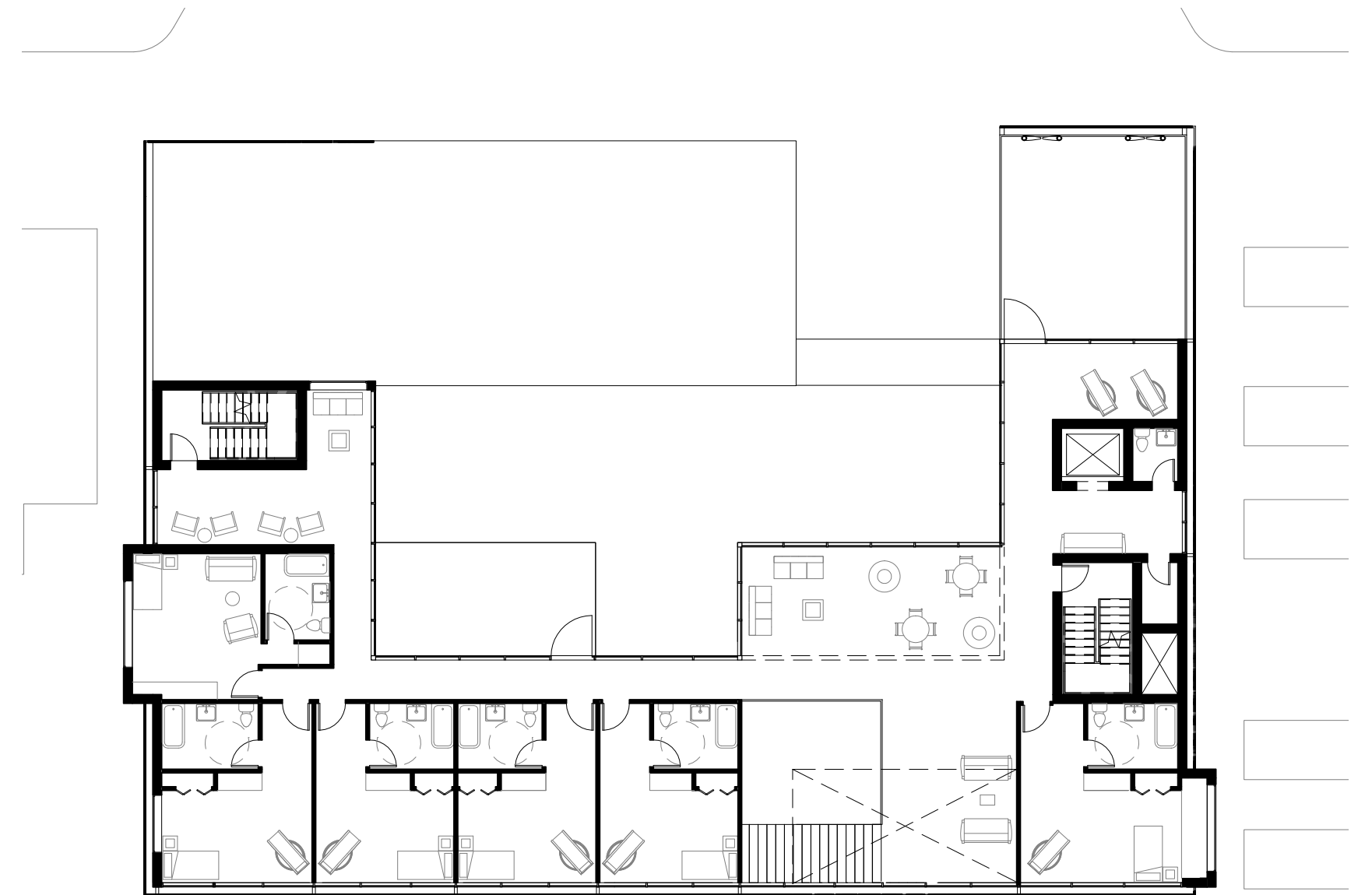


Fig 5.112: Fourth level floorplan

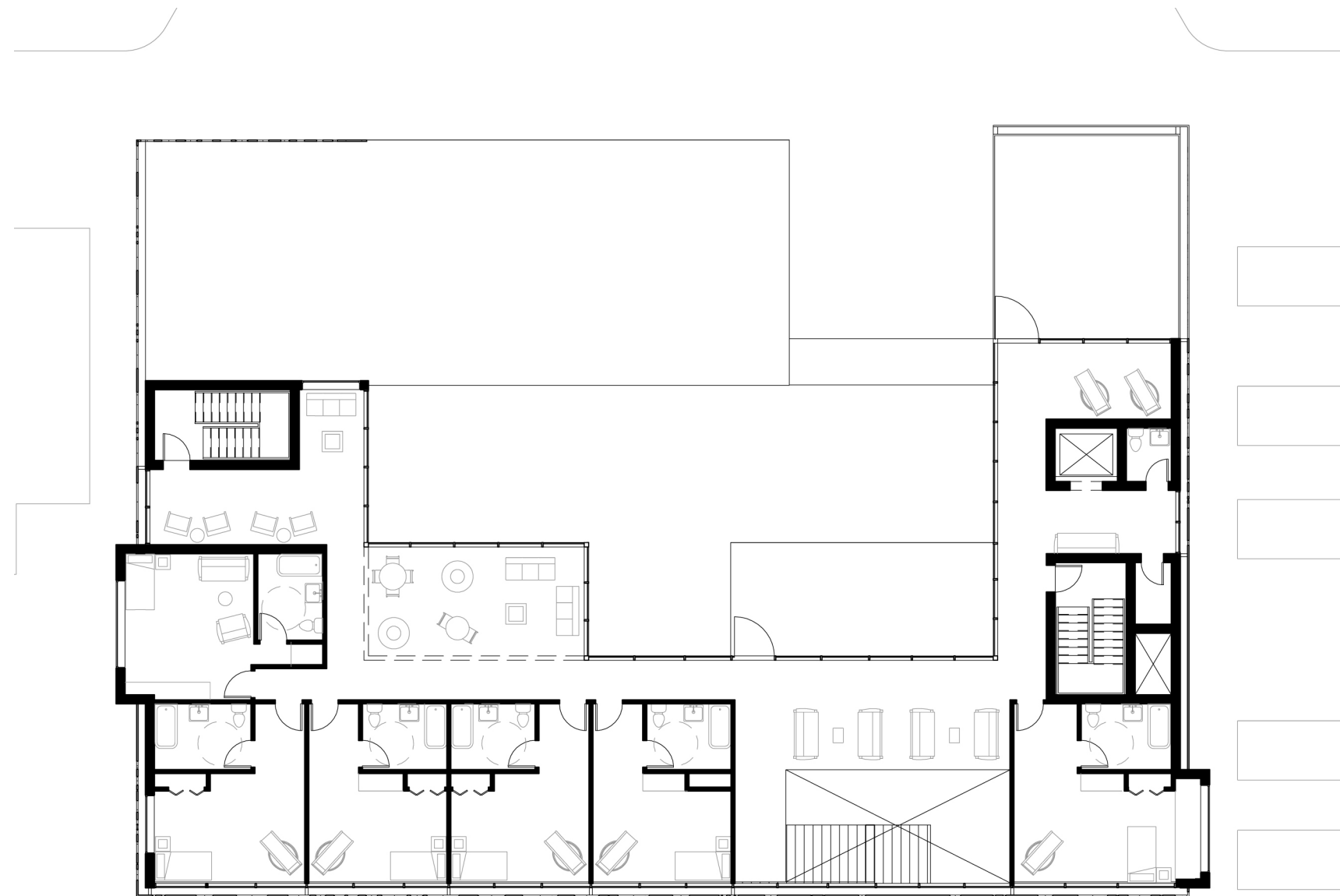


Fig 5.113: Fifth level floorplan

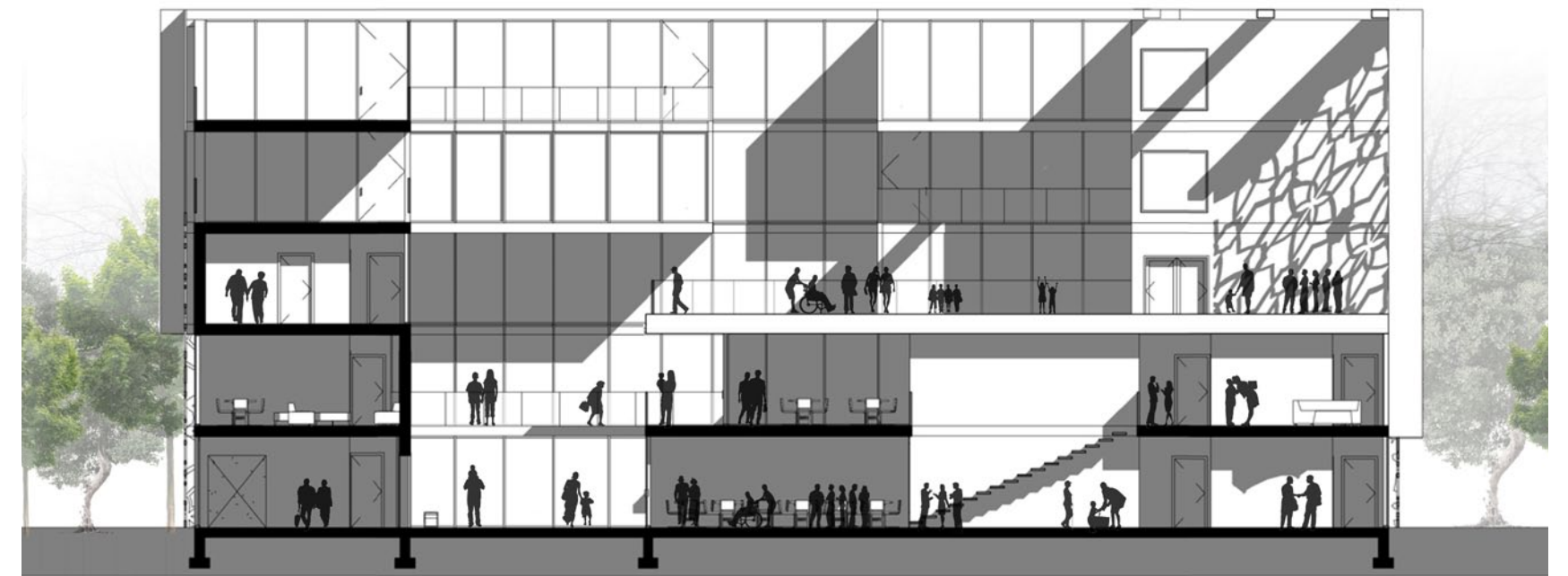


Fig 5.114: Longitudinal section

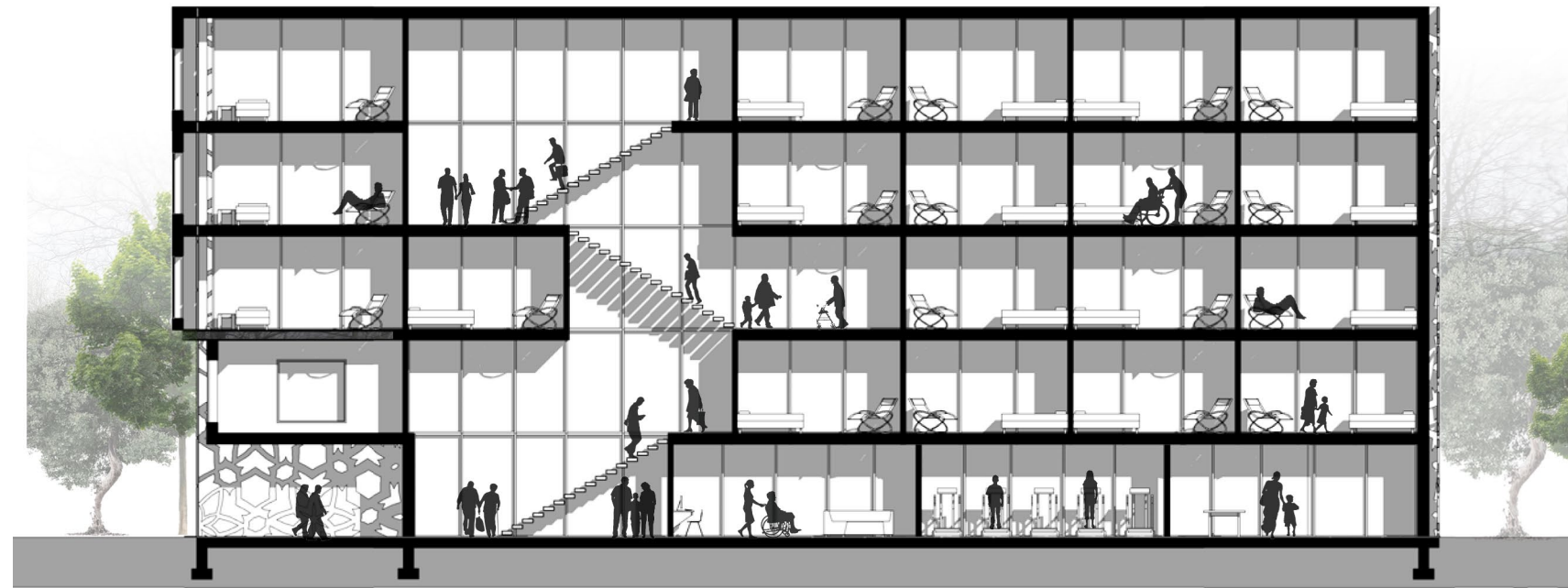


Fig 5.115: Longitudinal section

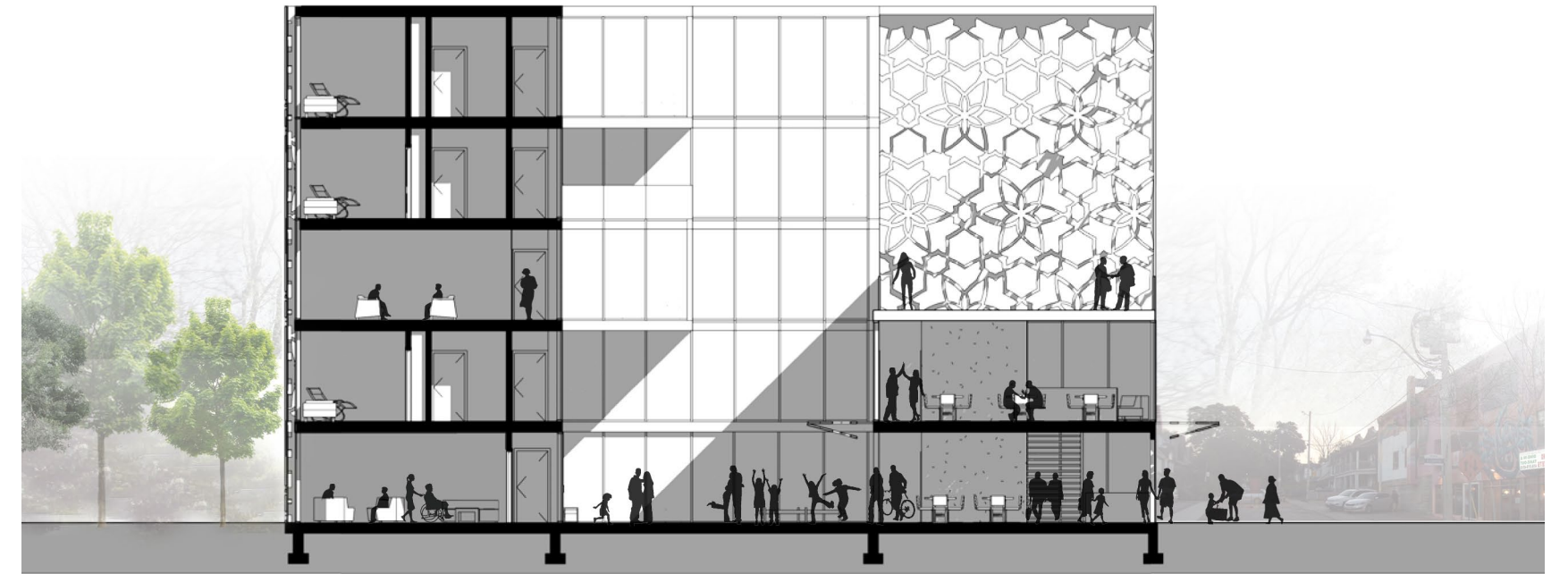


Fig 5.116: Cross-section

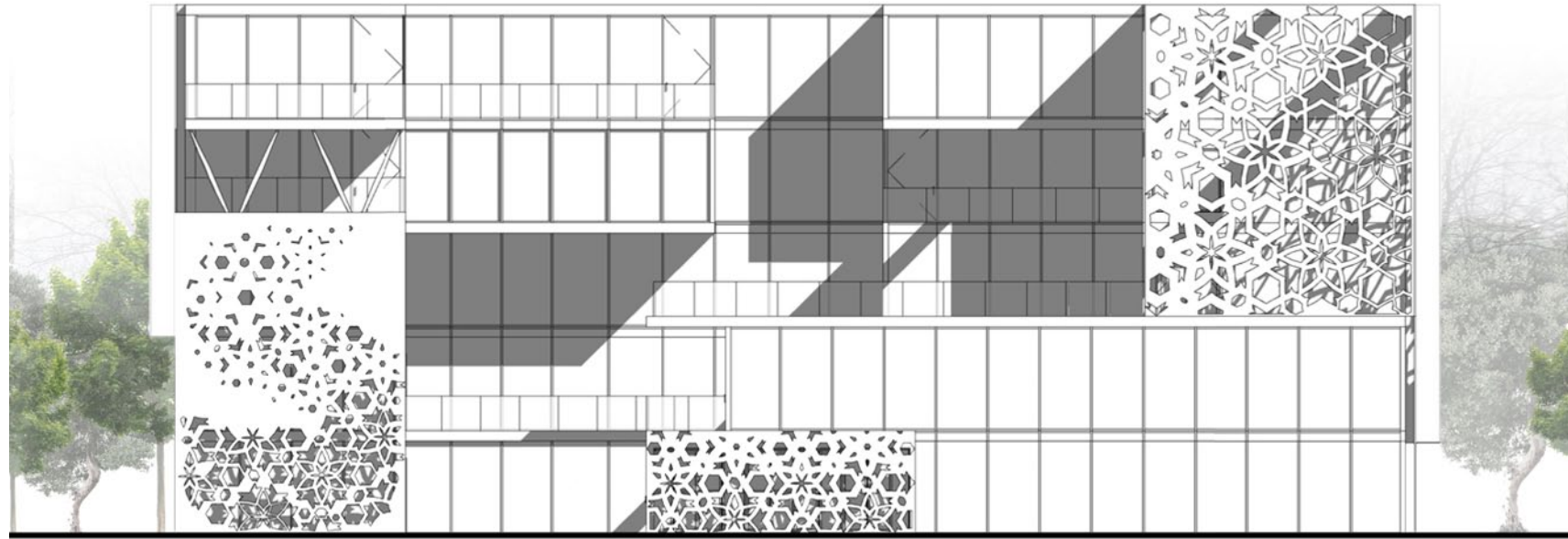


Fig 5.117: North elevation

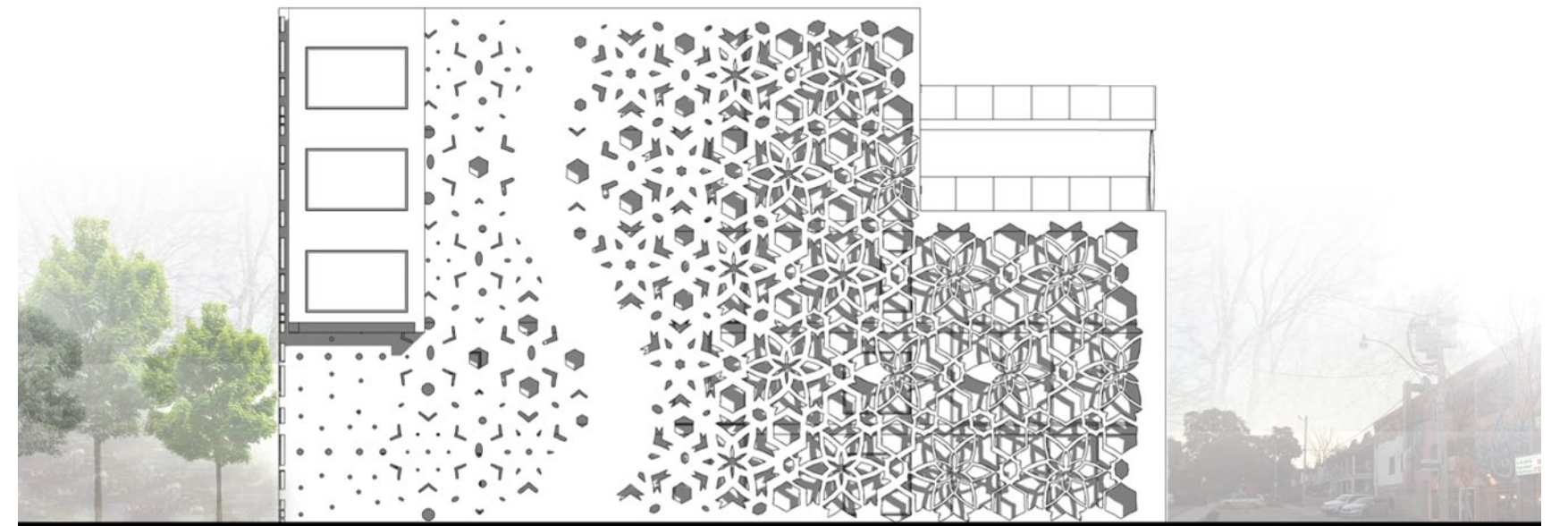


Fig 5.118: East elevation

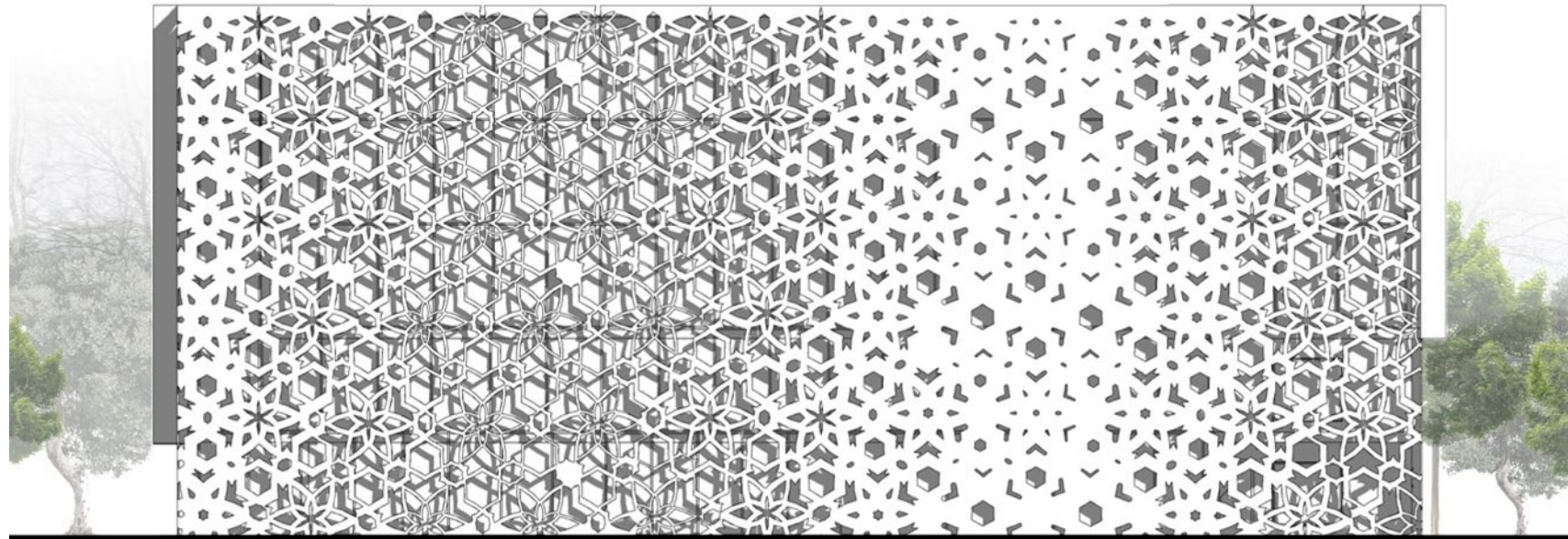


Fig 5.119: South elevation

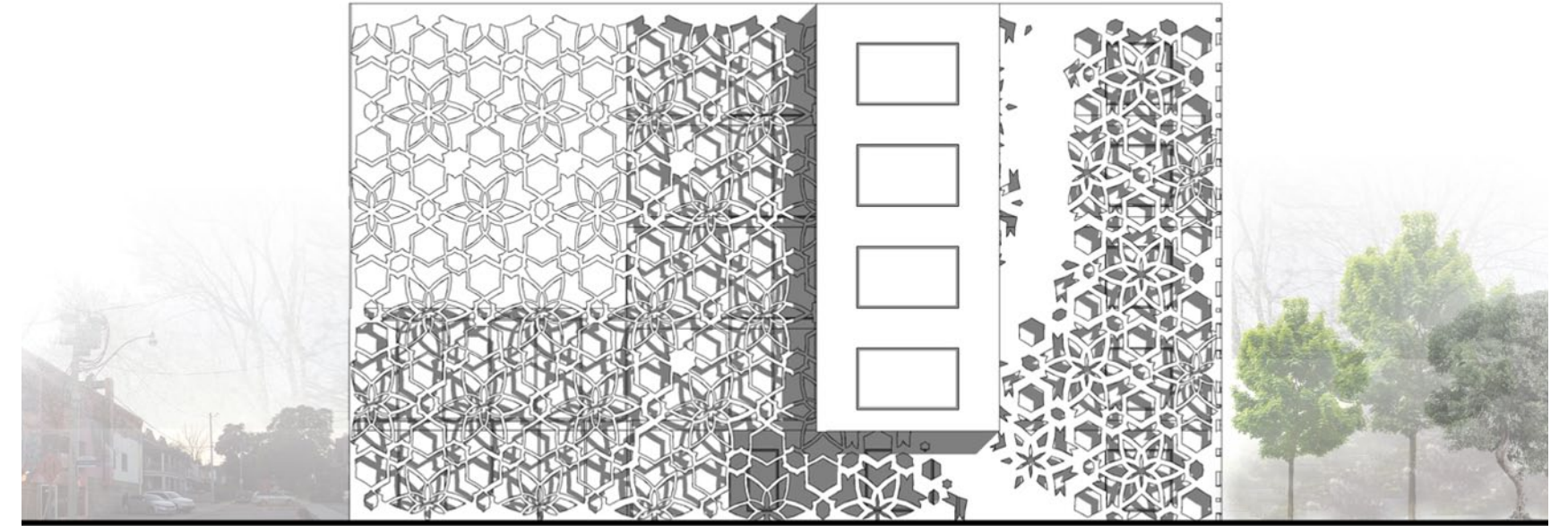


Fig 5.120: West elevation

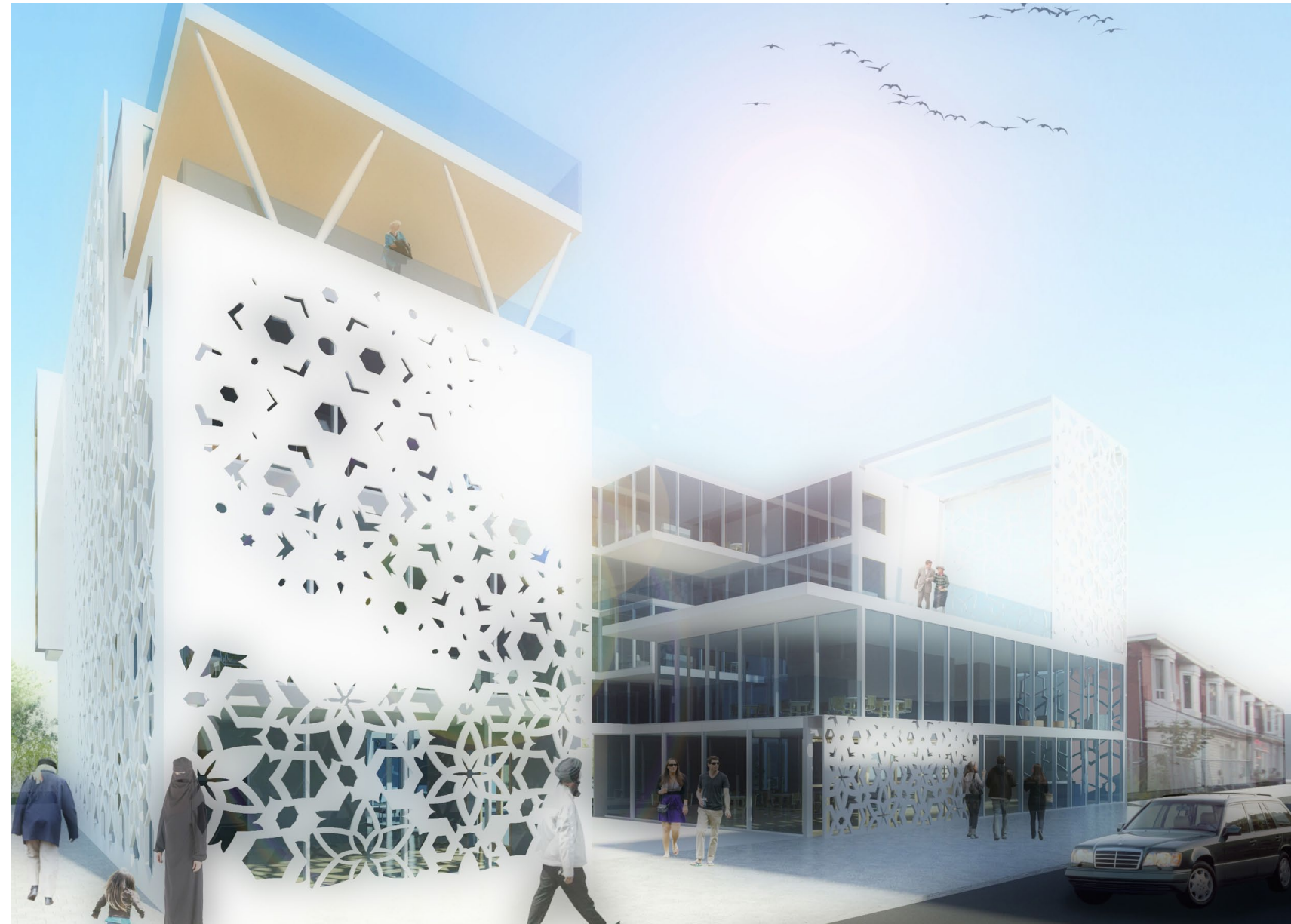


Fig 5.121: Building from exterior



Fig 5.122: Re-imagine: on a regular day



Fig 5.123: Re-imagine: during Basant (a popular kite-flying festival celebrated in Pakistan)



Fig 5.124: Re-imagine: during Friendship's Day (a popular festival celebrated in India)

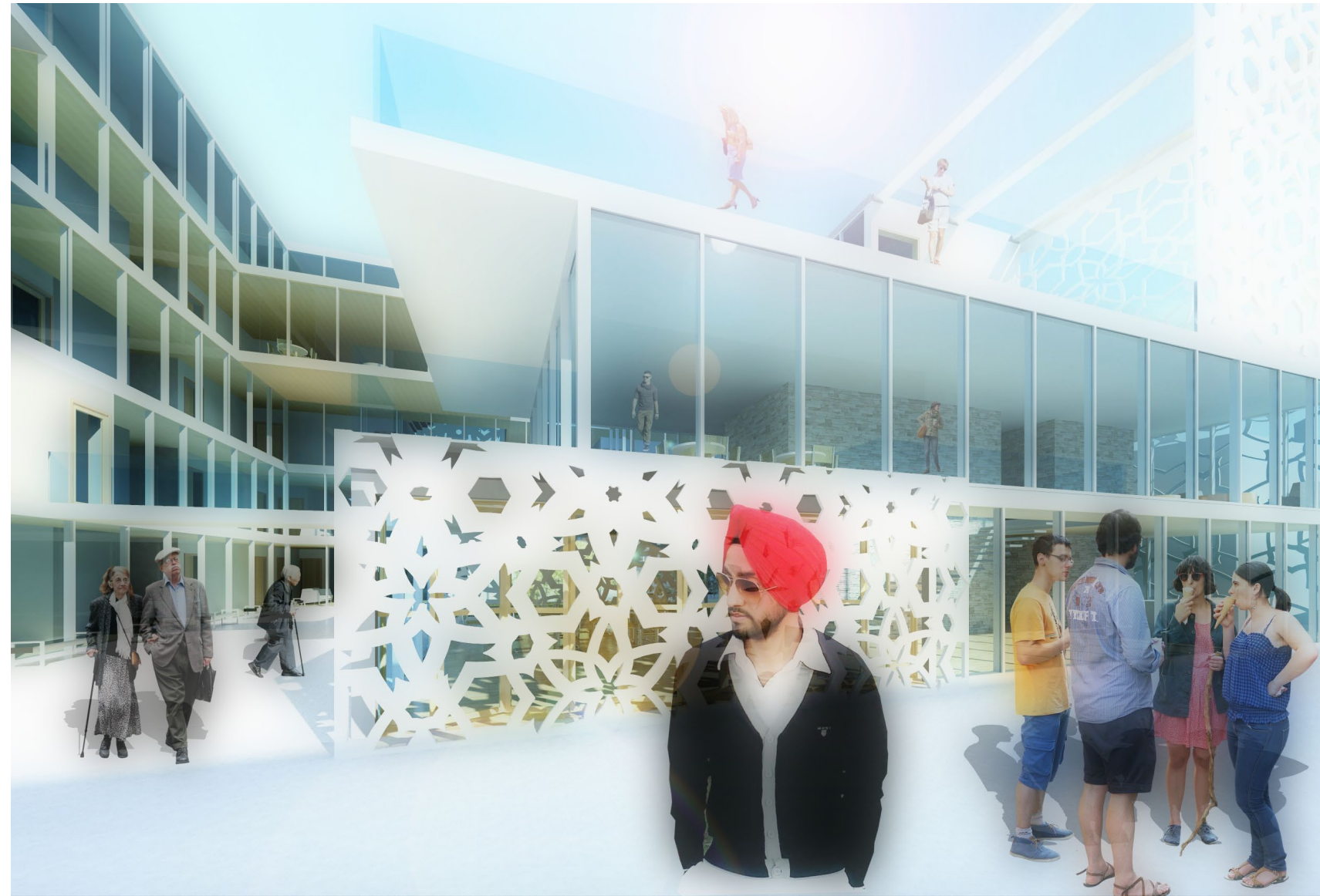


Fig 5.125: Re-imagine: during a regular day



Fig 5.126: Re-imagine: during an annual Spice Festival



Fig 5.127: Re-imagine: on a regular evening in the courtyard



Fig 5.128: Re-imagine: during Christmas celebrations

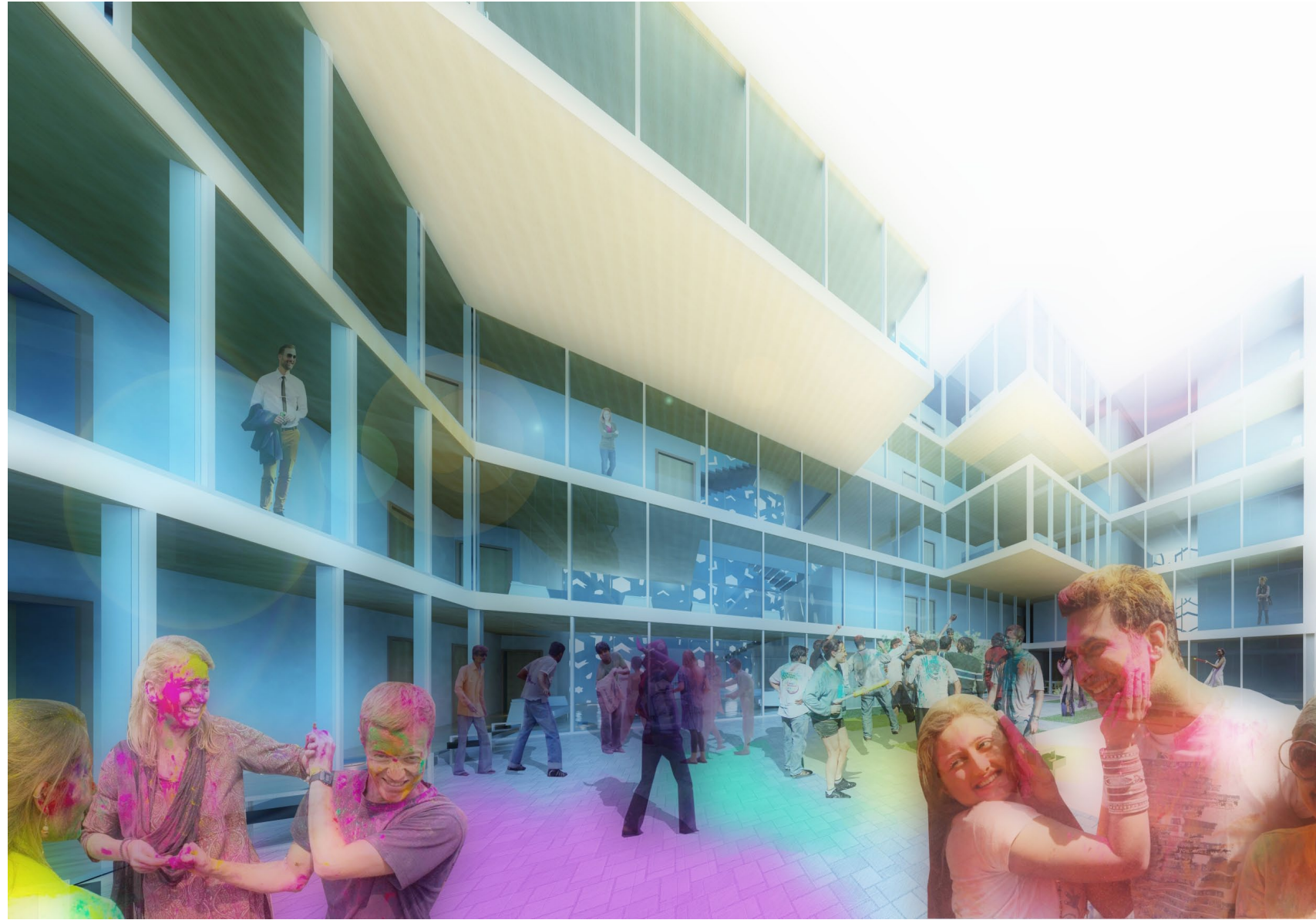


Fig 5.129: Re-imagine: during Holi, the festival of the colours celebrated in India



Fig 5.130: Re-imagine: during Vaisakhi, a Sikh festival of the harvest



Fig 5.131: Re-imagine: on a regular day at the teashop



Fig 5.132: Re-imagine: during a PCC Family Night musical event



Fig 5.133: Re-imagine: during a Christmas gala dinner



Fig 5.134: Re-imagine: during a South Asian public fashion show - marketing strategy for merchants

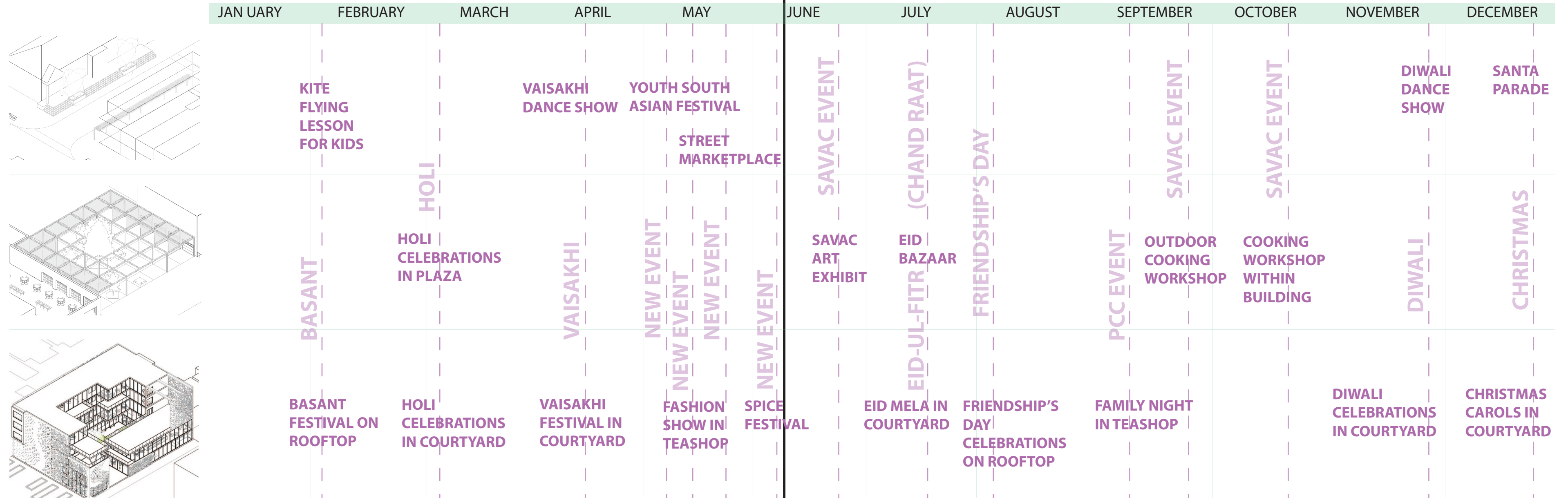


Fig 5.135: Calendar of events for all three design interventions

5.5 Potential for Modification and Implementation

The original concept of the manual within this thesis was to serve as a threshold between the research and data collection methods and the design proposal. It stands as an important element that translates the research into design and lays out step-by-step urban strategies that are meant to act as guidelines for the intervention. These urban strategies carefully considered every aspect of the research including demographic, architectural, spatial and personal findings.

The steps taken within this thesis and the subsequent formulation of this manual are meant to serve as an exemplary method in which declining ethnic enclaves within Toronto can renew and enhance their identity through architecture and urban design. The aim is that these strategies can serve as an inspiration for city organizations, Architects and Business Improvement Areas when they look to improve their neighbourhoods by means of a rigorous method and ultimate design proposal.

The use of these formulated urban strategies is meant to stand as an illustration of how geographic, demographic, architectural and personal research can be utilized in a strategic manner to bring about change within various ethnic enclaves that are undergoing gentrification, ethnic succession and/or decline.

Although the manual of urban strategies was formulated after carefully considering various aspects researched, its application within the three sites illustrates that the manual operates more successfully on some sites than others. For example, the manual seems to operate well for urban spaces, particularly the re-use intervention, as opposed to actual architecture. This may be due to the fact that a building is much more complex than simple outdoor structures, and would require much more detailed and thorough design guidelines. As such, there are certain changes or adjustments that can be made. Firstly, the manual may need some more specificity in the rules, in the form of "sub-rules". For instance,

the last intervention could use a set of sub-rules that fall under each rule. The rule "Uncover underlying form/ site geometry to establish design constraints" could have sub-rules such as: "identify zoning setbacks", "identify axes lines" and "identify underlying street and site geometries" - this would allow for the built form to be more precise.

Another aspect of the manual that needs improvement is its flexibility. It would work better as something that is more custom-based, rather than something that applies the same rules to every site. For example, the rule: "Define new networks among Key Entities and other user groups" can be divided into two or three rules: "Identify envisioned programs of new design", "identify networks of key entities that can be integrated into envisioned program" and "define new symbiotic networks between envisioned programs and existing networks". This would accommodate more flexibility in the type of networks that can be applied and integrated within that specific design proposal. In addition, certain rules may not be applicable to the site and should therefore be excluded, such as the "Modify existing site elements to make them more accessible" rule - it works for the first two design interventions but not necessarily the last one. As such, the manual should maybe have alternative rules or rules that can be exempt from being applied to certain sites.

Another, more minor aspect of the manual that can be modified, is the order of the rules and their relevance to the previous rule. For example, it would make more sense for "Modify site elements to create connectivity and adjacency" to come right after the rule, "Define new networks among Key Entities and other user groups". This would allow for these modifications to be a direct result of the newly proposed networks. This would also more clearly illustrate how the site is being modified, and the design influenced, in relation to these networks.

One final rule that can be added to the manual is "Test prototype in different context and evaluate" - this would simply mean that these

-  Examine current site situations
-  Acknowledge personal input from key entities and other user groups
-  Define new networks among key entities and other user groups
 - Identify envisioned programs of new design
 - Identify networks of key entities that can be integrated into envisioned programs
 - Define new symbiotic networks between envisioned programs and existing networks
-  Identify vernacular/ traditional design maneuvers
-  Identify local design maneuvers
-  Uncover underlying form/ site geometry to establish design constraints
 - Identify zoning setbacks
 - Identify axes lines
 - Identify underlying street and site geometries
-  Re-surface/ modify the ground plane to create new spatial relationships
-  Modify site elements to create connectivity and adjacency
-  Design new architectural/ urban elements
-  Refine new architectural/ urban elements to create areas of gathering/ interaction (cultural exchange)
-  Test prototype in different context and evaluate

Fig 5.136: Modified urban strategies manual

same rules can be applied to another site to see what type of design is born from those conditions. This would ensure that the best site for that specific design intervention is ultimately chosen.

Fig 5.136 shows how the manual of urban strategies would look if it were modified after this critique.

In terms of facilitating cultural exchange, the most important aspects of this manual are its consistency, that ensures that all previous research is translated into the design in the same way; its personal feature, that allows the design to have a personal influence; and its seamless incorporation of the design maneuvers into the urban strategies, which are necessary elements for cultural exchange.

All in all, this manual is meant to serve as a starting point for urban strategies, for if implemented in the real world, there would be many more factors to consider. In addition, achieving a new role, function and reinvigorated identity for today's Torontonians ethnic enclaves, via the implementation of this manual, would be a long-term process in which gradual results would be seen over time. This time period would also involve the manual and method undergoing various modifications. Moreover, once this manual has been utilized for a design project within an enclave, strict measures would need to be taken to ensure that the design interventions are operating as desired. For example, a new public square would require rigorous programming to allow for various types of gatherings and activation. Otherwise, it would serve as a public space and become severely underutilized many times throughout the year.

Despite the fact the these three interventions were tested on specific locations along the retail strip, they do not necessarily have to be in those chosen sites nor in that amount - they are simply plug-ins that stand as example outcomes of the manual. If considered in realistic and time-sensitive terms, the complete regeneration of the Gerrard Bazaar would be a long-term process that would involve more of these manual-based interventions built in different phases over time.

Envisioned phase development:

- Phase 1 - Library re-activation intervention is constructed
- Phase 2 - Lahore Tikka House re-use intervention is constructed
- Phase 3-5 - Re-imagine intervention, New Senior Complex, constructed
- Phase 6 - New Re-use intervention, SAVAC/ Art pop-up space, constructed
- Phase 7 - New Re-use intervention, SAVAC/ Art pop-up space, constructed
- Phase 8 - New Re-use intervention, SAVAC/ Art pop-up space, constructed
- Phase 9 - New Re-use intervention, SAVAC/ Art pop-up space, constructed
- Phase 10 - New Re-activation interventions to cater to the expanding public realm

In terms of the application of this manual in other ethnic enclaves, the over-arching strategy would be the same. However, there would be differences in the type of networks and architecture typologies depending on how the ethnic enclave operates. For example, these strategies would be very similar if applied to a site like Greektown, because it is facing the very same issues and has a more independent entrepreneurship strategy. On the other hand, these strategies would differ in Chinatown because of the underlying clan structure, that requires different types of networks and architecture.

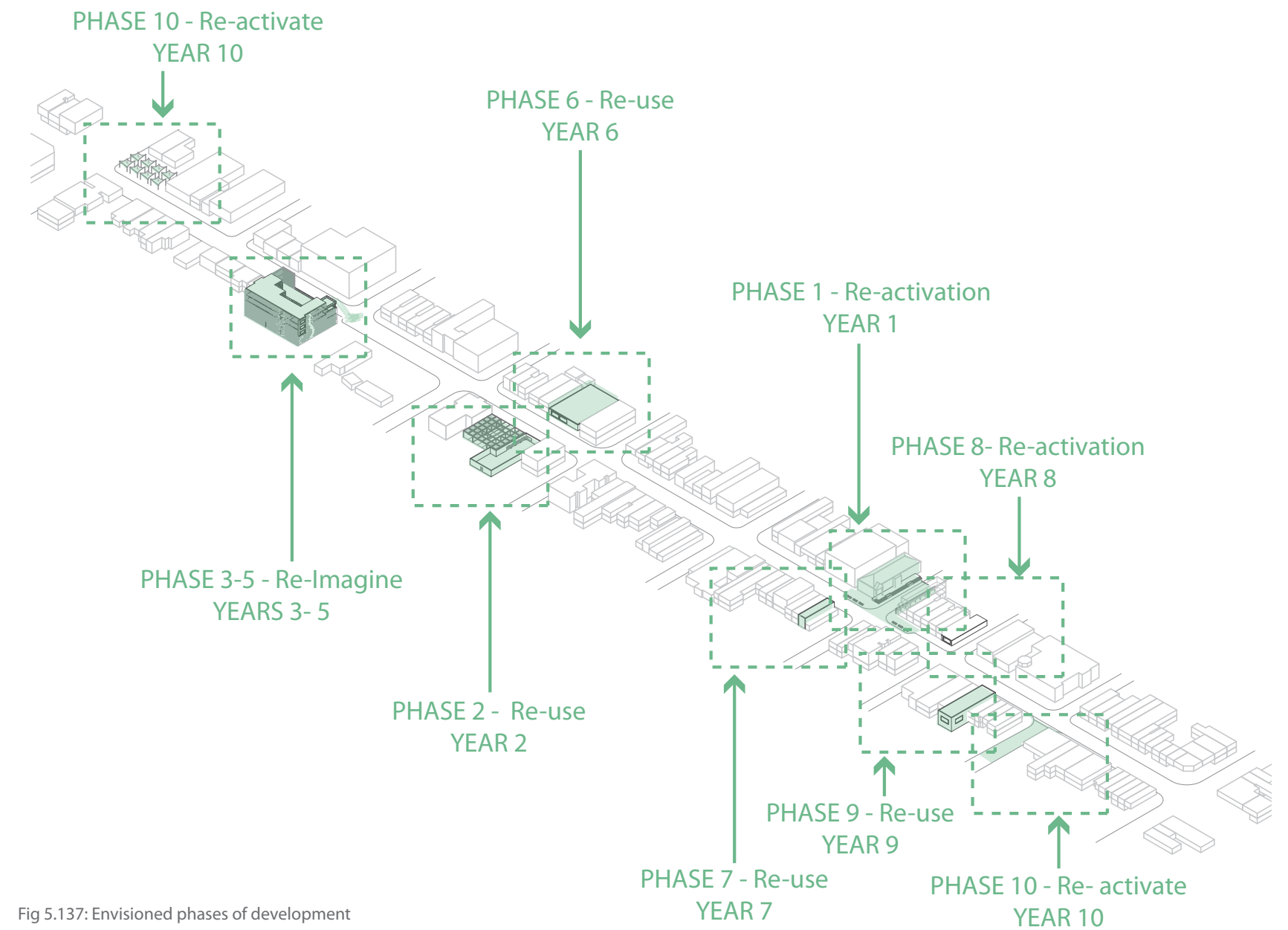


Fig 5.137: Envisioned phases of development

Endnotes

1. Chinatown revitalization. in City of Vancouver [database online]. 2014 [cited February 5 2015]. Available from <http://vancouver.ca/home-property-development/chinatown-revitalization.aspx>.
2. Streetsville main street square redevelopment. 2013. Mississauga: City of Mississauga, <http://www.mississauga.ca/file/COM/2013-04-25-SMSS-Public-Presentation.pdf> (accessed February 5,2015).
3. Mississauga civic centre square and mississauga central library square redevelopment. 2009. Toronto: CS&P Architects Inc., http://www5.mississauga.ca/isf/civic_square_overview.pdf (accessed February 5, 2015).
4. Arcilla, Patricia. "Urban platform" wins first in lisbon open room competition. in Arch Daily [database online]. 2015 [cited 04/05 2015]. Available from <http://www.archdaily.com/611966/urban-platform-wins-first-in-lisbon-open-room-competition/#>.
5. Jordana, Sebastian. Senior residence/ a/ LTA. in ArchDaily [database online]. 2011 [cited February 5 2015]. Available from <http://www.archdaily.com/127609/seniors-residence-alta/>.
6. Furuto, Alison. Solund retirement community second prize winning proposal / henning larsen architects. in ArchDaily [database online]. 2012 [cited February 5 2015]. Available from <http://www.archdaily.com/293923/solund-retirement-community-second-prize-winning-proposal-henning-larsen-architects/>.
7. Plassen cultural centre / 3XN architects. ArchDaily, 2012 [cited February 5 2015]. Available from <http://www.archdaily.com/279891/plassen-cultural-center-3xn-architects/>.

Conclusion

With immigrants moving directly to the suburbs upon entry within Ontario, ethnic enclaves within the downtown Toronto are facing many challenges. They no longer serve as immigrant reception areas, but rather, retail or residential areas with a distinct cultural character - one that is on the verge of change. Gentrification, economic decline, urban vacancy and a changing identity are several of the numerous factors that are promoting these changes. The Gerrard Bazaar is one of the many examples of an ethnic enclave that is a neighbourhood in transition. Many South Asians do not live in, or visit the area while there is a large influx of young, well-off families moving in. The number of South Asian retail enterprises is gradually decreasing while vacant storefronts are often replaced with mainstream businesses. This is causing a divide and clashes between the South Asian merchants and mostly Caucasian residents.

This thesis established that the Gerrard Bazaar is experiencing decline. This decline is not only related to its economy, but also its ability to respond to the changing demographics of the neighbourhood within which it is situated.

After analyzing various discourses on ethnic enclaves, this thesis grasped the viewpoint of Mohammed Qadeer, a notable scholar who draws on his years of research to explain how ethnic enclaves are voluntary settlements that allow new immigrants to establish and integrate themselves within a foreign society. He also states that institutions within ethnic communities are key players that foster interaction and social cohesion. Furthermore, he states that although ethnic enclaves don the identity of a particular culture, they do not disintegrate if social cohesion occurs. It is these main points that established a framework within which this thesis unfolded. The key players were identified in this thesis as "key entities" and the goal was to study these in relation to the lack of social cohesion within the enclave.

In order to go about studying the Gerrard Bazaar with these key points in mind, this thesis was divided into three research components which form an integral part of the method - historic and demographic research, architectural and spatial research, and personal research. Each of these forms of study allowed for the Gerrard Bazaar to be examined from a macro-scale to a micro-scale and from a theoretical perspective and a personal perspective. It was discovered that despite the so-called "divide" between residents and merchants, most individuals from both ethnic groups are in favour of keeping the Gerrard Bazaar alive and thriving. Further investigations conducted within this thesis reveal that many South Asians who frequent the bazaar would like to see it retain its identity as a South Asian retail destination while many non-South Asians would like to see more inclusivity within events and initiatives that take place along the retail strip. The accumulation of this research, along with the key points stated by Qadeer, revealed that the main issue present within the Gerrard Bazaar, and the one that can solve many problems, is the lack of cultural exchange.

After this was determined, this thesis went on to speculate on how architecture and urban design can act as an instigator of this cultural exchange. "key entities" were studied in more detail and once areas of new networks were identified, a strategic design process was initiated.

In order to make sure that the compilation of research was utilized to influence the design interventions, a set of urban strategies were devised to ensure that the design process acknowledged all previous findings. These urban strategies also allowed for a more strategic and formalized design approach that ensures that every design intervention operates in the same way and toward the same goal. Not only are these strategies meant to create a new infrastructure that can support cultural identity but they are also meant to help optimize current uses and events within the Gerrard Bazaar.

The creation of the manual of urban strategies in this thesis is a vital step. Generally speaking, manuals are effective because they promote efficiency, ensure consistency, reduce errors and allow for a well-guided process for a formalized outcome. In this thesis, the manual was imperative to ensure that all of that which had been researched was effectively integrated into each design intervention in the same way and to the same extent. It would also enable the final design to be more formalized, convincing and responsive. Furthermore, it was important to apply the same steps to any site to evaluate how the manual works depending on site conditions. The key disadvantage to this manual, however, is its limitations in flexibility - different sites require slightly different designs and the manual, in a sense, restrict the design to the urban strategies outlined within it.

One key thing to note within this thesis is that the main emphasis is not on the architecture or design of the interventions, but rather on the method of research and data collection, and how the research was extracted to form a manual to produce architecture that served as a "plug-in" to this method.

At the beginning of this thesis, a series of questions were put forward. The answer to these questions is now apparent, given the compiled research, developed method and proposed designs.

What role can architecture and urban design play in strengthening local interests and networks?

Architecture and urban design can serve as a facilitator or armature which utilizes specific design maneuvers to promote gathering and social interaction. However, in the case of the Gerrard Bazaar, it is imperative for there to be a rigorous program housed within this architecture - one that allows for the South Asian culture to be shared and celebrated with a multi-cultural crowd. Inclusion is key. Different design maneuvers can

create different spatial conditions that can be utilized in various ways depending on the program.

What is the method by which research and data can be accumulated to influence this architecture?

The method is one that consists of several steps. These steps begin by looking at historical, theoretical and demographic information, and then zooming into a more micro-scale. Ultimately they involve human research to obtain a personal perspective. These are all factors that influence the architectural design.

How can this method work to promote inclusion and cultural exchange within an ethnic enclave?

This method is meant to primarily determine what kinds of designs housed such programs in the past, how these have worked, what the current architectural conditions are of the site and what people want to see and do within the site. An important determination is how people see culture, how it varies from person to person, and how this can influence the design.

How would it allow for a renewed identity or locus of an ethnic enclave and what would this identity be?

New architecture and new programs would reinvigorate the ethnic enclave, bringing together people on various occasions and lending to the memory and perception of the place. The main idea in this instance is to promote the identity of the Gerrard Bazaar, through this architecture, as a place that holds strong to its South Asian roots, but welcomes and celebrates with everyone.

The research process and formulated manual within this thesis is meant to serve as the initiation of a broader strategy to promote cultural exchange or urban regeneration within the changing Torontonians ethnic enclave of today. It stands as a solution that can act as a new model for regeneration so that areas such as the Gerrard Bazaar are more acknowledging of their demographic, economic and social changes and are able to respond to them in an appropriate manner.

BIBLIOGRAPHY |

Books:

Bauder, Harald, and Angelica Suorineni. 2010. *Toronto's little india: A brief neighbourhood history*. Toronto: Ryerson University.

Beverly, Ted. No year. *The Neighbourhood Around Gerrard/Ashdale: An Annotated Bibliography*. Introduction by Ruth E. Wallace. Toronto: Toronto Public Library, Gerrard/Ashdale Branch.

Brown-Saracino, Japonica. 2010. *A neighborhood that never changes: Gentrification, social preservation, and the search for authenticity* University Of Chicago Press.

Bunting, Trudi E., Pierre Filion, and Ryan Christopher Walker. 2010. Chapter 9: New diversity: Social change as immigration. In *Canadian cities in transition: New directions in the twenty-first century*.

Carter, Tom, Marc Vachon, John Biles, Jim Zamprelli, Erin Tolley, and University of Winnipeg. *Institute of Urban Studies*. 2006. *Our diverse cities : Challenges and opportunities*. Winnipeg, Man.: *Institute of Urban Studies*.

Chen, Chun-houh Härdle, Wolfgang. Unwin, Antony. 2007. *Handbook of data visualization*, ed. edited by C. Chen, W. Härdle, A. Unwin. Berlin ; London : Springer, 2007.

Fressoli, Mariano, Elisa Arond, Dinesh Abrol, Adrian Smith, and Adrian Ely. 2013. *Grassroots innovations' framings and their models of engagement: Implications for models of inclusive innovation*. Rio de Janeiro.

Fong, Eric. 2006. *Inside the mosaic*. University of Toronto Press.

Hiebert, Daniel. 2009. *Exploring minority enclave areas in montréal, toronto, and vancouver*, ed. Daniel Hiebert. Ottawa, Ont. : Citizenship and Immigration Canada, 2009.

Jones, K. & Simmons, J. (1993). *Location, Location, Location: Analyzing the Retail Environment* (2nd ed.). Scarborough: Nelson Canada.

Judd, Dennis R., and Susan S. Fainstein. 1999. *The tourist city* Yale University Press.

McCarthy, John, 1961-. 2007. *Partnership, collaborative planning and urban regeneration*. Aldershot, England ; Burlington, VT; Aldershot, Hants, England ; Burlington, VT: Ashgate.

Mostaedi, Arian. 2003. *Homes for senior citizens*. Barcelona: Carlos Broto & Joseph Ma Minguet.

Nursing homes and senior citizen care. 1986. *Nursing Homes and Senior Citizen Care*.

Richards, Greg. 2010. *Eventful cities : Cultural management and urban revitalisation*, ed. Robert Palmer. Amsterdam: Amsterdam : Elsevier/Butterworth-Heinemann.

Rossi, Aldo, 1931-1997, and Aldo Rossi 1931-1997. 1982. *The architecture of the city*, eds. Graham Foundation for Advanced Studies in the Fine Arts, Institute for Architecture and Urban Studies. Cambridge, Mass.: Cambridge, Mass. : MIT Press.

Spoonley, Paul, Erin Tolley, and Queen's University (Kingston, Ont.). School of Policy Studies. 2012. *Diverse nations, diverse responses : Approaches to social cohesion in immigrant societies*. Kingston, Ont. : Montreal: School of Policy Studies, Queen's University ; McGill-Queen's University Press.

Walks, Alan R. 2010. *New divisions: Social polarization and neighborhood inequality in the canadian city*. In *Canadian cities in transition: New directions in the twenty-first century*. Don Mills: Oxford UP.

Zucchi, John. 2007. *A history of ethnic enclaves in canada*. Canada's ethnic group series. Ottawa: The Canadian Historical Association.

Journals:

CHAVIS, DM, and A. WANDERSMAN. Sense of community in the urban- environment - a catalyst for participation and community- development. *American Journal of Community Psychology; Am.J.Community Psychol.* 18 (1): 55-77.

Davis, J. Urban catalysts in theory and practice. *ARQ-ARCHITECTURAL RESEARCH QUARTERLY; Arq-Archit.Res.Q.* 13 (3-4): 295-306.

Hoernig, Heidi. 2009. Planning amidst cultural diversity ; lessons from religious development. *Welcoming Communities : Planning for Diverse Populations*.

Kumar, Sandeep, and George Martin. 2004. A case for culturally responsive urban design. *The Ontario Planning Journal* 19 (5): 5-7.

Lynch, Robert. The arts are definitely good for business: Final article in a three-part series on the value of nonprofit arts and culture organizations to local governments. *Public Management* 95 (3): 16.

Portes, Alejandro, and Leif Jensen. 1992. Disproving the enclave hypothesis. *American Sociological Review* 57 (3): 418.

Zhuang, Zhixi Cecilia. 2009. Ethnic retailing and implications for planning multicultural communities. *Welcoming Communities : Planning for Diverse Populations*.

Reports/ Papers:

Census snapshot – Immigration in Canada: A portrait of the foreign-born population, 2006 census. 2008. Statistics Canada, , <http://www.statcan.gc.ca/pub/11-008-x/2008001/article/10556-eng.htm> (accessed 12/21 2015).

Bauder, Harald, and Isabel Ritchie. 2011. *Toronto's little india in residential context: A geographical analysis of census data.* Toronto: Geography Publications and Research, 35.

Mazumdar, Sanjoy. *Ethnic enclaves, diversity and multiculturalism: Should environmental design researchers care?*

Murdie, Robert, and Carlos Teixeira. *The Impact of Gentrification on Ethnic Neighbourhoods in Toronto: A Case Study of Little Portugal.* Tech. N.p.: Urban Studies, 2011. Print.

Qadeer, Mohammad, Sandeep K. Agrawal, and Alexander Lovell. 2010. *Evolution of ethnic enclaves in the Toronto metropolitan area 2001 - 2006.*

Qadeer, Mohammad, and Sandeep Kumar. 2006. *Ethnic enclaves and social cohesion.* , <http://ejtest.uwinnipeg.ca/bitstream/handle/10680/382/a-qadeer-eng.pdf?sequence=1> (accessed January 28, 2015).

Zhuang, Zhixi Cecilia. 2008. *Ethnic retailing and the role of municipal planning four case studies in the greater Toronto area.* Waterloo, Ont. : University of Waterloo.

Online Databases:

Abbotsford gur sikh temple. in Trip Advisor [database online]. 2015 [cited 03/26 2015]. Available from http://www.tripadvisor.ca/Attraction_Review-g181725-d1867352-Reviews-Abbotsford_Gur_Sikh_Temple-Abbotsford_British_Columbia.html.

About business improvement areas. in City of Toronto [database online]. 2015 [cited 03/26 2015]. Available from http://www1.toronto.ca/wps/portal/cont_ontonly?vgnextoid=71571c8ab77da310VgnVCM10000071d60f89RCRD&vgnnextchannel=673032d0b6d1e310VgnVCM10000071d60f89RCRD.

Adult learning and events. in Danforth Jewish Circle [database online]. 2015 [cited February 6 2015]. Available from <http://djctoronto.com/education/programs-and-events/>.

Arcilla, Patricia. "Urban platform" wins first in Lisbon open room competition. in Arch Daily [database online]. 2015 [cited 04/05 2015]. Available from <http://www.archdaily.com/611966/urban-platform-wins-first-in-lisbon-open-room-competition/#>.

Border town. in Divided Cities [database online]. 2012 [cited 03/22 2015]. Available from <http://dividedcities.com/post/11361304852/deb-chachra-is-one-of-the-godparents-of-border>.

Buchignani, Noman. South asian Canadians. in Canadian Encyclopedia [database online]. 2014 [cited 06/28 2014]. Available from <http://www.thecanadianencyclopedia.ca/en/article/south-asians/>.

Chinatown revitalization. in City of Vancouver [database online]. 2014 [cited February 5 2015]. Available from <http://vancouver.ca/home-property-development/chinatown-revitalization.aspx>.

Chinatown's street signs Toronto Ontario Canada. in Hicker-Stock-Photography [database online]. 2015 [cited 02/06 2015]. Available from <http://www.hicker-stock-photography.com/stockphoto/chinatown-street-signs-toronto-ontario-canada-73.htm>.

Chown Oved, Marco. Riverdale hub moving from charity to enterprise. in Toronto Star [database online]. 2013 [cited 01/03 2015]. Available from http://www.thestar.com/business/2013/01/03/riverdale_hub_moving_from_charity_to_enterprise.html.

Classification of visible minority. in Statistics Canada [database online]. 2012 [cited 03/25 2015]. Available from <http://www.statcan.gc.ca/concepts/definitions/minority01-minorite01a-eng.htm>.

Community group calls for halt on Chinatown development. in Glass City [database online]. [cited February 4 2015]. Available from <http://glasscity.ca/2015/01/20/community-group-calls-halt-chinatown-development/>.

Dislocations A Scotiabank CONTACT featured exhibition 2013. in Wordpress [database online]. 2013 [cited January 30 2015]. Available from <https://dislocations2013.wordpress.com/>.

Ethnic diversity and immigration. in Statistics Canada [database online]. 2007 [cited 03/26 2015]. Available from http://www41.statcan.gc.ca/2007/30000/ceb30000_000-eng.htm.

Furuto, Alison. Solund retirement community second prize winning proposal / Henning Larsen Architects. in ArchDaily [database online]. 2012 [cited February 5 2015]. Available from <http://www.archdaily.com/293923/solund-retirement-community-second-prize-winning-proposal-henning-larsen-architects/>.

IIFA awards green carpet. in The Windsor Star [database online]. 2015 [cited 03/26 2015]. Available from <http://www.windsorstar.com/life/Photos+IIFA+Awards+Green+Carpet/5008722/story.html>.

Inner suburbs at stake: Investing in Scarborough's communities. in Ju Hui Judy Han [database online]. 2015 [cited 01/18 2015]. Available from <http://judyhhan.com/post/141>.

Jordana, Sebastian. Senior residence/ a/ LTA. in ArchDaily [database online]. 2011 [cited February 5 2015]. Available from <http://www.archdaily.com/127609/seniors-residence-alta/>.

Lavoie, Joanna. GerrardART project aims to revitalize Little India neighbourhood. in Inside Toronto [database online]. Toronto, 2012 [cited 05/22 2014]. Available from <http://www.insidetoronto.com/news-story/1310727-gerrardart-project-aims-to-revitalize-little-india-neighbourhood/>.

Vancouver chinatown. in Definium Design Group [database online]. 2015 [cited February 5 2015]. Available from <http://www.vancouver-chinatown.com/>.

Maps:

*Change in census tract average individual income, 1970 - 2005 toronto region.*2006. . Cities centre, university of toronto, the three cities within toronto. Vol. N.T.S.

*Percentage of the total immigrant population of the inner city, inner suburbs, and the outer suburbs and percentage of the population immigrant by census tract, toronto CMA, 1971 and 2006.*2006. Cities centre, university of toronto, the three cities within toronto. Vol. N.T.S.

*Population density of low-income neighbourhoods, city of toronto, 2006.*2006. . Cities centre, univeristy of toronto, The Three cities Within Toronto. Vol. N.T.S.

*Toronto average re-sale residential values 2010.*2010. . The value of trees. Vol. N.T.S.

*Toronto official plan: Map 21 land use plan.*2010. Toronto official plan. Vol. N.T.S.

Websites:

About | miss india canada. [cited January 23 2015]. Available from <http://www.missindiacanada.com/about/>.

Ahmad, Mukhtar. Markets in full bloom as kashmir braces for eid. in Rediff News [database online]. 2012 [cited 01/06 2015]. Available from <http://www.rediff.com/news/slide-show/slide-show-1-markets-in-full-bloom-as-kashmir-braces-for-eid/20120818.htm>.

Almeida, Gustavo. 2008. *Little portugal | toronto*. Skyscraper city.

Andrew D'Cruz. 2013. The best places to live in the city: A (mostly) scientific ranking of all 140 neighbourhoods in toronto. *Toronto Life.*, <http://www.torontolife.com/informer/toronto-real-estate/2013/08/14/toronto-best-neighbourhoods/> (accessed January 29, 2014).

Brown, Tyson. 2012. Paksitani heritage in toronto: *Faith and family*. Heritage toronto., <http://heritagetoronto.org/pakistani-heritage-in-toronto-faith-and-family/>.

Chopp, Chris. Rashtrapati bhavan mughal gardens open from 14 february. in Full Stop India [database online]. 2015 [cited 01/06 2015]. Available from <http://www.fullstopindia.com/rashtrapati-bhavan-mughal-gardens-open-from-10-february/>.

City of toronto: Toronto facts. 2013 [cited December 28 2015]. Available from http://www.toronto.ca/toronto_facts/diversity.htm.

Cultural mosaic. in Central Alberta Refugee Effort [database online]. 2014 [cited 03/26 2015]. Available from <http://immigrant-centre.ca/cultural-mosaic/>.

Colorful kaleidoscopic cultural collage in udaipur. in Travel Pod [database online]. 2011 [cited 01/06 2015]. Available from <http://www.travelpod.com/travel-blog-entries/friesendm/12/1304926290/tpod.html>.

Daskar : Nature bazaar 2010. in Purple Homes [database online]. 2010 [cited 01/06 2015]. Available from <http://purplehomes.blogspot.ca/2010/10/daskar-nature-bazaar-2010.html>.

Echternacht, Laura. Quiet india – the sunrise at river ganga. in Water & Megacities [database online]. 2012 [cited 01/06 2015]. Available from <http://www.waterandmegacities.org/quiet-india-the-sunrise-at-river-ganga/>.

Festival of South Asia, TD. Event information: Festival of south asia. 2014 [cited May 30 2015]. Available from http://www.festivalofsouthasia.com/event_information.html.

Gentrification trends. [cited 03/27 2015]. Available from <http://uwebip.httpcv.com/gentrification-trends.php>.

Gerrard india bazaar BIA. [cited January 24 2015]. Available from <http://www1.toronto.ca/wps/portal/contentonly?vgnextoid=74a2ad51a40ea310VgnVCM10000071d60f89RCRD>.

Gwylm, . The world's best photos. in Flickr Hive Mind [database online]. 2015 [cited 01/06 2015]. Available from <http://flickrhivemind.net/User/Gwylm/Interesting>.

Handlon, James. Foto friday – the taj mahal, agra, uttar pradesh, India. in James Handlon [database online]. 2011 [cited 01/06 2015]. Available from <http://jameshandlon.com/2011/07/15/the-taj-mahal-aggra-uttar-pradesh-india/>.

Keung, Nicholas, and Yelaja, Prithi. Knowing the neighbours. 2005 [cited January 28 2015]. Available from <http://www.dpcdsb.org/NR/rdonlyres/9AB5EDC3-4EA7-4CDE-A973-2F50A4679C08/61204/Knowingtheneighbours.pdf>.

Language diversity across toronto's 44 wards; based on 2006 census data. in Reddit [database online]. 2015 [cited 03/26 2015]. Available from http://www.reddit.com/r/toronto/related/1c3b8l/language_diversity_across_torontos_44_wards_based/.

L. Robertson, Scott. Vancouver chinatown gate 2. [cited February 4 2015]. Available from <http://www.slrobertson.com/galleries/canada/vancouver/chinatown/vancouver-china-town-gate-2.htm>.

McGuire, Liam. 2012. *May day podcast // international workers' day // social polarization in toronto*. Toronto | the city., <http://thecityfm.org/2012/04/30/may-1-show-preview-international-workers-day-social-polarization-in-toronto/>.

Merriam webster dictionary. 2014 [cited 03/25 2015]. Available from <http://www.merriam-webster.com/dictionary/>.

Micallef, Shawn. The riverdale hub expands on toronto's ever-evolving gerrard street. *Yongestreet*, <http://www.yongestreetmedia.ca/features/>

riverdalehub0831.aspx (accessed January 23, 2015).

Mississauga civic centre square and mississauga central library square redevelopment. 2009. Toronto: CS&P Architects Inc., 1, http://www5.mississauga.ca/isf/civic_square_overview.pdf (accessed February 5, 2015).

Miss pakistan world 2013. 2013 [cited 03/26 2015]. Available from <http://misspakistanworld.com/miss-pakistan-world-2013/>.

Mohan, Radhika. Land of fiery cuisine, saris & mansions. in Buzz in Town [database online]. 2009 [cited 01/06 2015]. Available from <http://www.buzzintown.com/article-review--land-fiery-cuisine-saris-mansions/id--801.html>.

Origami, The. Saving little india. 2014 [cited January 23 2015]. Available from <http://theorigami.ca/2014/01/22/saving-india/>.

Oxford dictionaries. in Oxford University Press [database online]. 2015 [cited 03/25 2015]. Available from <http://www.oxforddictionaries.com/definition/english/>.

Pai, Mohan. Traditional hindu central courtyard houses of goa. in Sulekha [database online]. 2015 [cited 01/06 2015]. Available from http://creative.sulekha.com/traditional-hindu-central-courtyard-houses-of-go_a_440635_blog.

Plassen cultural centre / 3XN architects. ArchDaily, 2012 [cited February 5 2015]. Available from <http://www.archdaily.com/279891/plassen-cultural-center-3xn-architects/>.

Plummer, Kevin. Historicist: Nights out at the naaz theatre. in Torontoist [database online]. 2012 [cited 03/25 2015]. Available from <http://torontoist.com/2012/01/historicist-nights-out-at-the-naaz-theatre/>.

Quaid-e-azam mazhar. 2009 [cited 01/06 2015]. Available from http://www.essexteas.com/modules/com_communicator/quaid-e-azam-mazar-1501.html.

Razvi, Zainub. Sunday bazaar 006. in Flickr [database online]. 2007 [cited 01/06 2015]. Available from <https://www.flickr.com/photos/zainub/468399849/>.

Some significant moments in sikh-canadian history. [cited January 22 2015]. Available from <http://explorAsian.org/about-us/education/sikh-canadian-paper/tp-features/tp-propertyplus/building-it-scientifically/article5331243.ece>.

Sri lanka classic tour. in Lakpura Travels [database online]. 2015 [cited 01/06 2015]. Available from <https://www.lanka.com/holidays/sri-lanka-classic-tour/>.

Stans, Seven. Badshahi mosque, pakistan. in National Geographic [database online]. 2015 [cited 01/06 2015]. Available from http://travel.nationalgeographic.com/travel/countries/seven-stans-photos/#/badsahi-mosque-lahore-pakistan_12283_600x450.jpg.

Streetsville main street square redevelopment. 2013. Mississauga: City of Mississauga, 1, <http://www.mississauga.ca/file/COM/2013-04-25-SMSS-Public-Presentation.pdf> (accessed February 5,2015).

Sundar, Nandhini. Building it scientifically. in The Hindu [database online]. 2015 [cited 01/06 2015]. Available from <http://www.thehindu.com/todays->

Toronto's south asian film festival. [cited 03/9 2015]. Available from <http://filmifestival.org/about/>.

Toronto facts: Diversity. in City of Toronto [database online]. 2015 [cited 03/25 2015]. Available from <http://www1.toronto.ca/wps/portal/contentonly?vgnextoid=dbe867b42d853410VgnVCM10000071d60f89RCRD&vgnnextchannel=57a12cc817453410VgnVCM10000071d60f89RCRD>.

Top 10 best places to visit in karachi pakistan. in Trip Discovery [database online]. 2015 [cited 01/06 2015]. Available from http://pk.tripdiscovery.com/travelguide/top-10-best-places-to-visit-in-karachi-pakistan_aid8.

T, Yawar. Picture of SeaView karachi. in Trip Discovery [database online]. 2015 [cited 01/06 2015]. Available from <http://pics.tripdiscovery.com/beaches-parks/picture-of-seaview-karachi/>.

Vicky, Vicked. Minar-e-pakistan - the national building of pakistan. in Xcite for Fun [database online]. 2010 [cited 01/06 2015]. Available from <http://forum.xcitefun.net/minar-e-pakistan-the-national-building-of-pakistan-t53367.html>.

Interviews:

Interview with storeowner 1, 06/05 2014.

Interview with storeowner 2, 06/09 2014.

Interview with storeowner 3, 06/07 2014.

Interview with storeowner 4, 06/08 2014.

Interview with storeowner 5, 06/12 2014.

Interview with storeowner 6, 06/27 2014.

Interview with storeowner 7, 06/08 2014.

Interview with storeowner 8, 06/14 2014.

Interview with storeowner 9, 06/07 2014.

Interview with storeowner 10, 06/04 2014.

Interview with storeowner 11, 06/27 2014.

Interview with storeowner 12, 06/05 2014.

Interview with organization 13, 06/10 2014.

Interview with storeowner 14, 06/09 2014.

Interview with storeowner 15, 06/12 2014.

Interview with organization 2, 05/08 2014.

Interview with storeowner 17, 06/27 2014.

Interview with storeowner 18, 06/13 2014.

Interview with storeowner 19, 06/27 2014.

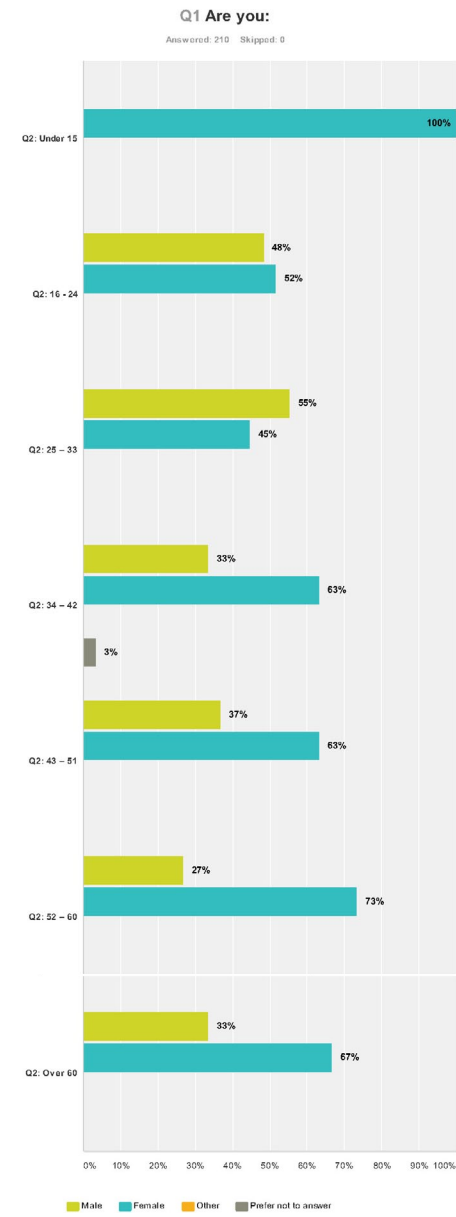
Interview with storeowner 20, 06/10 2014.

S. Chintaluri, personal communication, March 6, 2014.

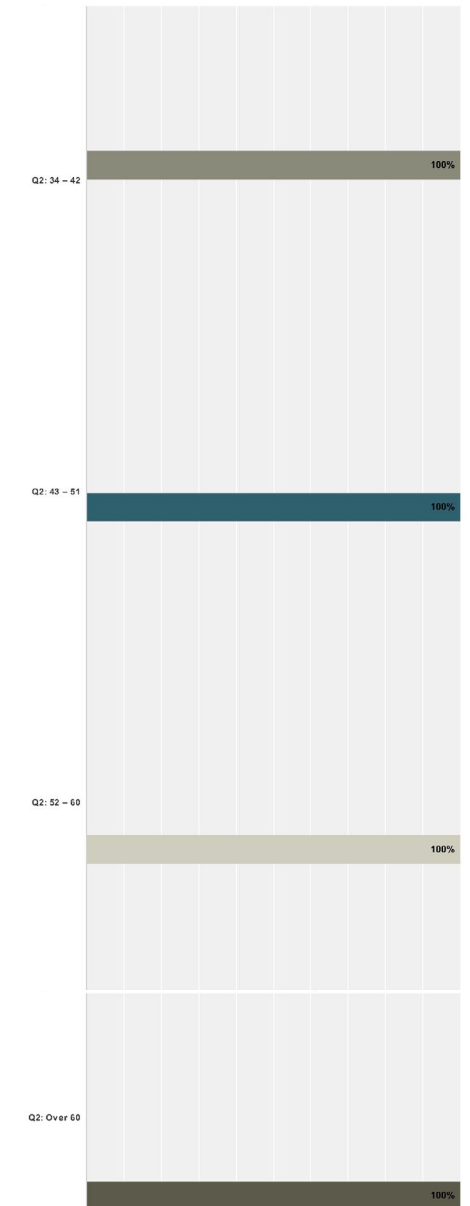
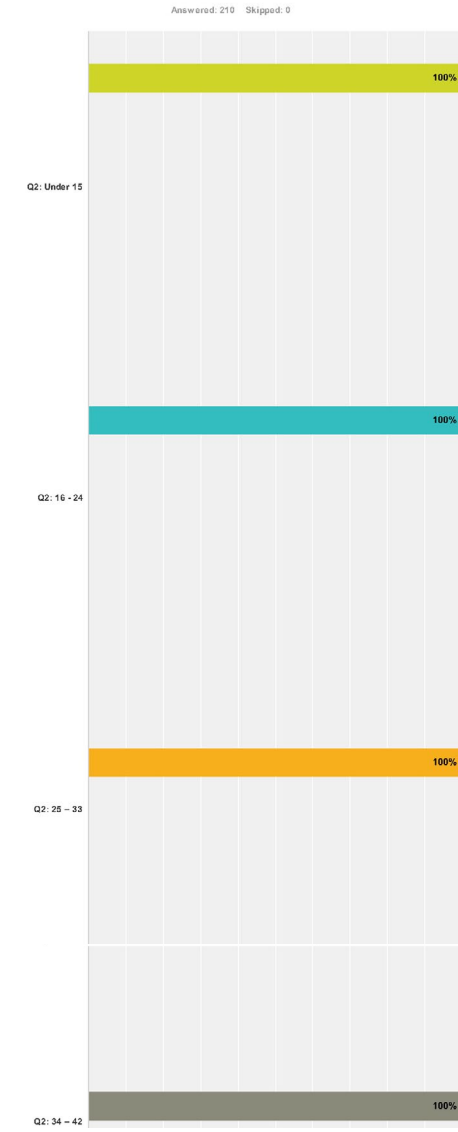
Videos:

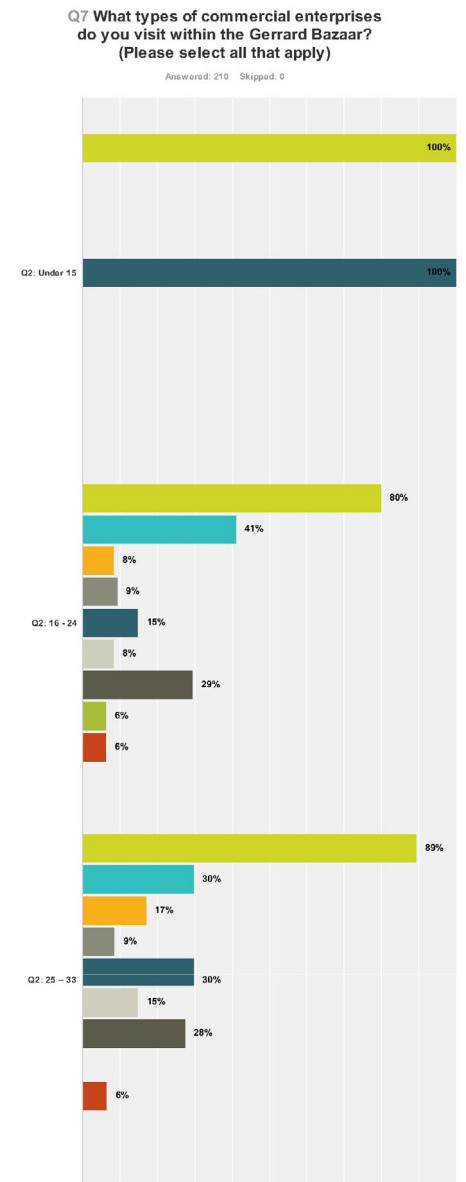
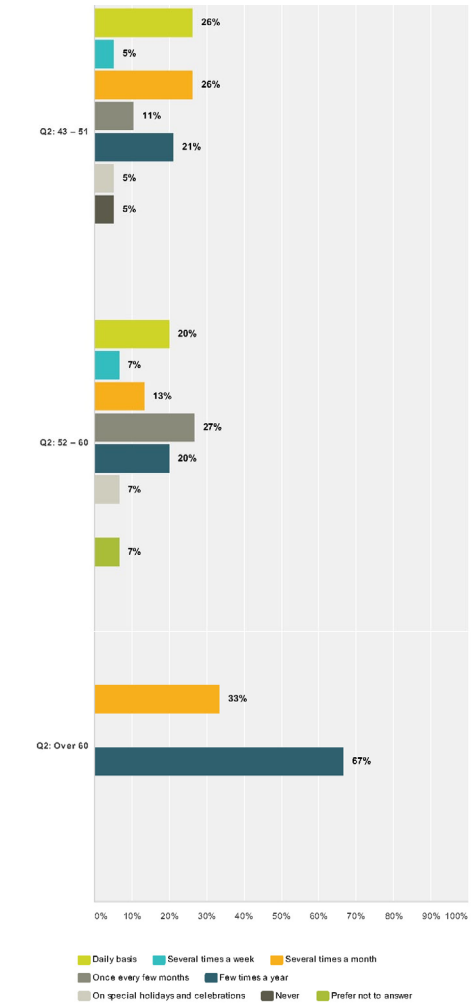
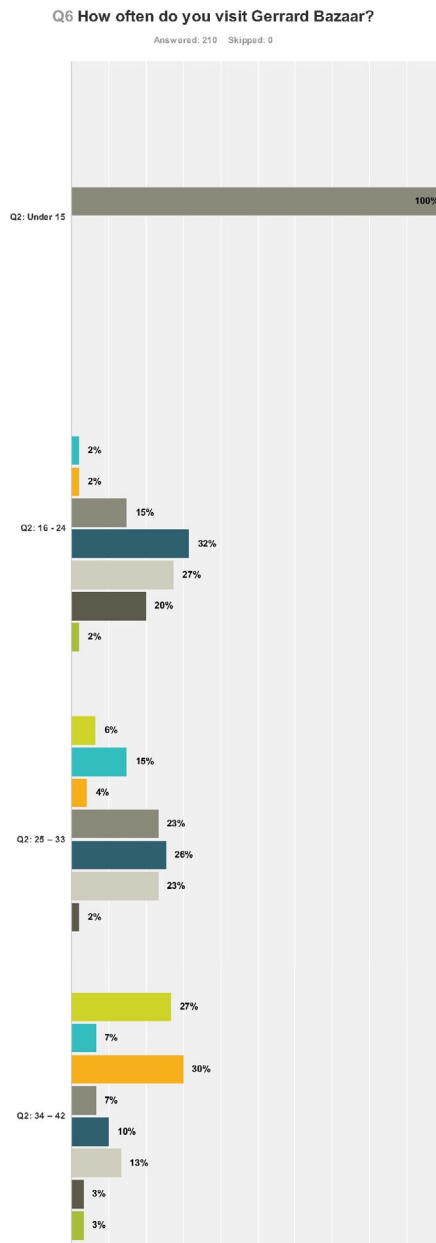
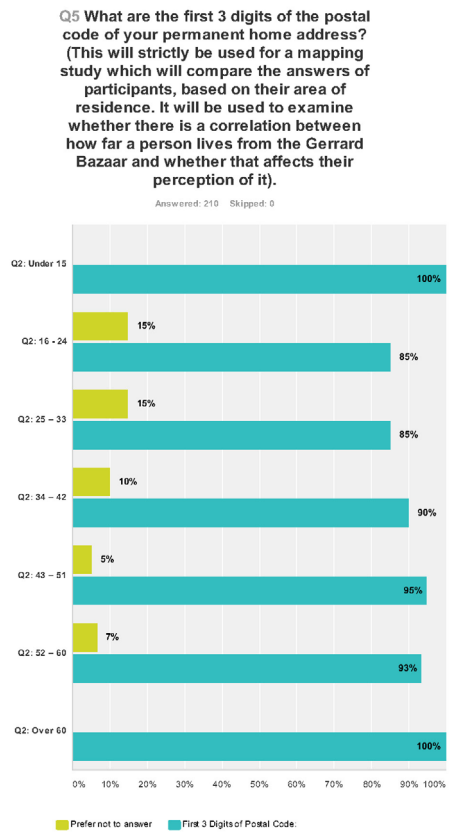
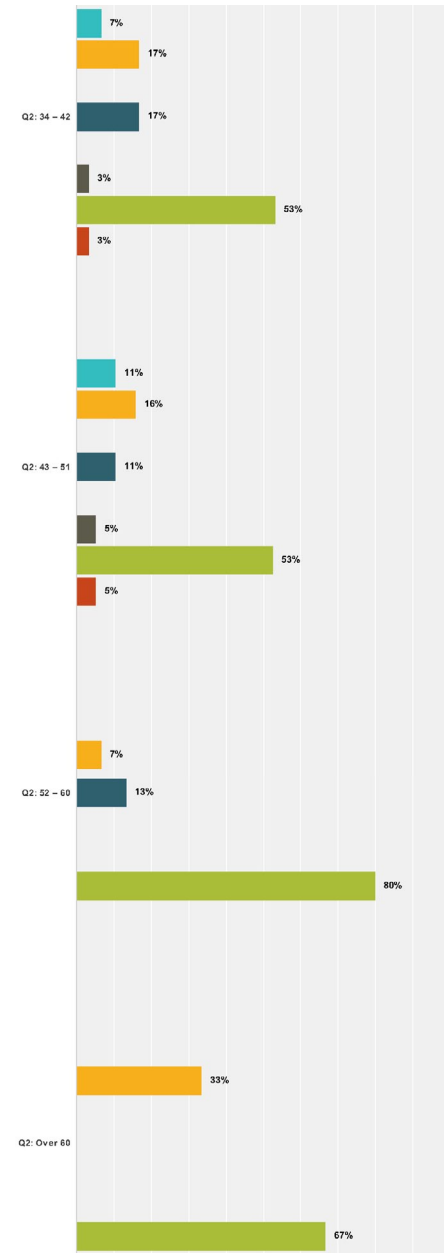
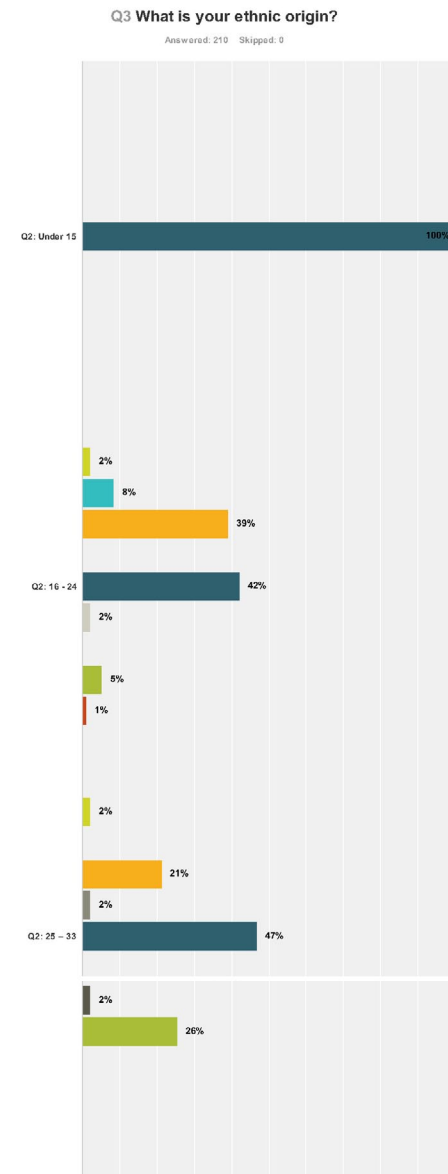
Syed, Aman. 2012. *Chand raat of eid al fitr 2012 gerrard street, toronto*, <http://www.youtube.com/watch?v=r1TEkSIOLMc>.

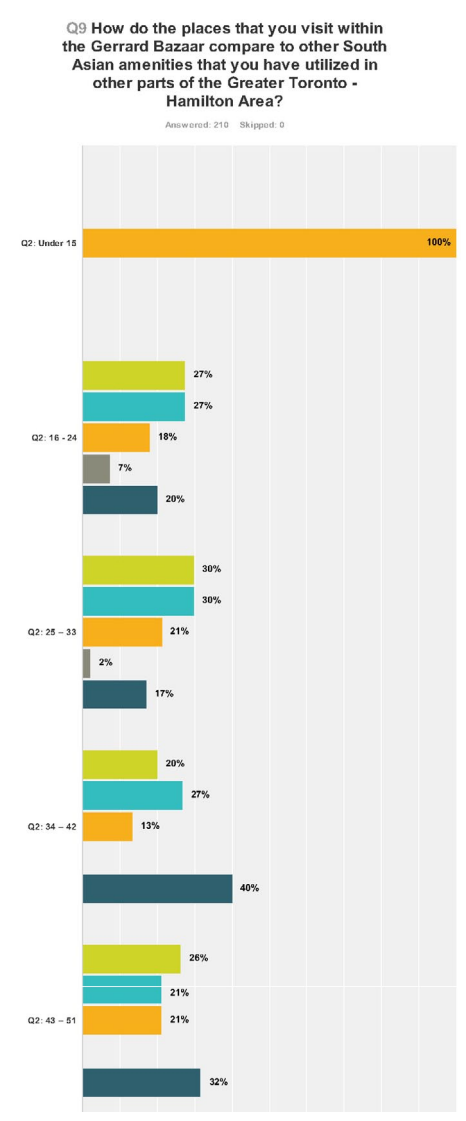
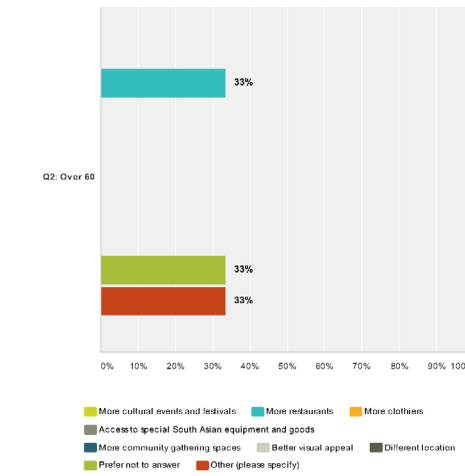
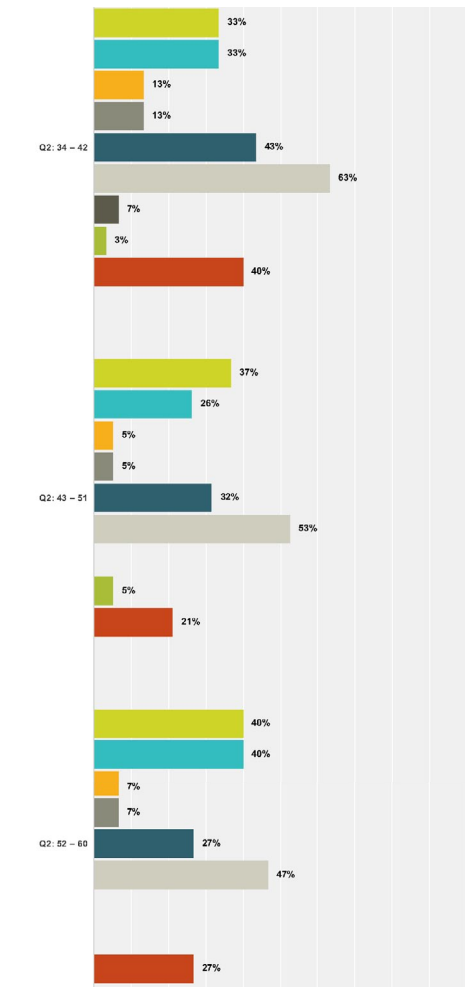
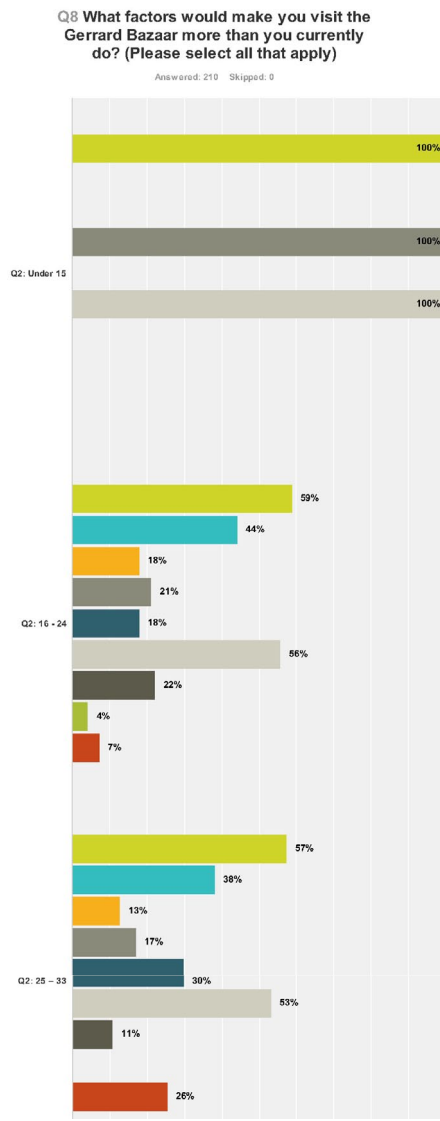
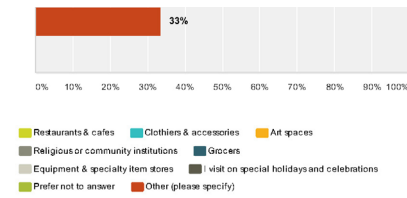
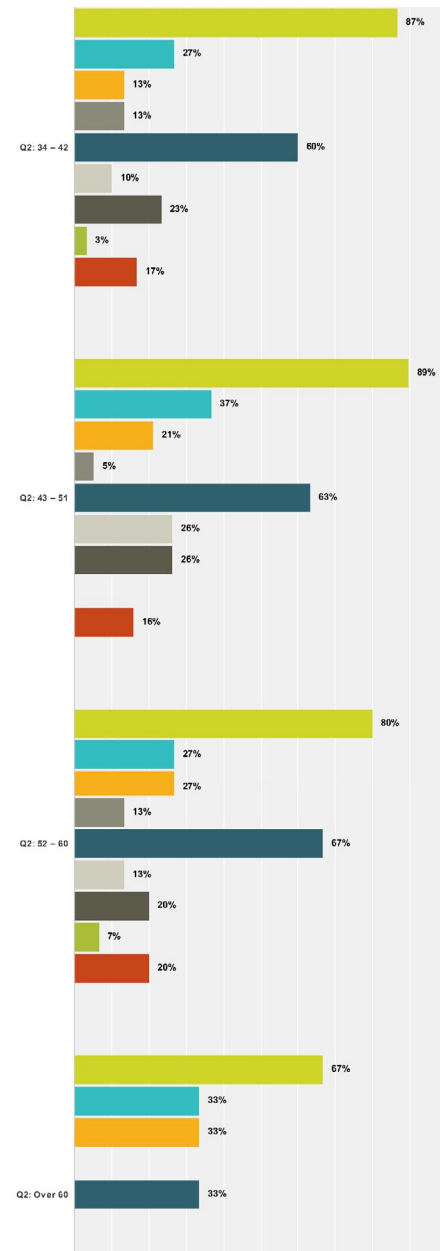
Survey Results - Filtered by Age

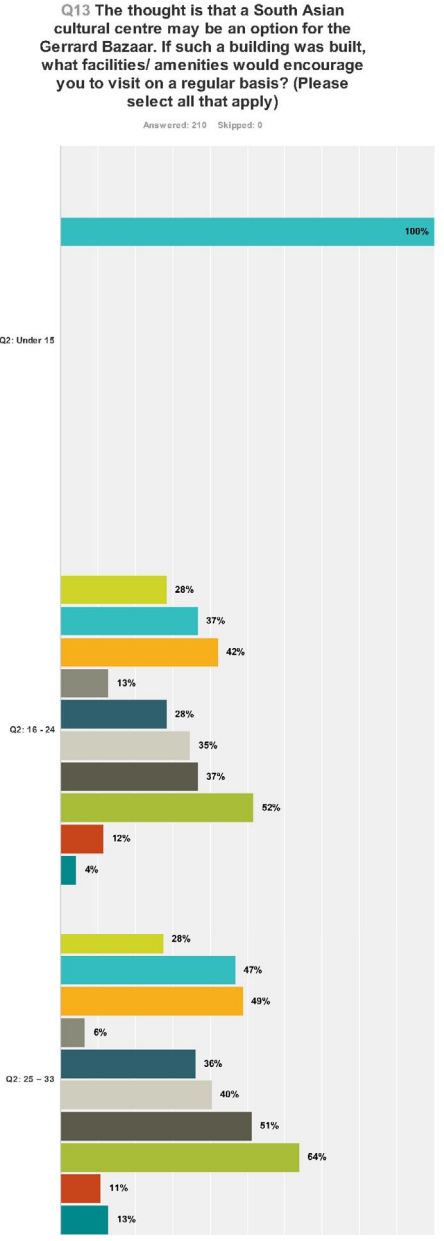
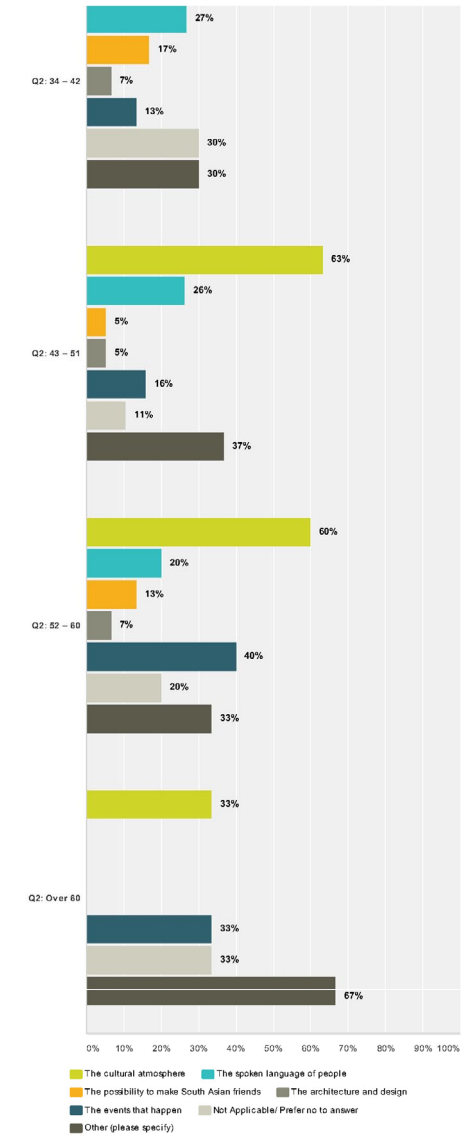
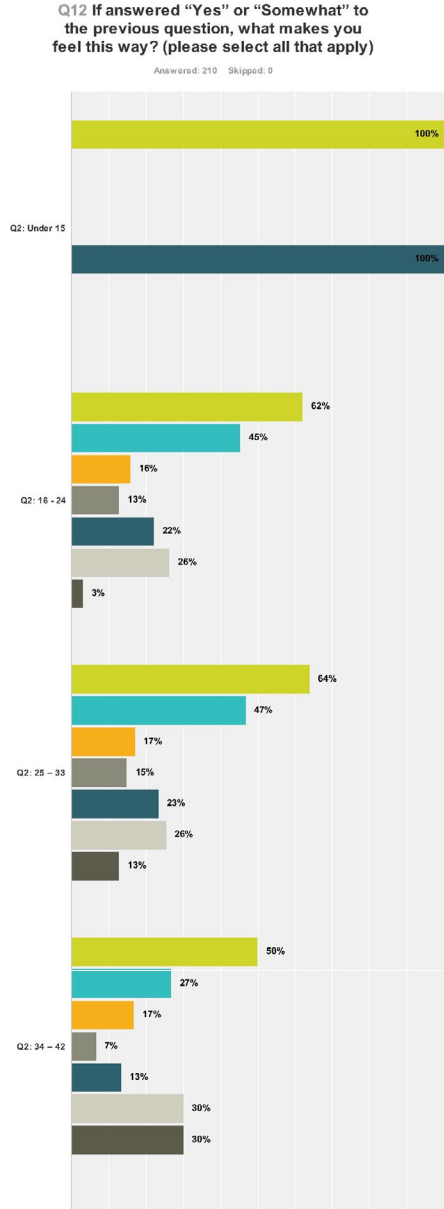
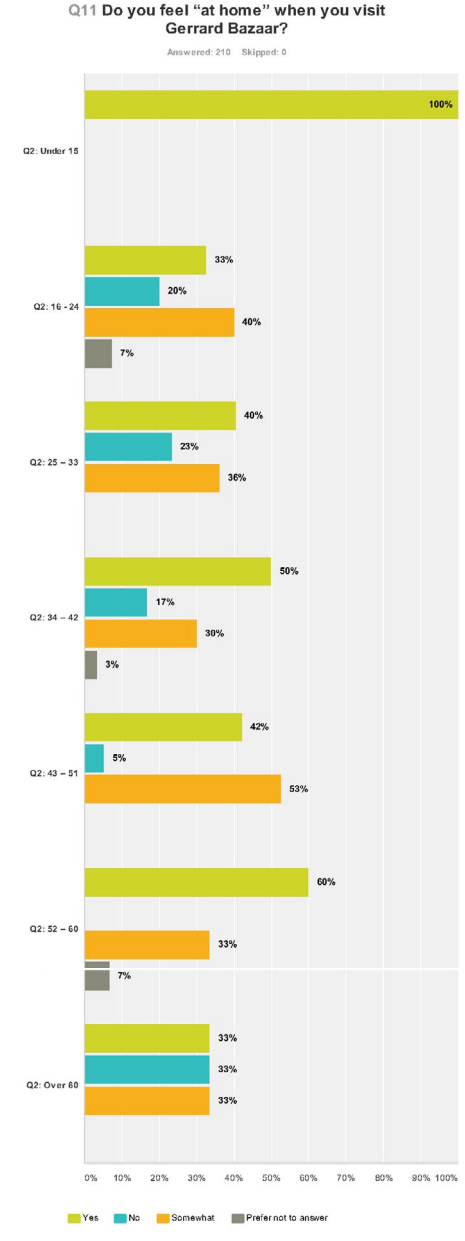
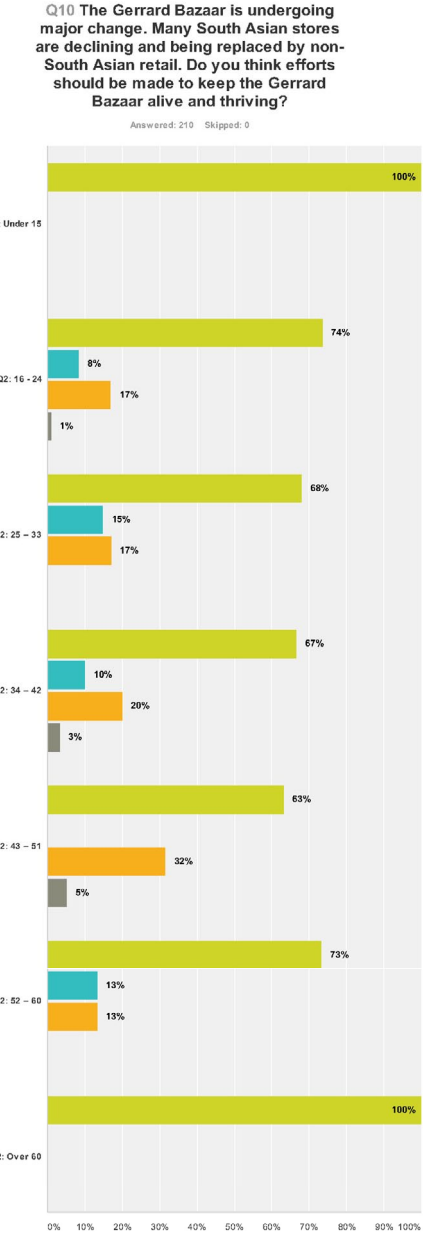
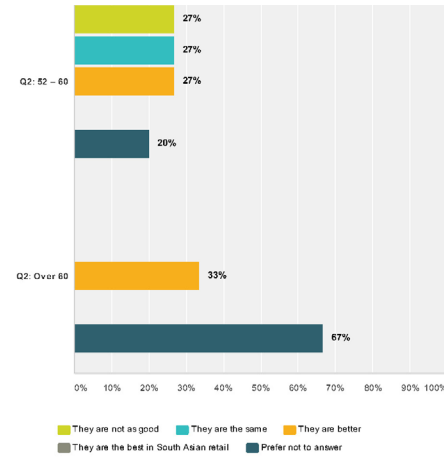


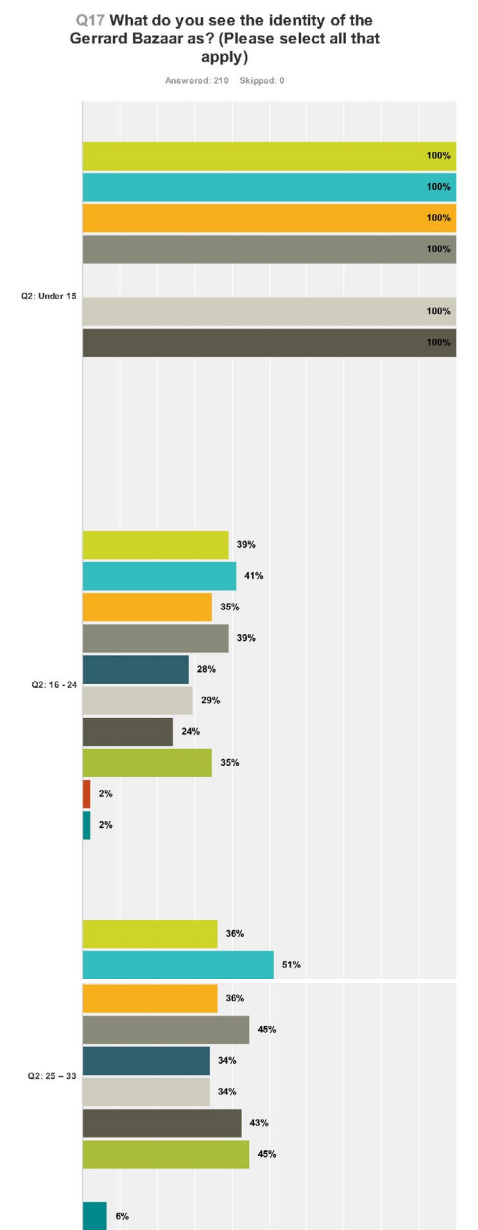
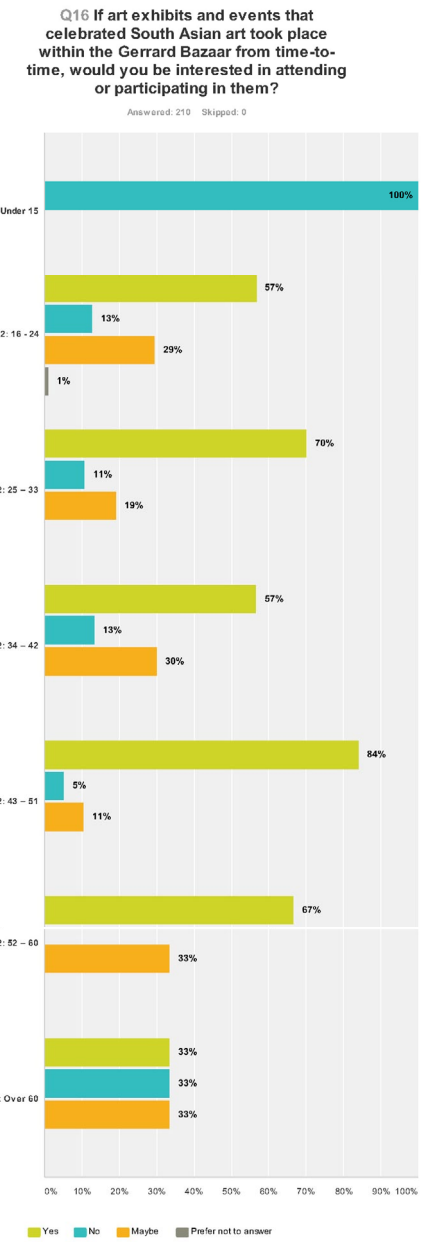
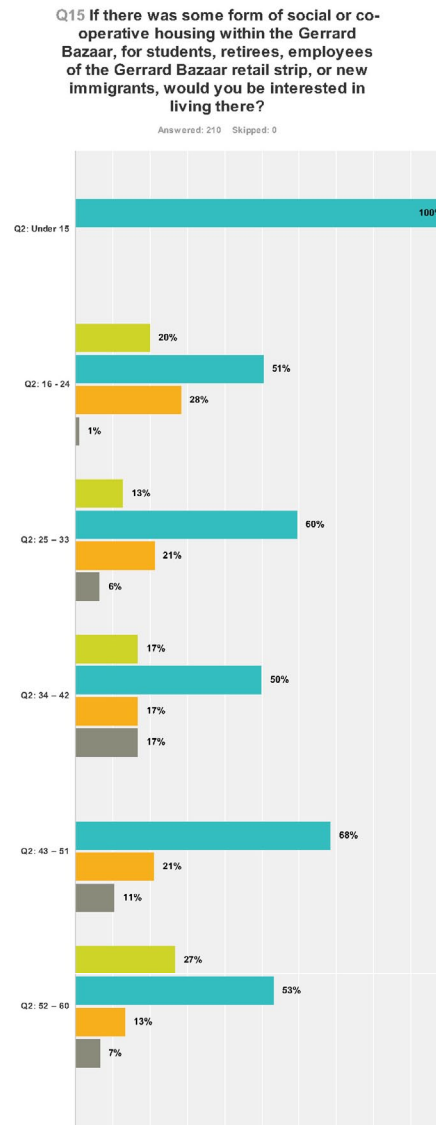
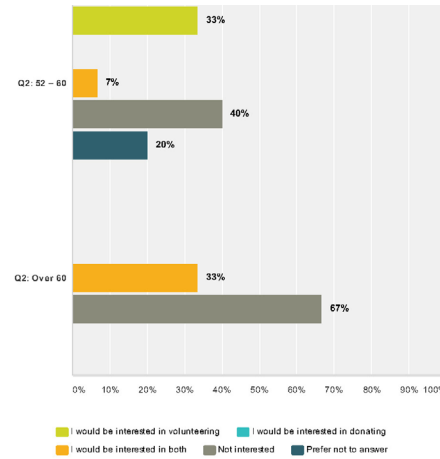
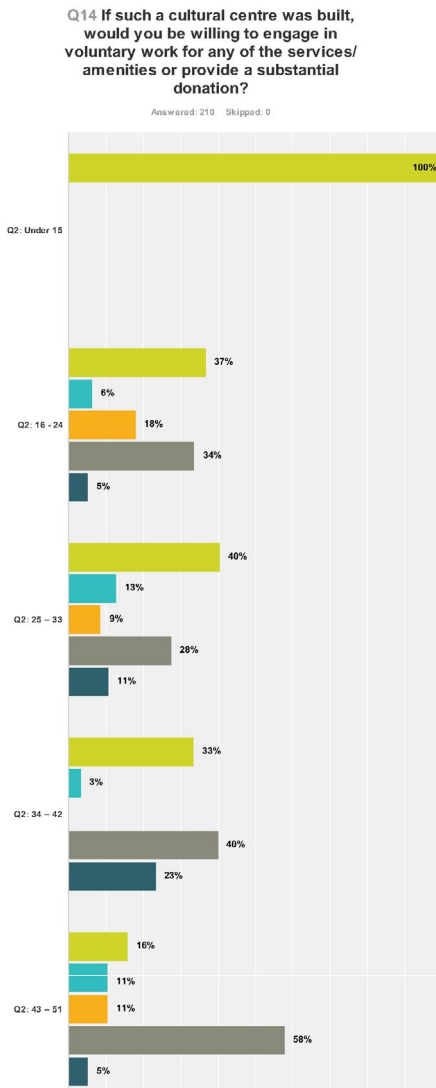
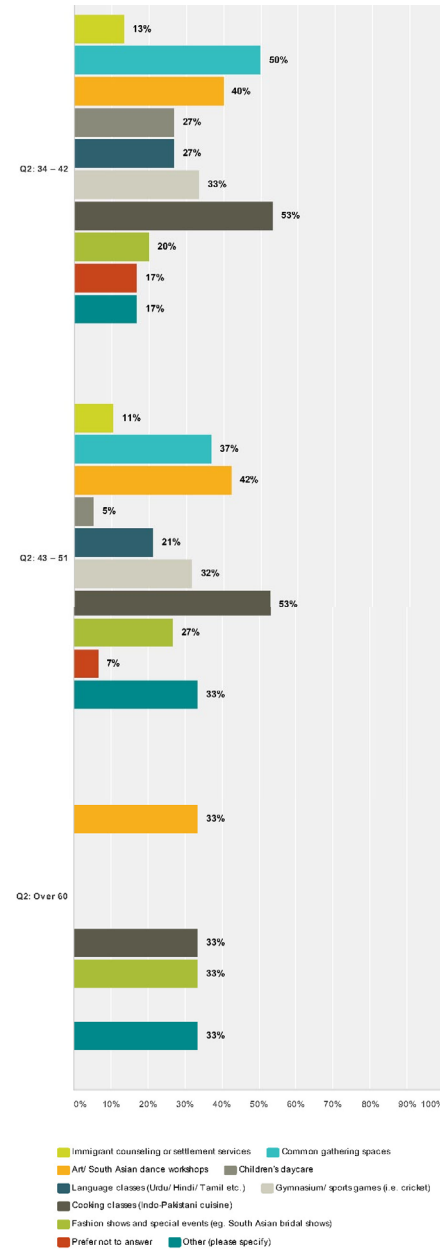
Q2 What age group do you belong to?

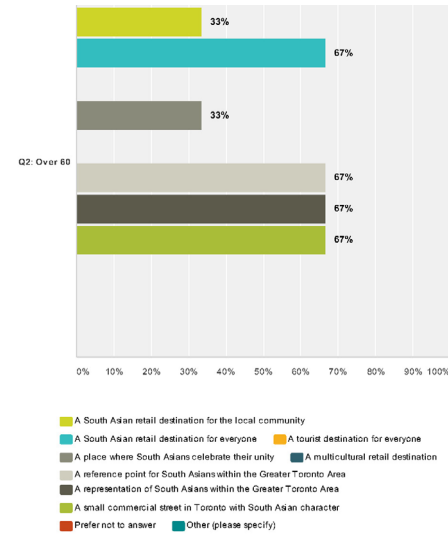
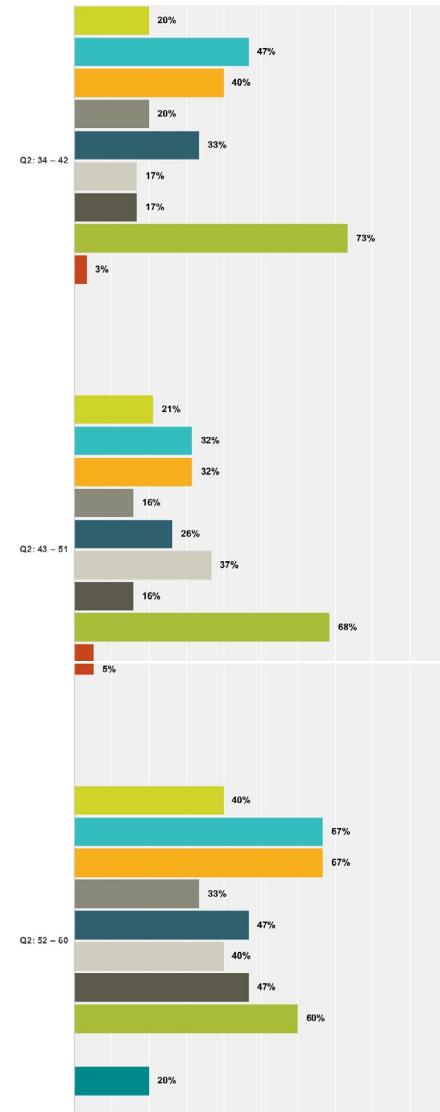






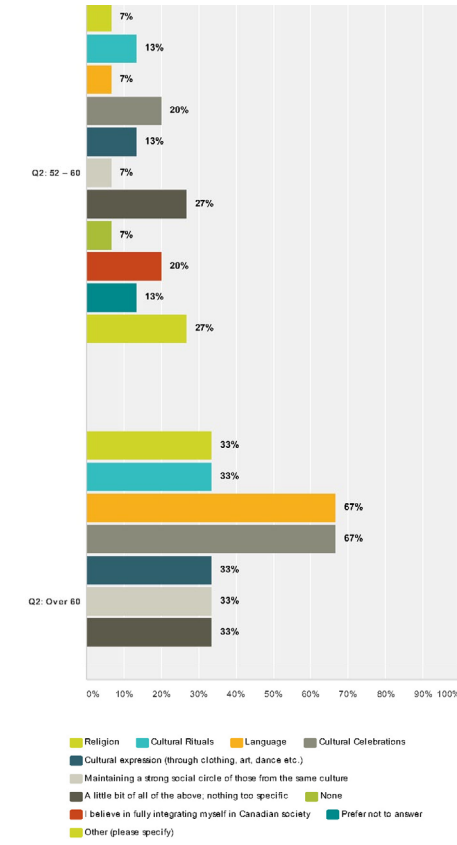
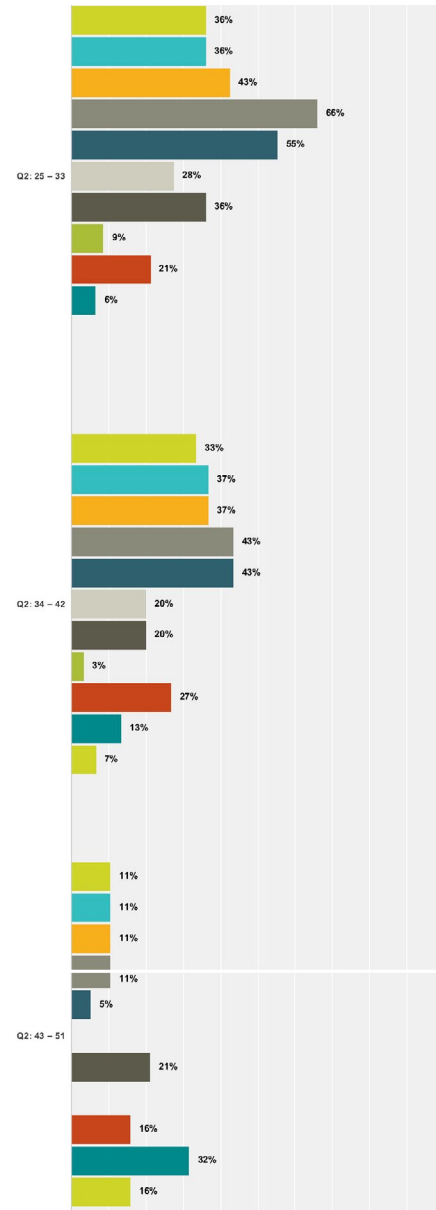
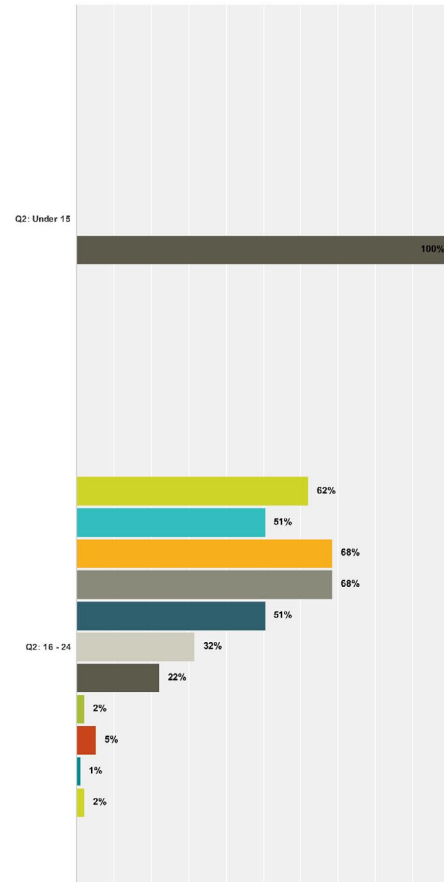




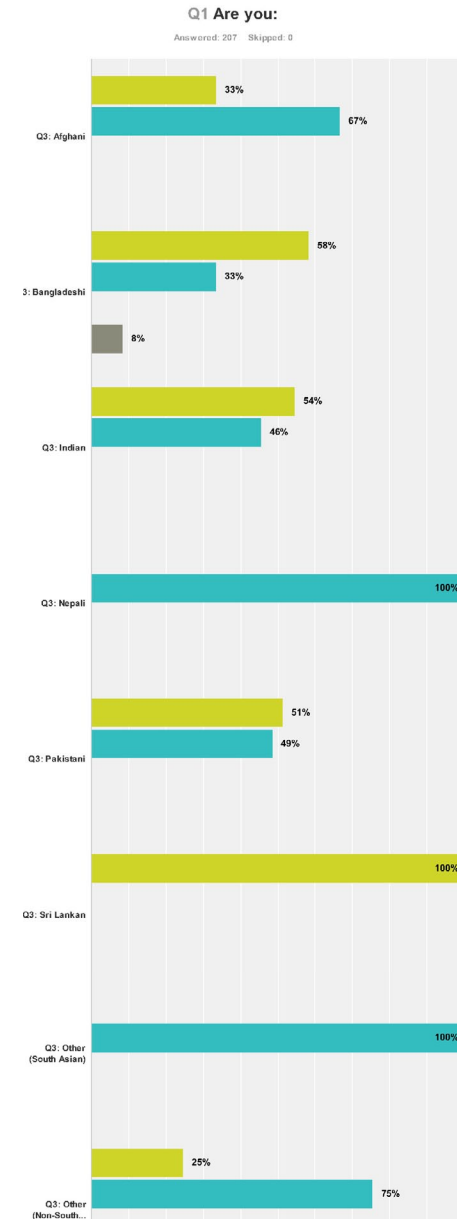


Q18 What aspects of your culture are most important for you to keep/ practice? (Please select all that apply)

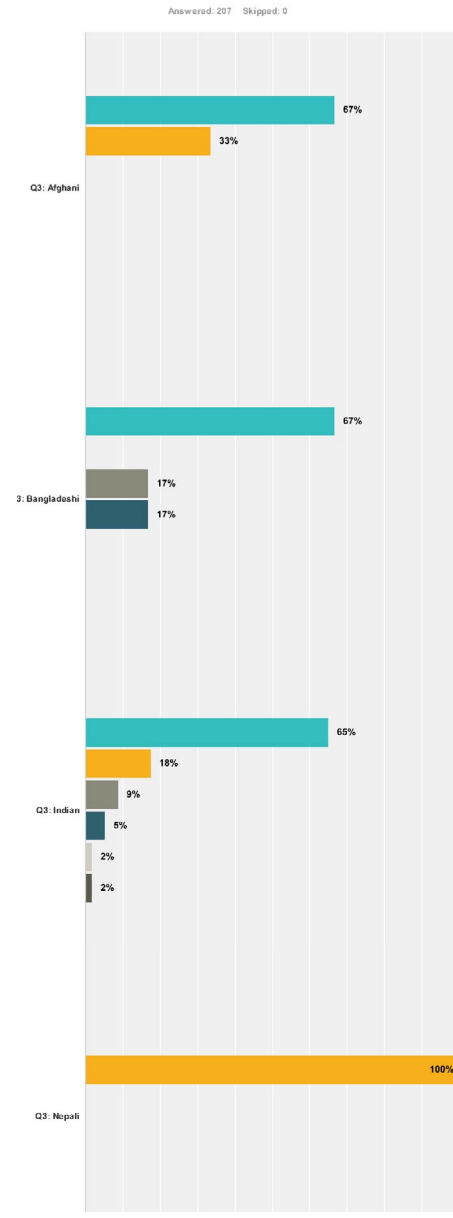
Answered: 210 Skipped: 0



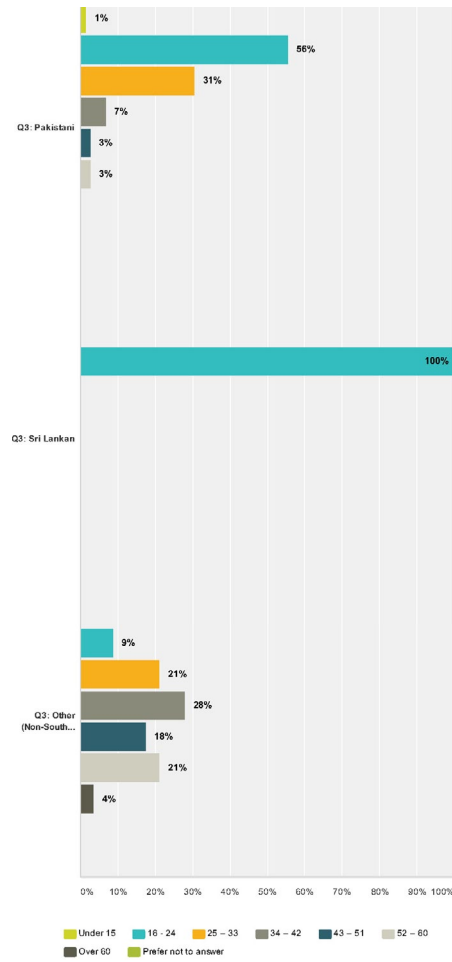
Survey Results - Filtered by Ethnicity



Q2 What age group do you belong to?



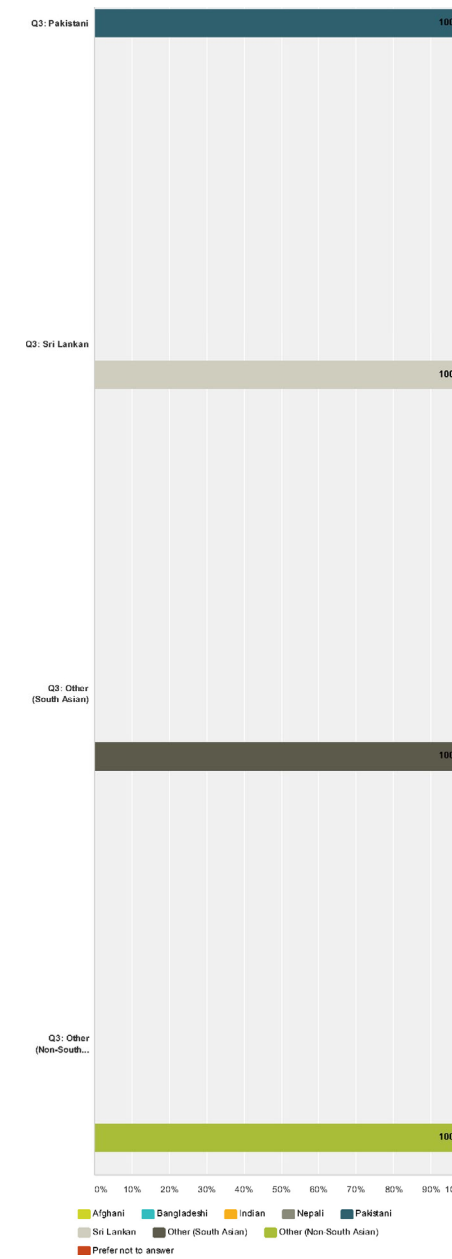
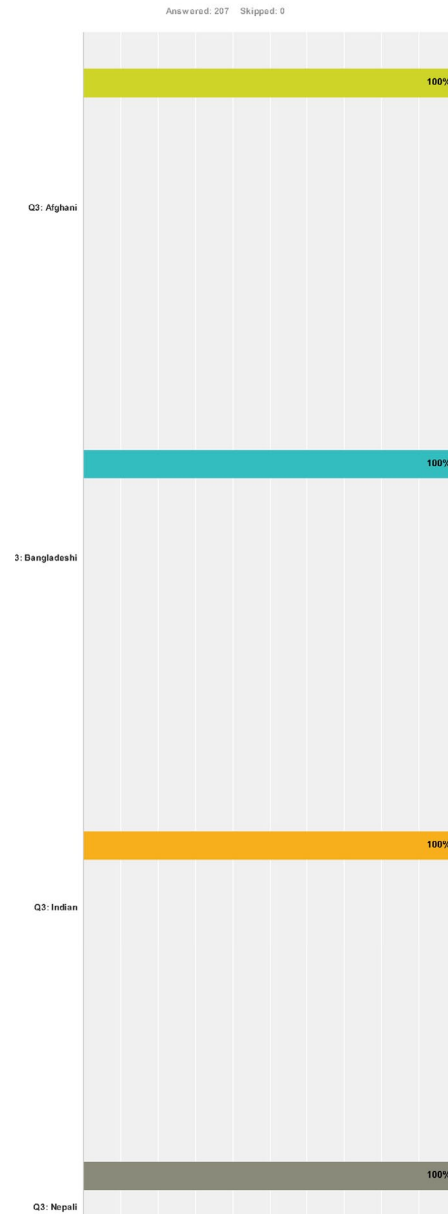
362



0% 10% 20% 30% 40% 50% 60% 70% 80% 90% 100%

Under 15 16 - 24 25 - 33 34 - 42 43 - 51 52 - 60 Over 60 Prefer not to answer

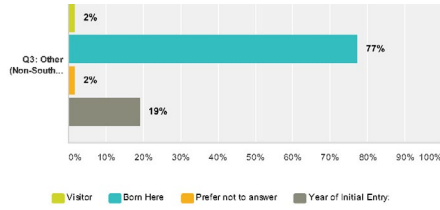
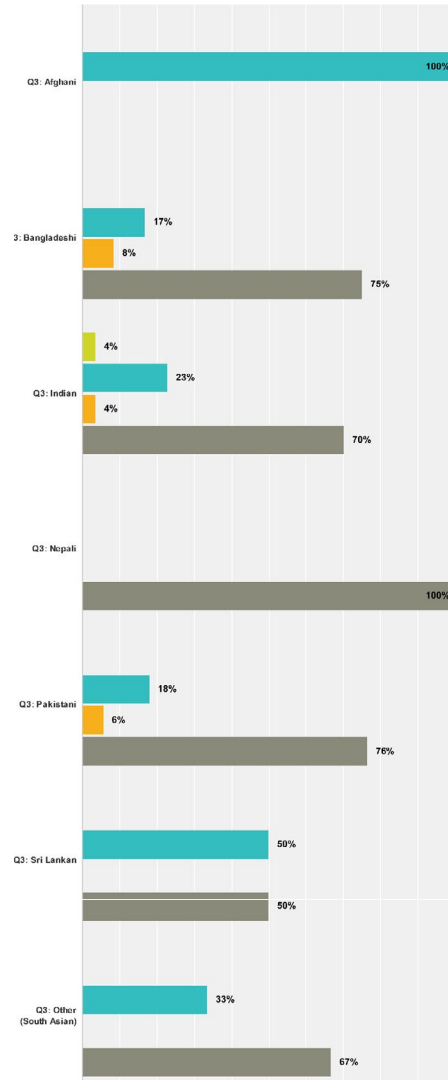
Q3 What is your ethnic origin?



363

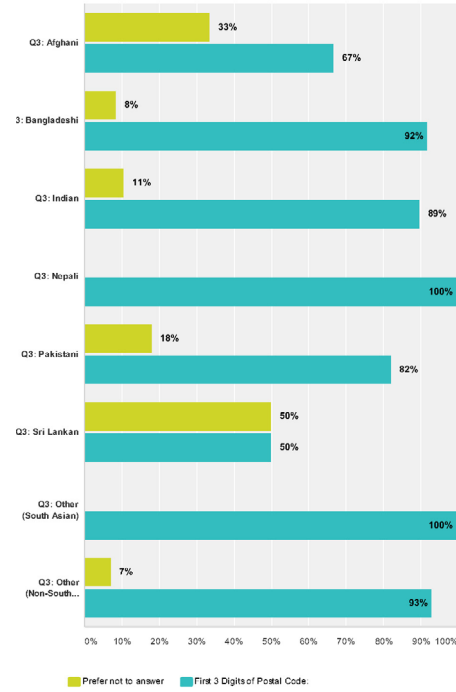
Q4 What was the year of your initial entry into Canada?

Answered: 207 Skipped: 0



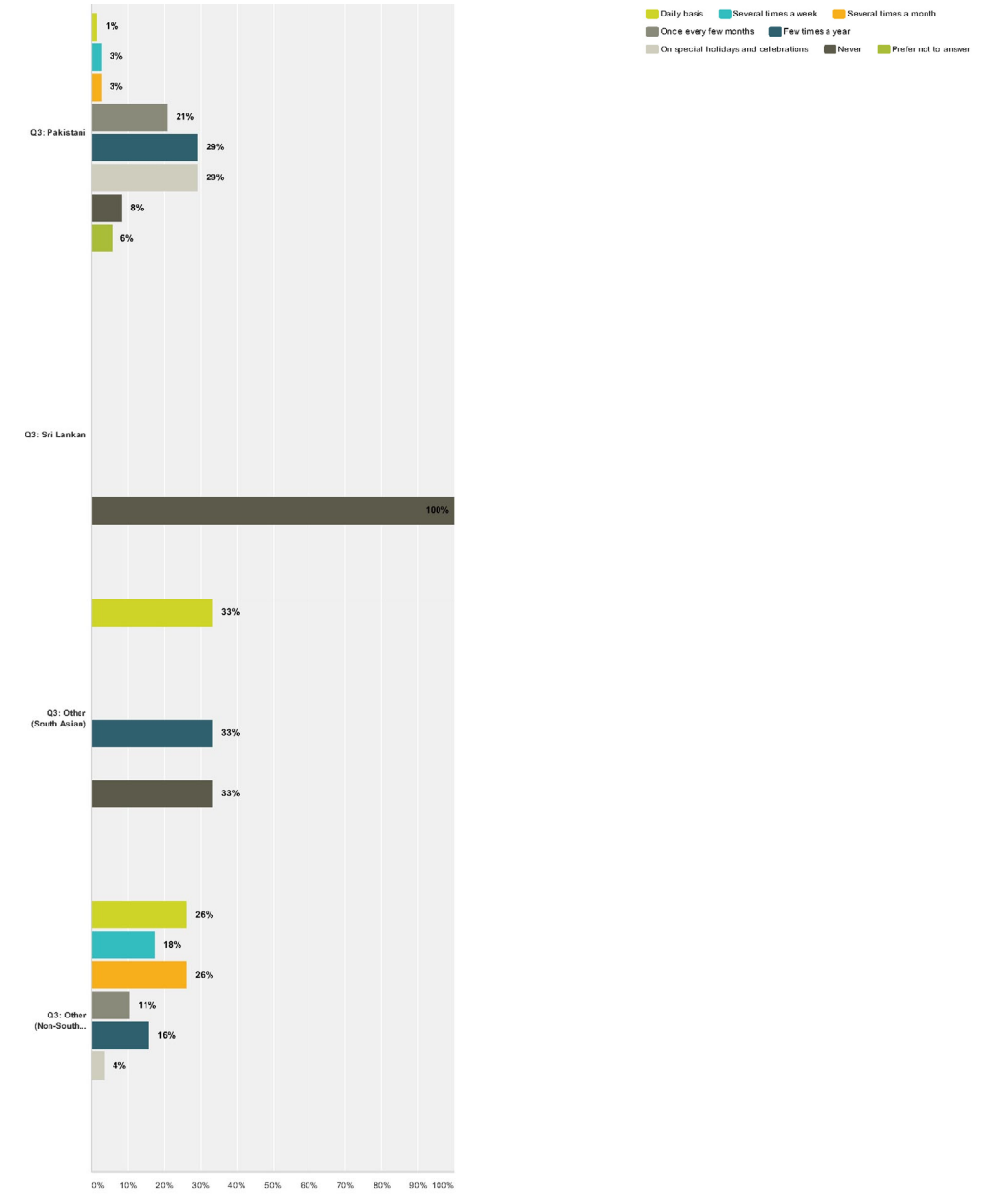
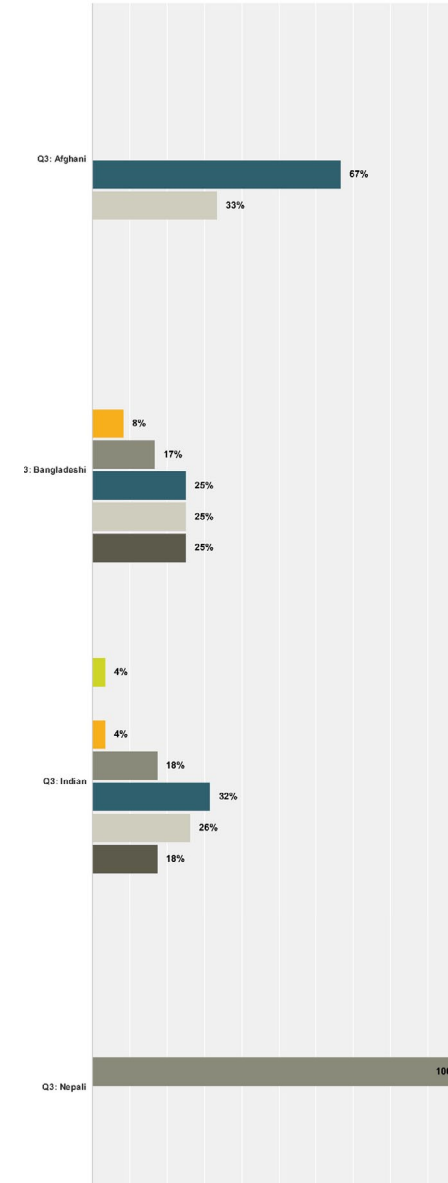
Q5 What are the first 3 digits of the postal code of your permanent home address? (This will strictly be used for a mapping study which will compare the answers of participants, based on their area of residence. It will be used to examine whether there is a correlation between how far a person lives from the Gerrard Bazaar and whether that affects their perception of it.)

Answered: 207 Skipped: 0



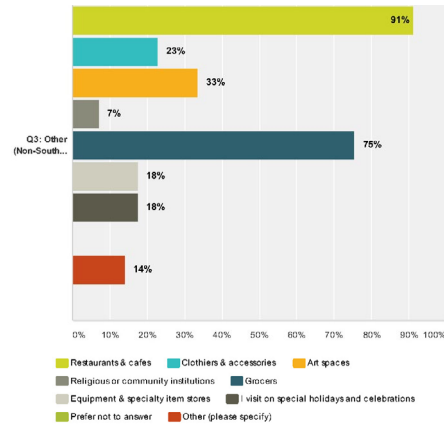
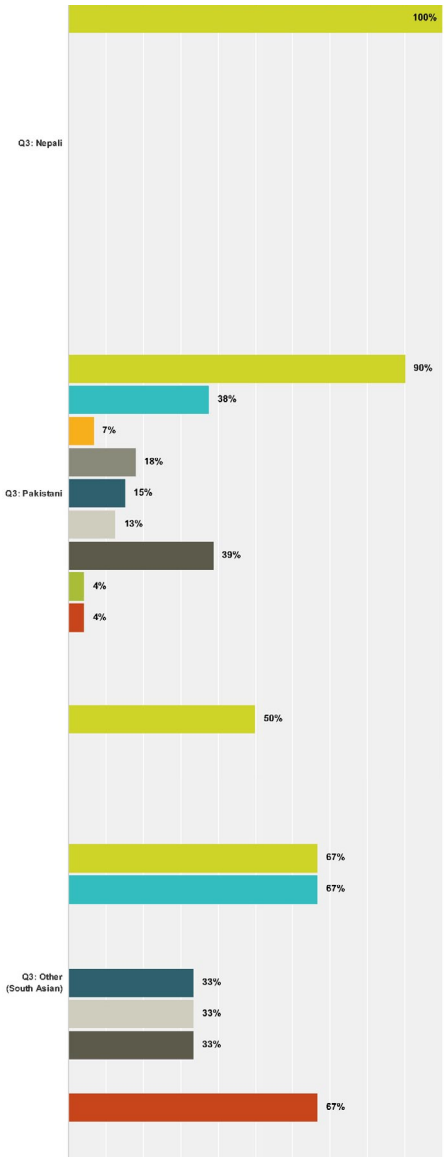
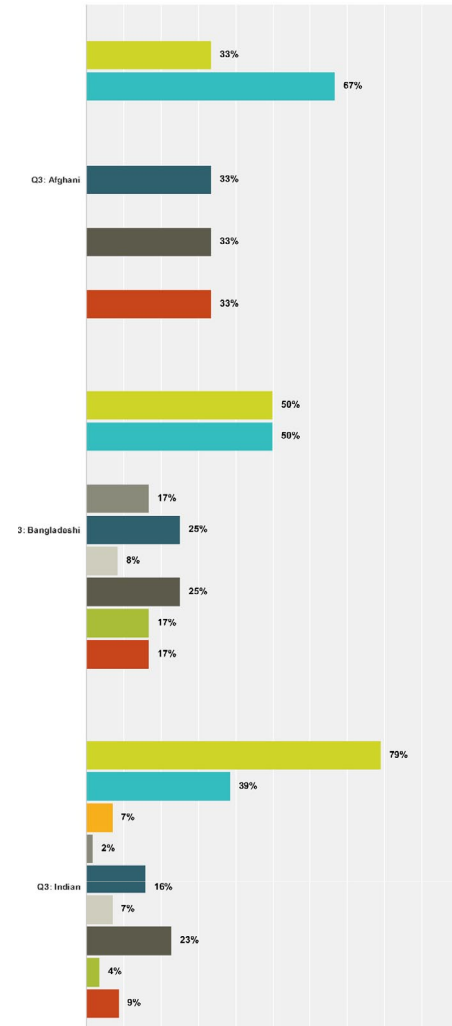
Q6 How often do you visit Gerrard Bazaar?

Answered: 207 Skipped: 0



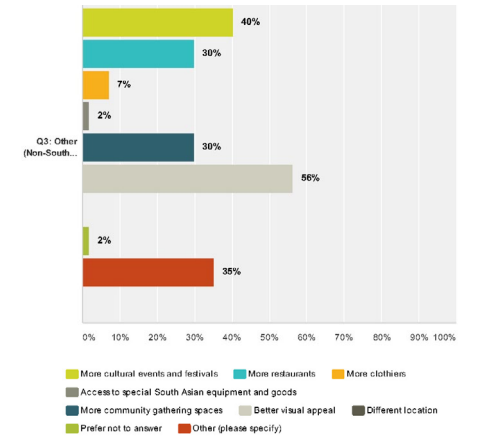
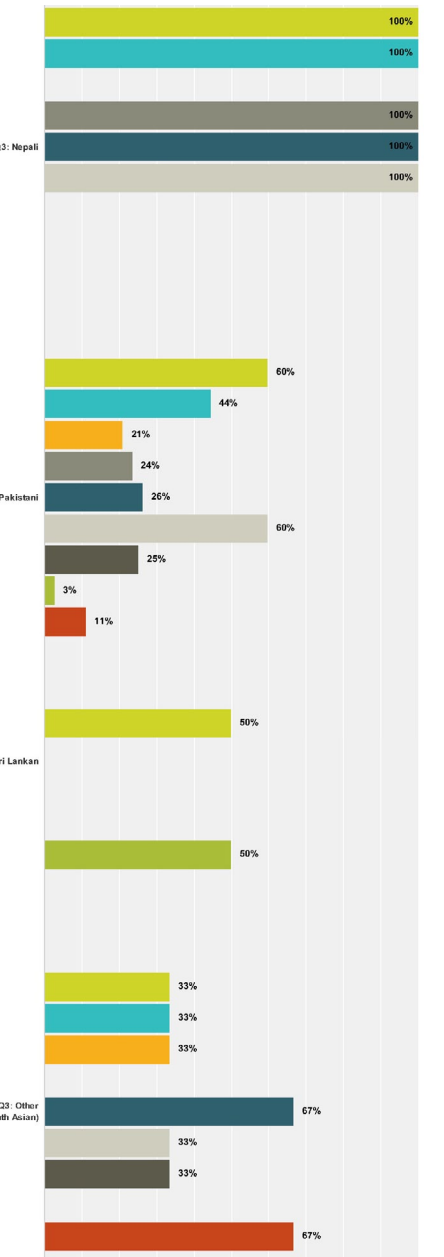
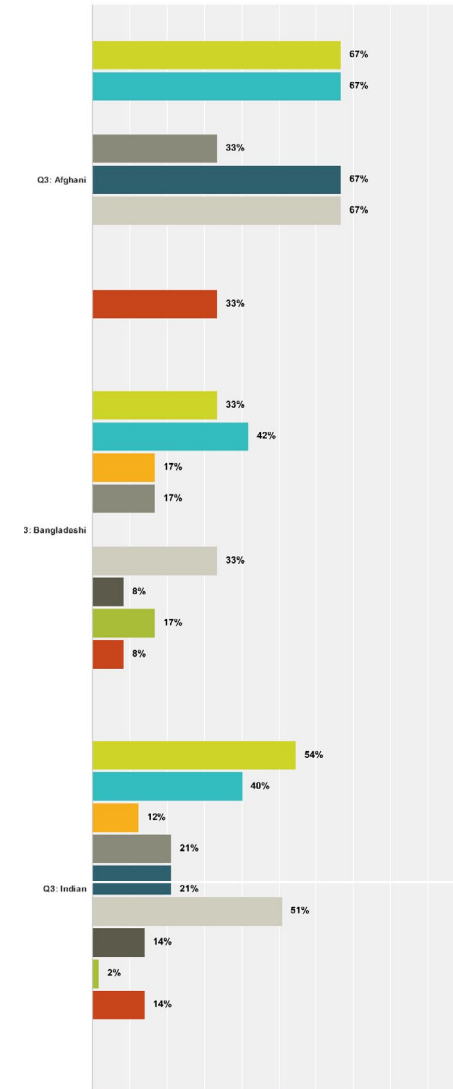
Q7 What types of commercial enterprises do you visit within the Gerrard Bazaar? (Please select all that apply)

Answered: 207 Skipped: 0



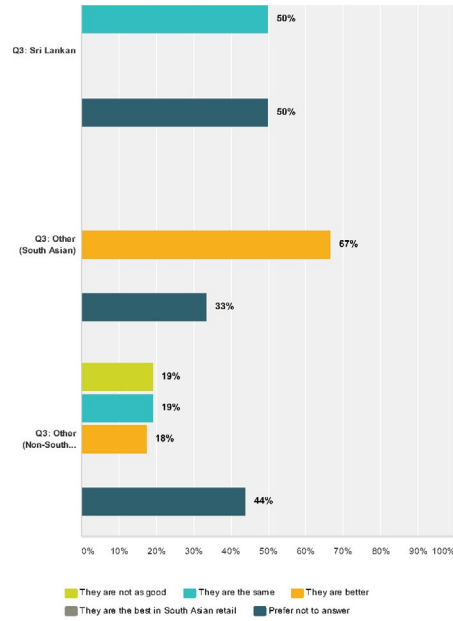
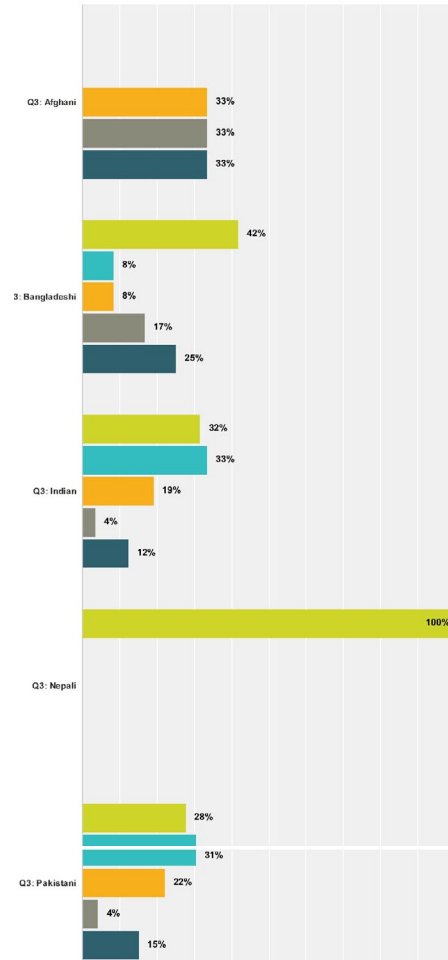
Q8 What factors would make you visit the Gerrard Bazaar more than you currently do? (Please select all that apply)

Answered: 207 Skipped: 0



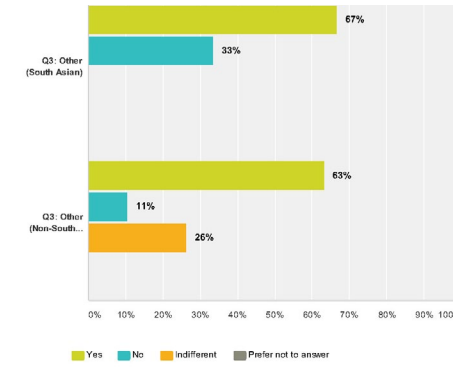
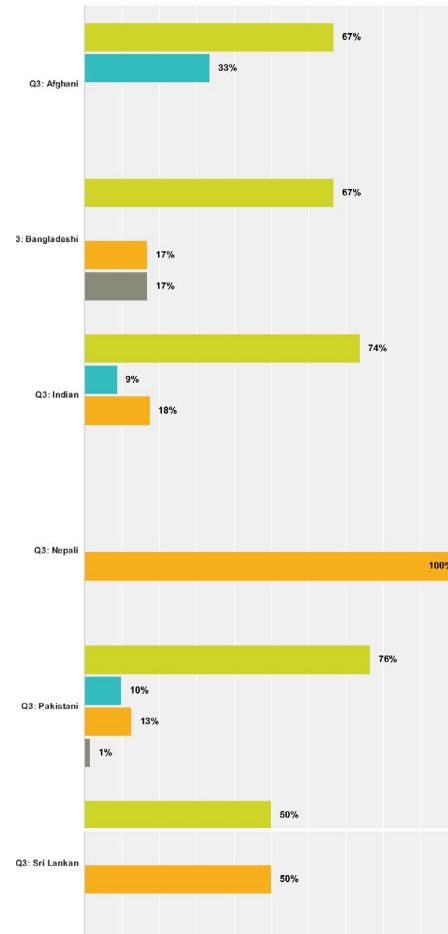
Q9 How do the places that you visit within the Gerrard Bazaar compare to other South Asian amenities that you have utilized in other parts of the Greater Toronto - Hamilton Area?

Answered: 207 Skipped: 0



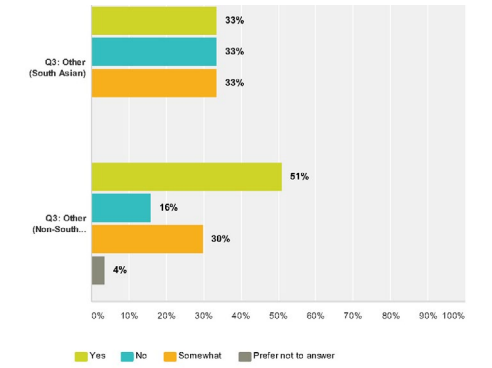
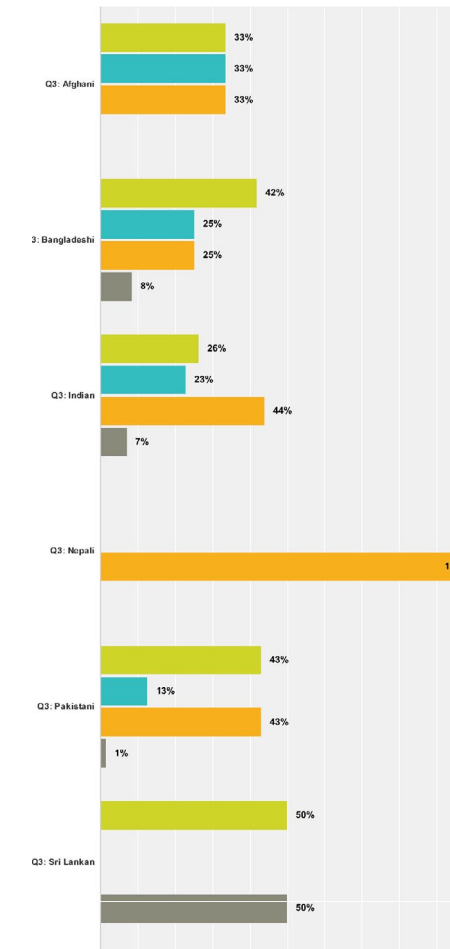
Q10 The Gerrard Bazaar is undergoing major change. Many South Asian stores are declining and being replaced by non-South Asian retail. Do you think efforts should be made to keep the Gerrard Bazaar alive and thriving?

Answered: 207 Skipped: 0



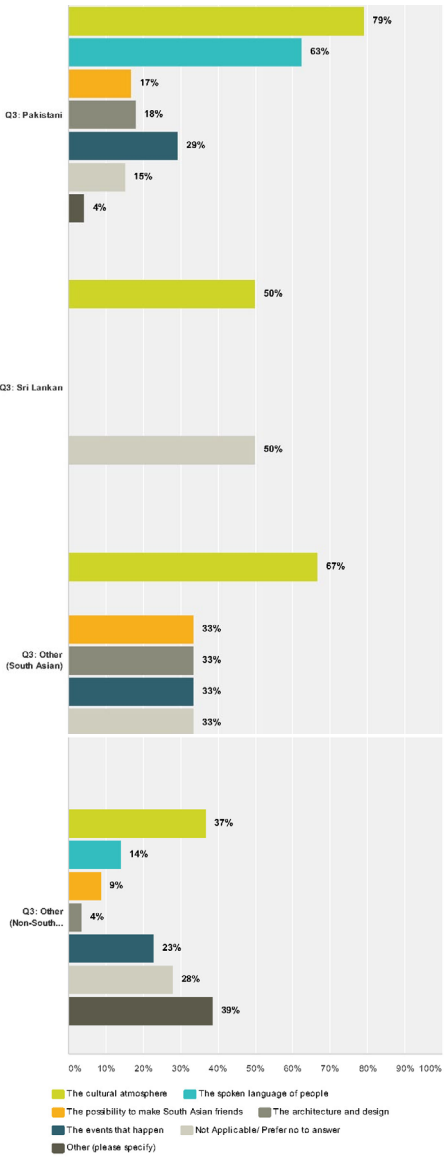
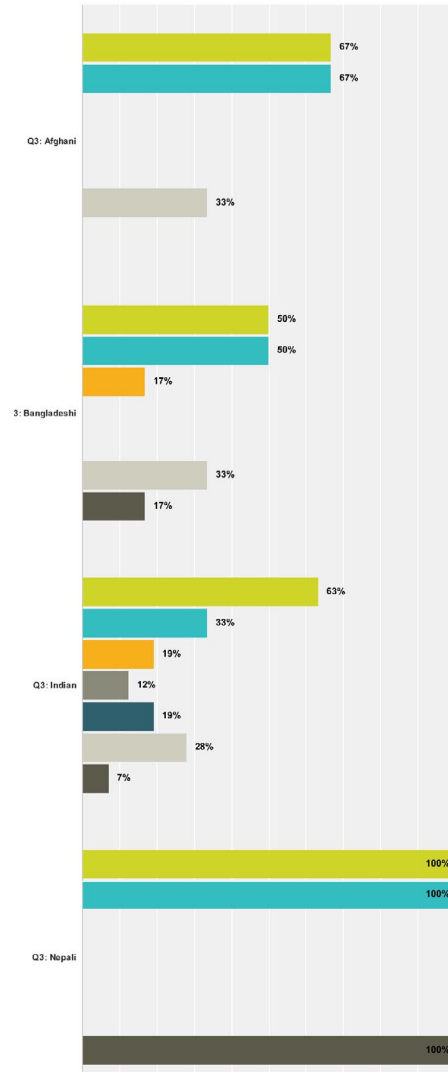
Q11 Do you feel "at home" when you visit Gerrard Bazaar?

Answered: 207 Skipped: 0



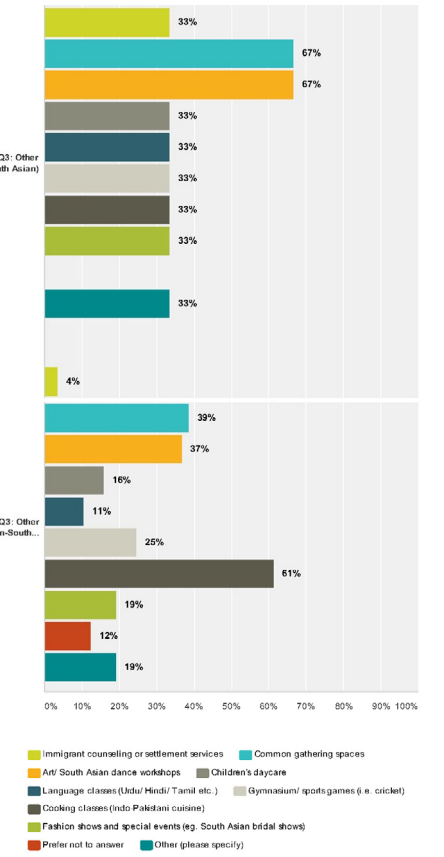
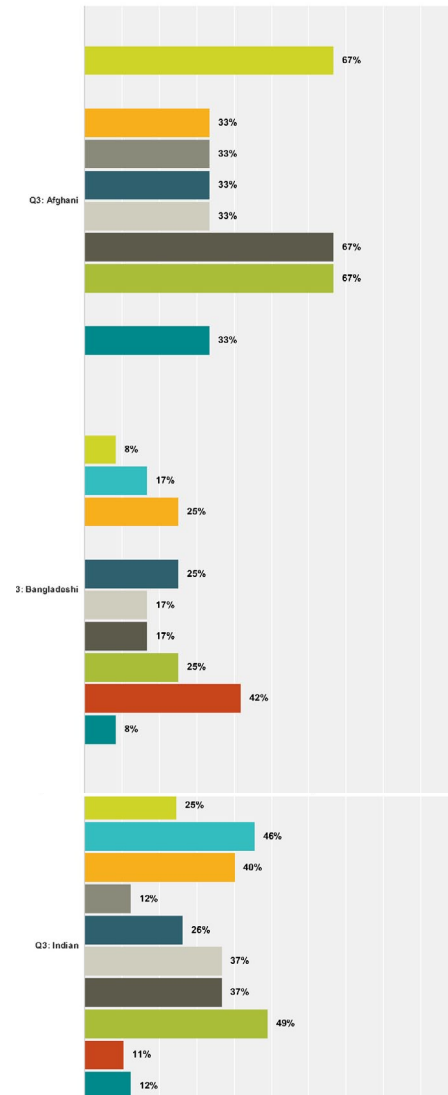
Q12 If answered "Yes" or "Somewhat" to the previous question, what makes you feel this way? (please select all that apply)

Answered: 207 Skipped: 0



Q13 The thought is that a South Asian cultural centre may be an option for the Gerrard Bazaar. If such a building was built, what facilities/ amenities would encourage you to visit on a regular basis? (Please select all that apply)

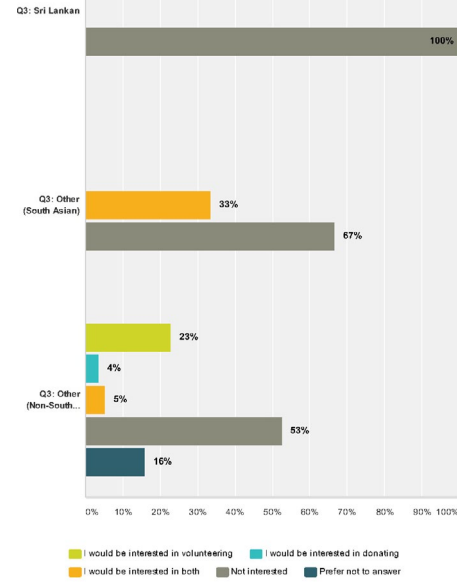
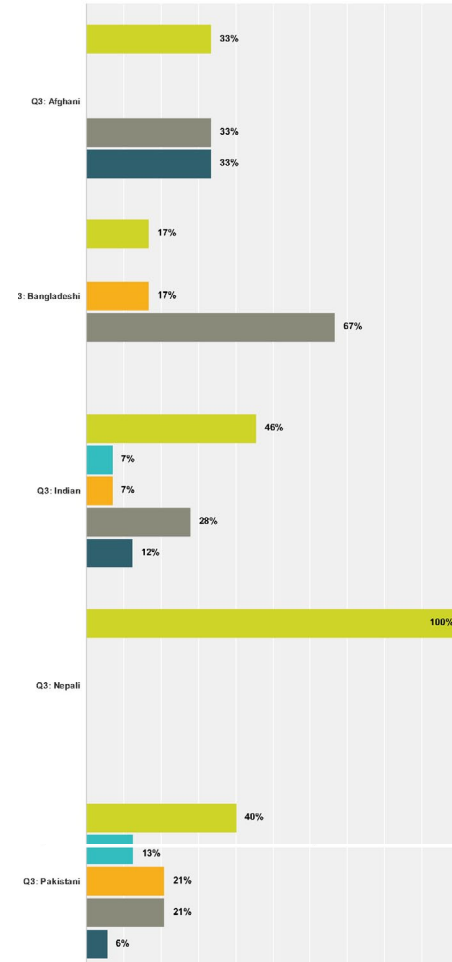
Answered: 207 Skipped: 0



■ Immigrant counselling or settlement services ■ Common gathering spaces
■ Av/ South Asian dance workshops ■ Children's daycare
■ Language classes (Urdu/ Hindi/ Tamil etc.) ■ Gymnasium/ sports games (e.g. cricket)
■ Cooking classes (Indo Pakistani cuisine)
■ Fashion shows and special events (eg. South Asian bridal shows)
■ Prefer not to answer ■ Other (please specify)

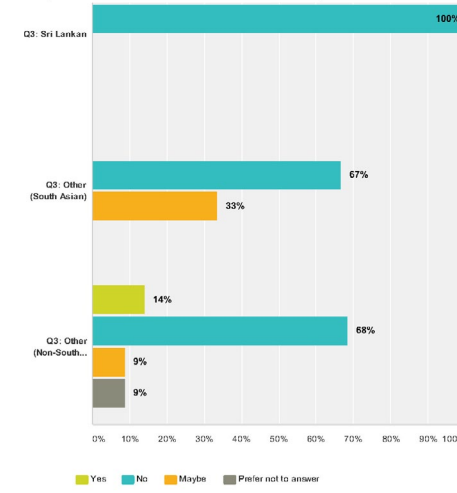
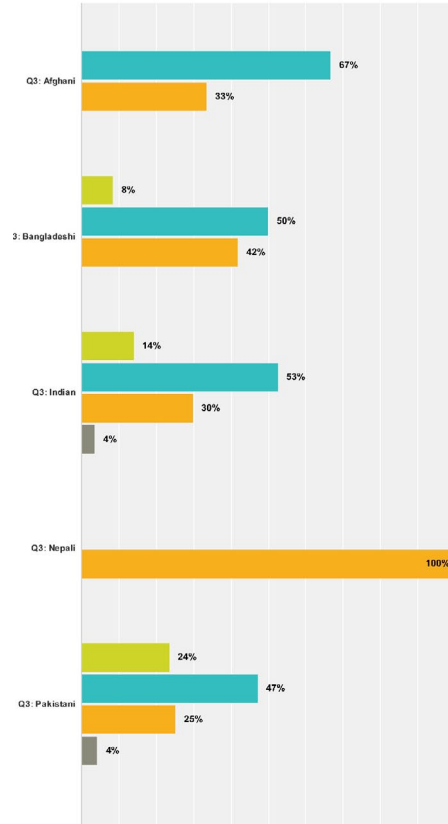
Q14 If such a cultural centre was built, would you be willing to engage in voluntary work for any of the services/ amenities or provide a substantial donation?

Answered: 207 Skipped: 0



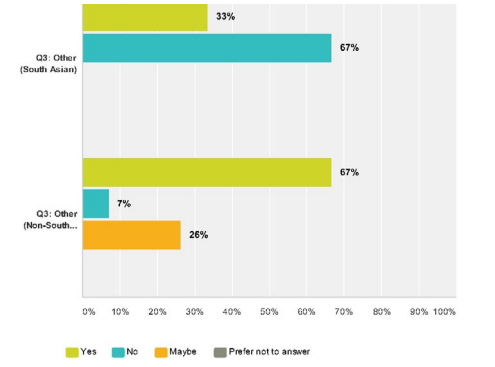
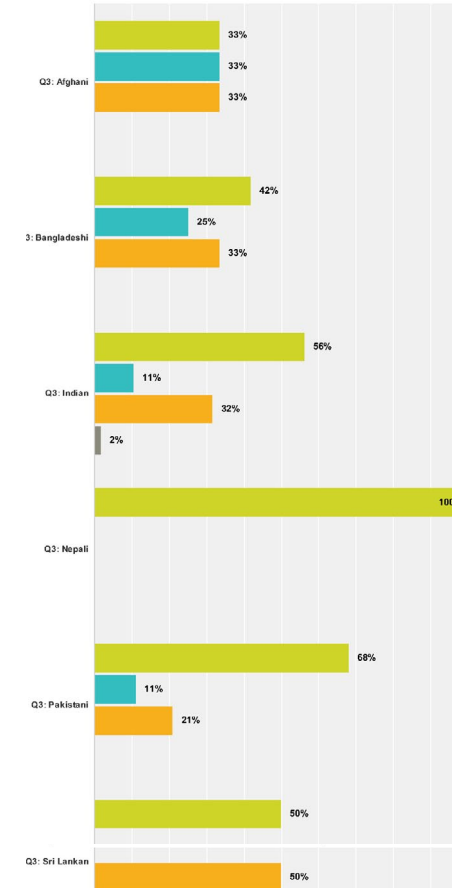
Q15 If there was some form of social or co-operative housing within the Gerrard Bazaar, for students, retirees, employees of the Gerrard Bazaar retail strip, or new immigrants, would you be interested in living there?

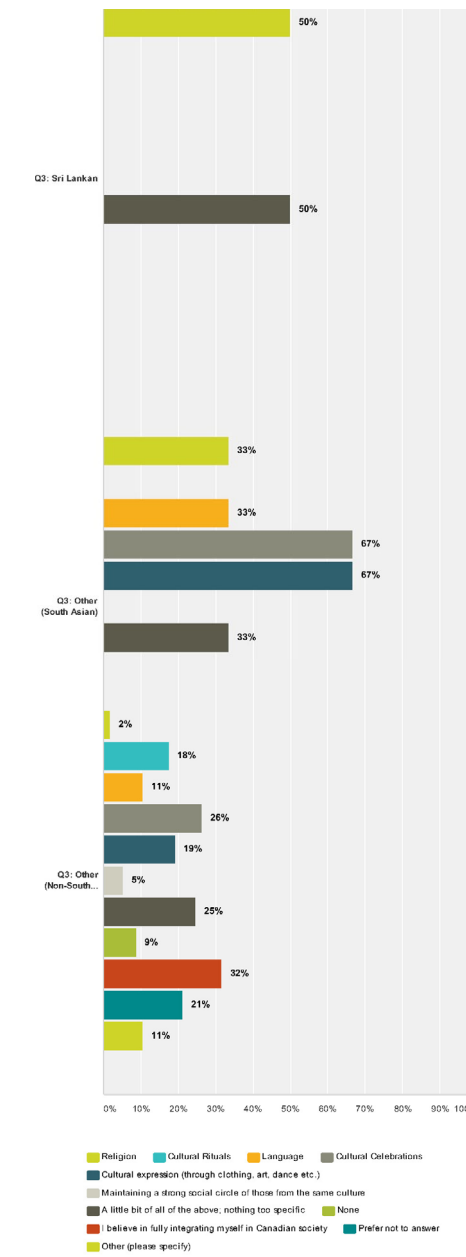
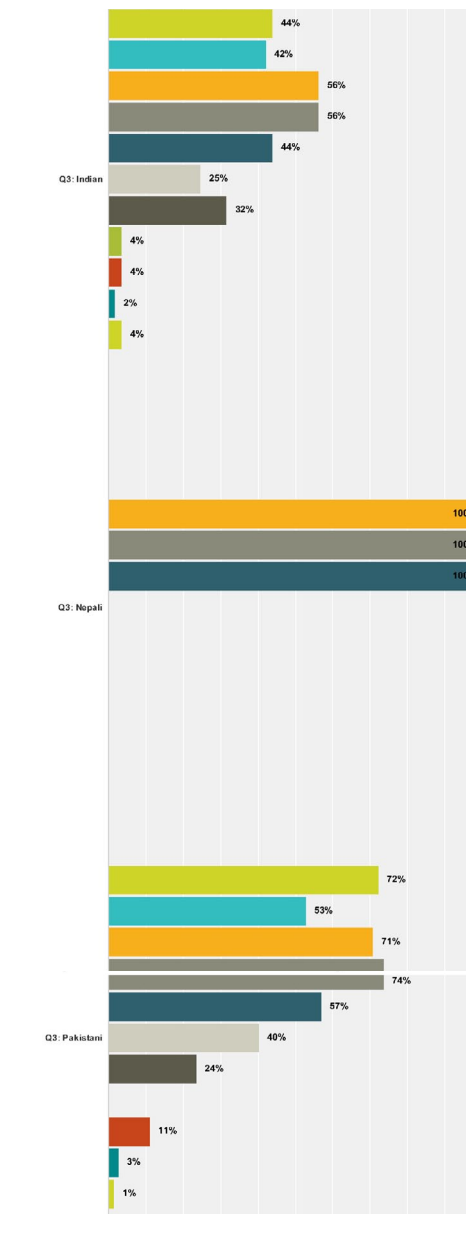
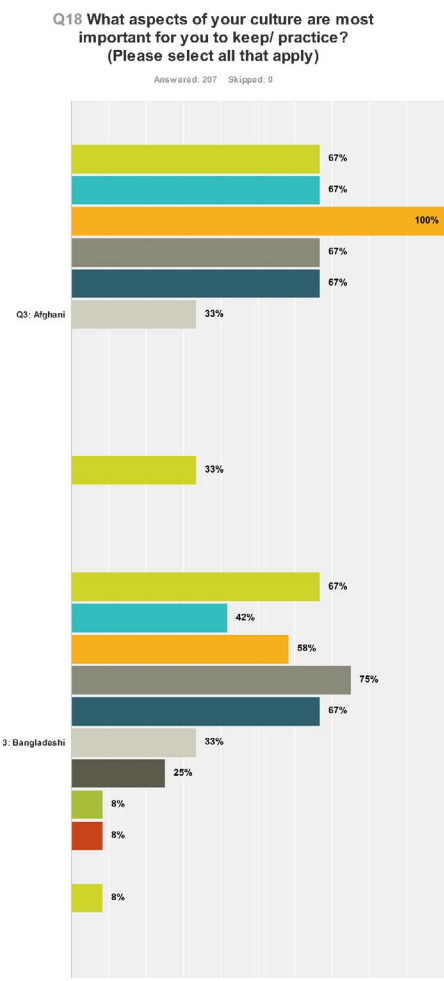
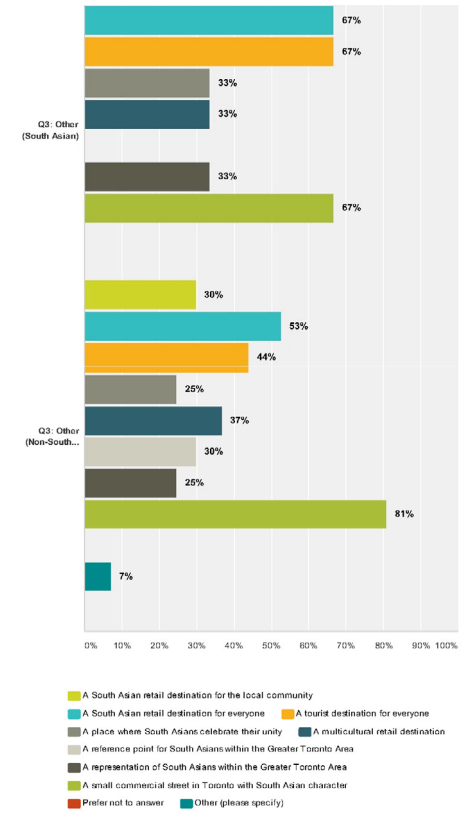
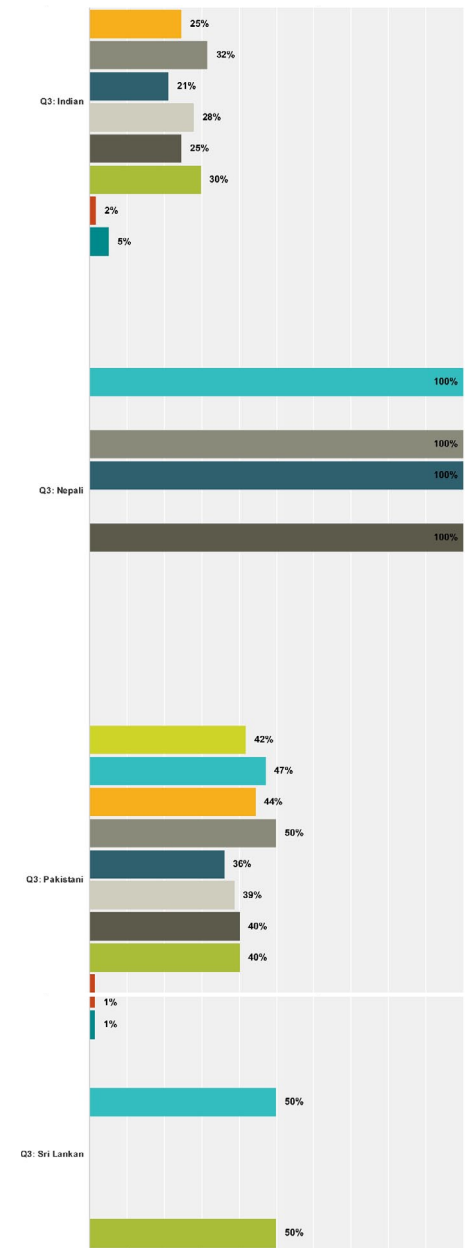
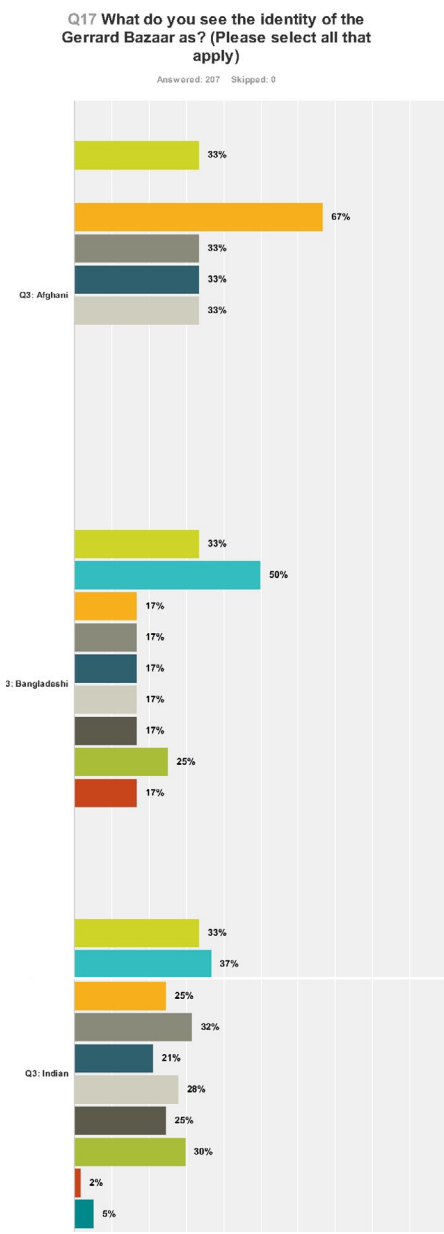
Answered: 207 Skipped: 0



Q16 If art exhibits and events that celebrated South Asian art took place within the Gerrard Bazaar from time-to-time, would you be interested in attending or participating in them?

Answered: 207 Skipped: 0





Interview Questions and Answers

The interview questions for storeowners were as follows:

- 1) What are the first 3 digits of your postal code?
- 2) How long have you been living in Canada?
- 3) What was your occupation in your home country before coming here?
- 4) Why did you decide to open up your own business within the Gerrard Bazaar?
- 5) When did you open this retail enterprise?
- 6) Would you happen to know what type of program was housed in this space before you began your enterprise here?
- 7) Can you please describe your clientele in terms of their ethnic background and geographic location (if known)?
- 8) What are the peak times for your business?
- 9) What is the predominant ethnicity of your employees and where do they commute from?
- 10) How has your business changed ever since you opened it?
- 11) What will happen to your business once you retire?
- 12) If you do not continue to run your business within the Gerrard Bazaar, or if you did not have a business here, would you (still) consider living in this neighbourhood?
- 13) Do you think some form of social or co-operative housing within the Gerrard Bazaar has potential within the Gerrard Bazaar?

- 14) Do you think a South Asian cultural centre which houses cultural amenities and programs has potential within the Gerrard Bazaar?
- 15) Do you think that artistic exhibits and events that celebrate South Asian art and culture have potential within the Gerrard Bazaar?

**Interviews have been condensed to reflect anonymity*

Interview Type #2

The interview questions for key organizations were as follows:

- 1) What is the primary purpose of this organization?
- 2) When was this organization established in its current location?
- 3) Why did you choose to be located here?
- 4) What type of organizational structure do you operate with?
- 5) How many members are a part of your organization, and from what parts of the city are they from?
- 6) What kinds of activities and events do you organize, and how often?
- 7) Are you looking to expand your venue or operations? If so, what would be your requirements for such expansions?
- 8) Where do you receive your funding from and how does it fit into your operational framework?
- 9) Do you collaborate with other organizations?
- 10) What kinds of programs do you think you could offer that can strengthen an individual or community's cultural identity?
- 11) Do you think some form of social or co-operative housing within the Gerrard Bazaar has potential within the Gerrard Bazaar?
- 12) Do you think that artistic exhibits and events that celebrate South Asian art and culture have potential

- within the Gerrard Bazaar?
- 13) Do you think a South Asian Community Centre within the Gerrard Bazaar has potential in bringing together various South Asians and other ethnic groups from neighbouring regions?
- 14) If something like this was built, would you consider re-locating your community centre within it?
- 15) What does the future hold for this organization?

**Interviews have been condensed to reflect anonymity*

**Anonymous Interview - South Asian Salon
Interview Type #1**

- 1) "M4L"
- 2) "14 years"
- 3) "Nothing"
- 4) "My in-laws [were] living here before and they came here. And they already have [a] business here. I wanted to join them. We feel comfortable here, that's because it's an Indian area and we are Indians too. And we feel comfortable here [be]cause all people here, they like they are Indians mostly. And we feel comfortable."
- 5) "2006"
- 6) "I have no idea"
- 7) "Like I have 40% Canadian people here. And I have lots of clients, they come when they start the business that time to now. And some clients have come from Scarborough. When they come to Gerrard Street, they come to me to see me here."
- 8) "Peak time is from July, August"
- 9) "Sometimes it's from Pakistan, sometimes it's from Nepal, Indians too... they live local"
- 10) "Yeah, it's the same thing...my clientele are happy with my services"
- 11) "I have no idea"
- 12) "Yes. I like [it] here because it's all communities are here. I like to talk with all kinds of people."
- 13) "No"

14) "Yes"

15) "I have no idea"

**Anonymous Interview - South Asian Specialty Store
Interview Type #1**

- 1) "M4L"
- 2) "About 26 years"
- 3) N/A
- 4) "My dad started it like he was in Scarborough first making jewelry and then he saved up enough money to basically have inventory and start selling"
- 5) "1990"
- 6) "I don't know"
- 7) "Basically...south Asians, if you want particular like there's we get Pakistanis, people from Bangladesh, Afghani, Indian, obviously. So mostly you could say in the south Asia part of India, all that. Most, like the GTA you can say. We get people from even like Ottawa, Montreal. We get customers from Hamilton, yeah, Mississauga, Brampton, Toronto of course, GTA"
- 8) "Saturdays, Sundays, you know, we open from 12-9 and I guess you can say between 2 to 7 pm"
- 9) "Okay, well, one is, has been with us for more than 10 years, she's from Bangladesh but she speaks the language and she speaks our language too. She's sort of not too far, like Victoria Park and Danforth, so that's basically 15 minutes drive, five, six minutes"
- 10) "Well, clients have changed of course. We get a lot of...Indians have went to Brampton, right, or Mississauga. And then merchandise has changed, designs, stuff like that has changed. As profitability has declined because if you notice in our industry there is less business 'cause

obviously most people have gone to Brampton, Mississauga, since they have opened stores there. So, you know, the Brampton customers now won't come here obviously cause there's so many jewelry stores there"

- 11) N/A
- 12) "Maybe. Like, I mean, my brothers have went, moved to Brampton, I'm still in Toronto. But I'm going to open another business and possibility of doing both. I'll still be here in Toronto"
- 13) "I mean, I think the value of the houses nearby have went up. So maybe nearby but not on Gerrard Street it wouldn't really help the market"
- 14) "Yeah, yeah, that would help. Just to bring more traffic in I guess"
- 15) "Like I think thousands of people coming those two days, Saturday, Sunday. So it does help. But cultural wise, I mean...for art and stuff, I don't see that helping"

**Anonymous Interview - South Asian Clothier
Interview Type #1**

- 1) "M40"
- 2) "I was born and raised here so that puts me at 28 years"
- 3) "Well...this was the family business which is clothing so his dad before him also owned a clothing store so it's been a sort of a lineage trade the last three generations"
- 4) "Well, my parents decided to open up the business in 1984, and they decided to open up a business because they wanted something they could make of their own. Specifically in the Gerrard Bazaar because back in the 80s, this was the only area. There was no other Bazaar. There was no Scarborough, there was no Brampton, there wasn't Mississauga"
- 5) "So this location here we've had since 1986. And we've owned it since 1986 and we used to rent in '84 two door down"
- 6) "Before we came here, it was also a clothing store and then before that clothing store came here, it was a grocery store"
- 7) "Yeah, so most of our clients are diverse on the ethnic scale... We have every customers from Bangali to Caucasian to Gujrati to Tamil to Punjabi to Hindu...we really cater to anybody getting married who wants something unique and different. And geographic location, a lot of our customers do come from the West End so Mississauga, Brampton who are willing to track down, still a lot from Scarborough. And then also a lot from downtown who find that Gerrard Street is still the closest area to come shop..."
- 8) "So Monday through Friday we peak after 4:00 which is

after working hours. Before 4:00, we'll have usually a lot of the stay at home moms coming when the kids are at school. And so after 4:00, you'll get a lot more traffic...And then Saturdays and Sundays are always busy. It's busy from about 12:00 to about 8:00 at night so 12:00 to 8:00 we have a consistent flow of traffic from Saturday to Sunday so it's always busy"

- 9) "Most of our employees are South Asian, Bangali, Punjabi, and they all commute from relatively nearby areas. So usually about East York I guess you could say"
- 10) "Our business has grown. It started off as just one floor back in '84. From there, we excavated the basement and made it two floors. And then after that, we converted the top residential area to a third floor. And then in 2001, we converted our fourth -- we built a fourth floor from scratch so we have four floors right now"
- 11) "I'm sort of the designated person to take over the business, however, I personally don't see myself being here every day. That's not the plans I have for myself. The business is great. It was my mom and dad's legacy and their dream to build something like this, but now it's on me to sort of take it to the next level so that's where I come in, my education background comes in, you know, in business to really allow for us to take it to the next level. So for me, what I have in mind is to expand locations, opening up new locations or renovating here"
- 12) "Yeah, definitely. My family and I have spent our whole life living downtown"
- 13) "Yeah, I think there is definitely room"
- 14) "I think a cultural center also has potential"
- 15) "For sure, definitely. It does have potential. That's one of the things I was talking about that we wanted to do here"

**Anonymous Interview - South Asian Restaurant
Interview Type #1**

- 1) "M4T"
- 2) "About 40-odd years"
- 3) "Culinary school"
- 4) "I got the opportunity to open up a small place because people, my friends have all that time, I used to cook at home for them for small parties...And so that was just playing my art at that time and they decided, they said why don't you open up a place... Because there was a theatre up here."
- 5) "1975"
- 6) "Well, there wasn't anything"
- 7) "Once I established then local people, Canadian people or people from States... now it is a mixed client from East Africa, from Tanzania, from Pakistan or people from local, Canadian, British and so on, so forth keep on coming. But I recently re-opened a restaurant, I was the first restaurant here from '74, '75 till 2000"
- 8) "Well, this has been my first year here where the winters are very severe...this winter was a longer winter. So I haven't experienced a very good crowd so far"
- 9) "Some of them are south Asian, some of them local Canadians that's all and they live nearer, a three, four miles radius"
- 10) "It is like, not many people are coming out on Gerrard Street and it is hurting businesses like me. And there is no way of promoting my business or reaching out to those people until I'm in the media or some kind of

newspaper or somebody writes a review about Gerrard Street or promote it"

- 11) "I was retired and I re-opened up because I wanted to keep myself occupied and busy"
- 12) "Of course. I'm used to this and I'm familiar with, demographically I'm in the whole city"
- 13) "That would be the wonderful idea..."
- 14) "Very much so... if there could be a banquet hall or something else that nature or, you know, where the whole community could come and get together and all, after their events they could come and shop around or eat around or whatever"
- 15) "It could. It could very much create that. It could bring more crowd up here. Yes, because for the local Canadians are coming and shopping around here for groceries and restaurants and they are buying clothes also. So if there are some artifacts are here or some galleries are here, so on, I'm sure that will help... So plus our kids and all today, they don't want to go down to old shabby Indian grocery store or old shabby restaurant or so. They want something that would be very clean, good looking, appropriate service, not mom and pop operation or so here"

**Anonymous Interview - South Asian Specialty Store
Interview Type #1**

- 1) "M4L"
- 2) "15 years"
- 3) "I was just starting here"
- 4) "Cause in, we have a Gerrard Bazaar Indian community here so it's very easy to, like communicate"
- 5) "I opened in 2003"
- 6) "... before there was a just a restaurant here"
- 7) "South Asian, South Asian, from Middle East also. So Middle East Arabs, then Pakistan, India and then we have Bangladesh. Then we have Sri Lanka and all Nepalis, and all of South Asia is basically covered. They come from all over North America"
- 8) "... summer is the peak time"
- 9) "I have one employee from Pakistan, one employee is from Bangladesh and one is Indian...[from] the neighbourhood here"
- 10) "... we have had a little decline of business because of the recession in 2008. Then it was it was still a little down than before, yeah. It's is still down, 30% is still down"
- 11) "We are not planning it. I just want my children to be well educated first and they will want to go their own way, whatever they like. Otherwise, I'm there"
- 12) "No. Brampton or Mississauga"
- 13) "The new immigrants are always here for jobs...but they have to be - they cannot afford any house here because houses are very expensive. And rent is very high... so they should have a job first then they can live nearby.
- 14) "A little bit, not much. Now everything is spread out. Like before, this was the oldest bazaar of South Asian people, right. Now everything is spread out to Scarborough, Markham, even Brampton and Mississauga, right. So everybody has to pull their own weight outside this area. That's why there's also the reason that the businesses here are declining for the last couple of years"
- 15) "It will help but it's very expensive"

**Anonymous Interview - non-South Asian Cafe
Interview Type #1**

- 1) "M4L"
- 2) "14 years"
- 3) N/A
- 4) "Cause I'd lived in the area for about 10 years and I guess it was part of my retirement plan"
- 5) "We haven't been open for 12 months, it took 12 months to renovate the building and we've probably been open for about 10 months"
- 6) "So and I believe anecdotally that a few people have said there used to be a hairdresser, a Greek gentleman had a hairdressing barbershop"
- 7) "Well, I'd be guessing. I don't know where everyone lives, I don't track them but...they live locally within one or two kilometres of the business, that's my customer base. Which is, and they tend to be, again just anecdotally from what I'm seeing young families moving into the area"
- 8) "Weekends, Friday, Saturdays, Sundays, even Monday"
- 9) "I've got one from the west end. And the ethnicity, I'm guessing they're Canadian although I have had a Spanish guy working for me... It's really a mix"
- 10) "It's probably too early to tell, it's always evolving"
- 11) "I am retired... My family, my son might be interested in taking over"
- 12) "Yeah, I mean, like I said I love the area. When I first came to Canada it was very attractive. It attracted me because of the vibrancy and the colour and it was interesting. It was very different when I first came here. It was still very active but then 9/11 really changed things and it really started to decline, 2002, 3, 4, the economic crisis. Also, it really changed this area, it kind of hit rock bottom about five years ago. I think it's turning around now, yeah"
- 13) "Yeah, there already is. The Toronto Housing Corporation has quite a few houses in this area"
- 14) "Yes, but again, they are kind of mixing it up a bit other than ghettoizing certain areas. I think that's old thinking. People - I'm not using ghetto in a derogatory term, I'm using it as a collective term - whether it's Little Italy or Little Portugal... It's like, so cultural centre. I don't know what that would necessarily achieve. I would be for a community centre that invited, that welcomed everyone... But, you know, that feels a little exclusive"
- 15) "Yes and no... Plus there's huge competition for festivals. So I think it's good but again I would like to see them try to reinvent it and use the good elements from the rich culture, from all the south Asian diaspora and how that reflects on living in the not so rich culture that's Canadian, mixing it up a bit. Because there's three big festivals in Brampton and Mississauga again it's huge, they would eclipse anything that's here. There's a dance party that goes on for like three days, one of the Bollywood film festivals. They didn't even have the - held the Bollywood, the equivalent of the Bollywood Oscars, they held it in Brampton. And they weren't interested in coming down to this area. Brampton and Dundas Square again is a shift... So, and again to be all inclusive of the actual people that live in the area. I recognize I think it's good to get people to come from different areas to come and visit and try and experience what's here"

**Anonymous Interview - non-South Asian Specialty Store
Interview Type #1**

- 1) "M4L"
- 2) "I was born here"
- 3) N/A
- 4) "I live two blocks away and it needed [this kind of store] and that's the kind of store I wanted open"
- 5) "Three years ago in March. So that would be March 2011"
- 6) "I believe it was a clothing store"
- 7) "That's interesting, okay. White Caucasian within a three mile radius"
- 8) "... there's no set pattern"
- 9) "It's just myself and my partner and we're each within two blocks from the store"
- 10) "It's just gotten busier, because the neighbourhood is changing demographically. So it's working out very well... when I first moved onto my street I had a lot of East Indian neighbours and they've now all moved to Brampton, so Little India is slowly but surely shrinking. The stores are changing because the demographics of the actual residential neighbourhood has changed drastically in the last few years"
- 11) "I would say that we would sell it, would be my answer"
- 12) "Oh yes, I've lived in the neighbourhood way more years than I've had my store"

- 13) "I'm not so sure there is not already some social and cooperative housing here... I think we already have it in our neighbourhood."
- 14) "No, I don't think so. I think this Gerrard Bazaar, like I said is fading. I think people are moving out of the city and I don't see it-, I don't see a use for it... when I moved in 12 years ago it was chock blocked with South East Asian stores and businesses and residents, but now it's doing a complete flip"
- 15) "I mean we already have, the BIA here already supports different cultural events within the area. So, would more help? I think we probably have our share of them already. I think two or three a year happen right on the street. They close it down and it's a big day for it"

**Anonymous Interview - non-South Asian Specialty Store
Interview Type #1**

- 1) "M4L"
- 2) "I was born here"
- 3) N/A
- 4) "Because I live in the neighbourhood"
- 5) "2012"
- 6) "It was a jewelry store and it's owned by my landlord who was a plumber. At first it was plumbing store"
- 7) "I'd say it mostly people from the neighbourhood, so it's mixed background"
- 8) "I guess from Spring right to Christmas it's very busy. January and February are quite slow and late afternoon, I would imagine, is the best time of day; early evening"
- 9) "The ethnicity is white and they come from all over the city"
- 10) "I don't know how to answer that really. It's just keeps growing... It just gets bigger and better"
- 11) "Probably it will retire with me. I have no idea what will happen to it"
- 12) "Yes, I've lived here 20 years"
- 13) "I think that has potential for anywhere in the neighbourhood... I think we need social housing across the city in different neighbourhoods, in different ethnic areas. I don't think that's particular to India Bazaar... it's changing. It changed 30 years ago from being

- 14) "predominantly working class Eastern Canadian population to South East Asian and now it's changing...we always need mixed housing as far as I'm concerned"
- 14) "Sure, I guess so. I don't-, I find it's very interesting what's going on culturally right now...as much as we've tried to reach out to the Indian community, we don't get a lot of people coming to our events...So I don't really know what that would provide, besides the festivals and the events that go on inside the library and the Indian Bazaar...So, it's a very complex situation that I don't think can be answered by putting up a community centre. We've been trying to work with the BIA, I'm part of the BIA. There's a lot of tension in the BIA. I don't really understand it, because communities change all the time in the city. I've lived here a long time. A lot of other people have lived here a long time and we're just trying to mix it up a little bit and do the things we want to do. There's a lot of push and pull"
- 15) "I've been seeing a decline in the neighbourhood since I moved here. It's been revitalized by new coffee shops and my [business] and different events at the library. I don't know how you force people to do things. There have been empty shops on our strip for years...I've heard from the locals that people don't come to the Sari shops because there's no parking. Parking is a huge issue. They go to the suburbs.... It is very complicated... because you're dealing with people. Everyone has a different agenda and everyone has a different experience. It's a very odd neighbourhood with a lot of mixed races and classes. That's changing...Rents have gone up. The rents on Gerard have gone up, which maybe is why a lot of shops are empty. A lot of Indians are selling their buildings and Indians are not buying them. So that's another thing, you know? It's a complicated issue here. It's not one group moving in and pushing people out. It's-, there's some tension and I think it just comes from change."

**Anonymous Interview - South Asian Specialty Store
Interview Type #1**

- 1) "N2N"
- 2) "Approximately 40 years"
- 3) "I was a student"
- 4) "That's because my brother-in-law used to own this store and I'd always been interested in having a business of my own because my dad and my parents always had a business so it was always in the back of my mind to have my own business"
- 5) "This one in 1989"
- 6) "No, this was the same store that was run by my brother-in-law but it was a much smaller store and they sort of ran away and I made it a much nicer, bigger store. But prior to me being here, it was still an Eastern Indian grocery store"
- 7) "Ethnic, I would say mostly Eastern Indian, South Asian community, basically East Indian, Pakistani, Bangladeshi and Sri Lanka. We are a little bit of Indian, Chinese from Calcutta area and so on. So I would say the majority of them are there but we do see some mix of west Indians from Trinidad or wherever because they have the Indian background but I'm gonna see a big number of Canadians as well nowadays... Yeah, mostly local but I think we get a lot of traffic, particularly on the weekends, from out of town. Like surrounding Ontario and Quebec, like, from Montréal, Ottawa and also we've got customers from Buffalo."
- 8) "We're open until, like, 11:00 at night everyday so we see a lot more traffic after 6:00... Saturday is steady on from the time we open. Sunday tends to start out a little

bit later on between 2:00 and 3:00 but mostly in the evenings we get a lot of traffic"

- 9) "All Indian and Pakistani...most of them [live nearby]"
- 10) "It's changed from the perspective that when I started, this was the only market that was available to the East Indian community or South Asian community. And as the years went by, different communities started building up in Scarborough and Brampton, so we have a lot of East Indians...Indian stores all over the place now so the whole market is now split up. It's much bigger also. I think we've got a lot more East Indians or South Asians here than when I started it. So the market has become much bigger but it's fragmented now. It's all over the place. So this is not just the main focus attraction for salvation... So what my strategy has been to introduce the more rare products which the main stream people wouldn't even know about it, so specialize in, it includes a lot of variety and increase our customer service so we can compete with Loblaws and all [those kinds of stores]"
- 11) "So in all likelihood, I'll probably be selling it. I don't see it being passed on to my son or any of my relatives"
- 12) "I live in Kitchener"
- 13) "I think there is because not too many people are doing very well economically in the surrounding area so definitely I would say yes"
- 14) "Oh definitely. Oh yeah, I think that would be a great asset"
- 15) "Oh yeah definitely. And they do that to a certain degree. Every year we have a South Asian festival here but it's not artistic. It's just a general festival so definitely that would add to the flavor here"

**Anonymous Interview - South Asian Cafe
Interview Type #1**

- 1) "M4L"
- 2) "Over 15 years"
- 3) "[My father] was also a store owner there"
- 4) "When [my father] came over there were maybe four or five Indian stores on the strip. And I believe at that time it either was one store that specialized in what we're selling now. So he definitely saw the market there, and the demand, so he went for it"
- 5) "...it would be around 2003"
- 6) "It was an East Indian restaurant"
- 7) "So obviously in the beginning it mostly consisted of the Asian clientele, so people from Pakistan, India, Sri Lanka and Middle Eastern...I would say obviously there's some clienteles nearby but I know we have clienteles coming all the way from Mississauga...even across the U.S. Whenever there's a long weekend would see the same clientele coming over from America even. And they always come to our store so we even built that relationship over time"
- 8) "Peak times in terms of seasons would be summer, so from April to at least August will be the summer peak time. For our restaurant daily I would say it would be between the evening and night time, so even 12, two a.m."
- 9) "It is again South Asian...And they are commuting from I guess, I don't actually remember, within Toronto. So I would say some of them live in Mississauga, others live in Scarborough. So they do have to commute a good time to get to our restaurant to get to their work"

- 10) "I would say our business has been continuously picking up and growing. First we were in a small location somewhere on the same strip. And then after a few years we moved to a bigger, more open store. And business wise it's been growing and our income, obviously revenues grew...just for the last year or two we've been noticing that the market has become saturated, so a lot of Indian restaurants now that specialize in the exact same thing, we're seeing even just a lot of traffic is also going down now that there's... If you go like five, six blocks then you hit the Greek town. If you go like five, 10 minutes commute westward you'll see Chinatown, so other markets nearby"
- 11) "Once [my father] retires I believe he might sell off the business to someone else. I don't believe anyone within the family would continue his business"
- 12) "I would say we would probably move but we would still be in the downtown Toronto area"
- 13) "I would say I am unsure how that would affect the area"
- 14) "Yes it would have potential definitely... I would say even besides looking at our South Asian community, like I've noticed whenever we have our annual festival or any special event we have noticed like the Canadian, North American community would come out and it's a blend of clienteles that show up. They all want to take part in it, want to taste the food, and want to learn something new about whatever culture"
- 15) "Definitely yes again...And everyone is interested in that...a year ago...People did come over, paint and did murals all over the walls. It was very South Asian style and I believe it had very positive feedback from the neighbourhood as well, which consists of both, again, Caucasians, South Asians"

**Anonymous Interview - non-South Asian Specialty Store
Interview Type #1**

- 1) "M4E"
- 2) "Almost all my life. I moved here when I was three years old"
- 3) N/A
- 4) "Reasonable rent, close to the beaches, Leslieville and other areas where I felt I could get clients"
- 5) "About a year ago"
- 6) "An Indian South Asian textiles clothing shop... they were late on rent a number of times...they closed down"
- 7) "... middle class, Caucasian mainly ethnically Caucasian... They come as far away as Oakland...[or] reside in the east"
- 8) "Peak times would be weekends as far as traffic...we're busy throughout the week but also it depends... August is slowest"
- 9) "Well, it's just me and [my colleague] here"
- 10) "... it's pretty much the same"
- 11) "It will end with me"
- 12) "Yes...because I live in Upper Beaches. I have a home with kids"
- 13) "Well, I think there is a definite room for modern well-constructed but new cooperative social type...There are a lot of shabby, I guess for lack of a better word, flop houses in this area which is changing to a degree through the facts that a lot of the houses are put up for sale, or half

million dollar homes and mostly middle class families, start up families are moving in so could definitely use more condominiums as well"

- 14) "That's difficult because the fact is there's been so much migration to Brampton and other areas where there are other large ethnically South Asia in communities. So there's not as many local South Asian families living here frankly as much and less a lot of them aren't coming to support the businesses. So I think it would be a great idea in one sense as part of its heritage but whether or not it would sustainable for the number of people that now come here to shop, I think that's a difficult question"
- 15) "Yeah, well The South Asia Festival, the one they already have is pretty popular so yes"

**Anonymous Interview - South Asian Specialty Store
Interview Type #1**

- 1) "M4L"
- 2) "Around 29 years"
- 3) "I was in the medical field"
- 4) "Well, opportunity arose for it...there was a demand for these items...So I expanded into it because before we had clothing"
- 5) "We were just two blocks east, since 1994, I would say. At this location, we are since 1998"
- 6) "In this, no, there was nothing because this was a boulevard construction"
- 7) "Like, 70 percent to 75 percent of my clients are mainstream white Canadian. And others are West Indians, Sri Lankans and a few Indian"
- 8) "It's the summer and weekends and also...just before Diwali"
- 9) "They are Indians only because they need to speak the Indian language and English, both. I think one is in Scarborough and one comes from Brampton. She used to stay here at the east end but now, since last year, she has moved to Brampton"
- 10) "The clientele has remained the same but I think there are more stores in the suburbs and also here in the Gerrard Bazaar, there's more competition. So, naturally, the business does get divided"
- 11) "I will try to sell my business"

- 12) "Yeah. I live at Harbourfront"
- 13) "They do have some subsidized housing, I think, for seniors and other units just east of ... sorry, west of my store, yeah"
- 14) "I'm not sure about that"
- 15) "Yeah, we do have that. We have the Asian Day and then we have another festival in August"

**Anonymous Interview - South Asian Key Organization
Interview Type #2**

- 1) "To engage communities, to bring community on a platform where they can engage and they can participate"
- 2) "It was established in 2007"
- 3) "Actually, this was a place where I got the opportunity because before I tried two different other locations...I started for seniors. Normally, seniors were sitting on stairs and they were just walking on the road, so at that time I thought that I should find some space for seniors where they can sit and they can chat"
- 4) "Basically, mostly, we do cultural events because we are very behind in doing cultural stuff in this area... So we always welcome all other cultures... whoever wants to participate with us, it's wonderful"
- 5) "Basically, there is no specific membership because this community centre is not supported by any federal, or city or provincial level funding, and we do not have any city-granted projects and we are not getting funds from any other organization. We are surviving by our own"
- 6) "Initially, we were having English language classes for seniors and then we started sister-to-sister movement where women are come together, they cook together, they do a fashion show, dancing, eating...doing so many things together...and often we are doing the cultural events like our events, the prayers. Sometimes we celebrate Independence Day. So we are doing all these types of events where we are inviting all of the community to give them an activity and to engage them in the community"
- 7) "I'd love to expand this but the thing is that I need a lot of

financial resources."

- 8) "Basically, I'm not getting funding from anywhere. Mostly, you can say, like, sixty, seventy percent work I'm doing myself...for the last event we had a \$15.00 ticket...Now, the question is how I managed this all. I personally, myself, cooked all the meals, which costs less money and I served this to more than 200 people"
- 11) "Yes. We are working together. Recently, we have done multi-faith cricket match. And before this we have done, many times, multi-faith walks where we visited one another's religious places and we shared food and culture together. So are very well connected"
- 10) "Basically, there are so many programs where we can promote these things. But every single thing needs funding. So my organization is non-profit...this is a big barrier in front of me that my organization is not charitable. If the organization is a charitable organization then we can get funding, and we can have more and more projects and we can do more in a sophisticated way, like so many things"
- 11) "I don't have any idea about this"
- 12) "Yes. Art always has potential"
- 13) "This is very technical question"
- 14) "Yeah. Why not"
- 15) "So this is the only thing that...I'm very hopeful and I'm very positive that in the near future we will have a strong team and we will do more ... whatever we are doing right now, we will do more"

**Anonymous Interview - South Asian Specialty Store
Interview Type #1**

- 1) "M4L"
- 2) "Since 2000"
- 3) "Student"
- 4) "I just like to live independently. And, like, we have more customers in the Gerrard India Bazaar"
- 5) "2000"
- 6) "A jewelry store"
- 7) "They are South Asian... they come [from] all over"
- 8) "Diwali time"
- 9) "We don't have any employees"
- 10) "Nothing"
- 11) "I don't know yet"
- 12) "Yes. I love this neighbourhood because I have started living in this neighbourhood"
- 13) "Yeah, definitely, it will be useful, if there are some things, definitely"
- 14) "Not really"
- 15) "Yes...that time lots of people comes in this neighbourhood and they can see stuff"

**Anonymous Interview - South Asian Clothier
Interview Type #1**

- 1) "M1B"
- 2) "Twelve years"
- 3) "I was a teacher"
- 4) "Actually, I got married here and I joined the business with my wife"
- 5) "This business is here since 1990... we were in the same location, like, one store down, so we moved into a bigger one."
- 6) "I think it was a grocery store or something"
- 7) "Well, we used to deal with, like, specific clients... this market was based on West Indian, Sri Lankan people, and people like Indian, Pakistanis but now we're dealing with mostly Pakistanis, Bengalis, Afghanis, like, all mixed communities are coming now. And lots of Canadian people, like, white people... lots of people come from Mississauga, Scarborough, Brampton, Hamilton"
- 8) "Usually the peak time starts from the month of, like, April to August end. And the main weekdays are basically busy, like, Wednesday, Thursday, Friday, Saturday, Sunday"
- 9) "Well, we have no employees...it's a family-run business, so me and my wife, we both run this one"
- 10) "... the clientele has changed so people's choices have changed, so we have to work according to the customer's requirement. Before it was different, now it is different... if you go back in, like, ten years back or maybe fifteen year back then Gerrard was the only option for people to come and, you know, walk around and enjoy Indian food,

an Indian market. But now since the markets are everywhere, like, you go to Brampton there are plazas, you go to Mississauga, like, people are more comfortable because the parking is free there"

- 11) "When I'm retired I'm going to maybe close down or just stay home...I'm not going to let my children take over"
- 12) "Like, now, I'm living in Scarborough"
- 13) "Yeah"
- 14) "No"
- 15) "Could be"

**Anonymous Interview - South Asian Key Organization
(Not Located within Gerrard Bazaar) - Interview Type #2**

- 1) "The primary purpose is to serve the South Asian art community"
- 2) "At the current location-, I'm not totally sure"
- 3) "Basically, it's a central location that is subsidized by the building owners. They care about the arts, so its rent is affordable for an organization such as ourselves and we're also surrounded by other artist-run centres"
- 4) "Basically, we have three paid staff members. We have the Executive Director, who's full-time and an Artistic Director and a Director of Communications...We have a Board as well and a part-time bookkeeper"
- 5) "we have about 120 right now, and it fluctuates usually from between 100 to 150. Mostly, I would say they're localized in Toronto, but we do have quite a few members in Mississauga and other parts of the GTA. We also have a few members that are international, from India, Pakistan"
- 6) "Basically we provide services to artists. We're a member based organization. We provide career support in the form of workshops, newsletters, information sessions and member events. We also do exhibitions-, art exhibitions throughout the year, including film and video programming through our Monitor program"
- 7) "At this time, we're not looking to expand"
- 8) "...we get funding from the government-, three levels of government. Most of our operational funding comes from The Canada Council for the Arts. We also get funding from the Ontario Arts Council and the Toronto Arts Council. We do get fees from memberships and things like that but most of our programs are not paid. They're

free to the public"

- 9) "It comes somewhat organically. Two years in advance, someone will contact us and say, "We'd like to work with you." Often with public galleries that are government funded...Other times, like with other artist-run centres, it's usually that they're colleagues of ours and either they have an artist or interest in showing an artist or we do and we liaise with them to make that happen"
- 10) "The programs that we offer right now, I think all can lead to that...Often we've been told that when artists come to us that it's a space in which represents diversity within the South Asian community in terms of it encompassing people who have immigrated here or people who have grown up here but just people who have a common set of experiences and creative concern. Even through our programming, sometimes people will come and have an interest in telling a particular story and will see work by an experimental video artist that covers identity based themes, themes of migration and themes of home"
- 11) "I'm not actually sure because I'm-, I don't think we're the best people to ask about that necessarily"
- 12) "Yes, probably that kind of stuff has potential"
- 13) "Yeah, I'm not really sure"
- 14) "I don't really think so, because to be totally honest I don't know that-, because of the extent to which the South Asian creative communities are kind of just youth"
- 15) "It's hard to...we have staff change-overs pretty often in order to keep evolving as an organization and not be stale. In the shorter term, what we are particularly interested in is expanding the conversation around South Asia...the work of the South Asian diaspora"

**Anonymous Interview - non-South Asian Specialty Store
Interview Type #1**

- 1) "M4L"
- 2) "Born here"
- 3) N/A
- 4) "I live in the area and there was a lack of shops to support the community"
- 5) "2012"
- 6) "A South Asian jewelry store... they're still on the strip... They moved down to the busier section"
- 7) "Geographic location is within walking distance of the store and we have all ethnicities"
- 8) "October to December for Christmas and then Fridays, Saturdays"
- 9) "It's just me and my husband"
- 10) "It's grown but there was nowhere but to grow when you're a brand new business"
- 11) "It's our retirement plan"
- 12) "Yep...the only place we could afford so we moved into the neighborhood out of necessity"
- 13) "No"
- 14) "No...the South Asian community has picked up most of their roots and left the community...quite frankly, the South Asians that come here that are looking for Little India are extremely disappointed because they

say they might as well stay home and walk down the street in Brampton, that there's not enough to offer and stores don't open early enough so they make a trip down. So it's actually a real disappointment so I don't see people actually making an effort to come here if there was a cultural centre"

- 15) "Within reason...The South Asian Festival really needs to take a whole new spin and be more inclusive to everybody because the neighbourhood is changing and there isn't anything for neighbourhood children to participate in, it's too skewed to just being South Asian and we all know that we opened in Little India, that's not the problem. It's that places like Little Greek Town, it's still known for being Little Greek Town but there's other things going on and that's the only way, and if you talk to a lot of the old timers, they get it too, the only way that this strip is going to survive is if we embrace everybody and have the South Asian flair and a mix of other things"

"Like they've asked restaurants to do cooking show nights where people can come pay to come and learn how to make two or three traditional dishes and all sit down and eat them. The neighbourhood really wants to embrace that idea...We had the Sikh Festival last year. It wasn't held this year. Nobody even knew about it. And yet it's all a harvest festival about food which this community is huge about around here and we could've done a spin on a more North American style market but with all the information as to why -- I forget the name of it but why that festival was happening and the cultural roots related to the Sikh community. But we don't do that stuff. We do a sidewalk sale and people sell clothes and that's it"

**Anonymous Interview - non-South Asian Specialty Store
Interview Type #1**

- 1) "M1N"
- 2) "Since 1985"
- 3) "I was a welder"
- 4) "It was within the demographics of the people group that the food is designed for and the price was okay"
- 5) "April 17, 2012"
- 6) "Right before, nothing. Before nothing, it was a woodworking shop. Before it was a woodworking shop, it was a restaurant"
- 7) "I would say about 50% are First Nation from all over the GTA and about 30% are of European descent living within four blocks"
- 8) "March through June and October and November. And during the week is: Friday and Saturday, I would say"
- 9) "Predominantly First Nation and they commute from within about five kilometers. Either east downtown or west Scarborough"
- 10) "How has it changed? It has just become better...it grew. Probably double"
- 11) "Probably one of the staff would take it"
- 12) "Yes"
- 13) "Yes"
- 14) "No comment"

15) "Yes"

**Anonymous Interview - non-South Asian Specialty Store
Interview Type #1**

- 1) "M4C"
- 2) "I was born here"
- 3) N/A
- 4) "I live close to the area. The area is evolving and I thought this was a good location"
- 5) "Two months ago"
- 6) "... it was an Irish bakery before me. And before that, it was a vegetable fruit stand"
- 7) "Most everybody lives in the area but most are Caucasian though"
- 8) "Weekends is the busiest and then during the day it varies"
- 9) "It's my store and I'm the only employee"
- 10) "No change as of yet"
- 11) "Hopefully my kids will take it over"
- 12) "Yes. I just love the area, the community feel"
- 13) "It does but it's starting to get priced out. The cost of all the houses around have doubled since I've been here at least"
- 14) "It does have potential, but I find the area...just with the house prices and everything, it's changing every month"
- 15) "I think so. I'm looking forward to the Bazaar this year"

**Anonymous Interview - South Asian Restaurant
Interview Type #1**

- 1) "M1X"
- 2) "I came here in 1996"
- 3) "I was a Manager for a restaurant"
- 4) "... when I came to this country there were no authentic South Indian restaurants. So I thought, you know, if I have one that would do very well. Because it's an Indian bazaar and...I knew that more Indians would stop over here, like so come to the Indian bazaar"
- 5) "In 2001"
- 6) "It was a small empty space with no proper walls, no proper tiling, nothing. But sometimes they used to use it for storage"
- 7) "I have all types of clients, like I have the Caucasians coming because I do different things for them, like different vegetables. Otherwise there are a lot of people that are vegan, gluten free, so I do take care of their necessities. So you know I do get a lot of Caucasians. Of course I do get a lot of Indians because my restaurant is an authentic South Indian restaurant...But I've got good reviews in some Japanese newspaper, some Bulgarian news magazine. So you know, I will get those clients too. Definitely I get people from Nepal and that area as well... I mean they come from all over. Like, we have people coming from Etobicoke. We have people coming from Hamilton. We have people coming from Scarborough, Mississauga. And even I used to get a lot from Mississauga, Brampton but now people, construction and all this, you know with Gardiner Expressway, all this construction is always going over there"

- 8) "Well mainly it's on the weekend but when the weather gets better I would say from April to November you get a good amount of clientele over here. And soon after Halloween people start going more into malls, you know, for shopping so that is a time which declines over here. And the Christmas holiday is one, Christmas holiday again this place gets busy and then it goes down after January 1st...Then again after March break it picks up"
- 9) "Most of them are from Asia, like you have people from Sri Lanka, Pakistan, Bangladesh, India... Most of them they come from Scarborough, from downtown"
- 10) "I would say it's, for me my business is almost as [when I had] opened and except it declined quite a bit because, as I said, because of all the construction problems and all"
- 11) "All of [my children] might think we're too small so I don't know whether they would want to take over the business...when I am thinking of retiring I would ask the staff if they want to run it for me"
- 12) "Yeah"
- 13) "I don't think so that would help them"
- 14) "Yeah that would be fair"
- 15) "Yeah, yeah"